

802.16/802.24 Tutorial: Proposed 802.16s Narrowband Project

Roger Marks
IEEE 802.16 WG Chair

Agenda

Topic	Detail	
	802.16/802.24 Tutorial: Proposed 802.16s Narrowband Project	
Call to Order	Roger Marks and Tim Godfrey (Co-Chairs)	
	Introductions / 802.16 overview, history, and context	Marks
	802.24 Vertical Applications TAG - applications of 802.16 in utility field area networks	Godfrey
	Utility industry perspective on private spectrum	Kilbourne
	Utility perspective on standardization for narrow channel operation	Shaft / Faruqi
	Update on the 700 MHz Upper A Block spectrum	Finch
	Approaches for narrow channel implementation	Simpson
	Q&A	
	Adjourn	

802.16/802.24 Tutorial: Proposed 802.16s Narrowband Project

802.24 Vertical Applications TAG - applications of
802.16 in utility field area networks

Tim Godfrey (EPRI)
IEEE 802.24 TAG Chair

Agenda

- What is a Field Area Network (FAN)?
- Why would a utility use 802.16? Why not LTE?
- What are spectrum options for FAN?
- Why amend 802.16?

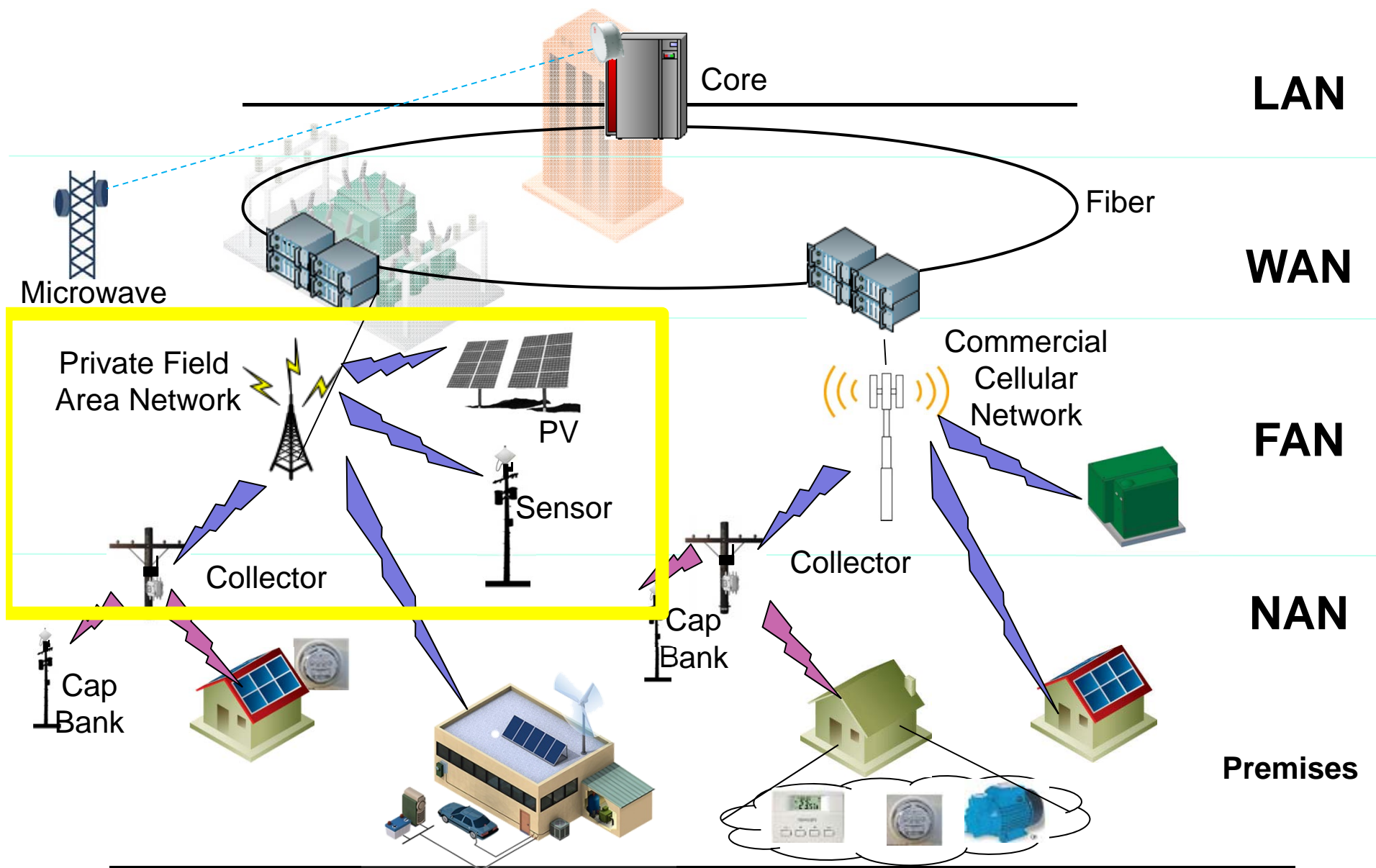

Utility Deployed FAN – private network

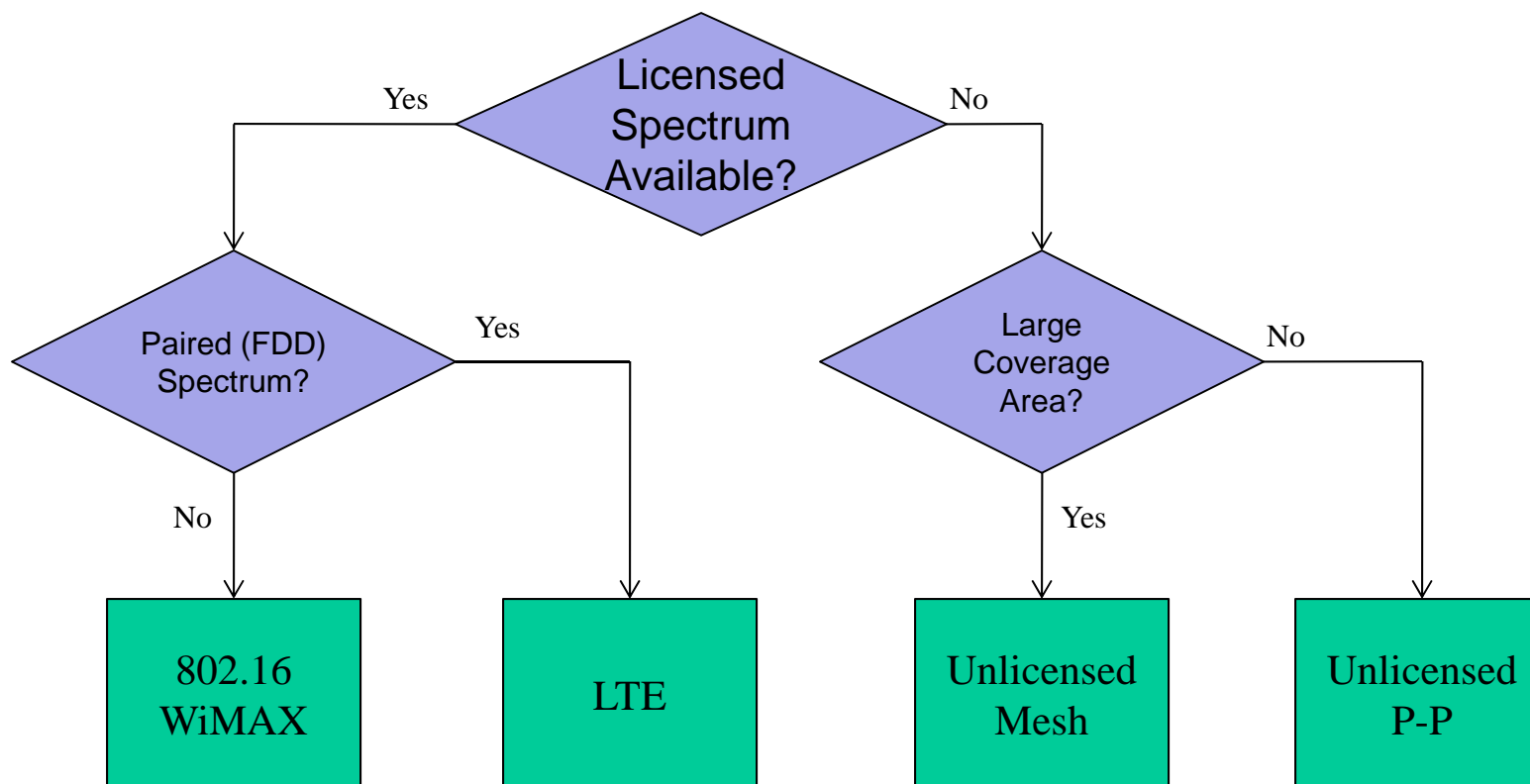

- Simplified chart – many other factors must be considered

Popular 802.16 products for utilities



GE MDS Mercury



Full Spectrum FullMAX



Cisco Connected Grid Router (Station Only)



Siemens RUGGEDCOM WIN7200



Airspan AirSynergy 4G

LTE Network Architecture

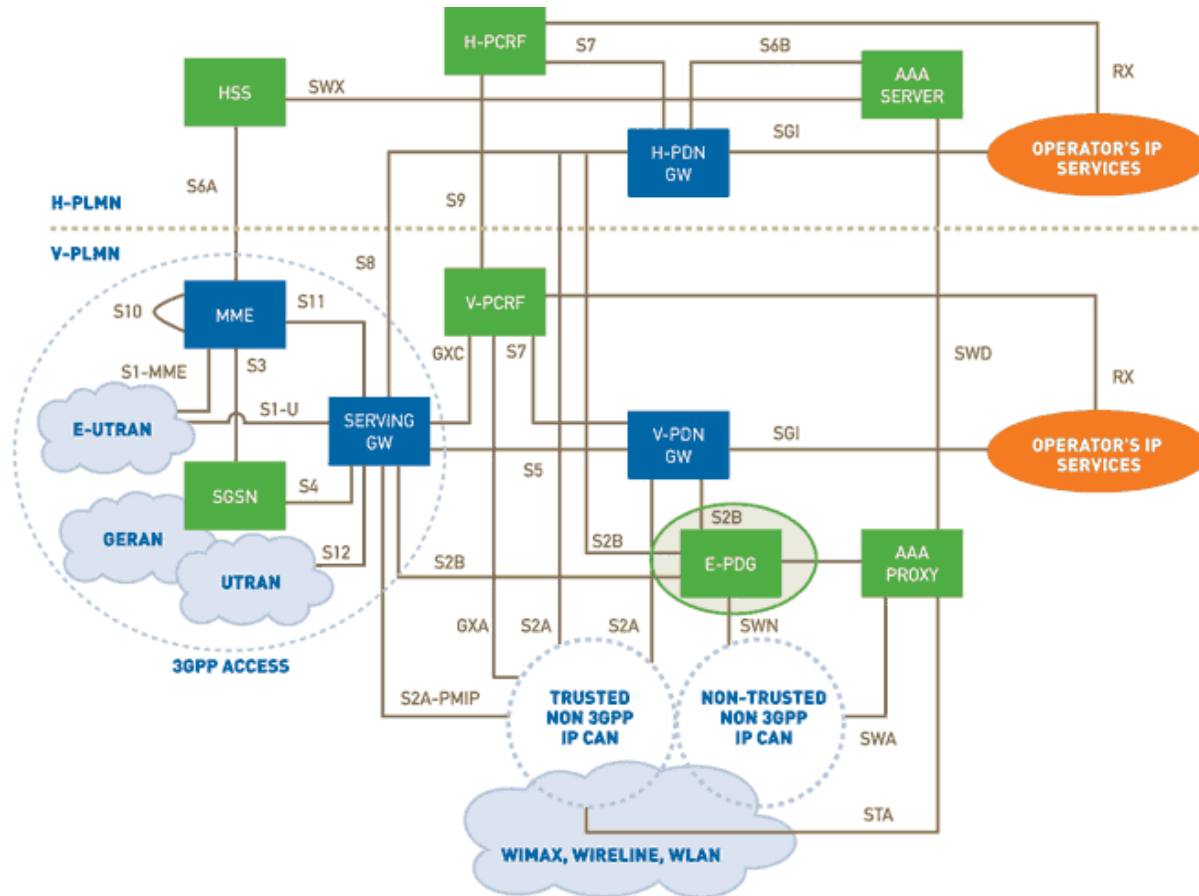

- Fully integrated with legacy mobile system
- Oriented towards mobile network operators needs

802.16 Network Architecture

IP-Based WIMAX Network Architecture

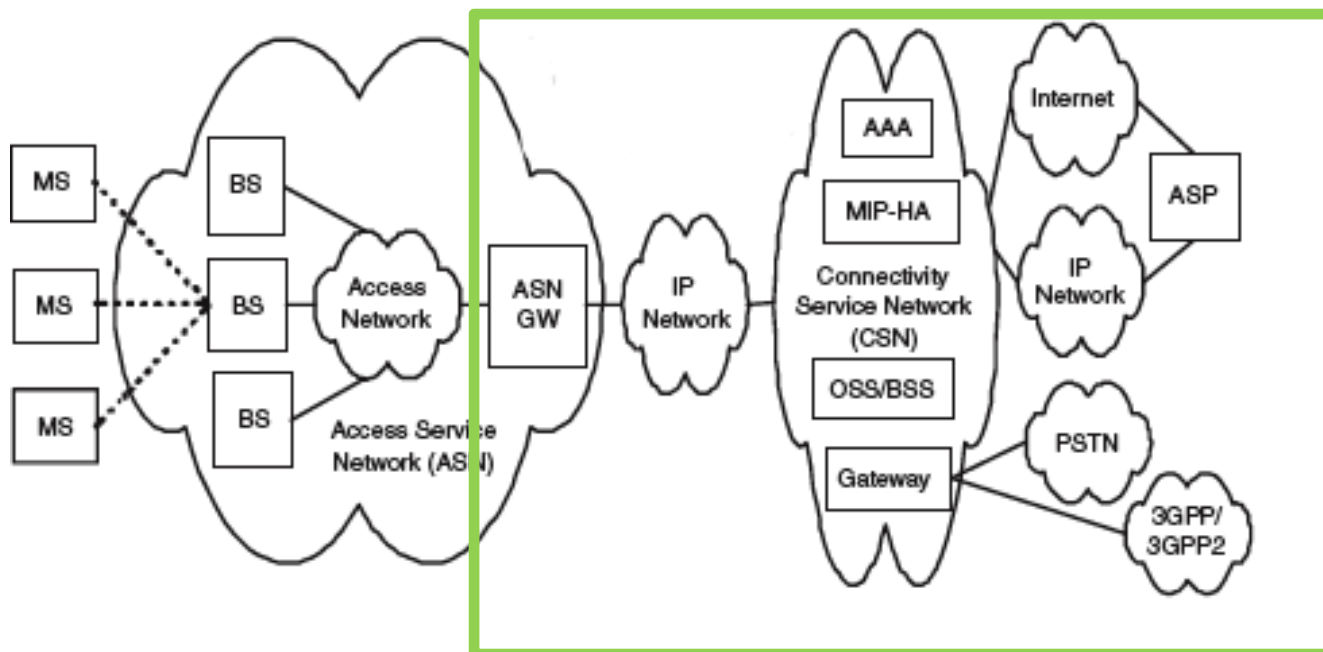

- Simpler architecture with L2 support
- More aligned with utility IT services and architecture

Other key differences in 4G technologies

- **Spectrum Type**
 - LTE typically uses FDD (paired) spectrum,
 - TD-LTE standard does support unpaired
 - Most equipment is for FDD
 - WiMAX typically operates in unpaired spectrum
 - Best match to “uplink biased” grid applications
- **IEEE 802 Ethernet Model**
 - Intrinsic support for Layer 2 connectivity
 - IEEE 802.16 supports an Ethernet Interface and Layer-2 messages (e.g. IEC 61850 GOOSE)
 - LTE is IP (layer 3) only – Layer 2 must be tunneled
- **Local forwarding**
 - 802.16 supports direct SS to SS forwarding through base station
 - LTE typically routes all packets through EPC
 - Local gateways have been proposed

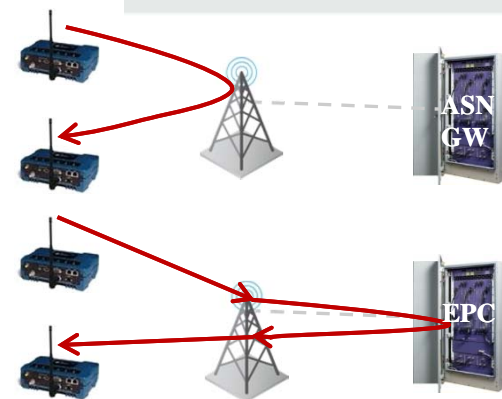
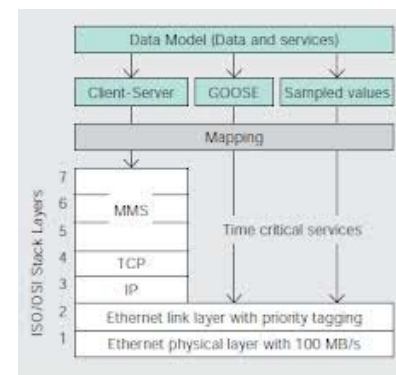
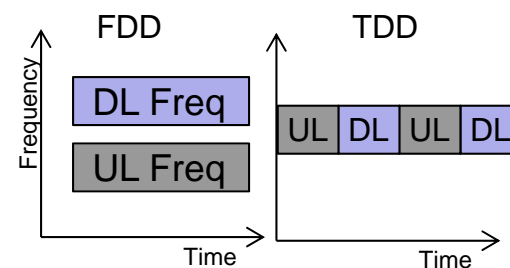

Why not Cellular IoT or other commercial wireless?

• Public



- Low CapEx, ongoing OpEx
 - Security and reliability up to carrier
 - Carrier provides the spectrum
 - Network evolution up to carrier
 - Network maint & repair up to carrier
- High CapEx, lower OpEx
 - Utility controls security and reliability
 - Utility provides the spectrum
 - Utility controls pace of evolution
 - Utility controls maint & repair
- Utilities that choose the private option have specific financial and operational reasons, and are unlikely to change to a public provider.
 - They are not potential customer for operators

• Private



Spectrum for utility 802.16 FANs

- 5.8 GHz Unlicensed
 - WiMAX certification and profiles
 - Less attractive due to poor propagation at high frequency
- 4.9 GHz Public Safety
 - WiMAX certification and profiles
 - Limited availability of spectrum – negotiation with PS entities required.
- 3.65 GHz “Lightly Licensed”
 - WiMAX certification and profiles
 - Has been widely used by over 100 utilities.
 - Recent rules changes have made the band less attractive for future expansion
 - Reports of interference in utility pilots
- 1.8 GHz Canadian band
 - WiMAX certification and profiles
 - Widely used Canadian utilities.
- 700 MHz Upper A Block
 - Superior propagation
 - Too narrow to support 802.16 or LTE as currently specified

Why narrow channel is of interest

- Spectrum is less attractive to mobile operators since LTE is not supported
 - Cost is moderated
- Narrow spectrum means lower data rate, but capacity is still sufficient for grid applications
- Other spectrum with similar narrow channel characteristics is available or may become available:
 - 217 MHz, 406 MHz, 901 MHz, 1.4 GHz

Conclusion

- 802.16 is technically well suited for utility Field Area Networks
- 802.16 continues to be widely used for utility Field Area Networks
- The industry desires to use 802.16 for 700 MHz and in other narrow allocations, but a standard is needed

Spectrum Access & Challenges

802.16/802.24 Tutorial: Proposed 802.16s Narrowband Project

Atlanta, Georgia

January 19, 2016

Introduction to UTC

- Established in 1948, UTC advocates for the telecom and IT interests of electric, gas and water utilities and other critical infrastructure industries.
- Based in Washington, DC, UTC has affiliate organizations around the world in Europe, Canada, and South America.
- Spectrum access is a key issue for utilities, as utility modernization places new demands on the underlying communications infrastructure.

Overview

- Issue: Spectrum Access
 - Assessment
 - Options
 - Risks
 - Strategic Approach

Utility Spectrum Access: Assessment

- Utilities need access to additional spectrum that is suitable to meet their increasing communications requirements from smart grid and other applications.
- Issues:
 - How much?
 - What frequency range?
 - When (current and future)?
- Next steps: Need to develop a technical basis and industry consensus for access to a band or bands that will meet utility functional requirements for a variety of applications and topologies.

Spectrum Access: Options

- UTC Whitepaper on Smart Grid Traffic Estimate:
 - Identifies bandwidth requirements for individual smart grid applications and aggregates them based on different use cases, including electric transmission and distribution networks, as well as gas networks.
 - Estimates bandwidth requirements on a site-by-site basis for different abstract communications networks at 450 MHz, 700 MHz, and 1.8 GHz.
 - Total bandwidth requirements are approximately 6-8 MHz, which may be higher or lower depending on the frequency range of the network.
- EPRI Assessment of Licensed Communication Spectrum for Electric Utility Applications:
 - Identifies 406-420 MHz as “particularly attractive” due to compatibility with LTE standard and low demand for this spectrum for commercial communications.
 - Secondary market spectrum; 700 MHz also possible options.

Spectrum Access: Risks

- Cost of spectrum access
 - Purchasing spectrum on the secondary market
 - Relocating incumbent operations
 - Equipment availability
- Competition from commercial carriers
 - Federal regulators under intense pressure to allocate additional spectrum for broadband commercial services.
 - Carriers want utility business.
- Spectrum scarcity
 - Suitable spectrum is difficult to find, especially under 2 GHz and especially on a dedicated basis.
 - Unlicensed spectrum available, but subject to congestion/interference

Spectrum Access: Strategic Approach

- Coordinated/Unified support across all utilities and all critical infrastructure sectors.
 - Engage with energy and water regulatory agencies to raise awareness and develop support.
- Develop a quantified substantiated basis for spectrum access
 - “We want spectrum!” won’t work. Must be specific and targeted.
- Elevate this initiative worldwide
 - Develops economies of scale, which attracts investment and equipment development/lower costs.
- Standardization
 - Develop solutions that are standardized, rather than proprietary to promote interoperability and avoid stranded investment.

QUESTIONS



www.utc.org

Contact Information



Brett Kilbourne

Utilities Telecom Council

1129 20th Street, NW

Suite 350

Washington, DC 20036

(202)833-6807

Brett.kilbourne@utc.org

Utility Perspective on Standardization for Narrow Channel Operation

Kathy Shaft P.E.

Senior Telecommunications Engineer

Who is Great River Energy?

- ▶ G&T Cooperative
- ▶ 28 member owners
- ▶ 12 power plants
- ▶ 4700 miles transmission lines
- ▶ 2nd largest supplier in MN

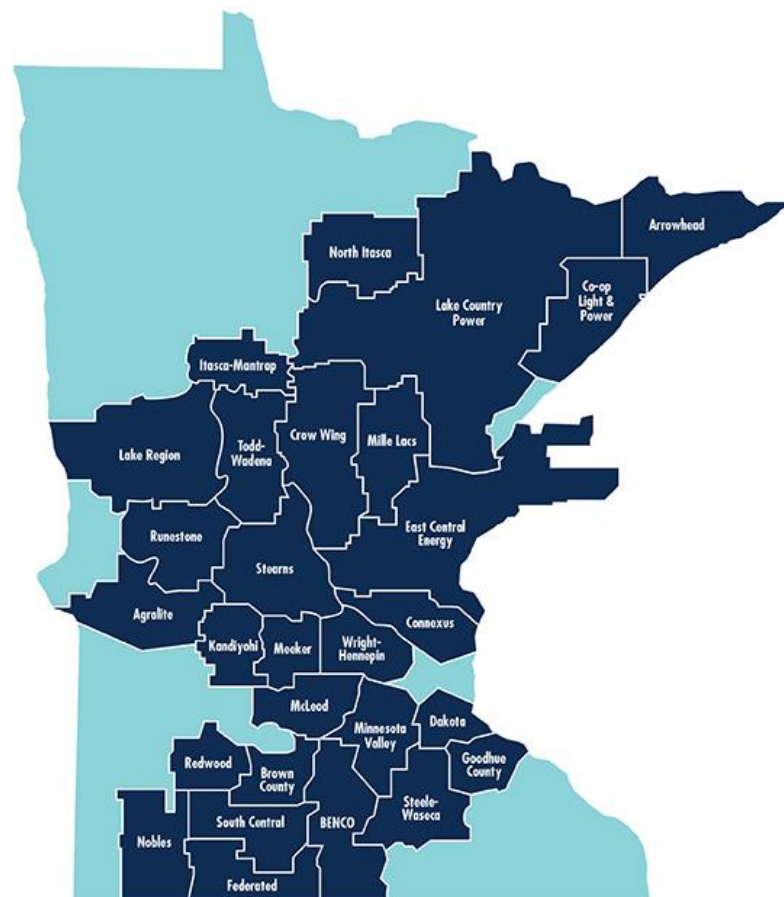

Importance of Narrow Channel standard for Utilities

- ▶ More utilities using the same standard and technology
 - Bigger market for vendors
 - More vendor choices
 - More stability

GRE's current SCADA Network

- ▶ Uses 700 MHz A band
- ▶ Communicates to 500 substations:
 - Long path lengths
 - 3 Sector (narrow channels)
 - Frequency Reuse
 - Throughput (1100/250 kbps)
- ▶ Applications:
 - SCADA (critical)
 - Metering
 - Remote Access
- ▶ Backhaul Coop data
 - AMI/AMR
 - Load Control
- ▶ Distributed generation

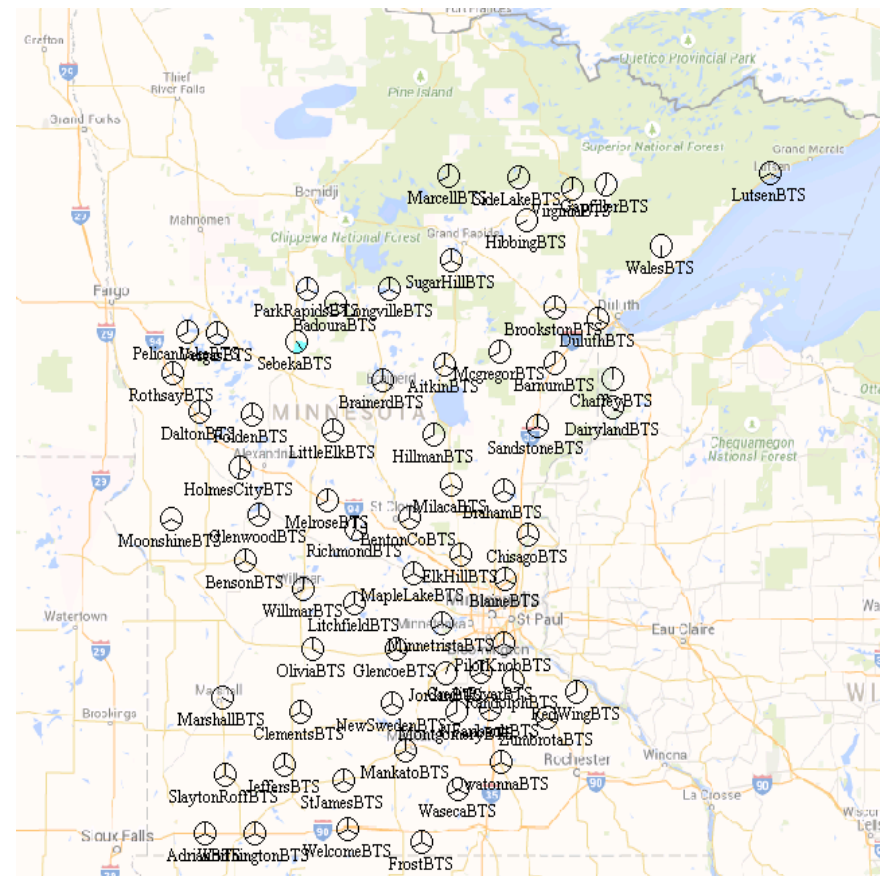

Current SCADA Network Cont.

- ▶ Modified DOCSIS 2.0 cable modem standard (proprietary)
- ▶ Three years after deployment the vendor went out of business
- ▶ Even with access to the IP we were too small for a vendor to make equipment for us
- ▶ Self maintaining now but equipment is aging and we have limited spares

What Does the Narrow Channel Standard do for Utilities?

- ▶ Most spectrum options available to utilities are 1MHz or smaller (this forces us to use proprietary solutions)
- ▶ This potential solution provides us with more stability
- ▶ More vendor and equipment choices
- ▶ Utilities have started purchasing licenses in the 700 band
- ▶ If there was a standard its likely more would join

Importance of Private Utility Networks

- ▶ We use our networks for critical SCADA traffic
- ▶ Command and control of the electric grid
- ▶ We cannot rely on public networks for our critical SCADA data

Questions?

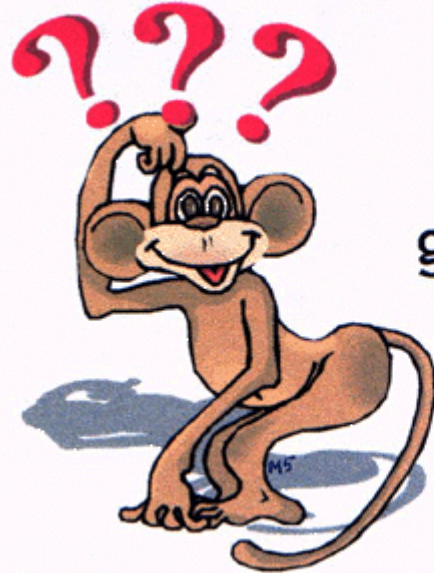

Questions
are
guaranteed in
life;
Answers
aren't.



Portland General
Electric

PGE Field Voice and Data Communications System Project Overview

January 19, 2016



Project Objectives:

- Replace PGE's 150 MHz Field Voice Communications System (FVCS)
- Develop a Field Data Communications System (FDCS) to allow for mobile data communications and system automation
- Purchase spectrum to replace current shared use radio channels with PGE exclusive radio channels

Importance of this Project:

This project is strategic to PGE's operations. Foundational to this project is PGE owned radio spectrum

Board approval:

- **February 2015:** Approved \$X million for purchase of spectrum, business requirements, initial design and legal fees
- **February 2016:** Will request up to \$Y million in project funding based upon engineering design

Sponsor:

Larry Bekkedahl

Team:

Dale Clark; Mike Wagner; Sal Faruqui

Current Field Voice Communications and it's limitations

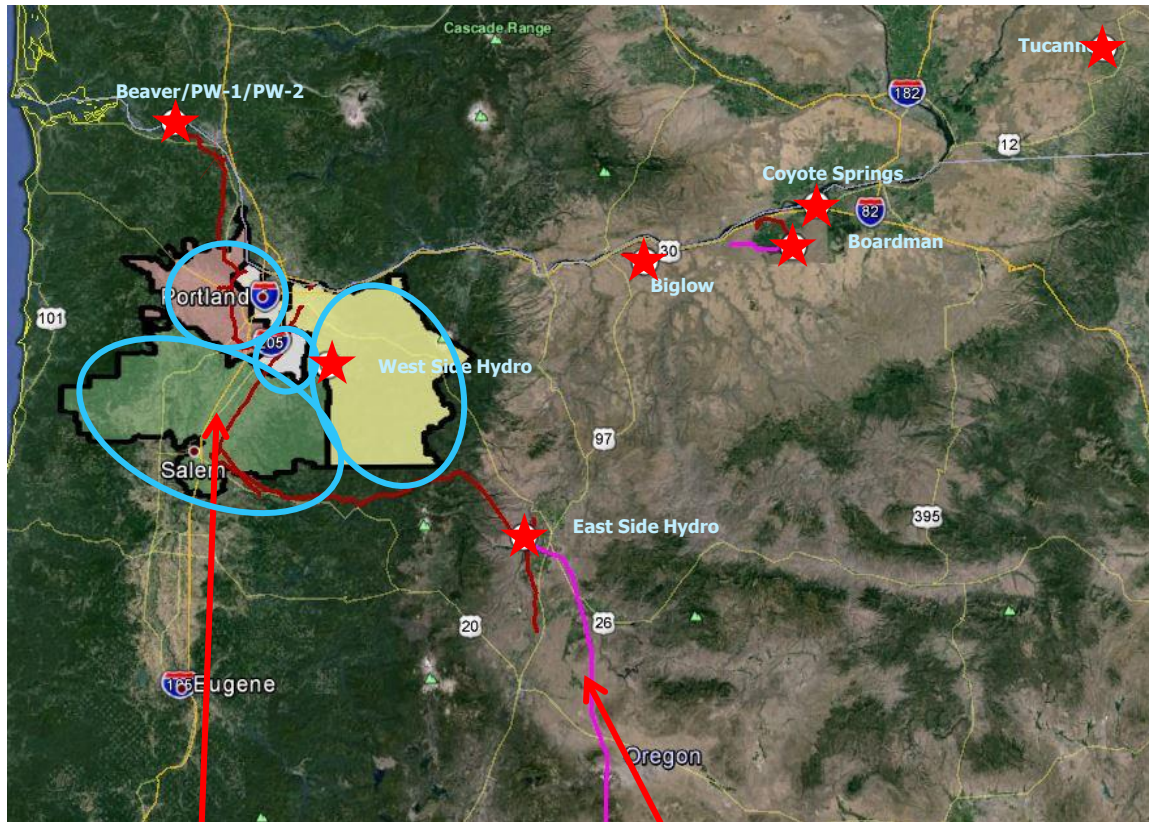

Distribution Regions

Transmission lines

 Current coverage  Generation plants

- T&D system users:
 - Line Crews
 - Substation Crews
 - Meter Services
 - Field Connect Reps
 - Field Engineers
 - Corp Security
- Generation sites have their own land mobile radio systems
- No coverage for transmission lines outside distribution territory
- Inability to communicate between regions
- Single conversation at a time per region
- No coverage in certain non-urban service territory and transmission areas causing safety, reliability and efficiency issues
- Does not support consolidation of all regions into a single integrated service network
- Experiences interference from other frequencies
- Outdated equipment

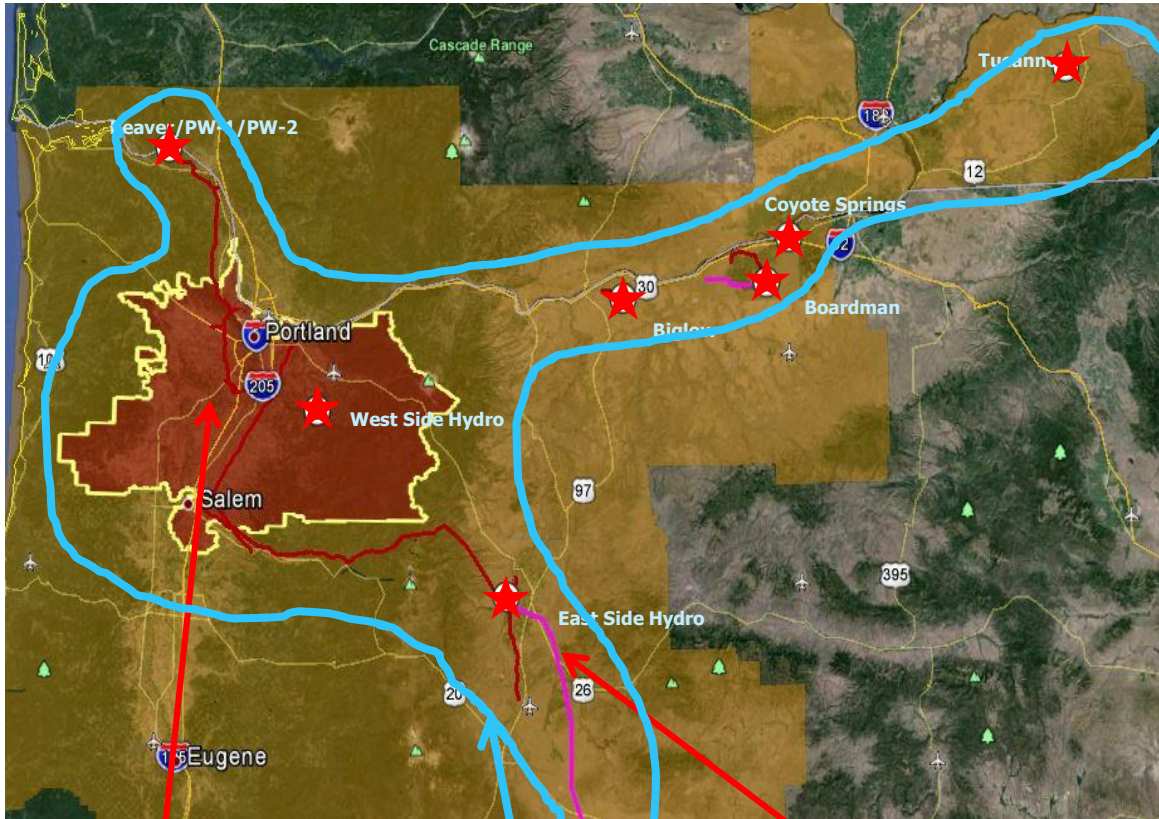

"Regionless"
Distribution

Largest possible
coverage

Transmission lines



Generation plants



Spectrum purchased by county

Recommendation:

Design, build and commission a land mobile radio system based on 220 MHz spectrum.

Benefits:

- Seamless wide-area coverage for distribution, transmission, generation and corporate operations.
- Highly reliable, exclusive private use, multi-party two-way communications voice network to ensure employee safety, system reliability and efficiency.
- Scalable platform to meet future operations.
- Resilient communications network to support business continuity and emergency management.
- Modern equipment; lower operating and maintenance cost.
- Centralized network management.

700 MHz Conceptual Spectrum Allocation

Data = 650 kHz/basestation supporting approx 512 kbps

**Uplink
(Mobile-to-Base)**

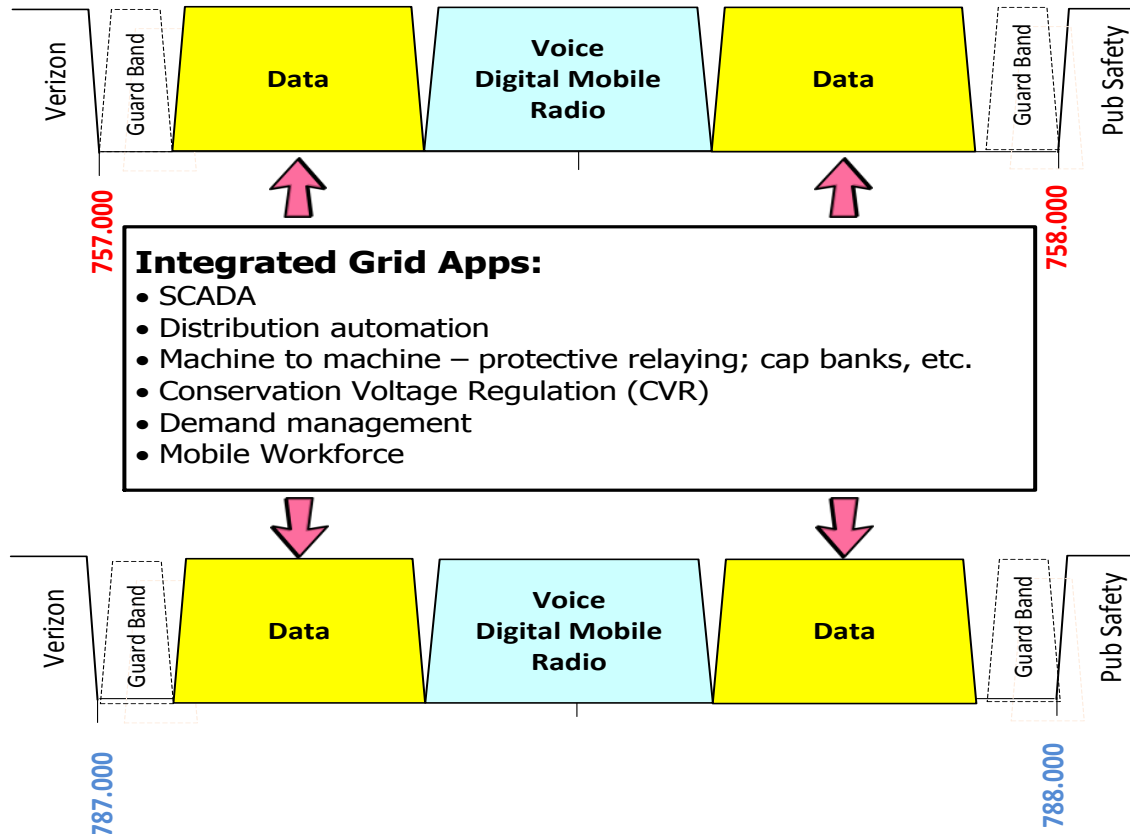

**Downlink
(Base-to-Mobile)**

Schedule and Roles and Responsibilities

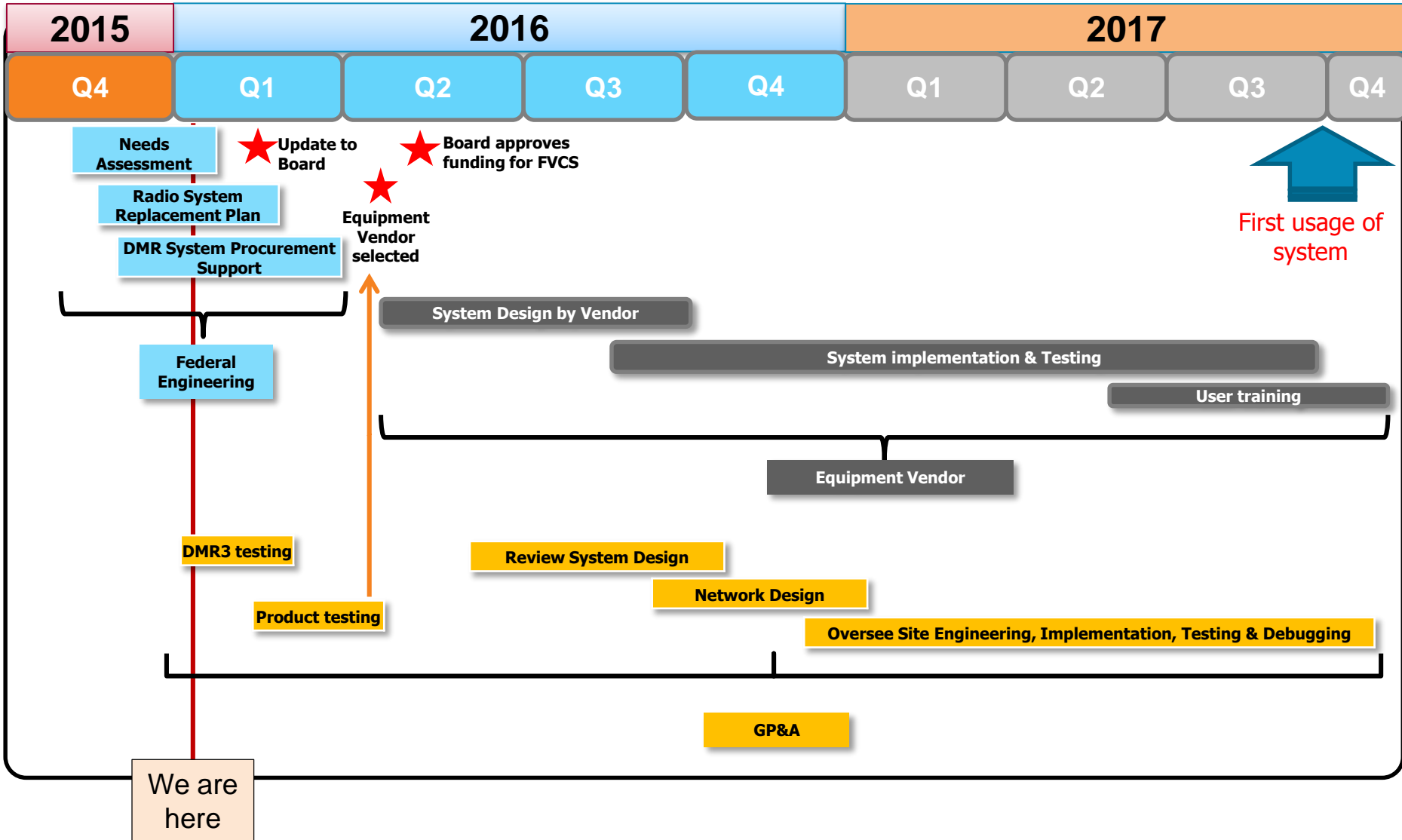

Presentation to IEEE 802.16 Meeting
Atlanta, GA - 1/19/2016

PRIVATE LICENSED SPECTRUM FOR UTILITIES UPPER 700 MHZ A BLOCK SPECTRUM

- Alternative Spectrum Sources for Utilities
- Private Licensed Spectrum Advantages
- Upper 700 MHz A Block Specifics



Robert Finch
Select Spectrum
703 635 2686
rfinch@selectspectrum.com

For the Mid 21st Century Utility (and Much Sooner) – **Spectrum is Mandatory**

- Fast effective communications, monitoring and control between all sources, transmission and distribution equipment and users of electricity (or gas, water, etc.)
- Wireless to replace **wired TDM and leased line circuits being cancelled by telcos**
- Bandwidth and latency to match requirements
- High security and reliability
- **Typically funded by operating savings & increased reliability**
- Supports AMI, distributed generation and storage, demand response and various regulatory and competitive structures
- Happier customers + increased profits

Potential Spectrum Sources Under Consideration

1. Unlicensed (and Lightly Licensed)
2. Shared Access
3. FirstNet LTE System - share excess capacity from conceptual system
4. Shared or exclusive licensed spectrum grant from government
5. Purchase Exclusive Licensed Spectrum

Spectrum Alternatives - Summary

- Unlicensed – Power limits and increasing interference problems
- Authorized Shared Access – Uncertainty, power limits, complexity and dominance by wireless carriers
- FirstNet = Second class customer of dysfunctional partner with no network yet
- Grant of spectrum from government? Past failures, regulator statements and possibly federal law say success is highly unlikely
- Licensed Spectrum – Investment in the future

Obtain Licensed Spectrum

- Except for narrowband in limited situations, will require purchase or lease
- Accommodate current and future applications – Field Area Network
- High security and reliability
- Higher power levels and protection from RF interference
- Operating savings and reliability improvements justify investment

Questions Before Spectrum Purchase

- How much (bandwidth) is available, and is that enough for the application(s)?
- Will the propagation characteristics and power be adequate?
- Are there any legal disputes among licensee partners or between licensee and FCC or adjacent licensees?
- Have prior transfers of similar licenses been approved?
- When does current license period end, and what is required for renewal?
- Does planned use match license rules? Waiver required?
- Are there any other license operations in the same band in your area of operations?
- What ecosystem of users and vendors exists in the band?

Upper 700 MHz A Block

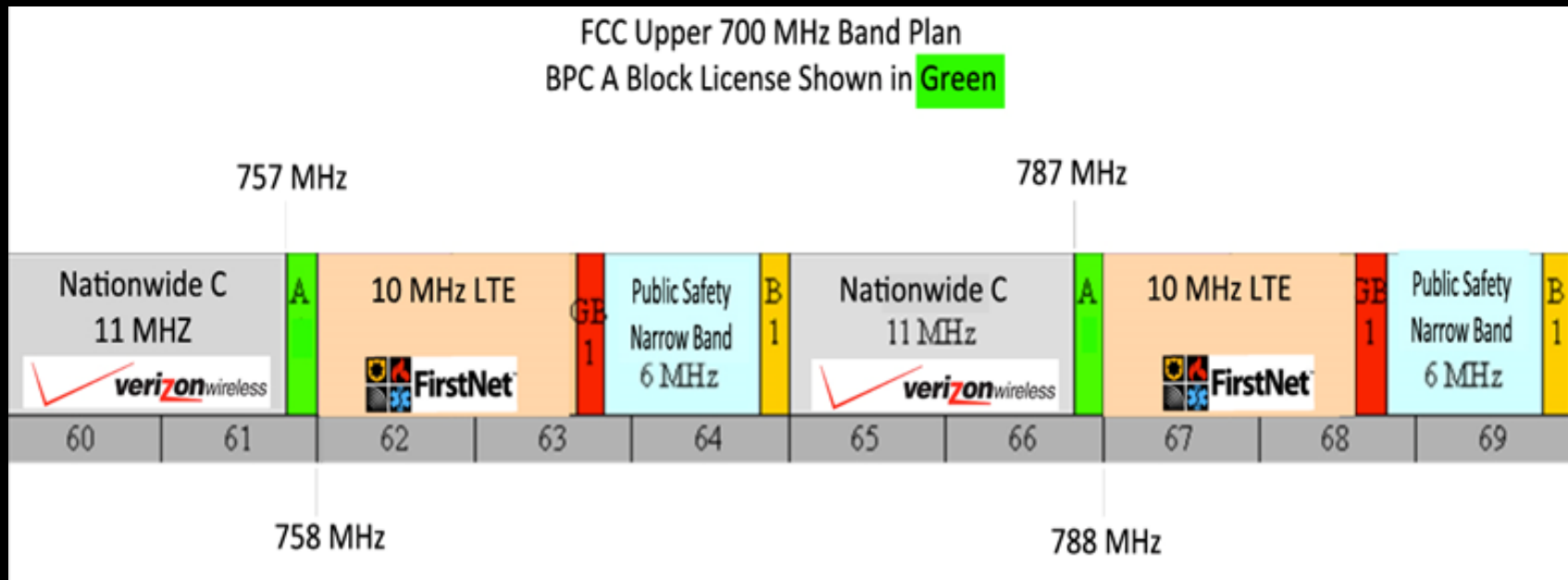

- Exclusive 2 x 1 MHz licenses, located between Verizon and FirstNet with same interference protection rules
- Fixed or Mobile
- Best combination of propagation and capacity for utility use
- Recommended by UTC in 2013 White Paper

700 MHz A Block Licenses

Held by Selling Investors and Utilities Nationwide

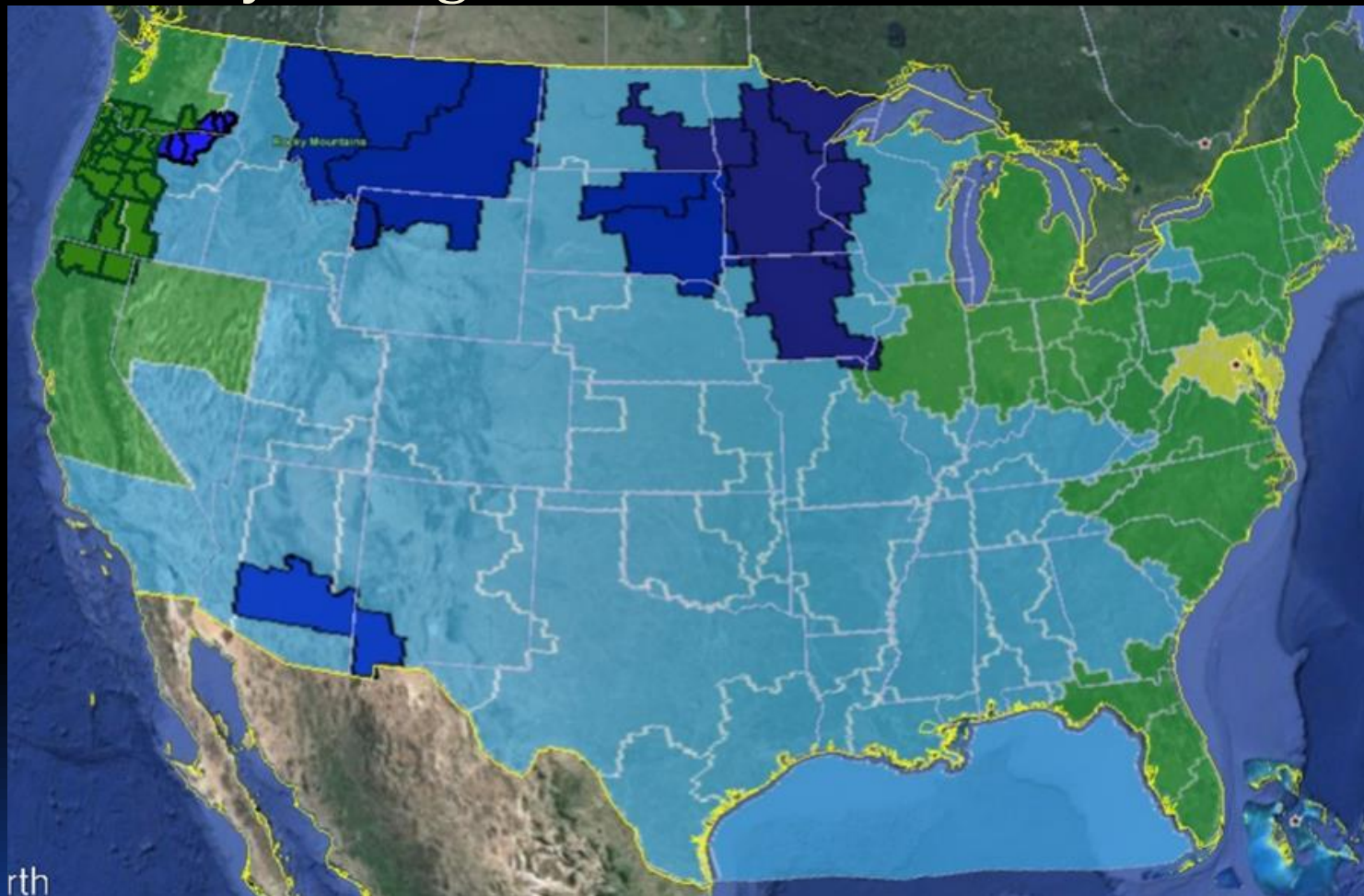

rth



Technical Aspects – Upper 700 MHz

A Block “Wideband”

- Transmit power:
 - Up to 1000 Watts ERP at 1000 feet at 757-758 MHz
 - Up to 30 Watts ERP at 787-788 MHz
- Superior propagation over terrain and through foliage
- Fixed or Mobile – Pt-Pt or Pt-Multipoint
- FDD or TDD
- Capacity estimate: 4 Mbps per tower site
- Equal interference protection with adjacent bands – OOB attenuation $\geq 43 + 10 \log P$ dB
- Most available bandwidth in private band < 1 GHz

Utilities Using and Acquiring Upper 700 MHz A Block Licenses

- System deployed: **Great River Energy** in Minnesota – Now leading “**Utility User Group**” including license holders and interested utilities
- **Salt River Project** – successful field trial led SRP to purchase license covering Phoenix and much of Arizona
- **Northwest Energy** acquired licenses in Montana and South Dakota
- **Portland General Electric** acquired licenses in Oregon, Washington and California Counties
- Other negotiations underway

Equipment & Standards - Upper 700 MHz A Block

- Currently available:
 - Full Spectrum
 - ConVergence Technologies
 - 4RF
- Walker & Associates supporting development and distribution of equipment
- Other manufacturers have agreed to modify equipment for band (GE Digital Energy, MiMOMax & XetaWave)
- Additional manufacturers will build to order
- **Utilities are demanding standards-based equipment,** and standards will expand the market



Approaches for Narrower Channel Implementation

Guy Simpson, COO

gsimpson@fullspectrumnet.com

January 2016

www.fullspectrumnet.com

- ◎ Company founded in 2006
 - Privately held, Delaware Corporation
 - Headquartered in Sunnyvale, CA
- ◎ Target Market: Private Wireless Data Networks
 - SCADA, AMI Backhaul
 - Distribution Automation
 - Distributed Generation
 - Mobile Data
- ◎ Domestic US Utility Activity
 - Numerous field trials starting in Q4 2010
 - First deployment Q2 2012
 - Focus on rural applications and challenging terrain

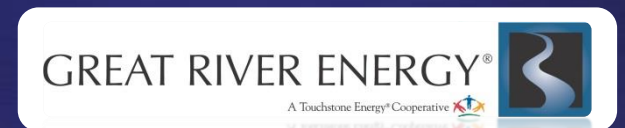

- ◎ Private Wireless Networks
 - Large Cells (25+ mile radius)
 - Relatively Low Endpoint Density
 - Leverage Existing Infrastructure
- ◎ Limited Spectrum Availability
 - 1 MHz channels or smaller - “Mid-band”
- ◎ Multi-megabit Throughput
 - Reverse Asymmetrical, Symmetrical & Asymmetrical
- ◎ Flexible Bandwidth Deployment

- ◎ Software Defined Radio
 - Frequencies from 40 MHz to 958 MHz
 - Channels sizes from 200 KHz to 5 MHz
 - Transmit power (Base Station & Remote) up to 20W
 - Receiver sensitivity as low as -107 dBm (500 kHz channel)

- ◎ Proprietary Variant of IEEE 802.16
 - Time Division Duplexing
 - Adaptive Modulation and Coding
 - Band-AMC Sub-channelization
 - Frequency reuse factor up to 6 in single channel
 - Quality of Service
 - Classification and prioritization
 - Multiple scheduling types (UGS, ErtPS, rtPS, nrtPS & BE)

Design Considerations



- ⊙ Fragmented Spectrum Availability
 - Flexibility to support multiple FCC regulations
- ⊙ Narrower Channel Advantages
 - Extended Range
 - Improved CINR
 - Reduced Infrastructure Costs
- ⊙ Reverse Asymmetrical Applications
 - Balancing Uplink & Downlink Link Budgets
 - Remote transmit power similar to Base Station
 - TDD to support appropriate Downlink : Uplink ratio
- ⊙ Relatively Small Private Networks
 - Simplified and Distributed Provisioning

Proposed Air Interface Protocol Changes



- ⦿ Based on the 128 FFT flavor for 1.25 MHz channel
- ⦿ Alternate Proposals for a narrower channel...
 - Reduce subcarrier spacing:
 - Signal structure is maintained with appropriate modifications of the sampling clock, the symbol duration and the TDD frame structure.
 - Eliminate one or more sub-channels:
 - Typically maintain a minimum of 3 sub-channels for re-use
 - Use continuous subcarrier allocation (Band-AMC 2x3 & 1x6)
 - Modify Subcarriers used for Downlink preamble and Uplink CDMA codes so as not to extend beyond channel boundary
- ⦿ Single zone Band-AMC in both Downlink and Uplink

Proposed Air Interface Protocol Changes (continued)



- ⊙ Preamble Changes
 - Support no preamble configuration
 - Support minimal preamble boosting (e.g. 3 dB)
 - Change preamble format to exist within subcarriers used
- ⊙ Support New Symbol rates...
 - Sampling Clock for 1 MHz wide channel : 1.12 MHz
 - Sampling Clock for 500 KHz wide channel : 0.56 MHz
- ⊙ Support New Frame Durations...
 - 12.5 and 25 ms
- ⊙ Support Any Number of Symbols in Any DL:UL Ratio
- ⊙ Support Variable Gap Duration to Accommodate Range

Proposed Changes to Improve Bandwidth Efficiency



⊙ Overhead Reduction

- DL-MAP customization...
 - MAP CRC reduced from 32 to 8 bits
 - Non rectangular DL bursts to reduce wastage
 - Packing of SDUs belonging to different service flows
- UL-MAP customization. Example
 - MAP CRC reduced from 32 to 8 bits

⊙ Automatic PHS

- Limited PDU header variation facilitates suppression

⊙ TCP Acceleration through Ack Prioritization

IEEE 802.16s Amendment



- ⊙ Market Demand for Public Standard
- ⊙ Vendor Diversity and Interoperability
- ⊙ Numerous Small Private Networks
- ⊙ Security and Sustainability