

# IEEE 802 Tutorial on WhiteSpaces, Technologies and Standardization .... *Means to Bridge the Digital Divide*

Apurva N. Mody, Ph. D.

BAE Systems, WhiteSpace Alliance

Chair, IEEE 802.22 Working Group on Wireless Regional Area Networks

[apurva.mody@ieee.org](mailto:apurva.mody@ieee.org)

+1-404-819-0314

With Inputs from:

Oliver Holland (802.22, UK / EU Update), Rich Kennedy (802.11af),

Bob Heile, Clint Powell (802.15.4m), Steve Shellhammer,

Naotaka Sato (802.19)



---

# Addressing the Problem of Digital Divide

# United Nations Sustainable Development Goals (SDGs)

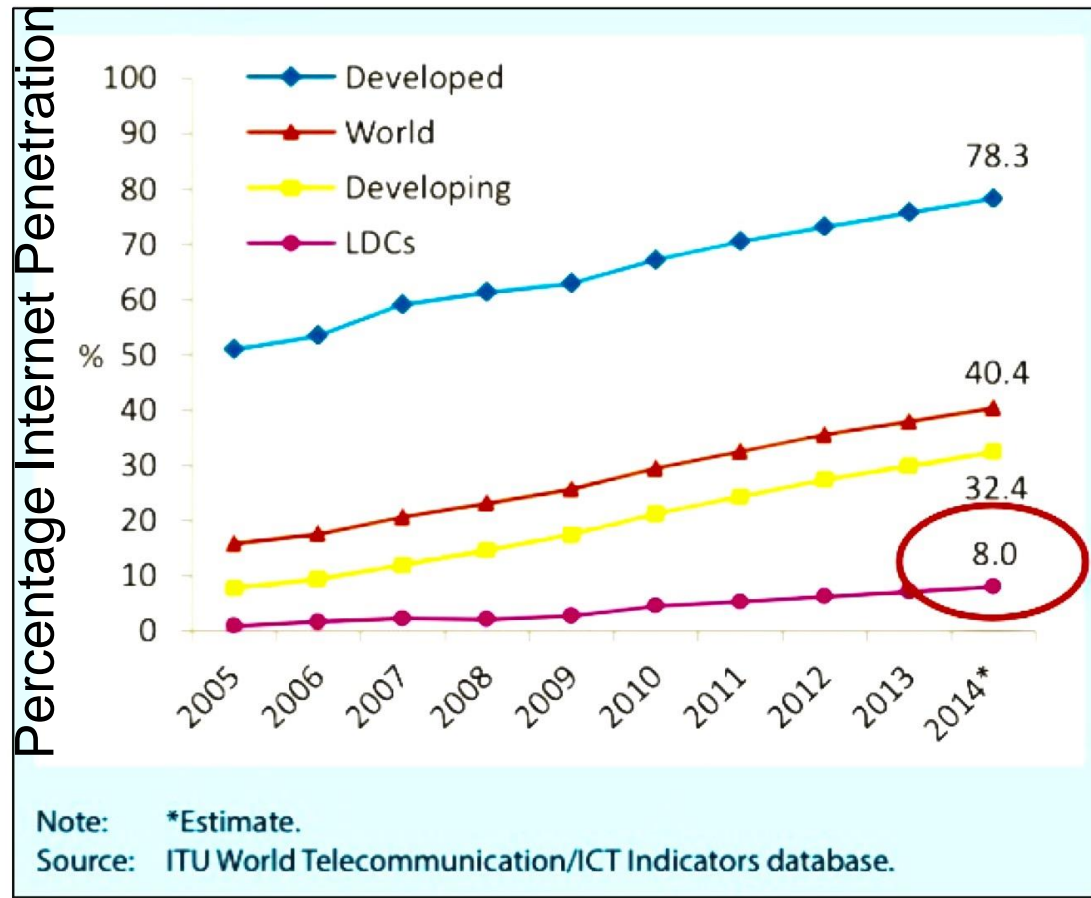

**SDG Target 9c**  
**“Significantly increase access to information and communications technology and strive to provide universal and affordable access to the Internet in least development countries by 2020”**

LDCs = Least Developed Countries (48 countries)

## Reality of Affordability vs Reach Challenge

Billions of People on Earth	Average Annual Income	Affordable monthly communications spend
1 <sup>st</sup> Billion	\$29,206	\$205
2 <sup>nd</sup> Billion	\$12,722	\$53
3 <sup>rd</sup> Billion	\$5,540	\$23
4 <sup>th</sup> Billion	\$2,987	\$12
5 <sup>th</sup> Billion	\$1,771	\$7
6 <sup>th</sup> Billion	\$1,065	\$4.4
7 <sup>th</sup> Billion	\$540	\$2.25

Source: Richard Thanki, University of Southampton, from UN & ITU Data

## Providing cost-effective **RURAL** broadband is a significant opportunity

- Today, 73% of the people in the world (5.1 Billion people) do not have access to internet. More than half the population in the world live in rural areas with hardly any access to broadband.
- It is expensive to lay fiber / cable in rural and remote areas with low population density.
- Wireless broadband powered by license exempt or lightly licensed spectrum can help.
- Backhaul / backbone internet access for rural areas is very expensive (50% of the cost). Hence long distance communications technologies are very useful as well.
- **Digital-Divide is in Reality a Middle-Mile Divide** – Optical Fiber/ Coaxial Backbones near Urban Hubs, IEEE 802.11 Wi-Fi for the Last Mile Connectivity. Wi-Fi alternatives exist for long distance Line of Sight connectivity. There is no affordable solution for Non Line of Sight (NLoS) Ranges from 5 km to 30 km.
- **This has created a DIGITAL DIVIDE / OPPORTUNITY**

# Relative Cost and Complexity of Various Technologies for Rural and Regional Area Broadband Service

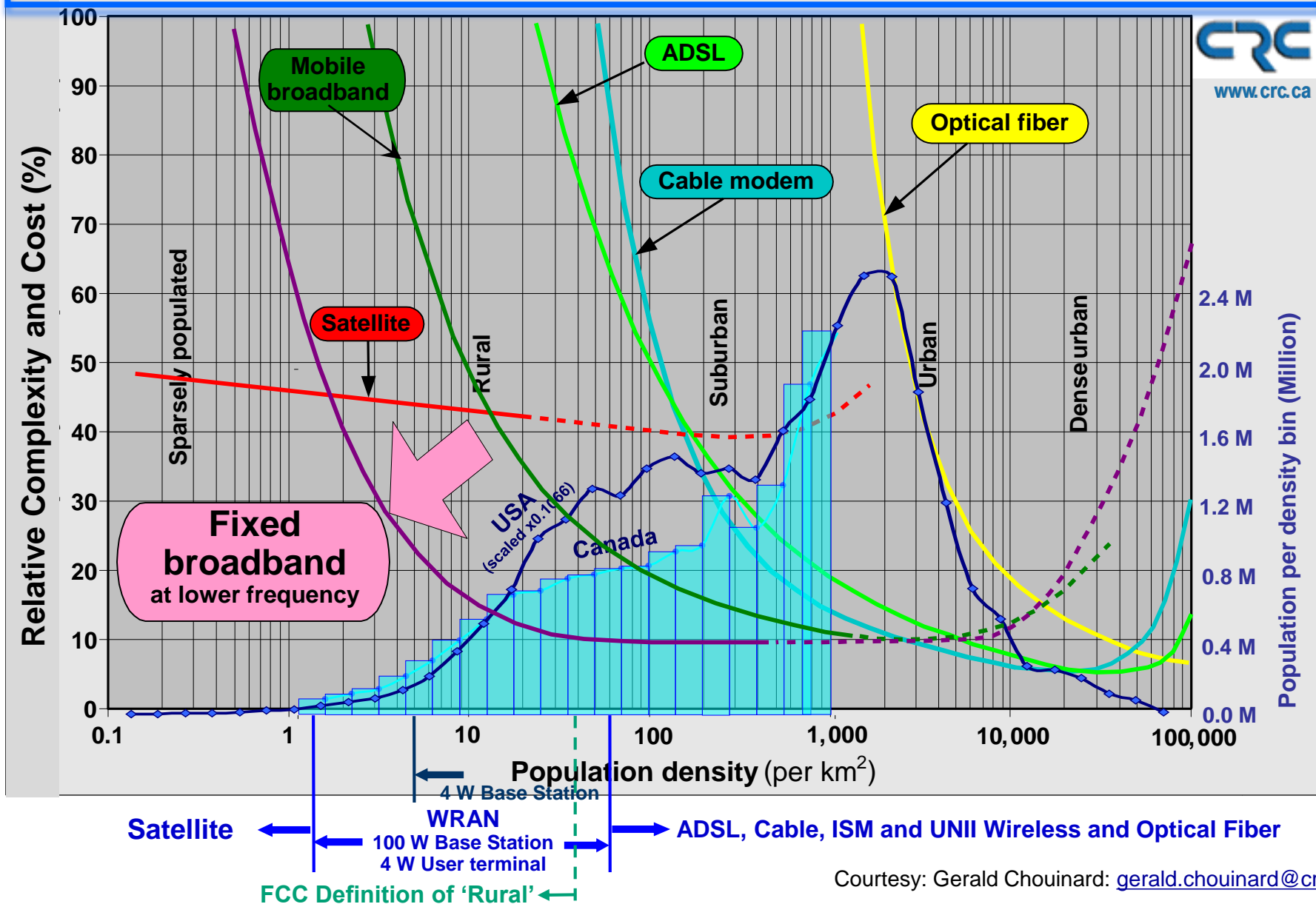

Courtesy: Gerald Chouinard: [gerald.chouinard@crc.ca](mailto:gerald.chouinard@crc.ca)

---

# How the Use of Television WhiteSpaces can Solve the Problem of Digital Divide

# Spectrum: Optimum frequency range for large area Non-Line-of-sight Broadband Access

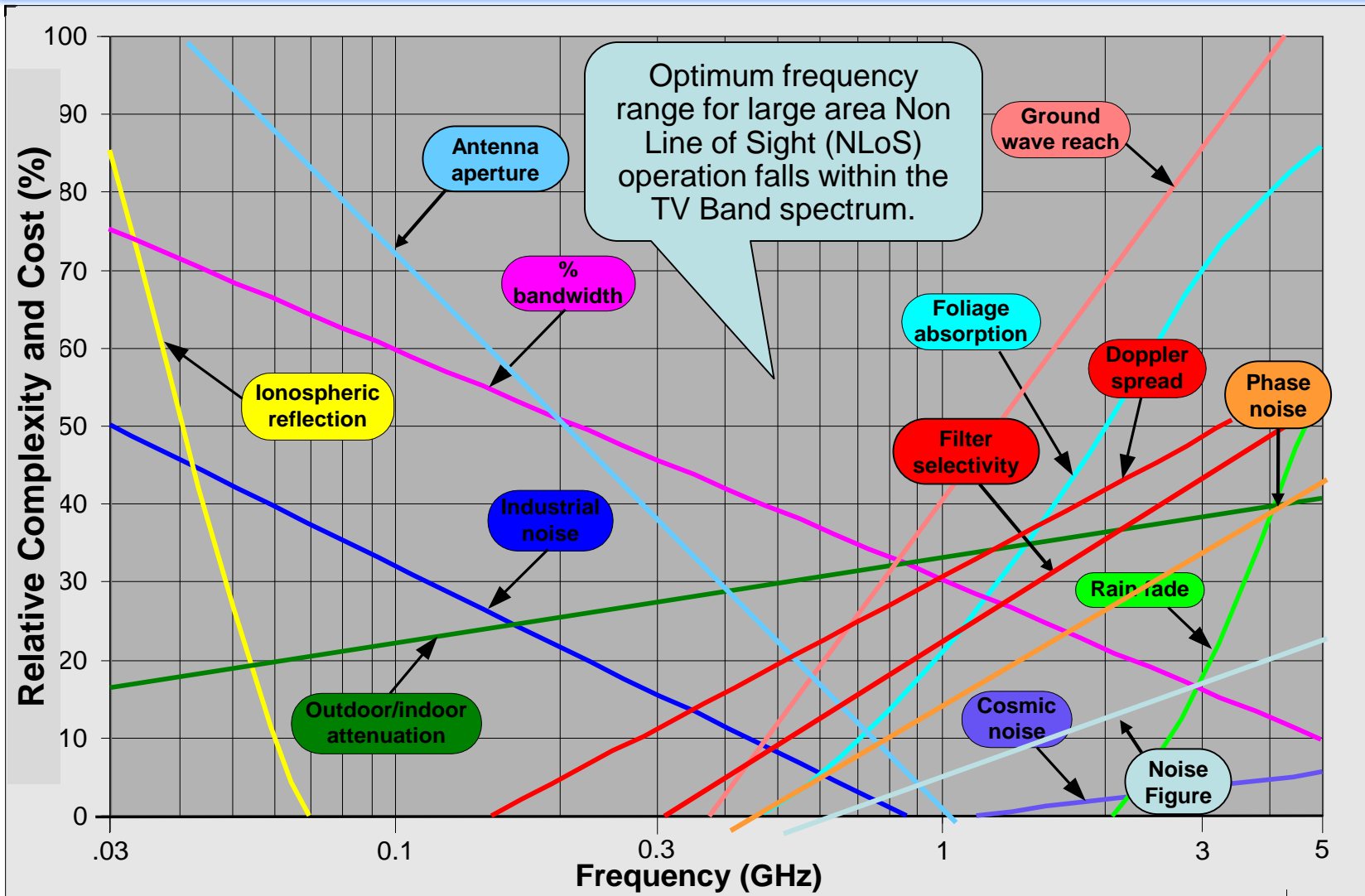

Courtesy: Gerald Chouinard: [gerald.chouinard@crc.ca](mailto:gerald.chouinard@crc.ca)



# What are TV Band WhiteSpaces (Video)



IEEE  
802

<https://www.youtube.com/watch?v=MCUUSGVgjV4>

# IEEE WhiteSpace Applications

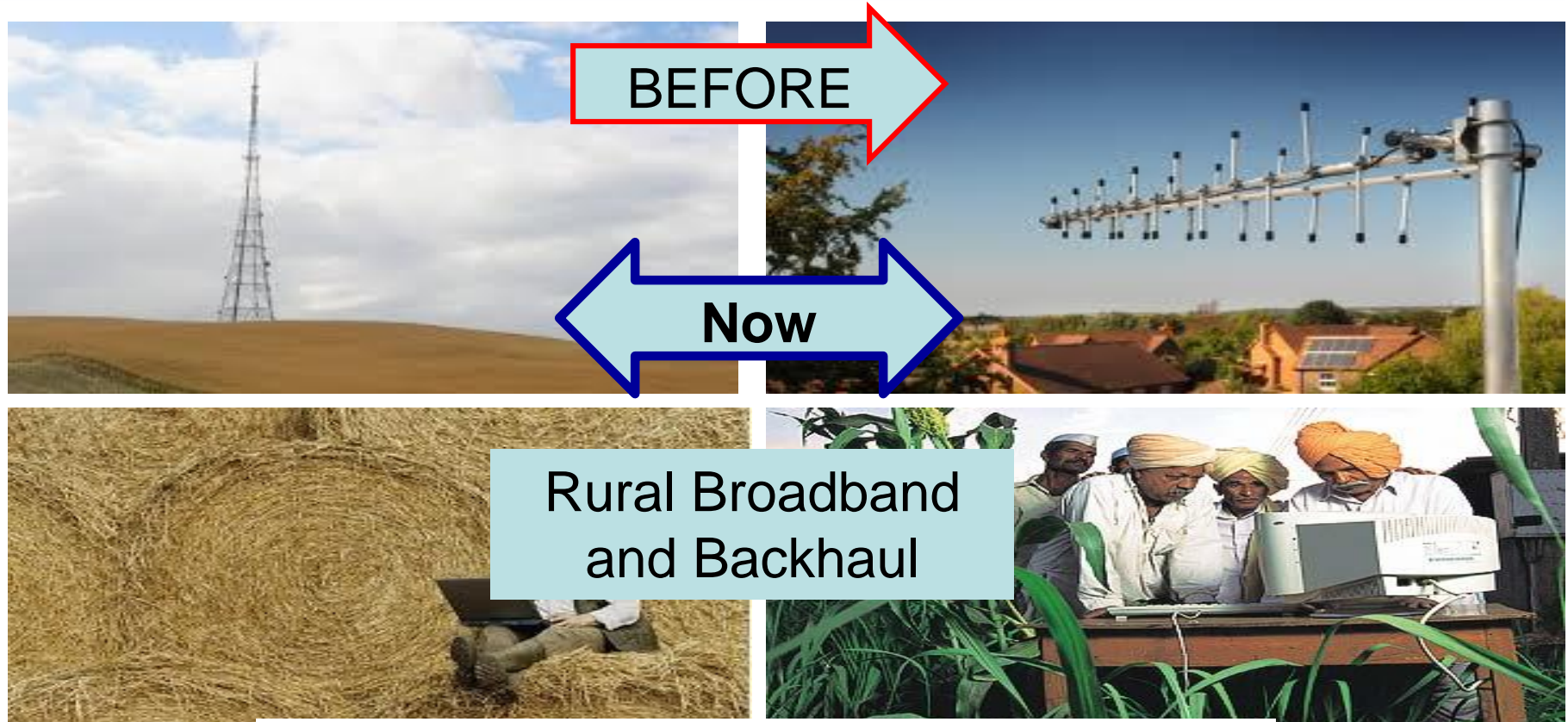

NOTHING

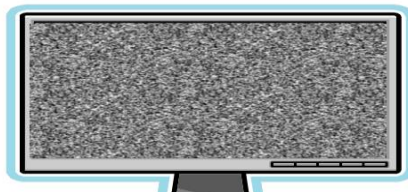

TVWS

HIGH SPEED INTERNET



IEEE  
802

# TVWS: Much Larger distance covered at much lower power transmission. Allows operation using Solar Panels

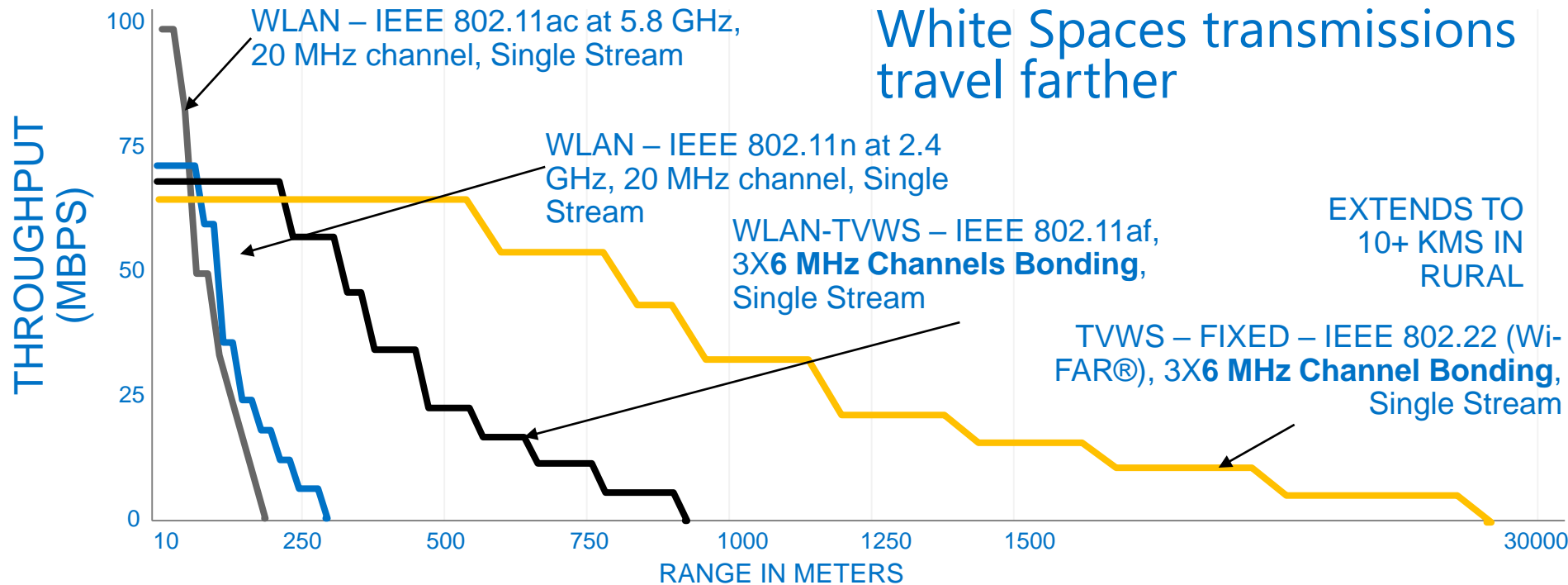

Source: Microsoft Presentation at the WhiteSpace Alliance, Global Summit on WhiteSpaces, New Delhi, 2015

- Provides 3-4x the range and 9-16x the coverage of current 2.4 GHz Wi-Fi (40 mWatts). Multi-kilometer range at higher power (up to 4 Watts EIRP).

# TV WhiteSpace Database (Entire USA)

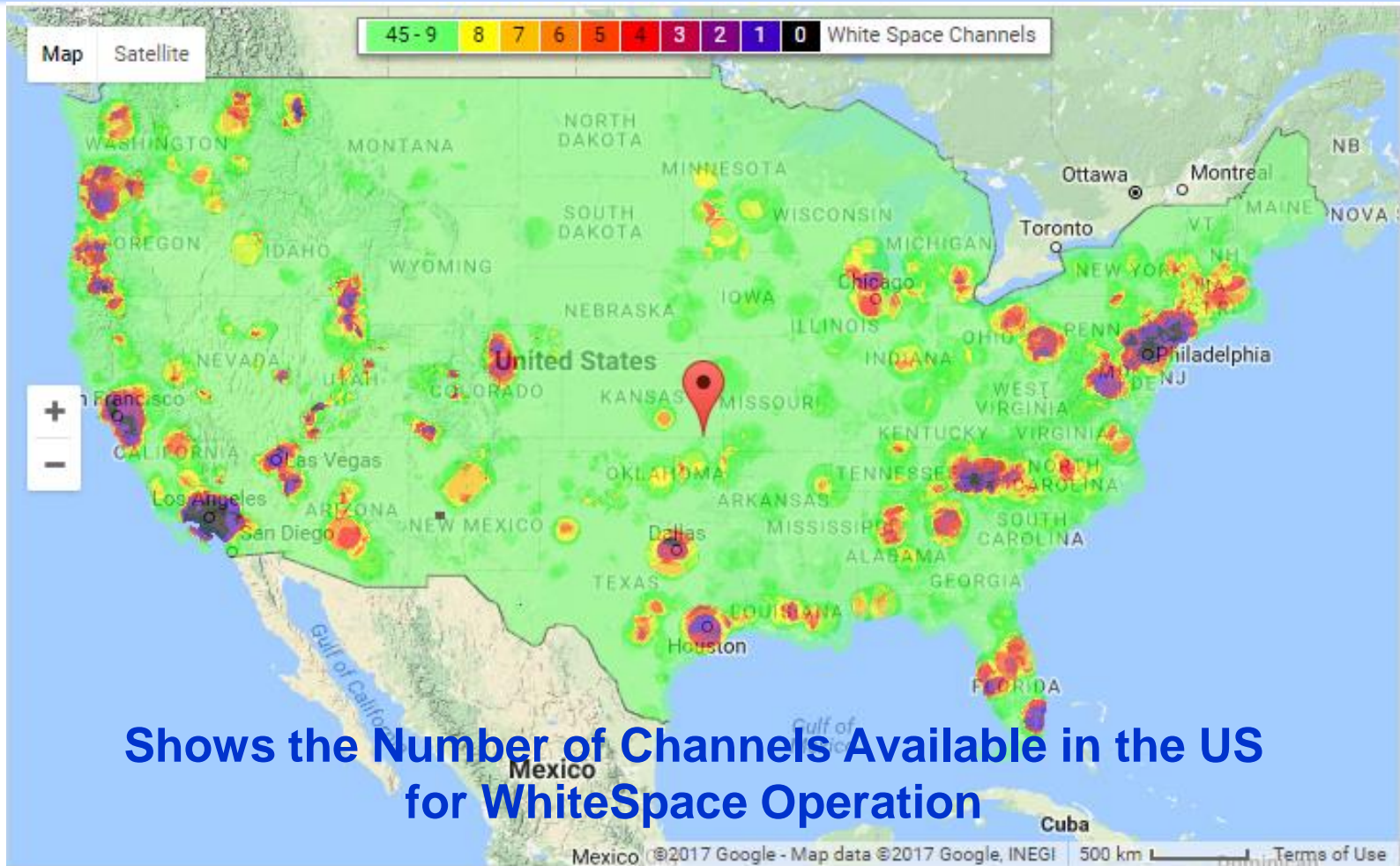

IEEE  
802

<https://www.google.com/get/spectrumdatabase/channel/>

Most Database Providers in the USA use the **IETF Protocol to Access WhiteSpaces (PAWS)** Standard for connectivity between Devices and Database

# TV WhiteSpace Database (Specific Locations)

Search for white space spectrum in your area:

Device type [What's this?](#)

Fixed  Portable

Address

kansas city

Latitude

39.099727

Longitude

-94.578567

Height (m)

10

Height type

Above ground level

Search

Reset

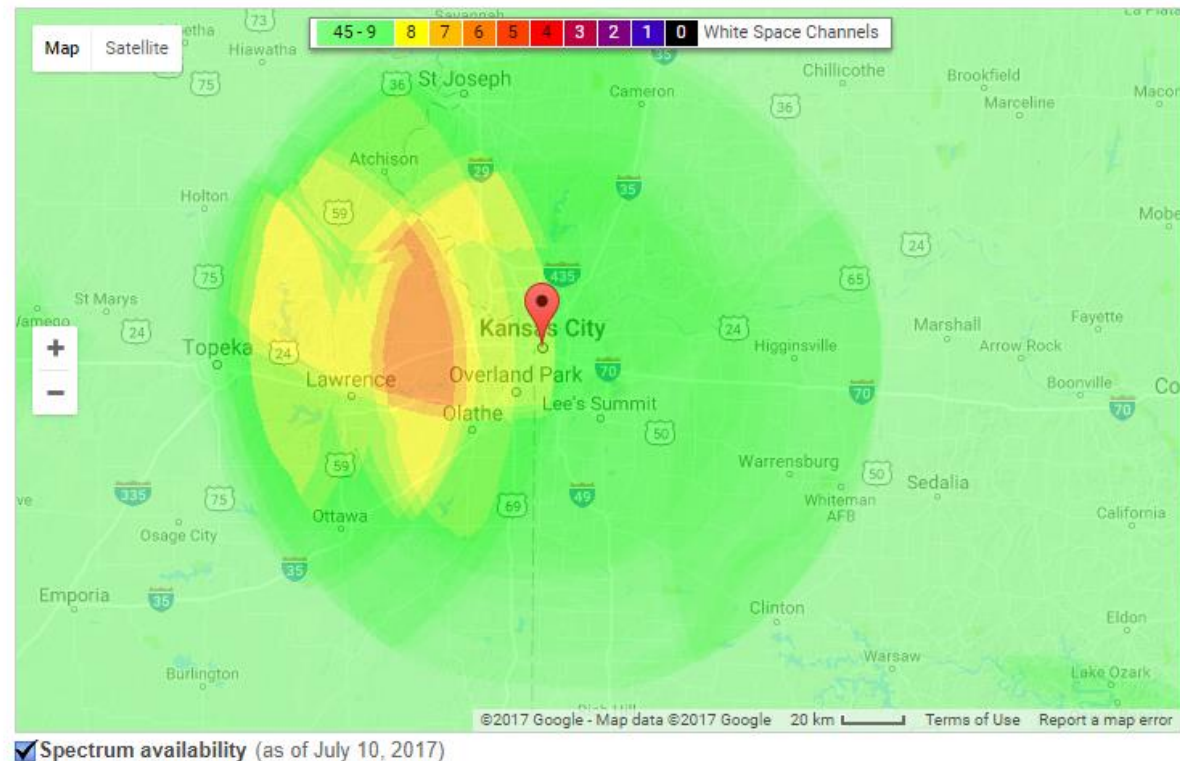

**Shows the Number of Channels Available in Kansas City, Kansas.  
More than 10 WhiteSpace Channels of 6 MHz each available for  
communications**

IEEE  
802

<https://www.google.com/get/spectrumdatabase/channel/>

# TV WhiteSpace Availability (Africa)

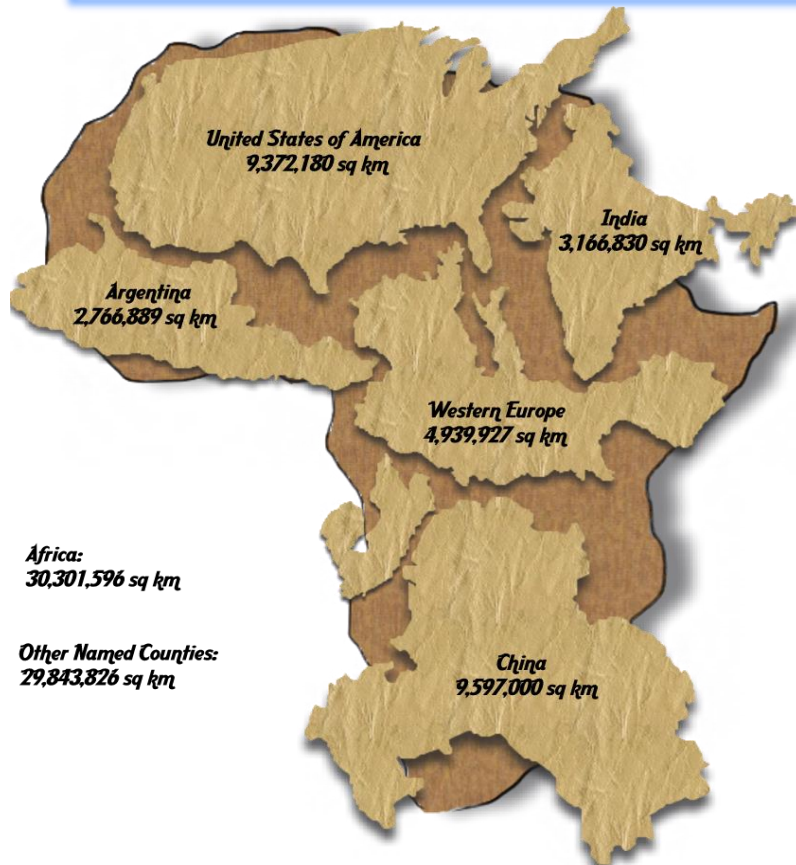

## Television Spectrum Occupancy in African Countries in 2012

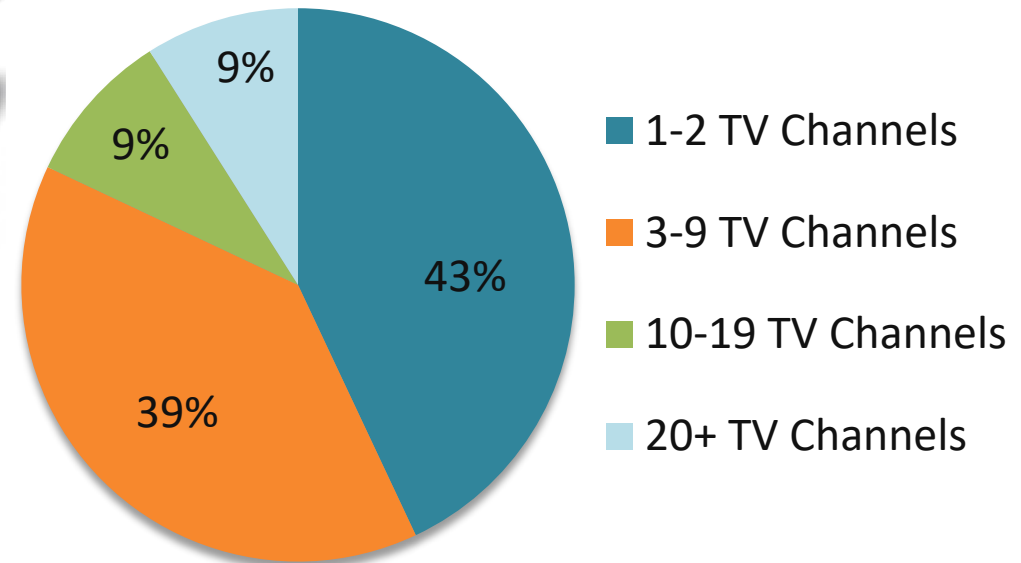

- Africa is huge by area and as an economy
- Low internet penetration, large areas to cover and availability of plenty of TV WhiteSpaces makes WhiteSpace Communications ideal for African and other developing economies

# India - UHF Band-IV (470-590MHz) Over 100 MHz of WhiteSpaces Available

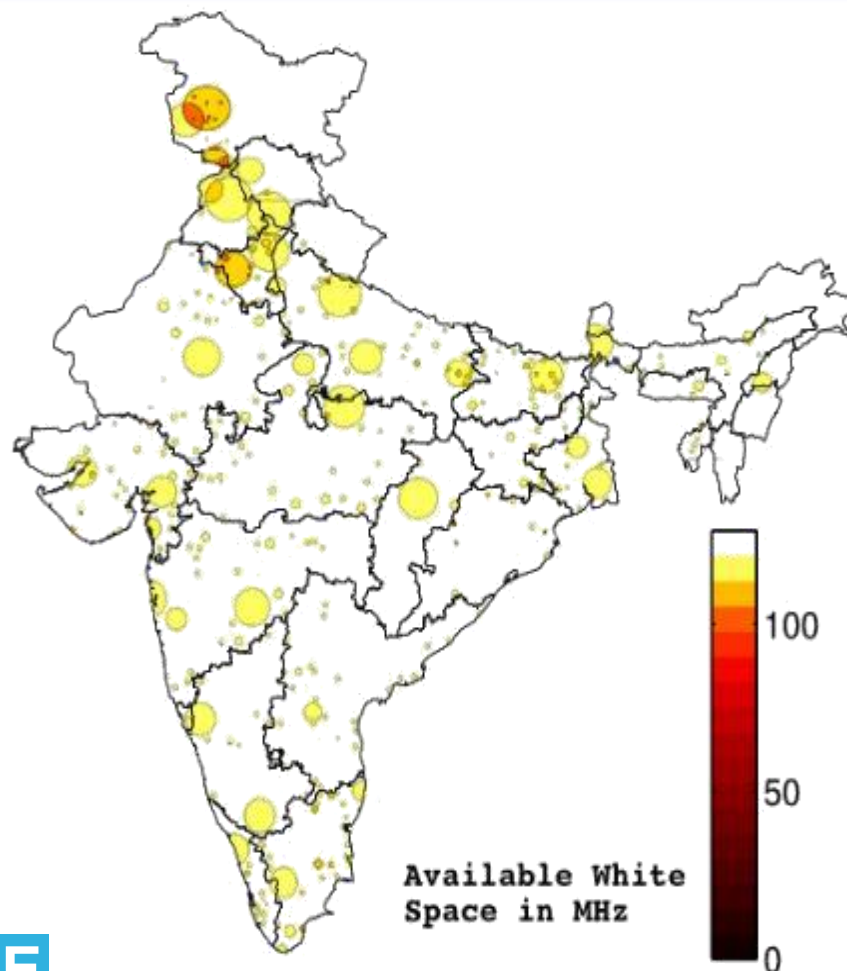

## Band Characteristics

- 1 Primary user: Doordarshan  
373 transmitters overall
- 2 15 channels of 8MHz  
each
- 3 At any place at least 12  
out of 15 channels are  
always available
- 4 Better propagation  
characteristics than  
existing unlicensed  
band
- 5 Potential for providing  
affordable rural  
broadband

IEEE  
802

\* Using protection viewpoint [Mishra-Sahai'09]

[http://www.whitespacealliance.org/documents/Research%20Paper%20on%20White%20Spaces\\_final2.pdf](http://www.whitespacealliance.org/documents/Research%20Paper%20on%20White%20Spaces_final2.pdf)

---

# **TV WhiteSpaces Applications and Trials Around the World**



# TV WhiteSpace Regulations and Trials Around the World

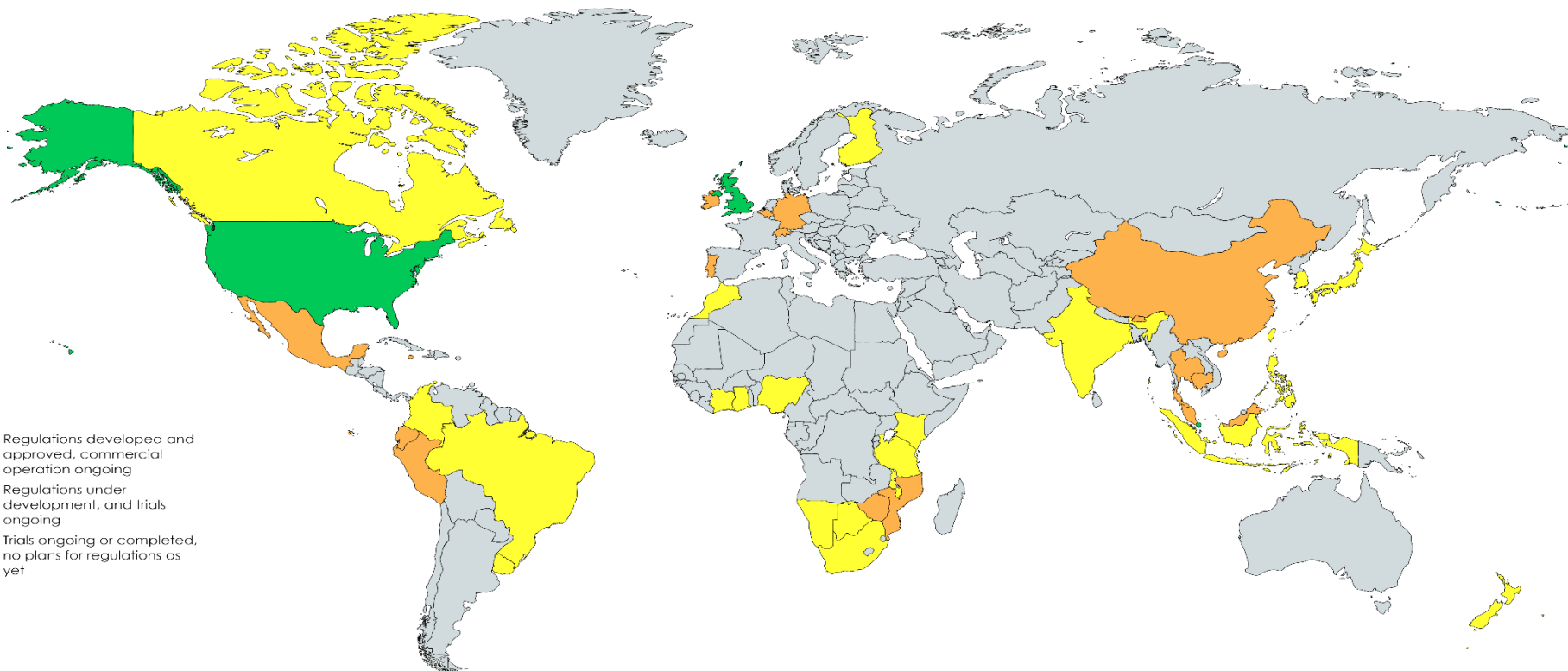

Created with mapchart.net ©

- Completed WhiteSpace Regulations
- On-going WhiteSpace Regulations
- Trials Conducted

# What are TV Band WhiteSpaces (Video)



# WhiteSpace Applications

Triple play

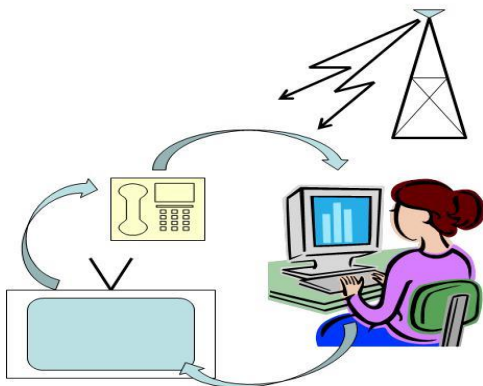

Cellular offload



Critical infrastructure monitoring

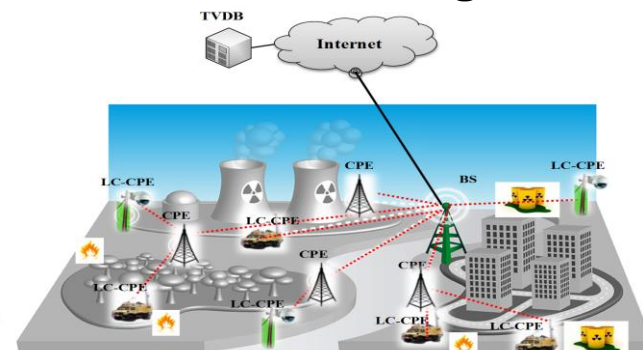

Border protection

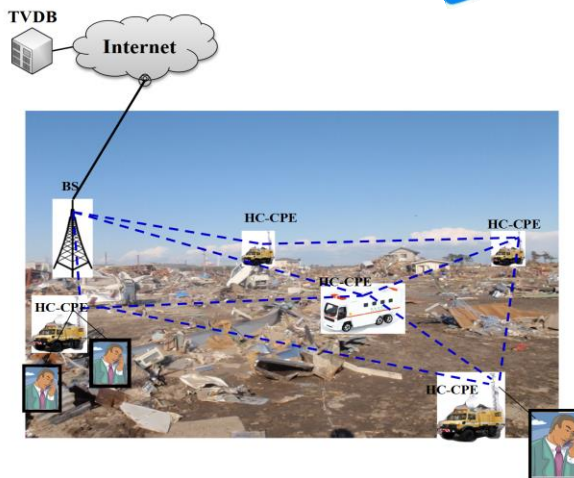
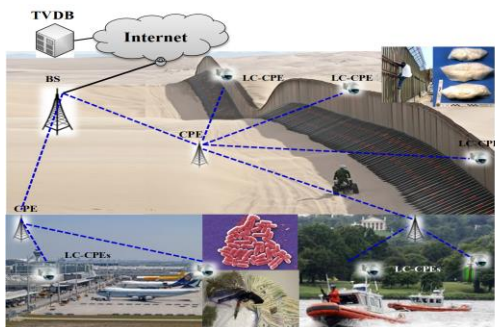

Emergency broadband infrastructure

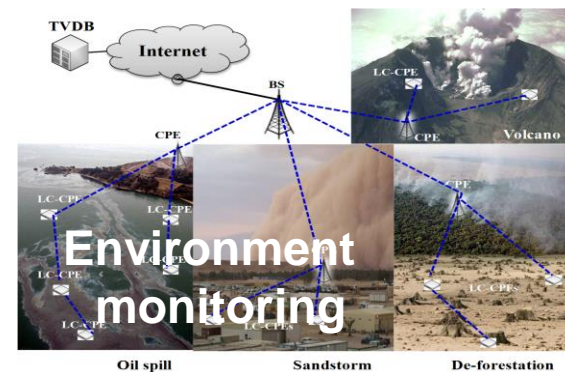

# WhiteSpace Applications

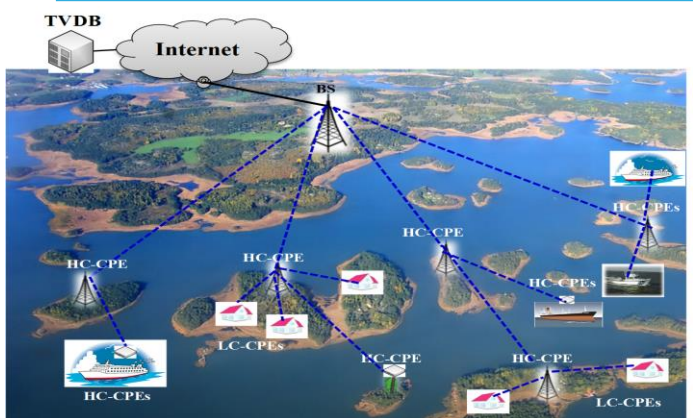

Archipelago and marine broadband service.  
Servicing oil rigs

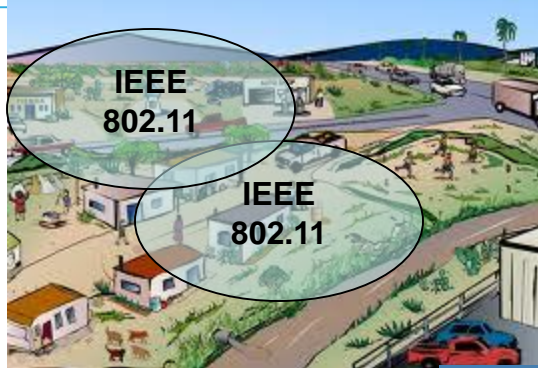

Rural Area



Urban Area

IEEE 802.22 used for Backhaul

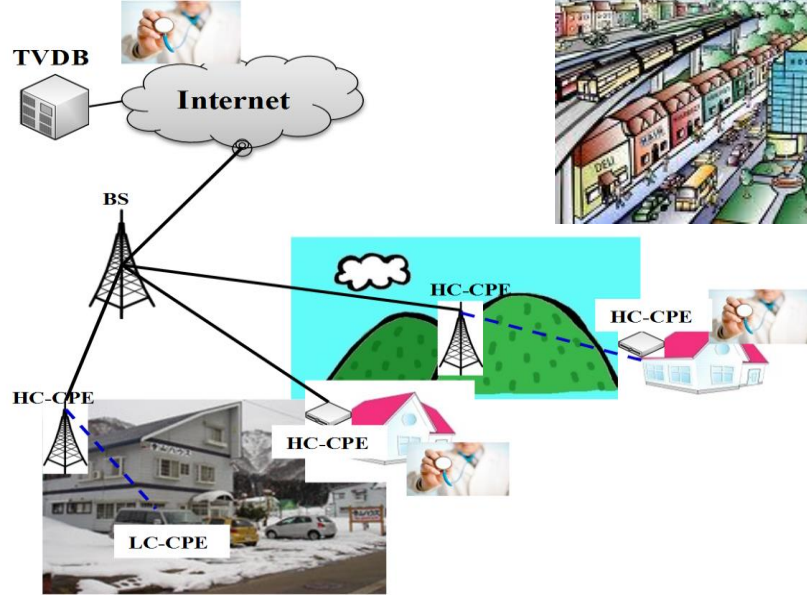

Remote medical service



C. W. Pyo, A. Mody et al. Use Cases for IEEE 802.22 (Wi-FAR® Smart Grid and Critical Infrastructure Monitoring)

# Trial of the IEEE 802.22 Trial, Tono, Japan



IEEE  
802

<https://mentor.ieee.org/802.22/dcn/17/22-17-0058-00-0000-video-of-nict-802-22-trials-tono-japan.wmv>

[http://www.whitespacealliance.org/documents/hitachikokusai\\_nict\\_802dot22\\_802dot11af\\_trials.pdf](http://www.whitespacealliance.org/documents/hitachikokusai_nict_802dot22_802dot11af_trials.pdf)

# TV WhiteSpace Trials in India



Palghar (Maharashtra) > IIT  
Bombay



Delhi > IIT Delhi & IIIT



Varanasi ERNET & BHEL

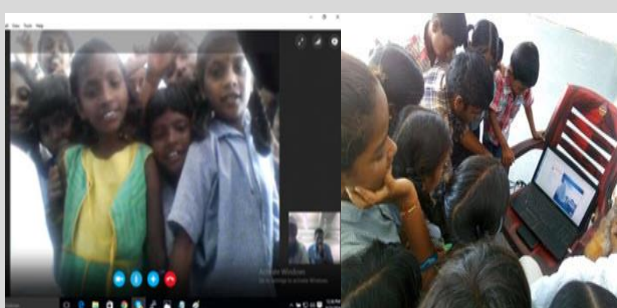

Medak, Telangana > IIT  
Hyderabad



Srikakulam > Andhra Pradesh  
ERNET

Many WhiteSpaces Pilots are under way in India. Large scale Pilots likely to happen this year – Assam, Telangana, Gujarat

# TV WhiteSpace Trials in India (Video – IITB)



# TV WhiteSpace Trials Around the World

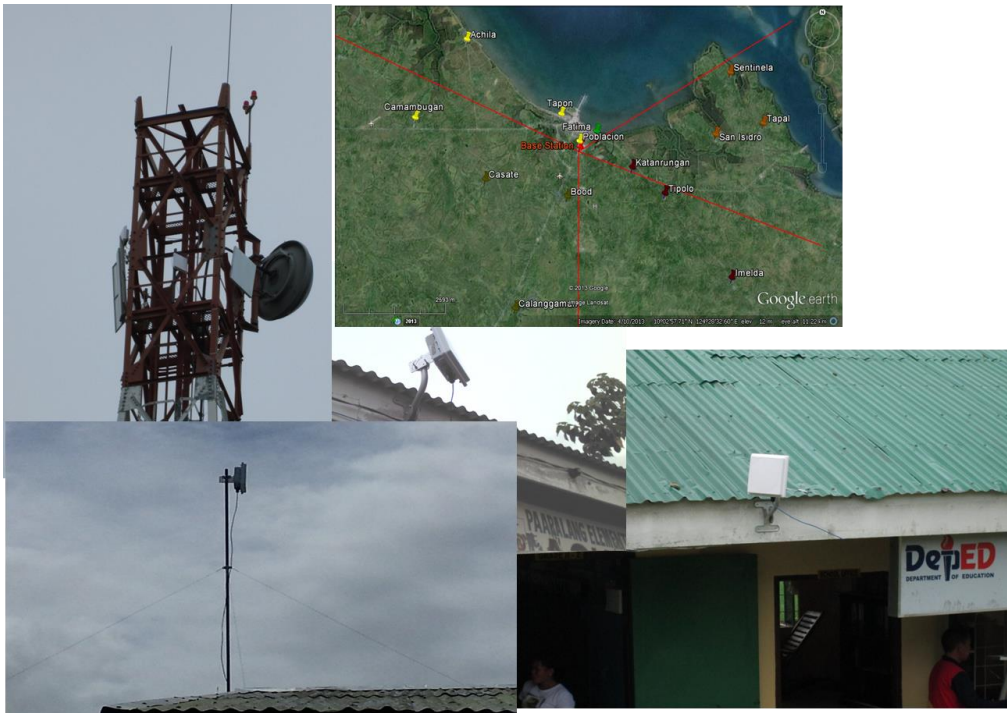

**Philippines.** Same network was re-used to establish connectivity after the Hurricane Haiyan



**Singapore:** Public Safety Network



# TV WhiteSpace Trials Around the World



IEEE  
802

## TV WhiteSpace Activities in Africa

# The UK: Challenges with Broadband Provisioning, and TVWS Opportunities

Many rural areas of the UK are still challenged in terms of broadband performance

- Right-top: Household broadband performance in Mbps for an area of the UK of approx. 90\*60 km
- Right-bottom: Number of (8 MHz) TV channels available for same area,  $\geq 1W$  allowed Tx EIRP, Tx antenna 30m above ground level
- **→ Rural broadband often  $<5$  Mbps; in much of this area could be provided over TV white space instead with over 100 MHz, even 150 MHz, b/w**

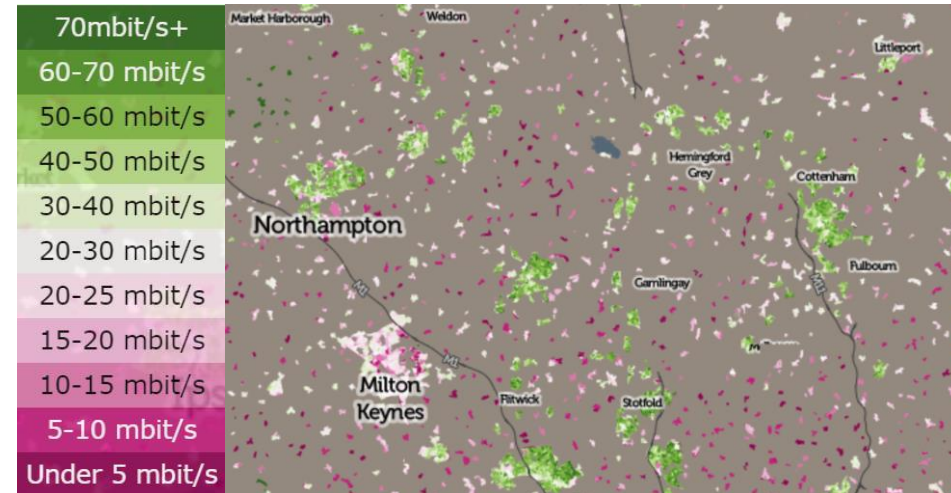

- |       |
|-------|
| 24-28 |
| 20-24 |
| 16-20 |
| 12-16 |
| 8-12  |
| 4-8   |
| 0-4   |

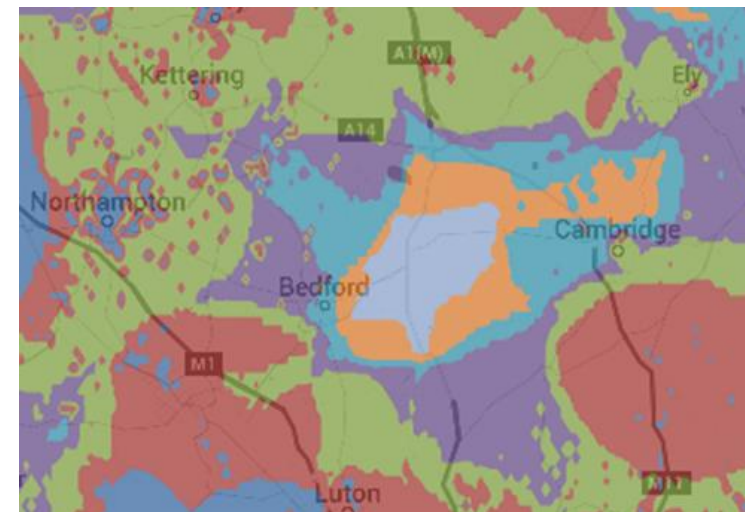

---

# TV WhiteSpaces Regulations at a Glance

# TV WhiteSpace Regulations and Trials Around the World

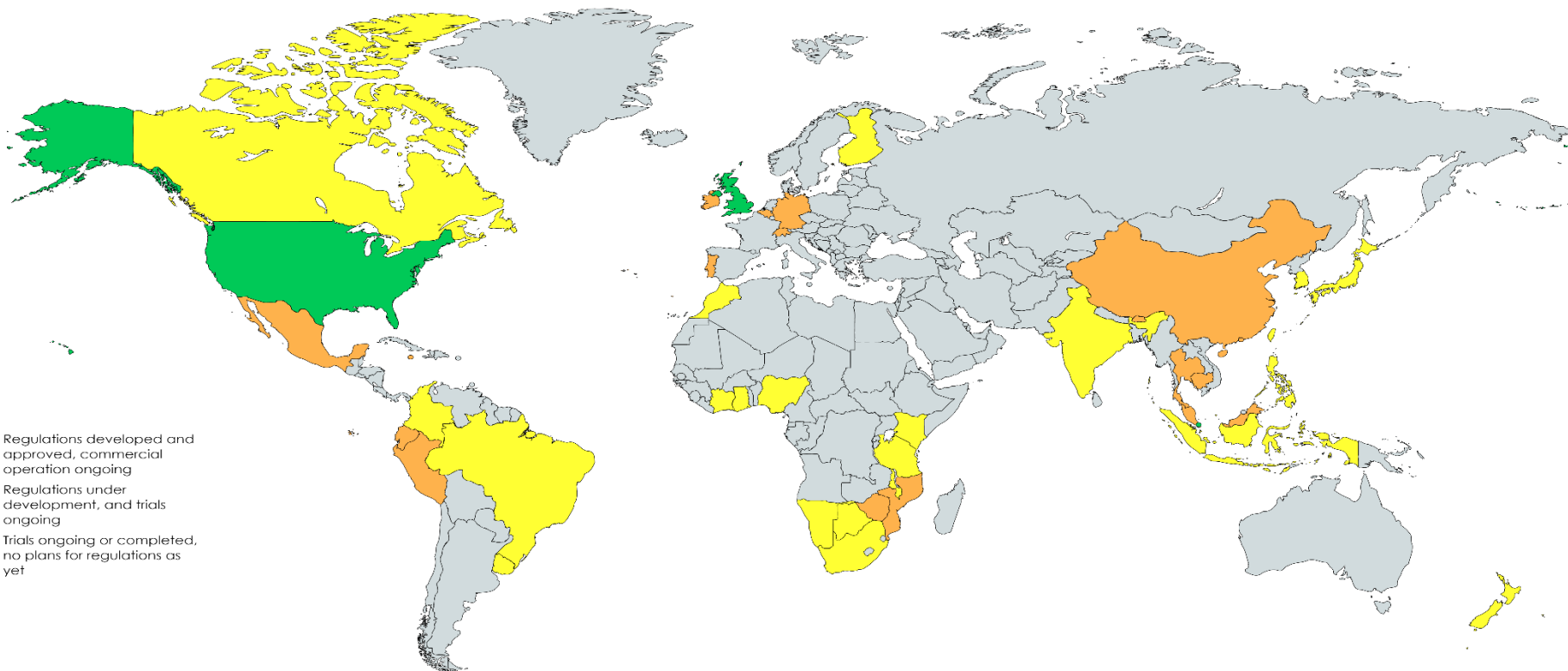

Created with mapchart.net ©

- Completed WhiteSpace Regulations
- On-going WhiteSpace Regulations
- Trials Conducted

# Regulation is different from standardization

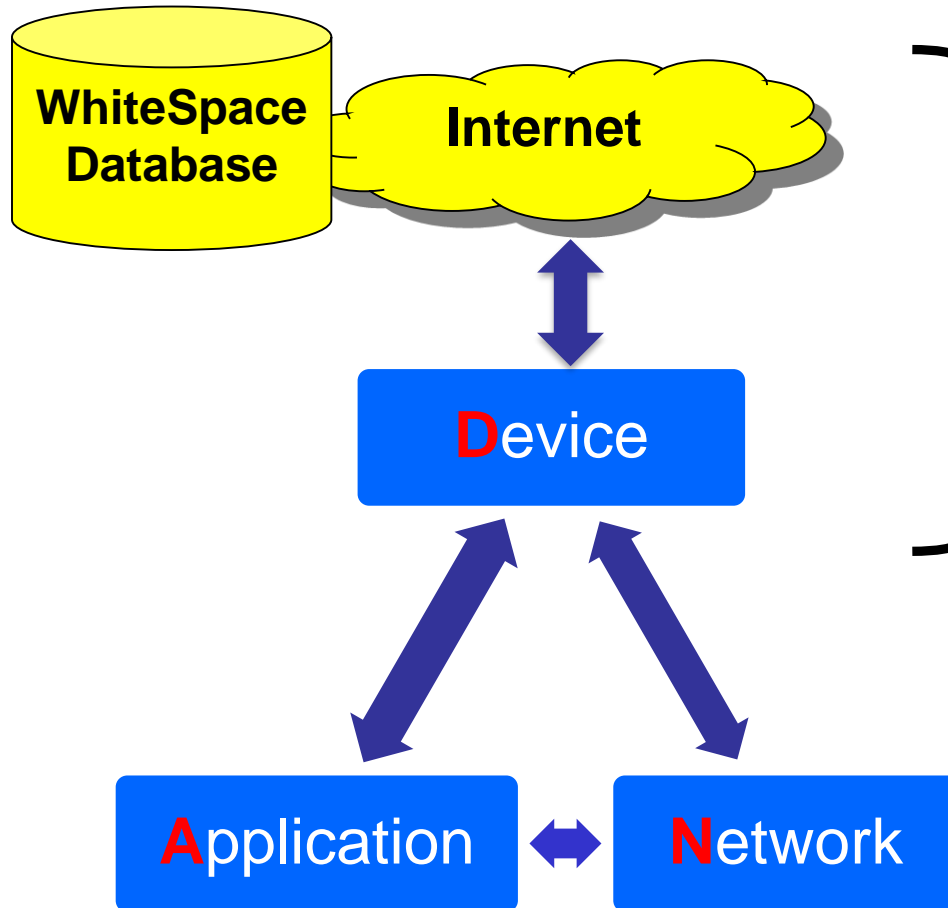

## Regulations

- Sets Limits of Operation to cause no interference to the Primary Services - e. g. TV Transmission

## Standardization

- Provides optimal and inter-operable protocols and devices to meet specific applications using the spectrum – e. g. LANs, RANs, Database Access

## Comparison of TVWS Frequency Range

FCC (MHz)	Canada (MHz)	Ofcom (MHz)	IDA (MHz)	RSM (MHz)
Fixed WSDs: 54-72, 76-88, 174-216.	Same as US	470-606, 614-790.	181-188, 209-223, 502-518, 614-622, 630-710, 718-742, 750-774, 790-806.	510-606.
Fixed & portable WSDs: 470-698.	54-72, 76-88, 174-216, 470-608, 614-698.			

- TVWS frequency range in North America and Singapore span from VHF to UHF while in Europe is only in UHF.
- Frequency range will affect the antenna size.

## Comparison of Available TVWS Spectrum

	Number of channels	Channel Bandwidth (MHz)	Total available TVWS spectrum (MHz)
<b>FCC</b>	50	6	300
<b>Canada</b>	49	6	294
<b>Ofcom</b>	39	8	256
<b>IDA (Singapore)</b>	24	7, 8	189
<b>RSM (NZ)</b>	12	8	96

- TVWS spectrum in Singapore exclude operating TV broadcast channels
- TVWS spectrum in New Zealand is only for trials

## Comparison of WSD Types

FCC	Canada	Ofcom	IDA	RSM
Fixed WSD, Mode I WSD, Mode II WSD, Sensing only WSD	Fixed WSD, Mode I WSD, Mode II WSD	Master WSD, Slave WSD	Fixed WSD, Mode I WSD, Mode II WSD	Fixed, Base station, Mobile

- Similar structure which consist of WSDs that have the ability to access WSDB and another type of WSDs that determine the available channels from other WSDs instead of WSDB
- Only FCC supports sensing-only WSDs



## Comparison of Power Limits - FCC

Type of WSD	EIRP (6MHz)	Conducted power limit (6 MHz)	PSD limit (100 kHz)	OOB limit (100 kHz)
<b>Fixed</b>	36dBm	30dBm (1W)	12.6dBm	-42.8dBm
	32dBm	26dBm (0.4W)	8.6dBm	-46.8dBm
	28dBm	22dBm (158mW)	4.6dBm	-50.8dBm
	24dBm	18dBm (63mW)	0.6dBm	-54.8dBm
	20dBm	14dBm (25mW)	-3.4dBm	-58.8dBm
	16dBm	10dBm (10mW)	-7.4dBm	-62.8dBm
<b>Personal/portable (adj. channel)</b>	16dBm	16dBm (40mW)	-1.4dBm	-56.8dBm
<b>Sensing only</b>	17dBm	17dBm (50mW)	-0.4dBm	-55.8dBm
<b>All other personal/portable</b>	20dBm	20dBm (0.1W)	2.6dBm	-52.8dBm

- Canada will initially harmonize with USA until further release of WSDs' details

## Comparison of Power Limits - IDA

Type of WSD	EIRP limit (8 MHz)	Adjacent channel limit (100 kHz)
<b>Fixed</b>	36dBm (4W)	-56.8dBm
<b>Mode I/II</b>	20dBm (0.1W)	-56.8dBm

- 2 channels adjacent to local DTV broadcast are blocked off
- No OOB if WSDs are operating in TV channels that are not adjacent to any TV broadcasting channels
- WSDs' signal power propagated to Malaysia's border will must be below -115dBm

# Comparison of Power Limits – ETSI & Ofcom

$$P_{OOB}(dBm/0.1MHz) < \max\{P_{IB}(dBm/8MHz) - AFLR(dB), -84\}$$

Where $P_{OOB}$ falls within the $n^{\text{th}}$ adjacent DTT channel	ACLR (dB)				
	Class 1	Class 2	Class 3	Class 4	Class 5
$n=\pm 1$	74	74	64	54	43
$n=\pm 2$	79	74	74	64	53
$n=\pm 3$	84	74	84	74	64

# WhiteSpace Database Requirements

	FCC	Ofcom (not exhaustive)	Singapore
<b>Min. WSDB output data</b>	Avail. TV channels	1) Start and end frequencies of available bands, 2) Maximum power levels 3) Maximum power spectral density levels 4) Time validity of data	Avail. TV channels
<b>WSD access freq.</b>	20 minutes	15 minutes	6 hours
<b>Default time validity of data</b>	1 hour	According to database response	6 hours
<b>Location accuracy</b>	50 meters	100 meters	50 meters
<b>Reserve channels for WSDs</b>	1	0	2

---

# Standards Supporting TV WhiteSpaces

# Standardization for TVWS

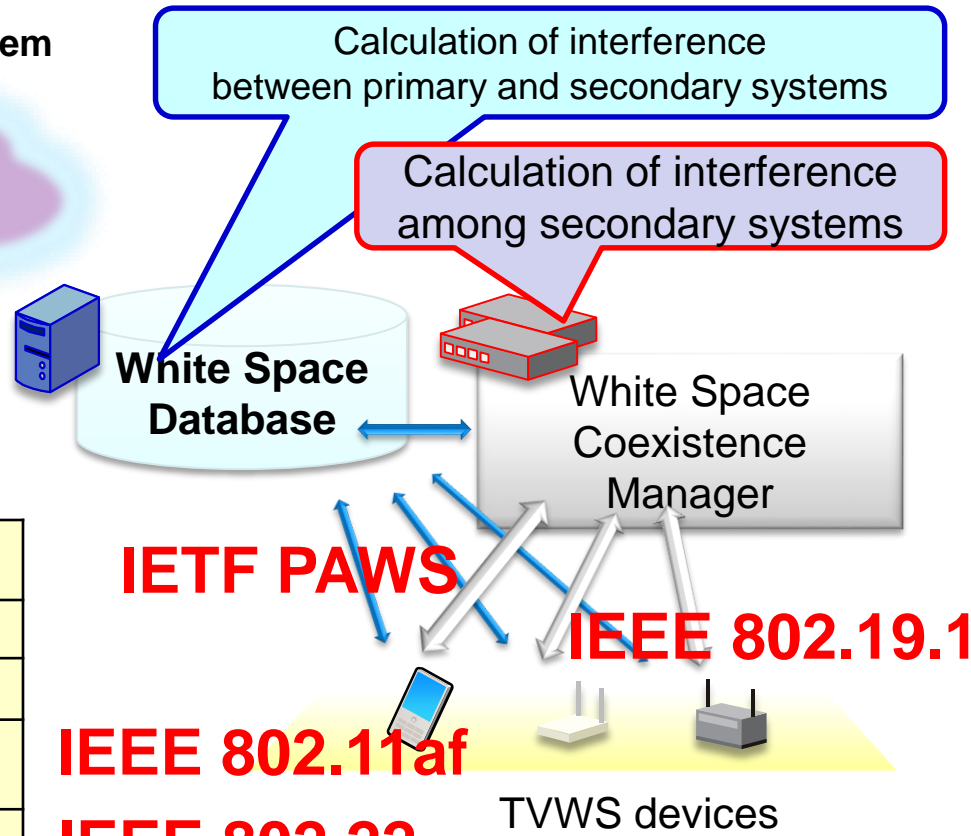
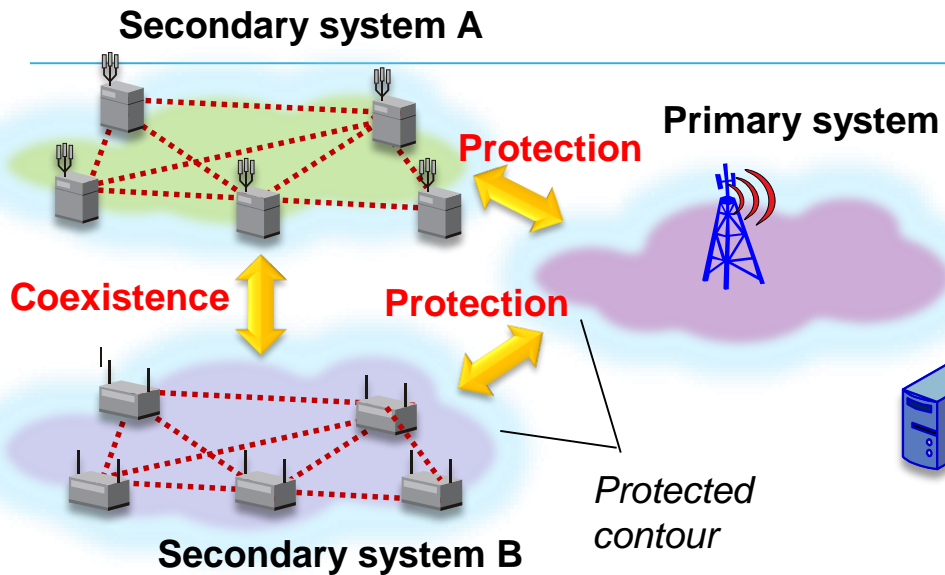

Standardization body	Working group
IEEE 802	802.22 (Wi-FAR)
	802.11af (Wi-Fi)
	802.15.4m (ZigBee, Wi-SUN)
	802.19.1 (Co-existence)
IEEE DySPAN Standards Committee	1900.7
	1900.4a
	1900.4.1

Source: NICT Presentation at the WhiteSpace Alliance, Global Summit on WhiteSpaces, New Delhi, 2015

---

# IEEE 802.11 AF Local Area Networks Standard

Rich Kennedy, [rich.kennedy@hpe.com](mailto:rich.kennedy@hpe.com)

## Abstract

As the Internet of Everything (IoE) becomes a reality, IEEE 802.11af strives to create a wireless world that enables Spectrum for Everything (SfE). This presentation will describe some of the unique advantages of 802.11af technology, and how it opens up huge opportunities for networks working in license-exempt spectrum.



# Introduction

- The technology of the devices
  - Drawing on the advances of IEEE 802.11ac
  - Range in the TV bands
- Geo-location database as an enabler
  - The database
  - The RLSS
- The Future

# IEEE 802.11af Radio Technology

- IEEE 802.11ac is designed to operate in the 5 GHz bands
  - Tremendous capacity gains
  - Up to 160 MHz channels for over 1 Gbps throughput
  - Able to operate in multiple, non-contiguous channels
- IEEE 802.11af uses the same leading-edge technology, and scales it down for smaller channels
  - Can operate in 6, 7 or 8 MHz channels or multiples of them to match the TV band allocations
  - At least 5x times range advantage over 11ac, maximizing data throughput over longer range micro-cells

# Channel Bandwidth Flexibility

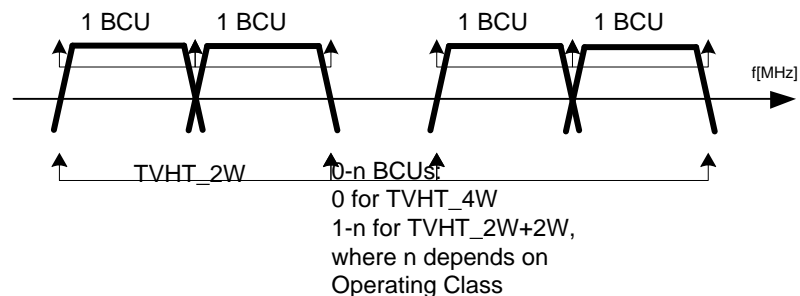
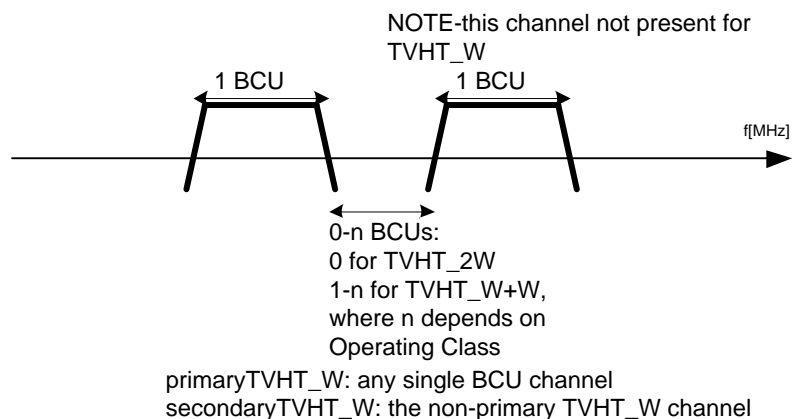

primaryTVHT\_W: any single BCU channel  
secondaryTVHT\_W: the non-primary TVHT\_W channel in the same TVHT\_2W channel group  
secondaryTVHT\_2W: the TVHT\_2W channel group that does not contain the primaryTVHT\_W

# Geo-location Databases

- Designed to maximize the use of under-utilized spectrum
  - For Experimental Licensed (like the US databases, where 24-hours is the standard of enablement)
  - For localized control (campuses, large enterprises, etc.)
- A Registered Location Secure Server can maintain the area knowledge and be the enabler for one or more small networks

# The RLSS

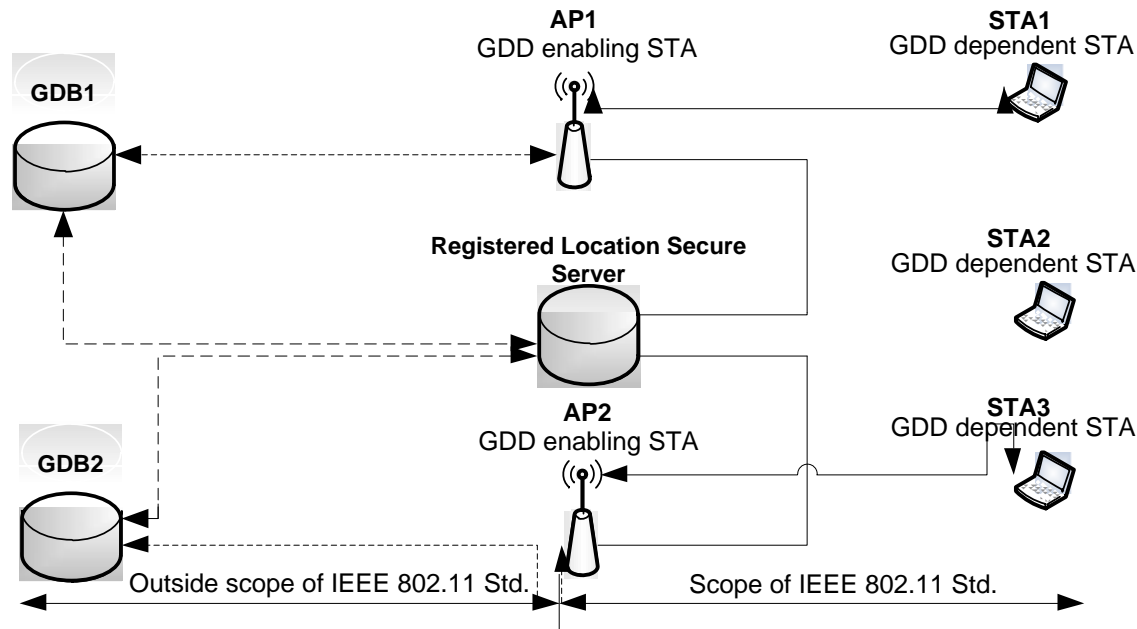

The RLSS provides the database function for multiple networks. It can access a regulatory database, or using centrally mounted antennas, provide available channel information based on sensing of the spectrum.

# Regulatory Flexibility

- Regulatory limits are set in Operating Classes
- Originally designed with the FCC in mind (because it had the only published rules at the time), the elements for operating in various regulatory domains gets coded into the Operating Classes
- As more regulatory domains specify their rules, it require only the specification of the appropriate classes, or creating new classes

# Some Future Examples

---

- In other bands, this technology can be used to provide interference-free spectrum access for special applications
  - For geo-survey satellite bands, it can secure the spectrum while a satellite is scanning a region, and share it when it is not, based on the highly predictable satellite path
  - For defense use of spectrum, eliminates the need to provide sensing data (like DFS) to maintain security of the satellite, UAV, etc.

## Reference Documents

- **US CFR47 Part 15 subpart H:**  
<http://www.ecfr.gov/cgi-bin/text-idx?c=ecfr&SID=9706a0746c793439e40007796de1f076&rgn=div5&view=text&node=47:1.0.1.1.16&idno=47#47:1.0.1.1.16.8>
- **ETSI BRAN EN 301 598 v1.1.1:**  
[http://www.etsi.org/deliver/etsi\\_en/301500\\_301599/301598/01.01.01\\_60/en\\_301598v010101p.pdf](http://www.etsi.org/deliver/etsi_en/301500_301599/301598/01.01.01_60/en_301598v010101p.pdf)
- **Ofcom (UK) Statement on approving TV white spaces; regulations:**  
[https://www.ofcom.org.uk/data/assets/pdf\\_file/0034/68668/tvws-statement.pdf](https://www.ofcom.org.uk/data/assets/pdf_file/0034/68668/tvws-statement.pdf), <http://www.legislation.gov.uk/ukxi/2015/2066/contents/made>



# 802.15.4m Wireless Personal Area Networks (PAN)s for TV WhiteSpaces

Clint Powell (PWC, LLC), [cpowell@ieee.org](mailto:cpowell@ieee.org)

# P802.15.4m

## □ Title

IEEE Standard for Local and Metropolitan Area Networks Part 15.4: Low Rate Wireless Personal Area Networks (LR-WPANs) Amendment 6: TV White Space Between 54 MHz and 862 MHz Physical Layer

## □ Abstract

In this amendment to IEEE Std. 802.15.4-2011, outdoor low-data-rate, wireless, TV White Space network requirements are addressed. Alternate PHYs are defined as well as only those MAC modifications needed to support their implementation.

# P802.15.4m

## □ Scope

This amendment specifies a physical layer for 802.15.4 meeting TV white space regulatory requirements in as many regulatory domains as practical and also any necessary Media Access Control (MAC) changes needed to support this physical layer. The amendment enables operation in the VHF/UHF TV broadcast bands between 54 MHz and 862 MHz, supporting typical data rates in the 40 kbits per second to 2000 kbits per second range, to realize optimal and power efficient device command and control applications.

## □ Purpose

The purpose of this amendment is to allow 802.15.4 wireless networks to take advantage of the TV white space spectrum for use in large scale device command and control applications.

# P802.15.4m

## □ Intro of Draft

This amendment specifies alternate PHYs in addition to those of IEEE Std 802.15.4-2011. In addition to the new PHYs, the amendment also defines those MAC modifications needed to support their implementation.

The alternate PHYs support principally outdoor, low-data-rate, wireless, TV White Space network (TVWS) applications under multiple regulatory domains. The TVWS PHYs are as follows:

- Frequency shift keying (TVWS-FSK) PHY
- Orthogonal frequency division multiplexing (TVWS-OFDM) PHY
- Narrow Band Orthogonal frequency division multiplexing (TVWS-NB-OFDM) PHY

The TVWS PHYs support multiple data rates in bands ranging from 54 MHz to 862 MHz.

# P802.15.4m

## □ PHY - Features

- **3 PHYs: multi-rate and multi-regional** - operating multiple over-the-air data rates in support of various applications in the TVWS
- Devices must support at least one of the 3 PHYs

PHY	Modulation	Data Rates
FSK	2 level FSK	50 or 100 or 200 or 300 kbps
	4 level FSK	400 kbps

**OR**

OFDM	BPSK	390.625 or 1562.5 kbps
	QPSK	781.250 or 3125 kbps
	16-QAM	1562.5 or 6250 kbps

**OR**

NB-OFDM	BPSK	156 or 234 kbps
	QAM	312 or 468 kbps
	16-QAM	624 or 936 kbps
	64-QAM	936 or 1404 or 1638 kbps

# P802.15.4m

## □ PHY - Features

- 17 Bands Currently Supported

Band	Band
TVWS Band USA	896-901 MHz
TVWS Band UK	901-902 MHz
TVWS Band Japan	902-928 MHz
TVWS Band Canada	917-923.5 MHz
TVWS Band Korea	928-960 MHz
450-470 MHz	920-928 MHz
470-510 MHz	950-958 MHz
779-787 MHz	2400-2483.5 MHz
863-870 MHz	<i>future expansion</i>

# P802.15.4m

## □ **MAC - Features**

- **TVWS multichannel cluster tree PAN (TMCTP) with a Super PAN coordinator (SPC)**

The SPC:

- Communicates with other PAN coordinators on their dedicated channels during the beacon only period (BOP)
- Provides access to geolocation database (GDB) server, providing TVWS channel availability information to all PAN coordinators in TMCTP
- Allocates use of a different channel for each PAN coordinator in TMCTP

# P802.15.4m

## □ MAC - Features

- **Direct device-to-device data transfer**

via. 4-modes:

- Probe-mode direct data transfer
- Polling-mode direct data transfer
- Broadcast-mode direct data transfer
- Multicast-mode direct data transfer

- **Low-energy mechanisms**

via. TVWS power saving (TVWSPS) Information Element (IE)

- TVWSPS IE is used to initiate a TVWSPS transaction and contains the: PS Control, Periodic Listening Interval, Periodic Listening Duration, Rendezvous Time, and Data Transaction Duration entities



# P802.15.4m

## □ MAC - Features

- **Location, GDB and channel access/usage** supported by use of multiple IE's:
  - TVWS device category IE
  - TVWS device identification IE
  - TVWS device location IE
  - TVWS channel information query request/response IE
  - TVWS channel information source description IE
  - Channel timing management IE
  - Channel list verification IE

# P802.15.4m

## □ MAC - Features

- **Transfer of ranging measurements between devices** supported by use of multiple IE's:
  - Ranging request IE
  - Ranging response IE
- **Ranging determination (to generate geo-location info)** support covered in informative annex:
  - FSK PHY - Use of symbol transition timing (STT)
  - OFDM PHYs - ToA estimation using conventional autocorrelation-based schemes

# P802.15.4m

## Depiction of Smart Utility Usage Model Utilizing TVWS\*

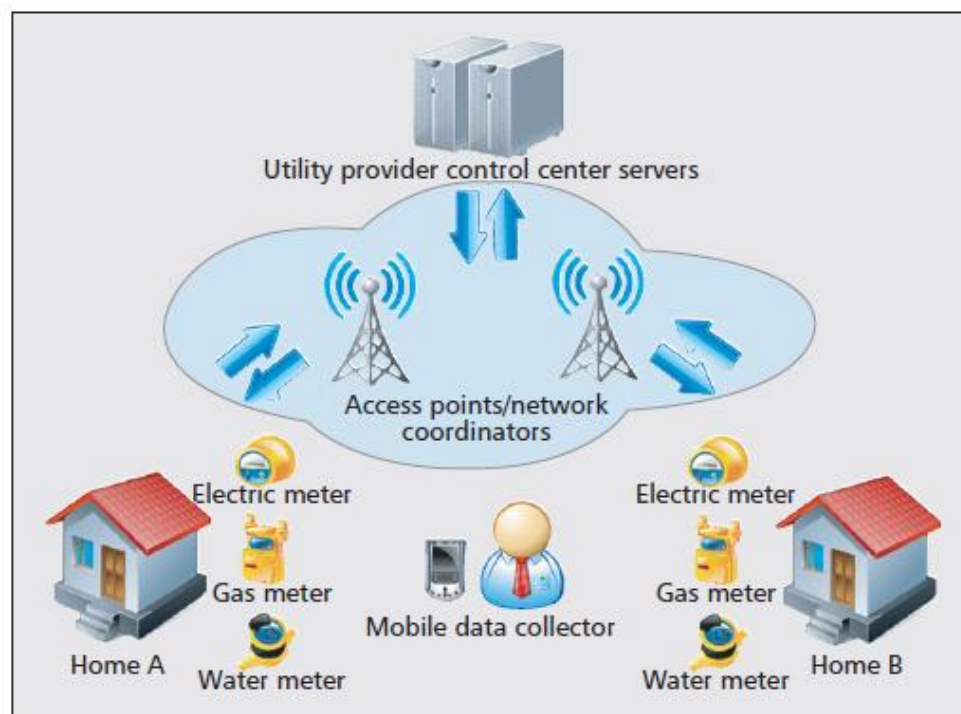

\*figure from “Cognitive Communication in TV White Spaces: An Overview of Regulations, Standards, and Technology”, IEEE Communications Magazine, July 2013.

# P802.15.4m - Summary

## □ P802.15.4m:

- Enables 802.15 low-rate WPAN technologies in the TVWS for targeted applications using low-power low complexity devices including sensors for smart grid/utility, and machine-to-machine networks
- Provides Multiple PHY, Multiple Data Rate, Multiple Region Capability
- Is well suited for large scale device command and control applications, such as Smart Utility and Field Area Sensor Networks

---

# IEEE 802.19.1 Standard for TV WhiteSpace Co-existence

Steve Shellhammer, [sshellha@qti.qualcomm.com](mailto:sshellha@qti.qualcomm.com)

# IEEE 802.19.1-2014

---

- **Scope of the project:** The standard specifies radio technology independent methods for coexistence among dissimilar or independently operated TV Band Device (TVBD) networks and dissimilar TV Band Devices.
- The purpose of the standard is to enable the family of IEEE 802 Wireless Standards to most effectively use TV White Space by providing standard coexistence methods among dissimilar or independently operated TVBD networks and dissimilar TVBDs. This standard addresses coexistence for IEEE 802 networks and devices and will also be useful for non IEEE 802 networks and TVBDs.

# IEEE P802.19.1a

---

- **Scope of the project:** This amendment to IEEE 802.19.1-2014 defines the network-based coexistence information exchange among networks and devices to enable network-based coexistence management. It specifies procedures and protocols for collection and exchanging coexistence information of heterogeneous networks, spectrum resource measurements and network performance metrics, such as packet error ratio, delay, etc, and information elements and data structures to capture coexistence information.
- The purpose of the standard is to enable the family of IEEE 802 Wireless Standards to most effectively use, under general authorization, frequency bands such as TV band White Spaces, the 5GHz license-exempt bands and the general authorized access in 3.5GHz bands by providing standard network-based coexistence methods among dissimilar or independently operated networks of unlicensed devices and dissimilar unlicensed devices with geo-location capability. This standard addresses coexistence for IEEE 802 networks and devices and will also be useful for non IEEE 802 networks and devices.



# Architecture

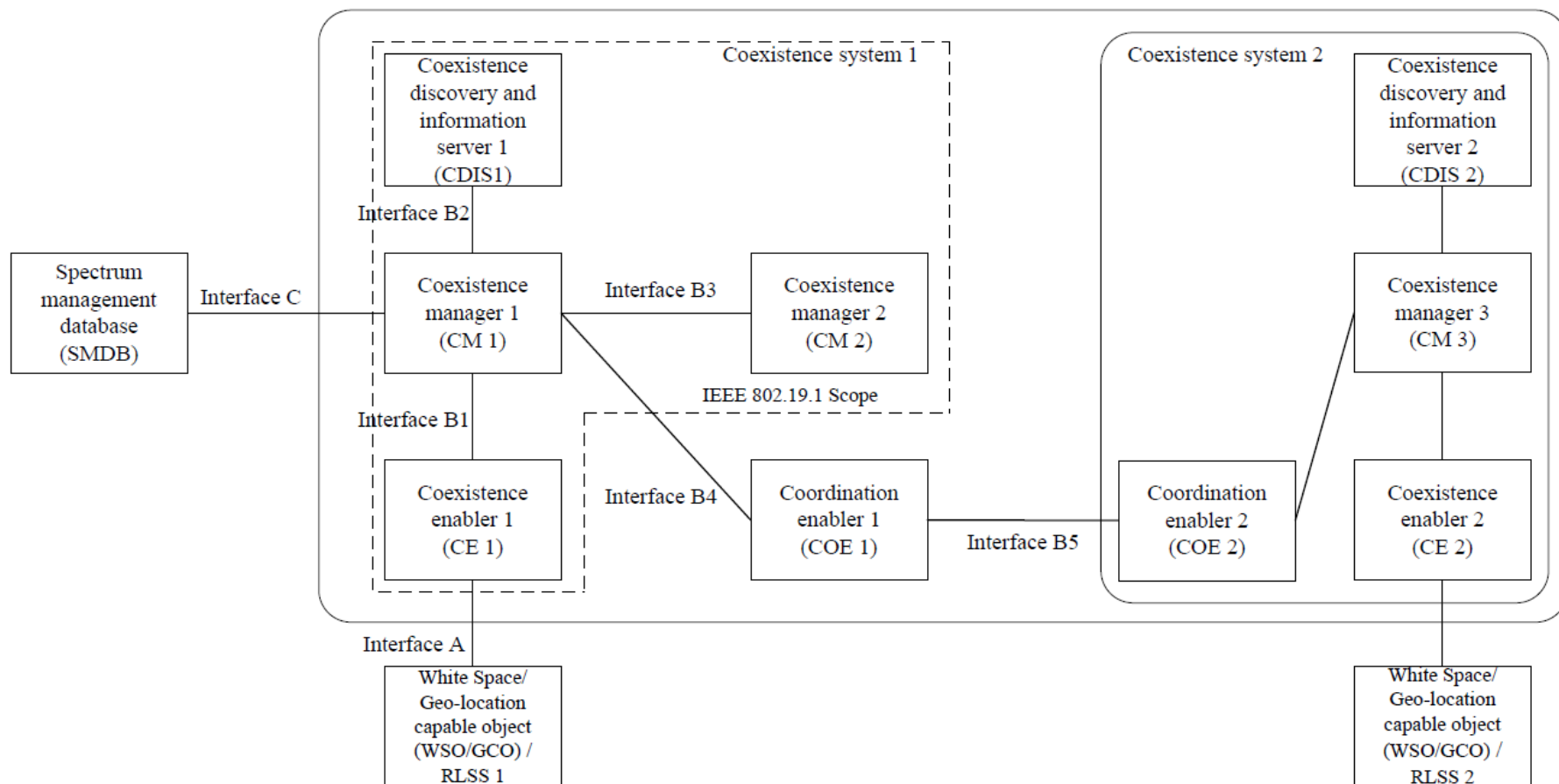



# Logical entities and their functions

---

- The Coexistence Discovery and Information Server (CDIS) provides coexistence discovery service to the Coexistence Managers (CMs) it serves. Within this service the CDIS informs the CMs about potential neighbors of the White Space/Geo-location Capable Objects (WSOs/GCOs) served by these CMs. WSO is under an umbrella of GCO.
- The CM provides either information or management service to the WSO/GCOs it serves. Communication between the CM and the WSO/GCOs is performed via their Coexistence Enablers.
  - Information service provides information about its potential neighbors including their operating frequencies, potential interference levels etc
  - management service the CM provides the WSO/GCO reconfiguration requests that create such configuration of this WSO/GCO that its operation is improved according to some criteria.
- The Coexistence Enabler (CE) is an interface element that represents one or several WSO/GCOs of the same type in the coexistence system.
- The coordination enabler (COE) is an interface element that represents one or more CMs to communicate with the other COE in another independent coexistence system.

# Application example

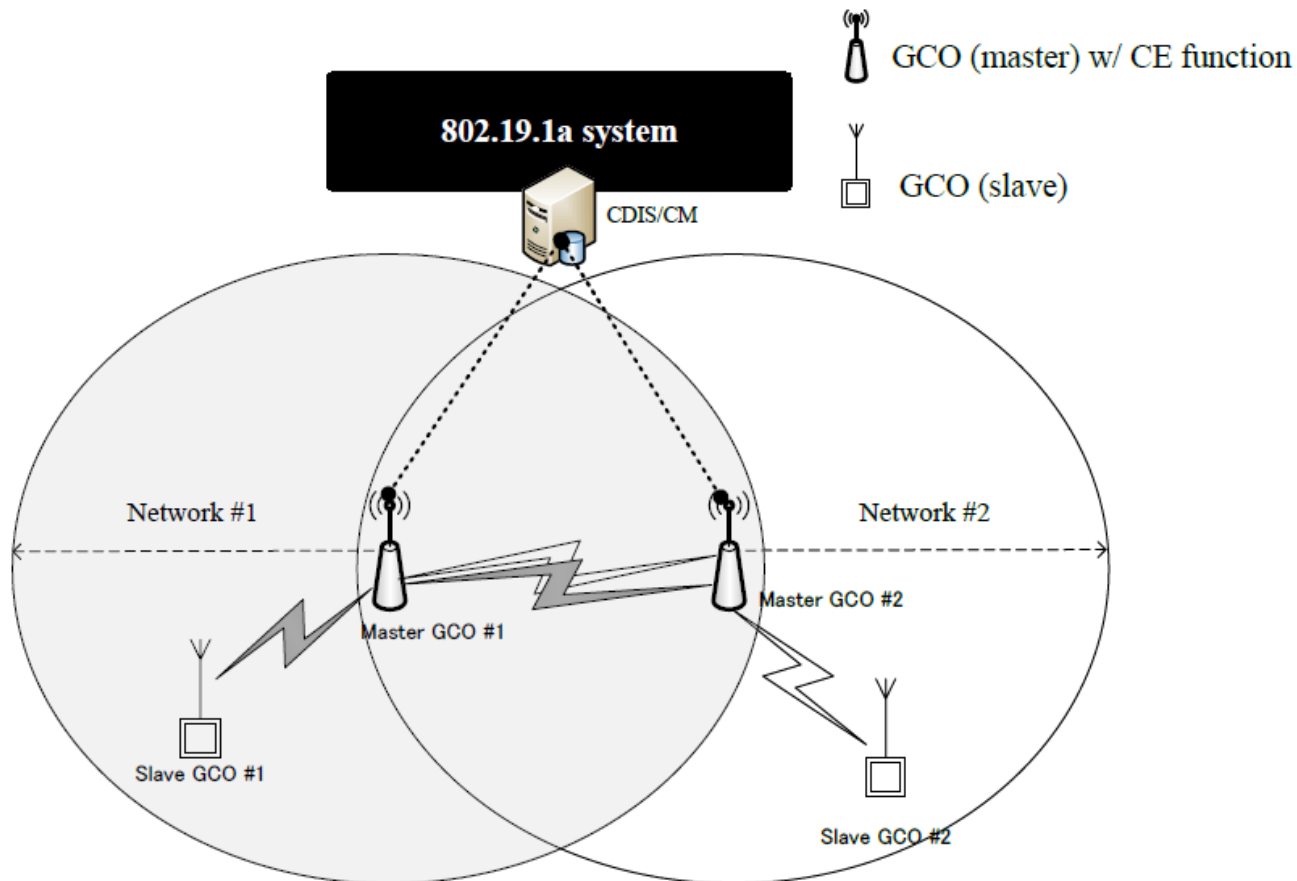

---

# IEEE 802.22 WG on Cognitive Radio Based Wireless Regional Area Networks

Apurva N. Mody, Ph. D., [apurva.mody@ieee.org](mailto:apurva.mody@ieee.org)

# IEEE 802.22 WG on Cognitive Radio Based Wireless Regional Area Networks

**IEEE 802.22 WG is the recipient of the IEEE SA Emerging Technology Award**



**Approved as an ISO Standard**

**IEEE 802.22 Standard – Wireless Regional Area Networks: Cognitive Radio based Access in TVWS:  
Published in July 2011**

**P802.22 – Revision (On Going)**



**IEEE SA awards ceremony**



**802.22.1 – Std for Enhanced Interference Protection using beaconing:  
Published in Nov. 2010**



**802.22.2 – Std for Recommended Practice for Deployment of 802.22 Systems:  
Expected completion - Dec 2012**



**802.22a – Enhanced Management Information Base and Management Plane Procedures:  
Expected Completion - Dec. 2013**



**802.22b Enhancement for Broadband Services and Monitoring Applications**

**802.22.3 Spectrum Characterization and Occupancy Sensing (On Going)**

**IEEE  
802**

**[www.ieee802.org/22](http://www.ieee802.org/22)**

# IEEE 802.22 (Wi-FAR™) – Cognitive Radio Capability

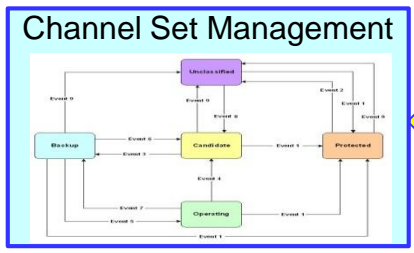

**Subscriber Station Registration and Tracking**

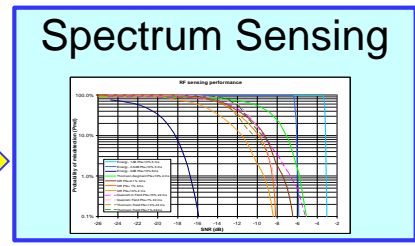
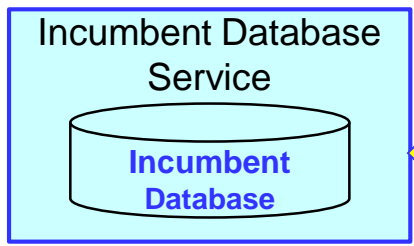
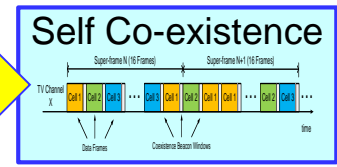
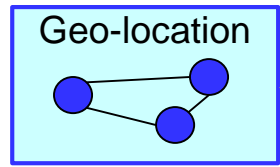
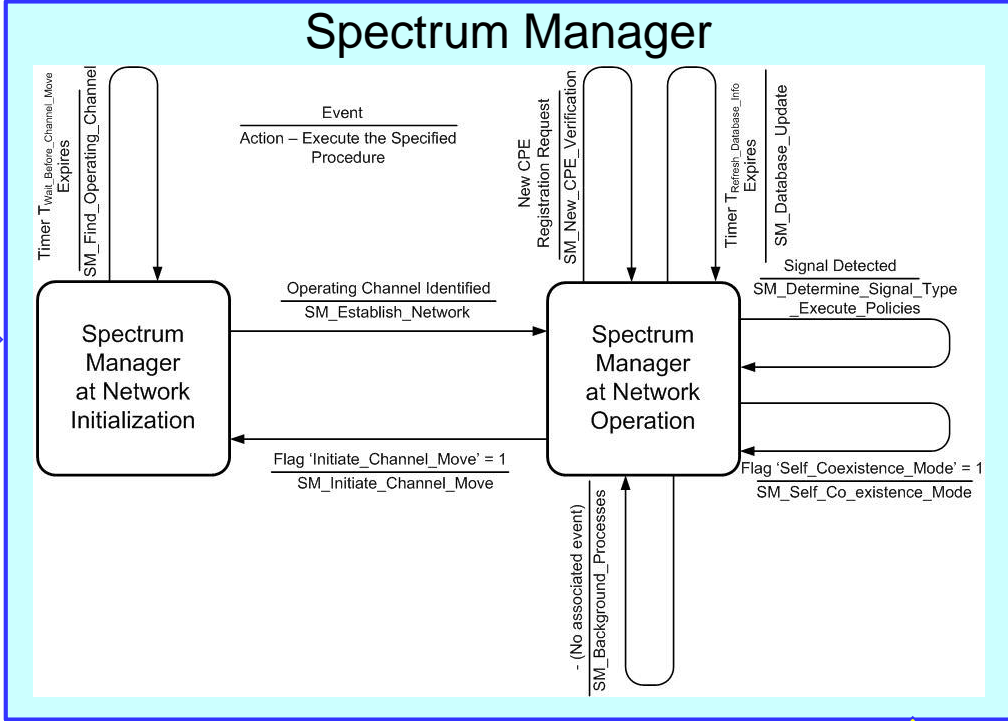
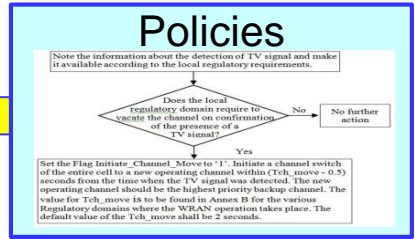

# TV Channel Modeling – IEEE 802.22 (Wi-FAR™ supports large multi-path delay absorption

- Long distance communication in the VHF/ UHF Band needs to deal with severe multipath and delay spread conditions
- Frequency selective with large excessive delay
  - Excessive delay (measurements in US, Germany, France\*)
    - **Longest delay: >60  $\mu$ sec**
    - **85% test location with delay spread  $\sim$ 35  $\mu$ sec**
  - Low frequency (54~862 MHz)
  - Long range (up to 100 km)
  - Slow fading
    - Small Doppler spread
    - (up to a few Hz)

\* WRAN Channel Modeling,  
IEEE802.22-05/0055r7, Aug 05  
Information provided by TV  
Broadcasters

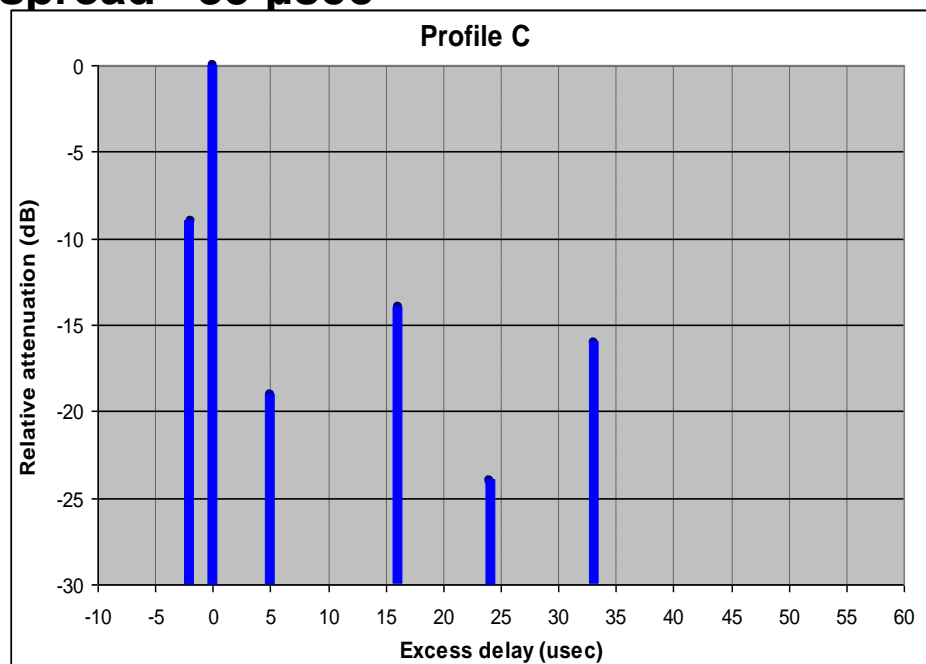

# IEEE 802.22 (Wi-FAR™) – Frame Structure

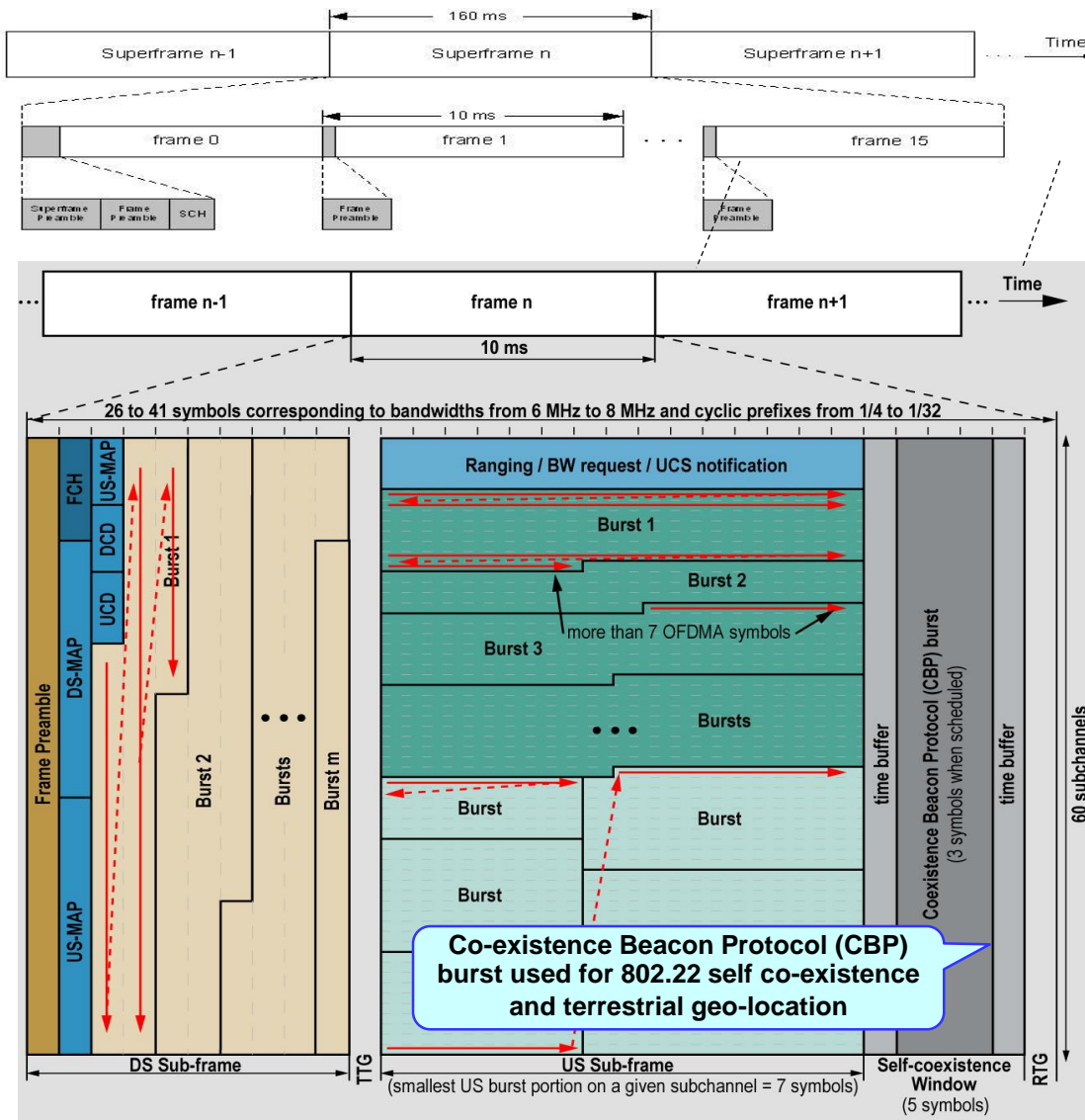

- Time Division Duplex (TDD) frame structure Super-frame: 160 ms, Frame: 10 ms
- OFDM/ OFDMA Transport
- QPSK up to 64 QAM modulation supported
- Convolutional codes and other advanced codes supported
- Throughput: 22-29 Mbps per TV channel WITH NO MIMO. MIMO and channel bonding increase the throughput
- Spectral Efficiency: 0.624 – 3.12 bits / sec / Hz
- Distance: 10 km minimum. Upto 30 km and even 100 kms
- MAC supports Cognitive Radio features
- Self-coexistence Window (SCW): BS commands subscribers to send out CBPs for 802.22

**IEEE 802.22 prototypes are being announced**



# IEEE 802.22 Trials, Tono City, Japan



This experiment was conducted jointly with Hitachi Kokusai Electric.

802



# IEEE 802.22 Trials and Applicability to India

IEEE 802.22 Device - Source: Saankhya Labs [www.saankhyalabs.com](http://www.saankhyalabs.com)



Image credit: IIM-Bangalore, Opel consulting



Number of Blocks (National Optical Fiber Network - NOFN Phase-I)	6,382
Number of Village Heads (Gram Panchayat) (NOFN Phase I/II)	2,50,000
Number of Villages	6,38,619
Avg. number of Gram Panchayats per block	40
Avg. number of Villages per Gram Panchayat	2.56
Avg. number of Hamlets per Village	4

Source: Saankhya Labs

# IEEE 802.22 Base Stations and Customer Premises Equipment

- Implementation of the IEEE 802.22  
Devices under way



- Highlights
  - Non-Line of Sight connectivity
  - Point-to-Point & Point to Multi-point topology
  - TDD (Time Division Duplex) or FDD (Frequency Division Duplex) modes
  - Encryption and authentication

- Features

- Long range up to 30 Km
- Frequency band: 300MHz to 700 MHz
- Configurable bandwidth: 6, 7, 8MHz
- Modulation Scheme:: OFDMA with coding support from BPSK, QPSK, 16-QAM & 64-QAM with configurable code rate
- Max link rate: 30Mbps per 8-MHz channel
- Receiver sensitivity: -98dBm for QPSK
- RF Power: Upto 30dBm conducted power
- Adjacent & alternate channel blocker immunity
- Integrated PoE

## IEEE 802.22 (Wi-FAR™) Features

- *First* IEEE Standard that is specifically designed for rural and regional area broadband access aimed at removing the digital divide
- *First* IEEE Standard that has all the Cognitive Radio features
- IEEE 802.22 (Wi-FAR™) provides Broadband Wireless Access to Regional, Rural and Remote Areas Under Line of Sight (LoS) and Non Line of Sight (NLoS) Conditions using Cognitive Radio Technology (*without causing harmful interference to the incumbents*).
- Cognitive Radio technology added to a simple and optimized OFDMA waveform (similar to the OFDMA technology used in other broadband standards)
- Each IEEE 802.22 (Wi-FAR™) cell can provide 22 to 29 Mbps per TV Channel and provide support for 512 devices at distances of 30 km
  - New Amendment adds Channel Bonding and MIMO – Allows Greater than 200 Mbps

---

# Future – Spectrum Sharing and Spectrum Super Highways

# United States Tomorrow: shared-use Spectrum Superhighways



PCAST recommends the President issue a new memorandum that:

- states the *policy of the U.S. government is to share underutilized Federal spectrum*; and
- identifies immediately 1,000 MHz of Federal spectrum for sharing with the private sector; and

**National Spectrum Consortium Formed:**

- [www.nationalspectrumconsortium.org](http://www.nationalspectrumconsortium.org)
- Takes approx. 10% proceeds of the spectrum auctions and re-invests into Spectrum Access Research and Development (SARDP)

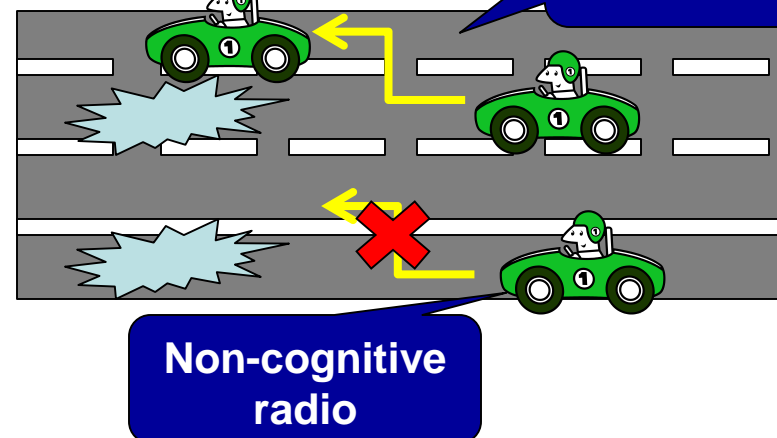

# Shared Spectrum Superhighways Relevant Internationally!

For example (one among many), the CEPT Electronic Communications Committee ECC (entity that acts as/forms the common position among EU regulators) has issued a strategic plan for wireless communications in 2015-2020:

<https://cept.org/files/18334/ECC%20Strategic%20Plan%202015-2020%20web-ready.pdf>

- Identifies *spectrum sharing*, receiver characteristics (i.e., not just transmitter), and use of higher frequencies as means to address spectrum challenges in the duration 2015-2020
- Specifically (re. spectrum sharing),
  - *“The ECC should continue to define conditions to support the concept of spectrum sharing in both unlicensed and licensed spectrum in order to meet the need for more sophisticated sharing, without prejudice to the need for protection from interference from other services or applications, whether in the same band or in adjacent bands.”*

# References

- IEEE 802.22 Working Group Website – [www.ieee802.org/22](http://www.ieee802.org/22), IEEE Std. 802.22-2011
- IEEE 802.11 Working Group Website – [www.ieee802.org/11](http://www.ieee802.org/11)
- IEEE 802.15 Working Group Website – [www.ieee802.org/15](http://www.ieee802.org/15)
- IEEE 802.19 Working Group Website – [www.ieee802.org/19](http://www.ieee802.org/19)
- IETF PAWS Website - <https://datatracker.ietf.org/wg/paws/documents/>
- Apurva Mody, Gerald Chouinard, “Overview of the IEEE 802.22 Standard on Wireless Regional Area Networks (WRAN) and Core Technologies”  
<http://www.ieee802.org/22/Technology/22-10-0073-03-0000-802-22-overview-and-core-technologies.pdf>
- PCAST Report – Report to the President – Realizing Full Potential of the Govt. held Spectrum to Spur Economic Growth  
[http://www.whitehouse.gov/sites/default/files/microsites/ostp/pcast\\_spectrum\\_report\\_final\\_july\\_20\\_2012.pdf](http://www.whitehouse.gov/sites/default/files/microsites/ostp/pcast_spectrum_report_final_july_20_2012.pdf)
- Richard Thanki, [Economic Significance of License-exempt Spectrum](#).
- WhiteSpace Alliance – [www.WhiteSpaceAlliance.org](http://www.WhiteSpaceAlliance.org)
- Dynamic Spectrum Alliance – [www.DynamicSpectrumAlliance.org](http://www.DynamicSpectrumAlliance.org)
- United States Federal Communications Commission – [www.fcc.gov](http://www.fcc.gov)
- United Kingdom Office of Communications (OfCom) - [www.ofcom.org.uk](http://www.ofcom.org.uk)