

LTE-U Forum and Coexistence Overview

Date: 2015-07-14

Authors:

Name	Affiliations	Address	Phone	email
Jingyi Zhou	Verizon	One Verizon Way Basking Ridge NJ 07920	+1-908-559- 7244	Jingyi.Zhou@Verizon.com
Mingxi Fan	Qualcomm	5775 Morehouse Drive, San Diego, CA 92130	+1-858-845- 3609	mfan@qti.qualcomm.com

Notice: This document has been prepared to assist IEEE 802.19. It is offered as a basis for discussion and is not binding on the contributing individual(s) or organization(s). The material in this document is subject to change in form and content after further study. The contributor(s) reserve(s) the right to add, amend or withdraw material contained herein.

Abstract

- **This presentation provides an overview of LTE-U forum documents and key mechanisms to coexist with WiFi in unlicensed band. Associated lab and field test cases and results are included.**

Objectives and Background

- **LTE-U Forum Objectives**
 - Develop a set of specifications for LTE-U products based on 3GPP Release 10 and beyond published specs
- **Scope**
 - LTE operation in the 5GHz U-NII-1 and U-NII-3 bands as Supplemental Downlink (SDL) carriers, aggregated with an LTE deployment in licensed bands.
 - Targeted for the US in full compliance with FCC regulations
 - Ensure proper validation of fair-sharing coexistence between LTE-U and Wi-Fi as well as between LTE-U operators with the coexistence spec
- **Forum was formed by industry members with both LTE and Wi-Fi expertise**
 - ALU; Ericsson; LGE; Qualcomm Technologies Inc.; Samsung; Verizon

LTE-U Forum Documents

- **Completed LTE-U Forum Documents**
 - LTE-U Technical Report V1.0
 - LTE-U SDL Coexistence Specifications (V1.0)
 - UE Minimum Requirements for LTE-U SDL V1.0
 - UE Conformance Test Specifications for LTE-U SDL V1.0
 - eNB Minimum Requirements for LTE-U SDL V1.0
 - eNB Conformance Test Specifications for LTE-U SDL V1.0
- **LTE-U Forum Documents are available at:**
 - <http://www.lteuforum.org/>
- **LTE-U Workshop Documents (May 28th 2015, San Diego, CA)**
 - <http://www.lteuforum.org/workshop.html>

Summary of Coexistence Test Scenarios

Test#	#Channels	Coexisting Nodes	Objectives	LTE-U Duty Cycle *
6.1.1	2	LTE-U / Wi-Fi	LTE-U selects clean channel over Wi-Fi occupied channel	NA
6.1.2	2	LTE-U / LTE-U / LTE-U (same + different operators)	LTE-U selects LTE-U occupied channel from the same operator over channel used by another LTE-U operator	NA
6.2.1	1	LTE-U / Wi-Fi	Channel sharing w/ one full-buffer Wi-Fi link above CCA-ED limit	$\leq 50\%$
6.2.2	1	LTE-U / Wi-Fi / Wi-Fi	Channel sharing w/ two full-buffer Wi-Fi links above CCA-ED limit	$\leq 33\%$
6.2.4	1	LTE-U/ Wi-Fi / Wi-Fi	Channel sharing w/ two uplink full-buffer Wi-Fi links above CCA-ED	$\leq 33\%$
6.2.5	1	LTE-U / Wi-Fi	Channel sharing w/ one Wi-Fi AP (mixed full-buffer and VoIP links) above CCA-ED limit	VoIP over Wi-Fi metrics
6.2.6	1	LTE-U / LTE-U / Wi-Fi (different operators)	Channel sharing w/ Wi-Fi and another LTE-U operator	$\leq 33\%$ (per LTE-U small cell)
6.2.7	1	LTE-U / LTE-U (same operator)	Channel sharing w/ same operator LTE-U with higher channel reuse	between 80% and 100%
6.3.1	1	LTE-U single link	Opportunistic SCell switch OFF	NA

Test cases in **blue** are newly added in Release 1.1

* In addition to the duty cycle (percentage of medium occupancy) requirements for LTE-U, there is also a limit on the maximum continuous transmission by LTE-U nodes to 50 msec

** : -62dBm is the CCA-ED (Energy Detection) threshold, -82dBm is the CCA-CS (Carrier Sense) threshold

LTE-U Technology Overview Outline

- **Overview of LTE-U coexistence algorithms design**
 - Channel selection, CSAT and OSDL
 - How to coexist with Wi-Fi BSSs within and outside CCA-ED
- **Lab & OTA results for coexistence above and below CCA-ED**
 - Different traffic applications (best effort, video, VoIP)
 - Wi-Fi/Wi-Fi, Wi-Fi/LTE-U fairness study

Introduction

- **Coexistence and fair sharing is a key principle in LTE-U design and testing**
 - Extensive study with different applications, devices, and deployment models
- **WiFi is the key reference technology for fair-sharing study, with and beyond spec**
 - 802.11 spec reference is used for simulation evaluation
 - Lab and OTA testing with multiple commercial WiFi AP and devices to account for different implementations, including performance benchmarking
- **Scope of presentation is based Qualcomm design in accordance with LTE-U Forum spec**
 - The spec provides guidelines and testing scenarios but doesn't dictate specific implementations
- **The design and results covers a larger set of scenarios than those mandated by LTE-U forum specifications**

LTE-U Coexistence Solutions State Diagram

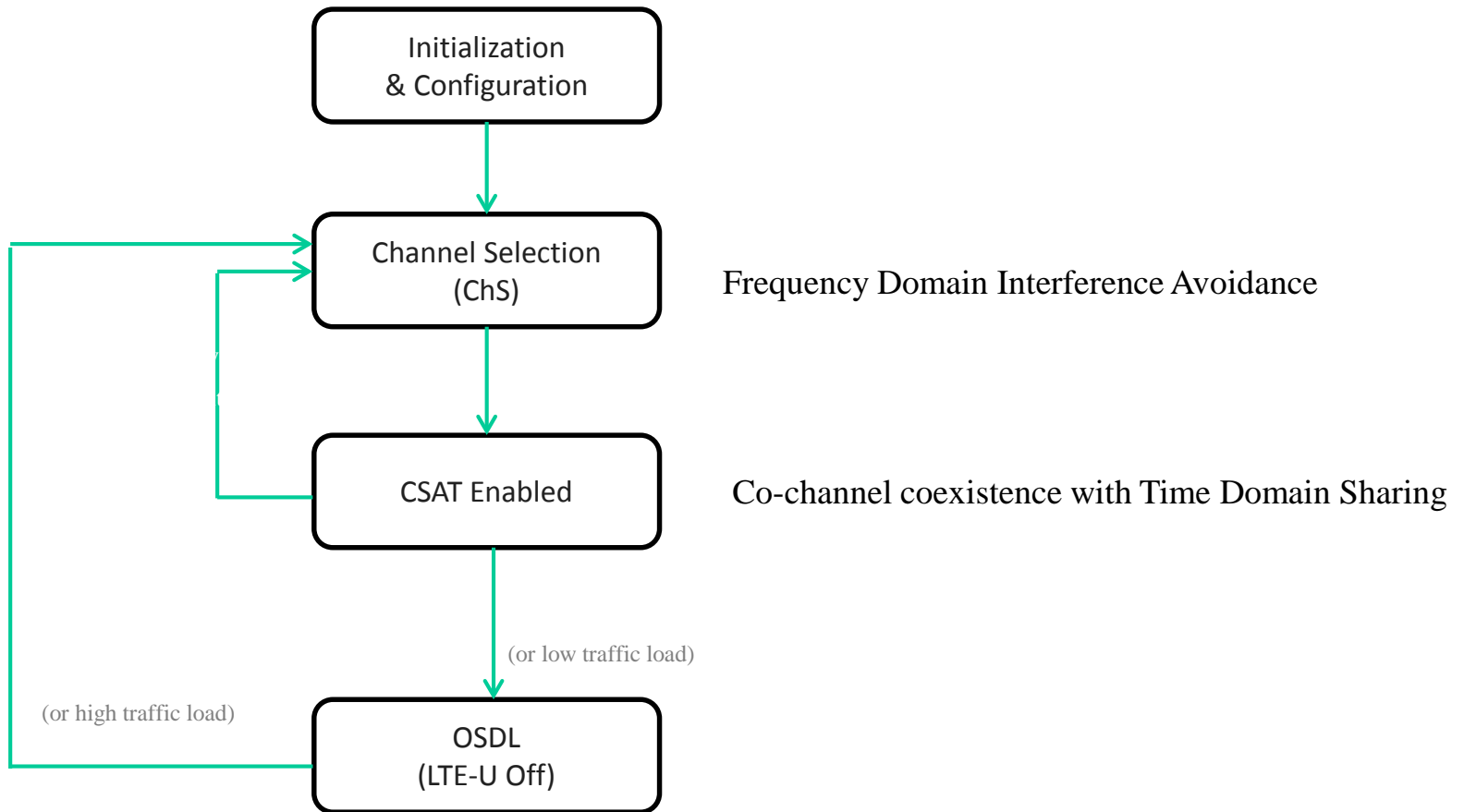

Channel Selection

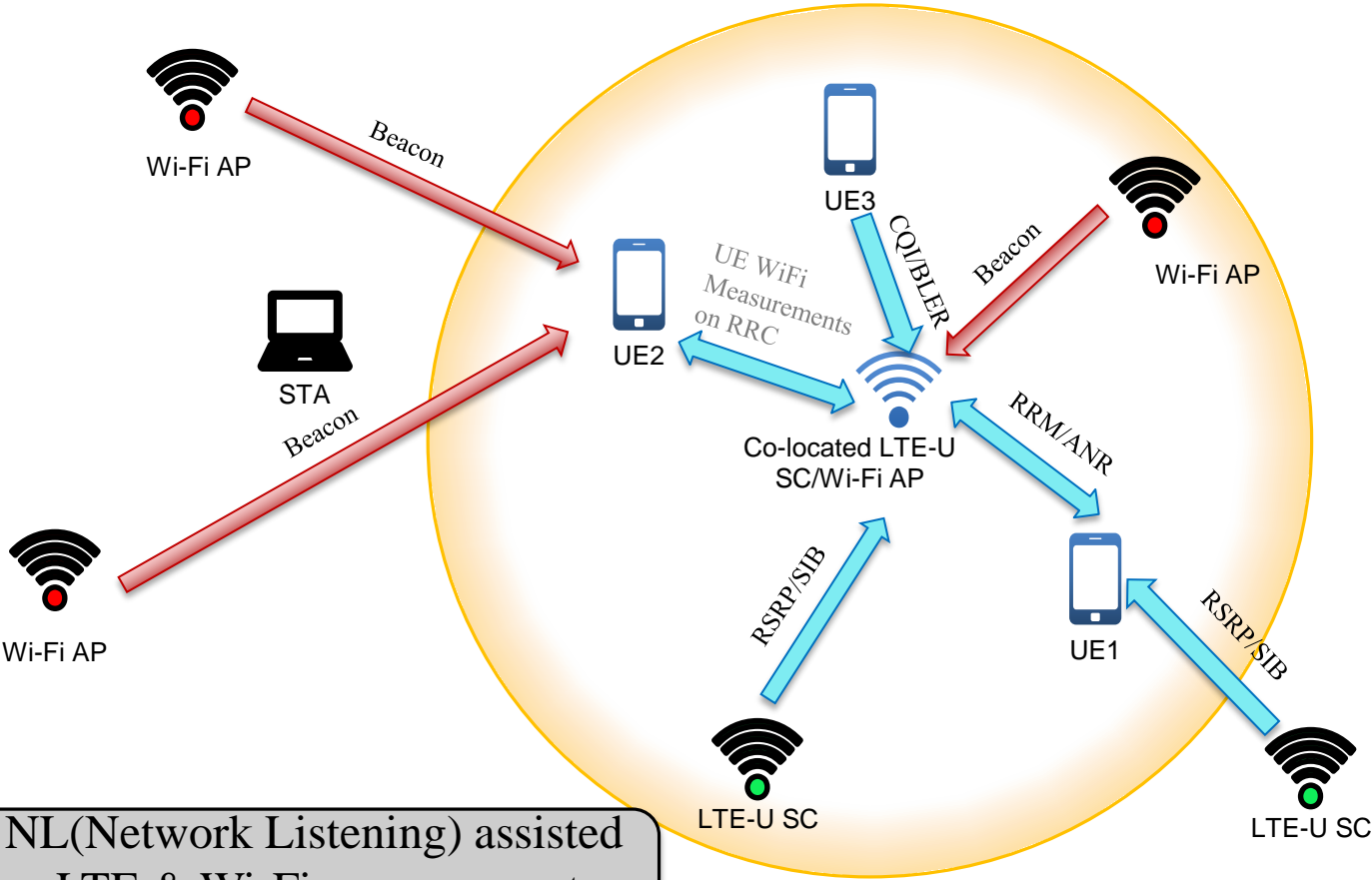

LTE-U and Wi-Fi NL(Network Listening) assisted with UE reporting LTE & Wi-Fi measurements and CQI/BLER to detect hidden nodes

Channel Penalty Function

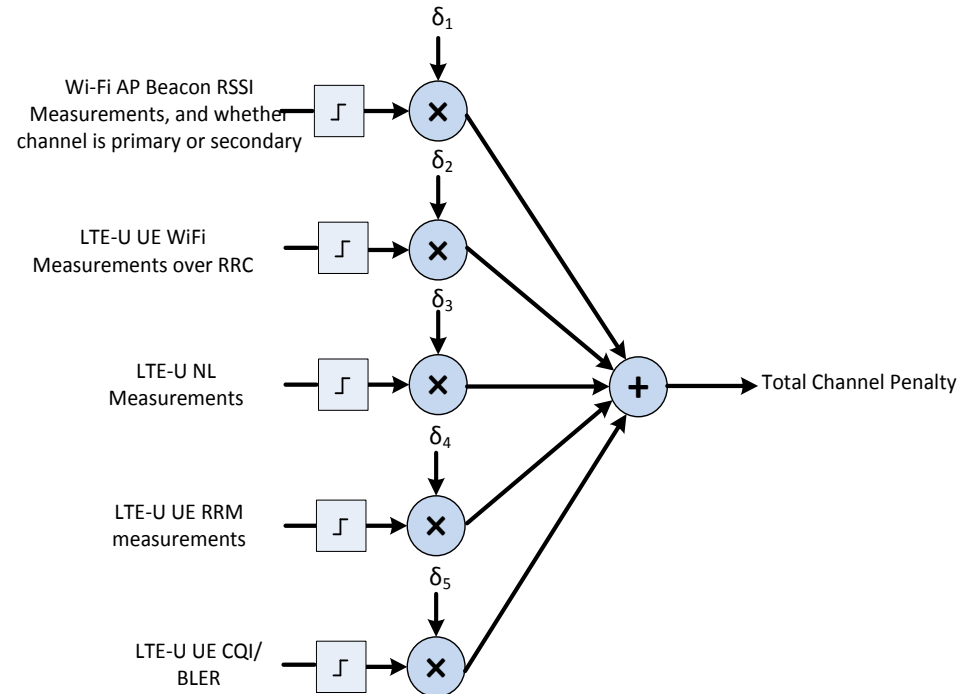

- Different penalty weighting for different interference sources, e.g. WiFi primary channel has higher penalty compared to secondary channel
- Quantized penalty for robustness to measurement errors and to reduce bias due to outliers
 - Measures % of coverage area with some desense due to other AP interference
- Built in mechanisms to detect and mitigate frequent channel switching

Channel Selection- Summary

1. **Has to be both during initial boot up as well as dynamically during operation**
 2. **Choose the cleanest channel in general**
 3. **If possible avoid primary channels of WiFi**
 4. **If possible avoid channels occupied by other LTE-U operators and choose channel occupied by the same LTE-U operator (Forum coexistence spec 6.1.2)**
- **Channel selection is aided by Small Cell NL(Network Listening) and/or UE measurements**
 - **Can be done through passive or active scan- our design uses active**
 - **Scanning typically happens every few seconds**
 - **Channel selection can happen at any time, but typically within 10s seconds**
 - **Channel selection is conservative in that it considers any found beacon to be active**
 - **Taking channel loading in consideration is for further optimization**

Carrier Sense Adaptive Transmission (CSAT)

- A TDM transmission pattern on the LTE-U SCell with T_{CSAT} cycle
 - This pattern leverages existing LTE carrier aggregation MAC signaling (MAC control element for activating and deactivating an SCell)
 - This pattern is triggered based on transmissions measured from Wi-Fi APs
- Wi-Fi medium utilization measurement is performed during LTE-U SCell OFF time, to adjust ON/OFF duty cycle
 - Adaptive trade-off between LTE-U and other systems (e.g. Wi-Fi) performance.

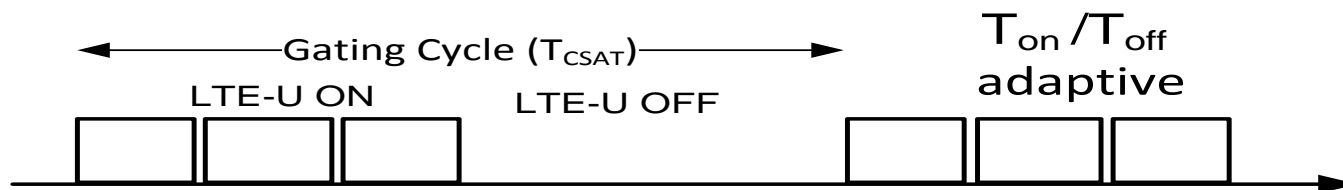

Wi-Fi Medium Utilization (MU) Estimation

Input to CSAT loop

- **Wi-Fi MU monitoring is done where all LTE-U small cells are required to turn 5GHz RF transmission OFF in this period**
 - guarantees overlapping OFF time across neighbor LTE-U small cells for sensing Wi-Fi
- **Sensing time is selected sufficiently large to allow the co-located Wi-Fi NL module for reliable MU monitoring of the operating channel. MU is also averaged across multiple observations**
- **Wi-Fi NL decodes the preamble of any WiFi packet detected during this time and records its corresponding received signal strength indicator (RSSI), duration in μs (or NAV), modulation, coding scheme (MCS) and source/destination address**

Wi-Fi MU Estimation

Averaged weighted observed activity over a monitoring window

- The algorithm divides packets into different categories based on their attributes and each category is assigned a weight
- If the packet is found to be an ACK, or CTS, and the preceding data packet is not detected, the packet is classified as generated from a **hidden node** and count the packet as full duration (nominal value of around 4msec)
- Let W_i and D_i denote the weight and duration of i-th detected packet during MU monitoring time, assume that K packets were detected during the monitoring time. The instantaneous MU is computed as
- $$MU(n) = \frac{1}{\text{MonitoringTime}} \sum_{i=1}^K W_i \times D_i$$

WiFi medium utilization is filtered as follows:

$$\overline{MU}(n) = \alpha_{MU} MU(n) + (1 - \alpha_{MU}) \overline{MU}(n - 1)$$

where filter coefficient α_{MU} could be set small for smaller monitoring time to allow more averaging

CSAT Adaptation

Outer loop to decide on T_{ON} in a given CSAT cycle

- CSAT algorithm will increase/decrease T_{ON} if MU is below/above a certain threshold
- CSAT adaptation is done as follows:

$$T_{ON}(n+1) = \min(T_{ON}(n) + \Delta T_{UP}, T_{ON,max}) \quad \text{if } \overline{MU}(n) < MU_Thr_1$$

$$T_{ON}(n+1) = T_{ON}(n) \quad \text{if } MU_Thr_1 \leq \overline{MU}(n) \leq MU_Thr_2$$

$$T_{ON}(n+1) = \max(T_{ON}(n) - \Delta T_{DOWN}, T_{ON,min}) \quad \text{if } \overline{MU}(n) > MU_Thr_2$$

where

- $T_{ON,min}$ bounds LTE-U ON interval to ensure LTE-U receives a fair share of the medium
- $T_{ON,max}$ bounds LTE-U OFF interval to allow time to sense Wi-Fi activity
- ΔT_{UP} and ΔT_{DOWN} determine the convergence speed of CSAT adaptation

Adjust $T_{ON,min}$ for Fairness

Selecting $T_{ON,min}$ independent of the number of neighbor Wi-Fi APs and LTE-U SCs might result in unfair resource sharing. To mitigate this issue, $T_{ON,min}$ is selected as below after every AP scan:

$$T_{ON,min} = \min \left\{ TONminInMilliSec, \frac{(N + 1) \times T_{CSAT}}{N + 1 + M + NumWiFiNodes} \right\}$$

where

TONminInMilliSec is a configurable parameter controlling minimum duty cycle below ED

N is the number of LTE-U SCs with the same PLMN ID measured by the specific LTE-U SC

M is the number of LTE-U SCs with different PLMN ID

Number of Wi-Fi Devices (*how to weigh in STA activity (visible to the algorithm) is still being optimized*)

Always go 1/num_of_Tx vs 1/num_APs vs a mix

Protecting Latency Sensitive WiFi Applications - Subframe Puncturing

Gaps inside Ton

- Subframe puncturing introduces frequent gaps in the LTE-U ON duration to help Wi-Fi flush delay-sensitive data and management packets that may be queued at the AP because of LTE-U transmissions
- In the specified punctured pattern, the subframes which are punctured are not used for scheduling any data
- Typically few msec every few 10s of msec (2/20msec is typical)

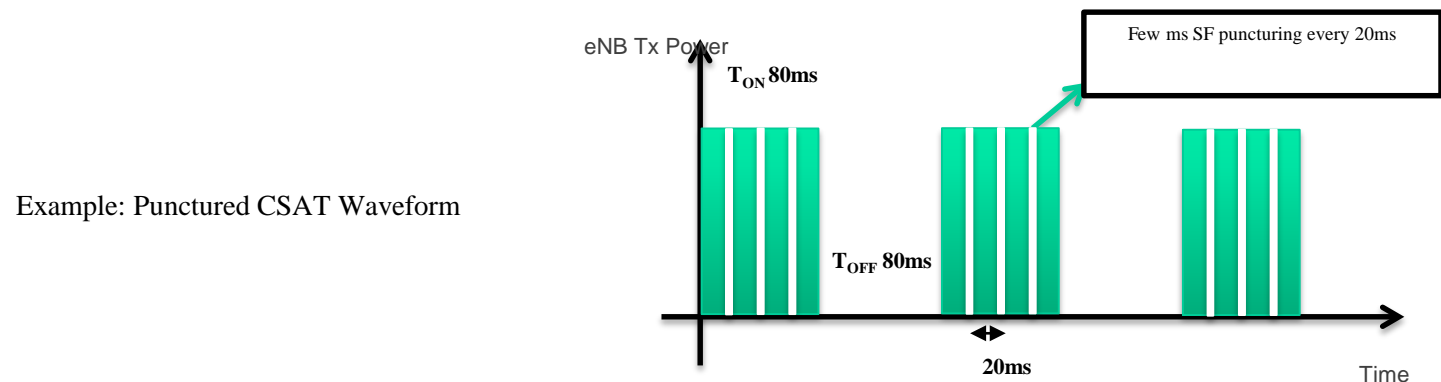

CSAT Cycles

- **Typical CSAT cycles**
 - 80msec total ON/OFF duration (i.e. like 40/40) & 160msec (i.e. like 80/80msec)
- **CSAT cycles on primary WiFi channel are typically shorter to enable beacon transmissions and connection setup activities**
- **In general CSAT cycles are constant but can change in scenarios where LTE-U share is too small**
 - i.e. 10% LTE-U share may be 40msec/360msec as opposed to 10msec out of 100msec

Benefit of WiFi NL

Not fundamental

- **Most coexistence functionalities can be achieved without NL albeit more complexity and less optimal trade-offs**
- **Examples:**
 - NL can help though reacting to some less common scenarios like hidden nodes
 - NL may allow better tradeoff of coexistence since it allows distinction between one node vs multiple nodes when both scenarios show same medium activity
 - NL allows distinction between LTE-U and WiFi nodes allowing the ability to run reuse 1 if need be on the former

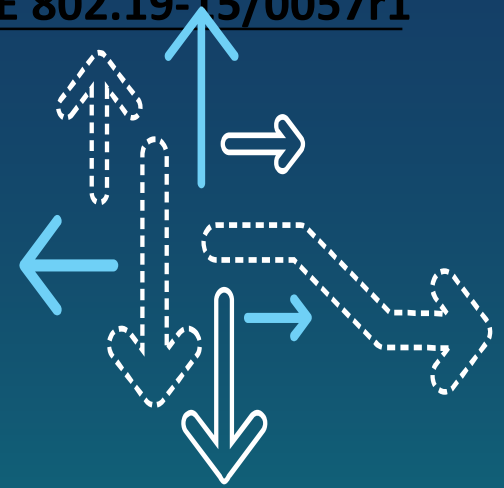

Lab and OTA Testing

LTE-U / Wi-Fi Coexistence Setup

- **Extensive lab test on LTE-U coex**
 - Wi-Fi: Multiple AP and STA brands
 - LTE-U: Test eNB and UE MTP
 - Cabled-up (illustrated) as well as over-the-air
- **Current focus: Non-LBT/CSAT design**
 - LBT-based test depend on 3GPP progress
 - Key Non-LBT coex feature is CSAT
 - CSAT has dynamic duty cycle, max 100-ms ON time, and long + short OFF gaps
 - Note LTE-U coexistence in reality would be better with proper channel selection
- **Cabled-up test in controlled environment**
 - 20MHz as well as 80 MHz used for Wi-Fi baseline testing
 - LTE-U on one of secondary channels of Wi-Fi

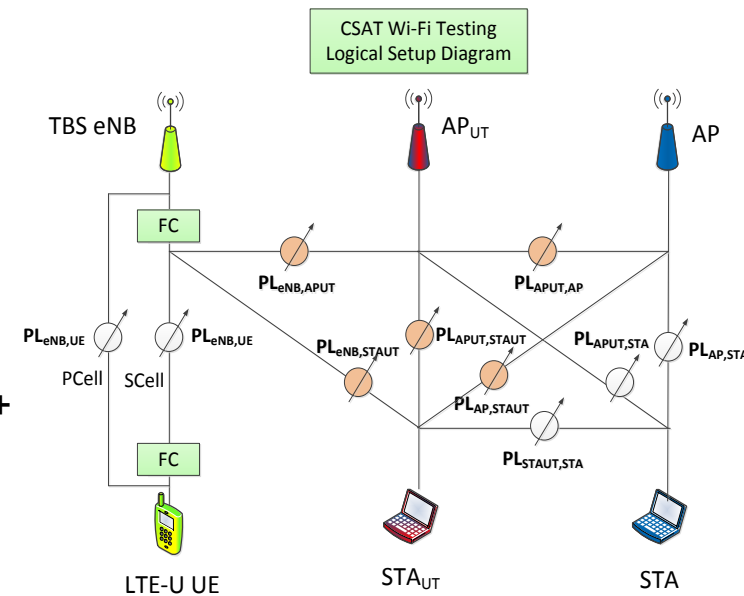

Full Buffer TCP Throughput Results

Cabled-up and Below ED

Below ED

AP ID	CINR	TCP Throughput
1	0 dB	0.9x
1	5 dB	1.1x
1	15 dB	1.8x
2	0 dB	0.9x
2	5 dB	0.95x
2	15 dB	1.85x

- Baseline throughput = x (50% of isolated Wi-Fi throughput – *optimistic assumption*)
- CINR = Wi-Fi signal energy / LTE signal energy at Wi-Fi STA

Downlink TCP Throughput Results

OTA and Above ED

AP Vendor 1	Wi-Fi Isolated Link	AP-AP Baseline			Wi-Fi in AP-LTE-U
		AP1	AP2	Avg. AP	
DL Avg. PHY rate (Mbps)	86.63	72.08	71.83	71.96	84.29
DL Avg. Thpt (Mbps)	65.00	7.93	39.48	23.71	24.14
AP Vendor 2	Wi-Fi Isolated Link	AP-AP Baseline			Wi-Fi in AP-LTE-U
		AP1	AP2	Avg. AP	
DL Avg. PHY rate (Mbps)	80.81	80.03	77.25	78.64	78.66
DL Avg. Thpt (Mbps)	66.54	31.57	29.80	30.68	28.00
AP Vendor 3	Wi-Fi Isolated Link	AP-AP Baseline			Wi-Fi in AP-LTE-U
		AP1	AP2	Avg. AP	
DL Avg. PHY rate (Mbps)	76.45	75.68	71.36	73.52	72.48
DL Avg. Thpt (Mbps)	41.84	36.08	4.23	20.15	25.33

Uplink TCP Throughput Results (Above ED)

OTA and Above ED

Device Vendor 1	Wi-Fi Isolated Link	STA-STA Baseline			Wi-Fi in STA-LTE-U
		STA1	STA2	Avg. STA	
UL Avg. PHY rate (Mbps)	96.30	57.66	75.42	66.54	96.30
UL Avg. Thpt (Mbps)	76.28	22.90	18.29	20.59	36.75
Device vendor 2	Wi-Fi Isolated Link	STA-STA Baseline			Wi-Fi in STA-LTE-U
		STA1	STA2	Avg. STA	
UL Avg. PHY rate (Mbps)	86.70	86.67	86.67	86.67	86.70
UL Avg. Thpt (Mbps)	75.46	33.09	36.55	34.82	33.49
Device Vendor 3	Wi-Fi Isolated Link	STA-STA Baseline			Wi-Fi in STA-LTE-U
		STA1	STA2	Avg. STA	
UL Avg. PHY rate (Mbps)	86.70	86.55	86.64	86.59	85.82
UL Avg. Thpt (Mbps)	79.20	40.68	37.68	39.18	37.19

Full Buffer TCP Throughput Results (Below ED)

OTA and Below ED

AP Model 1	Wi-Fi Isolated Link	AP-AP Baseline			Wi-Fi in AP-LTE-U
		AP1	AP2	Avg. AP	
DL Duty cycle (%)	88.30	27.70	56.99	42.35	77.82
iperf DL Avg. Thpt (Mbps)	70.00	20.25	40.2	30.23	48.00
AP Model 2	Wi-Fi Isolated Link	AP-AP Baseline			Wi-Fi in AP-LTE-U
		AP1	AP2	Avg. AP	
DL Duty cycle (%)	95.83	40.98	37.28	39.13	88.62
iperf DL Avg. Thpt (Mbps)	76.00	36.15	32.75	34.45	52.60
AP Model 3	Wi-Fi Isolated Link	AP-AP Baseline			Wi-Fi in AP-LTE-U
		AP1	AP2	Avg. AP	
DL Duty cycle (%)	91.92	49.77	43.59	46.68	85.22
iperf DL Avg. Thpt (Mbps)	63.60	31.67	28.37	30.02	37.90

Wi-Fi YouTube Streaming Results – Wi-Fi/Wi-Fi vs. Wi-Fi/LTE-U

Below ED

Metrics	AP 1		AP 2	
	Baseline (w/ Wi-Fi)	w/ LTE-U	Baseline (w/ Wi-Fi)	w/ LTE-U
No. of video stalls	6.00	1.67	12.33	2.67
Playback interrupt time (s)	7.94	7.40	4.77	2.00
Initial Buffer Time (s)	0.67	1.33	0.33	0.33
Avg. Thpt (Mbps)	3.49	4.49	3.17	5.89
Avg. PHY Rate (Mbps)	19.81	39.88	65.65	83.55

LTE-U hit is an erasure

LTE-U with CSAT is a better neighbor than Wi-Fi

Overview of OTA Campus Network

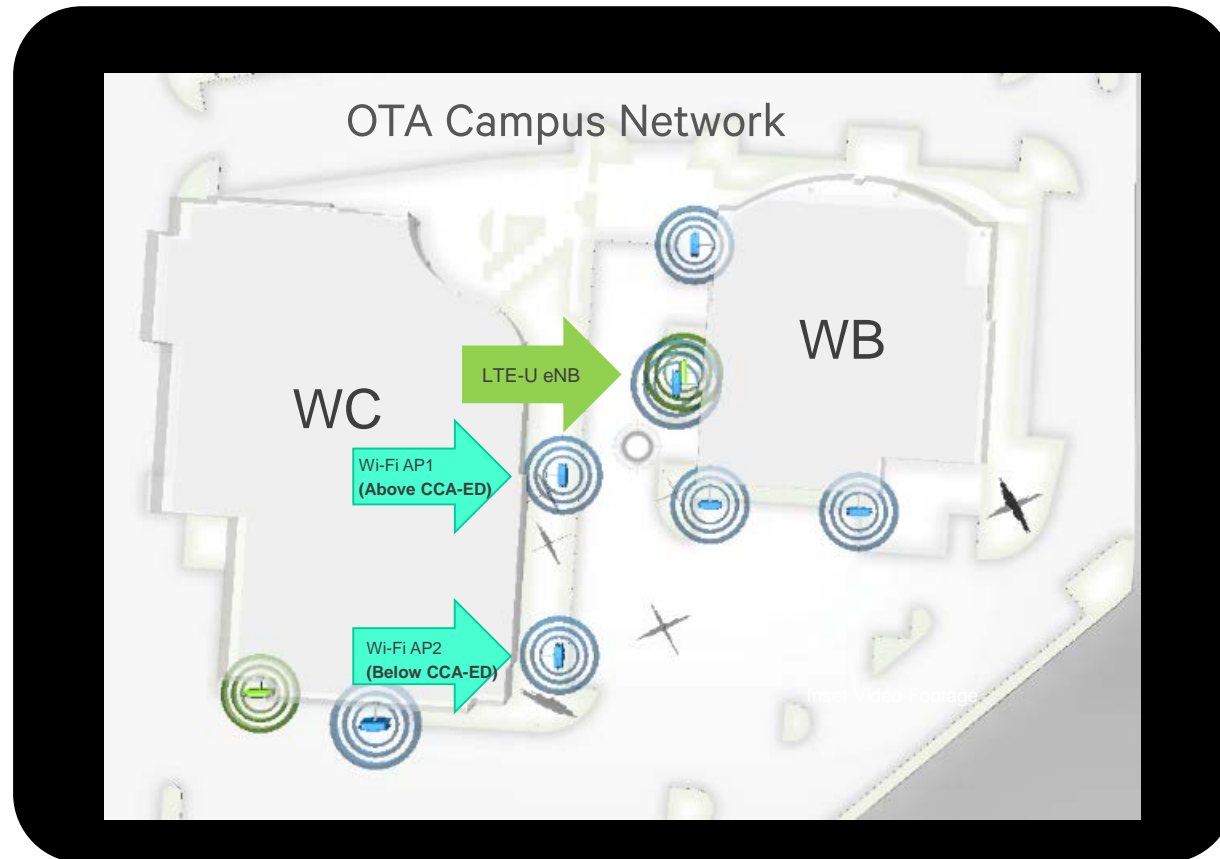

Carrier Wi-Fi VoIP: Primary CH, Above ED, 160msec CSAT, 2/20 Puncturing

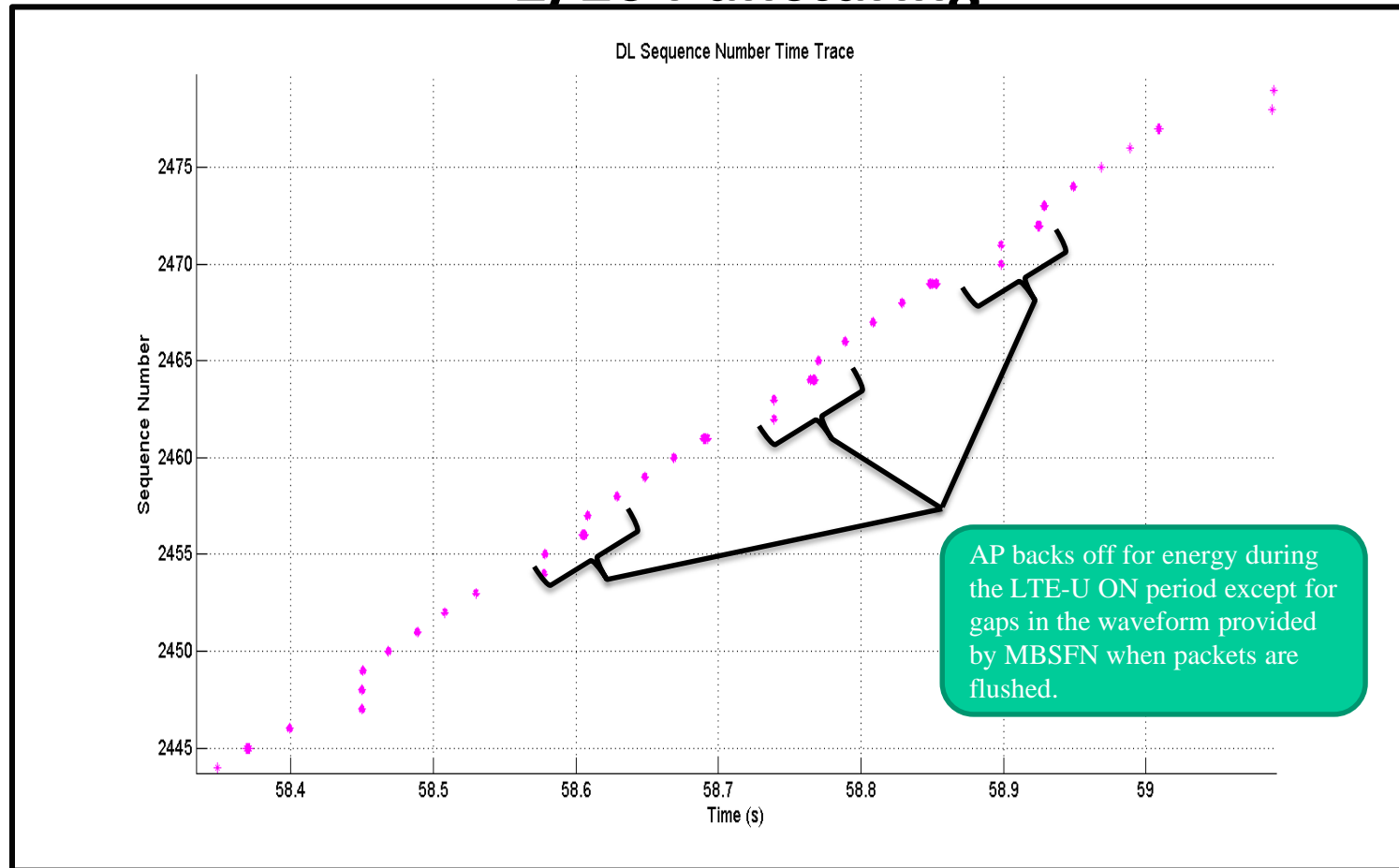

Carrier Wi-Fi VoIP: Primary CH, Below ED, 160ms CSAT, 2/20 Puncturing

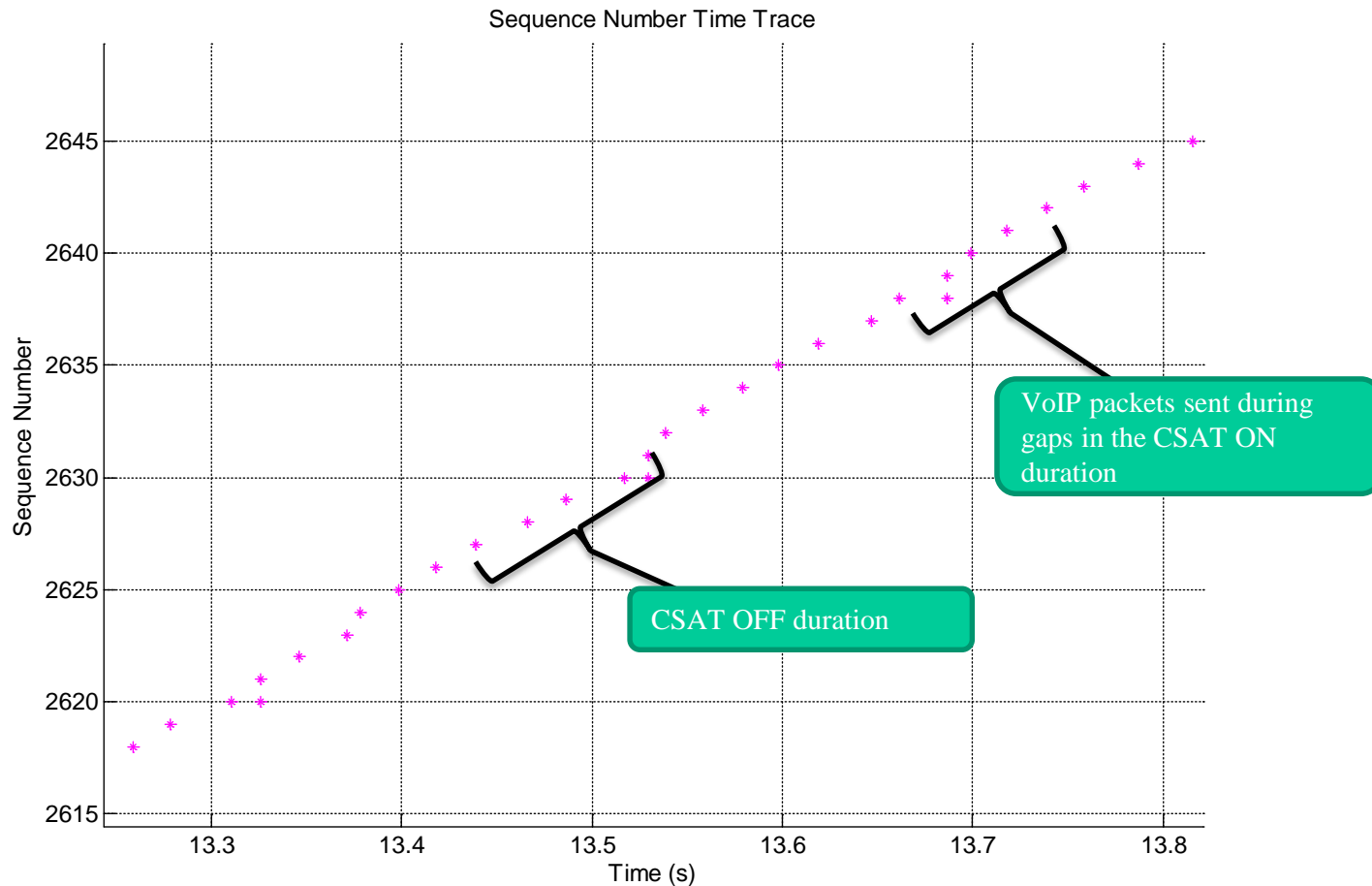

Carrier Wi-Fi VoIP: Primary CH, 160ms CSAT, 2/20 MBSFN

Wi-Fi VoIP Calling Statistics†

Scenario	Jitter > 50ms	Packet Loss	> 3 Consec. Packet Loss
Above ED	6.6%	1.1%	0.1%
Below ED	1.0%	0.7%	0.0%

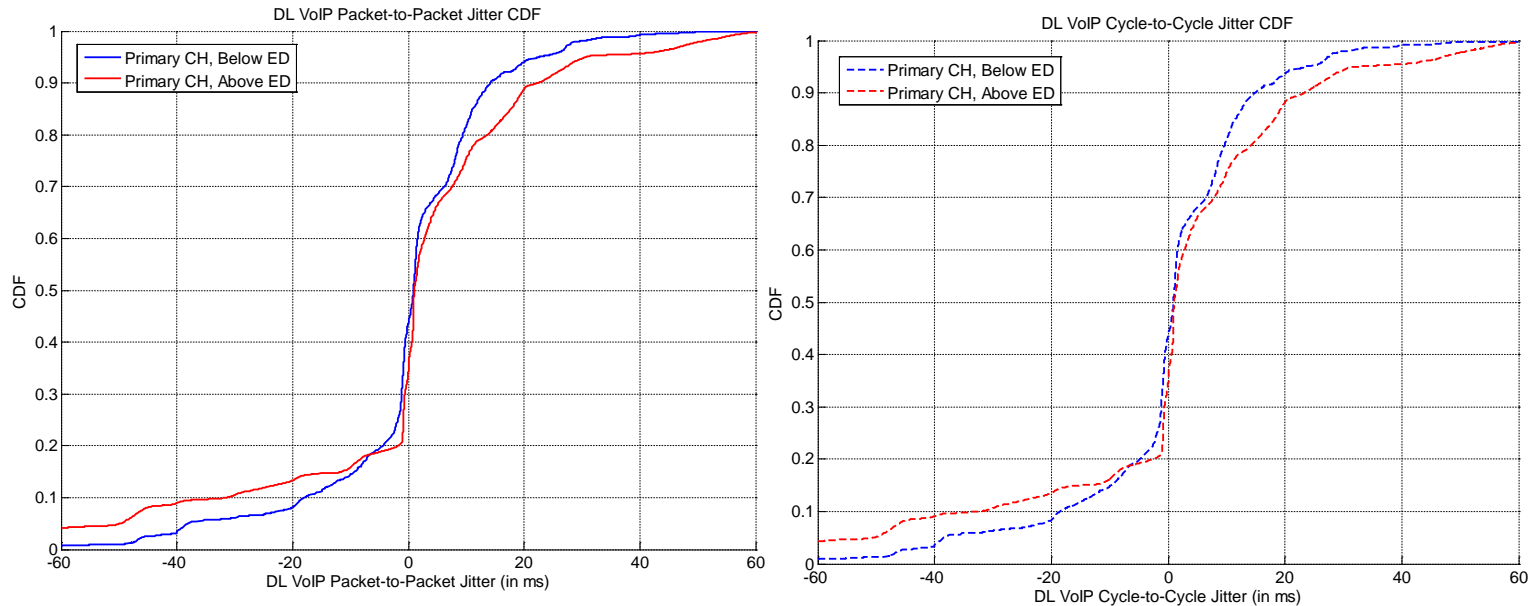

†Calculated per WFA-VE guidelines; Packet arrival one approx. every 20ms

VoIP QoS Statistics with 40 ms on/off

Overall statics from 5 pairs of WiFi VoIP with LTE-U Presence

Scenario	VoIP direction	One-way delay maximum (ms)	Jitter (delay variation) maximum (ms)	Probability of Jitter > 50ms	Packet loss rate	Probability of 4 or more consecutive packet loss
Baseline	Downlink	48	21	0%	0%	0%
	Uplink	40	42	0%	0.03%	0%
Coexistence	Downlink	42	56	0.00%	0%	0%
	Uplink	50	79	0.76%	0.08%	0%

Carrier WiFi VOIP: Secondary CH, Below ED, 640ms CSAT, 2/20 MBSFN

Smart BW mgmt. forces VoIP to go on the clean primary channel for PER. No degradation in voice quality.

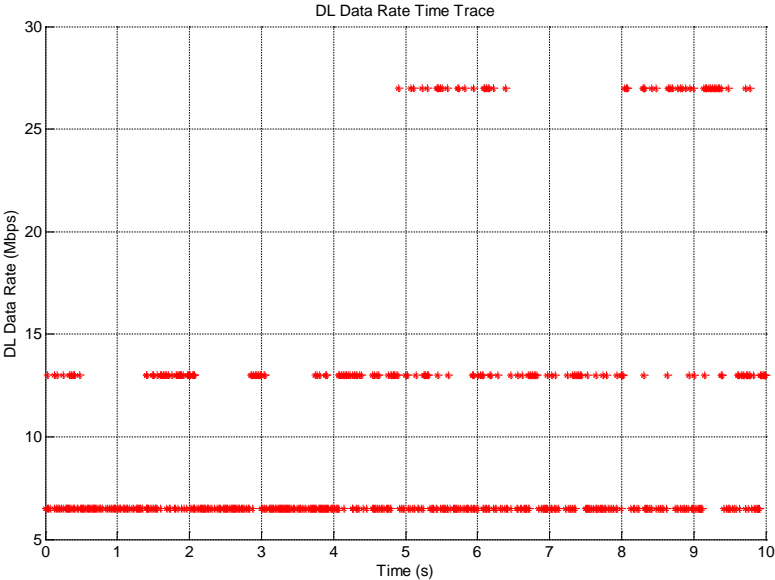
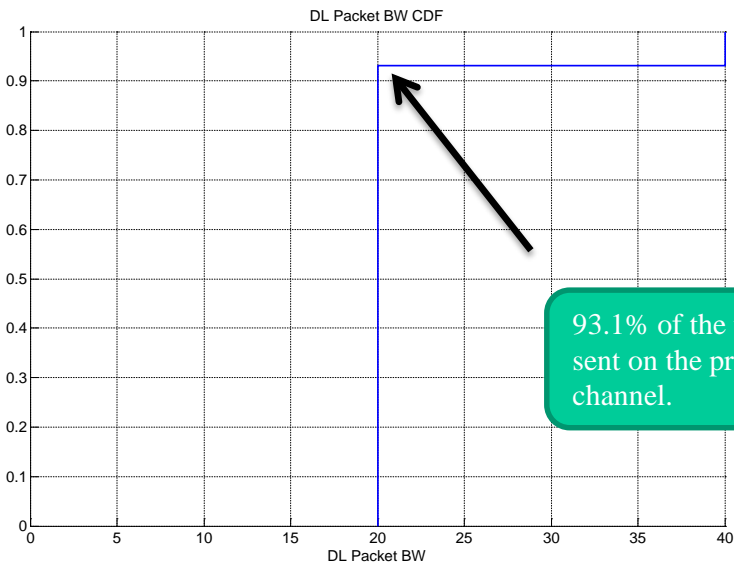

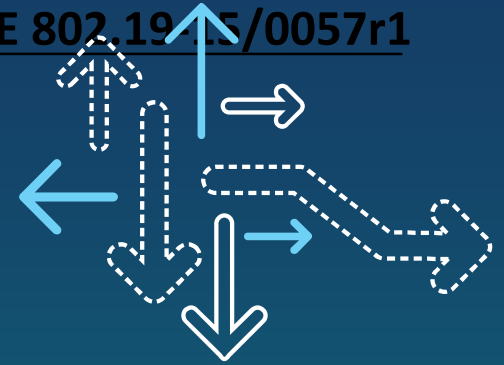

Stress Room Testing

Stress Test Chamber



Stress Test Chamber Setup

- **1 WiFi AP and 1 LTE-U node under test**
 - The WiFi AP-UT is inside an RF shielded box
- **8 Reference WiFi nodes**
 - 4 APs inside RF box to allow below ED scenarios
- **3 Enterprise grade WiFi APs + Controller**
 - Referred to as Vendor A, B, and C
- **Results presented in these slides**
 - All links above CCA-ED
 - 8WiFi+WiFi vs. 8WiFi+LTE-U
 - LTE-U duty cycle = 1/9

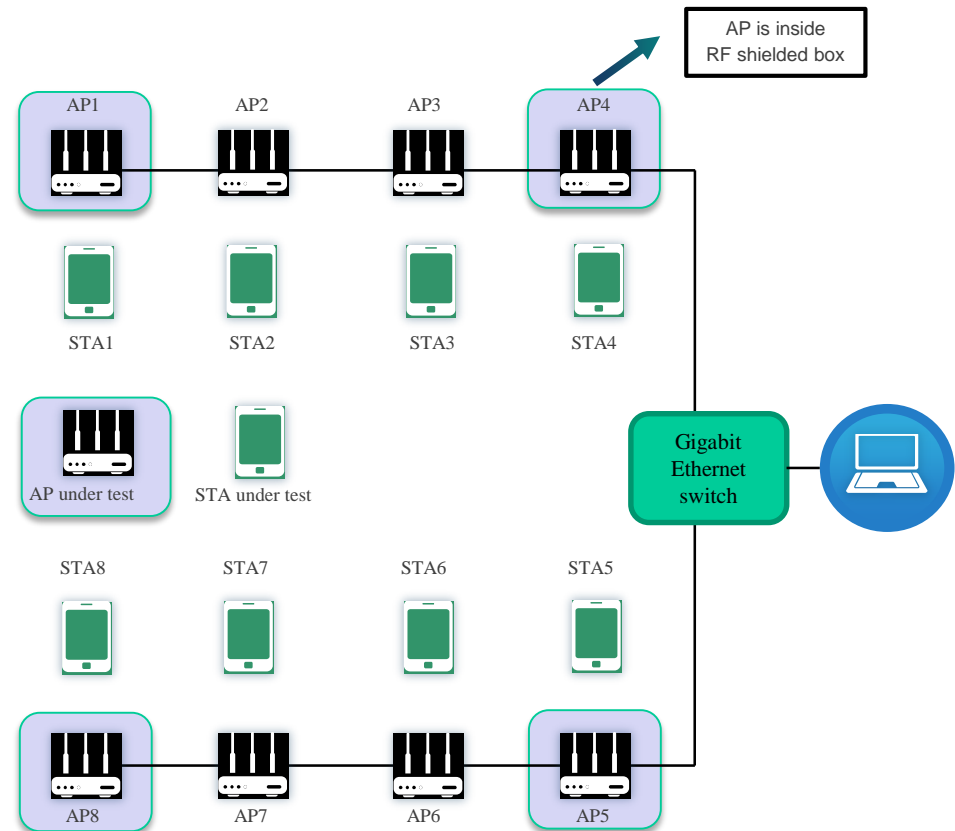

Demo GUI Summary (Vendor A)

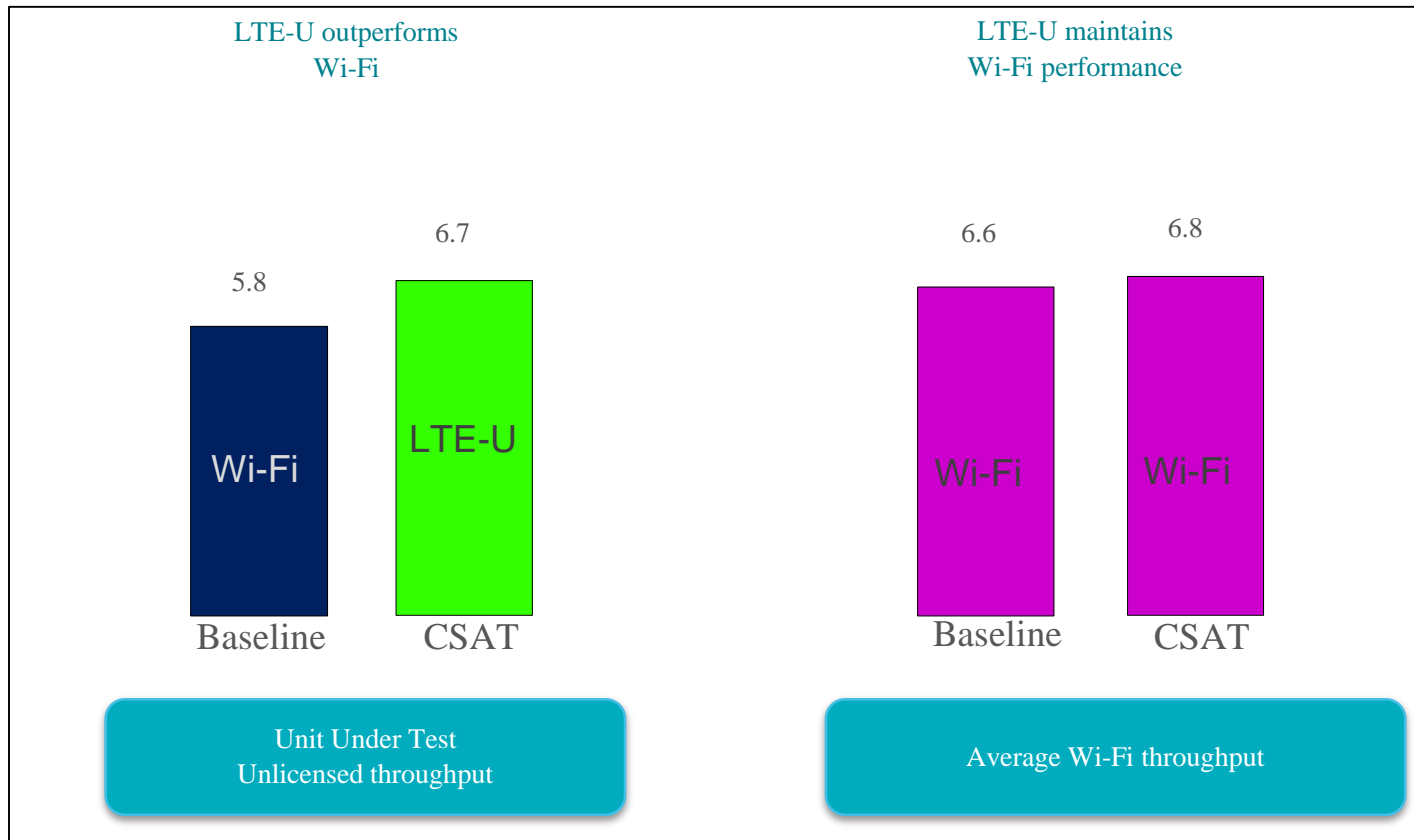

Demo GUI Summary (Vendor B- *more aggressive in winning medium*)

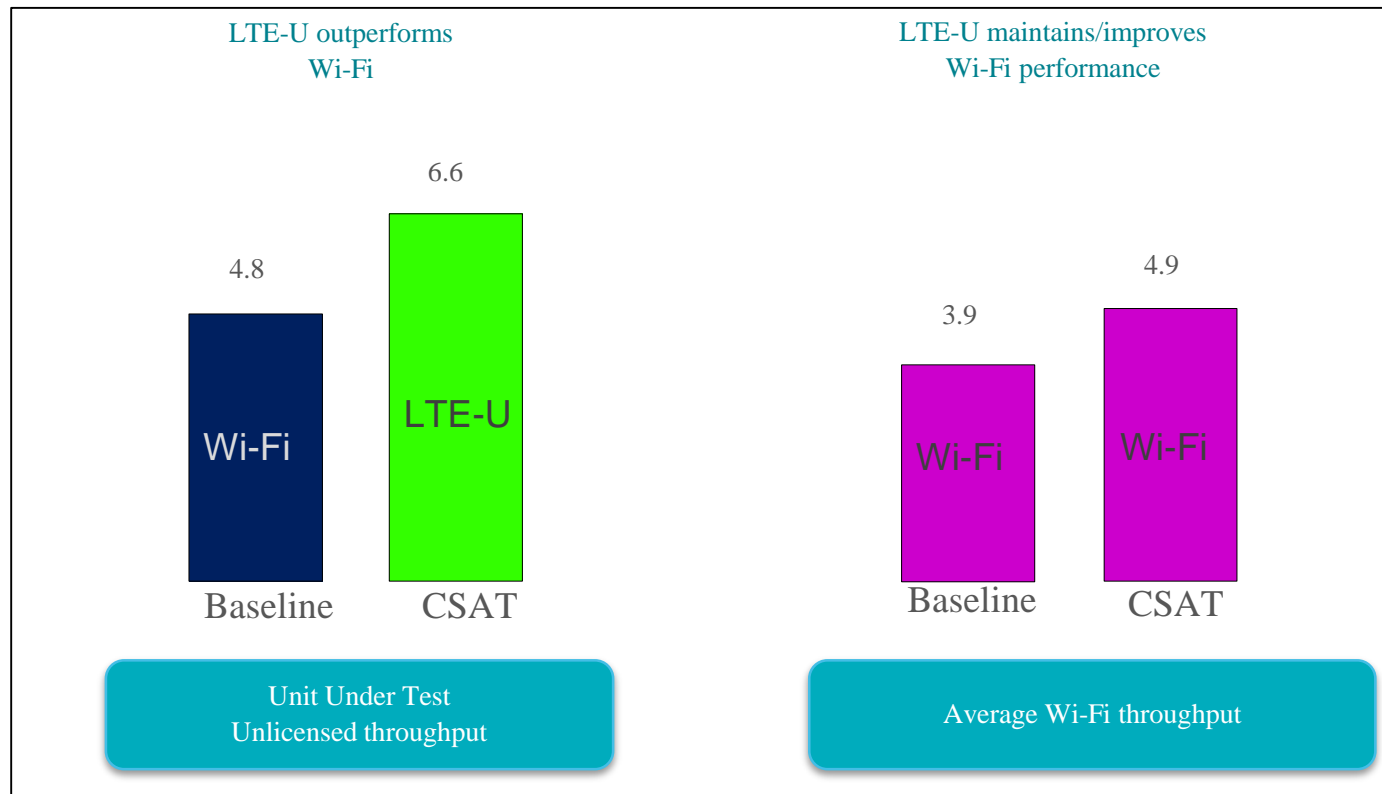

Demo GUI Screenshot (Mixture of Vendor A and B)

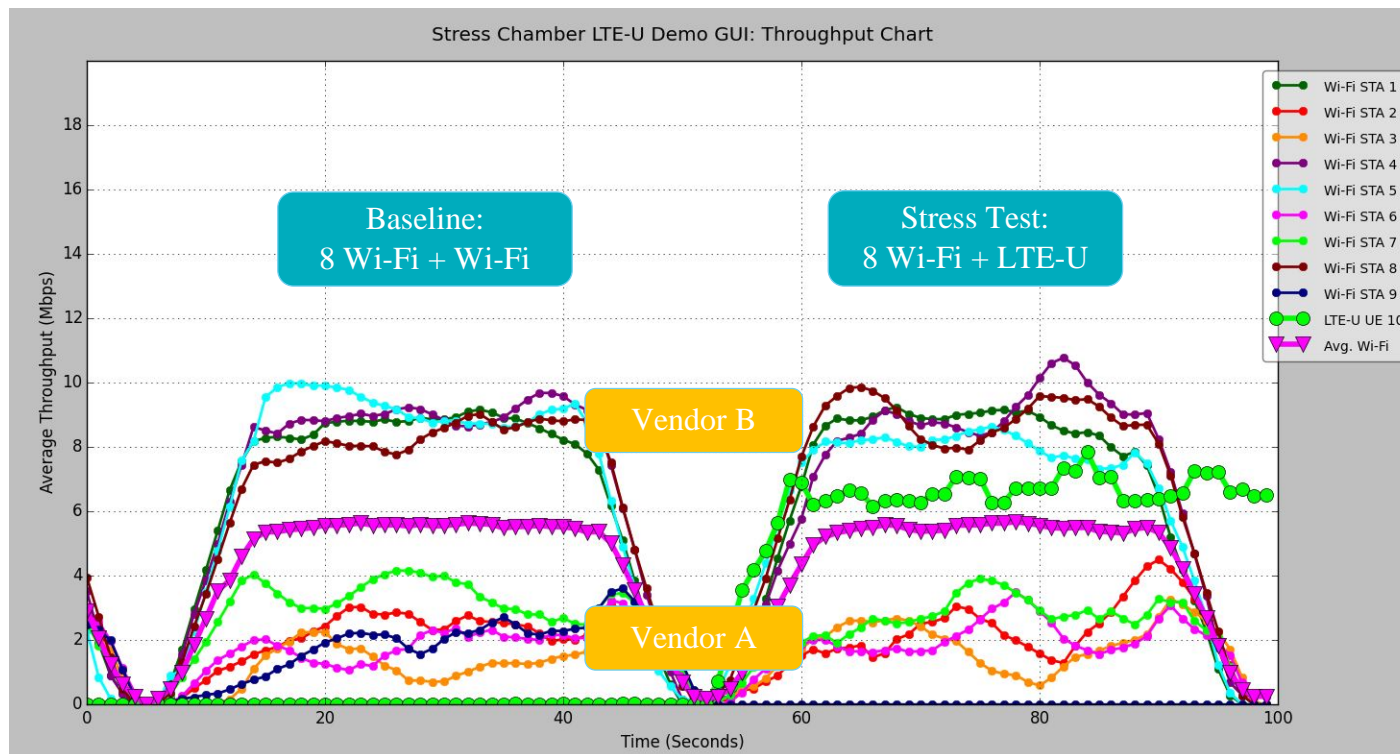

Demo GUI Summary (Mixture of Vendor A and B)

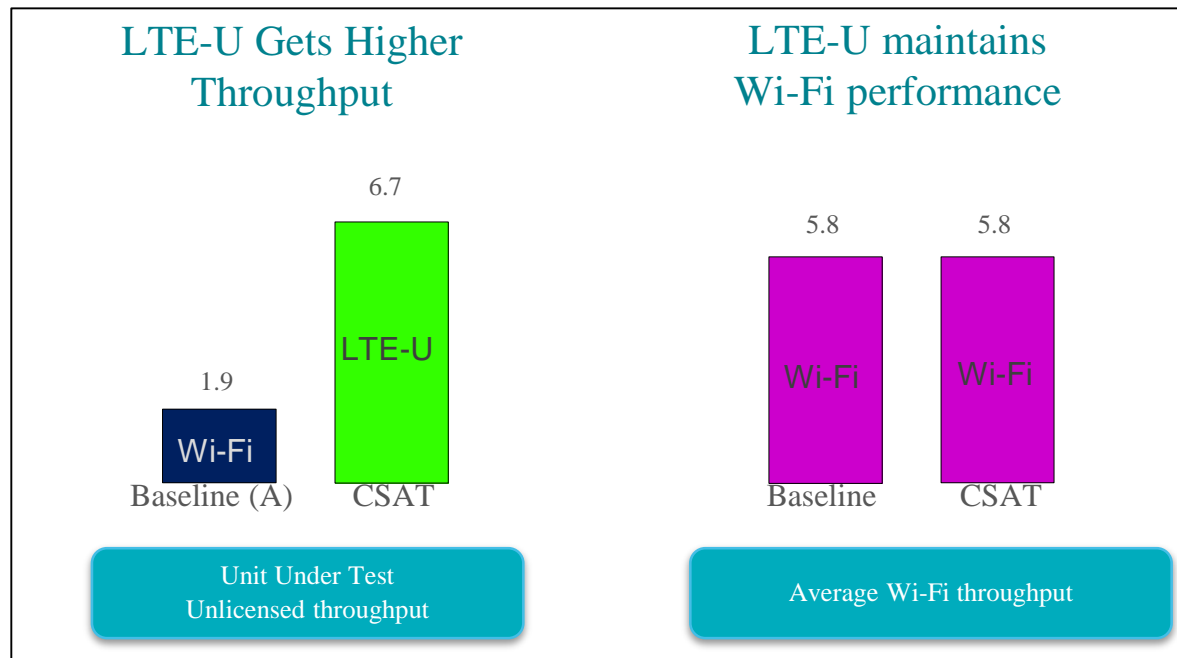

Demo GUI Screenshot (Mixture of Vendor A and C)

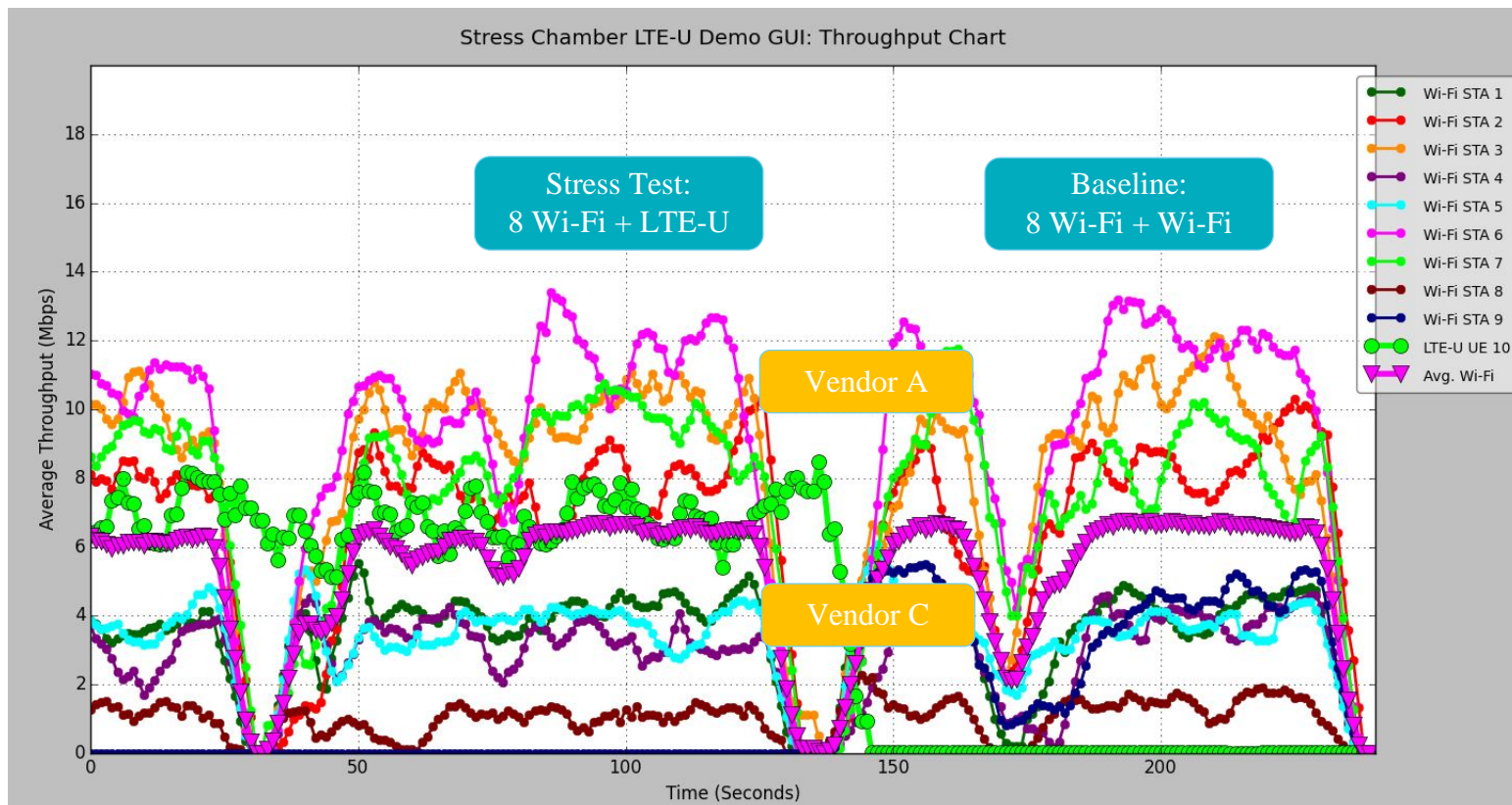

Demo GUI Summary (Mixture of Vendor A and C)

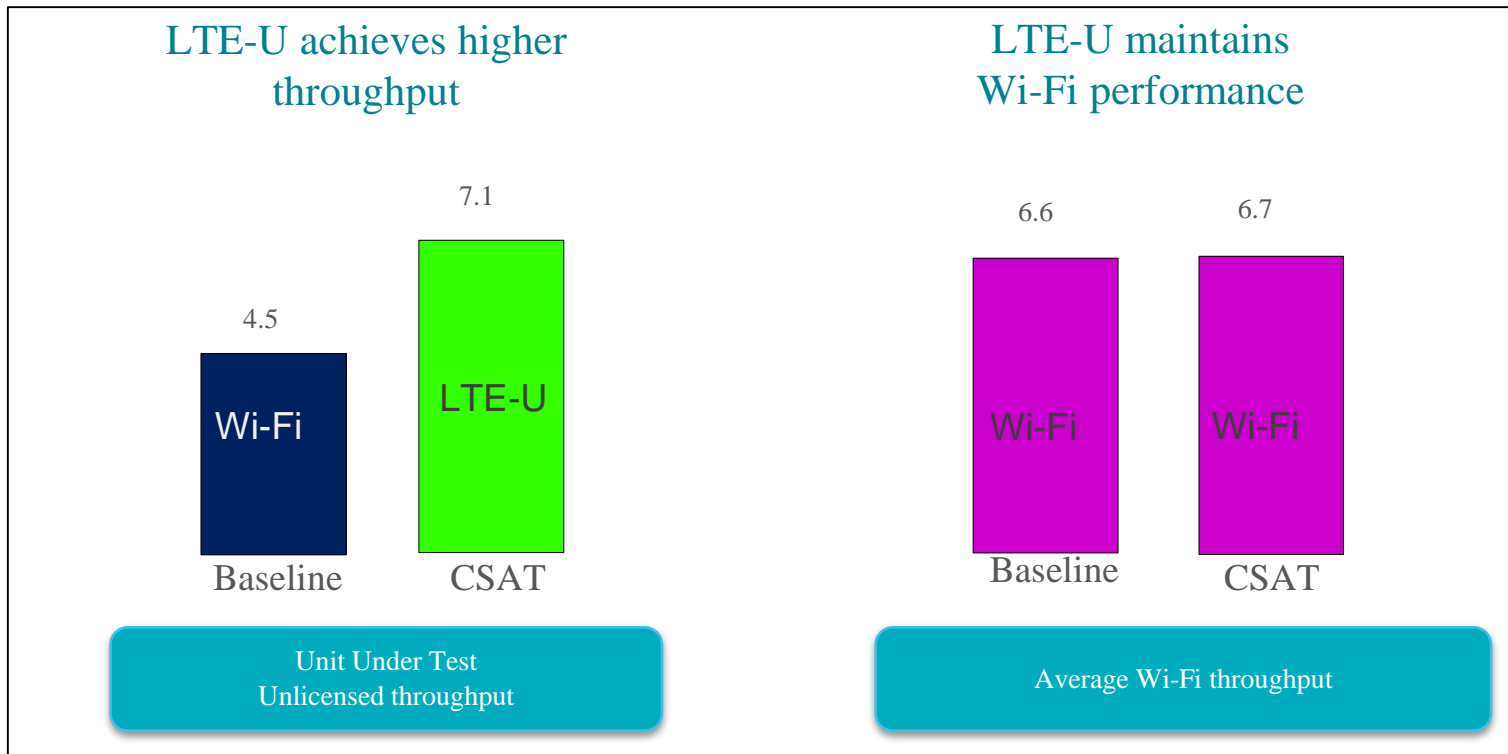

Summary of Stress Room Testing

Main Observations

- **In general LTE-U preserves or enhances Wi-Fi user experience**
- **If Wi-Fi nodes are fair in medium sharing, LTE-U gains are lower, as its link level gains are not exposed by this dense setup**
- **If Wi-Fi nodes are aggressive in medium occupancy, frequent collisions occur and LTE-U provides better user experience for WiFi nodes by deterministically clearing the medium after its fair share decreasing relative number of collisions**
 - LTE-U gains over Wi-Fi are more pronounced in this case and mostly due to MAC

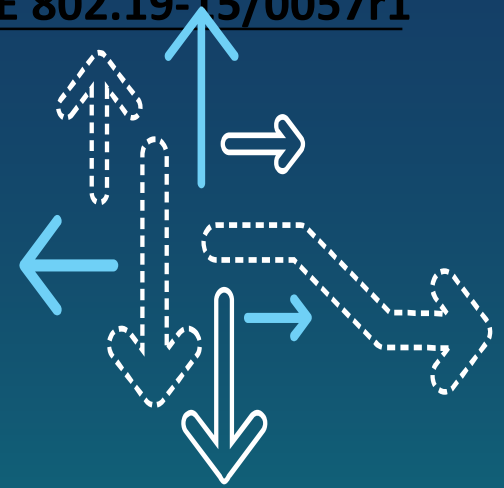

Baseline Fairness Testing

Introduction to fairness study

- **We studied how different Wi-Fi APs coexist with each other**
 - Later compared to coexistence with LTE-U as well
- **Conducted measurements using commercially available Wi-Fi Certified WLAN devices**
 - 5 top-selling retail APs (11ac) based on ‘best-seller lists’ determined from top industry magazines and online-retailers
 - Product diversity of 5 OEMs and 3 chipset-vendors
 - Labelled – A thru E
 - STA (11ac, 1x1) – a top-selling mobile-device
 - Same brand of STA device used with all APs to limit combinations

Test Setup

- **Four Networks with 1 AP having 1 STAs each**
 - All APs set to VHT20 in Ch#153
 - All combinations of APs from set of 5 considered
- **Both APs are doing full-buffer downlink traffic (iperf) to the STAs**
- **Average throughput determined over a 90sec period**

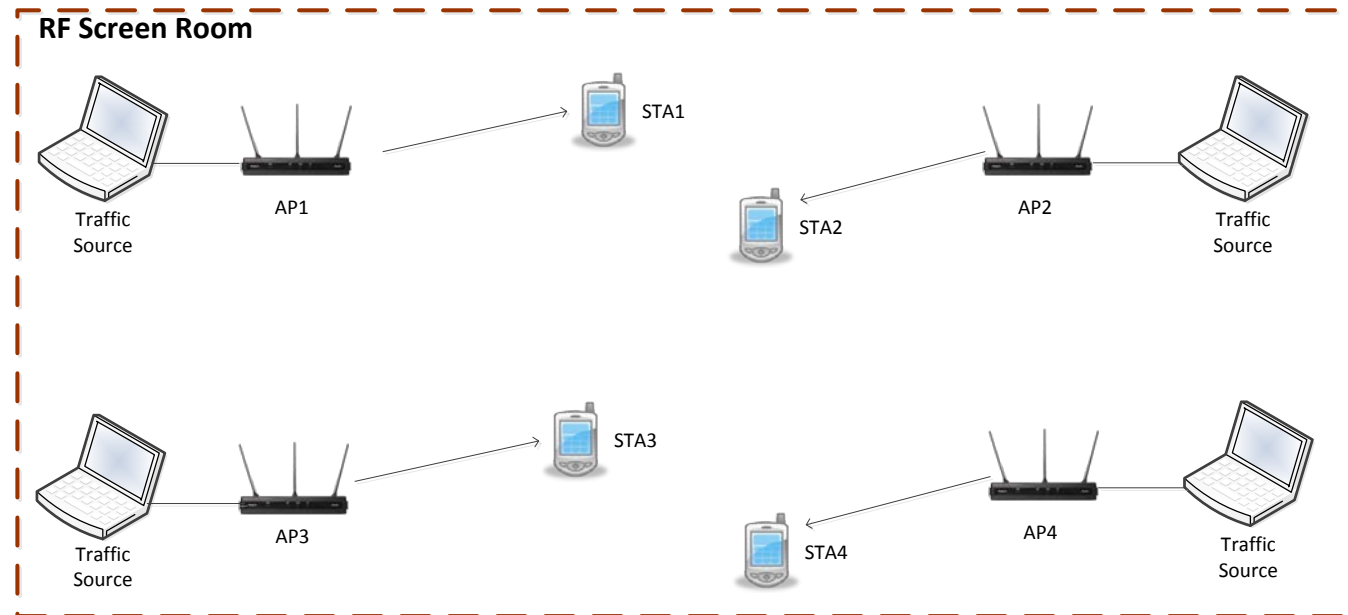

Test Results

APs				Throughput (Mbps)				Aggregate (Mbps)
AP 1	AP 2	AP 3	AP 4	AP 1	AP 2	AP 3	AP 4	
A	B	C	D	40.9	3.9	5.6	3.4	53.7
B	C	D	E	19.4	8.2	7.4	12.9	47.9
C	D	E	A	3.7	2.2	3.6	49.8	59.3
D	E	A	B	4.8	4.6	40.8	4.7	54.9
E	A	B	C	3.9	49.0	2.4	4.3	59.6

- Different APs achieve different levels of throughput share
- Wide variation in channel aggregate throughput of different devices despite similar link conditions (high SNR regime)

Fairness between Wi-Fi/Wi-Fi and Wi-Fi/LTE-U

Test Setup

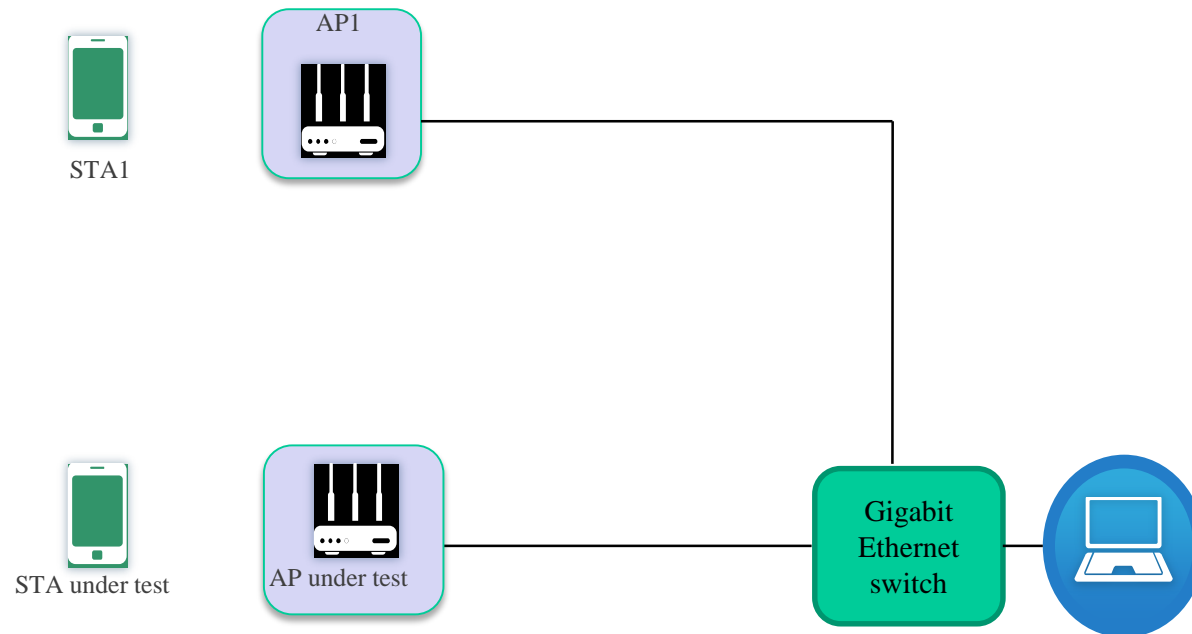

Tests are performed using two Wi-Fi connection pairs across different AP models, and one LTE-U link with one Wi-Fi AP link across different AP models

Consumer grade Fairness with and without LTE-U (*Air time*)

Testing pair-wise airtime sharing across 4 Wi-Fi AP models and between Wi-Fi/LTE-U

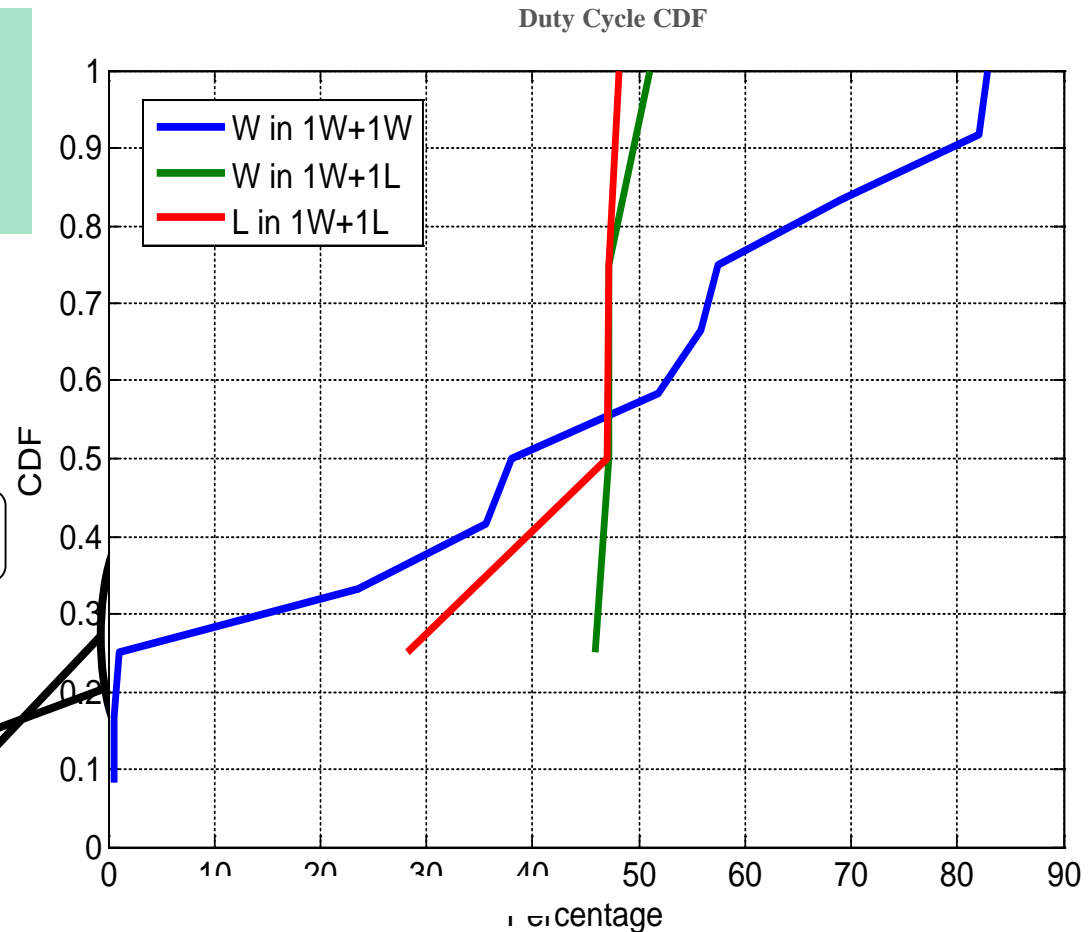

Points corresponding to all 4 Wi-Fi AP models

- Points corresponding to coexistence with AP model A
- AP model A does not obey CCA-ED rule and does not backoff to LTE-U

Technical Report Overview

- **Background of LTE-U operation**
 - 5GHz band definition, channel numbers (EARFCN), LTE-U SDL CA band combinations
- **LTE-U coexistence evaluation methodologies**
 - Evaluation scenarios and performance metrics
- **Evaluation results**
 - Outdoor and indoor simulation results from multiple companies
- **Recommendations for coexistence mechanisms (non-LBT waveform requirement regions)**
 - Channel selection
 - Medium-sensing-based SCell duty cycle in unlicensed spectrum (e.g. CSAT) with max on-time limit
 - Opportunistic Secondary Cell OFF in unlicensed spectrum.
- **Conclusions:**
 - For a given operator, replacing LTE/Wi-Fi bearer selection by LTE + LTE-U carrier aggregation leads to substantial improvement in user experiences in terms of data throughput.
 - For a high density Wi-Fi deployment, if part of the nearby Wi-Fi nodes are replaced by LTE-U nodes, the remaining Wi-Fi nodes throughput is no worse than before, and, in many cases, improved.

List of LTE-U Evaluation Scenarios

Outdoor scenarios				
Scenarios	Deployments	Frequency Elements	#nodes/ Operator	Private Wi-Fi
SO1-4	2 operators: Wi-Fi/Wi-Fi => LTE-U/Wi-Fi => LTE-U/LTE-U	10	8	N
SO5-8	2 operators: Wi-Fi/Wi-Fi => LTE-U/Wi-Fi => LTE-U/LTE-U	10	4	N
SO9-12	2 operators: Wi-Fi/Wi-Fi => LTE-U/Wi-Fi => LTE-U/LTE-U	4	8	N
SO13-14	3 operators: Wi-Fi/Wi-Fi/Wi-Fi => LTE-U/LTE-U/Wi-Fi	4	4	N
Indoor scenarios				
Scenarios	Deployments	Frequency Elements	#nodes/ Operator	Private Wi-Fi
SI1-4	2 operators: Wi-Fi/Wi-Fi => LTE-U/Wi-Fi => LTE-U/LTE-U	10	4	Y
SI5-8	2 operators: Wi-Fi/Wi-Fi => LTE-U/Wi-Fi => LTE-U/LTE-U	4	4	Y
SI9-12	2 operators: Wi-Fi/Wi-Fi => LTE-U/Wi-Fi => LTE-U/LTE-U	4	4	N

Summary of evaluation scenarios from LTE-U Forum Technical Report

Notes: 1 Frequency Elements = 40 MHz. For 2 operators cases, each set defines 4 scenarios: Wi-Fi/Wi-Fi (baseline), LTE-CA (without coexistence) / Wi-Fi, LTE-U / Wi-Fi, LTE-U/LTE-U. Tx power on unlicensed for eNB and AP is 24 dBm except SO9-14 where 30 dBm is used.

LTE-U Outdoor Simulation Scenarios (SO1-12)

- Two operators (A/B) deployment
 - 2x10MHz HetNet in Licensed band
 - Wi-Fi or LTE-U SDL in Unlicensed band
 - Wi-Fi model applies to enterprise or operator deployment
 - 4 or 10 FE (Freq Element) total in each hotspot
- All Wi-Fi with LDPC & Channel Selection
 - Wi-Fi: 802.11ac
 - LTE & Wi-Fi: 2x2 MIMO with max rank 2 transmissions
- Bursty traffic model based on modified 3GPP model 2
 - Traffic load increased to load all the cells

- 3GPP model* with 500m macro ISD
- Clustered Pico model
 - One hotspot cluster per Macro cell
 - 50 meter radius
 - 8 or 4 Picos per operator in a cluster
 - 10m minimum distance between Picos from different operators
- User distribution
 - 60 UEs per Macro cell per operator
 - 2/3 UEs are in 70m radius of cluster center

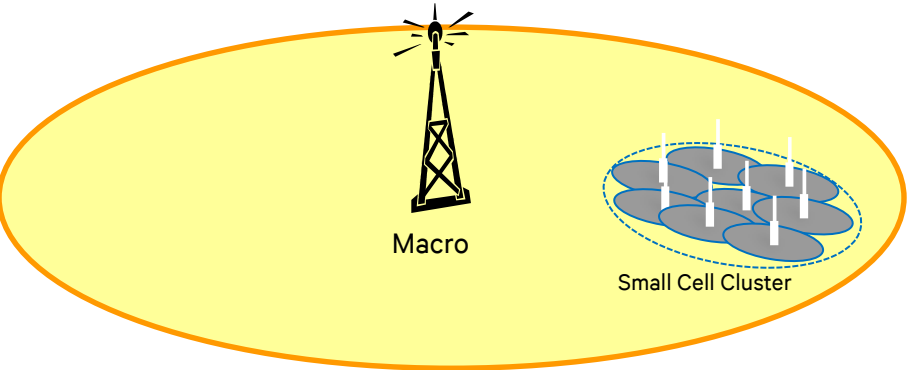

Clustered Pico Scenario

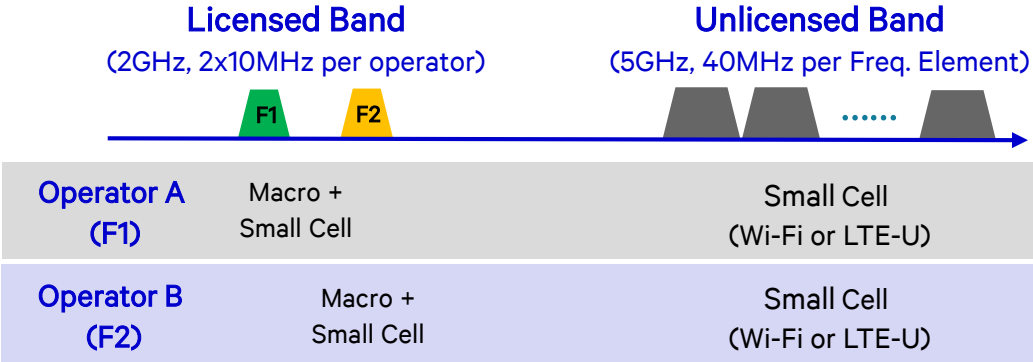

* 3GPP TR 36.872, LTE pico transmit power: 30dBm+5dBi antenna gain. LTE-U Pico//WiFi AP Tx power (outdoor SC): 24dBm+5dBi antenna gain. UE Tx power in licensed band is 23dBm while Wi-Fi STA Tx power is 18dBm.

Simulated LTE-U and Wi-Fi Outdoor Performance

High Density Scenario (SO1-4) from Technical Report

Median DL User Throughput

(2 deployments x 8 outdoor Picos / cluster, 10x40MHz unlicensed spectrum)

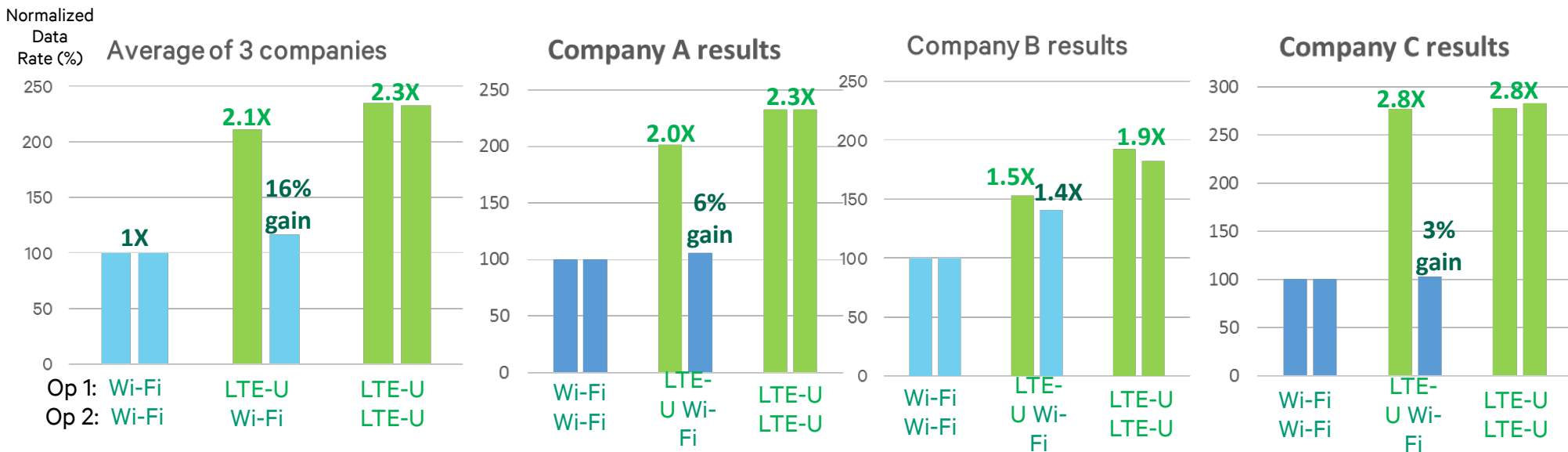

In the LTE-U/Wi-Fi coex case, Wi-Fi performance is maintained/improved, while LTE-U's average gain is 110%

Outdoor results from test cases SO1-4: 2 operators with 8 nodes per operator in one cluster, 10 channels of 40MHz. LTE-U uses R-10/11 with coexistence techniques. See the Technical Report for more details.

Simulated LTE-U and Wi-Fi Outdoor Performance

Very High Density Scenario (SO9-12) from Technical Report

Median DL User Throughput

(2 deployments x 8 outdoor Picos / cluster, 4x40MHz unlicensed spectrum)

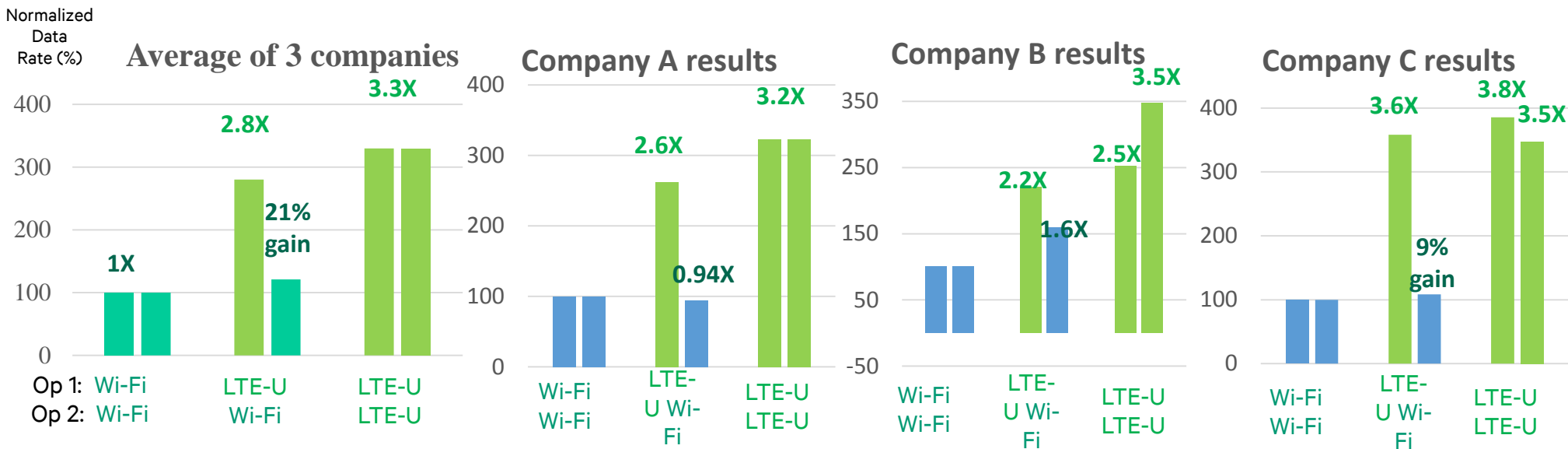

In the LTE-U/Wi-Fi coex case, Wi-Fi performance is maintained/improved, while LTE-U's average gain is 180%

Outdoor results from test cases SO9-12: 2 operators with 8 nodes per operator in one cluster, 4 channels of 40MHz. LTE-U uses R-10/11 with coexistence techniques. See the Technical Report for more details.

Simulated LTE-U and Wi-Fi Outdoor Performance (Tail Users)

Highlights of the Technical Report

5-percentile Tail DL User Throughput (2 deployments x 8 outdoor Picos / cluster)

High Density (SO 1-4, 10x40MHz unlicensed spectrum)

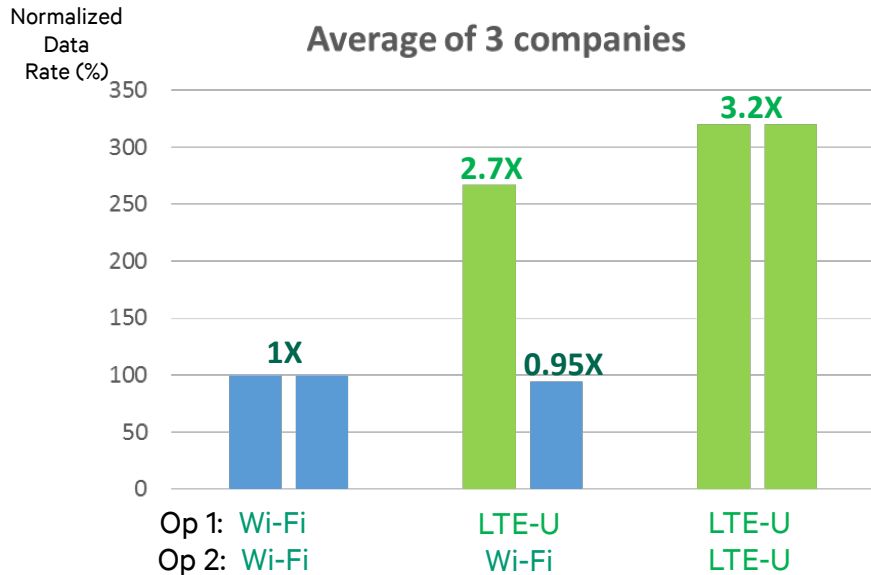

Very High Density (SO 9-12, 4x40MHz unlicensed spectrum)

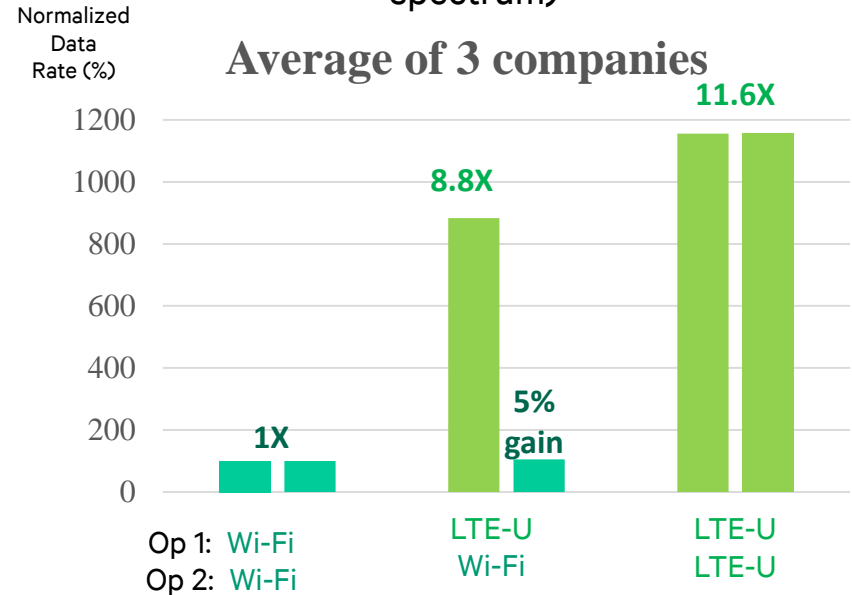

LTE-U delivers more gains to tail users while maintaining or improving Wi-Fi performance

Outdoor results from test cases SO1-4 and SO9-12: 2 operators with 8 nodes per operator in one cluster, 10 (SO1-4) or 4 (SO9-12) channels of 40MHz. LTE-U uses R-10/11 with coexistence techniques. See the Technical Report for more details.

S09 (W+W), S011(W+L), S012 (L+L) - 4x40MHz, 8 nodes/op/cell

Additional Statistics from Qualcomm Simulation: User throughput

- Arrival rate per user: 0.5MB burst every 1.5s (3GPP TM2) resulting in 70% WiFi network loading
- On average 6-7users per AP (87% off-load WiFi, 89% off-load LTEu)
- Compared with Wi-Fi + Wi-Fi baseline, the Wi-Fi throughput is almost unchanged when the other operator is LTE-U.
- Compared to Wi-Fi (in Wi-Fi + Wi-Fi), LTE-U has roughly 3X gains in terms of median burst rate
 - This is due to the fact that with more density (number of nodes per channel), Wi-Fi performance is very poor (in Wi-Fi + Wi-Fi) due to inefficient MAC and preamble detection failure that can results in collisions and increase in retransmissions

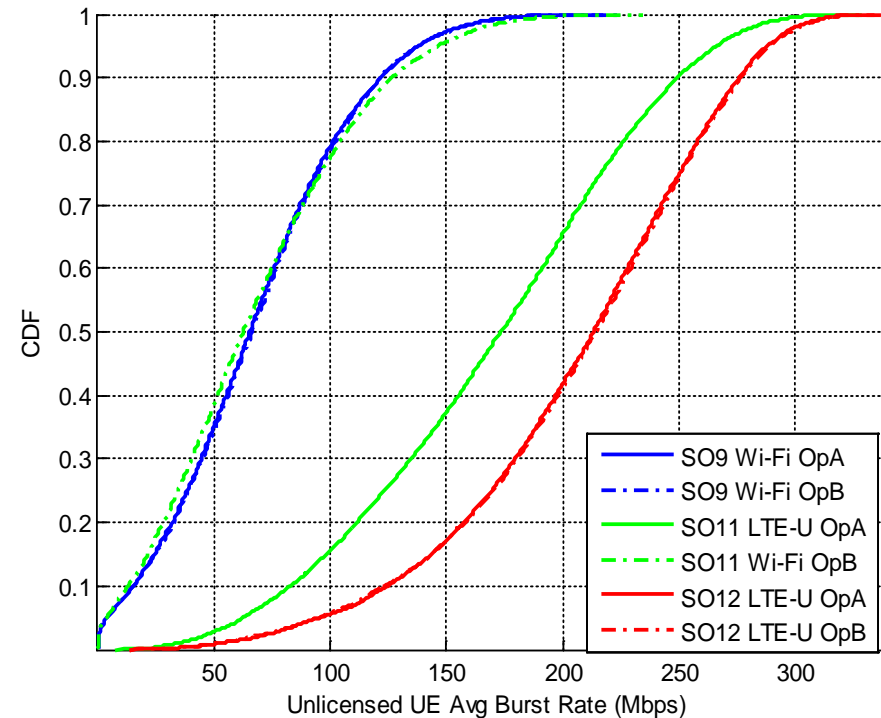

S09 (W+W), SO11(W+L), SO12 (L+L) - 4x40MHz, 8 nodes/op/cell

Additional Statistics from Qualcomm Simulation: Network Loading

- *Loading: The percentage of time a SC has non-empty buffer to the total time*
- Compared with Wi-Fi + Wi-Fi baseline, the Wi-Fi loading is increased when the other operator is LTE-U

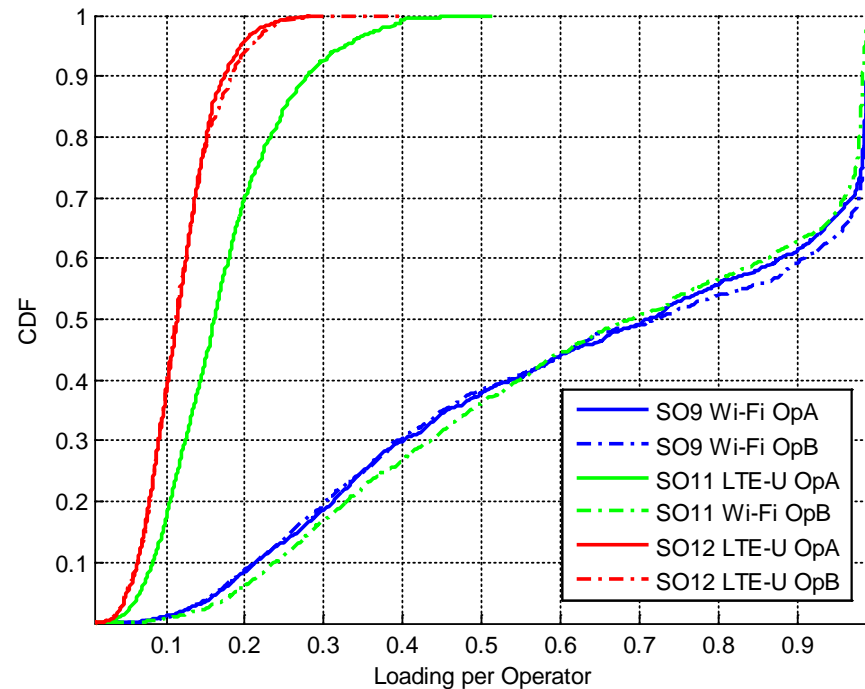

SO9 (W+W), SO11(W+L), SO12 (L+L) - 4x40MHz, 8 nodes/op/cell

Additional Statistics from Qualcomm Simulation: Reuse & SINR

- *Reuse: Time of data in buffer to time of medium access*
- There is small degradation in average (and more in tail) user SINR distribution for Wi-Fi with LTE-U neighbors compared to Wi-Fi neighbors. This can be understood as Wi-Fi does not back off to LTE-U below -62dBm
- The loss in user tail SINR dominates WiFi rate control decreasing MCS. On the other side reuse of WiFi gets better and total impact on throughput is almost a wash

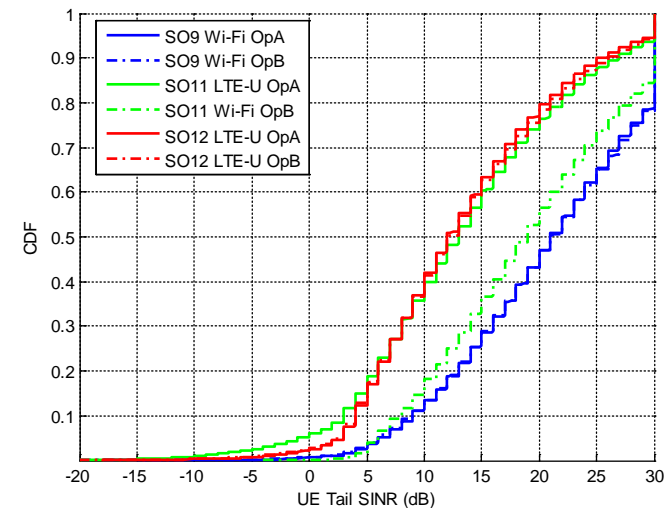
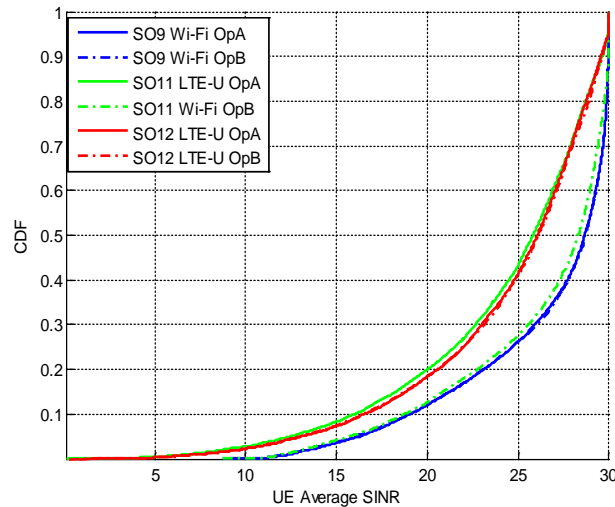
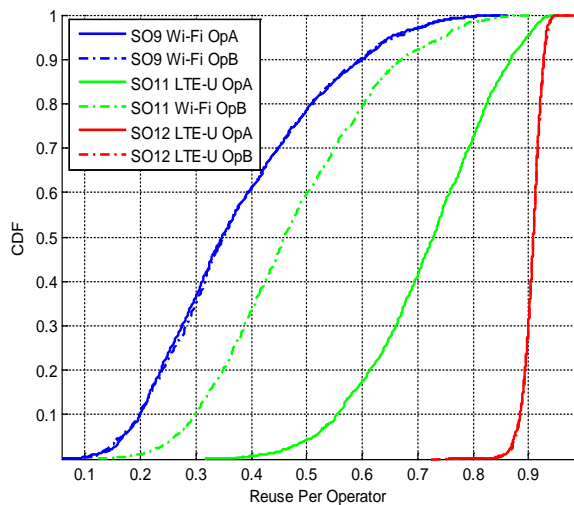

Simulated LTE-U and Wi-Fi Outdoor Performance

3 Deployments Scenarios (SO13-14) from Technical Report

Very High Density (3 deployments x 4 outdoor Picos / cluster, 4x40MHz unlicensed spectrum)

Medium DL User Throughput

Average of 3 companies

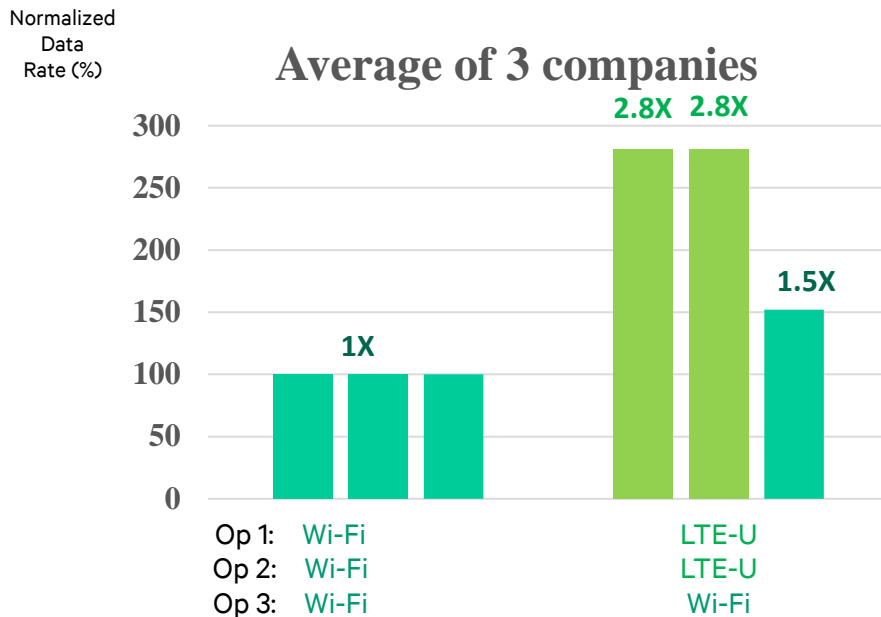

5-percentile Tail DL User Throughput

Average of 3 companies

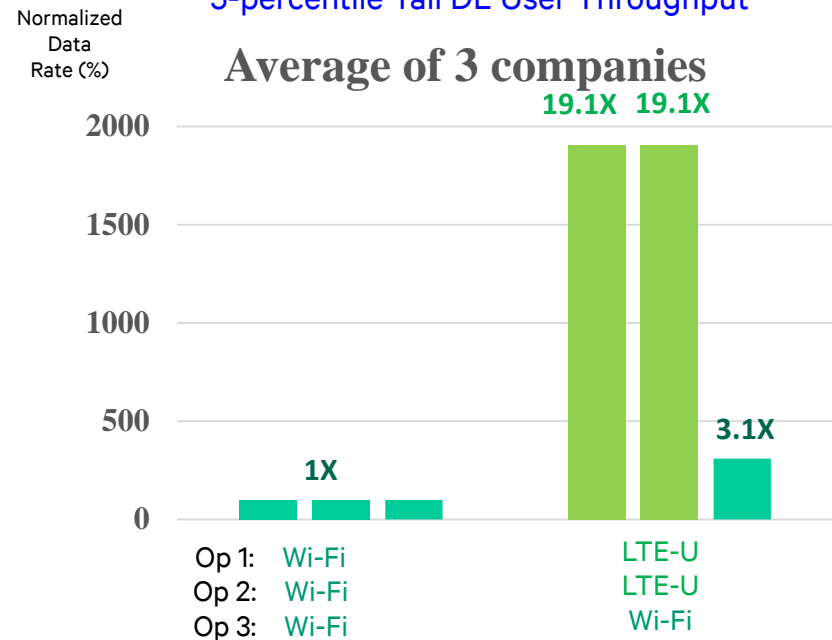

LTE-U delivers 3X gains to medium user rate while improving Wi-Fi performance

Outdoor results from test cases SO13-14: 3 operators with 4 nodes per operator in one cluster, 4 channels of 40MHz. LTE-U uses R-10/11 with coexistence techniques. See the Technical Report for more details.

LTE-U Indoor Simulation Scenarios (SI1-8)

- Indoor hotspot scenario based on InH model from 3GPP 36.872
 - Single floor building with building plan close to shopping malls, enterprise or airport
 - 4 FE (SI5-8) or 10 FE (SI1-4) total shared by 2 operators in these scenarios
 - Serving node dropping: 4 access points or small cells per operator (denoted as operator 1 and 2)
 - Operator 1: regularly dropped in the middle of the hall
 - Operator 2: randomly dropped in the middle of the hall
 - Min. separation distance 3m between Op1 and Op2 small cells and Min separation distance 3m between Op2 small cells
 - Additional 16 private Wi-Fi APs: one per shop/office with random dropping
 - One Wi-Fi STA for each Wi-Fi AP in the same shop
- ITU propagation model: 3GPP 36.872 and 36.814
- LTE primary carrier will be co-channel with Macro (2GHz)
 - 21 cell Macro layout
 - Randomly drop 1 building per Macro
 - 60 UEs per macro cell per operator
 - 2/3 UEs are uniformly dropped inside the building
 - 1/3 UEs are dropped uniformly in the cell

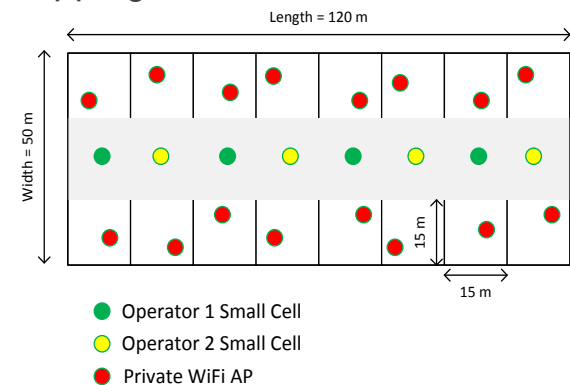

Simulated LTE-U and Wi-Fi Indoor Performance

High Density Scenario (SI5-8) from Technical Report

Median DL User Throughput

(2 deployments x 4 indoor small cells + 16 private Wi-Fi APs per building, 4x40MHz unlicensed spectrum)

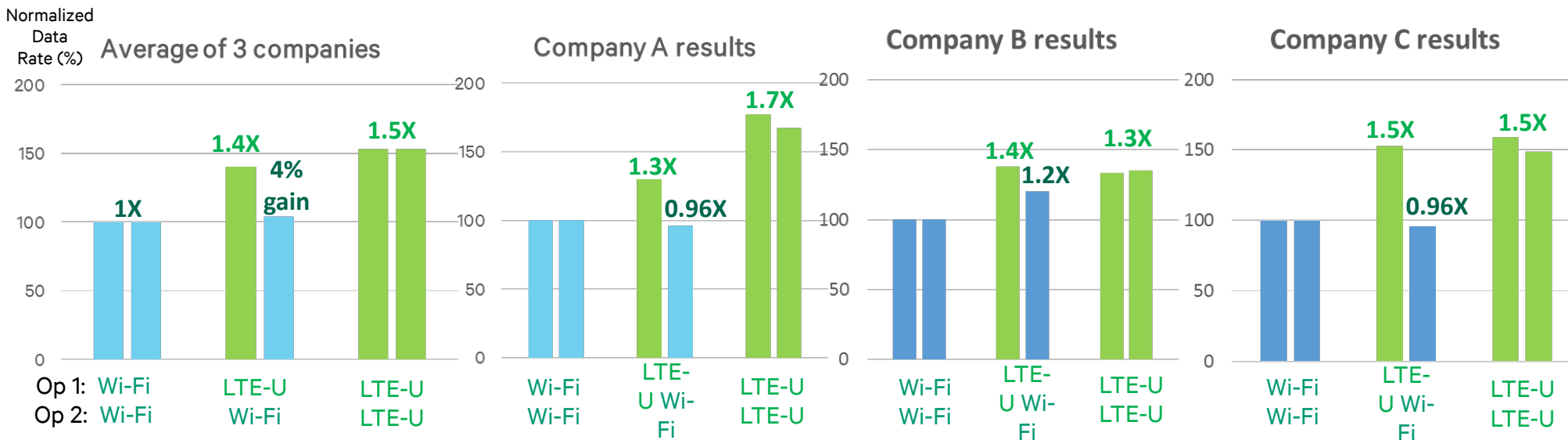

In this indoor LTE-U/Wi-Fi coex case, Wi-Fi performance is maintained, while LTE-U's average gain is 40%

Indoor results from test cases SI5-8: 2 operators with 4 nodes per operator in one building, and 16 private WiFi APs, 4 channels of 40MHz. LTE-U uses R-10/11 with coexistence techniques. See the Technical Report for more details.

Simulated LTE-U and Wi-Fi Indoor Performance

Medium Density Scenario (SI1-4) from Technical Report

Median DL User Throughput

(2 deployments x 4 indoor small cells + 16 private Wi-Fi APs per building, 10x40MHz unlicensed spectrum)

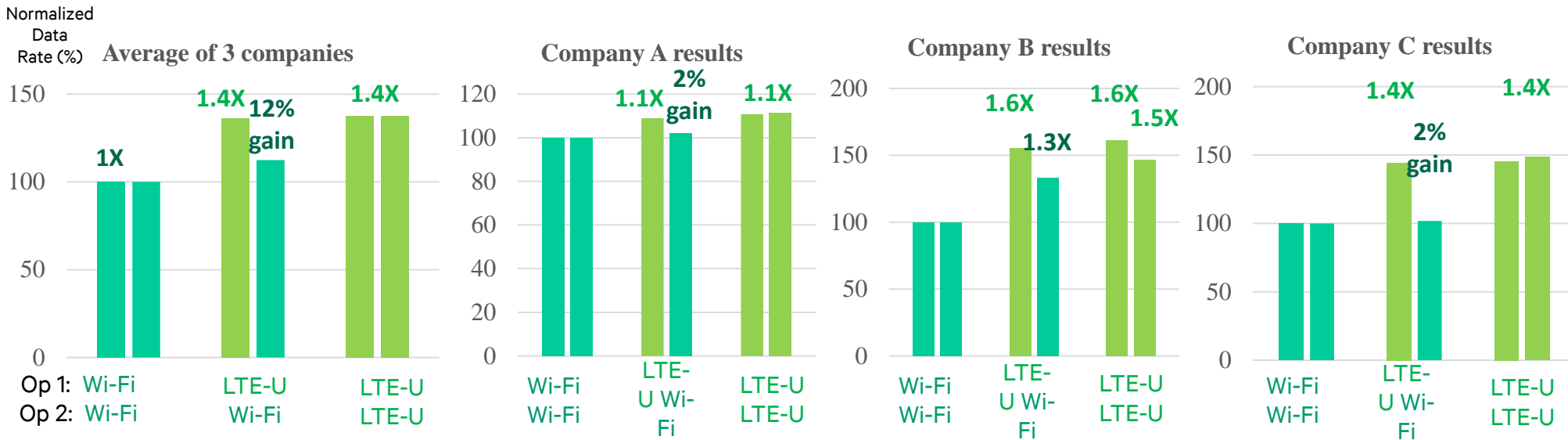

In this indoor LTE-U/Wi-Fi coex case, Wi-Fi performance is maintained, while LTE-U's average gain is 40%

Indoor results from test cases SI1-4: 2 operators with 4 nodes per operator in one building, and 16 private WiFi APs, 10 channels of 40MHz. LTE-U uses R-10/11 with coexistence techniques. See the Technical Report for more details.

Simulated LTE-U and Wi-Fi Indoor Performance (Tail Users)

Highlights of the Technical Report

5-percentile Tail DL User Throughput (2 deployments x 4 indoor small cells + 16 private Wi-Fi APs per building)

High Density (SI 5-8, 4x40MHz unlicensed spectrum)

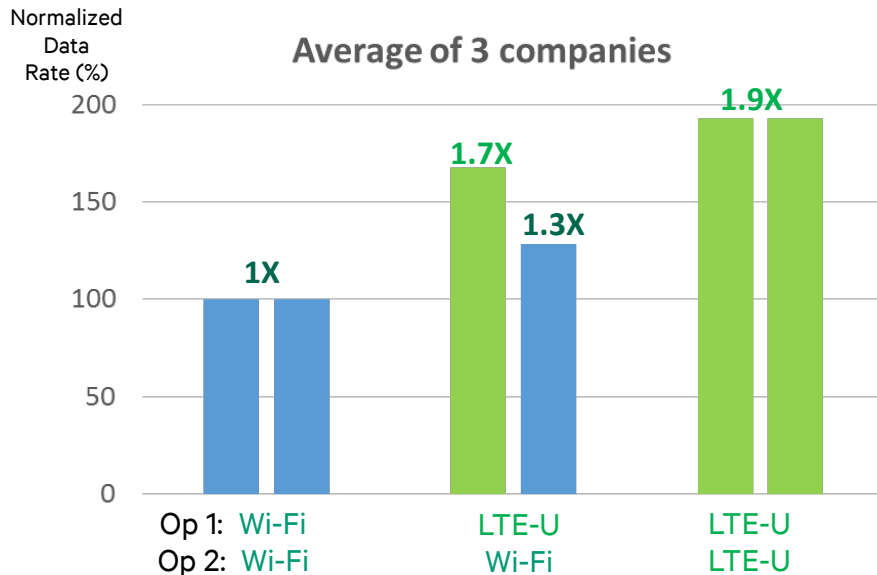

Medium Density (SO 1-4, 10x40MHz unlicensed spectrum)

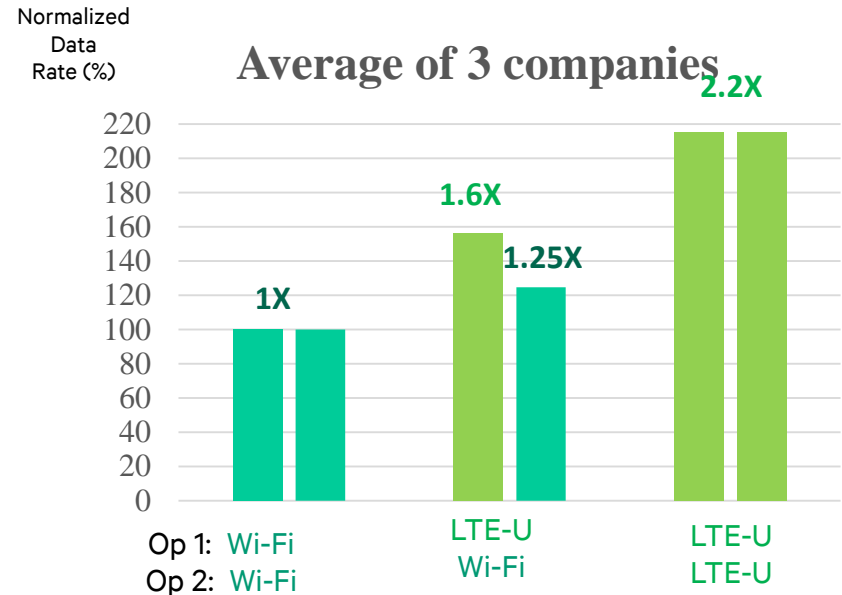

LTE-U delivers more gains to tail users while maintaining or improving Wi-Fi performance

Indoor results from test cases SI5-8 and SI1-4: 2 operators with 4 nodes per operator in one building, and 16 private WiFi APs, 4(SI5-8) or 10 (SI1-4) channels of 40MHz. LTE-U uses R-10/11 with coexistence techniques. See the Technical Report for more details.

SI5 (W+W), SI7(W+L), SI8 (L+L) - 4x40MHz, 4 nodes/op/cell+16private WiFi APs

Additional Statistics from Qualcomm Simulation: User throughput

- Arrival rate per user: 0.5MB burst every 0.45s (3GPP TM2) resulting in 70% WiFi network loading
- Almost 10 users per AP (almost 68% off-load on both)
- The performance of Wi-Fi in SI7 is same as Wi-Fi in SI5 and the performance of LTE-U in SI7 is 30% better than Wi-Fi in SI5 scenario
- Impact on the Operator Wi-Fi is marginal at the median however LTE-U improves the tail performance of Operator Wi-Fi (compared to Wi-Fi in SI5)

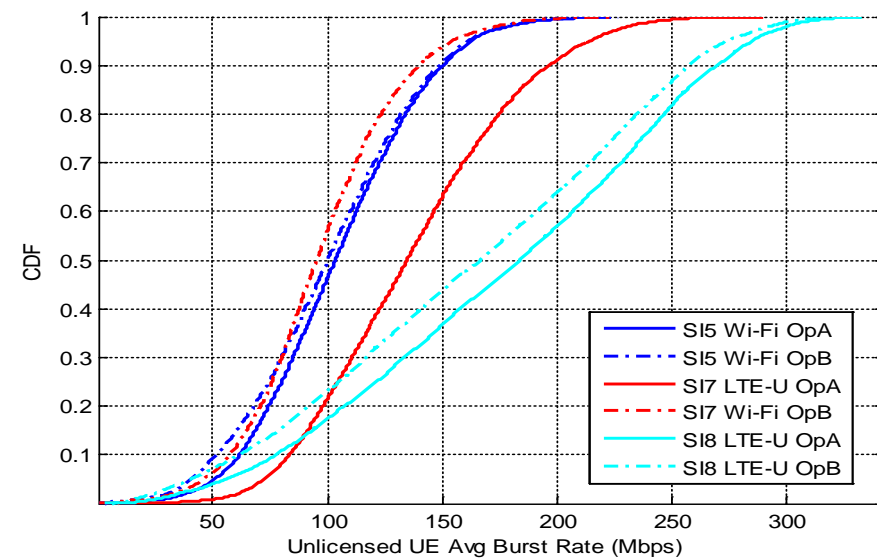

SI5 (W+W), SI7(W+L), SI8 (L+L) - 4x40MHz, 4 nodes/op/cell+16private WiFi APs

Additional Statistics from Qualcomm Simulation: Loading

Loading of WiFi is ~ 75%

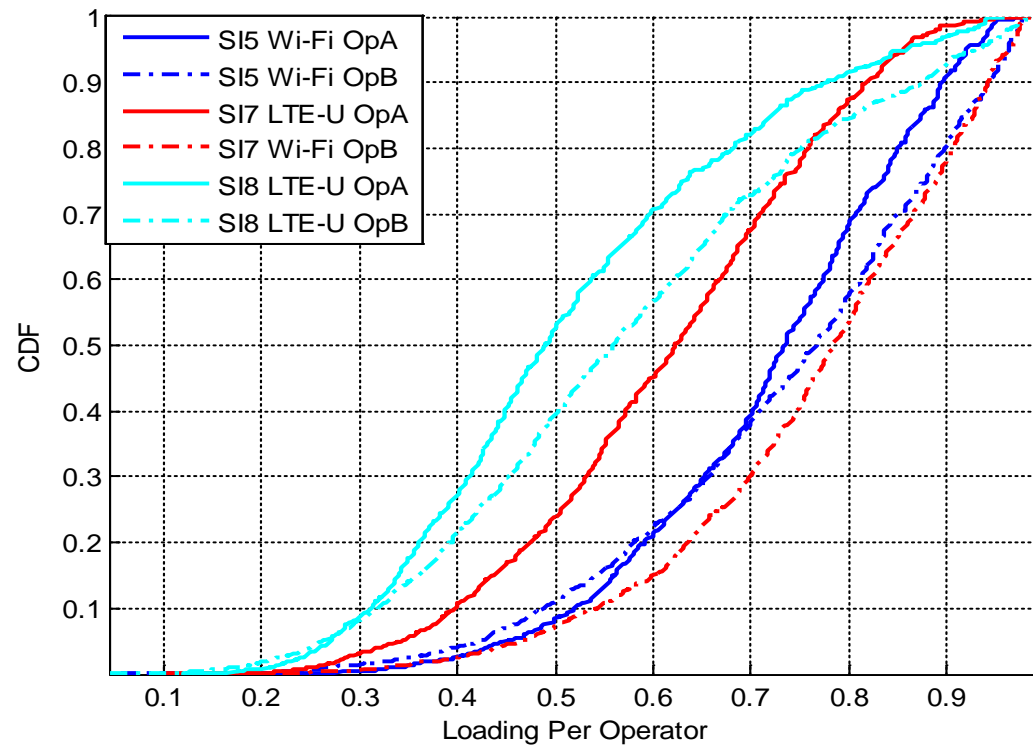

SI5 (W+W), SI7(W+L), SI8 (L+L) - 4x40MHz, 4 nodes/op/cell+16private WiFi APs

Additional Statistics from Qualcomm Simulation: Reuse & SINR

Observe that the congestion Metric of Operator Wi-Fi is improved with LTE-U as neighbor

No Impact on the Wi-Fi SINR as Wi-Fi backs off to LTE-U as LTE-U nodes happens to be within -62dBm (Result of ChS)

