

**Project: IEEE P802.15 Working Group for Wireless Personal Area Networks (WPANs)**

**Submission Title:** [Power delay profile measurement for THz communications link]

**Date Submitted:** [November 2024]

**Source:** [Hirokazu Sawada, Azril Haniz, Shingo Saito, Keizo Inagaki, Akifumi Kasamatsu, Norihiko Sekine and Takeshi Matsumura] Company [NICT]

Address [4-2-1, Nukui-Kitamachi, Koganei, Japan]

Voice:[+81-42-327-7324], E-Mail:[sawahiro@nict.go.jp]

**Re:** [N/A]

**Abstract:** [This document presents the measurement results of the power delay profile in a data center and an outdoor environment, and also presents the analytical results of the characterization of the power delay profile.]

**Purpose:** [Information document for IEEE 802.15 SC THz]

**Notice:** This document has been prepared to assist the IEEE P802.15. It is offered as a basis for discussion and is not binding on the contributing individual(s) or organization(s). The material in this document is subject to change in form and content after further study. The contributor(s) reserve(s) the right to add, amend or withdraw material contained herein.

**Release:** The contributor acknowledges and accepts that this contribution becomes the property of IEEE and may be made publicly available by P802.15.

# Power delay profile measurement for THz communications link

Hirokazu Sawada, Azril Haniz, Shingo Saito,  
Keizo Inagaki, Akifumi Kasamatsu, Norihiko  
Sekine and Takeshi Matsumura

NICT, Japan

# Abstract

- Measurement results of the power-delay profile in a data center and an outdoor environment are introduced.
- Analytical results of the characterization of the power-delay profile are also reported.

# Measurement System

- The operating principle is to use a network analyzer to transmit and receive frequency-swept radio signals, measure the transfer function in the frequency domain, and then perform a Fourier transform to obtain the power delay profile.

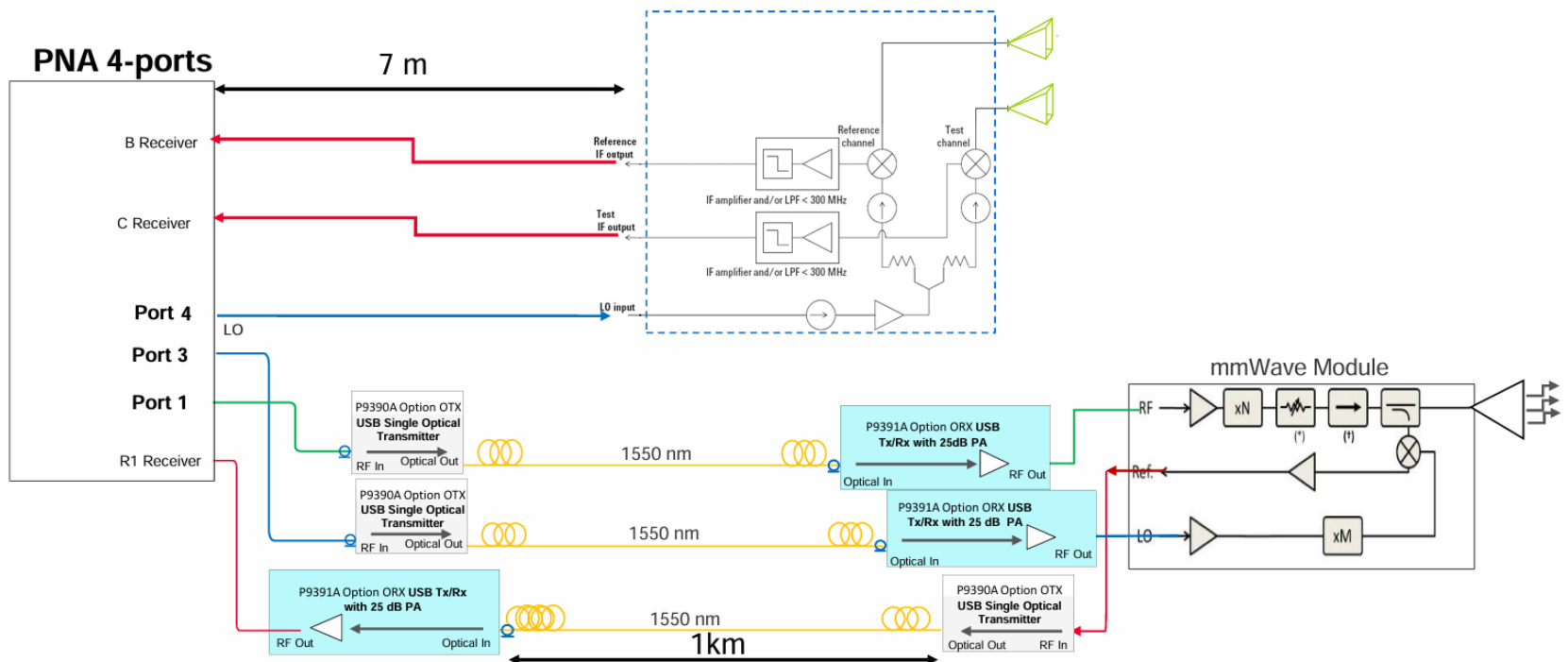

# Measurement Setup

- Measurements were performed under the conditions shown in the table, with the transmitter fixed and the receiver moved.

<b>Environment</b>	<b>Data center (Indoor)</b>	<b>Rual (Outdoor)</b>
Frequency	286.94 - 291.94 GHz, 289.44 - 291.6 GHz, 306.72 - 308.88 GHz	
Output power	2 dBm	
Antenna/Gain	Omni. / 3 dBi	
TX and RX ant. Config.	TX: Omni., RX: Omni.	
TX ant. Height	20 cm above racks	1.5 m
RX ant. Height	20 cm above racks	1.5 m
Distance	< 20 m (on racks)	0.5 - 300m

# Measurement in outdoor environment

- The photo shows the delay profile measurement setup in an outdoor environment.
- Measurements were conducted in LoS situation, where on well-open road with few buildings in the vicinity as shown in the map.

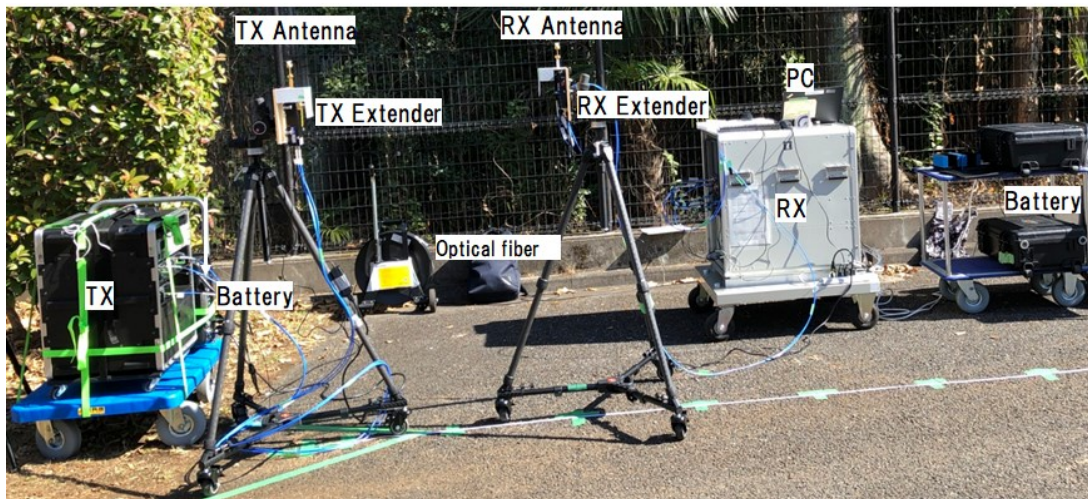

Outdoor measurement photo

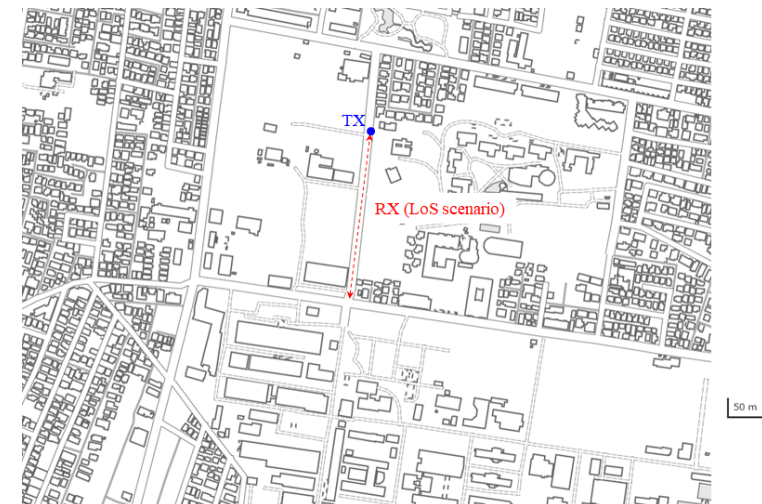

Outdoor environment map

# Power delay profile in outdoor environment

- A delayed wave was received 5.5 ns later than the main wave with maximum amplitude and attenuated by 20 dBc, and it can be seen that the effect of the delayed wave is small.

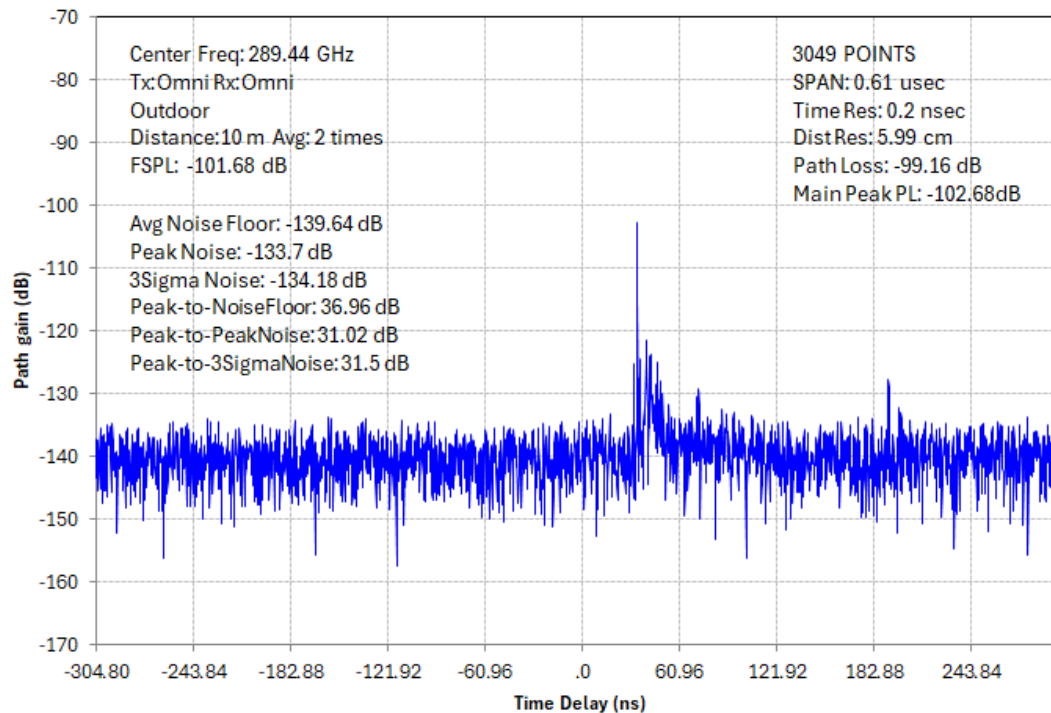

# Path loss results in outdoor environment

- Figure shows the propagation loss calculated from the total received power, and it can be seen that the attenuation is about 3 dB smaller on average than the free space loss due to the reception of delayed waves other than the direct wave.

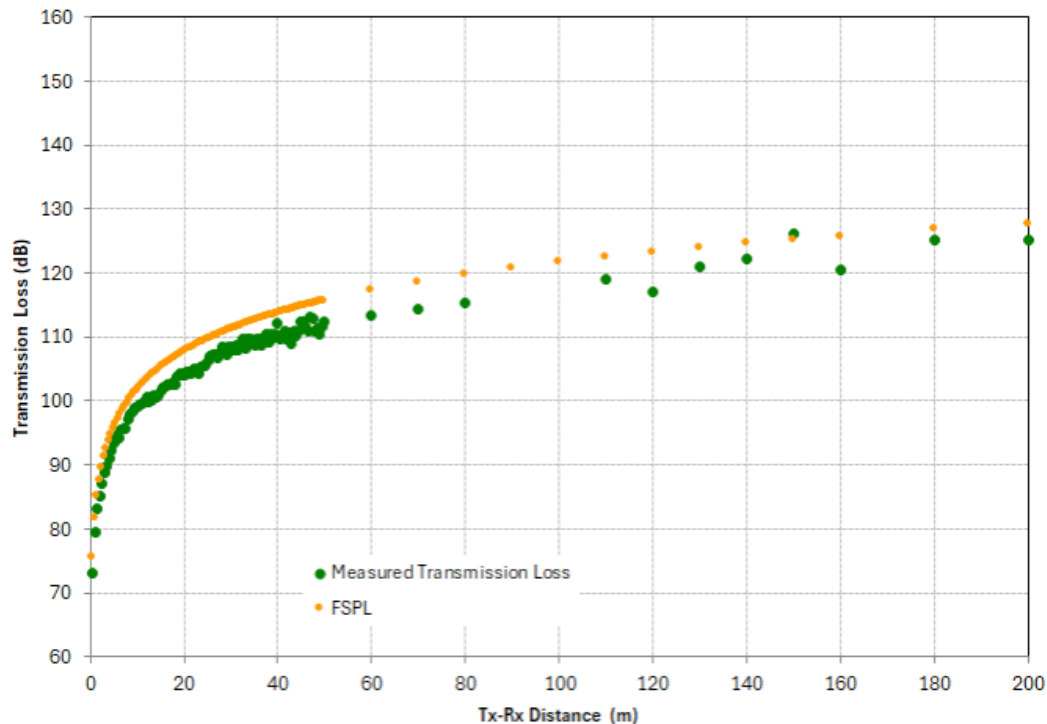



# Measurement in data center environment

- TX and RX omnidirectional antennas were placed above the server rack.
- Measurements were also taken with the receiving antenna placed in different positions on the server racks.



Data center measurement photo

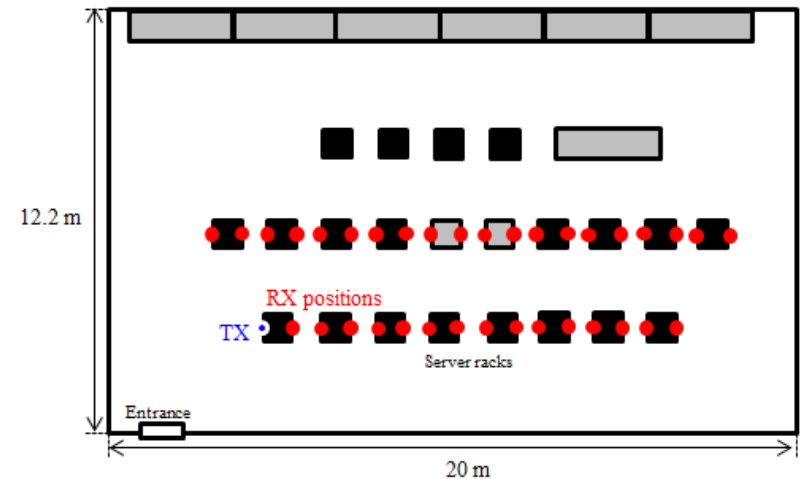

Data center environment

# Power delay profile in data center environment

- In the data center environment, the antenna is installed close to the ceiling, so reflected waves from the walls and ceiling of the room arrive as delayed waves with large amplitudes.

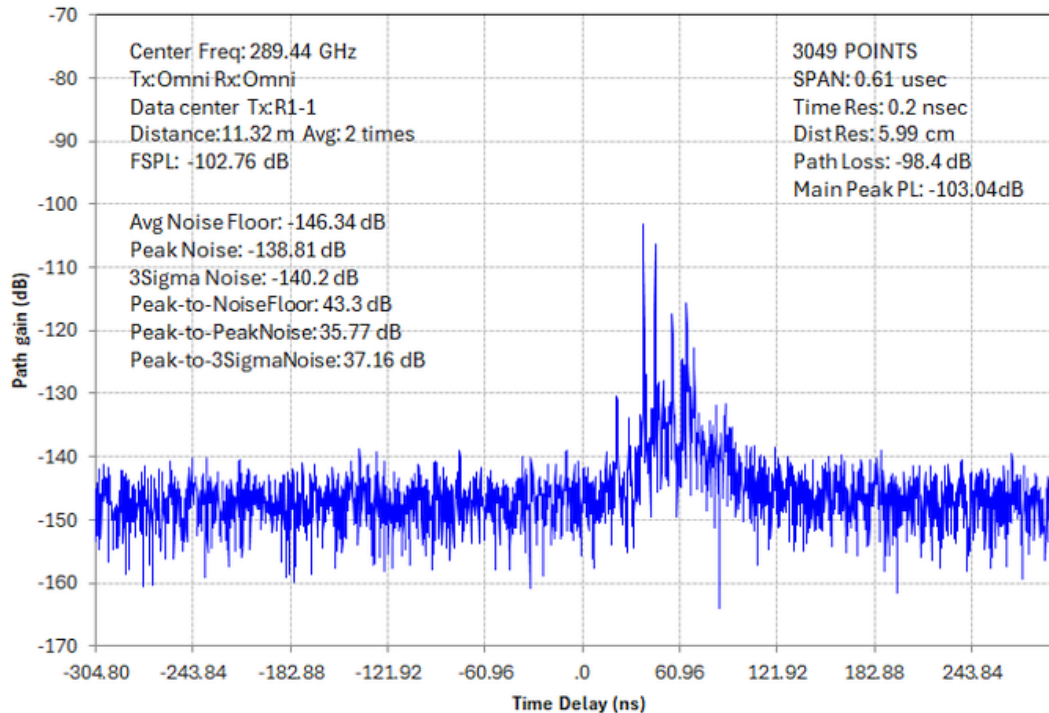

# Path loss in data center environment

- Although there is a larger fluctuation than in the outdoor environment, the attenuation is smaller than the free space loss.

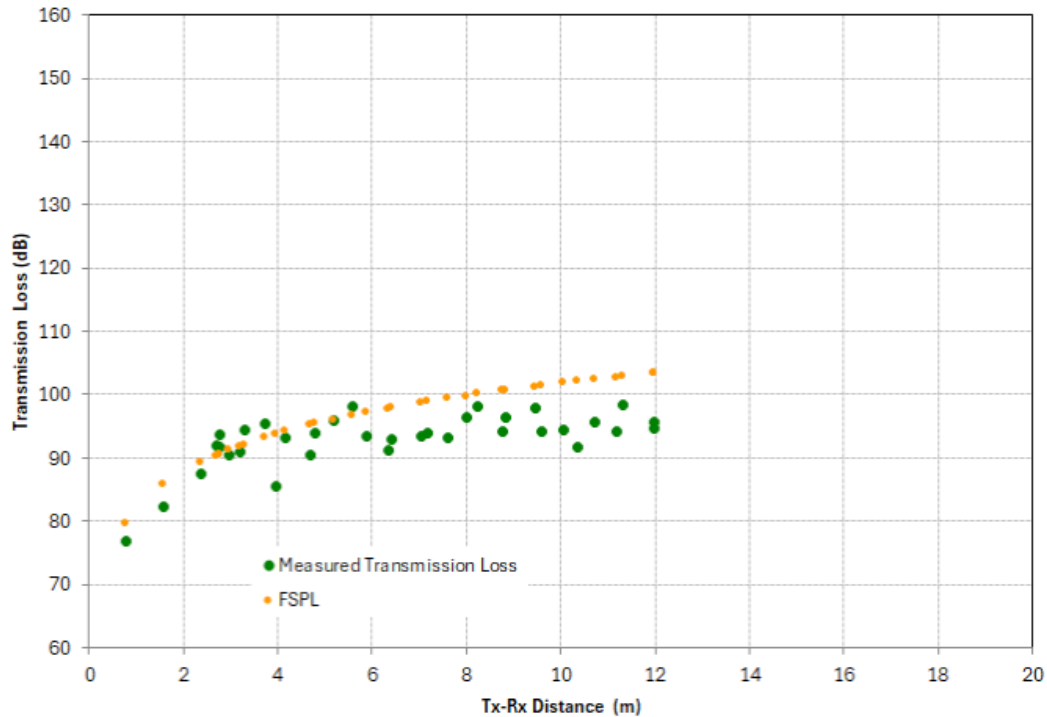

# Characterization of power delay profile results

- CDF results of calculating the delay spread ( $\tau_{rms}$ ) using the following formula from the delay profiles are obtained.

$$\tau_{rms} = \sum_k \frac{(\tau_k - \tau_\mu)^2 p_k}{\sum_k p_k} \quad (1)$$

$$\tau_\mu = \sum_k \frac{\tau_k p_k}{\sum_k p_k} \quad (2)$$

- where,  $p_k$  is the amplitude of the delay profile, and  $\tau_k$  is the delay time. The signals included in the delay spread calculation were -15, -20, -25, and -30 dB threshold from the peak power of the received wave, and also 10 dB higher than the noise floor.

# Delay spread in outdoor environment

- The delay spread was small, 0.82 ns at 50% and less than 2 ns at 90% when the threshold was set to 20 dB down from the peak at 289 GHz.

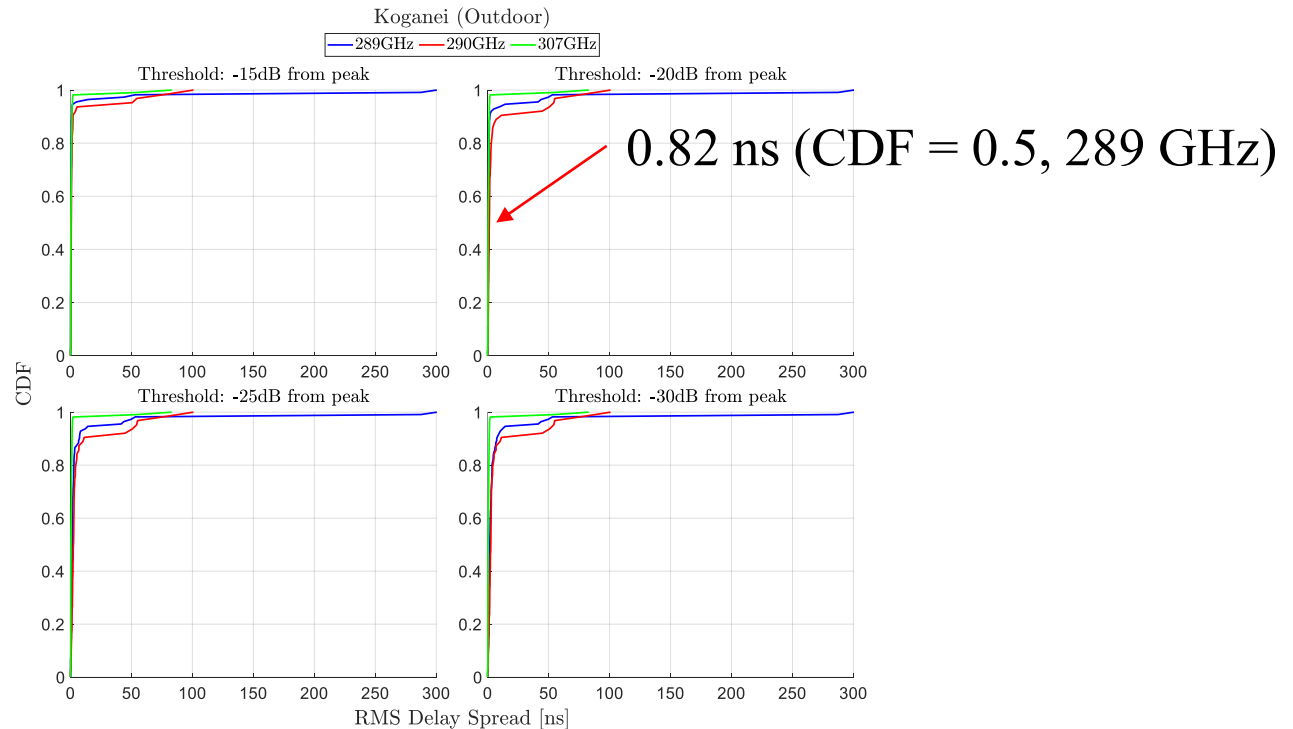

# Delay spread in data center environment

- The delay spread was larger than the outdoor environment, and when the threshold was set to -20 dB down from the peak, the delay spread was 2.7 ns at 50% and 6.4 ns at 90% at 289 GHz.

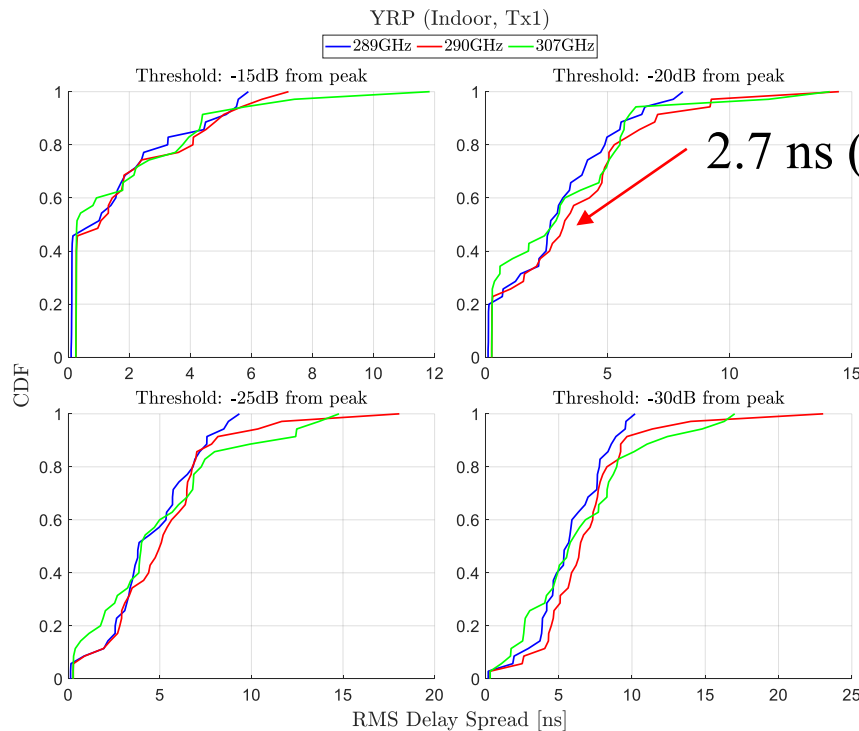

# Summary

- In the outdoor environment, the received power was close to the free space characteristics, and in the indoor environment, the transmission loss was smaller in the data center.
- In addition, the delay spread is analyzed to evaluate the delay profile characteristics.
- As a future challenge, it will be necessary to analyze the correlation bandwidth from the delay spread and determine the appropriate communication bandwidth and modulation method per channel.