

Project: IEEE P802.15 Working Group for Wireless Personal Area Networks (WPANs)

Submission Title: THz-band indoor network based on photonics technology

Date Submitted: July 11, 2023

Source: Seung-Hyun Cho, Sang-RoK Moon, Eon-Sang Kim, Wonkyoung Lee, Minkyu Sung, Sooyeon Kim, ETRI
218, Gajeong-ro, Yuseong-gu, Daejeon, 34129, Republic of Korea
Telephone: +82-42-860-5721, E-Mail: shc@etri.re.kr

Re: n/a

Abstract: This contribution describes a few demonstrations that configures terahertz-band (@300GHz) indoor network based on photonics technology reported by ETRI so far.

Purpose: Information of SC_THz

Notice: This document has been prepared to assist the IEEE P802.15. It is offered as a basis for discussion and is not binding on the contributing individual(s) or organization(s). The material in this document is subject to change in form and content after further study. The contributor(s) reserve(s) the right to add, amend or withdraw material contained herein.

Release: The contributor acknowledges and accepts that this contribution becomes the property of IEEE and may be made publicly available by P802.15.

THz-band indoor network based on photonics technology

Seung-Hyun CHO, Sang-RoK MOON, Eon-Sang KIM, Wonkyoung LEE, Minkyu SUNG, Sooyeon KIM

Technology Pioneer Making Happy Future
through Digital Innovation



July, 11, 2023

Outlines

Why do we need a THz-band Communications?

Is it necessary to use photonics technology for THz transmission?

How to realize THz transmission systems

What will we prepare for THz-band indoor network?

Summary





Why do we need a THz-band communications?

The advent of the 6G era

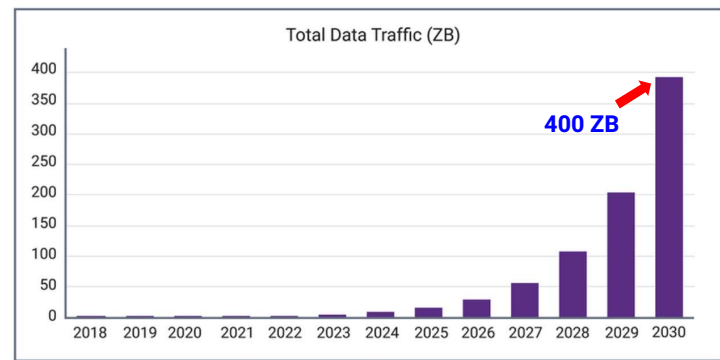

Explosive growth in data traffic by 2030

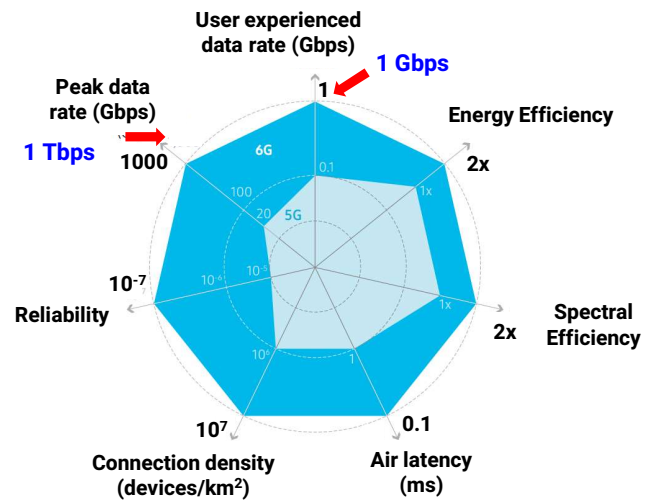

Enhancement of key requirements form 5G to 6G

Ref.: Total Data Traffic Forecast through 2030. Source: "Impact of AI on Electronics and Semiconductor Industries", IBS, April 2020. & White paper "6G the next hyper-connected experience for all, Samsung Research, 2020.

Candidate band for 6G

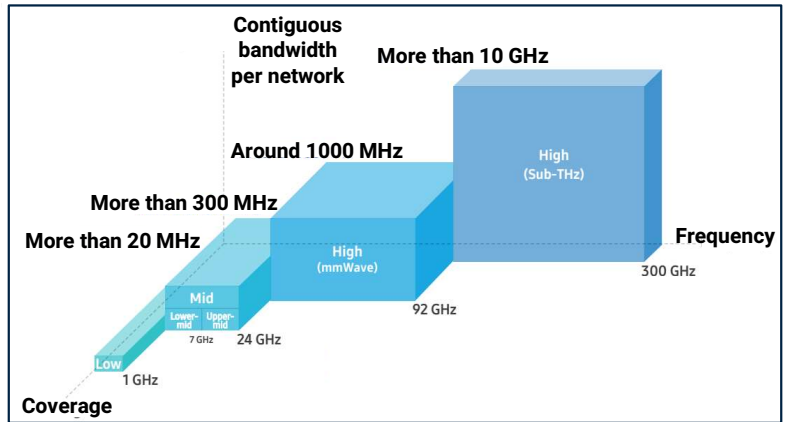

Dimension of 6G spectrum grouping

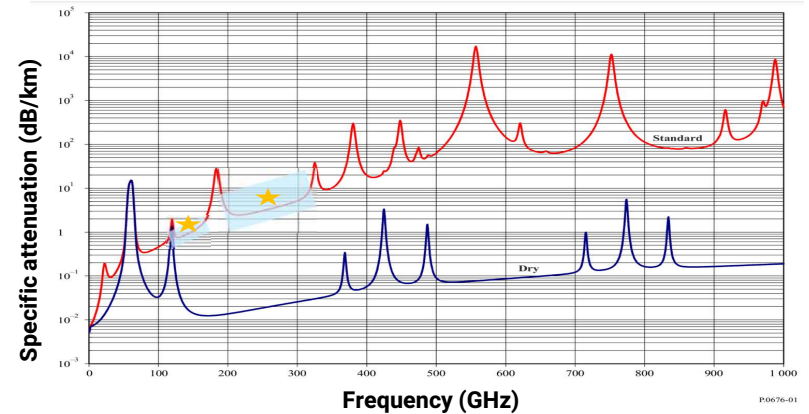

Specific attenuation due to atmospheric gases, calculated at 1 GHz intervals, including line centres

Ref.: White paper "6G the next hyper-connected experience for all, Samsung Research, 2020. & ITU-R P.676-6: Attenuation by Atmospheric Gases (ITU, 2022)

Why do we need a THz-band communications?

Expected key 6G services (hyper-reality)



Truly immersive XR



3D hologram display over mobile devices

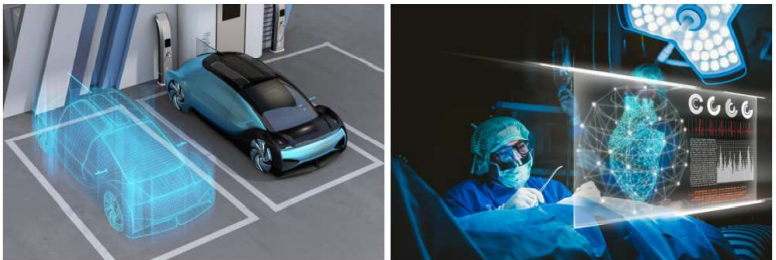

Digital replica: bridge the real and virtual worlds

Ref.: White paper "6G the next hyper-connected experience for all, Samsung Research, 2020.

Required data throughput for 3D hologram

Bandwidth requirement will grow up to Tbps for holographic telepresence applications

	Dimensions	Bandwidth
Tile	10 x 10 cm	30 Gb/s
Human	195 x 50 cm	4.62 Tb/s

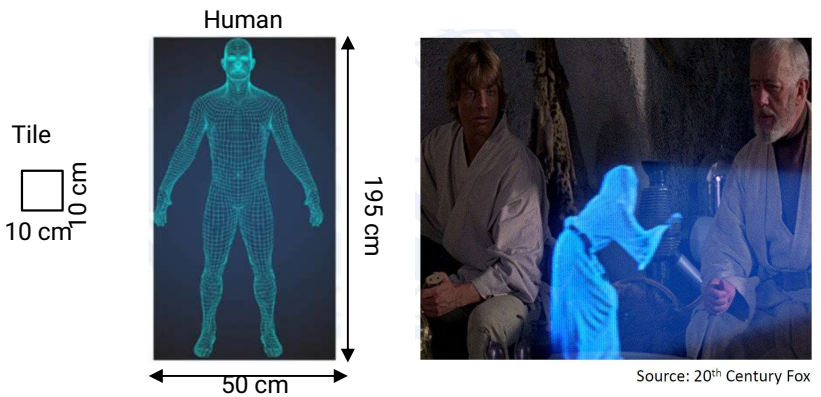

Ref. : R. Li et al., "Towards a new internet for the year 2030 and beyond," 3rd annual ITU-IMT 2020/5G Workshop on Demo Day, July, 2018.

Why do we also need a THz-band indoor network?



~80% of mobile data occurs indoors



Ref.: A global leader in infrastructure solutions for communications networks, CommScope, 2020. & "Microsoft introduces the world to 'holoportation'" in Techradar 2016.

THz transmission suitable for indoor application

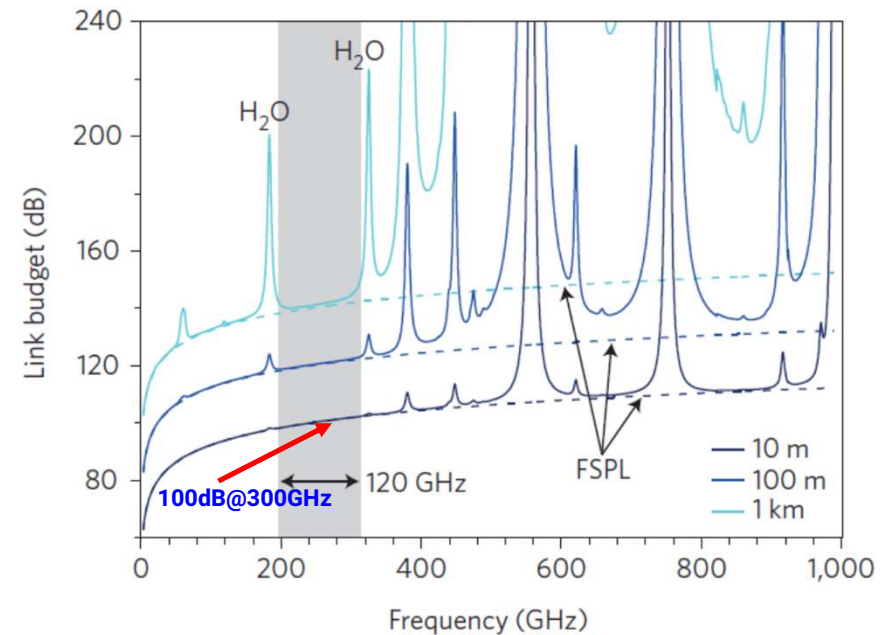

Link budget at THz frequencies for the isotropic case at 23 °C and 2.59% water content in air composition (tropical climate)

Ref : T. Nagatsuma et al., "Advances in terahertz communications accelerated by photonics," Nature Photonics 10, 371 (2016).

Is it necessary to use photonics technology for THz transmission?

THz transmission based on electronics

❖ THz Transmitter

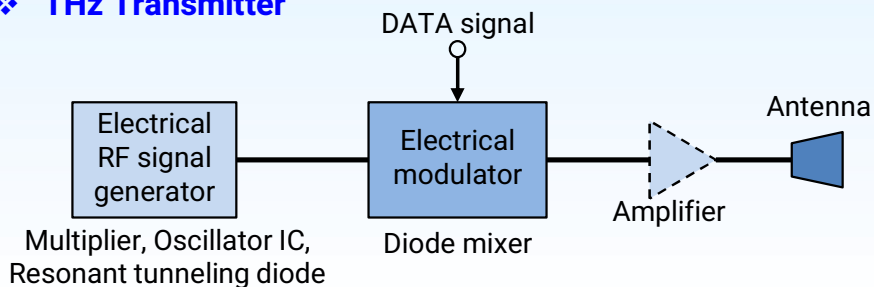

❖ THz Receiver

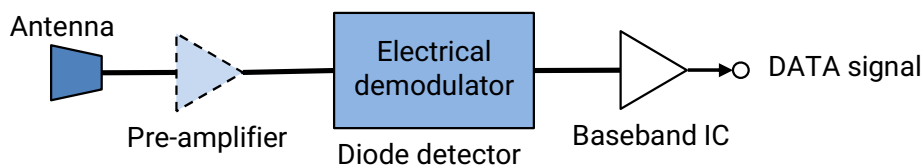

- Available frequency: < 300GHz (III-V & Si)
- Max. data rate: 120Gb/s (III-V & Si)@300 GHz
- Max. transmission distance: 10m)@300 GHz (III-V, 50dBi antenna + THz amp)

- Easy to **miniaturize, integrate, low-power consume**
- Utilizing **matured III-V semiconductor fab. process**
- Need to overcome **SNR degradations caused by frequency multiplier chain**

Ref.: Tadao Nagatsuma et al., "Recent progress and future prospect of photonics-enabled terahertz communications research," IEICE Trans. Electron. vol. E98-C, no.12, pp. 1060, 2015.

THz transmission based on photonics

❖ THz Transmitter

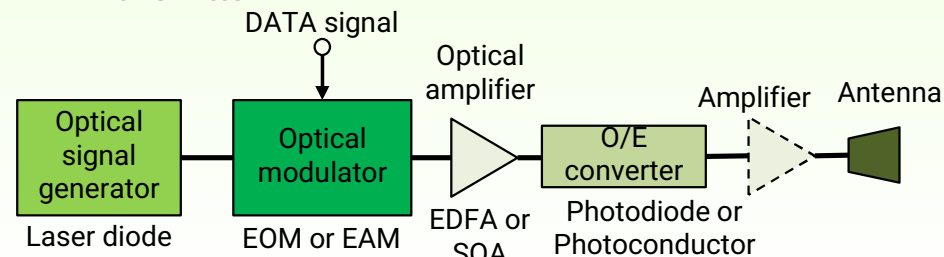

* EOM: Electro-Optic Modulator, EAM: Electro-Absorption Modulator

❖ THz Receiver

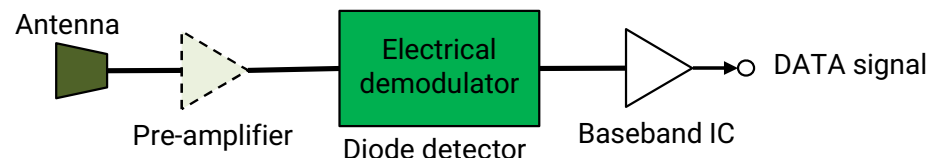

- Available frequency: < 1THz
- Max. data rate: 110Gb/s (Single ch.), 600Gb/s (Multi-ch. PDM)@300 GHz
- Max. transmission distance: 110m@300 GHz (w THz amp)

- Utilizing **matured optical communication technology** with ultra-wideband and low-loss characteristics
- Easy to **get relatively high SNR and extend coverage**
- Need a effort to **miniaturize, integrate, low-power consume** by using a **PIC technology**

Ref.: Tadao Nagatsuma et al., "Advances in terahertz communications accelerated by photonics," Nature Photonics, vol. 10, pp. 371, 2016.

Is it necessary to use photonics technology for THz transmission?

Data rate vs. carrier frequency

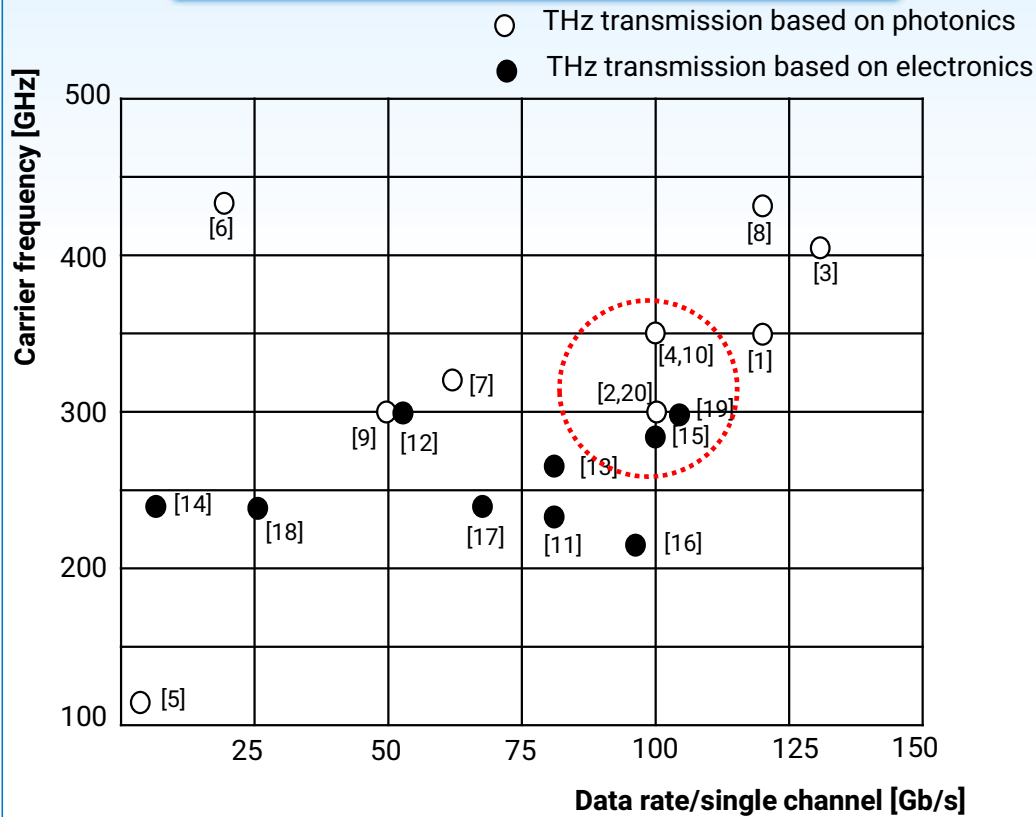

- Many reports of 100Gb/s near 300 GHz.
- Still photonics technology better than electronics technology.
- Careful consideration should be needed for various applications.

Ref.: Please see the summarized table in the next slide

Data rate vs. transmission distance

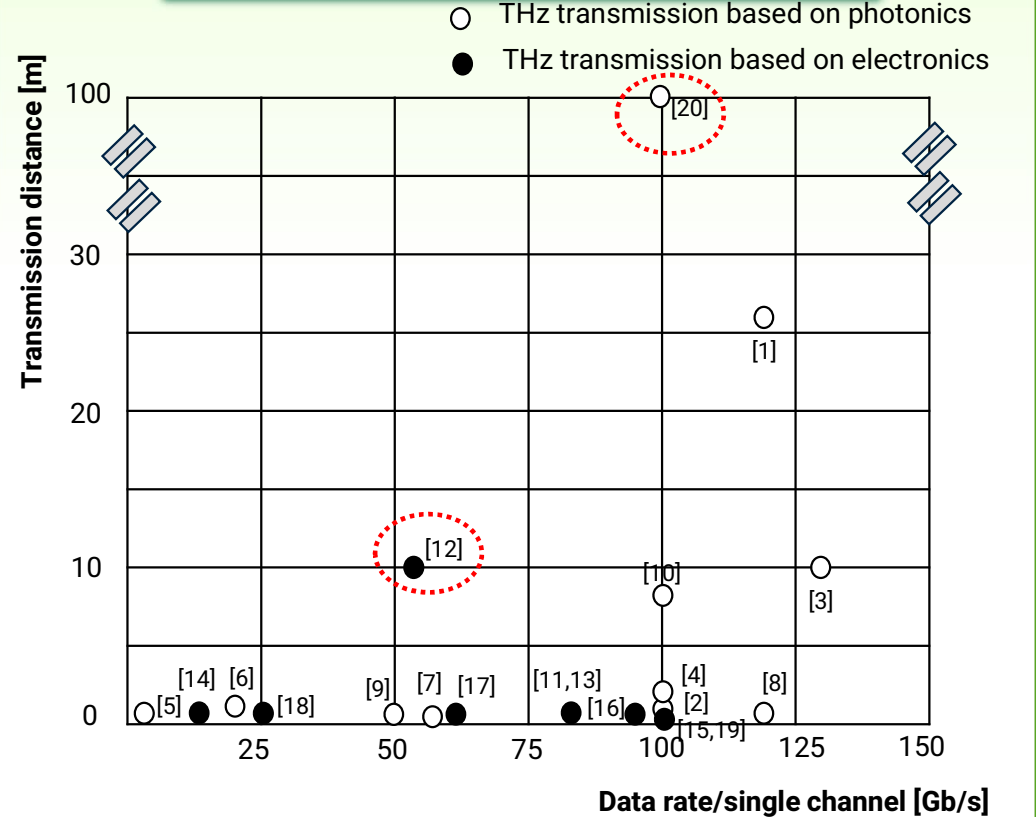

- Transmission distance of less than 1m at various data rate.
- The best result was 132Gb/s-110m.
- Still need to extend transmission distance (coverage).

References for previous slide



[1]	Probabilistic shaping for better spectral efficiency	350 GHz	120 Gb/s	PS-16QAM-OFDM	26.8 m	2020	Zhejiang Univ.
[2]	Real-time digital coherent optical modem	300GHz	100 Gb/s	PDM-QPSK	0.5m	2020	HHI
[3]	Integrated Dual- λ DFB LDs & Probabilistic shaping	408 GHz	131 Gb/s	16QAM-OFDM	10.7 m	2019	DTU
[4]	Enhanced UTC-PD	350 GHz	100 Gb/s	16QAM	2 m	2018	Zhejiang Univ.
[5]	DFB-LD based commercial optical transceiver	138 GHz	5.5 Gb/s	NRZ-OOK	1.5m	2018	Polytechnique Montréal
[6]	Six-channel WDM/PDM-QPSK	437.5 GHz	120 Gb/s (6x20 Gb/s)	QPSK	10-km SMF 142 cm wireless	2018	DTU
[7]	Coherent THz-over-Fiber architecture	325 GHz	59 Gb/s	64QAM-OFDM	2 km SMF 5 cm wireless	2017	Univ. of Duisburg
[8]	Coherent transmission using optical frequency comb	425 GHz	120 Gb/s (net: 106 Gb/s)	16QAM	50 cm wireless	2017	Zhejiang Univ.
[9]	Si Photonics	300 GHz	40 Gb/s	NRZ	2 m	2022	ETRI
[10]	THz repeater	300 GHz	100 Gb/s	16-QAM	8 m	2022	ETRI
[11]	0.13 μ m SiGe HBT	220~260 GHz	81 Gb/s	64-QAM	1 m	2019	IHCT, Univ. of Wuppertal
[12]	35 nm InGaAs mHEMT	285-315 GHz	56 Gb/s	16-QAM	10 m	2019	Univ. of Stuttgart
[13]	40 nm CMOS	265.68 GHz	80 Gb/s	16-QAM	0.03 m	2019	Hiroshima Univ.
[14]	130 nm SiGe BiCMOS	240 GHz	15.6 Gb/s	16-QAM	0.15 m	2019	IHP
[15]	80-nm InP HEMT	272-302 GHz	100 Gb/s	16-QAM	2.22 m	2018	NTT
[16]	0.13 μ m SiGe HBT	230 GHz	90 Gb/s	16-QAM	1 m	2018	IHCT, Univ. of Wuppertal
[17]	0.13 μ m SiGe HBT	225-255 GHz	65 Gb/s	4-QAM	1 m	2018	IHCT, Univ. of Wuppertal
[18]	130 nm SiGe BiCMOS	240 GHz	25 Gb/s	BPSK	0.15 m	2018	IHP
[19]	40 nm CMOS	300 GHz	105 Gb/s	32-QAM	No air transmission	2017	Hiroshima Univ.
[20]	KK SBD Rx, THz amplifiers	300 GHz	100 Gb/s	QPSK	110 m	2018	KIT

How to realize THz transmission systems



Architectures of THz transmission technology based on photonics

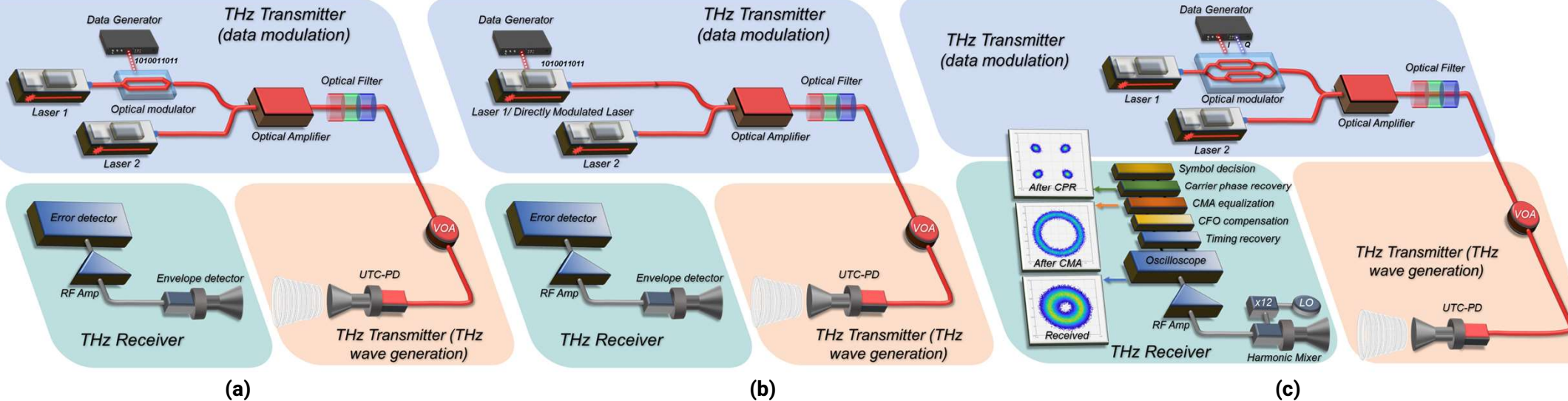

(a) External modulation/incoherent detection

- **Conventional approach** using external optical intensity modulator and laser diodes.
- Up to **40Gb/s** data rate.
- Cost-effective SBD-based receiver was employed for envelope detection.

(b) Direct modulation/incoherent detection

- **Cost-effective solution** using directly modulated laser diode as a data modulator.
- Up to **25Gb/s** data rate.
- To extend the transmission distance and data rate, **adiabatic chirp management skill** was utilized.

(c) Optical IQ modulation/coherent detection

- **Filed modulation using optical IQ modulator** and coherent detection using **THz mixer based receiver**.
- Up to **120Gb/s** data rate.
- Easy to increase **data rate & transmission distance**.
- Relatively **expensive** implementation.

How to realize THz transmission systems



External modulation/incoherent detection scheme

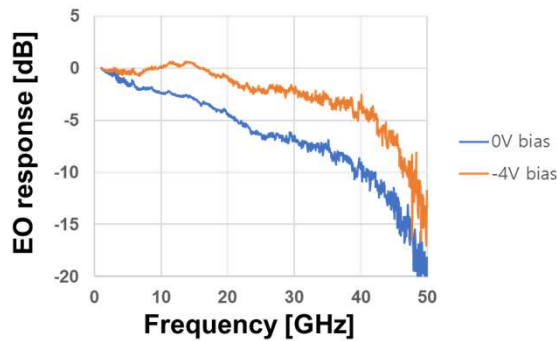
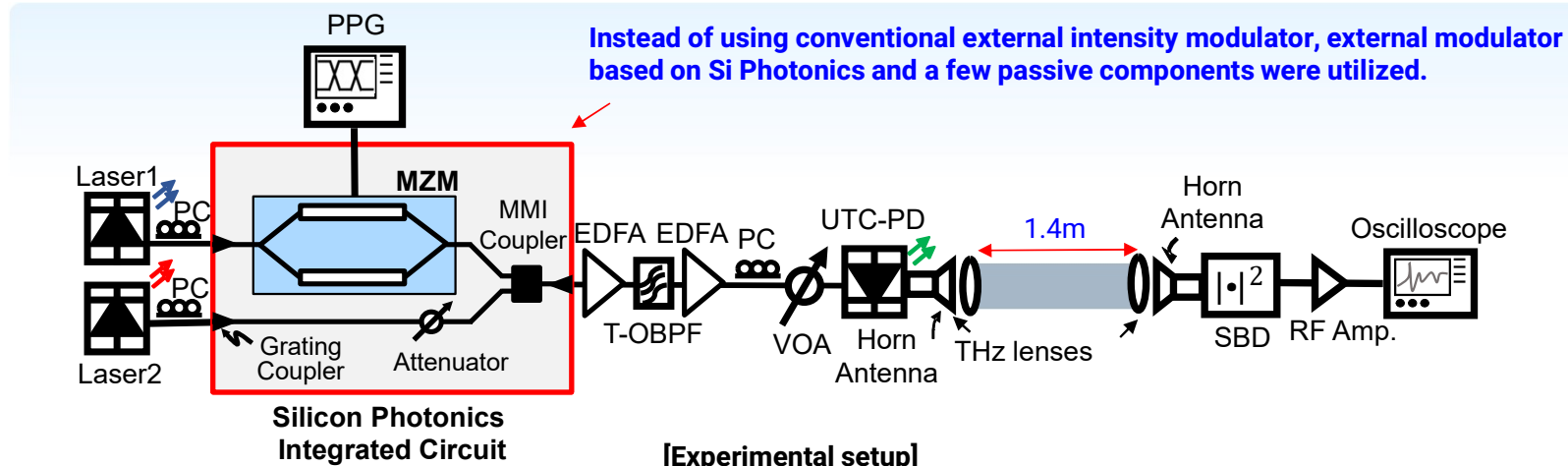

[Measured EO responses of MZM based on SiP]

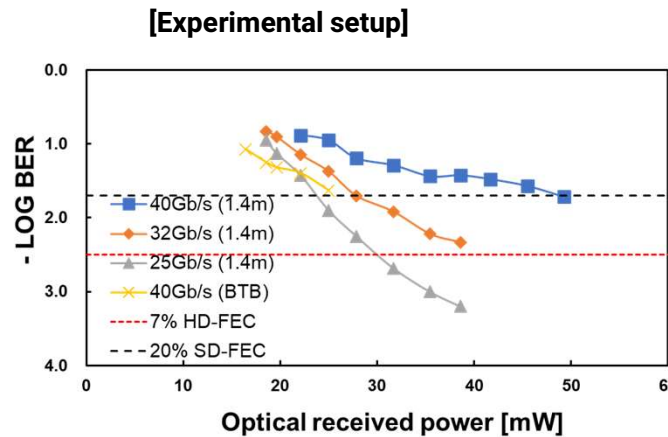

[Measured BERs by varying data rate w/o DFE]

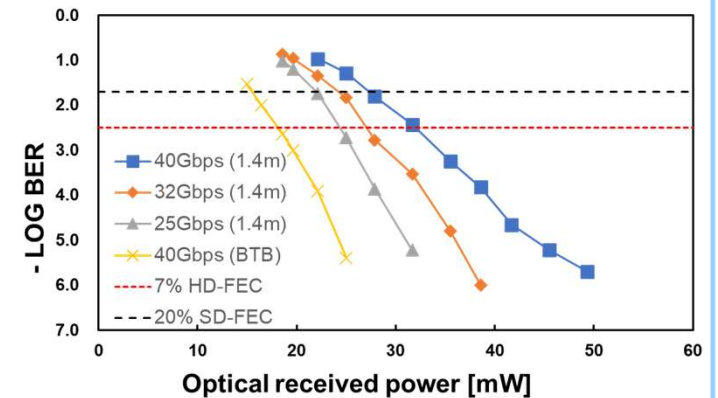

[Measured BERs by varying data rate w/ DFE]

How to realize THz transmission systems



Direct modulation/incoherent detection scheme

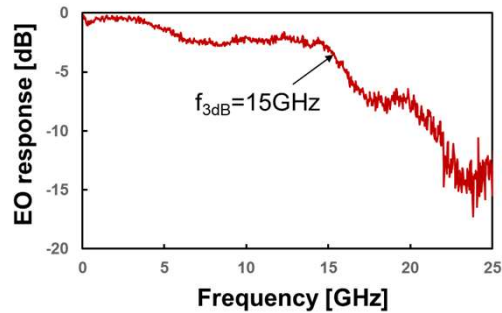
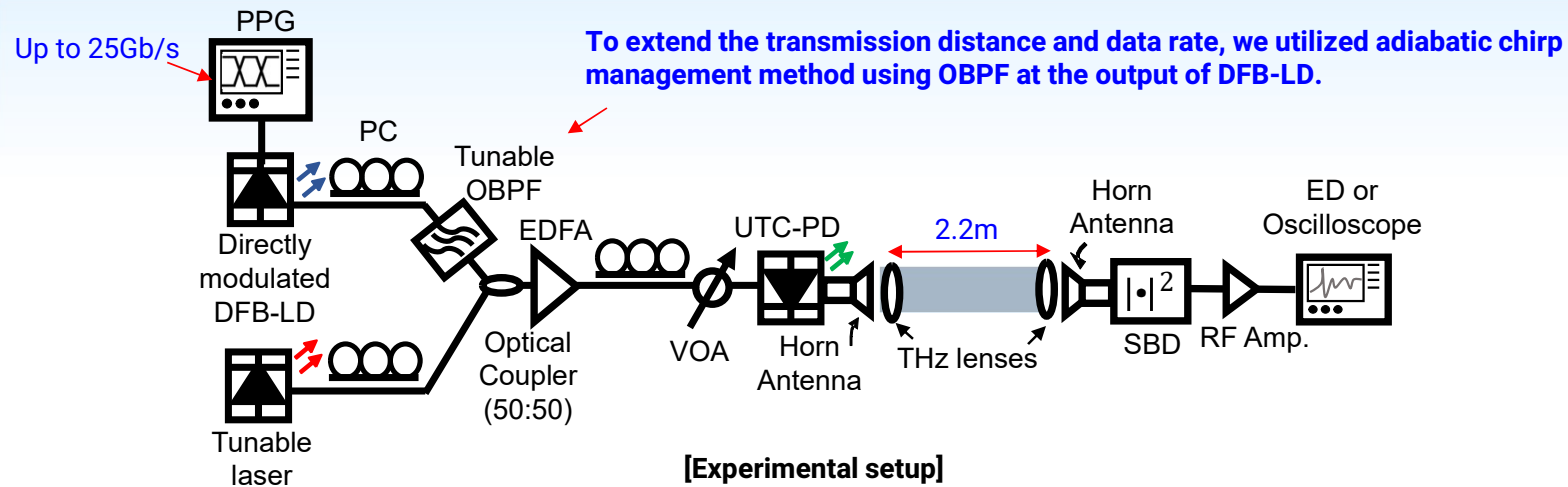

[Measured EO response of DFB-LD]

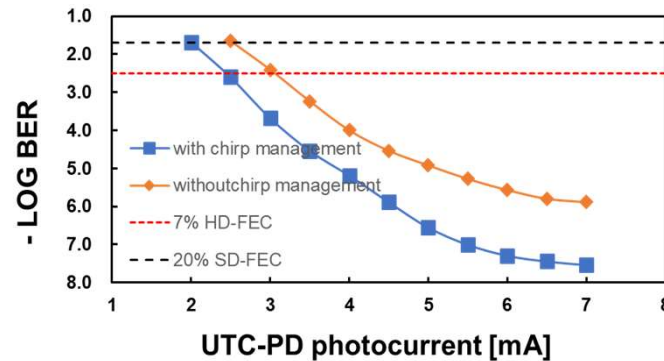

[Measured BERs with and without chirp management]

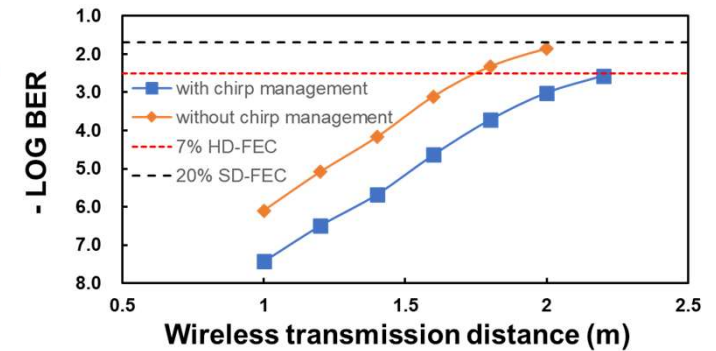

[Measured BERs by varying transmission distance]

How to realize THz-band indoor network

Optical IQ modulation/coherent detection scheme

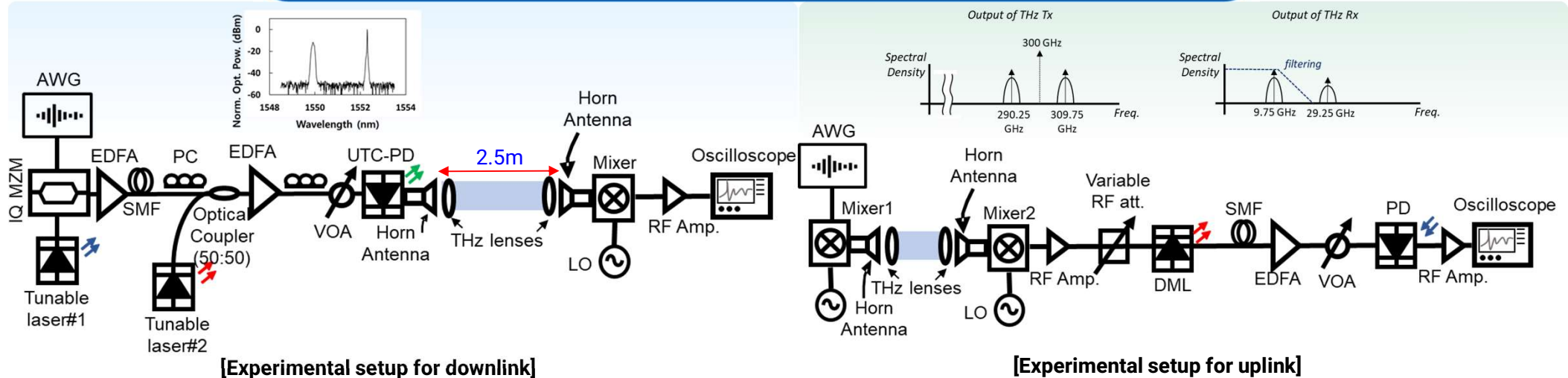

[Experimental setup for downlink]

[Experimental setup for uplink]

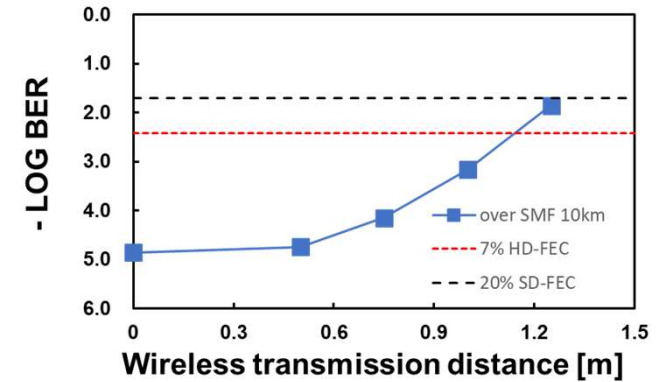
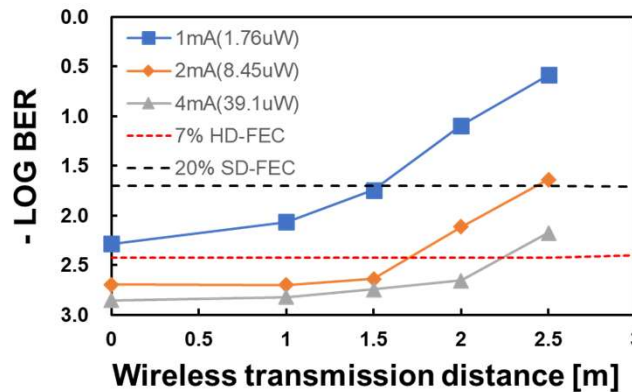
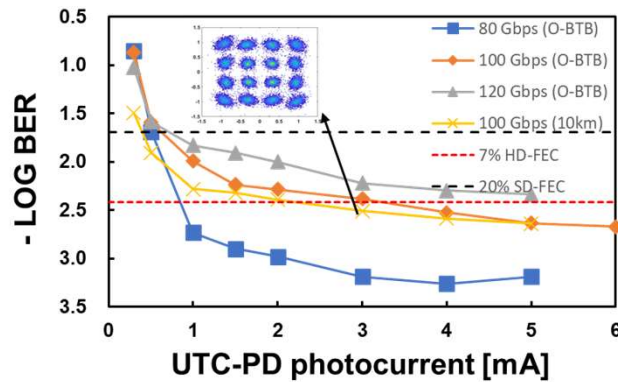

[Measured BERs by varying data rate for downlink] [Measured BERs by varying tr. distance for downlink]

[Measured BERs by varying tr. distance for uplink]

How to realize THz-band indoor network



THz-band amplifier (using 250nm InP HBT process)

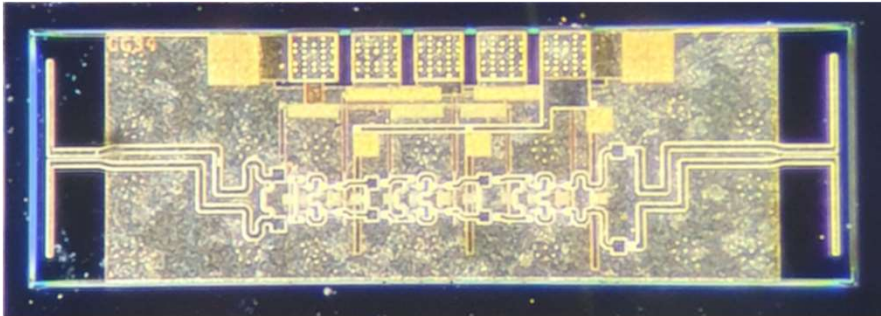

[THz-band amplifier IC with waveguide transition]

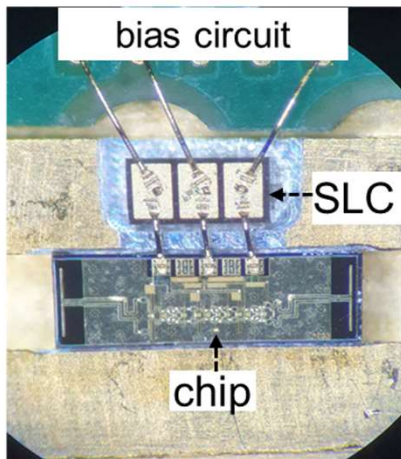

[Assembled module of THz-band amplifier]

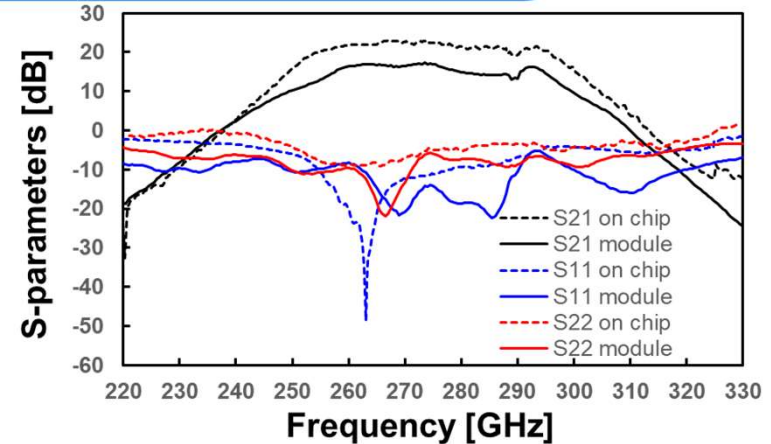
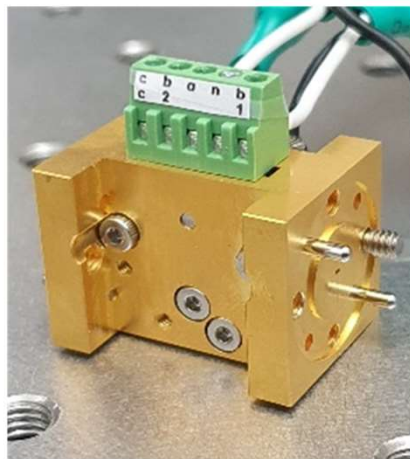

[Measured S-parameters for THz-band amplifier IC and module]

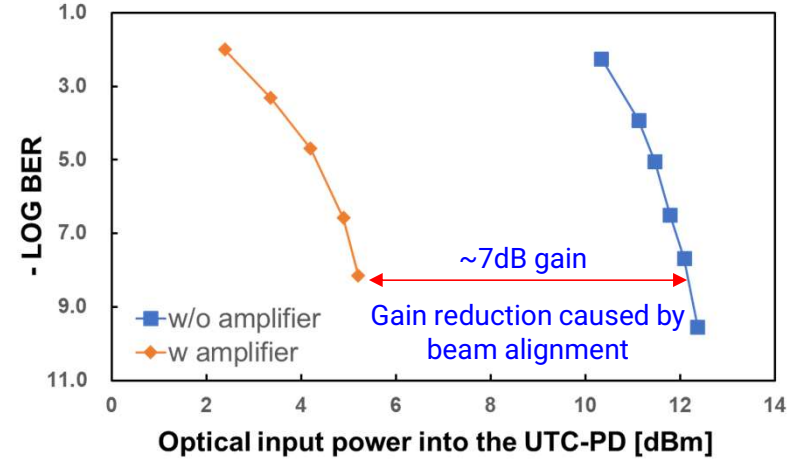

[Measured BER characteristics w&wo THz-band amplifier (NRZ-10Gb/s)]

Technical challenges



Improvement of output power

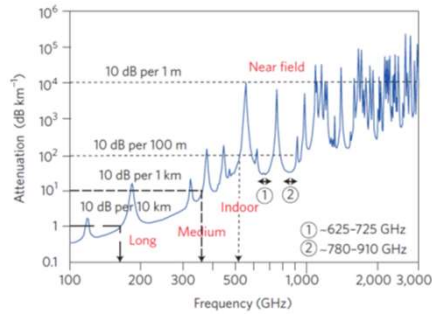

THz-band attenuation

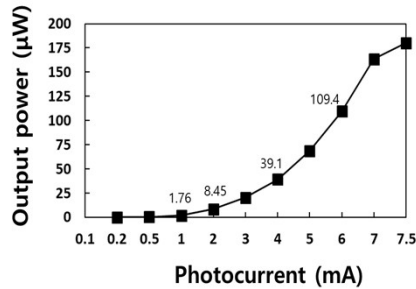

UTC-PD output power

Size (form factor) Reduction

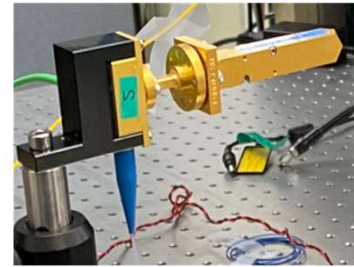

UTC-PD w/ horn antenna

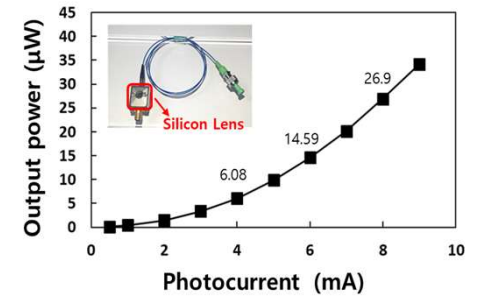

Lens type UTC-PD & power

Photonic Integration

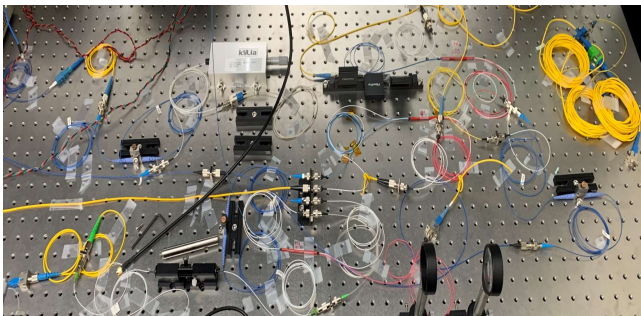

THz signal generator using fiber-optics: 2m x 1m

THz signal generator using PIC (expectation)
: 10 mm x 14 mm



Reduction of polarization dependency

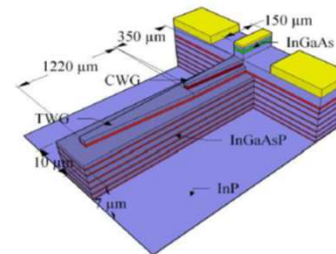

Internal structure of UTC-PD

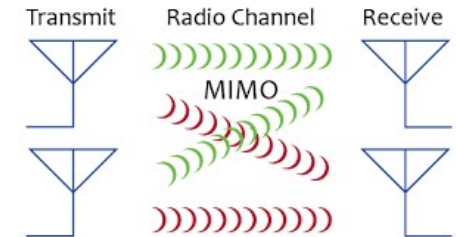

2x2 MIMO with PDM

- **The necessity of THz-band communications**
 - advent of 6G era
 - hyper-reality services
 - indoor network application

- **THz transmission based on photonics**
 - electronics vs. photonics

- **Demonstrations of THz transmissions by using photonics**
 - architectures
 - modulation/detection methods
 - indoor network demonstrations

- **Technical challenges to overcome**
 - Still have lots of works to do



Thank you