

Project: IEEE P802.15 Working Group for Wireless Personal Area Networks (WPANs)

Submission Title: [IG DEP Dependable MAC Protocol with Interference Mitigation Using Negotiation among Coordinators in Multiple Wireless Body Area Networks(BANs)]

Date Submitted: [15 July 2019]

Source: [Shunya Ogawa¹, Ryuji Kohno^{1,2,3}] [1;Yokohama National University, 2;Centre for Wireless Communications(CWC), University of Oulu, 3;University of Oulu Research Institute Japan CWC-Nippon]
Address [1; 79-5 Tokiwadai, Hodogaya-ku, Yokohama, Japan 240-8501

2; Linnanmaa, P.O. Box 4500, FIN-90570 Oulu, Finland FI-90014

3; Yokohama Mitsui Bldg. 15F, 1-1-2 Takashima, Nishi-ku, Yokohama, Japan 220-0011]

Voice:[1; +81-45-339-4115, 2:+358-8-553-2849], FAX: [+81-45-338-1157],

Email:[1: ogawa-shunya-md@ynu.jp, kohno@ynu.ac.jp, 2: Ryuji.Kohno@oulu.fi, 3: ryuji.kohno@cwcnippon.co.jp] Re: []

Abstract: [An updated dependable MAC protocol for wireless body area network(WBAN) in presence of multiple overlaid BANS is introduced, A scheme of negotiation among coordinators could improve overall performance.]

Purpose: [information]

Notice: This document has been prepared to assist the IEEE P802.15. It is offered as a basis for discussion and is not binding on the contributing individual(s) or organization(s). The material in this document is subject to change in form and content after further study. The contributor(s) reserve(s) the right to add, amend or withdraw material contained herein.

Release: The contributor acknowledges and accepts that this contribution becomes the property of IEEE and may be made publicly available by P802.15.

Dependable MAC Protocol with Interference Mitigation Using Negotiation among Coordinators in Multiple WBANs

Shunya Ogawa*, Ryuji Kohno* †

* Graduate School of Engineering Yokohama National University

† University of Oulu Research Institute Japan – CWC-Nippon, Co. Ltd.

1. Introduction

1.1 Introduction

- From the development of an aging society and wireless communication technology, researches on medical information communication technology are thriving

➤ One solution is a WBAN (Wireless Body Area Network) IEEE802.15.6

WBAN

A network consisting of sensor nodes and coordinators installed around the human body

International standard of WBAN
Defined for physical layer and MAC layer

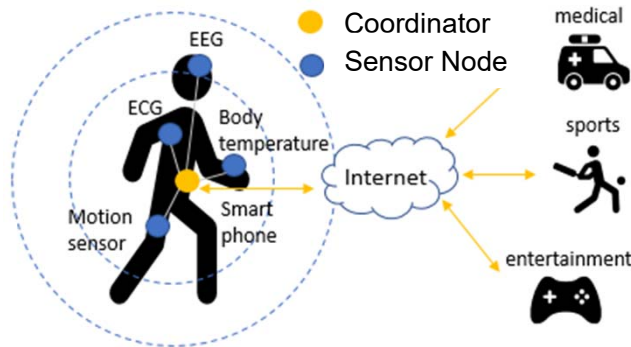

Fig1. Overall picture of WBAN network

This study changes the MAC layer



Hardware already sold
MAC layer can be changed by software

WBAN can control priority according to importance of data packet

- ◆ In this research, we focus on the MAC layer of IEEE 802.15.6 and propose a MAC protocol that reduces inter-BAN interference

1.2 Issues in the standard

Issue

- Interference problem in the case where multiple BANs overlap (specifically, situations where people with BAN approaching)
- Because the schedule adjustment between the coordinators has not been done



Proposal

- Negotiation between coordinators, scheduling between different BANs, to prevent deterioration due to inter-BAN interference

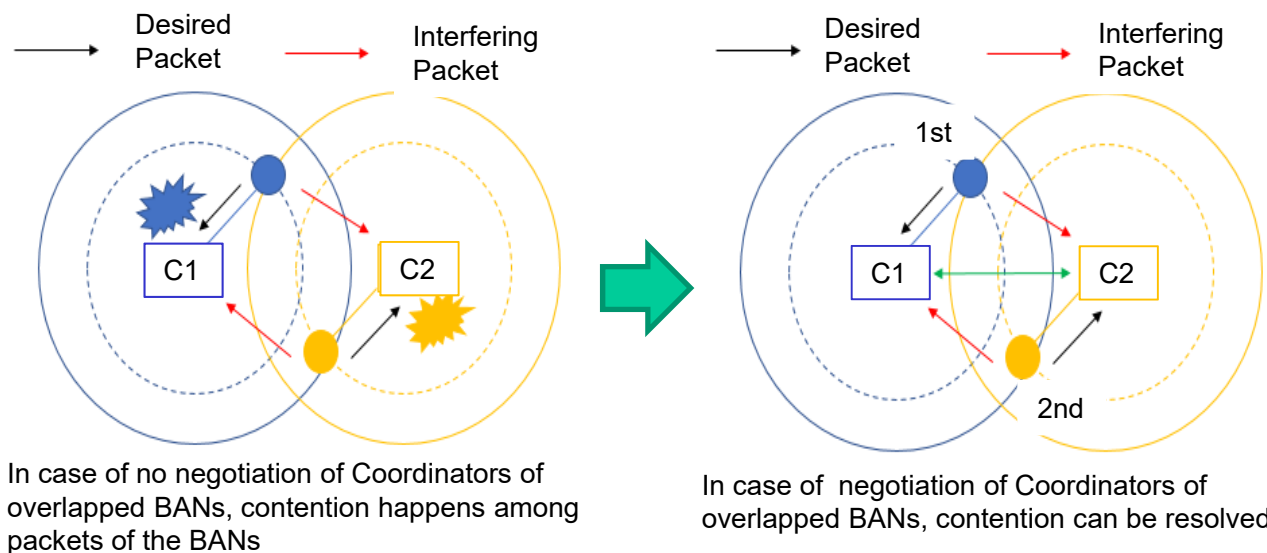

- What is interference at the MAC layer
- Sensor nodes within the communication range try to transmit packets at the same timing, causing collisions, making it impossible to communicate correctly

Fig2. Issue and proposal

2. Proposed method

Purpose

2.1 Outline of proposed method

- Increase the throughput of each BAN in case of interference
- Communication should be guaranteed in descending order of User Priority

Proposal

- Negotiate between coordinators, share the overlap situation of the sensor nodes, and identify the sensor nodes that will cause contention
- Do not send them at the same time

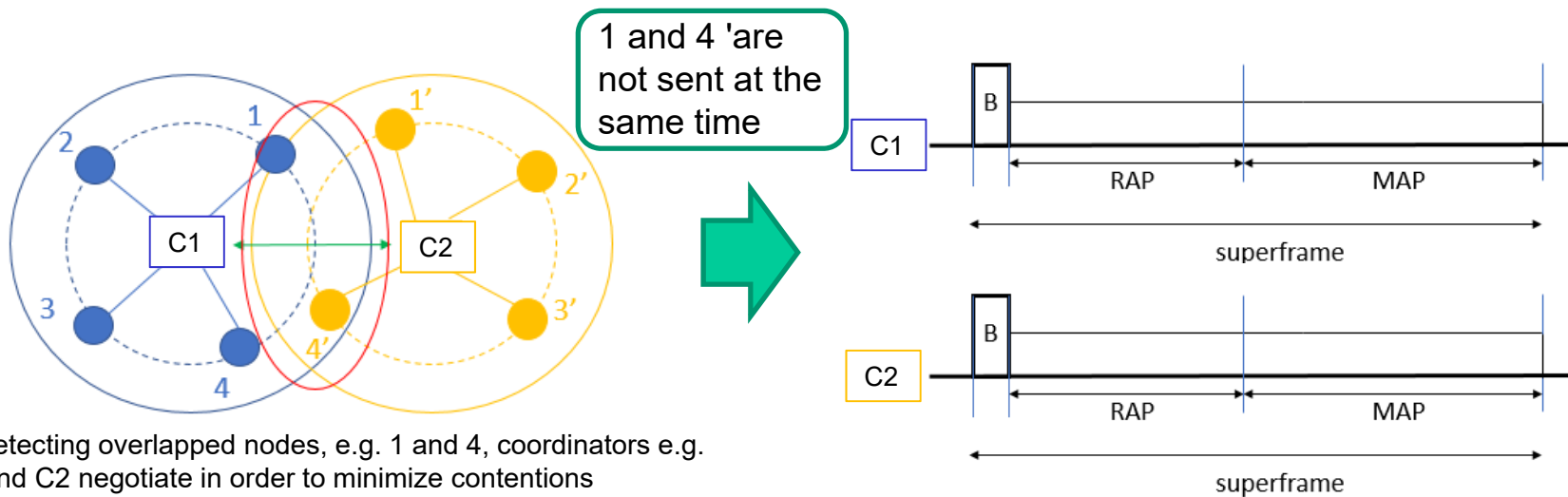

Fig3. Outline of proposed method

2.2 procedure of how to identify overlap situations

1. **Since BAN uses UWB communication, it uses physical layer information that indicates the distance (between coordinators and sensor nodes)**
 - By knowing the distance between a sensor node and the coordinator, it is possible to identify whether or not the node is within its communication range

2. **Use the address of the sensor node given for each BAN**
 - By sharing this address among the coordinators, it is possible to identify whether a sensor node within the trust range is under its own control or under the control of another BAN

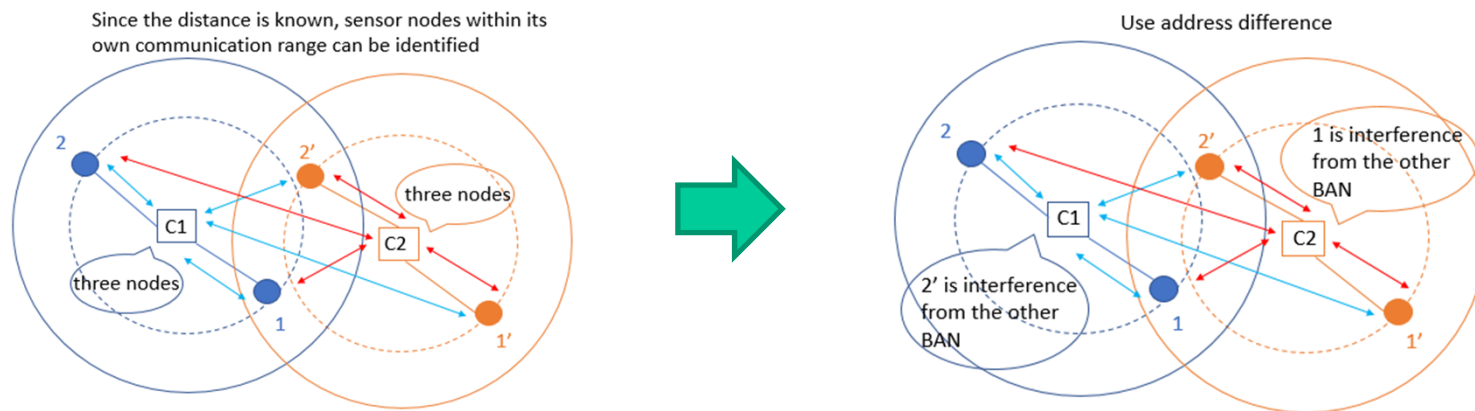

Fig4. how to identify overlap situations

2.3 MAC protocol of MAP(Managed access period)

Proposal (Adopt polling for MAP)

- Divide Superframe's MAP structure into two parts, MAP 1 and MAP 2
- 1. In MAP 1, sensor nodes **not related to interference** are allocated
 - Send at the same time
- 2. In MAP 2, sensor nodes **related to interference** are allocated
 - When one BAN attempts to transmit at MAP 2, the other BAN is placed in a standby state

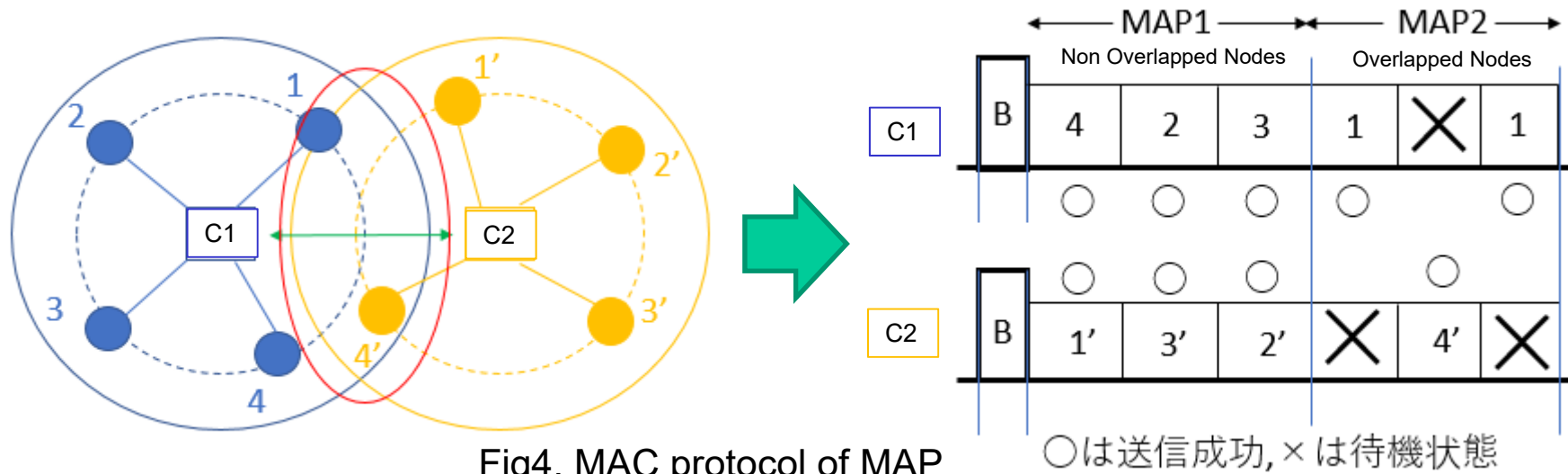

Fig4. MAC protocol of MAP

◆ By separating by interference and non-interference, packet collision does not occur and efficient transmission can be done

2.4 MAC protocol of RAP(Random Access Period)

Proposal (Adopt CSMA / CA for RAP)

- The Superframe's RAP protocol is as follows
 - If the interfering node is low UP (4 or less), do not conflict transmission rights (those with lower UP than competing nodes do not compete)**
 - If the interference node is high UP (5 or more), compete transmission rights of normal CSMA/CA**

Although contention will occur, it will guarantee in descending order of UP

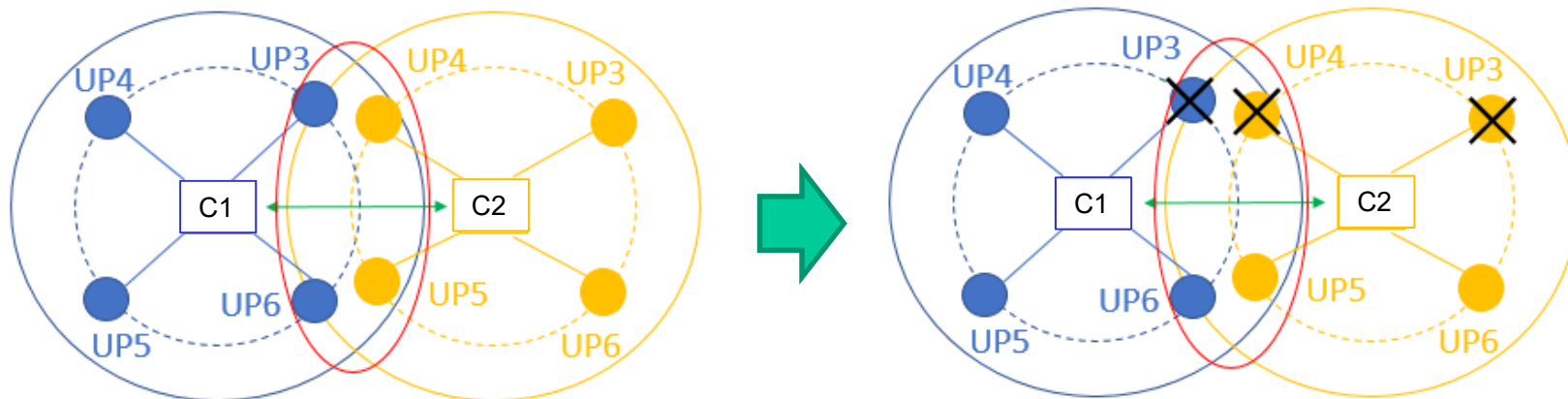

Fig5. MAC protocol of RAP

- ◆ **It is possible to reduce the contention of packets while guaranteeing in descending order of UP**

2.4 Drawback of proposed method

1. MAC protocol of MAP
 - Depending on the number of interfering nodes, the characteristics are degraded
 - The number of slots of MAP 1 and MAP 2 of Superframe becomes **extra**
2. MAC protocol of RAP
 - When **offeredload is low**, the delay characteristic deteriorates
 - When packet occurrence interval is large, deterioration due to not competing transmission right is large
- ◆ **Even if these two combinations are used, only the average UP as a whole improves, **high UP is particularly guaranteed, and low UP is sacrificed can not be controlled** for each purpose**
- ◆ **We aim to respond by changing parameters according to design policy**

3. Measures against drawback

3.1 Measures to drawback MAP

Measures

- Change the ratio of the number of slots of MAP 1 and MAP 2 of Superframe
- **MAP 1 : MAP 2 = number of non-interfering nodes ÷ 2 : to be the number of interfering nodes**

(It is known from the simulation that this is the optimal solution)

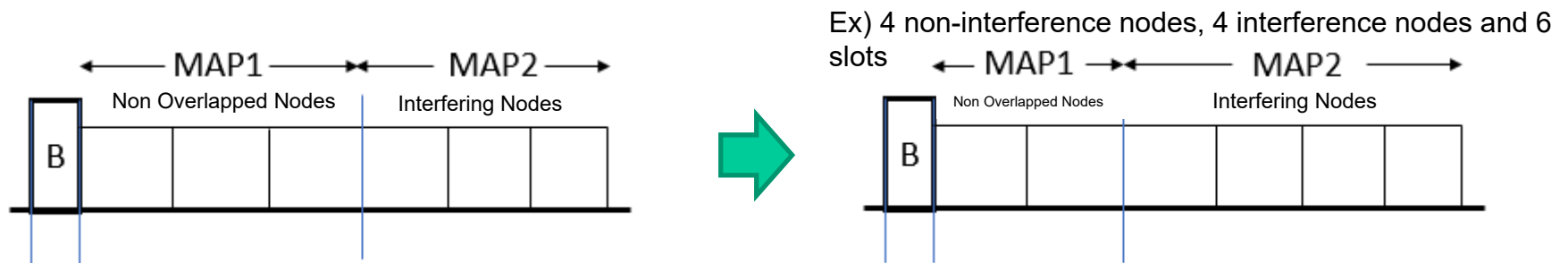

Fig6. Measures to drawback MAP

- ◆ **By changing the ratio of the number of slots of MAP 1 and MAP 2 according to the number of interfering nodes, there is no extra**

3.2 Measures to drawback MAP

Measures

- **Switch on whether to use the proposed method for each offeredload**
 - When offeredload is low, competing transmission rights of normal CSMA / CA
 - When the offer load becomes such that packets conflict, countermeasures against interference are made using the proposed method

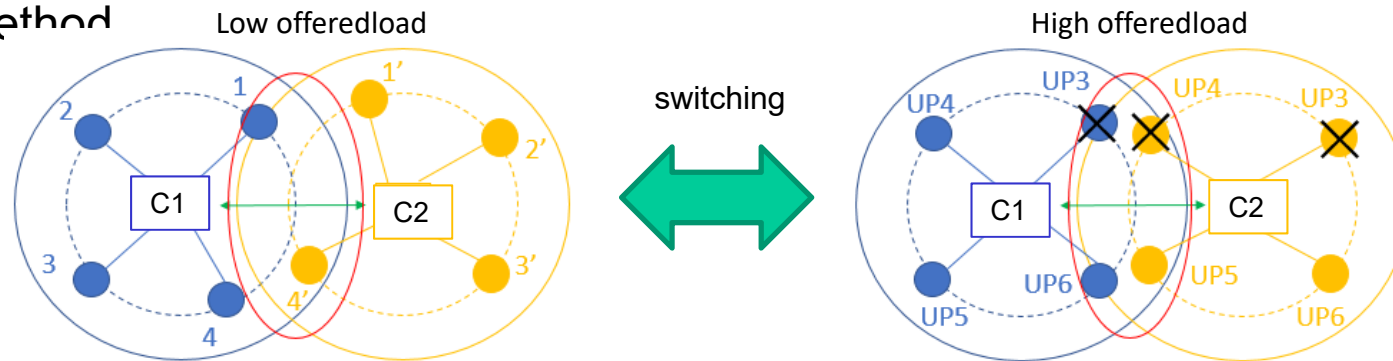

Fig7. Measures to drawback MAP

- ◆ **Due to the switching of the proposed scheme, the deterioration at the time of low offeredload decreases**

3.3 Control to make the priority higher

- We propose a MAC protocol not only giving average performance as a whole, but also **differentiating between high UP and low UP**

RAP

- If it is low UP (4 or less) **irrespective of interference or non-interference**, do not compete transmission right
- If it is high UP (5 or more) **irrespective of interference or non-interference**, compete transmission right

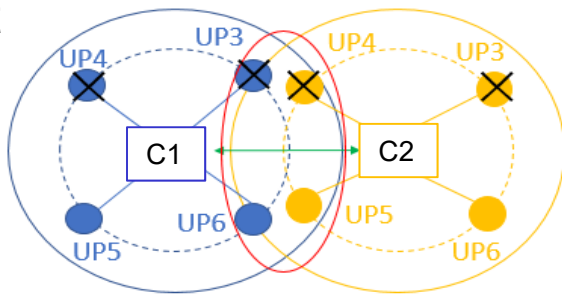

Fig8. RAP

MAP

How to assign transmission rights

The one with the largest
UP value × elapsed time



We changed the weighting
value called UP value

Weighting to make the priority more
dominant

- ◆ **By changing parameters, we can cope with each design policy (giving average performance , differentiating between high UP and low UP)**

4. Performance evaluation by simulation

4.1 Simulation characteristics

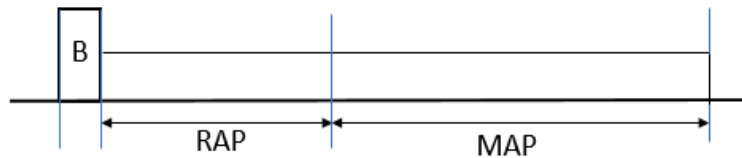

Fig9. Superframe structure

There is no EAP for simplicity

- Determining parameters based on the standard (IEEE 802.15.6)
- The probability of occurrence for each UP is the same
- One type of packet is generated from one node
- RAP, MAP handle all packets
- The condition for discarding the packet is the case where the number of retransmissions is 4 or more and the case where the number of packets to be crowded becomes 3 or more

Table1. simulation characteristics

Number of nodes	4(UP高2,低2)
Data rate	242.9 [kbps]
Payload length	128 [octets]
Number of BANs	2
Superframe length	115 [ms]
Number of slots	RAP=5,MAP=12
Simulation time	30 [s]
Number of trials	100

Content of evaluation

- Overall network throughput characteristics
- Throughput characteristics per UP
- Delay characteristics per UP

Evaluation is made in two ways such as average performance, differentiating between high UP and low UP

4.2 Simulation scenario

1, there are no interference node each

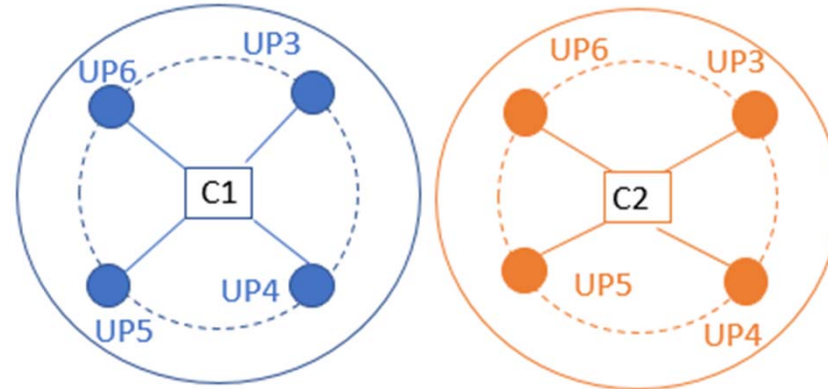

2, there are two interference nodes each

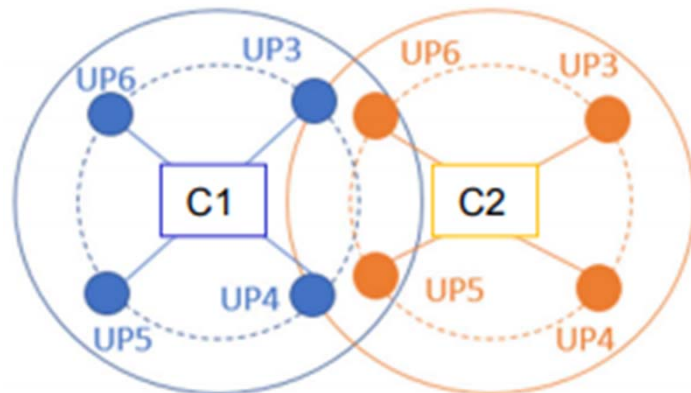

3, there are four(all) interference nodes each

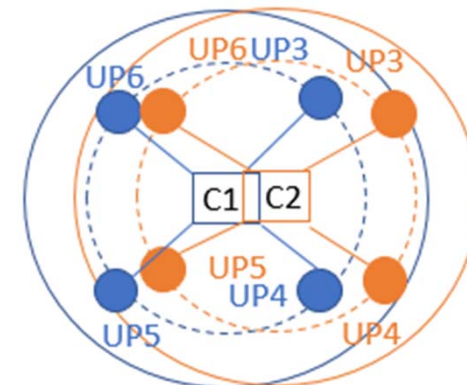

4.3 Simulation result(Total throughput)

Average performance

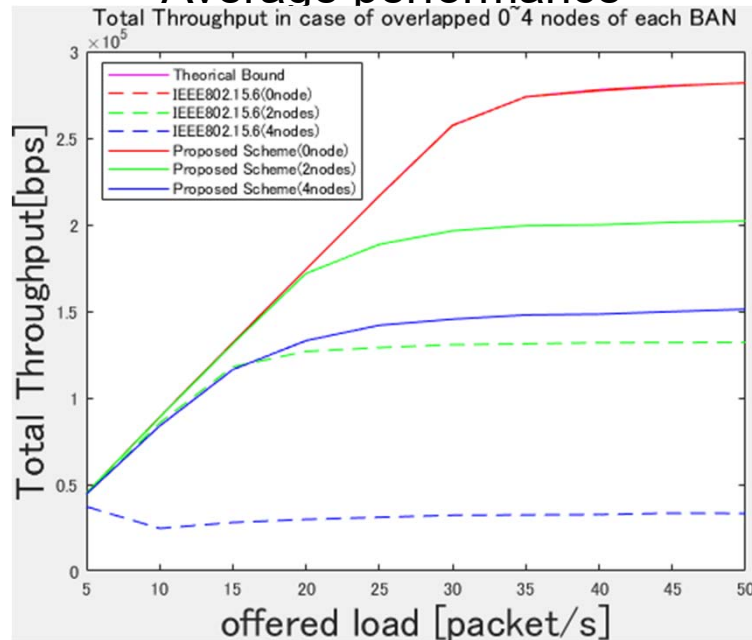

Fig11. Overall network throughput

Differentiating between low UP and high UP

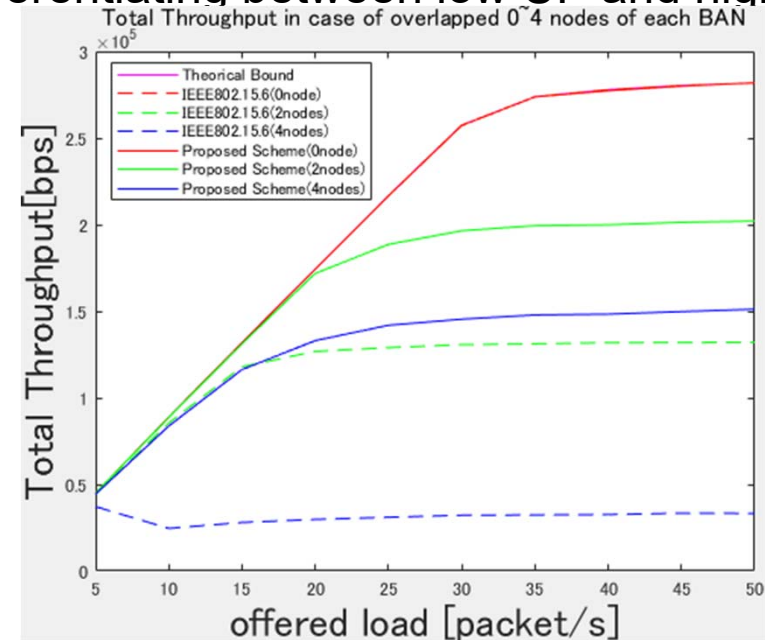

Fig12. Overall network throughput

- **The theoretical bound is the throughput of the entire network in the absence of interference**
- Compared to the standard, the throughput of the whole network is improved in the proposed method in each case
- Since there is no difference in overall throughput by design policy, both are valid

4.3 Simulation result(Throughput of each UP overlapped 2 nodes)

Average performance

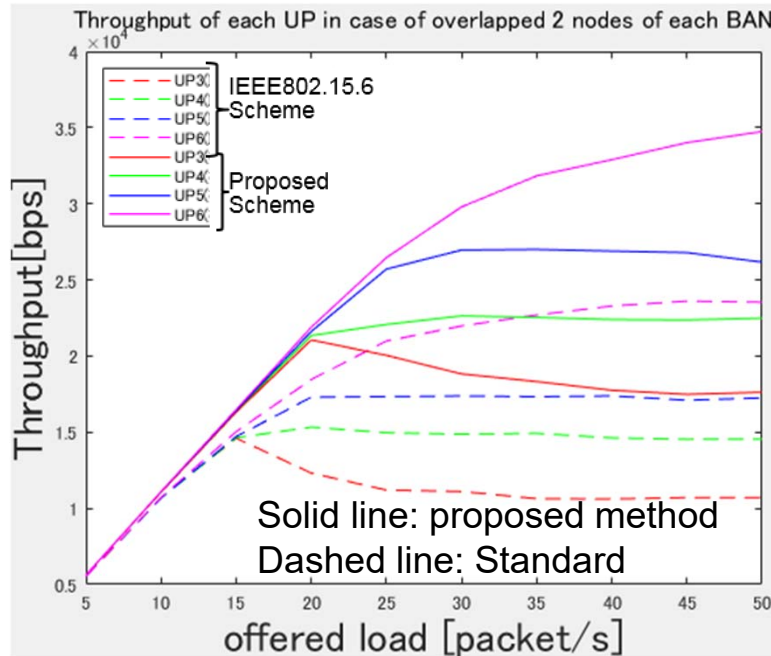

Fig13. Throughput of each UP overlapped 2 nodes

Differentiating between low UP and high UP

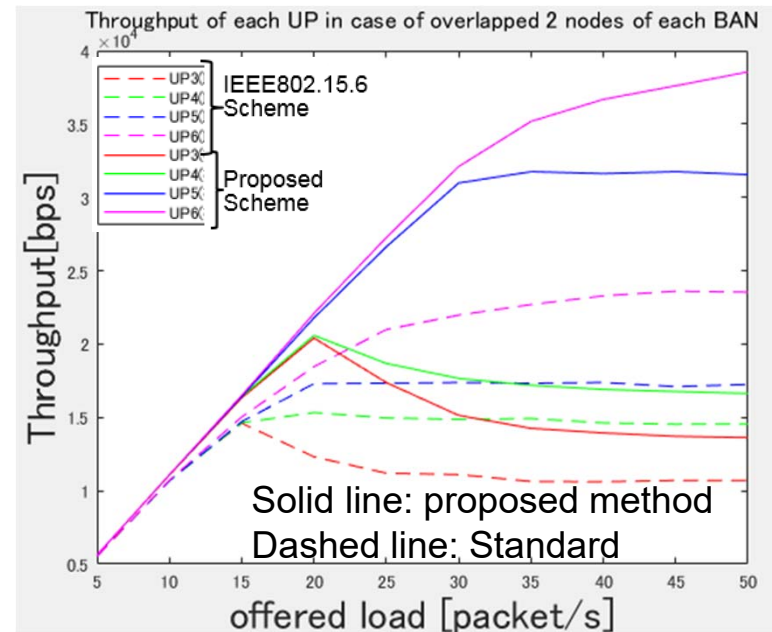

Fig14. Throughput of each UP overlapped 2 nodes

- Similarly, the proposed method is superior to the throughput for each UP
- We can cope with the case where average performance is given and the case where difference is given for each UP

4.3 Simulation result(Throughput of each UP overlapped 0,4 nodes)

Average performance

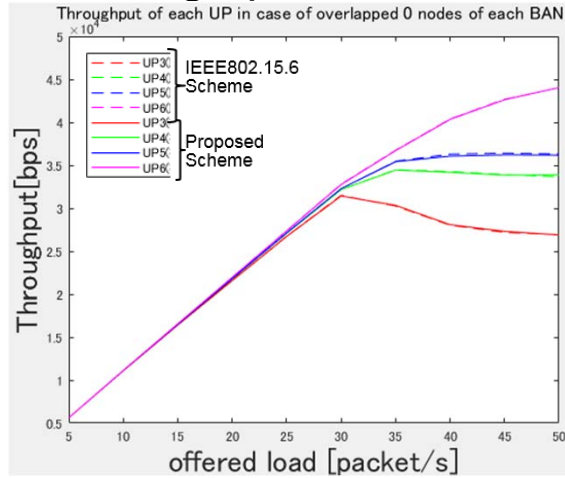

Fig15. Throughput of each UP overlapped 0 node

Differentiating between low UP and high UP

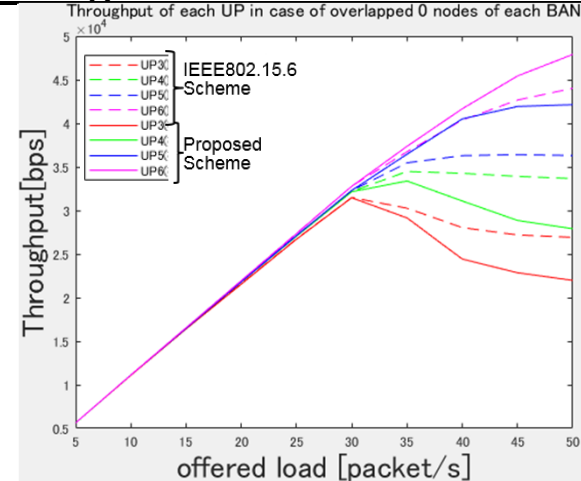

Fig16. Throughput of each UP overlapped 0 node

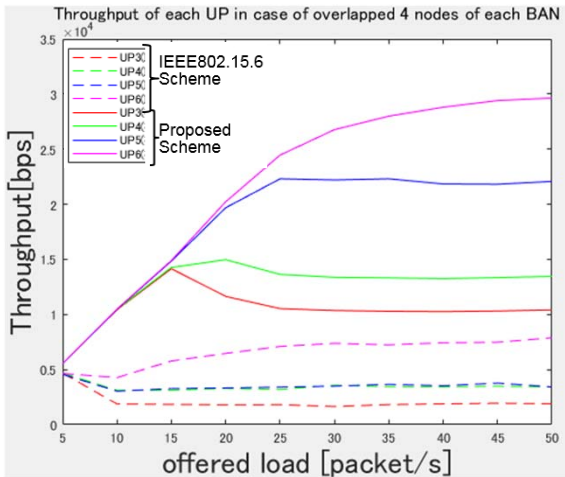

Fig17. Throughput of each UP overlapped 4 nodes

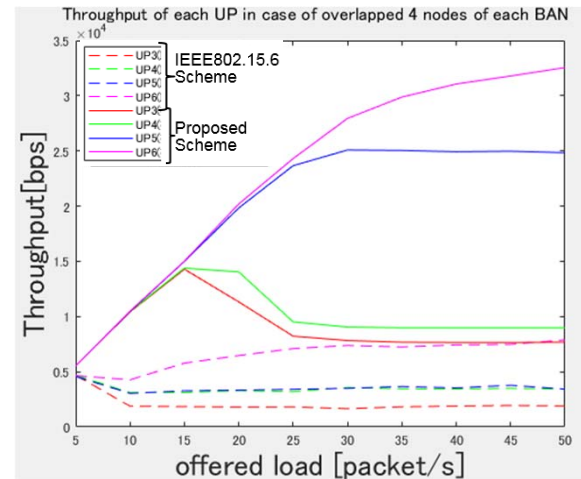

Fig18. Throughput of each UP overlapped 4 nodes

4.3 Simulation result(Delay of each UP overlapped 2 nodes)

Average performance

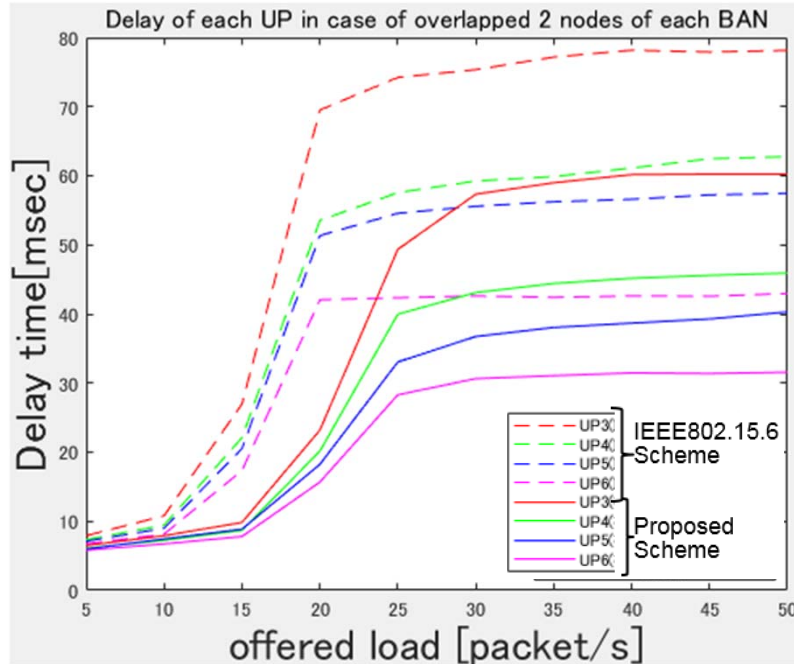

Fig19. Delay of each UP overlapped 2 nodes

Differentiating between low UP and high UP

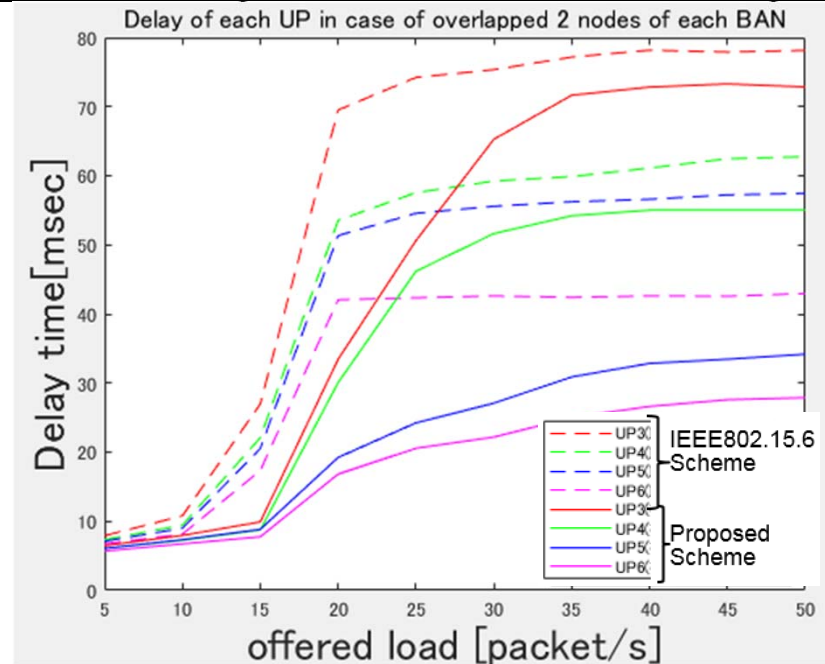

Fig20. Delay of each UP overlapped 2 nodes

- Similarly, the proposed method is superior to the throughput for each UP
- We can cope with the case where average performance is given and the case where difference is given for each UP

4.3 Simulation result(Throughput of each UP overlapped 0,4 nodes)

Average performance

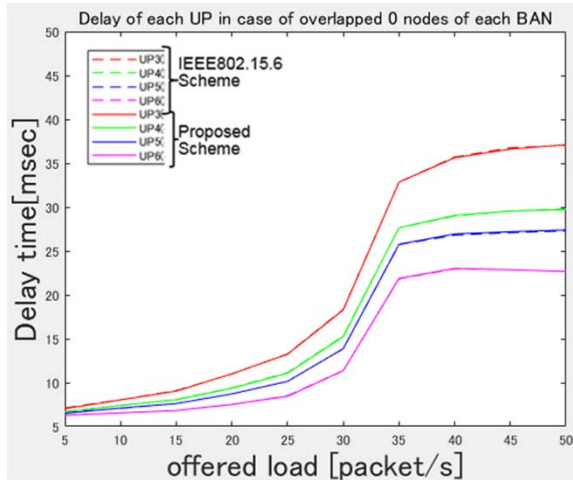

Fig21. Delay of each UP overlapped 0 node

Differentiating between low UP and high UP

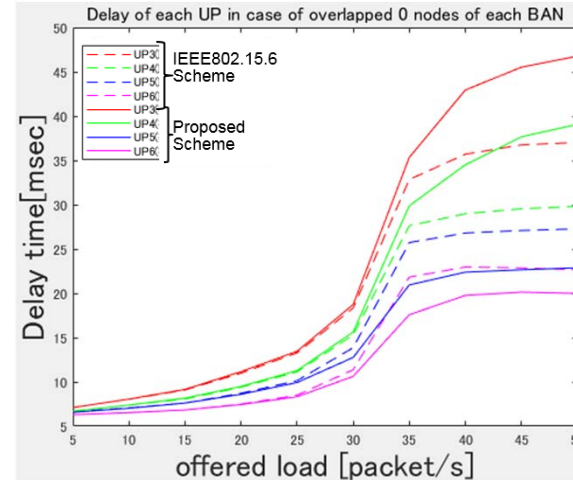

Fig22. Delay of each UP overlapped 0 node

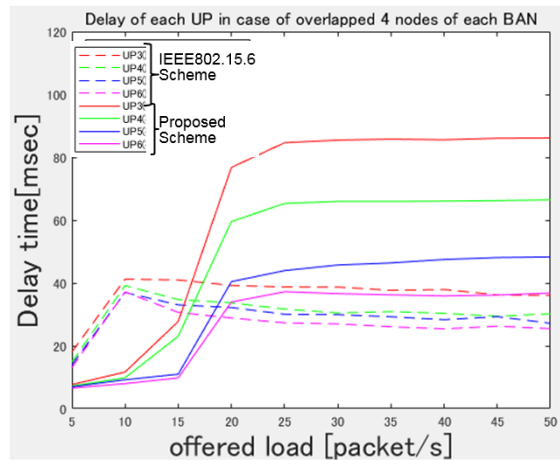

Fig23. Delay of each UP overlapped 4 nodes

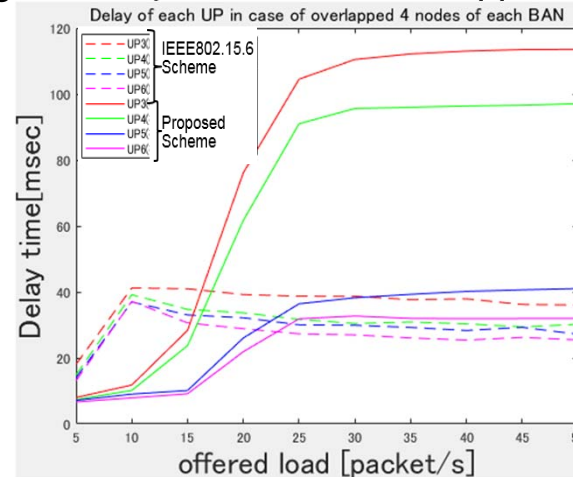

Fig24. Delay of each UP overlapped 4 nodes

5. Conclusion

5.1 Conclusion and Future works

Conclusion

- We conducted research to mitigate interference against the international standard MAC protocol
- In order to reduce interference in multiple BAN environments, we propose to communicate between coordinators to identify and share interfering nodes, and the proposed protocol has improved throughput and delay characteristics over international standards
- We showed that we can deal with by changing parameters according to design policy

Future works

- Consideration when the number of BAN becomes **3 or more**
- Consideration when **packet occurrence probability changes** for each UP
- Theoretical analysis on **optimum values** of various parameters
 - MAP 1 and MAP 2 ratio, UP weighting etc.

Thank you for your attention