

Project: IEEE P802.15 Working Group for Wireless Personal Area Networks (WPANs)

Submission Title: PHY Proposal with Relaying Support for IEEE802.15.7r1

Date Submitted: January 10, 2016

Source: Murat Uysal¹, Refik Kizilirmak², Mohamed Abdallah³, Omer Narmanlioglu¹, Khalid Qaraqe³
Tuncer Baykas⁴

Address: 1) Ozyegin University, Istanbul, Turkey 2) Nazarbyev University, Astana, Kazakhstan 3) Texas A&M University at Qatar, Doha, Qatar 4) Istanbul Medipol University, Istanbul, Turkey

Contact info: Mohamed Abdallah, email: mohamed.abdallah@qatar.tamu.edu

Abstract: This contribution presents a partial PHY proposal with relaying support for IEEE 802.15.7r1

Purpose: This is a partial PHY proposal to enable relay-assisted modes.

Notice: This document has been prepared to assist the IEEE P802.15. It is offered as a basis for discussion and is not binding on the contributing individual(s) or organization(s). The material in this document is subject to change in form and content after further study. The contributor(s) reserve(s) the right to add, amend or withdraw material contained herein.

Release: The contributor acknowledges and accepts that this contribution becomes the property of IEEE and may be made publicly available by P802.15.

Contents

- Introduction
- Relaying Operation
- Common Relay Link Setup
- Data Transmission Rules
- Relaying Operation-type Change (ROC)
- Numerical Results: Office Room with Secondary Light Source
- Summary

Introduction (1/3)

Problem statement for VLC channel

- High path loss
 - Large free space path loss
 - Short communication coverage
- High penetration loss by human
 - High penetration loss (e.g., human body ~25 dB)
 - Resulting in no or lower-rate communication between source and destination.

Introduction (2/3)

In order to address the problems, we propose the use of relay mechanisms in VLC systems

- Relay operation
 - Cooperative Relaying
 - Dual-hop Relaying (Relay is active only when the direct link fails)

Introduction (3/3)

The secondary light sources already exist in the environment can be used as dedicated relay terminals.



Floor light

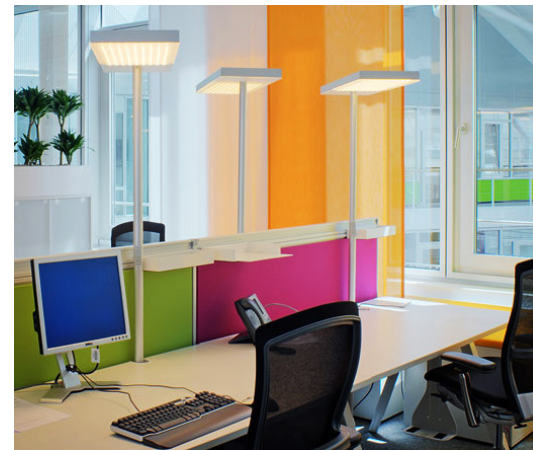

Desk light

Contents

- Introduction
- Relaying Operation
- Common Relay Link Setup
- Data Transmission Rules
- Relaying Operation-type Change (ROC)
- Numerical Results: Office Room with Secondary Light Source
- Summary

Relaying Operation (1/5)

1) Cooperative type

when both S-D and S-R-D links are available

2) Dual-hop type

when S-D link is lost (destination can be blocked or is outside of the coverage), transmission is addressed via relay to destination.

Relaying Operation (2/5)

Cooperative type

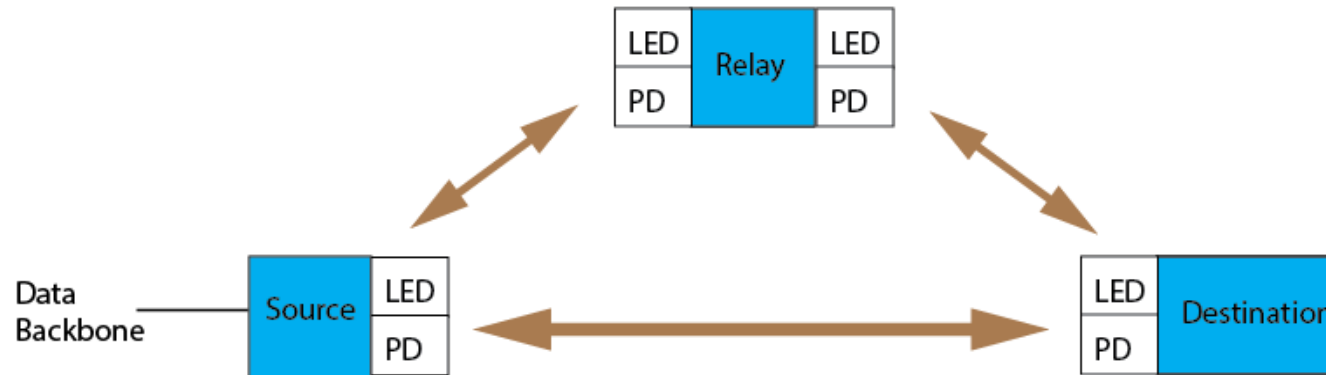

- The relay is actively involved in the direct link communication between S-D.

Relaying Operation (3/5)

Dual-hop type

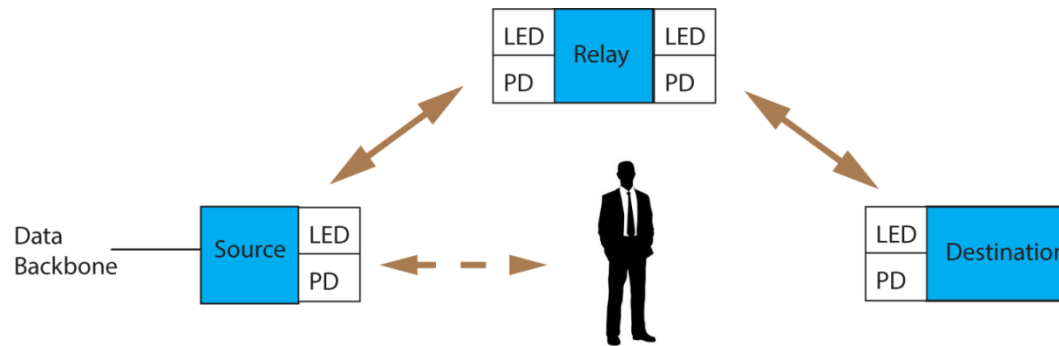

- Dual-hop type is activated when the S-D PHY link (direct link) is disrupted. Transmission of frames addressed to the destination via the relay.
- Direct link can resume after it is recovered.

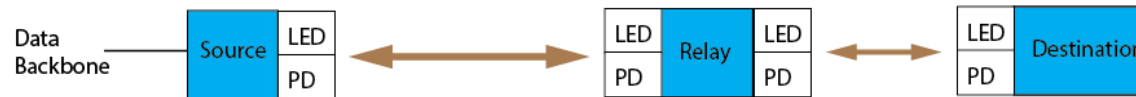

- If the destination moves outside the coverage area of the source, the transmission of frames addressed to the destination via the relay.
- Direct link can resume after it is recovered.

Relaying Operation (4/5)

The relay can work in one of the AF or DF relaying modes.

The relay can work in one of the HD or FD duplexing modes.

Full Duplex (FD): The relay receives and transmits simultaneously.

Amplify-and-Forward (AF): The relay amplifies the signal it receives and forwards.

Half Duplex (HD): The relay receives and transmits in different time slots. (i.e. it first receives the frames from the source, and then forwards to destination.)

Decode-and-Forward (DF): The relay decodes the signal it receives, encodes and forwards.

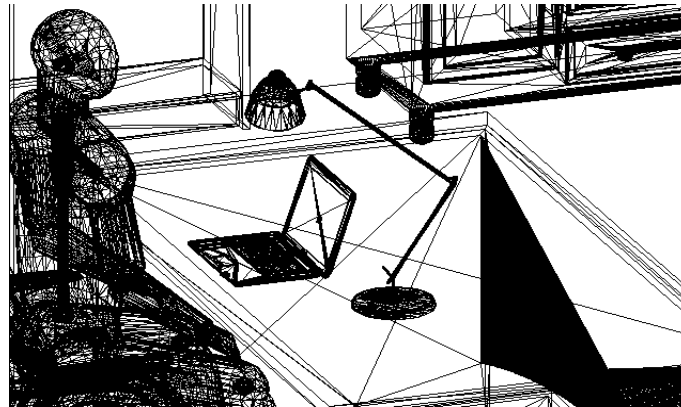

Scenario 2 of IEEE P802.15-15-0746-01-007a.

Relaying Operation (5/5)

In summary, following relaying operation types will be supported.

Cooperative relaying (FD/AF, FD/HD, HD/AF or HD/DF)

Dual-hop relaying (FD/AF, FD/DF, HD/AF or HD/DF)

Contents

- Introduction
- Relaying Operation
- **Common Relay Link Setup**
- Data Transmission Rules
- Relay Operation Type Change
- Numerical Results: Office Room with Secondary Light Source
- Summary

Common Relay Link Setup (1/9)

In this section, we describe the procedures that a source, a destination and a relay employ to setup a relay operation (either FD/AF or HD/DF).

- **Common Relay Link Setup**
 - Relay capabilities and relay discovery procedures
 - Relay selection procedure
 - Relay link setup (RLS) procedure

Common Relay Link Setup (2/9)

Relay capabilities and relay discovery procedures

- The source that intends to setup relay operation with a destination shall obtain the relay capabilities of the destination and relays prior to initiating the relay setup procedure with the destination.
- Relaying Capabilities Information Element (IE)

Element ID	Length	Relay Capability Info				
		Relay Usability	Relaying mode	Duplexing mode	Operation type	Reserved
Octets : 1	1	B0	B1-B2	B3-B4	B5-B6	B7

Common Relay Link Setup (3/9)

Relay capabilities and relay discovery procedures

- Relaying Capabilities Information Element (IE) (cont'd).
 - The sub-field definition in the Relay Capabilities Info field
 - Relay Usability
 - Indicates that the terminal is capable of relaying.
 - Set to 1 if relay supportable (relay terminal).
 - Otherwise set to 0 (destination terminal).

Element ID	Length	Relay Capability Info				
		Relay Usability	Relaying mode	Duplexing mode	Operation type	Reserved
Octets : 1	1	B0	B1-B2	B3-B4	B5-B6	B7

Common Relay Link Setup (4/9)

Relay capabilities and relay discovery procedures

- Relaying Capabilities Information Element (IE) (cont'd)
 - The sub-field definition in the Relay Capabilities Info field
 - Relaying mode
 - Indicates whether relay is capable of amplify-and-forward (AF) or decode-and-forward (DF) relaying modes.
 - Set to 01 (only AF).
 - Set to 10 (only DF).
 - Set to 11 (both AF and DF). The value 00 is reserved.

Element ID	Length	Relay Capability Info				
		Relay Usability	Relaying mode	Duplexing mode	Operation type	Reserved
Octets : 1	1	B0	B1-B2	B3-B4	B5-B6	B7

Common Relay Link Setup (5/9)

Relay capabilities and relay discovery procedures

- Relaying Capabilities Information Element (IE) (cont'd)
 - The sub-field definition in the Relay Capabilities Info field
 - Duplexing mode
 - Indicates whether terminal (either relay or destination) is capable of full-duplex (FD) or half duplex (HD) duplexing modes.
 - Set to 01 (only FD).
 - Set to 10 (only HD).
 - Set to 11 (both FD and HD). The value 00 is reserved.

Element ID	Length	Relay Capability Info				
		Relay Usability	Relaying mode	Duplexing mode	Operation type	Reserved
Octets : 1	1	B0	B1-B2	B3-B4	B5-B6	B7

Common Relay Link Setup (6/9)

Relay capabilities and relay discovery procedures

- Relaying Capabilities Information Element (IE) (cont'd)
 - The sub-field definition in the Relay Capabilities Info field
 - Operation type
 - Indicates whether the terminal (either relay or destination) is capable of cooperation relaying or dual-hop relaying.
 - Set to 01 (only cooperation).
 - Set to 10 (only dual-hop).
 - Set to 11 (both cooperation and dual-hop). The value 00 is reserved.

Element ID	Length	Relay Capability Info				
		Relay Usability	Relaying mode	Duplexing mode	Operation type	Reserved
Octets : 1	1	B0	B1-B2	B3-B4	B5-B6	B7

Common Relay Link Setup (7/9)

Relay capabilities and relay discovery procedures

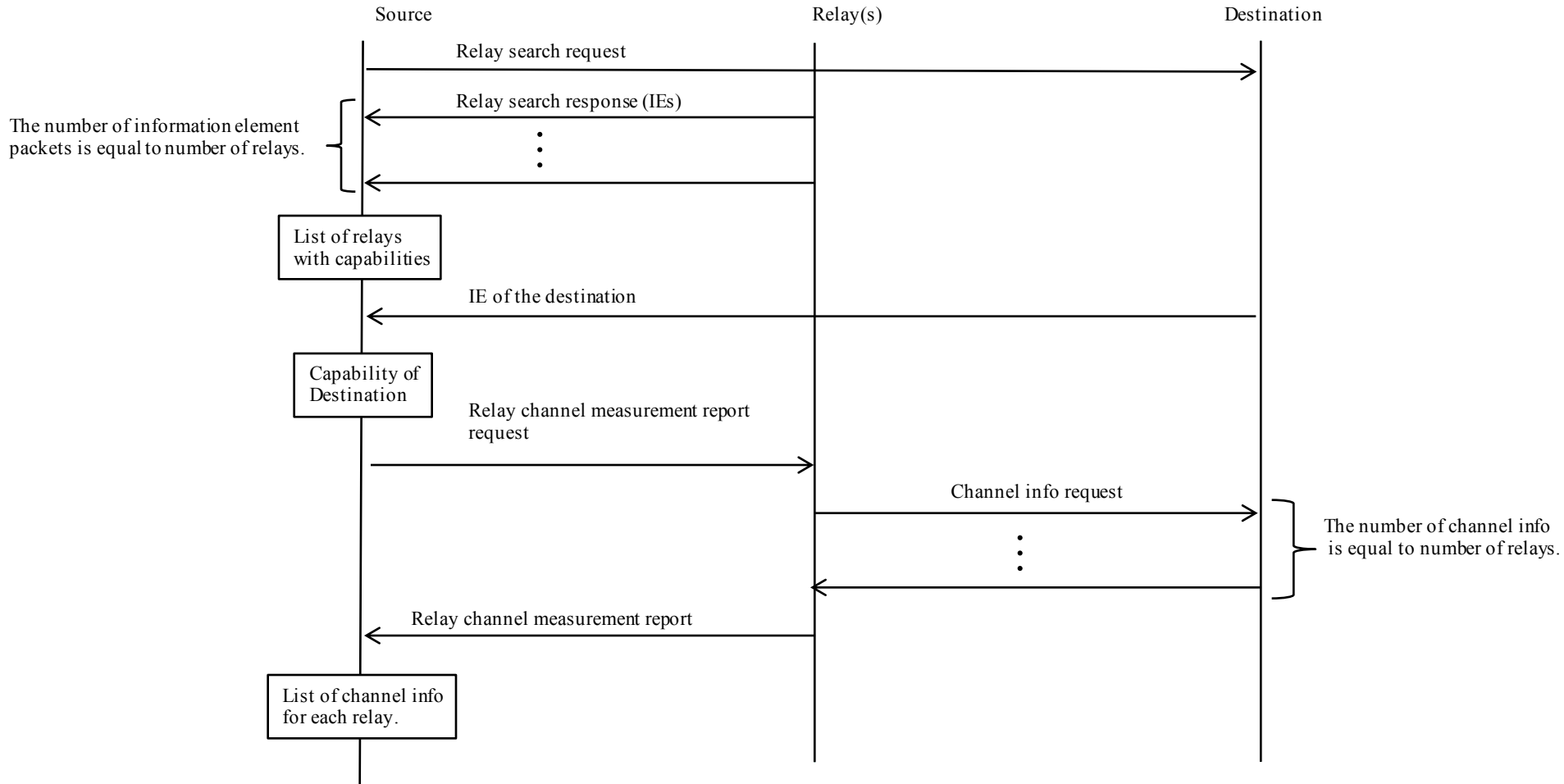

Common Relay Link Setup (8/9)

Relay selection procedure

- Relay procedure defines selecting the best relay and operation type among multiple relays.
- The relay selection procedure is based on the channel info and capabilities for each relay available at the source node.

Common Relay Link Setup (9/10)

Relay selection procedure

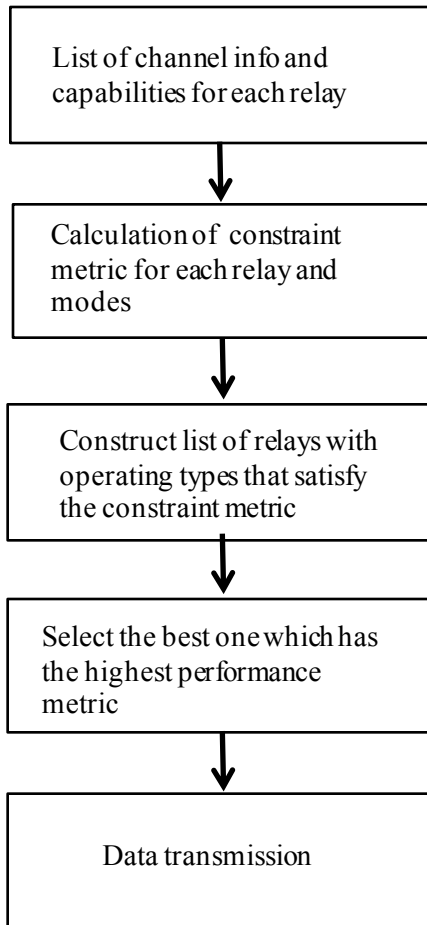

Constraint metric: pre-determined values for constraint metric according to QoS requirements for targeted applications.

Performance metric: pre-determined values for constraint metric according to QoS requirements for targeted applications.

Common Relay Link Setup (10/10)

Relay link setup (RLS) procedure

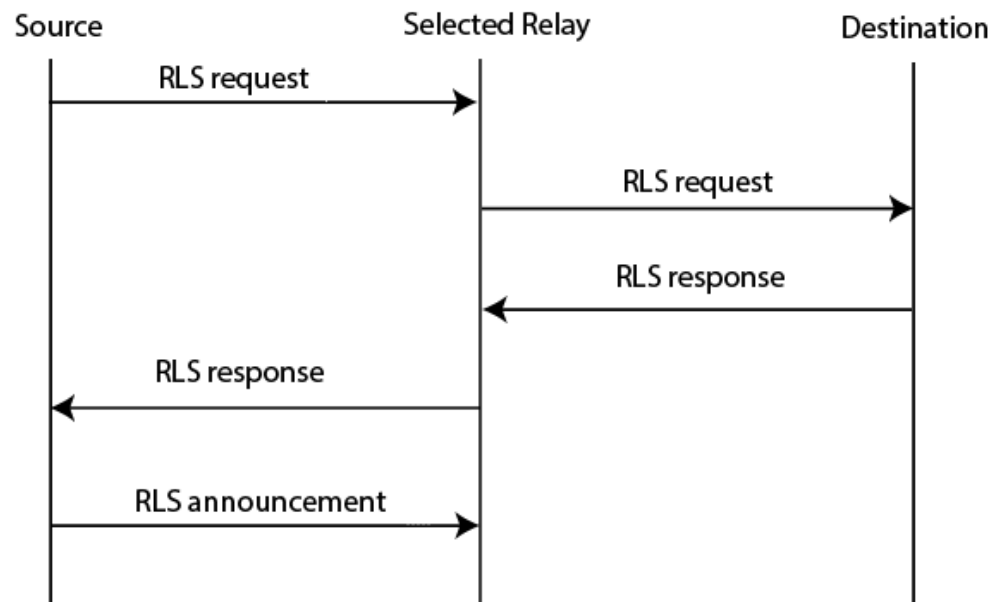

RLS request: including capabilities, IDs of the source, relay, destination nodes.

RLS response: indicates whether terminal can participate in the RLS.

RLS announcement: indicates the RLS procedure was successfully completed.

Contents

- Introduction
- Relaying Operation
- Common Relay Link Setup
- [Data Transmission Rules](#)
- Relaying Operation-type Change (ROC)
- Numerical Results: Office Room with Secondary Light Source
- Summary

Data Transmission Rules (1/6)

In this section, we describe the data transmission rules for the following relaying operation types.

- 1) **Cooperative relaying** (FD/AF, FD/DF, HD/AF or HD/DF)
- 2) **Dual-hop relaying** (FD/AF, FD/DF, HD/AF or HD/DF)

Data Transmission Rules (2/6)

1) Cooperative relaying (FD/AF, FD/HD)

A source shall use the relay (both S-D and S-R-D links) when it initiates frame transmission to the destination at the start of the first SP allocated for destination.

Relay works in FD mode.



Delay due to the processing time of the FD relay

Data Transmission Rules (3/6)

1) Cooperative relaying (HD/AF or HD/DF)

A source shall use the relay (both S-D and S-R-D links) when it initiates frame transmission to the destination at the start of the first SP allocated for destination.

Relay works in HD mode.

Destination applies a combining scheme (Selection combining, Maximal ratio combining etc.).

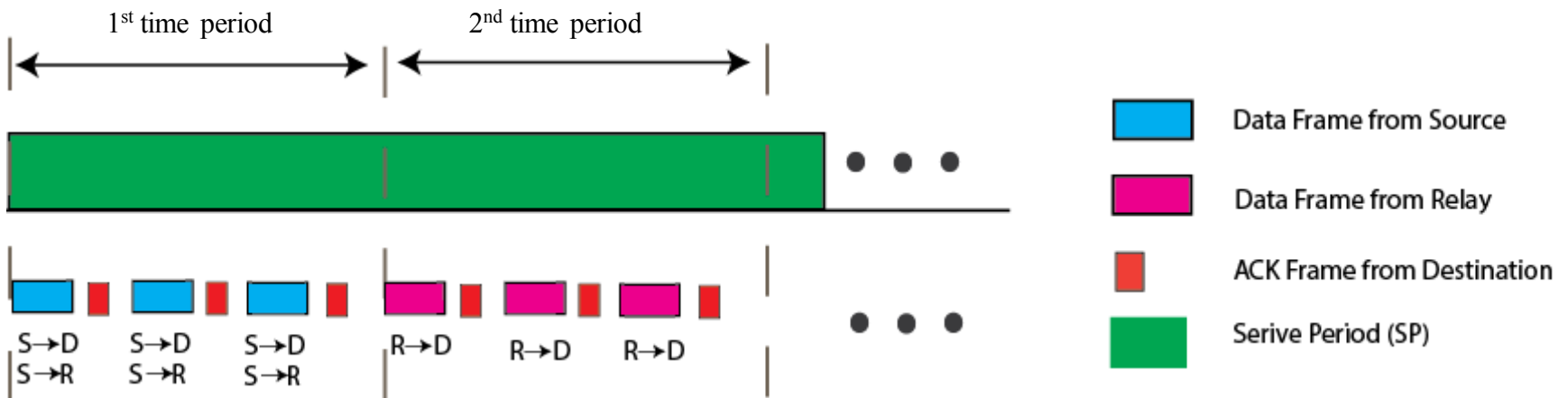

Data Transmission Rules (4/6)

2) Dual-hop relaying (FD/AF, FD/DF)

A source shall use the direct link (S-D) or cooperative type to initiate frame transmission to the destination at the start of the first SP allocated for destination.

If the “ACK frame to Direct link” fails (either due to blocking or lack of coverage), transmission is addressed via relay to destination.

Relay works in FD mode.

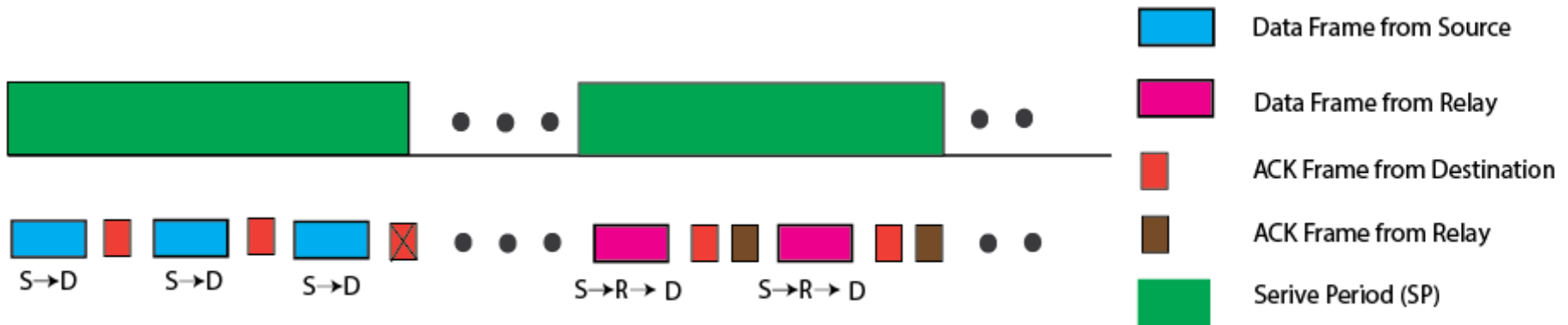

Data Transmission Rules (5/6)

2) Dual-hop relaying (FD/AF, FD/DF) cont'd

After transmitting a series of frames via relay, source retries the transmission through S-D link. If it receives "ACK Frame to Direct link", it resumes S-D link. Otherwise, it switches back to relaying.

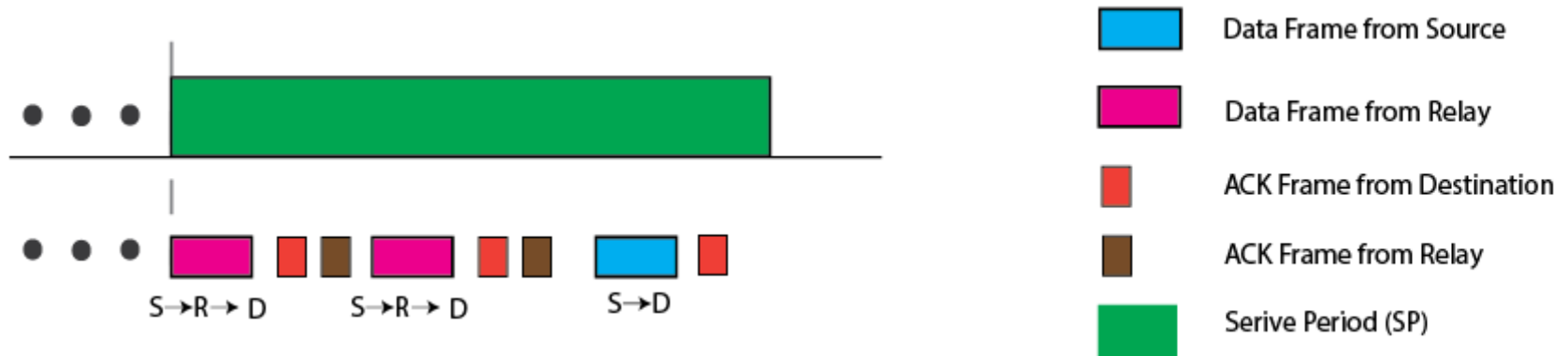

Data Transmission Rules (6/6)

2) Dual-hop relaying (HD/AF or HD/DF)

A source shall use the direct link (S-D) or cooperative type to initiate frame transmission to the destination at the start of the first SP allocated for destination.

Relay works in HD mode.

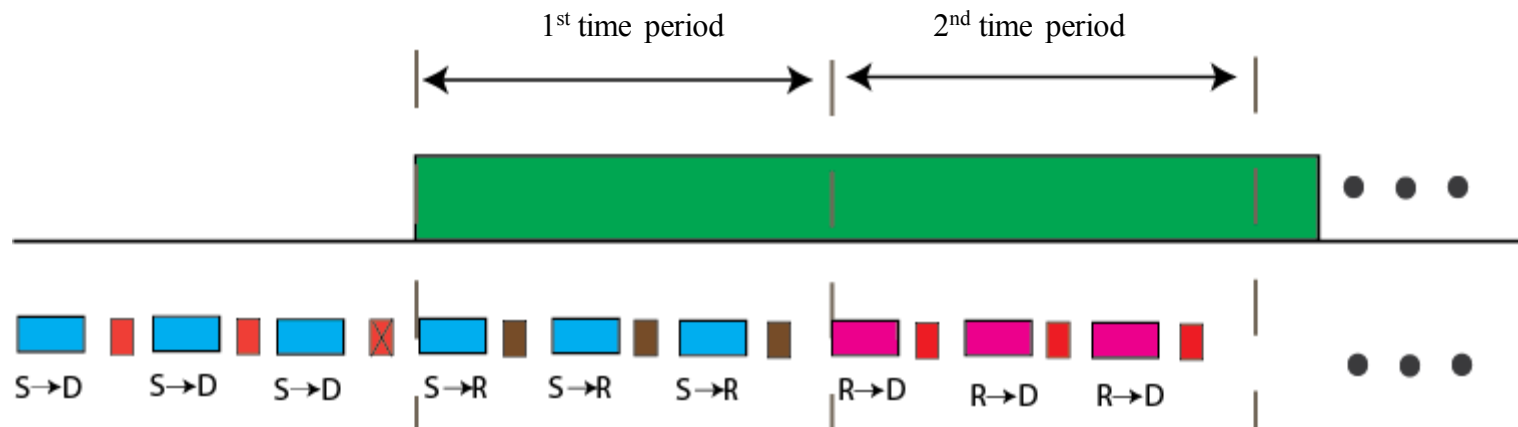

Contents

- Introduction
- Relaying Operation
- Common Relay Link Setup
- Data Transmission Rules
- Relaying Operation-type Change (ROC)
- Numerical Results: Office Room with Secondary Light Source
- Summary

Relaying Operation-type Change (ROC) (1/3)

If either one of S-D, or S-R, or R-D links becomes unavailable or for other reasons, the source may change the relay operation type from direct to dual-hop, cooperative to dual-hop and vice-versa.

ROC Procedure

- If the source catches one of events to trigger the ROC, then it initiates the ROC procedure by transmitting a ROC Request action frame.
- The corresponding relay and destination may respond with a ROC Response action frame.
- Two procedures
 - Procedure of changing from cooperative/direct to dual-hop
 - Procedure of changing from dual-hop to cooperative/direct

Relaying Operation-type Change (ROC) (2/3)

Changing from Cooperative / Direct to Dual-hop type

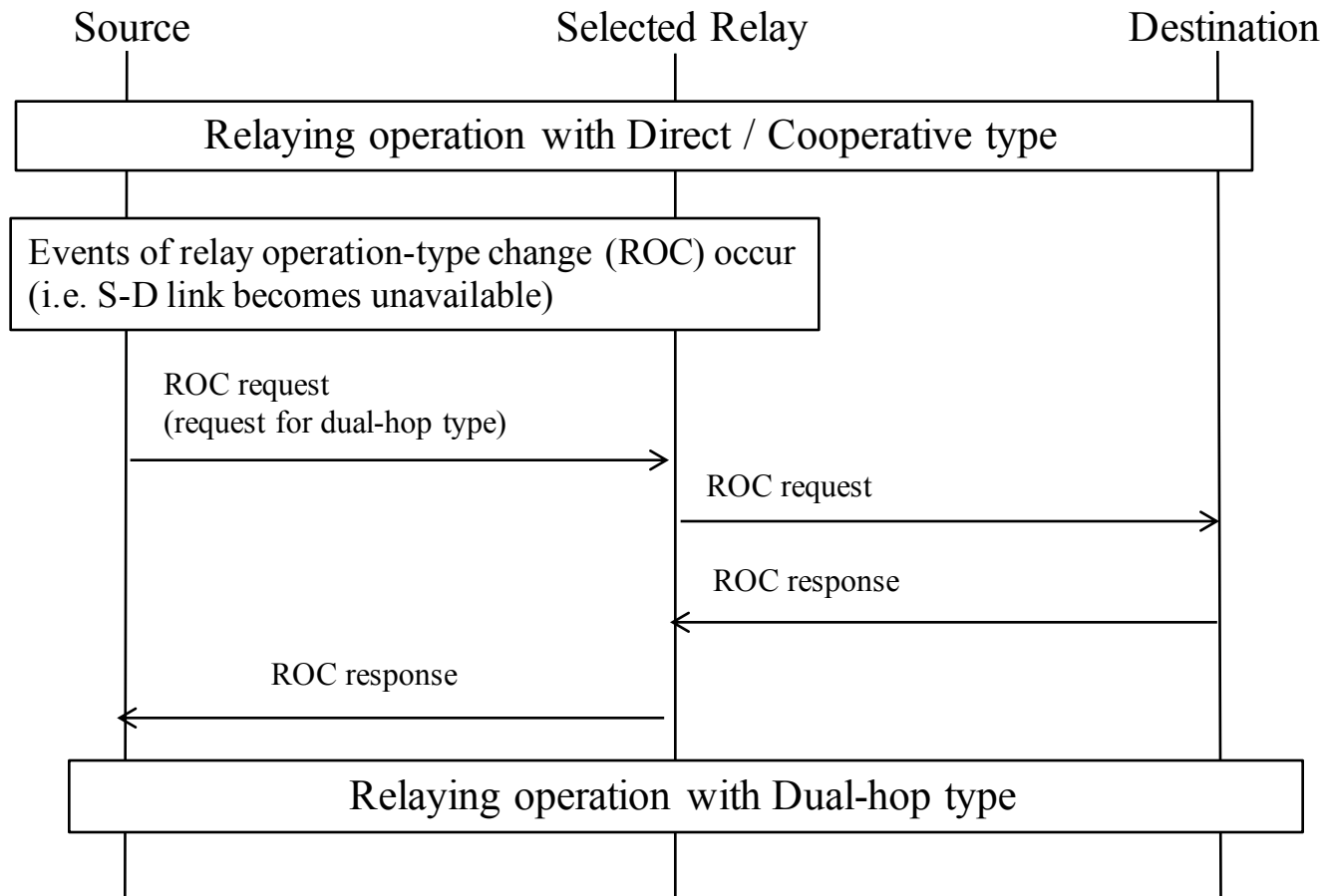

Relaying Operation-type Change (ROC) (3/3)

Changing from Cooperative/Dual-hop type to direct transmission

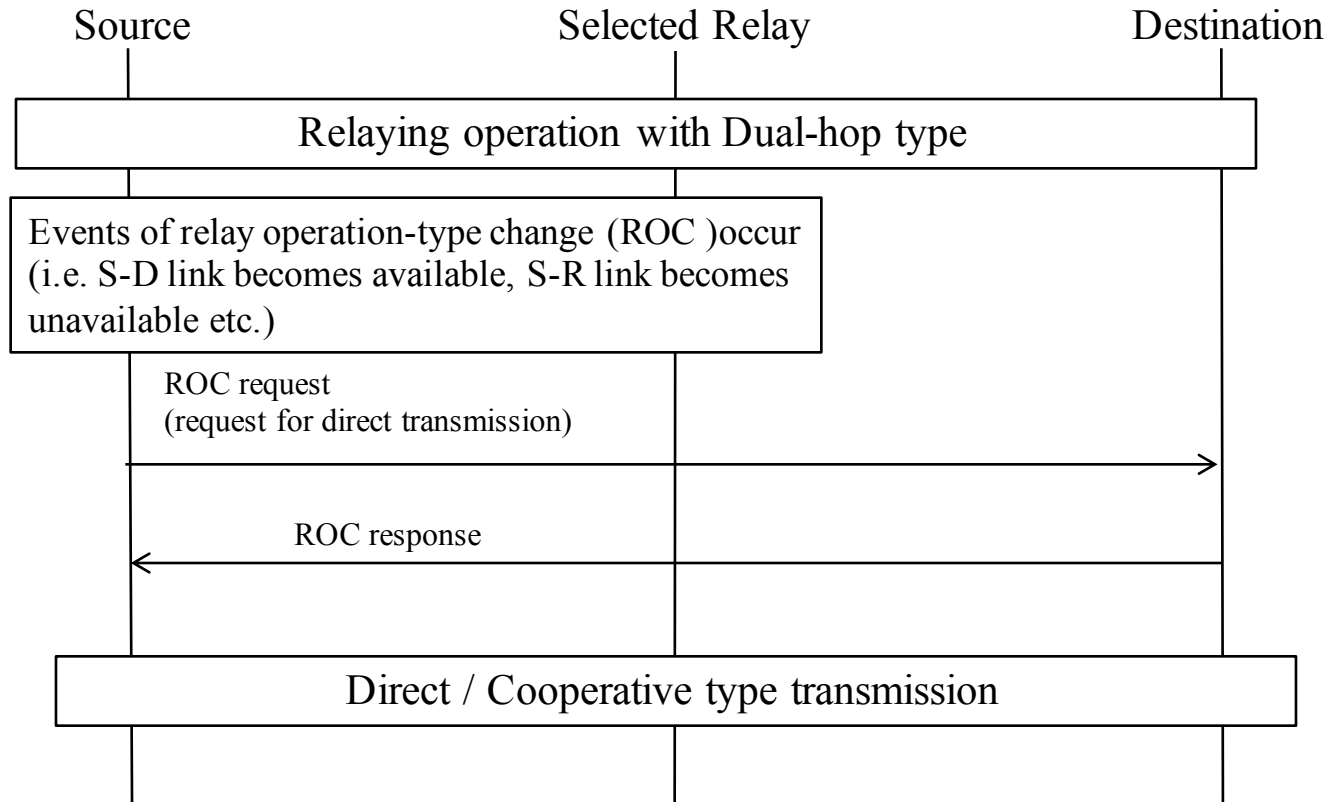

Contents

- Introduction
- Relaying Operation
- Common Relay Link Setup
- Data Transmission Rules
- Relaying Operation-type Change (ROC)
- Numerical Results: Office Room with Secondary Light Source
- Summary

Numerical Results

- DCO-OFDM
- Pulse shaping filter: Root raised cosine
- Bandwidth (W): 10 MHz
- Number of subcarrier: 64
- Cyclic prefix length: 3
- Noise power spectral density (N_0): 10^{-22} W/Hz

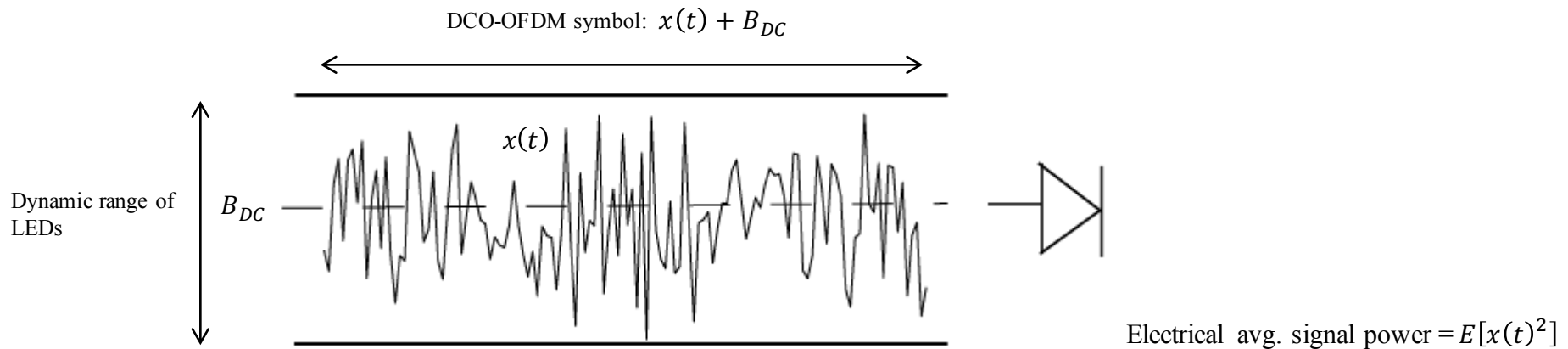

Example 1: Office Room with Secondary Light Source

Both S-D and S-R-D links are available. The relay is actively involved in the direct link communication between S-D.

Cooperative type (HD/DF, HD/AF, FD/DF or FD/AF)

Scenario 2 from IEEE P802.15-15-0746-01-007a.

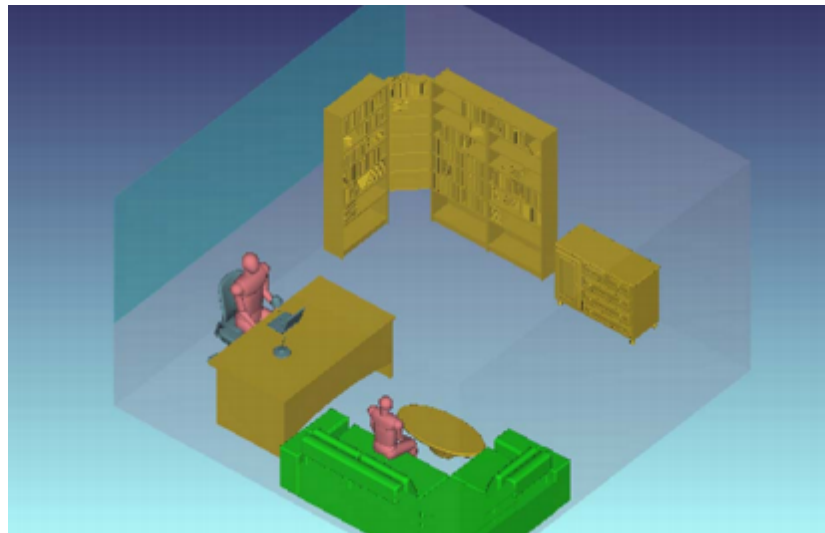

Secondary light source is in the form a desk light.

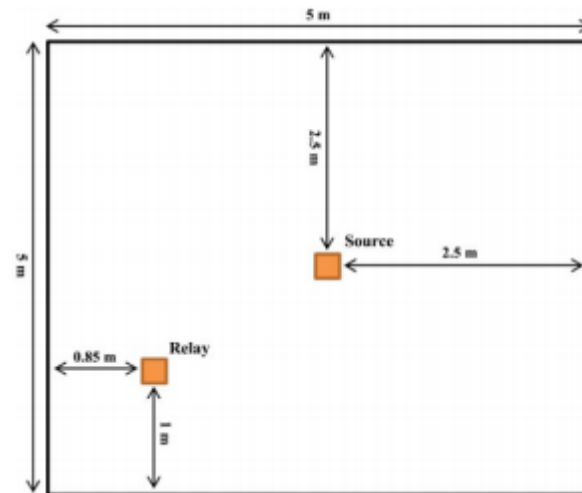

Half duplex DF

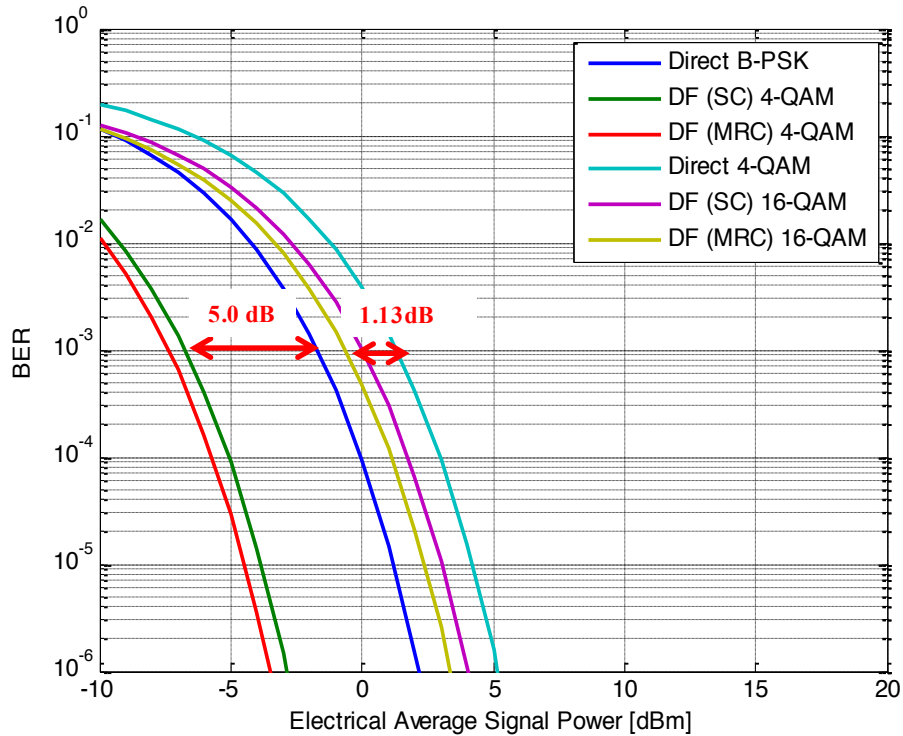

Half duplex AF

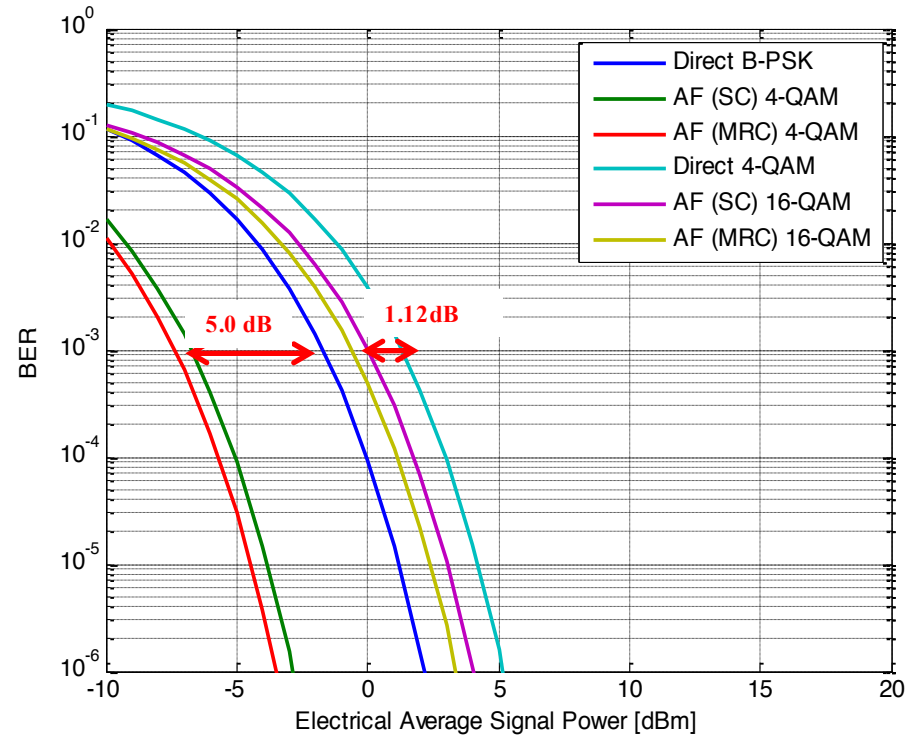

Gains are given based on Selection Combining.

BER curves with Maximal Ratio Combining (MRC) are given for reference. The improvements with MRC are limited.

Full duplex DF

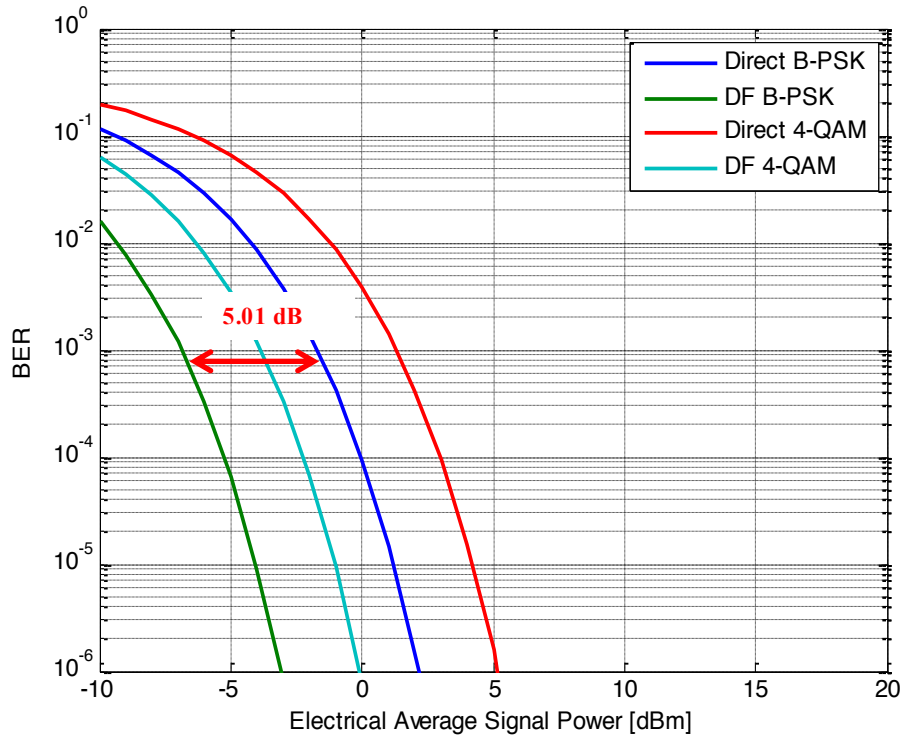

Full duplex AF

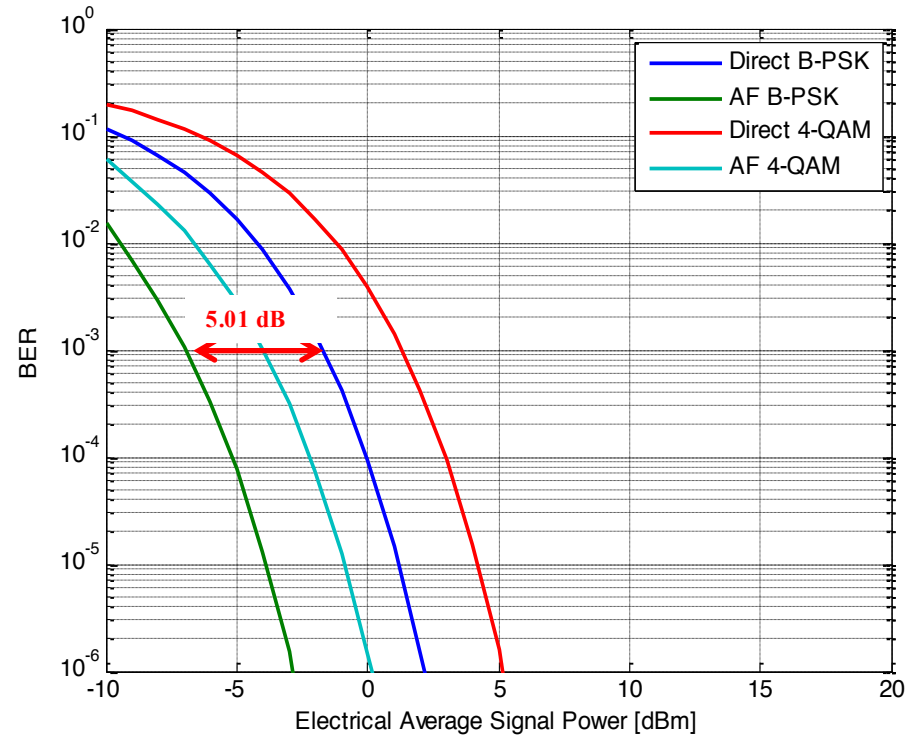

Gain is fixed for any modulation order.
 In FD relaying, SNR is gain obtained.

Example 2: Office Room with Secondary Light Source, S-D link is blocked

The S-D link is not available. The data is forwarded to the destination via dual-hop relaying.

Dual-hop type (HD/DF, HD/AF, FD/DF or FD/AF)

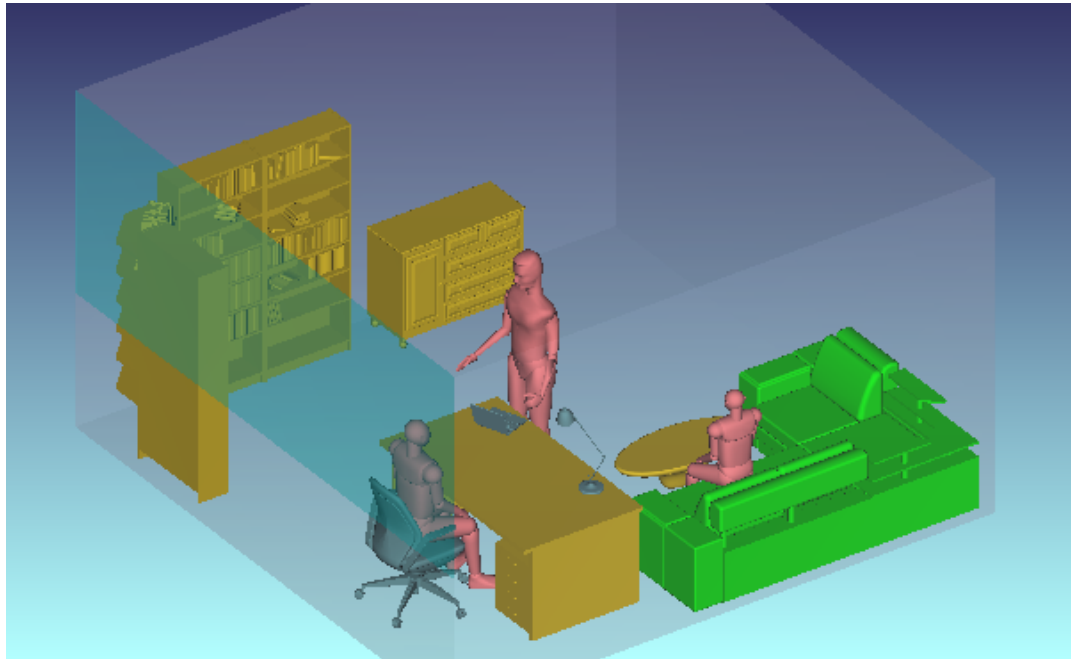

**Penetration loss in
S-D link due to
human blockage:
~25 dB**

Half duplex DF

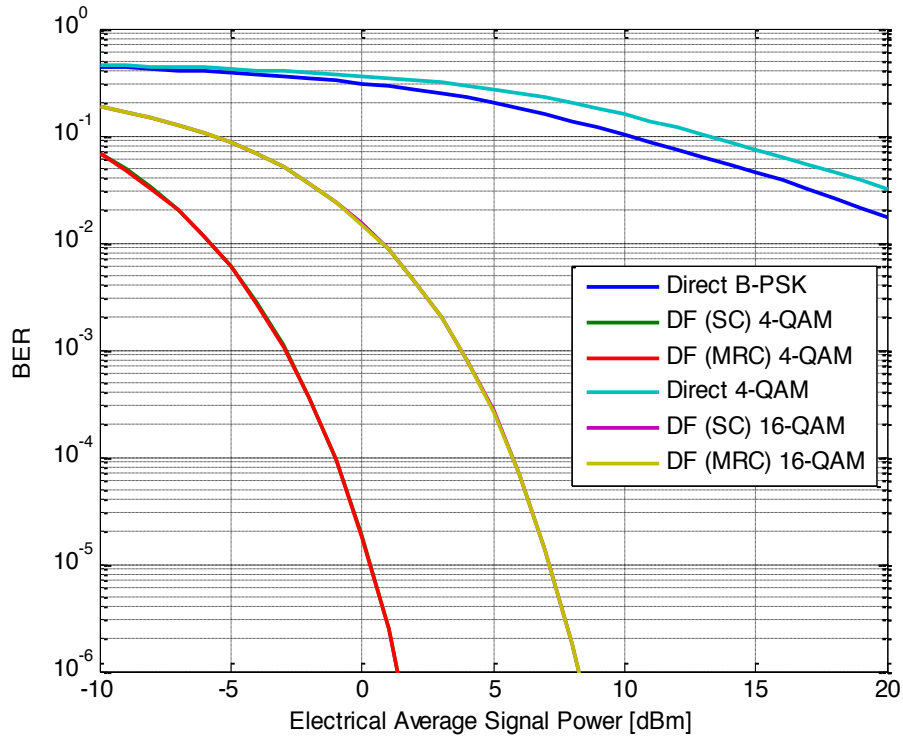

Half duplex AF

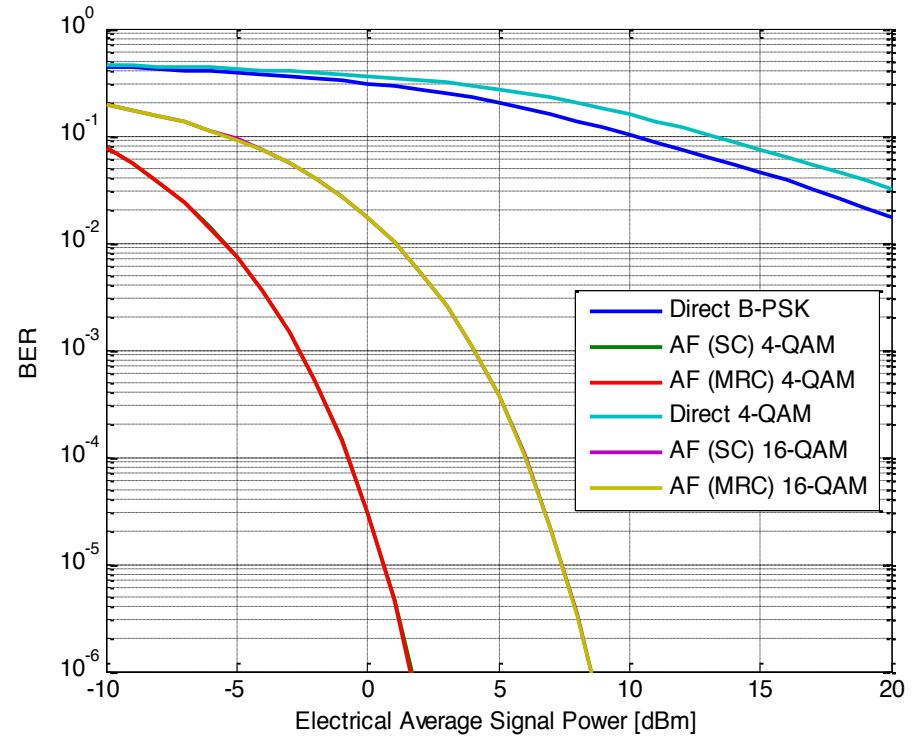

Selection combining (SC) and Maximal Ratio Combining (MRC) gives

Gain is 32.0 dB for AF , 32.3 dB for DF

Full duplex DF

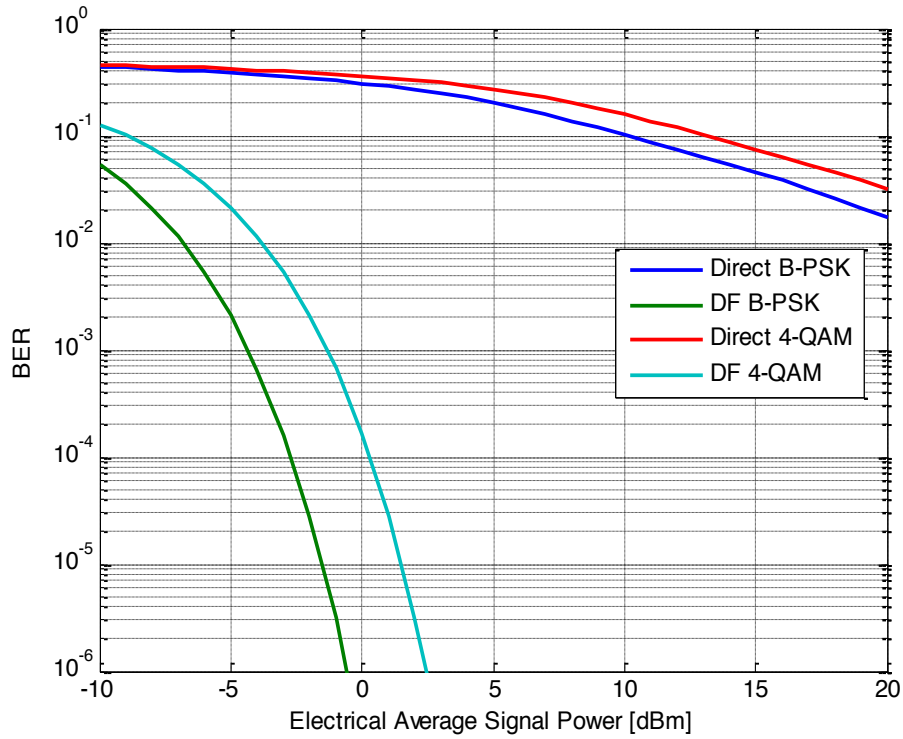

Full duplex AF

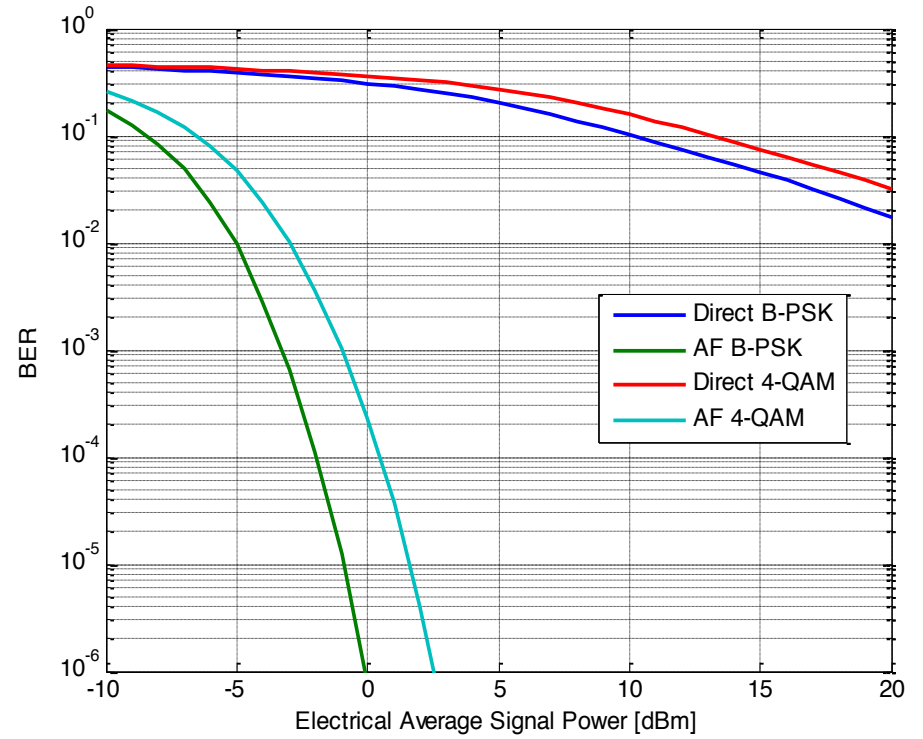

Gain is 34.21 dB for AF , 34.29 dB for DF.

Example 3: Office Room with two Secondary Light Sources – Best Relay

Both S-D and S-R-D links are available for both relays. Relay selection is applied.

Dual-hop type (HD/DF, HD/AF, FD/DF or FD/AF)

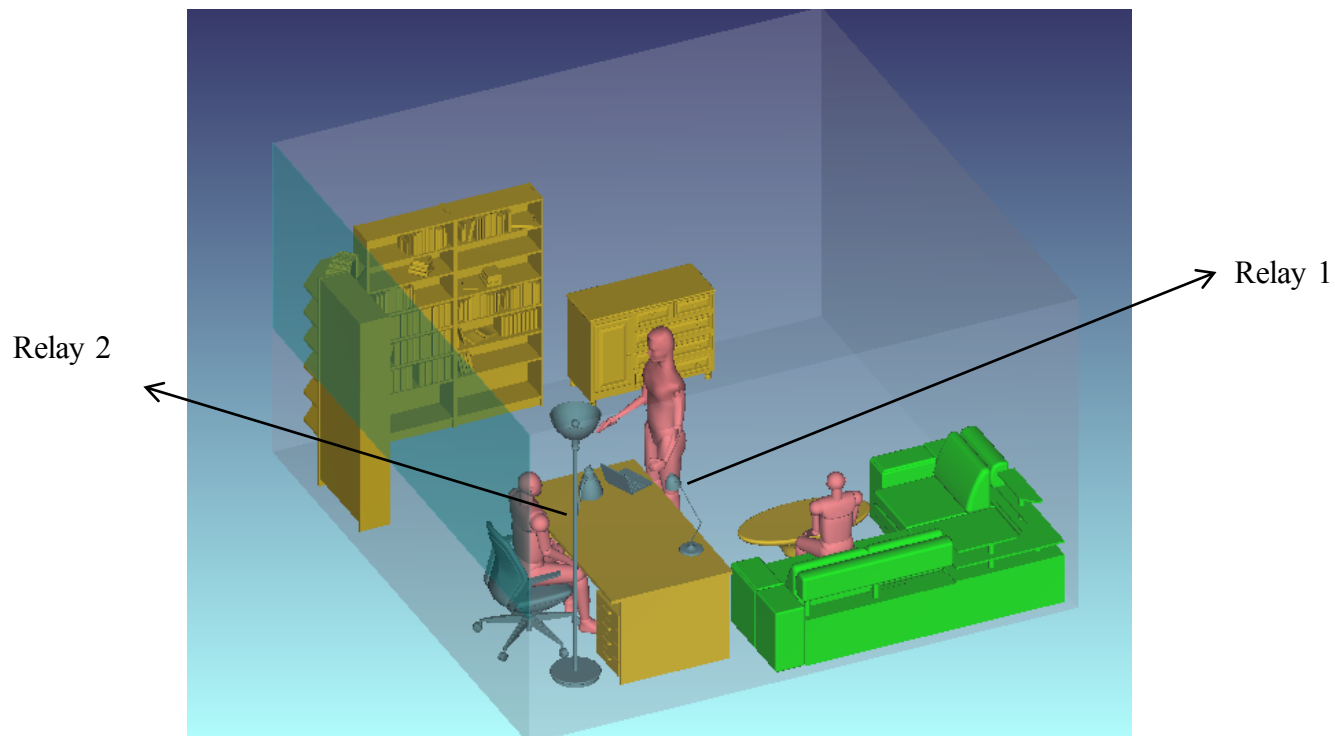

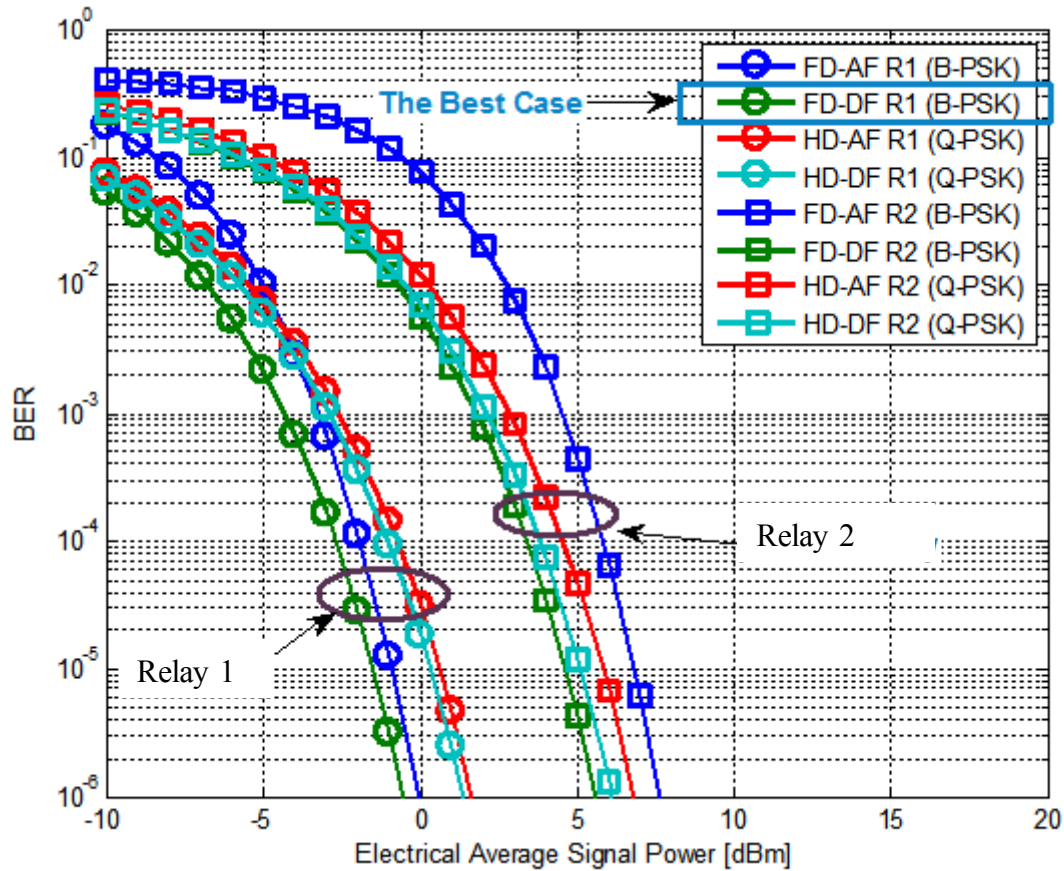

Summary

- Proposed relaying support techniques for IEEE 802.15.7.r1
- Two relaying operation: cooperative and dual-hop relaying.
- For each operation, we consider different duplexing and modes:
 - Duplexing mode: Half-Duplex (HD) and Full-Duplex (FD).
 - Relaying mode: Amplify-and-Forward (AF) and Decode-and-Forward (DF).
- Gain of cooperative operation: 1.12-5.3 dB depends on modulation level.
- Gain of dual-hop operation: ~34.3 dB.

Acknowledgement

- The work of authors Mohamed Abdallah and Khalid Qaraqe was made possible by the NPRP award [NPRP 5-980-2-411] from the Qatar National Research Fund (a member of The Qatar Foundation). The statements made herein are solely the responsibility of the author[s].
- The work of authors M. Uysal and T. Baykas is carried out as an activity of “Optical Wireless Communication Excellence Centre” funded by Istanbul Development Agency (ISTKA), Innovative Istanbul Financial Support Program 2015 (TR10/15/YNK-72 OKATEM).