

**Project: IEEE P802.15 Working Group for Wireless Personal Area Networks (WPANs)**

**Submission Title:** LOS Link Budget

**Date Submitted:** July 2015

**Source:** Rick Roberts [Intel]

Address

Voice: 503-712-5012, E-Mail: [richard.d.roberts@intel.com](mailto:richard.d.roberts@intel.com)

**Re:**

**Abstract:**

**Purpose:**

**Notice:** This document has been prepared to assist the IEEE P802.15. It is offered as a basis for discussion and is not binding on the contributing individual(s) or organization(s). The material in this document is subject to change in form and content after further study. The contributor(s) reserve(s) the right to add, amend or withdraw material contained herein.

**Release:** The contributor acknowledges and accepts that this contribution becomes the property of IEEE and may be made publicly available by P802.15.

This document is a revision of work originally presented to IEEE802.15.7 in September 2009.

September 2009

doc.: IEEE 802.15-09-0635-01-0007

**Project: IEEE P802.15 Working Group for Wireless Personal Area Networks (WPANs)**

**Submission Title:** Update on VLC Link Budget Work

**Date Submitted:** September 2009

**Source:** Rick Roberts [Intel], Zhengyuan Xu [University of California, Riverside]

Address

Voice: 503-712-5012, E-Mail: [richard.d.roberts@intel.com](mailto:richard.d.roberts@intel.com), [dxu@ee.ucr.edu](mailto:dxu@ee.ucr.edu)

**Re:**

**Abstract:** Update on the VLC link budget work. The one remaining issue is the calculation of the noise density.

**Purpose:**

**Notice:** This document has been prepared to assist the IEEE P802.15. It is offered as a basis for discussion and is not binding on the contributing individual(s) or organization(s). The material in this document is subject to change in form and content after further study. The contributor(s) reserve(s) the right to add, amend or withdraw material contained herein.

**Release:** The contributor acknowledges and accepts that this contribution becomes the property of IEEE and may be made publicly available by P802.15.

This contribution is in response to the call for channel models and address the line-of-sight OCC channel.



Intel believes that for many OCC usages, a channel model is not needed because there is no implied guaranteed quality of service since the light source is a signal of opportunity. If performance is not adequate then the user needs to move closer to the source to improve the signal-to-noise ratio. However, the automotive use case is an exception (has a QoS requirement) and will be given additional emphasis in the presentation.

## ToC

- **Radiometric (Physical) vs. Photometric (Visual)**
- **Path loss due to line-of-sight (LOS) light propagation**
- **Beam Divergence**
- **Atmospheric Attenuation Due to Fog**
- **Propagation Path Loss**
- **850 nm NIR specific analysis**
- **Appendix A: Ascertaining the LED parameters of interest**
- **Appendix B: Calculating integrated spectral flux density**
- **Appendix C: Receiver noise density calculations**
- **Appendix D: Solid angle path loss model**

# Radiometric (Physical) vs. Photometric (Visual)

The human eye and the detector diode have different frequency responses and hence perceive the same LED source differently.

A white LED spews optical power across a range of wavelengths (mW/Hz)

LED



Detector Diode



Eyeball

Spectrum Distribution

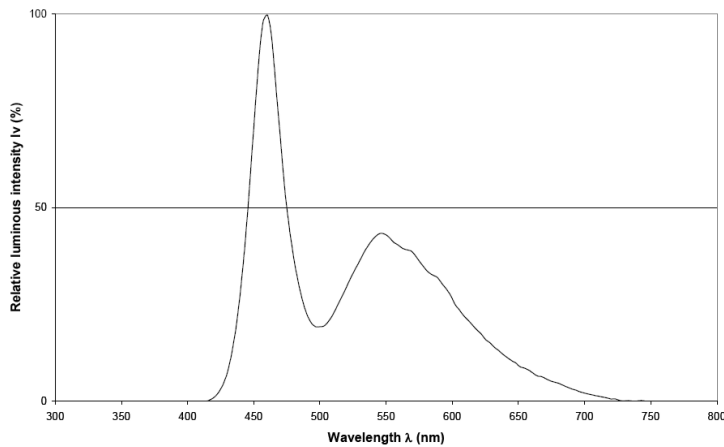

### SPECTRAL RESPONSE

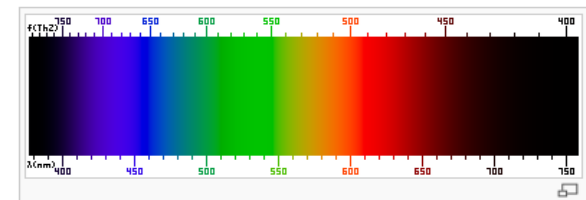
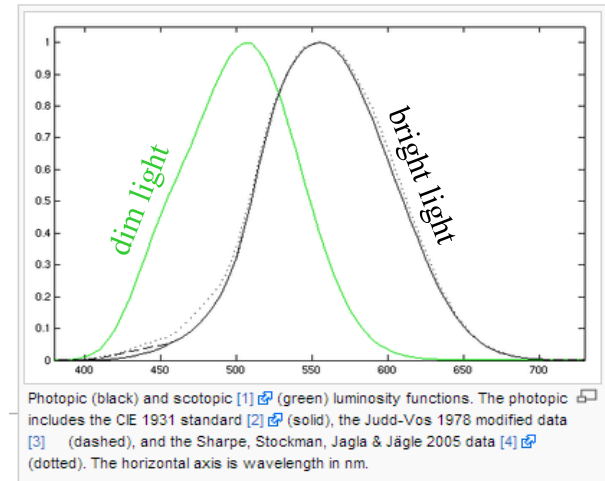
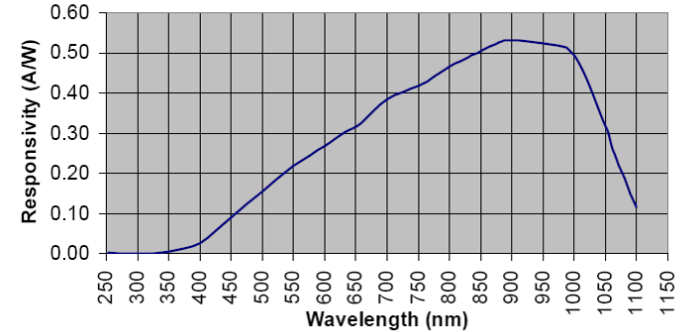

**Units**

	<b>Radiometric (Physical)</b>	<b>Photometric (Visual)</b>
<b>Total Flux</b>	Watts (W)	lumens (lm)
<b>Flux Density</b>	W/cm <sup>2</sup>	lm/cm <sup>2</sup>
<b>Source Intensity</b>	W/sr	candela = lm/sr
<b>Illuminance</b>		Lux (lx) = lm/m <sup>2</sup>
<b>Irradiance</b>	W/m <sup>2</sup>	

For data link budgets we want to use **Radiometric units**

For illumination applications we want to use **Photometric units** (which include the frequency response of the human eye)

Most VIS LED vendors generally only provide Photometric data since illumination is the market today and the use of VIS LEDs for data is an obscure usage.

Often IR LED vendors will provide radiometric data for LEDs intended for communications. Appendix A discusses a method to convert photometric units to radiometric units, but it is not recommended by the author. It is felt that the better method is to obtain radiometric data by measurement.

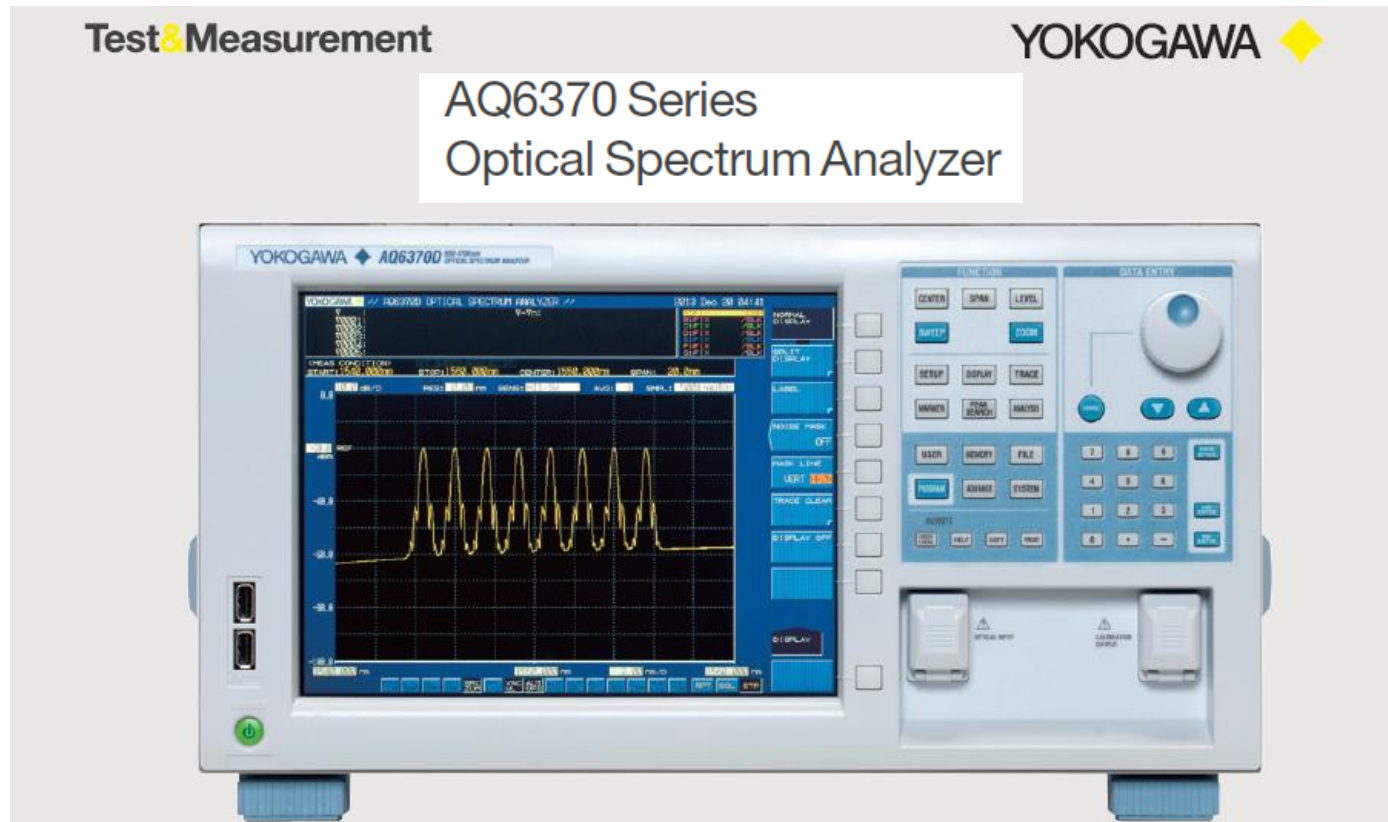

Best way to determine optical power and spectrum  
... measure it using a known aperture sensor!



# **Path loss due to line-of-sight (LOS) light propagation**

## Spherical Light Source

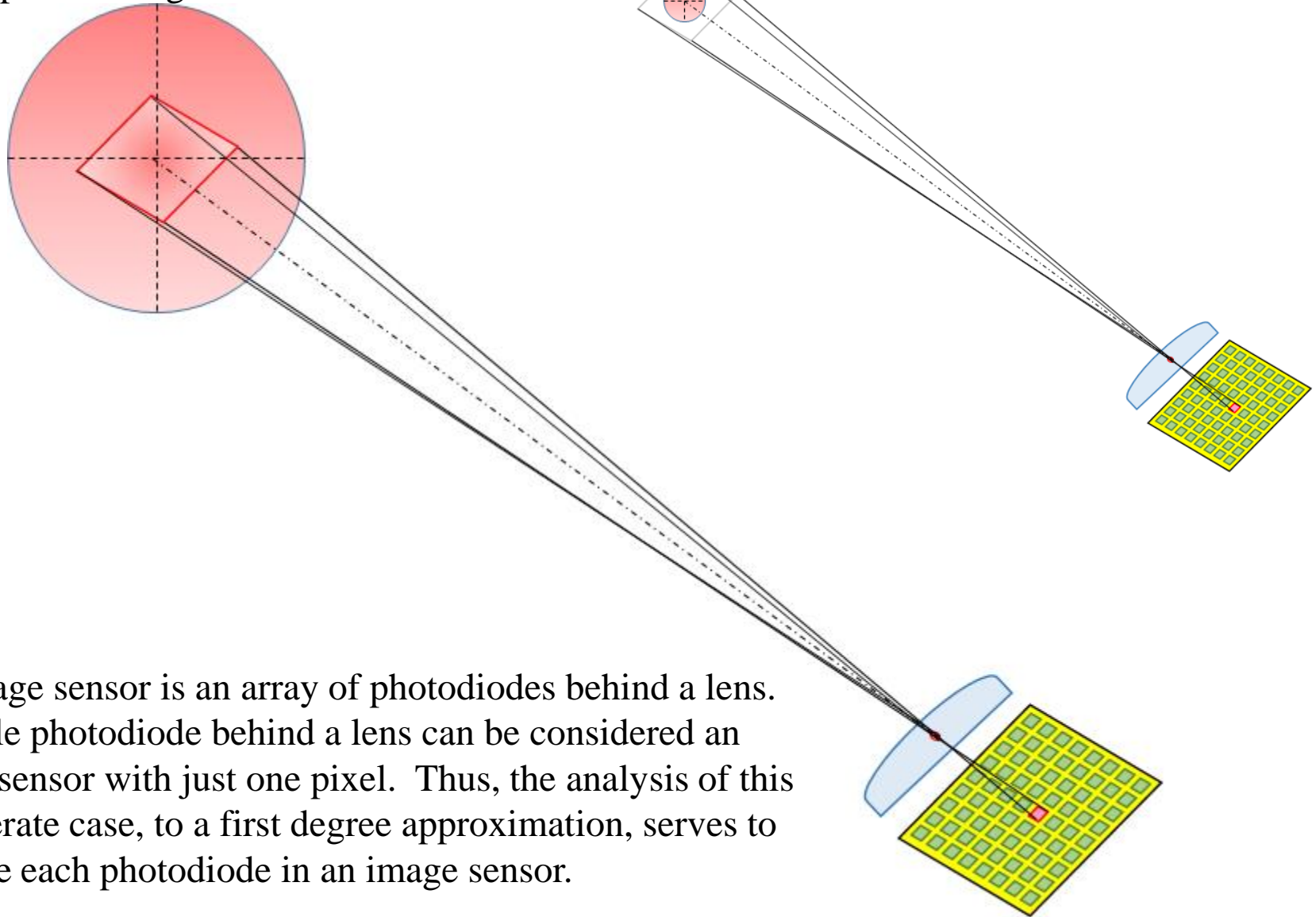

An image sensor is an array of photodiodes behind a lens. A single photodiode behind a lens can be considered an image sensor with just one pixel. Thus, the analysis of this degenerate case, to a first degree approximation, serves to analyze each photodiode in an image sensor.

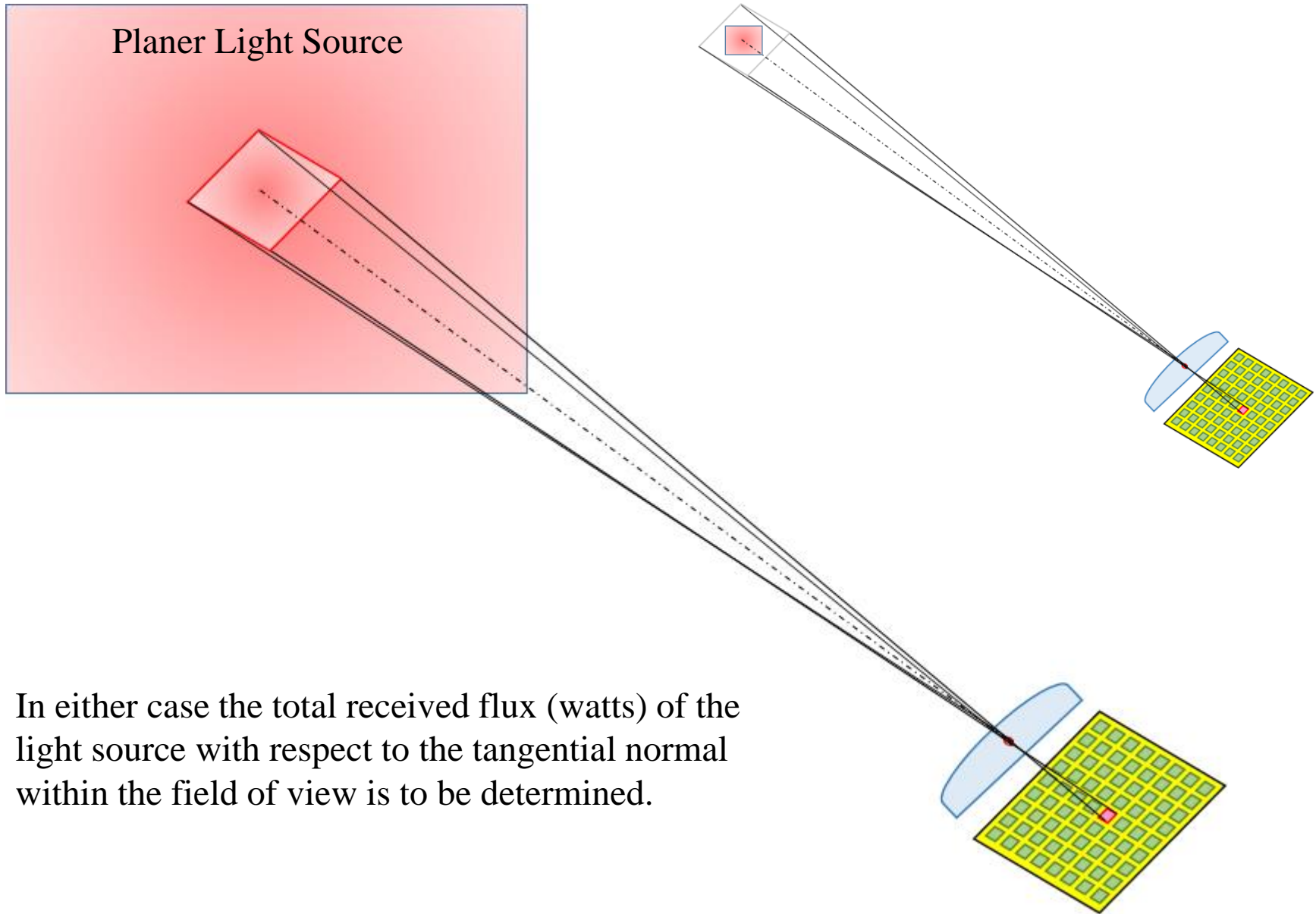

In either case the total received flux (watts) of the light source with respect to the tangential normal within the field of view is to be determined.

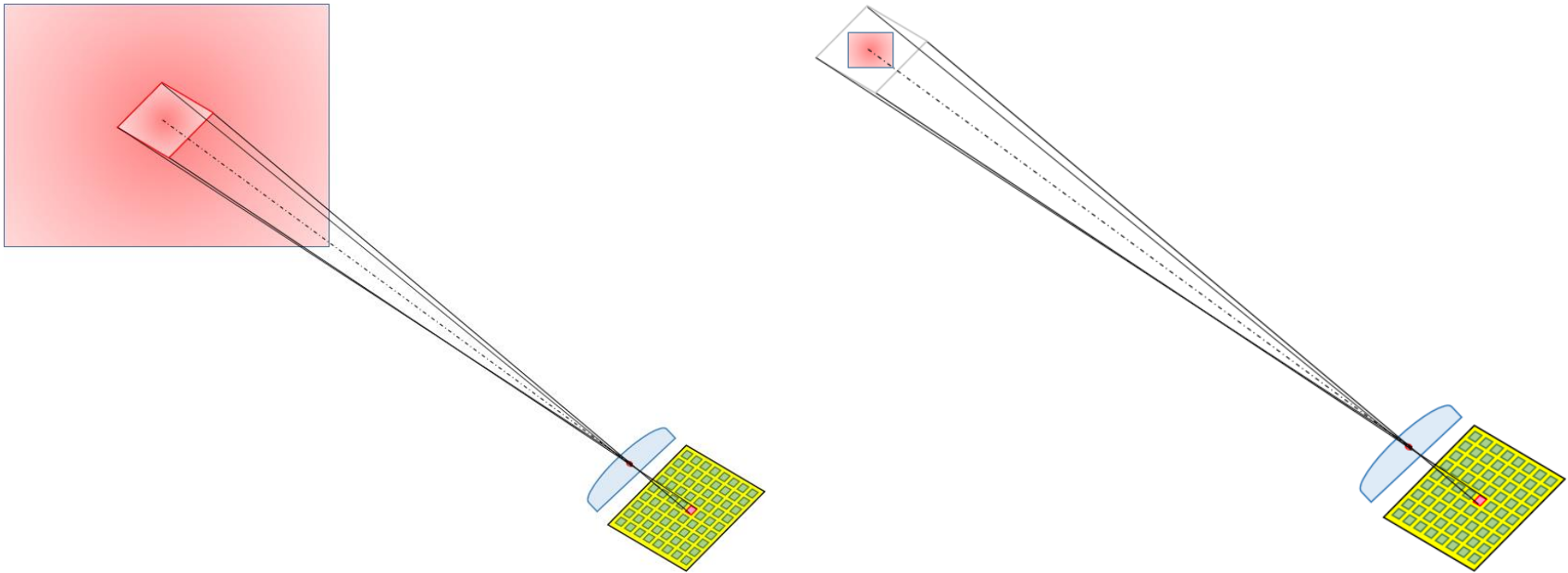

When determining the tangential normal transmitted spectral flux density (watts per unit area per wavelength  $W/m^2 \cdot nm$ ), there are obviously two cases to consider: 1) area of the source exceeds the FOV; 2) FOV exceeds the area of the source.

Case 1: Use the average flux density within the FOV.

Case 2: Use the total available flux since the total source area is within the FOV.

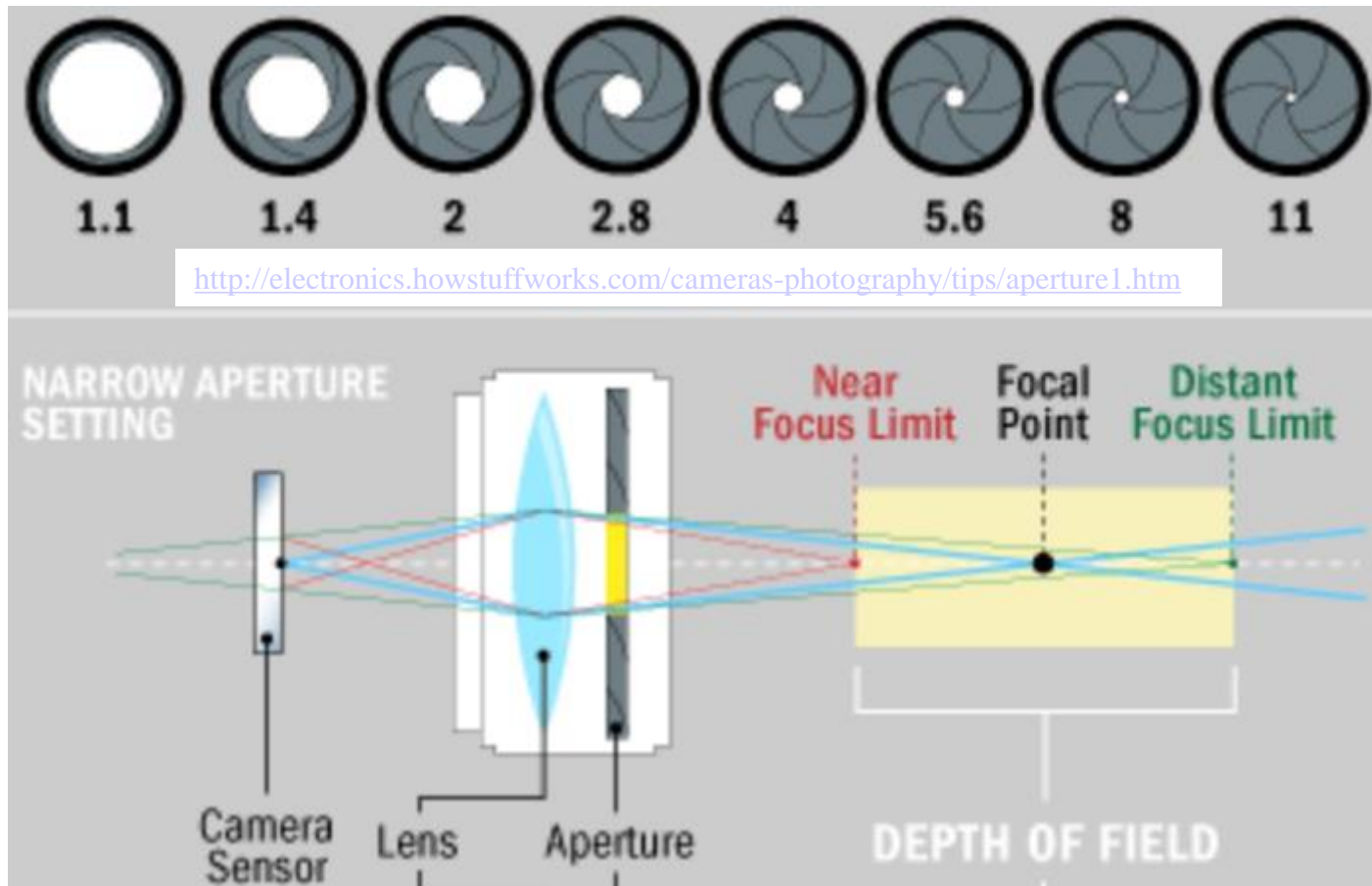

The area of the aperture opening determines the amount of light entering the camera. The total flux entering the camera is the product of the aperture area and the irradiance flux density.

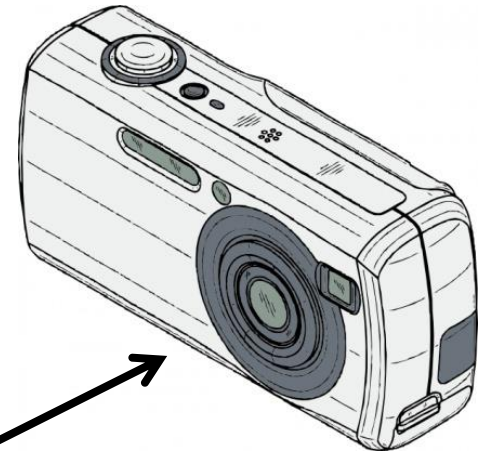
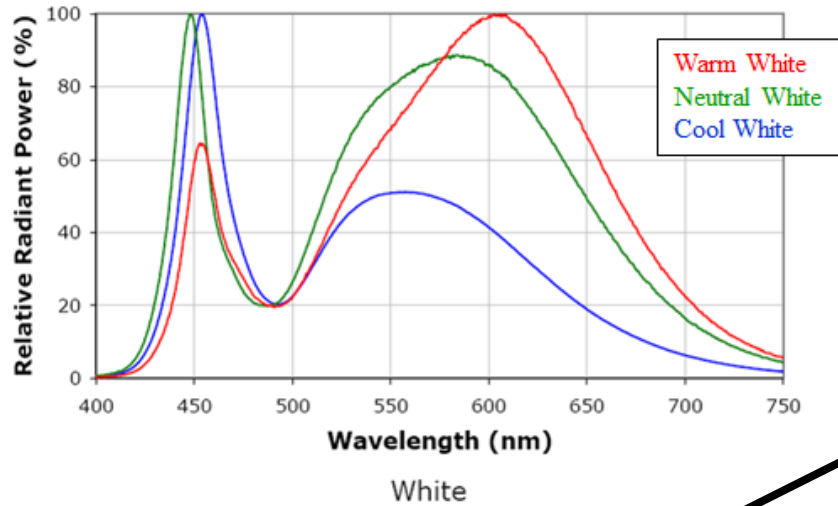

Received Spectral  
Irradiance  $\frac{Watts}{m^2 \cdot nm}$



Transmitted Spectral  
Flux Density  $\frac{Watts}{m^2 \cdot nm}$



Integration across the wavelengths  
of interest converts spectral flux  
density and spectral irradiance to  
spectral flux and irradiance  $\frac{Watts}{m^2}$ .

The detector diode vendors provide the spectral response  $\frac{A}{W}$  information.

### SPECTRAL RESPONSE

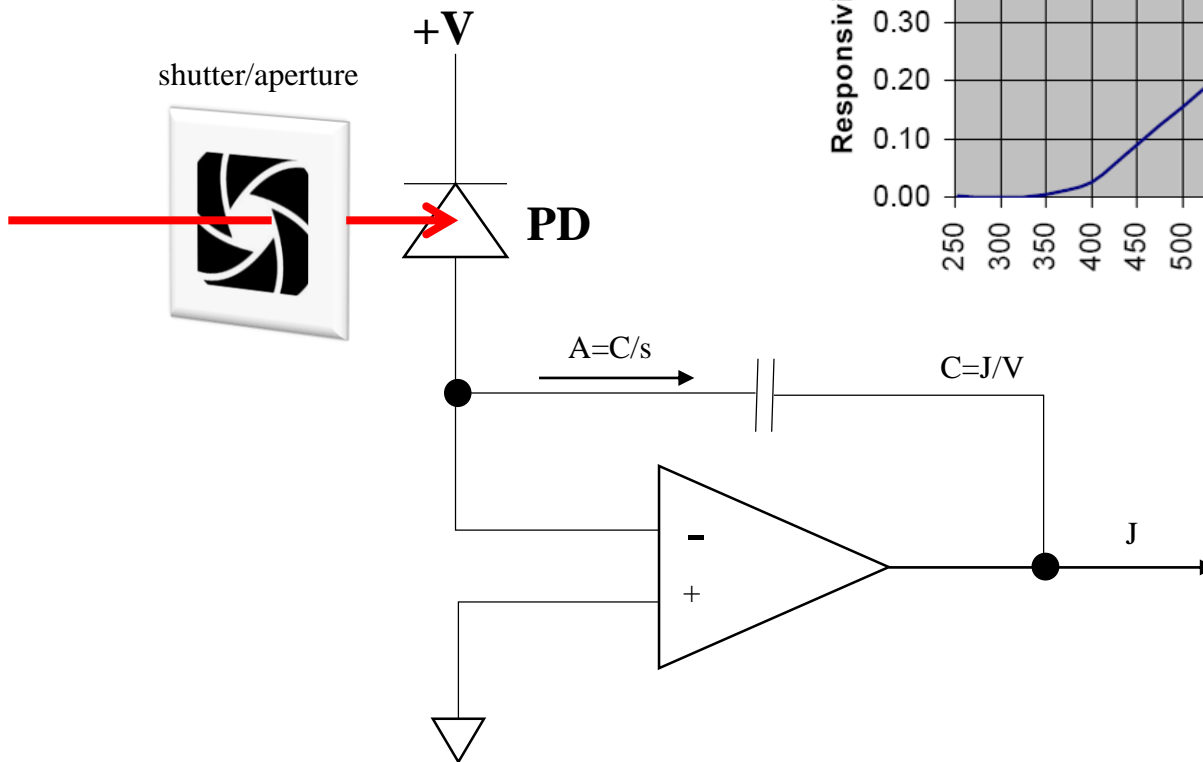
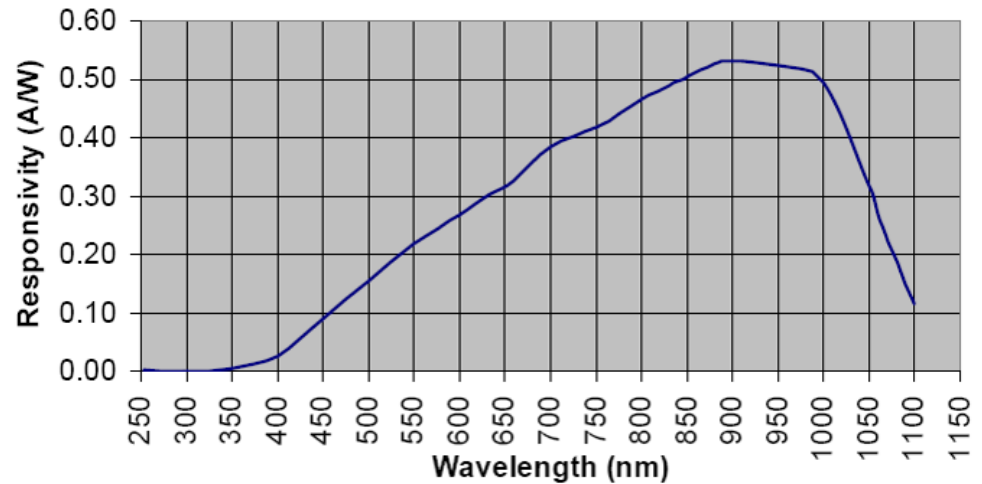

The detector diode current is integrated to provide the energy per bit in Joules.

The total current is given as the integral over wavelength of the source spectrum weighted by the photodiode wavelength dependent responsivity. Appendix B provides the mathematical details.

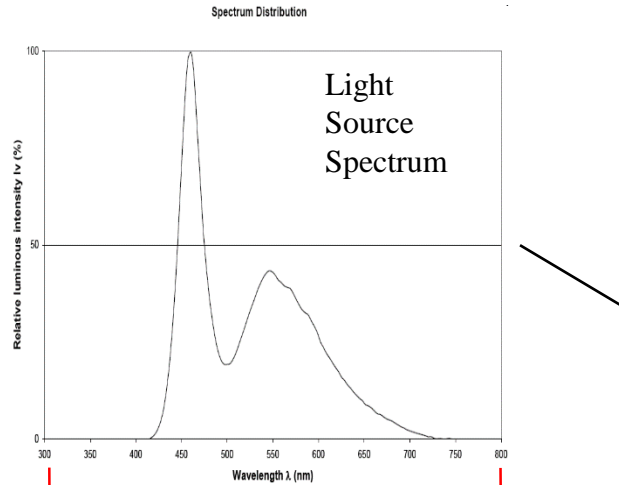

300 nm

800 nm

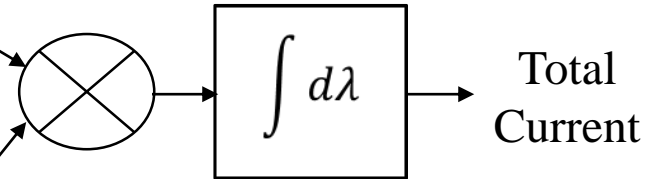
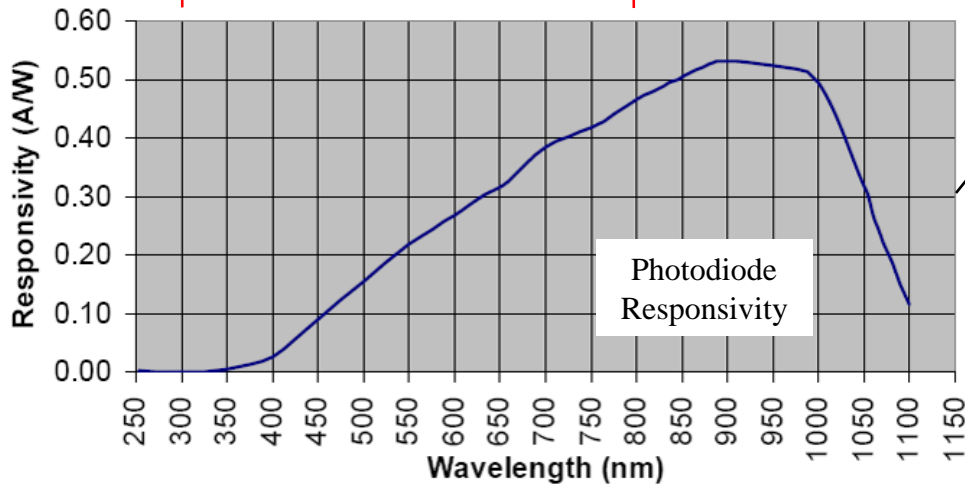



# Beam Divergence

## Beam Divergence

### Spherical Source

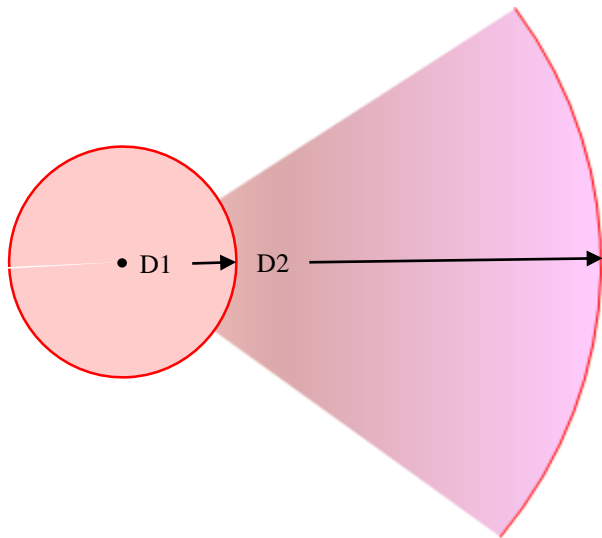

Surface power density is inversely proportional to the surface area increase: see slide 20 for details.

### Planar Source



Preferably, the light intensity divergence should be supplied by the vendor. The alternative is to measure the divergence and then use the estimates presented on slide 22.

## Camera aperture on diverged surface power density

Spherical Source

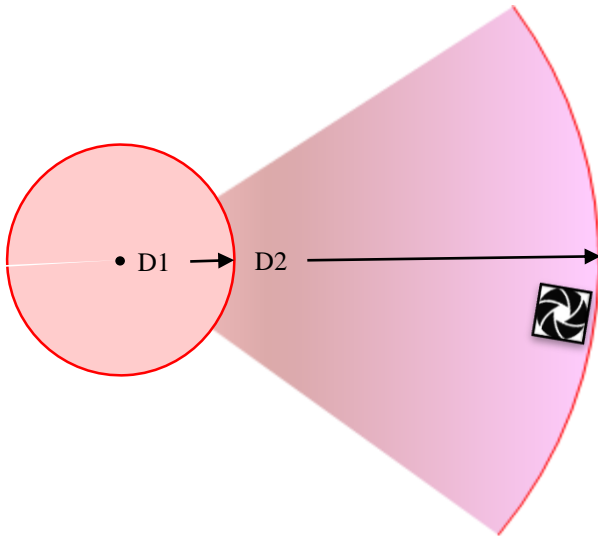

Planar Source



The camera aperture is projected on to the increased surface area, of which the surface area has reduced power density.

## Spherical Bulb Beam Divergence

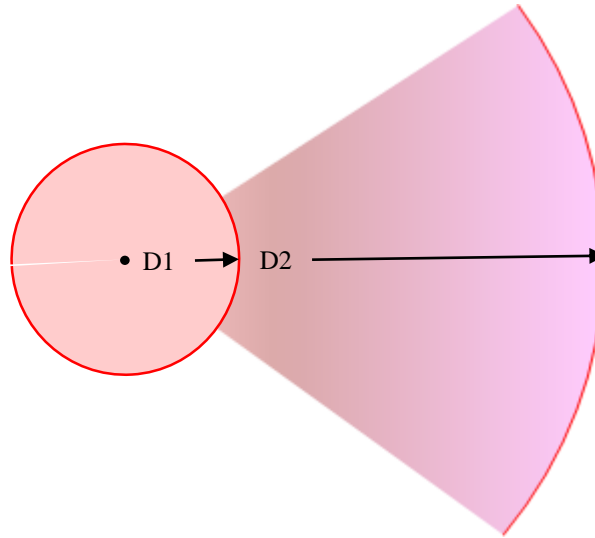

$$\text{Dispersion Loss} = 10 \cdot \log_{10} \left( \frac{A_2}{A_1} \right) = 20 \cdot \log_{10} \left( \frac{D_2}{D_1} \right)$$

For a spherical bulb, the dispersion loss is proportional to the increase in distance squared (similar to RF with an isotropic radiator).

For a spherical source, all illuminated pixels are orthonormal since they fall within the field of view.

## Light Panel Beam Divergence

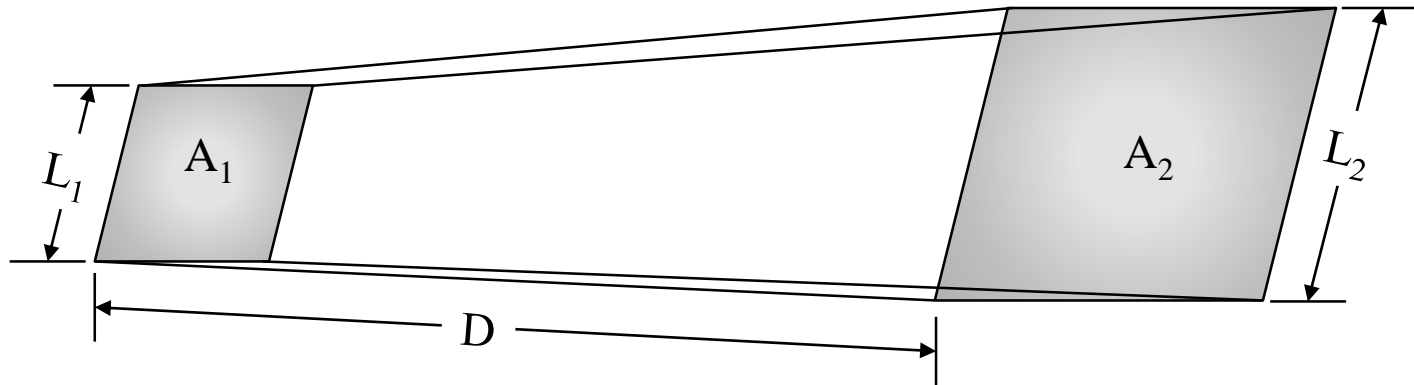

$$\text{Divergence } \theta = 2 \arctan \left( \frac{L_2 - L_1}{2 \cdot D} \right)$$

$$L_2 = 2 \cdot D \cdot \tan \left( \frac{\theta}{2} \right) + L_1$$

Squaring both sides

$$A_2 = 4 \cdot D^2 \cdot \tan^2 \left( \frac{\theta}{2} \right) + 2 \cdot D \cdot L_1 \cdot \tan \left( \frac{\theta}{2} \right) + A_1$$

$$\frac{A_2}{A_1} = \frac{4 \cdot D^2 \cdot \tan^2\left(\frac{\theta}{2}\right)}{A_1} + \frac{2 \cdot D \cdot L_1 \cdot \tan\left(\frac{\theta}{2}\right)}{A_1} + 1$$

$$\frac{A_2}{A_1} \propto \frac{4 \cdot D^2 \cdot \tan^2\left(\frac{\theta}{2}\right)}{A_1}$$

Observations on panel light dispersion:

1. dispersion is proportional to dispersion angle
2. dispersion increases as distance squared
3. dispersion is inversely proportional to the size of the panel
4. the area ratio  $\geq 1.0$

$$\text{Dispersion Loss} = 10 \cdot \log_{10}\left(\frac{A_2}{A_1}\right)$$

The light panel source case can also experience additional loss due to camera viewing angle.

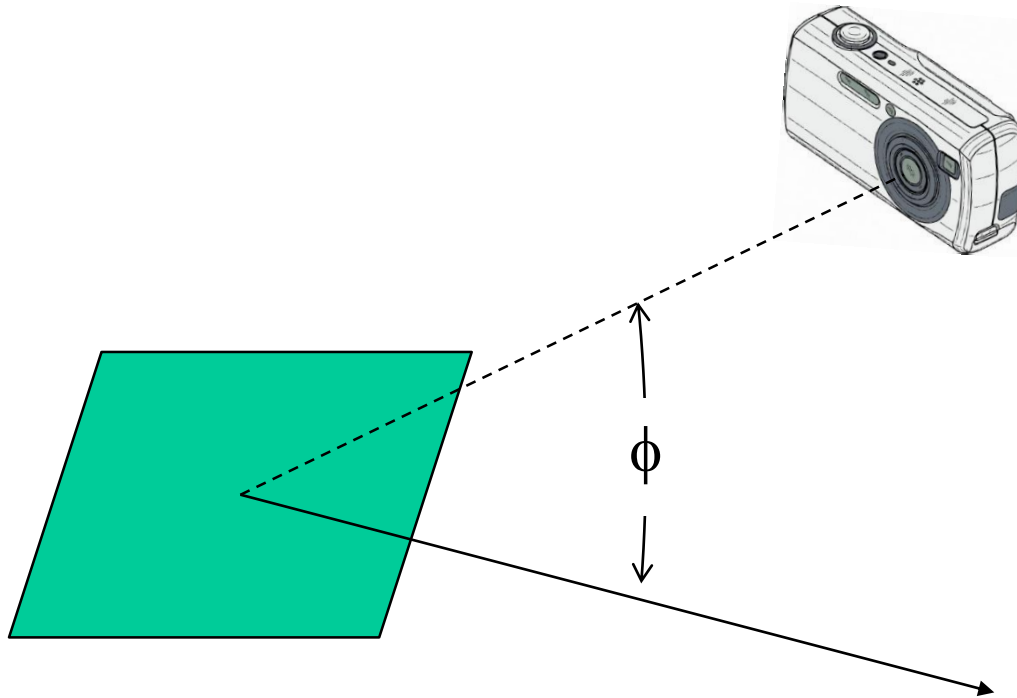

A precise analysis would require vendor data on the light panel angular radiation. Lacking such data, an approximation can be made as

$$\text{Angular Loss} \approx 10 \cdot \log_{10}\{\cos(\Phi)\}.$$

# Atmospheric Attenuation Due to Fog



From the paper by Kim, et. al. ...

$$\Lambda(dB/km) = 10 \cdot \log_{10} \left( e^{\left\{ \frac{3.91}{V} \left[ \frac{\lambda}{550 \text{ nm}} \right]^{-q} \right\}} \right)$$

where  $V$  = visibility in km

$\lambda$  = wavelength in nm

$q$  = the size distribution of the scattering particles

= 1.6 for high visibility ( $V > 50$  km)

= 1.3 for average visibility ( $6 \text{ km} < V < 50 \text{ km}$ )

=  $0.16 V + 0.34$  for haze visibility ( $1 \text{ km} < V < 6 \text{ km}$ )

=  $V - 0.5$  for mist visibility ( $0.5 \text{ km} < V < 1 \text{ km}$ )

= 0 for fog visibility ( $V < 0.5 \text{ km}$ )

For the most part, the distances of interest are much less than a kilometer so we can express this on a per meter basis as

$$\Lambda(dB/m) = 0.01 \cdot \log_{10} \left( e^{\left\{ \frac{3.91}{V} \left[ \frac{\lambda}{550 \text{ nm}} \right]^{-q} \right\}} \right)$$

*Comparison of laser beam propagation at 785 nm and 1550 nm in fog and haze for optical wireless communications;*

Isaac I. Kim, Bruce McArthur, and Eric Korevaar; [www.ece.mcmaster.ca/~hranilovic/woc/resources/local/spie2000b.pdf](http://www.ece.mcmaster.ca/~hranilovic/woc/resources/local/spie2000b.pdf)

# Fog and Haze Attenuation by Wavelength

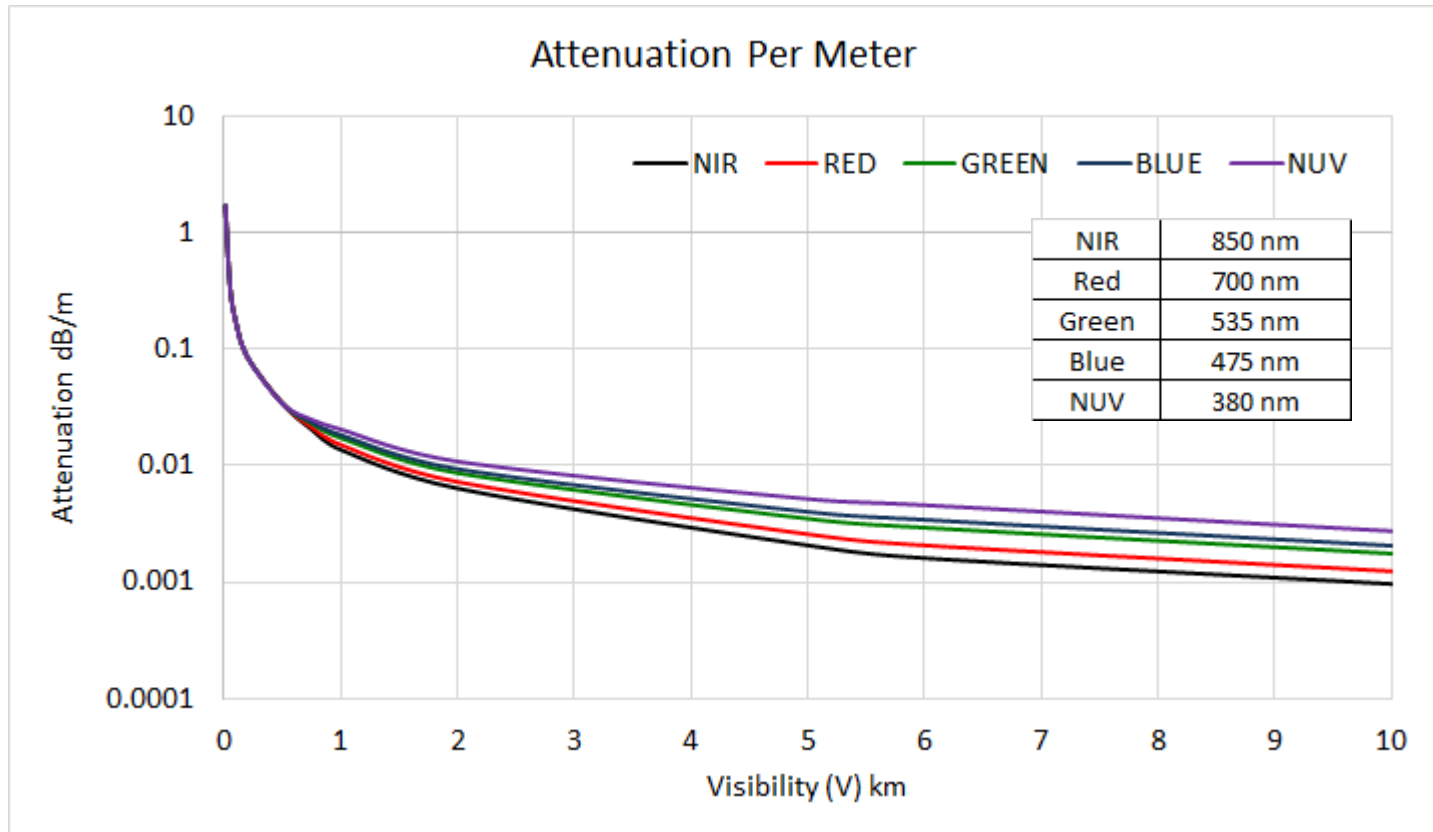

**fog**
**haze**
**clear**

# Fog and Haze Attenuation by Wavelength

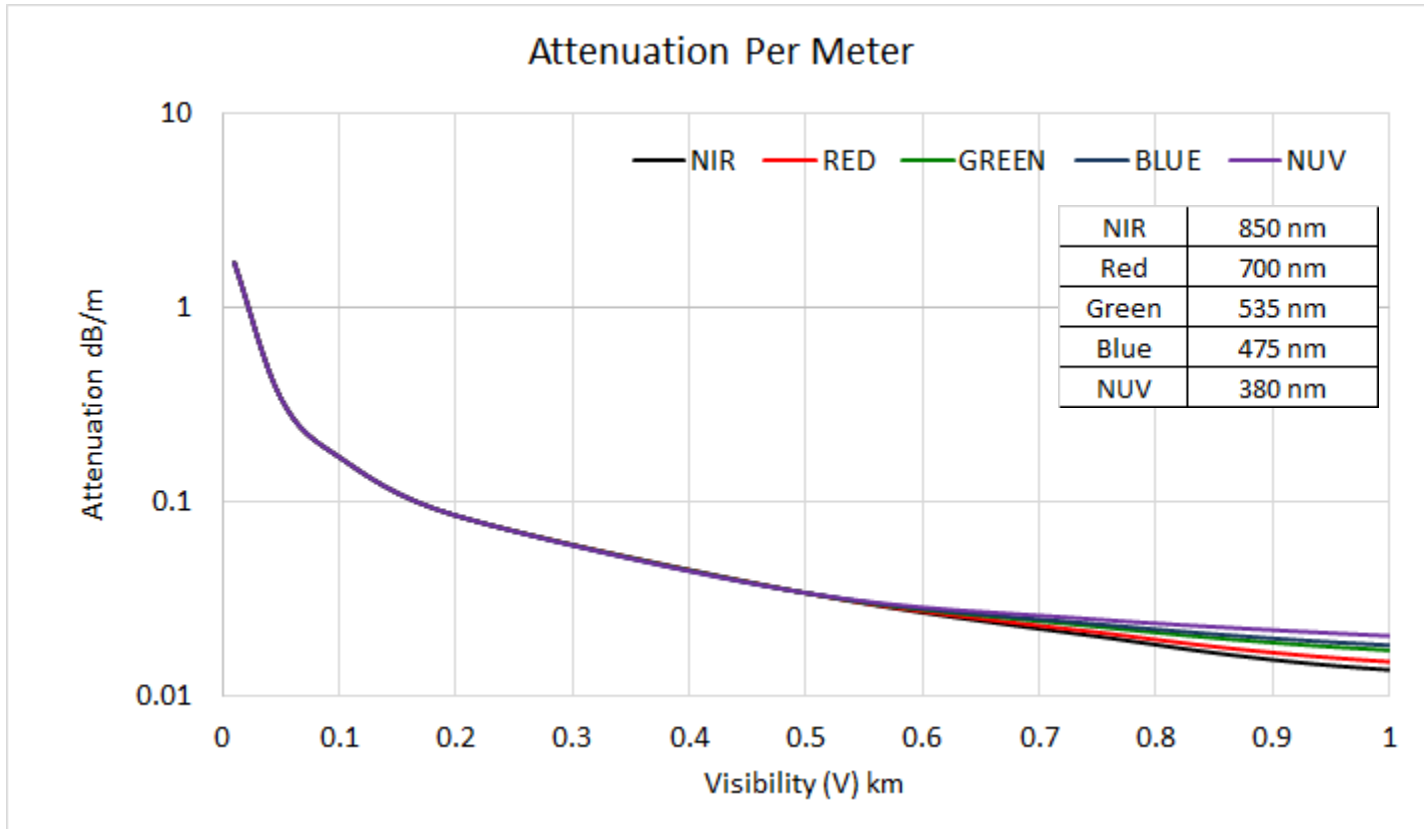

**heavy fog** **light fog**

# Propagation Path Loss

Propagation Loss (dB) = Dispersion Loss (dB) + Angular Loss (dB) +  $\Lambda$ (dB/m) · distance (m)

Ingested Flex (W) = Source Flex Density · Propagation Loss (ratio)

The signal-to-noise ratio (SNR) is defined as the ratio of the ingested flex to the receiver noise. The receiver noise can be either calculated or measured. Given real hardware, it is probably easier to measure the noise than calculate it since such calculations would require extensive knowledge of the receiver structure. Nevertheless, appendix C outlines a method of doing the calculations.

# 850 nm NIR specific analysis

# IEC60825 NIR Safety Limits

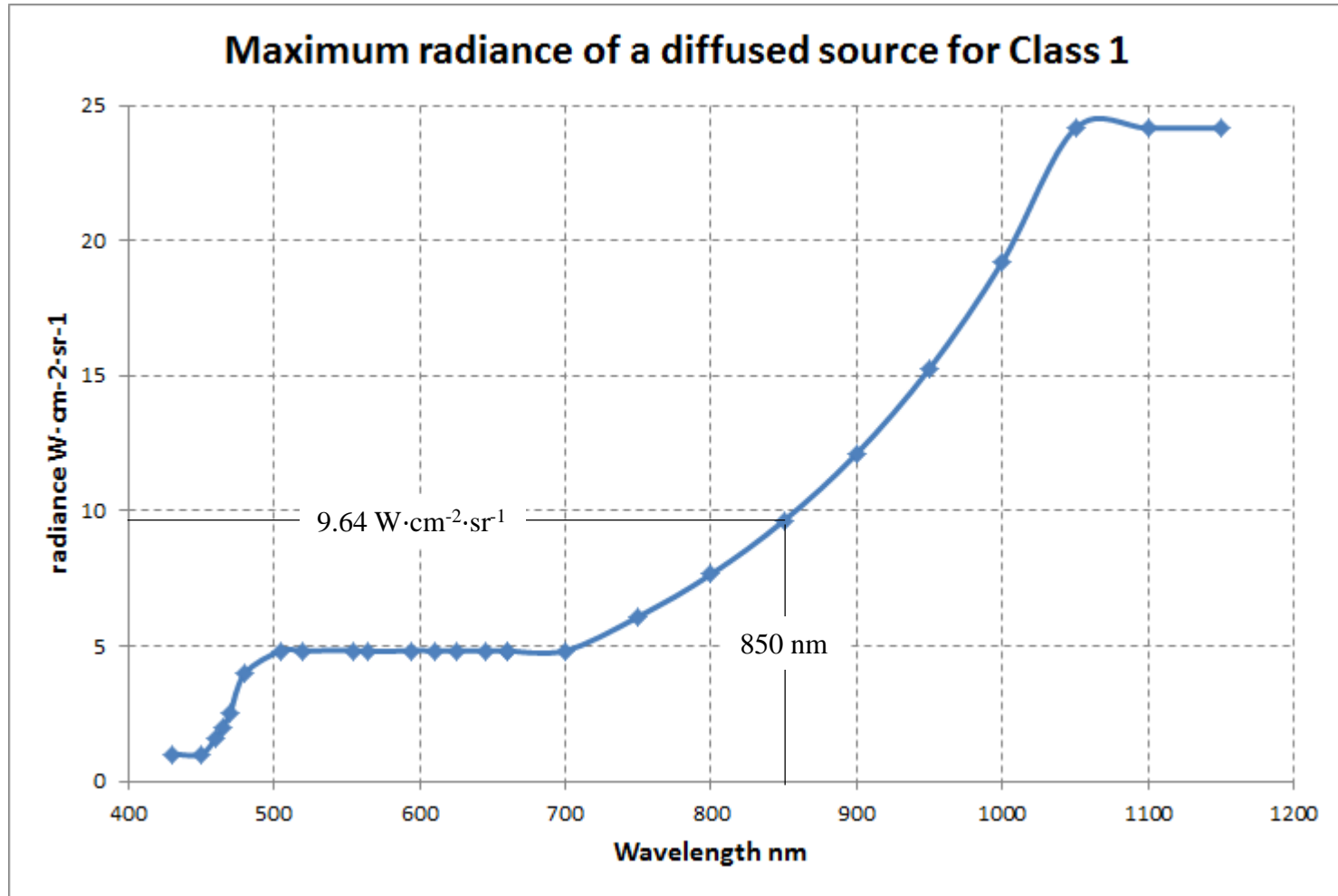

Example of Class 1 laser device – e.g. laser pointer      *Note:  $9.64 W \cdot cm^{-2} \cdot sr^{-1}$  is bright ... but SUN radiance is  $2.4 kW \cdot cm^{-2} \cdot sr^{-1}$*

# Interpretation of IEC60825 NIR Safety Limits

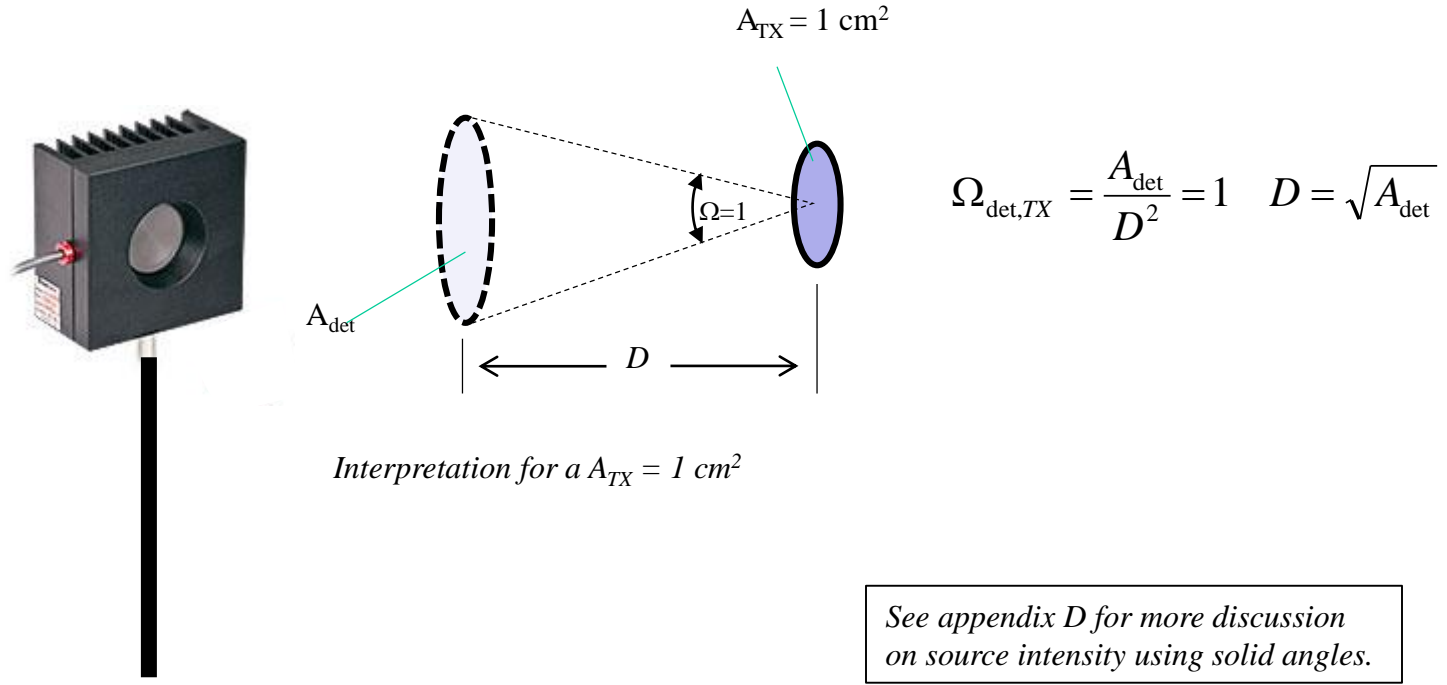

To a first order approximation ...  
 ... how much power is ingested by the detector?

$$P_{det} = A_{TX} \text{ cm}^2 \cdot 9.6 \frac{\text{W}}{\text{cm}^2 \cdot \text{sr}} \cdot \Omega_{det,TX} \text{ sr} = (9.6 \cdot A_{TX}) \cdot \left( \frac{A_{det}}{D^2} \right) \text{ W}$$

$$P_{TX} = (9.6 \cdot A_{TX}) \text{ W} \quad L_{channel} = \frac{A_{det}}{D^2}$$



## Receiver Noise

Receiver noise floor is a mixture of thermal noise and shot noise.

$$S_{total}(f) = S_{shot}(f) + S_{thermal}(f)$$

The biggest contributor to shot noise is the ambient solar spectral irradiance on a bright sunny day.

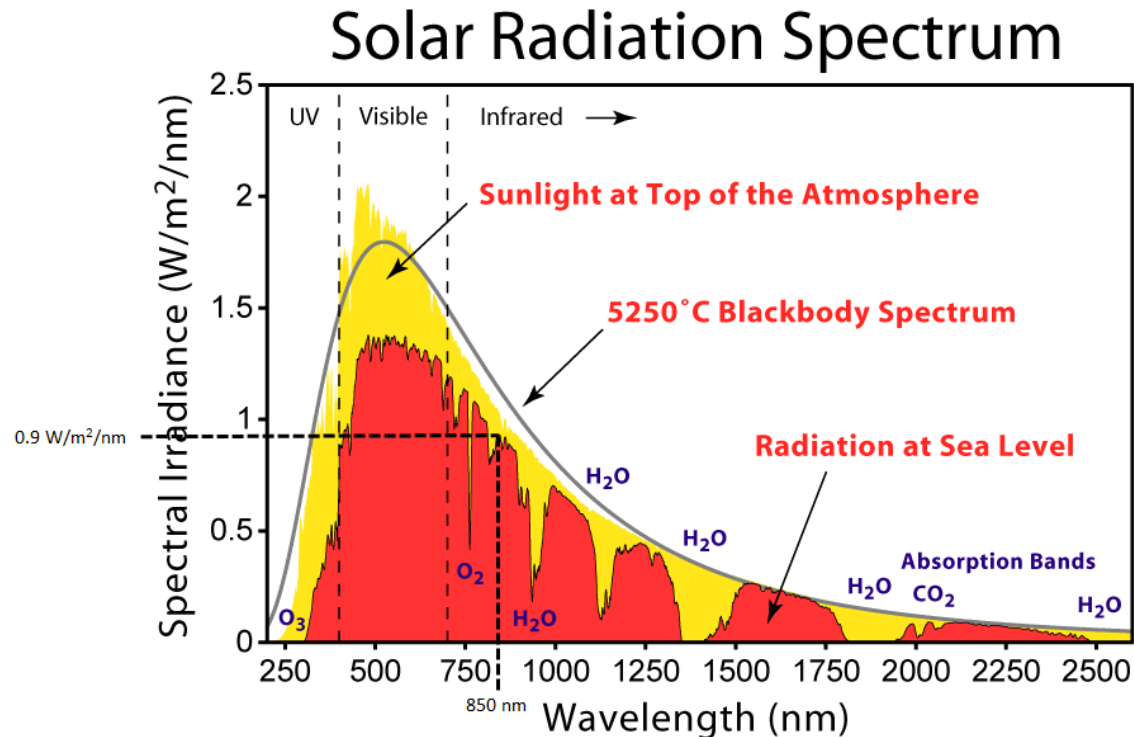

*Sun spectral irradiance at 850 nm (sea level): 90  $\mu$ W/cm<sup>2</sup>/nm*

*Shot noise is caused by the random arrival time of photons from a light source.*

# Impact of Fog Attenuation

What is the relationship between the perceived fogginess and the NIR (850 nm) attenuation?

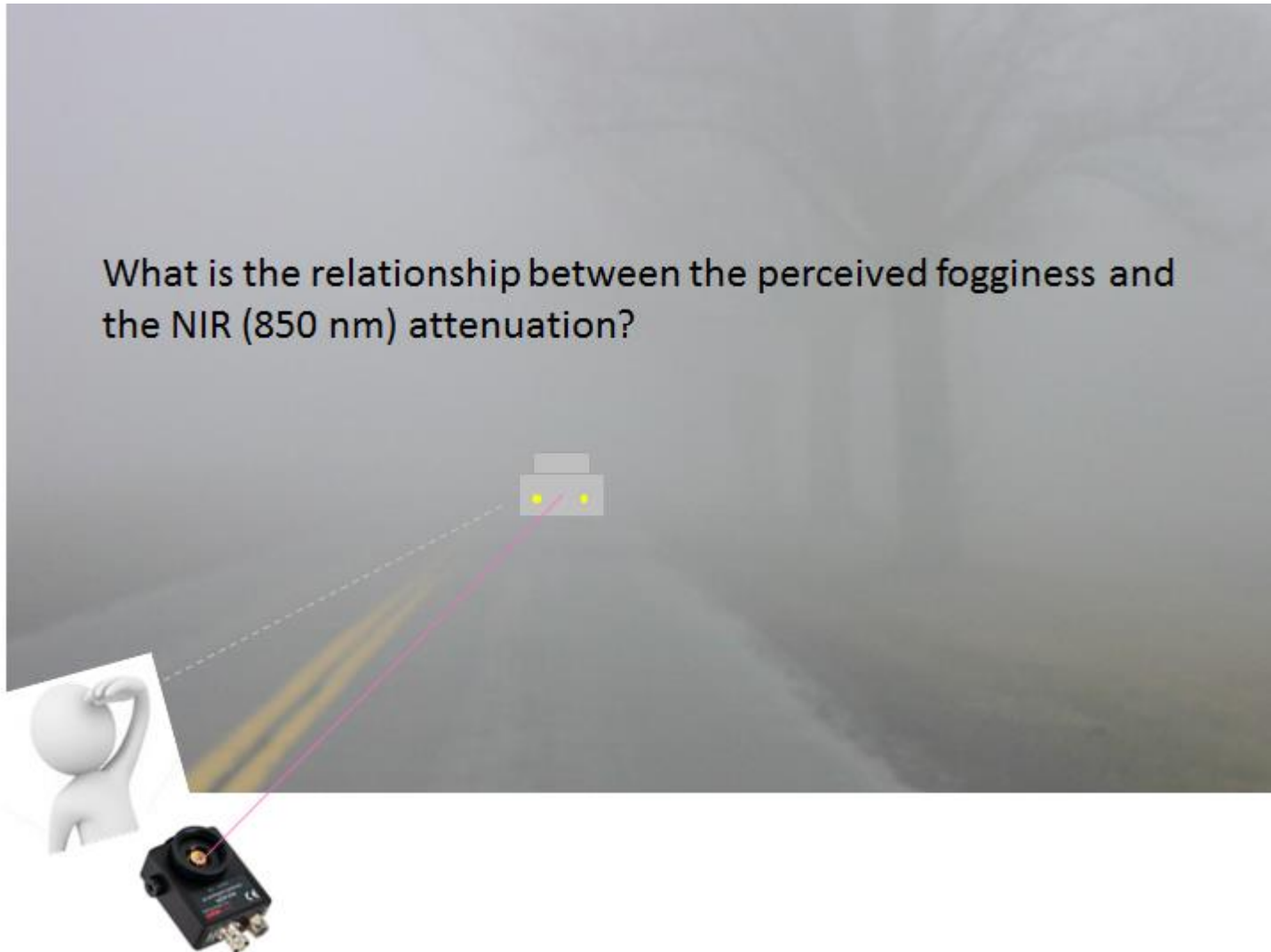

### 850 nm Attenuation Per Meter in Fog

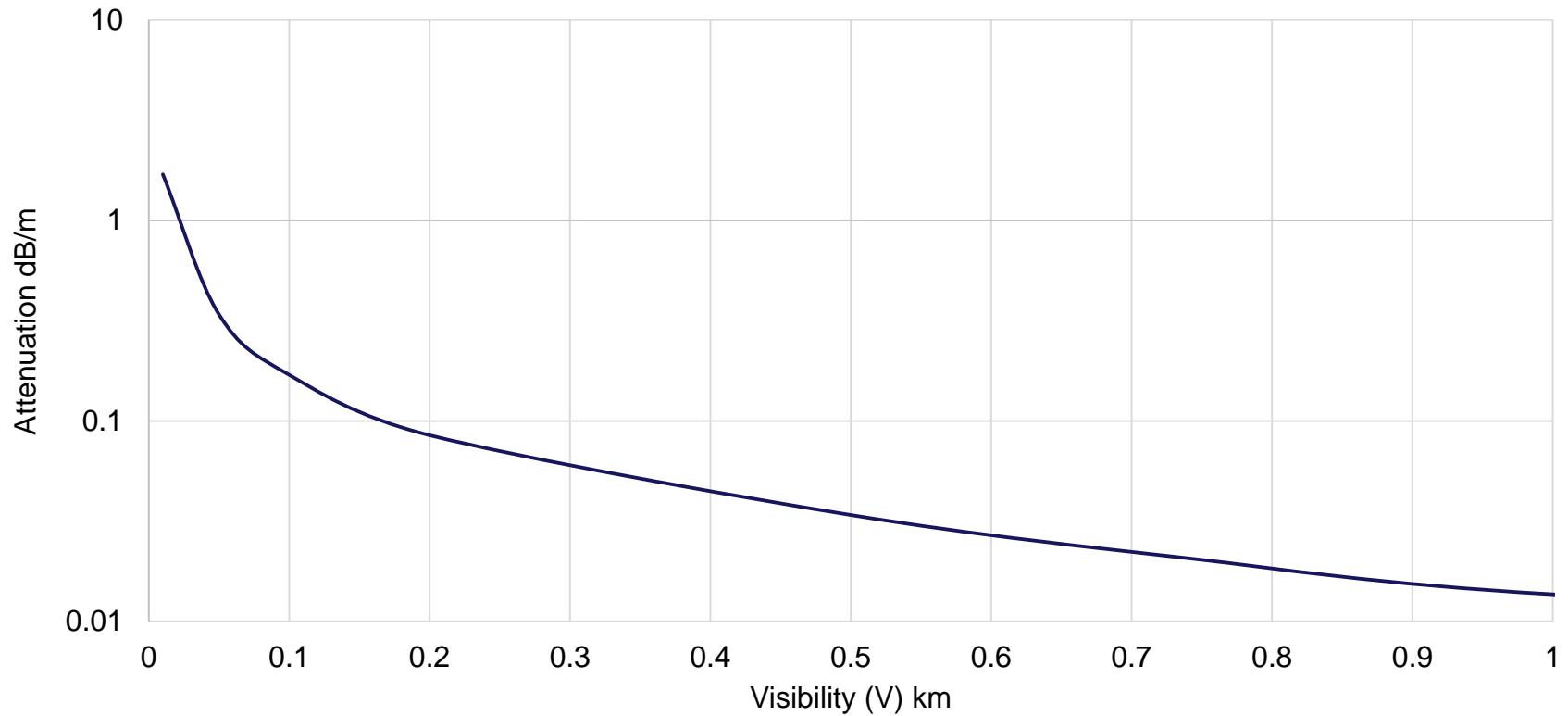

$$L_{total}|_{dB} = L_{channel}|_{dB} + L_{fog}|_{dB} = -10\log\left(\frac{A_{det}}{D^2}\right) + \alpha_m \cdot D$$

# Reaction Time and Stopping Distance Implications

<http://easycalculation.com/engineering/civil/vehicle-stopping-distance.php>

### Assumptions:

- road coefficient of friction: 0.8
- reaction time: 2.5 secs (typical)
- road grade: level

## Visibility Distance vs. Speed

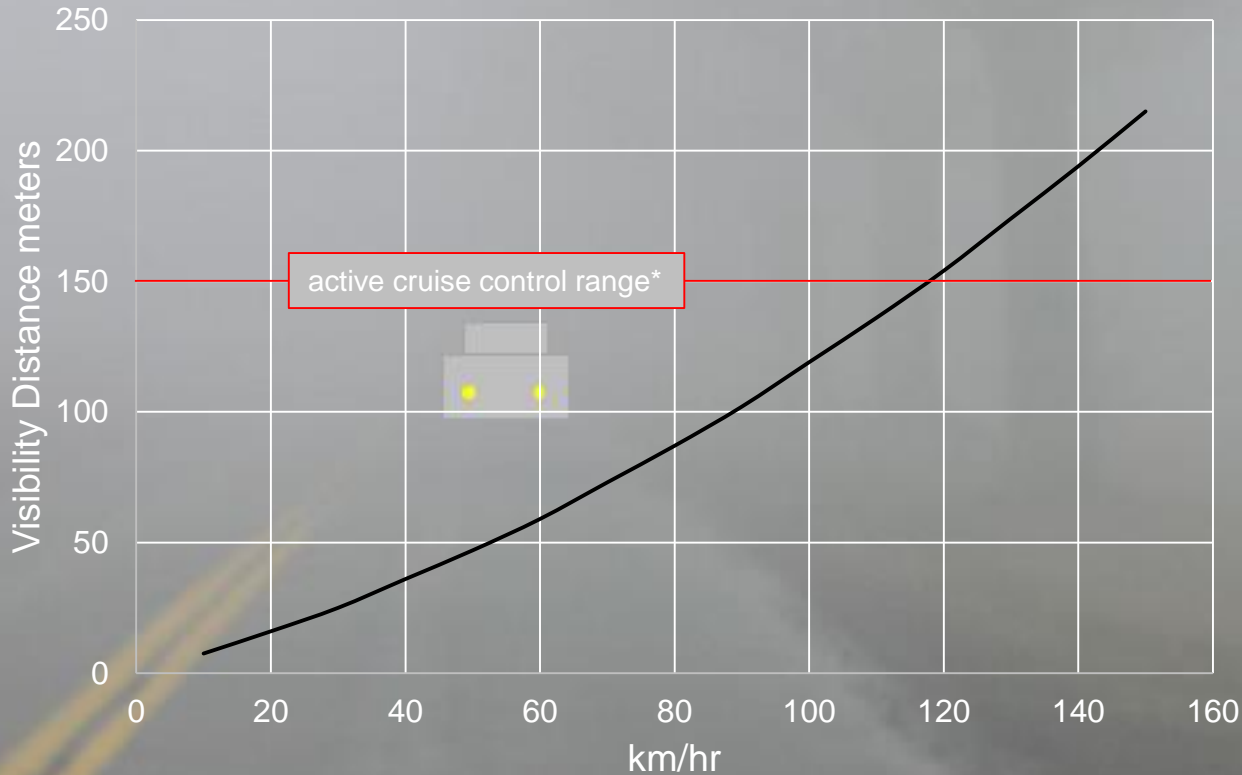

*Automotive Industry Dilemma: what to do when the sensor technology out performs the human eye? Do we encourage blind driving?*

\*[http://www.bmw.com/com/en/insights/technology/technology\\_guide/articles/active\\_cruise\\_control\\_stop\\_go.html](http://www.bmw.com/com/en/insights/technology/technology_guide/articles/active_cruise_control_stop_go.html)

# Example Link Analysis

$$A_{\text{det}} = \pi \text{ cm}^2$$

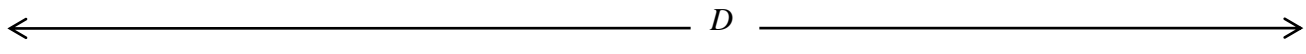

$$A_{\text{TX}} = \pi \text{ cm}^2$$

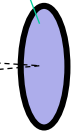

**UNDER CONSTRUCTION**

**A detailed 850 nm link budget will be presented as part of the Intel proposal to IEEE802.15.7r1.**



# Appendices

# Appendix A

## Ascertaining the LED parameters of interest

On the following pages, equation (2.2.1) and Figure 2.1.1 are from the book *Introduction to Solid-State Lighting* by A. Zukauskas, et.al. The equation relates the power spectral distribution  $S(\lambda)$  (W/nm) to luminous flux  $\Phi_v$  (lm).

# Find transmitted power and spectral density

The LED total luminous flux  $F_t$  (lumens) is given as 
$$F_t = 683 \int_{380nm}^{780nm} S_t(\lambda)V(\lambda)d\lambda \quad (2.2.1)$$

$V(\lambda)$  is the relative luminous efficiency function defined by CIE and given in the table (from internet) and curve (from the book Fig 2.1.1)

Wavelength (nm)	Photopic Luminous Efficiency $V(\lambda)$	Wavelength (nm)	Photopic Luminous Efficiency $V(\lambda)$
380	0.00004	580	0.870
390	0.00012	590	0.757
400	0.0004	600	0.361
410	0.0012	610	0.503
420	0.0040	620	0.381
430	0.0116	630	0.265
440	0.023	640	0.175
450	0.038	650	0.107
460	0.060	660	0.061
470	0.091	670	0.032
480	0.139	680	0.017
490	0.208	690	0.0082
500	0.323	700	0.0041
510	0.503	710	0.0021
520	0.710	720	0.00105
530	0.862	730	0.00052
540	0.954	740	0.00025
550	0.995	750	0.00012
560	0.995	770	0.00003
570	0.952		

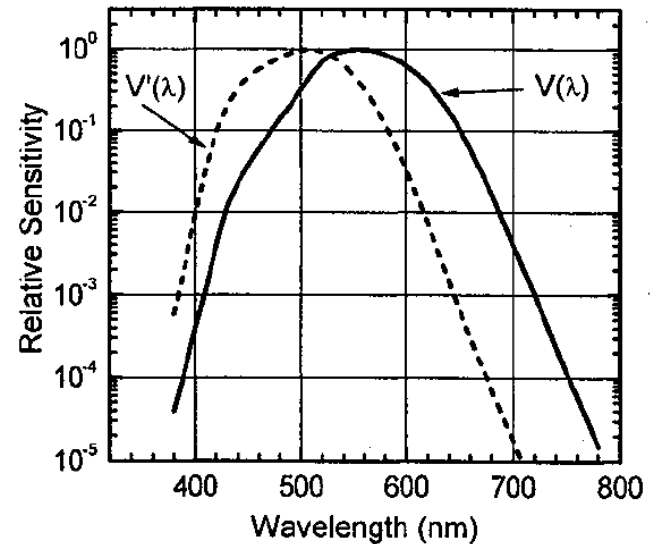

Fig 2.1.1

Sometimes it is convenient to use a Gaussian curve fitting for  $V(\lambda)$  (from internet)

$$V(\lambda) \cong 1.019e^{-285.4(\lambda-0.559)^2}, \quad \lambda : \text{in } \mu\text{m}$$



Typically we only know a normalized spectral curve  $S_t'(\lambda)$  instead of  $S_t(\lambda)$  in (2.2.1). Denote their relation as  $S_t(\lambda) = c_t S_t'(\lambda)$  with an unknown scaling factor  $c_t$  that can be found from

$$F_t = c_t \cdot 683 \int_{380nm}^{780nm} S_t'(\lambda) V(\lambda) d\lambda \quad \longrightarrow \quad c_t = \frac{F_t}{683 \int_{380nm}^{780nm} S_t'(\lambda) V(\lambda) d\lambda}$$

$$S_t(\lambda) = c_t S_t'(\lambda)$$

$$P_t = \int_{\lambda_L}^{\lambda_H} S_t(\lambda) d\lambda$$

Remark:

The above step to find  $S_t(\lambda)$  can be skipped if  $S_t(\lambda)$  can be either measured using a spectrometer or supplied by the LED vendor.

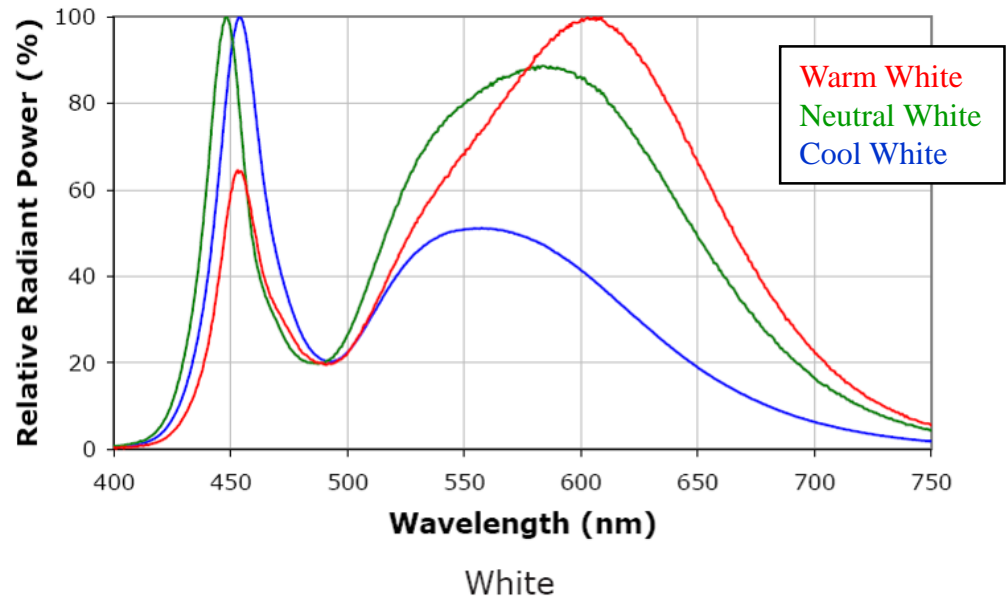

# Find transmitter luminous spatial intensity distribution $I_0 g_t(\theta)$

A normalized spatial luminous intensity distribution  $g_t(\theta)$  is provided by a vendor. We need to find the axial intensity  $I_0$  that is defined as the luminous intensity (candelas) on the axis of the source (zero solid angle). Since the luminous flux  $F_t$  is also a spatial integral of spatial luminous intensity in addition to spectral integral we used before, we have the following relation

$$F_t = \int_0^{\Omega_{\max}} I_0 * g_t(\theta) d\Omega = I_0 \int_0^{\theta_{\max}} 2\pi g_t(\theta) \sin \theta d\theta$$

$$\longrightarrow I_0 = \frac{F_t}{\int_0^{\theta_{\max}} 2\pi g_t(\theta) \sin \theta d\theta}$$

where  $\Omega_{\max}$  and  $\theta_{\max}$  are the source beam solid angle and maximum half angle respectively and  $\Omega_{\max} = 2\pi(1 - \cos\theta_{\max})$ .

Note: if the axial intensity is provided by the vendor then one only need convert the intensity from candelas to watts/sr.

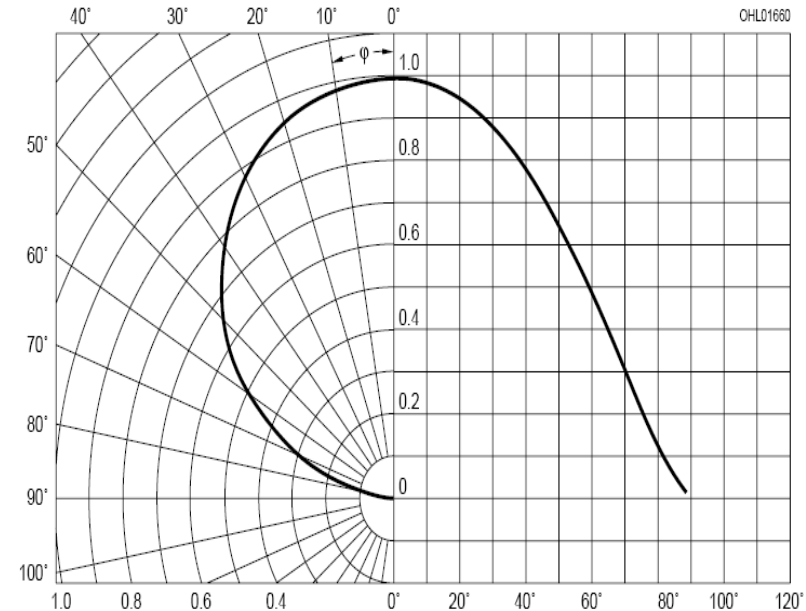

normalized spatial luminous intensity distribution

## Appendix B

# Calculating Integrated Spectral Flex Density

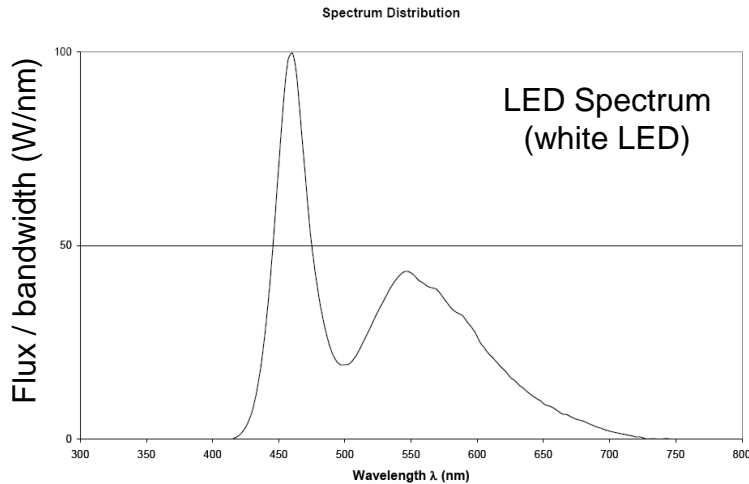

This is the information we need from the LED vendor

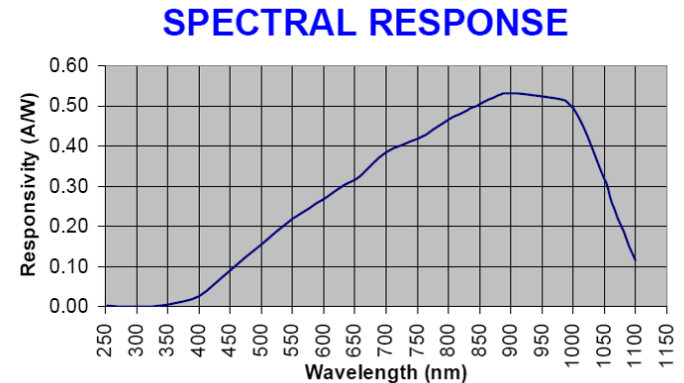

The detector diode vendors are giving us the info we need

For best performance we want the detector spectral responsivity to be “matched” to the LED spectral density. In general this is hard to due, especially for white LEDs.

$$P_{RX} \propto \left[ \int_{\lambda=250nm}^{\lambda=1150nm} S(\lambda) \cdot R(\lambda) \cdot L(\lambda) \, d\lambda \right]^2 R_2$$

Where  $T(\lambda)$  is the transmitter power spectral density (W/nm)

$R(\lambda)$  is the detector responsivity (A/W at  $\lambda$ )

$L(\lambda)$  is the propagation loss (loss at  $\lambda$ )

# Appendix C

## Receiver Noise Density Calculations

## Determining the noise density $N_o$

What are the sources that contribute to the noise density?

- Photodetector Noise
  - Transimpedance Amplifier Noise
    - Ambient “in-band” noise
- Interference from other VLC sources
  - Others?

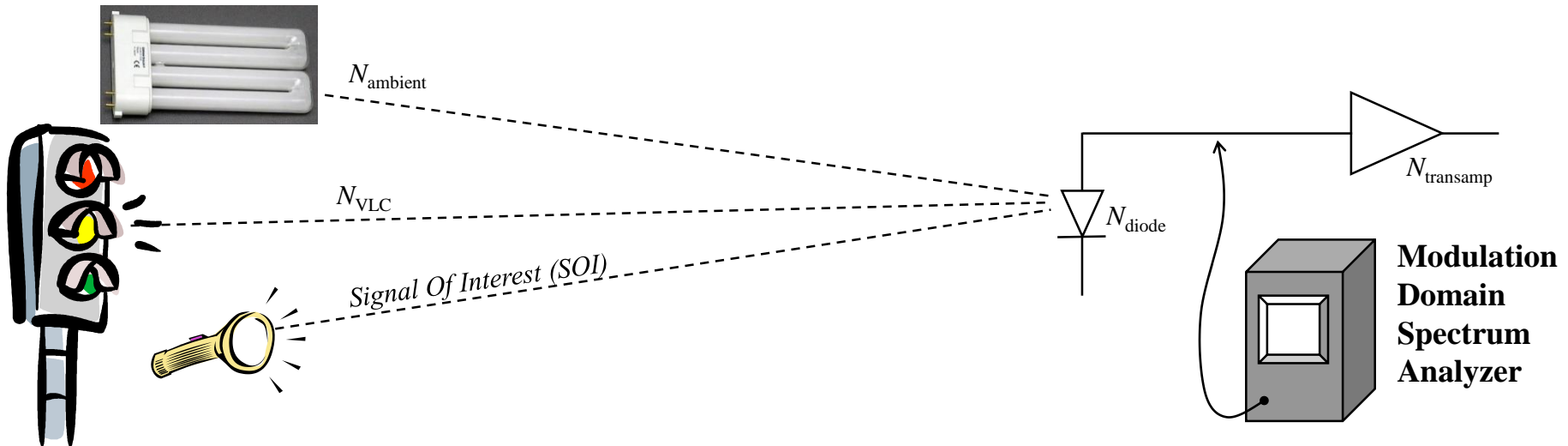

### Modulation Domain Spectrum

## Ambient “In-Band” Noise Floor

*This probably has to be empirically  
measured for many different environments*

## Interference from other VLC sources

*For OCC this source of noise is unlikely because of the angle-of-arrival mapping of the lens because the interferer would have to be on the same angular vector as the desired noise source. In general, an interfering source will form an image elsewhere on the image sensor and can be spatially filtered out.*



The detector itself contributes a noise density  $N_{\text{diode}}$  ( $\text{W}/\sqrt{\text{Hz}}$ )

$$i_{\text{npd}} = \sqrt{i_{\text{shot}}^2 + i_{\text{thermal}}^2} = \sqrt{2q(I_D + I_S + I_B) + 4kT/R_{SH}} \quad (\text{A}/\sqrt{\text{Hz}})$$

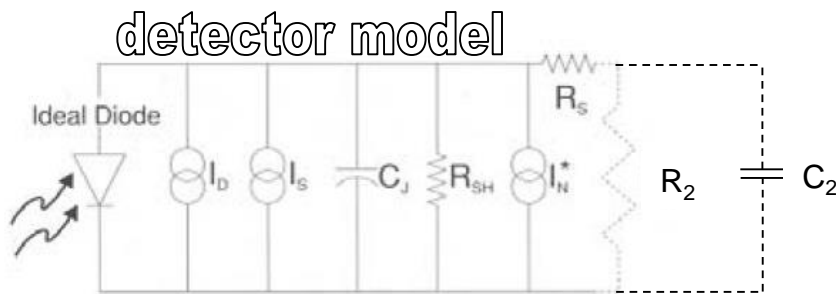

$I_D$  = Dark current, Amps

$I_S$  = Light signal current, Amps, ( $I_S = RP_O$ )

$R$  = Photodiode responsivity at a wavelength of irradiance, Amps/Watt

$P_O$  = Light power incident on photodiode active area, Watts

$R_{SH}$  = Shunt resistance, Ohms

$I_N^*$  = Noise Current, Amps rms

$C_J$  = Junction Capacitance, Farads

$R_S$  = Series resistance, Ohms

$R_2$  = Load resistance, Ohms

$q$  is the electron charge ( $1.6 \times 10^{-19}$  coulombs)

$I_D$  is the dark current

$I_S$  is the signal current

$I_B$  is the background light induced current

$B$  is the bandwidth ( $B=1$  Hz for  $N_0$ )

$k$  is Boltzmann's constant ( $1.38 \times 10^{-23}$  J/K)

$T$  is the Kelvin temperature ( $\sim 290^\circ$  K)

$R_{SH}$  is the shunt resistance

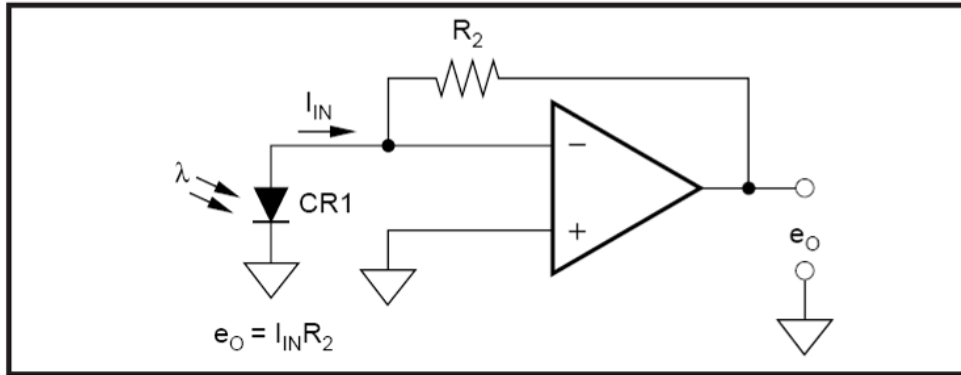

FIGURE 3. Pin Photo Diode Application.

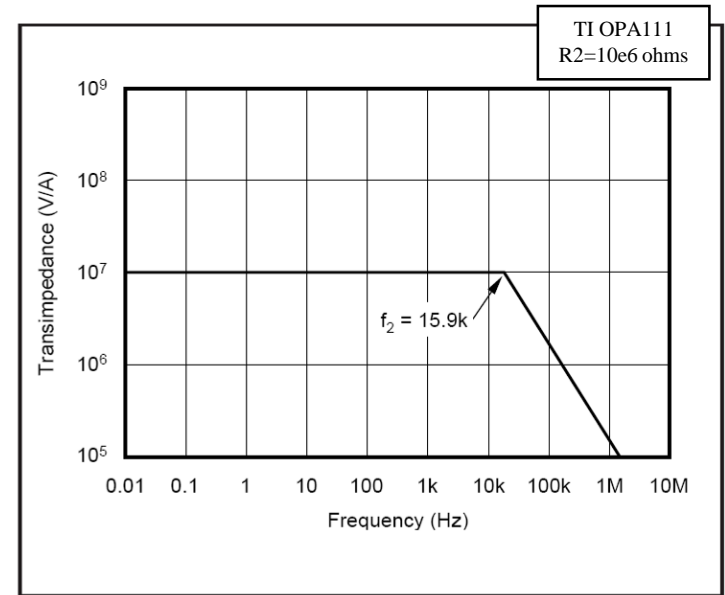

FIGURE 6. Transimpedance.

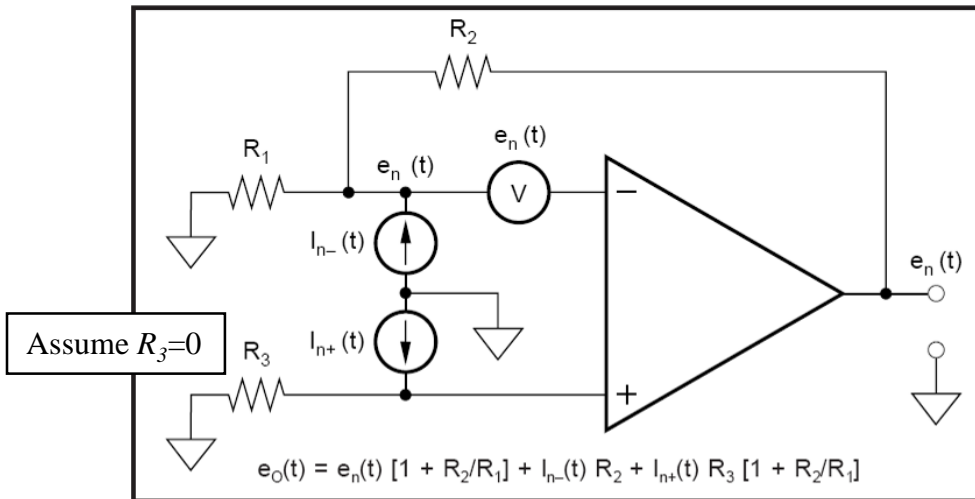

FIGURE 2. Circuit With Error Sources.

# Transimpedance Amplifier Noise Analysis

Ref. TI/Burr-Brown Application Bulletin SBOA060  
 "Noise Analysis of FET Transimpedance Amplifiers"

<http://focus.ti.com/lit/an/sboa060/sboa060.pdf>

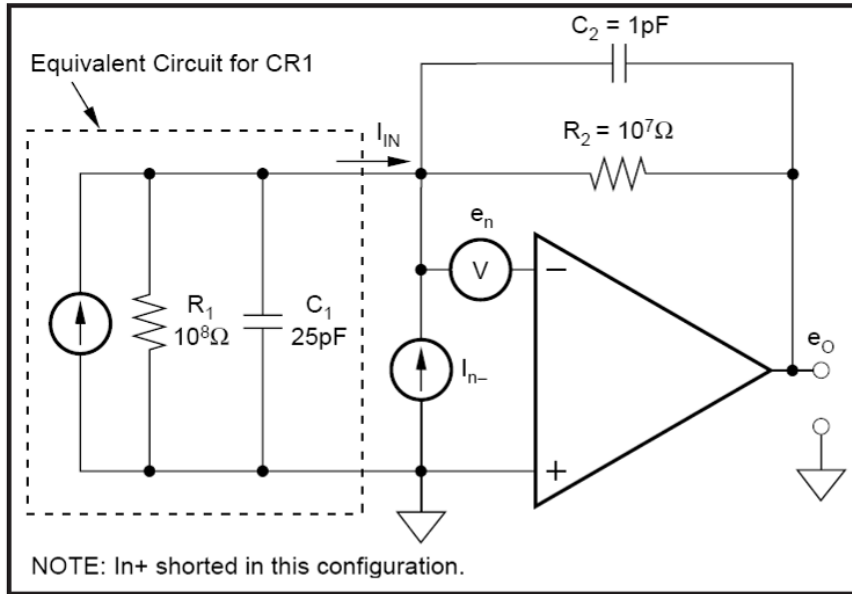

FIGURE 4. Noise Model of Photodiode Application.

The resistors and capacitors form critical corner frequencies as shown below:

$$f_2 = \frac{1}{2\pi R_2 C_2}$$

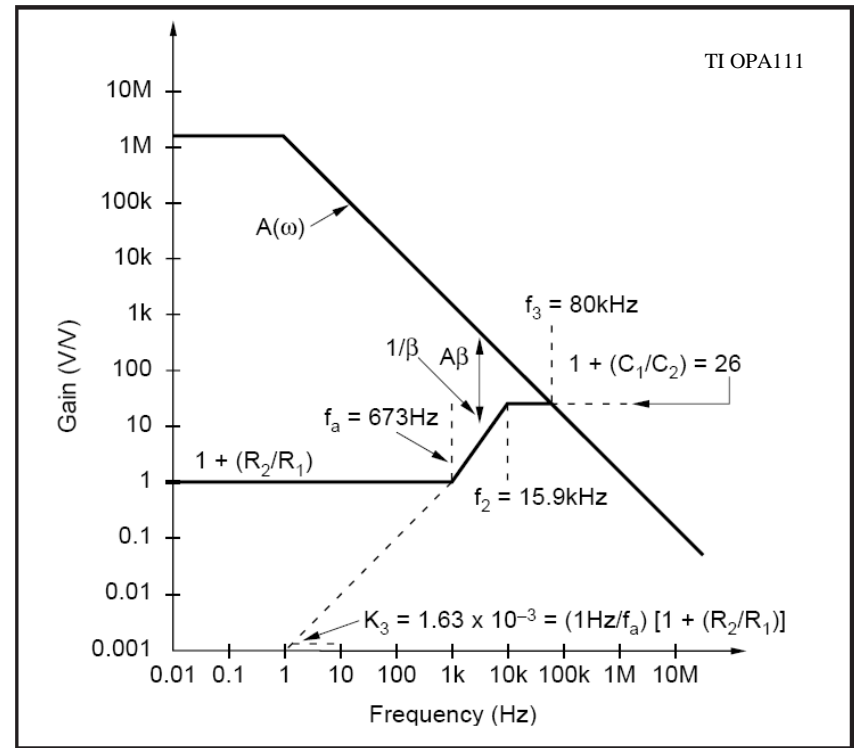

FIGURE 7. Noise Voltage Gain.

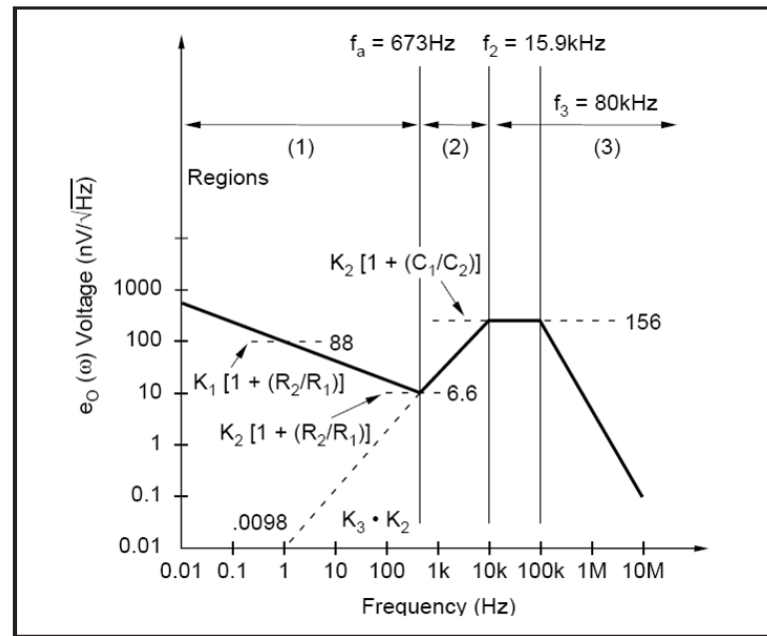

FIGURE 8. Output Voltage Noise Spectral Density.

Typically op-amps have three noise regions ... the above noise regions are for the TI OPA111 op-amp. It is anticipated most outdoor VLC implementations will be bandpass systems operating in noise region 3.

<b>NOISE</b>							
Input Voltage Noise, $f = 0.1\text{Hz to }10\text{Hz}$			90			*	nVp-p
Input Voltage Noise Density, $f = 10\text{Hz}$	$e_n$	<b>Noise Regions for the TI OPA228</b>	15			*	nVrms
$f = 100\text{Hz}$			3.5			*	nV/sqrt(Hz)
$f = 1\text{kHz}$			3			*	nV/sqrt(Hz)
Current Noise Density, $f = 1\text{kHz}$	$i_n$		0.4			*	pA/sqrt(Hz)

The approximation output noise is given by

$$N_0 = N_0^{n3} + N_0^R + N_0^{i_n}$$

where

$$N_0^{n3} = K_3^2 \cdot \left( 1 + \frac{C_1}{C_2} \right)^2$$

$$N_0^R = 4kTR_2$$

$$N_0^{i_n} = (i_{nop}^2 + i_{npd}^2)R_2^2 = (i_{nop}^2 + 2q(I_D + I_S + I_B) + 4kT/R_{SH})R_2^2$$

The signal current is given as

$$I_{sig} = \int_{\lambda=\lambda_{rL}}^{\lambda=\lambda_{rH}} S_r(\lambda) \cdot R_f(\lambda) \cdot R_D(\lambda) \, d\lambda$$

Then electrical SNR is

$$\frac{E_b}{N_0} = \frac{\left( R_2 \int_{\lambda=\lambda_{rL}}^{\lambda=\lambda_{rH}} S(\lambda) \cdot R(\lambda) \cdot L(\lambda) \, d\lambda \right)^2 / Rate}{K_3^2 \left( 1 + \frac{C_1}{C_2} \right)^2 + 4kTR_2 + \left( i_{nop}^2 + 2q(I_D + I_S + I_B) + 4kT/R_{SH} \right) R_2^2}$$

# Eb/No Dimensional Analysis

$$W = \frac{J}{s} = V \cdot A \quad \Omega = \frac{V}{A} = \frac{J}{A^2 s}$$

$$V = \frac{W}{A} = \frac{J}{A \cdot s} \quad Hz = \frac{1}{s} \quad A = \frac{C}{s}$$

$$\left( \frac{V}{A} \cdot W \cdot \frac{A}{W} \right)^2 \cdot \frac{1}{1/s} = \frac{V^2}{Hz}$$

$q \rightarrow C(\text{coulombs})$

$k \rightarrow J/K$

$T \rightarrow K$

$$\left( R_2 \int_{\lambda=380nm}^{\lambda=780nm} S(\lambda) \cdot R(\lambda) \cdot L(\lambda) \, d\lambda \right)^2 / Rate$$

$$\frac{E_b}{N_0} = \frac{\left( R_2 \int_{\lambda=380nm}^{\lambda=780nm} S(\lambda) \cdot R(\lambda) \cdot L(\lambda) \, d\lambda \right)^2 / Rate}{K_3^2 \left( 1 + \frac{C_1}{C_2} \right)^2 + 4kTR_2 + \left( i_{nop}^2 + 2q(I_D + I_S + I_B) + 4kT/R_{SH} \right) R_2^2}$$

$$\left( \frac{V}{\sqrt{Hz}} \right)^2 = \frac{V^2}{Hz}$$

$$\frac{A^2}{Hz} \cdot \left( \frac{V}{A} \right)^2 = \frac{V^2}{Hz}$$

$$\frac{J}{K} \cdot K \cdot \frac{\left[ \frac{V}{A} \right]^2}{\frac{V}{A}} = \frac{V^2}{Hz}$$

$$\frac{J}{K} \cdot K \cdot \frac{V}{A} = \frac{J}{A} \cdot V \cdot \frac{s}{s} = \frac{J}{A \cdot s} \cdot V \cdot s = \frac{V^2}{Hz}$$

$$C \cdot A \cdot \frac{V^2}{A^2} = \frac{C}{A} V^2 = \frac{C}{C/s} V^2 = V^2 s = \frac{V^2}{Hz}$$

# Appendix D

## Solid angle path loss model



# LOS Link Model

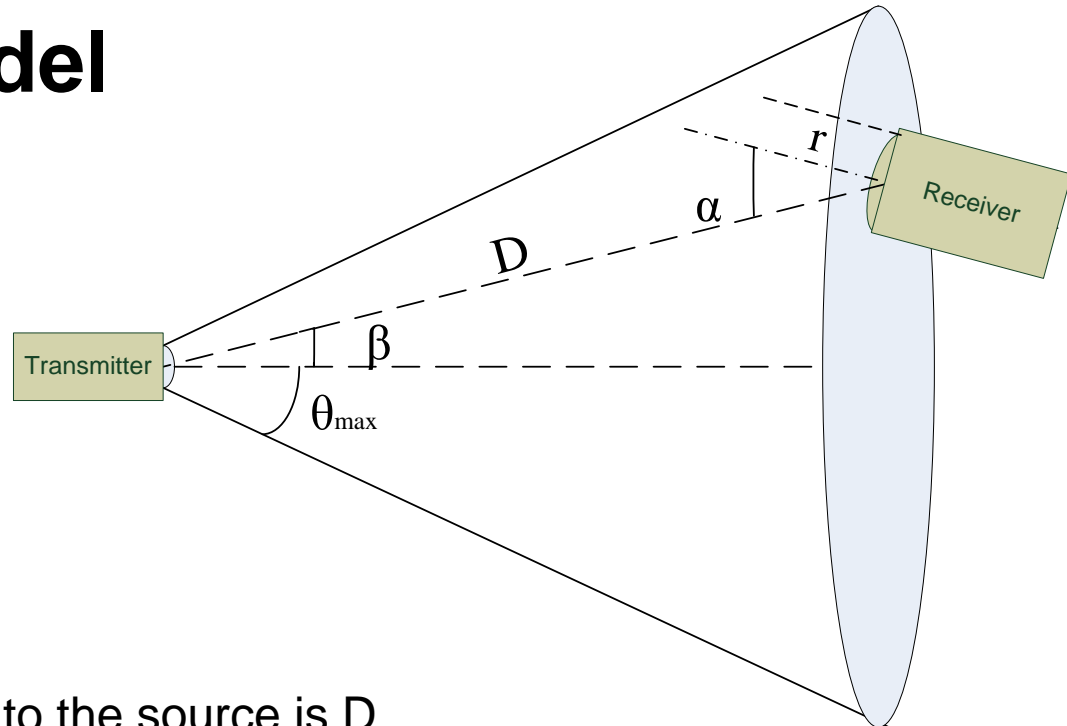

- The receiver distance to the source is  $D$
- The receiver aperture radius is  $r$  and receiver area is  $A_r$
- The angle between receiver normal and source-receiver line is  $\alpha$
- The angle between source beam axis and source-receiver line (viewing angle) is  $\beta$
- The solid angle of the receiver seen by the source is  $\Omega_r$

The luminous angular intensity of the source at the receiver direction is  $I_0 g_t(\beta)$ , and therefore the receiver ingested luminous flux  $F_r = I_0 g_t(\beta) \Omega_r$ .

The luminous path loss can be represented as

$$L_L = \frac{F_r}{F_t} = \frac{I_0 g_t(\beta) \Omega_r}{I_0 \int_0^{\theta_{\max}} 2\pi g_t(\theta) \sin \theta d\theta} = \frac{g_t(\beta) \Omega_r}{\int_0^{\theta_{\max}} 2\pi g_t(\theta) \sin \theta d\theta} \approx \frac{g_t(\beta) A_r \cos \alpha}{D^2 \int_0^{\theta_{\max}} 2\pi g_t(\theta) \sin \theta d\theta}$$

where  $\Omega_r$  is the receiver solid angle which satisfies  $A_r \cos(\alpha) \approx D^2 \Omega_r$ .

Power path loss  $L_p$  can be proven equal to luminous path loss  $L_L$  as follows:

- Optical power can be written as  $P = \int_{\lambda_L}^{\lambda_H} S(\lambda) d\lambda$
- In LOS free space propagation, path loss is assumed independent of wavelength. Power path loss can be represented as  $L_p = S_2(\lambda) / S_1(\lambda) = P_2 / P_1$ .
- Luminous flux is related to  $S(\lambda)$  as  $F = 683 \text{ lm/W} \times \int_{\lambda_L}^{\lambda_H} S(\lambda) V(\lambda) d\lambda$ , which is linear with  $S(\lambda)$

Therefore,  $L_L = F_2 / F_1 = L_p$ .

## Find received optical and electrical power

Now that we have known the optical power loss due to LOS propagation, we can obtain the received optical spectral density from transmitter optical spectral density as

$$S_r(\lambda) = L_p S_t(\lambda) = L_L S_t(\lambda)$$

Received optical power 
$$P_{r,o} = \int_{\lambda=\lambda_{rL}}^{\lambda=\lambda_{rH}} S_r(\lambda) \cdot R_f(\lambda) d\lambda$$

Suppose we use a photodiode detector to receive the signal light. We can obtain the electrical power of the signal as

$$P_{r,e} = \left[ \int_{\lambda=250nm}^{\lambda=1150nm} S_r(\lambda) \cdot R_f(\lambda) \cdot R_D(\lambda) d\lambda \right]^2 R_L$$

where  $S_r(\lambda)$  is the received light power spectral density (W/nm)

$R_f(\lambda)$  is the receiver filter spectral response

$R_D(\lambda)$  is the detector responsivity (A/W at  $\lambda$ ) 
$$R_D(\lambda) = \frac{\eta q \lambda}{hc}$$

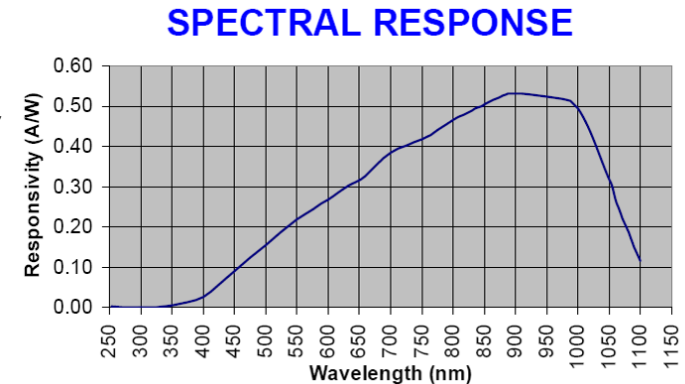

The detector diode vendors are giving us the info we need

### Exemplary Optical Filter Response

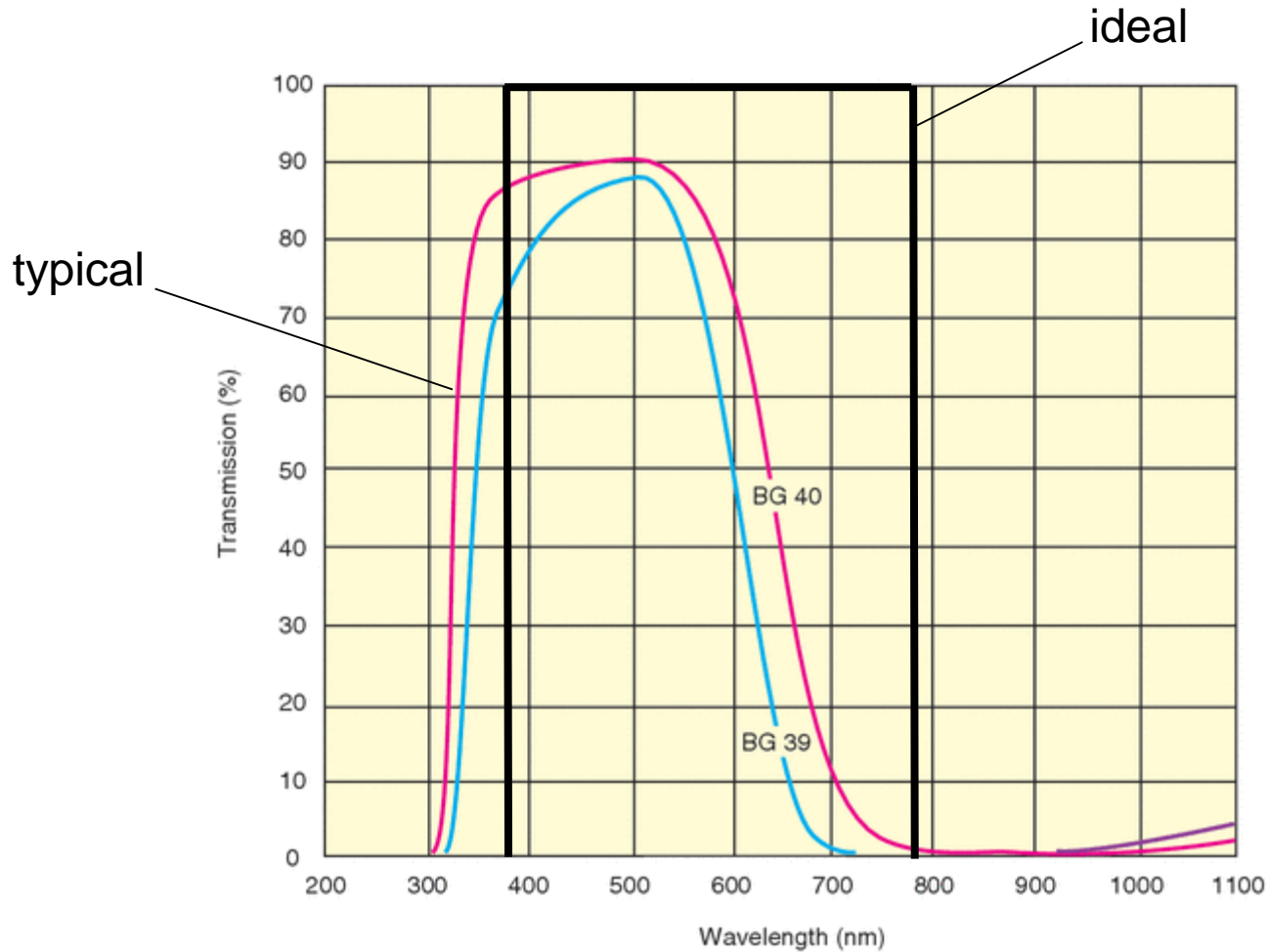

<http://www.newport.com/images/webclickthru-EN/images/2226.gif>

## Summary of key steps to obtain received optical power and electrical power

- Calculate transmitter (source) optical power from given luminous flux  $F_t$  (lumens) and normalized spectral curve  $S_t'(\lambda)$
- Find the transmitter axial intensity  $I_o$  from given luminous flux  $F_t$  and luminous spatial intensity distribution  $g_t(\theta)$
- Find receiver ingested luminous flux  $F_r$  from receiver solid angle and transmitter luminous spatial intensity distribution  $I_o g_t(\theta)$
- Find the luminous path loss  $L_L$  from  $F_t$  and  $F_r$
- Prove power path loss  $L_p$  is equal to luminous path loss  $L_L$  from which to find received optical power spectral curve  $S_r(\lambda)$
- Calculate received optical power and electrical power

## Comment on RX aperture vs. magnification factor

It is the author's opinion that the RX aperture determines the "brightness" of an observed object and that the field of view determines the magnification factor of an observed object. That is, for a given aperture the magnification factor determines how big an object appears but not how bright an object appears. The observed brightness is solely a function of the aperture size. It should be noted that the field of view, and hence the magnification factor, is a function of the focal distance.

