

**Project: IEEE P802.15 Working Group for Wireless Personal Area Networks (WPANs)**

**Submission Title:** 15.7 Revision: Short-Range Optical Wireless Communications Tutorial

**Date Submitted:** 28 Jan 2015

**Source:** Various — Rick Roberts (15.7r1 editor)      **Company:** Various

**Address:**

**Voice:**      **FAX:**      **E-Mail:**

**Re:**

**Abstract:** Collection of industry tutorial inputs

**Purpose:** Tutorial presentation for the IEEE802 plenary

**Notice:** This document has been prepared to assist the IEEE P802.15. It is offered as a basis for discussion and is not binding on the contributing individual(s) or organization(s). The material in this document is subject to change in form and content after further study. The contributor(s) reserve(s) the right to add, amend or withdraw material contained herein.

**Release:** The contributor acknowledges and accepts that this contribution becomes the property of IEEE and may be made publicly available by P802.15.

Task Group IEEE802.15.7r1  
Short-Range Optical Wireless Communications  
Kickoff Tutorial

# Table of Content

Part 1: Introduction

Part 2: Optical Camera Communications PHY

Part 3: Higher Rate PHY

Part 4: LED ID PHY

# Part 1: Introduction

# Base standard ... IEEE802.15.7-2011 Short-Range Wireless Optical Communication Using Visible Light

Originally wanted to write an amendment to add IR/UV PHY options but the word “visible” in the base standard title required a revision to change the title.

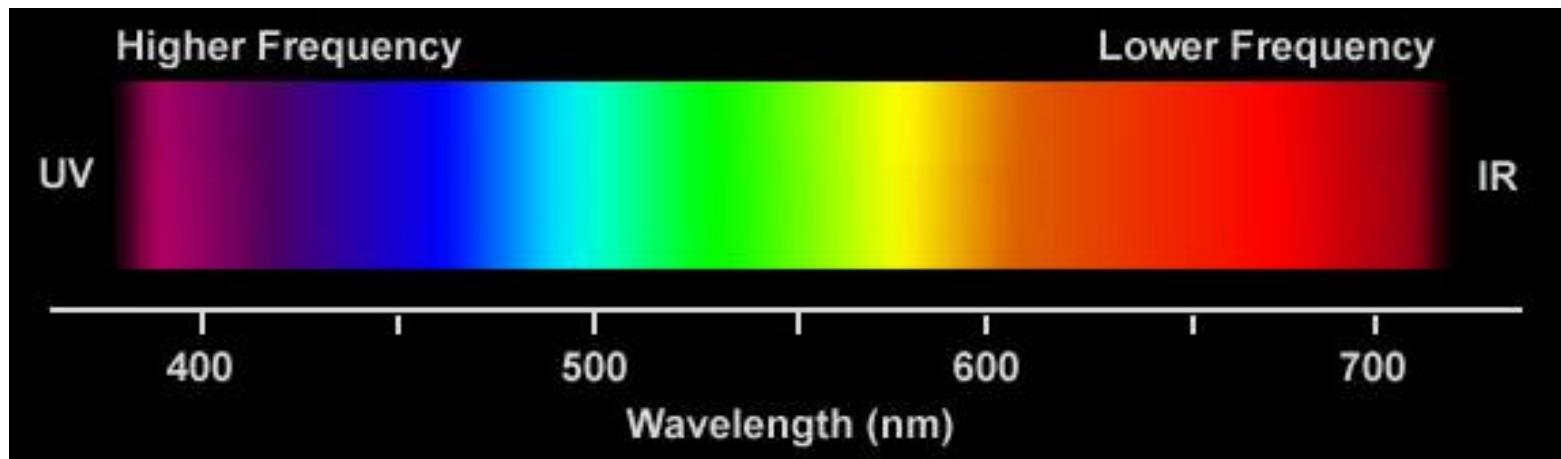

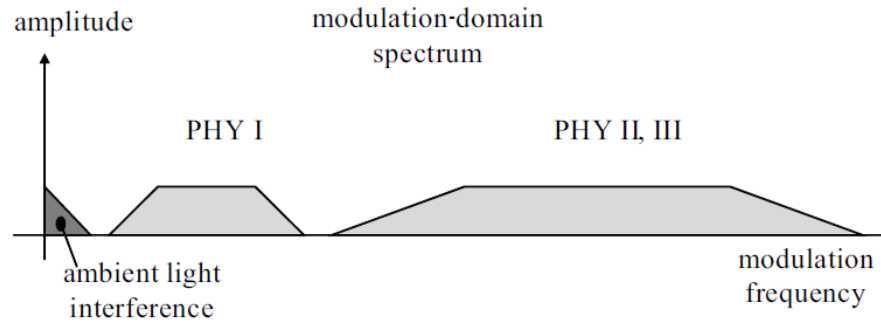

Figure 4—FDM separation of the PHY types in the modulation domain

Table 73—PHY I operating modes

Modulation	RLL code	Optical clock rate	FEC		Data rate
			Outer code (RS)	Inner code (CC)	
OOK	Manchester	200 kHz	(15,7)	1/4	11.67 kb/s
			(15,11)	1/3	24.44 kb/s
			(15,11)	2/3	48.89 kb/s
			(15,11)	none	73.3 kb/s
			none	none	100 kb/s
VPPM	4B6B	400 kHz	(15,2)	none	35.56 kb/s
			(15,4)	none	71.11 kb/s
			(15,7)	none	124.4 kb/s
			none	none	266.6 kb/s

Table 74—PHY II operating modes

Modulation	RLL code	Optical clock rate	FEC	Data rate
VPPM	4B6B	3.75 MHz	RS(64,32)	1.25 Mb/s
			RS(160,128)	2 Mb/s
		7.5 MHz	RS(64,32)	2.5 Mb/s
			RS(160,128)	4 Mb/s
			none	5 Mb/s
OOK	8B10B	15 MHz	RS(64,32)	6 Mb/s
			RS(160,128)	9.6 Mb/s
		30 MHz	RS(64,32)	12 Mb/s
			RS(160,128)	19.2 Mb/s
		60 MHz	RS(64,32)	24 Mb/s
			RS(160,128)	38.4 Mb/s
		120 MHz	RS(64,32)	48 Mb/s
			RS(160,128)	76.8 Mb/s
none	96 Mb/s			

Table 75—PHY III operating modes

Modulation	Optical clock rate	FEC	Data rate
4-CSK	12 MHz	RS(64,32)	12 Mb/s
8-CSK		RS(64,32)	18 Mb/s
4-CSK	24 MHz	RS(64,32)	24 Mb/s
8-CSK		RS(64,32)	36 Mb/s
16-CSK		RS(64,32)	48 Mb/s
8-CSK		none	72 Mb/s
16-CSK		none	96 Mb/s

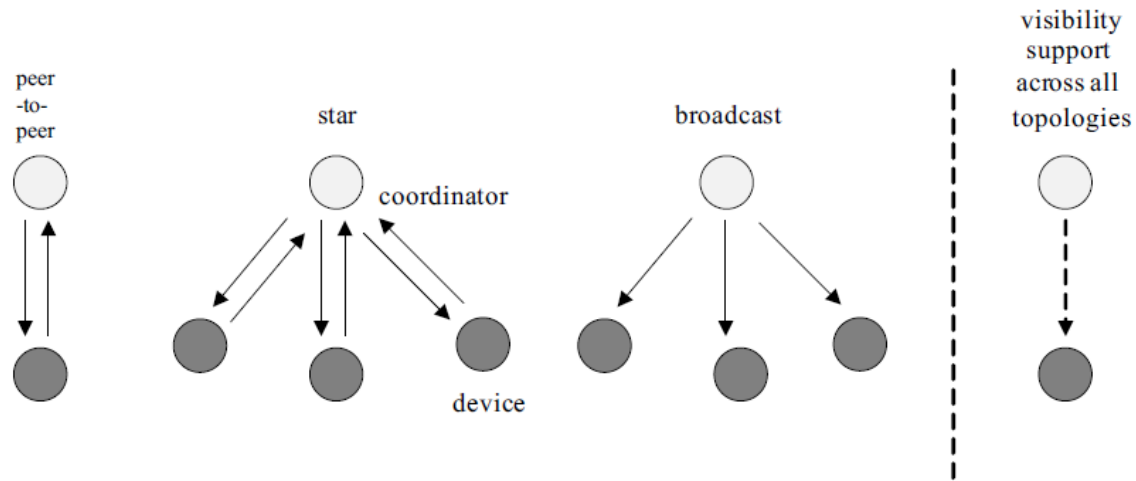

Figure 1—Supported MAC topologies

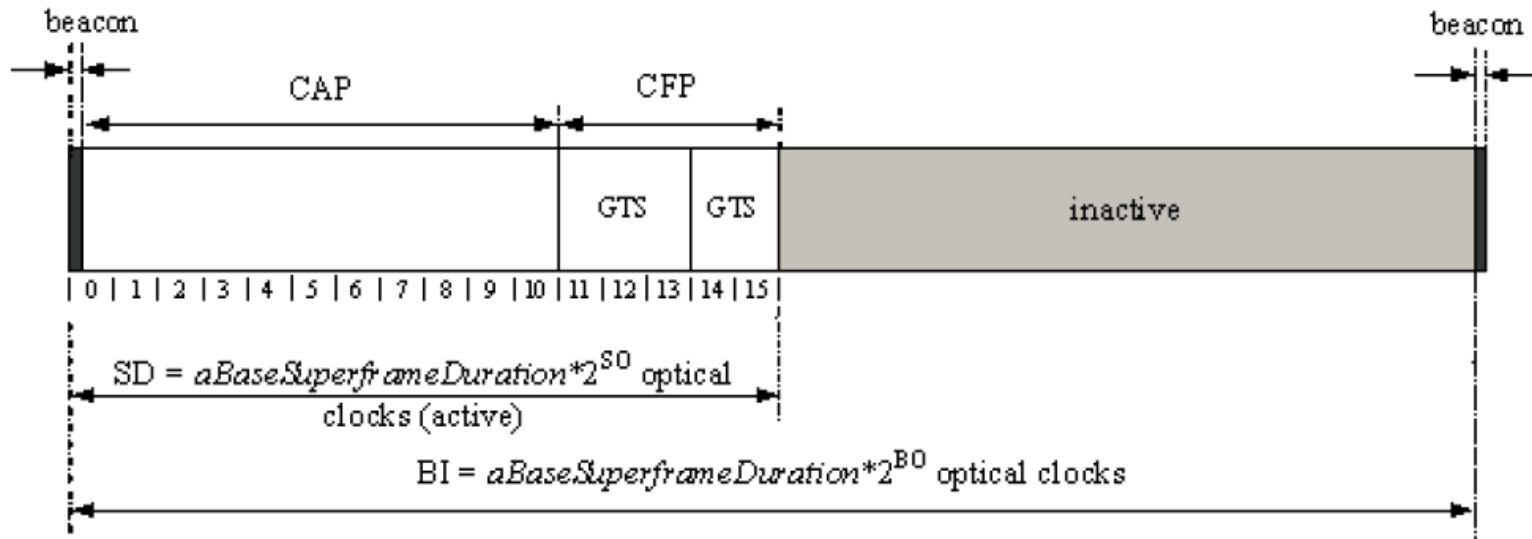

Figure 13—An example of the superframe structure



# Part 2: Optical Camera Communications PHY

# Intel Corporation Contribution

Rick Roberts

[richard.d.roberts@intel.com](mailto:richard.d.roberts@intel.com)

# Optical Camera Communications (OCC)

## A Pragmatic Form of Visible Light Communications

OCC is modulating an LED light with data bits that can be received by a camera, which then decodes the bits and extracts the data.

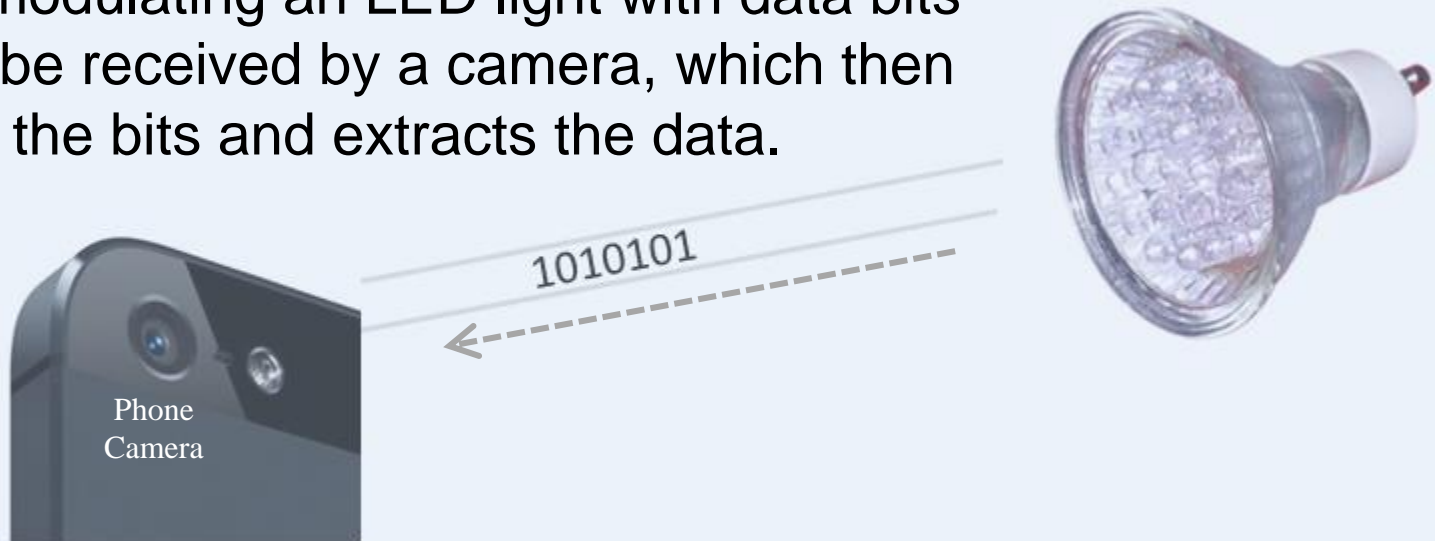

Today we have millions of mobile devices enabled to receive visible light communications via the camera, but we lack standards to describe the modulation format.

*This contribution discusses some OCC topics of interest.*

Basic idea:

- each LED sign uses OCC to broadcast URL info
- multiple parallel transmissions received by camera
- each web page accessed via RAN
- Google Glass displays webpage next to related LED sign
- added information augments users reality

## Augmented Reality

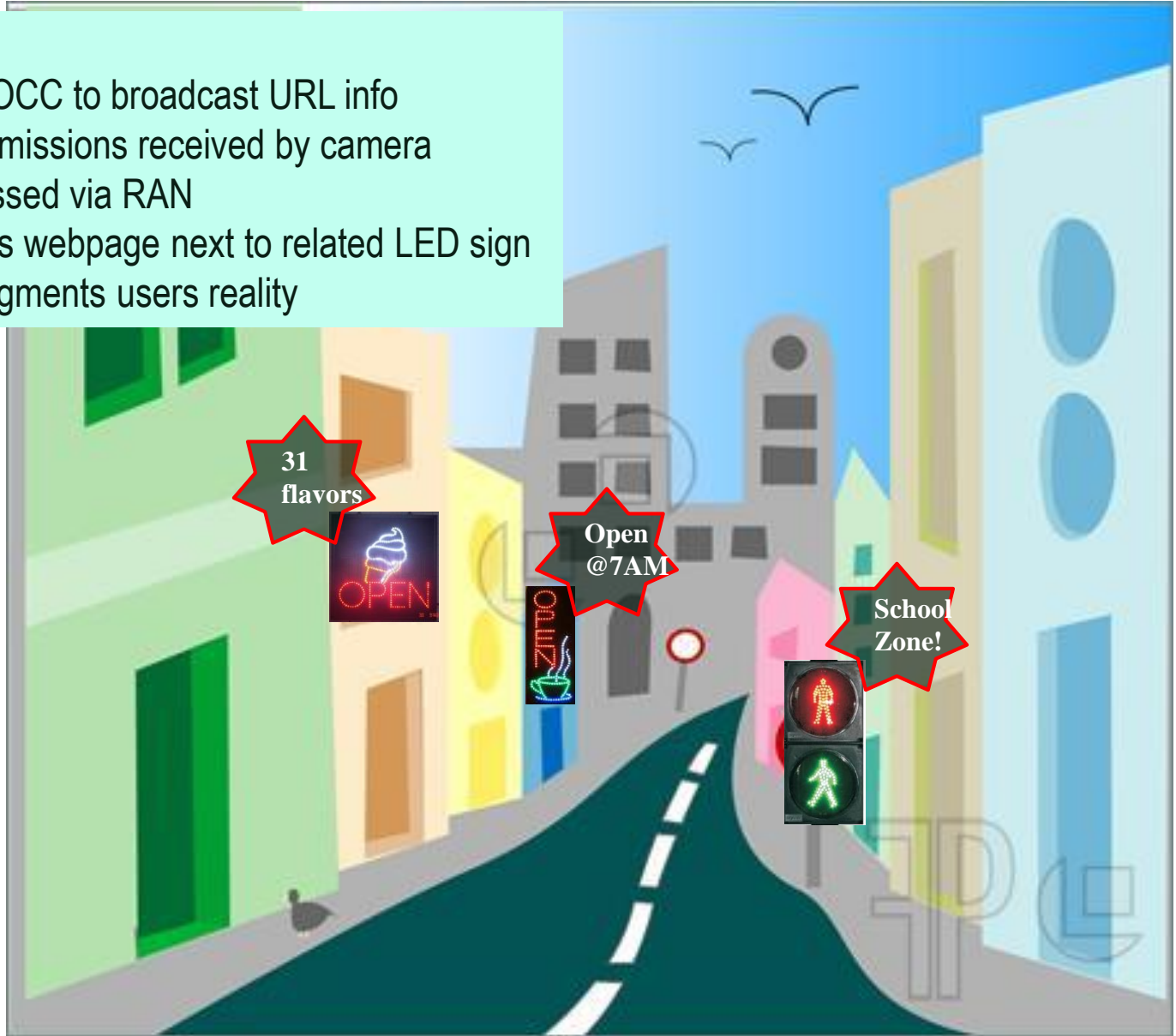

Comphotogrammetry: the merger of OCC and Photogrammetry such that light sources become self-identifying anchor features

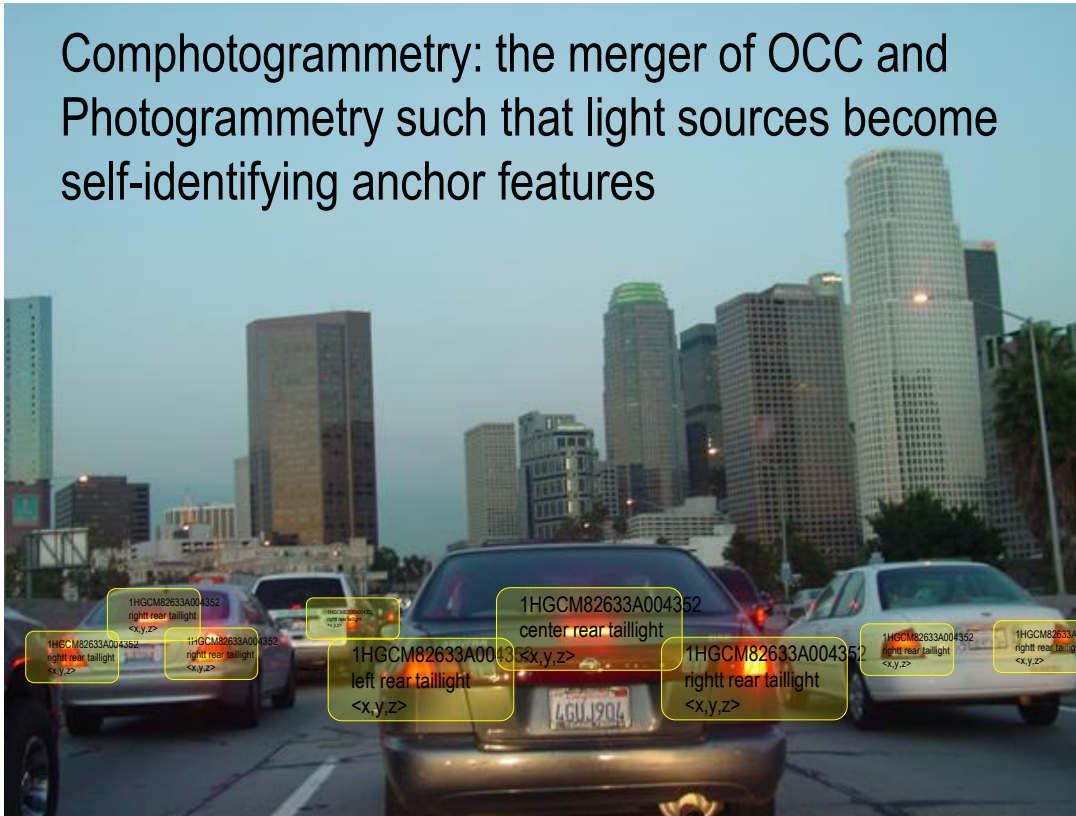

# High Resolution Automobile Positioning

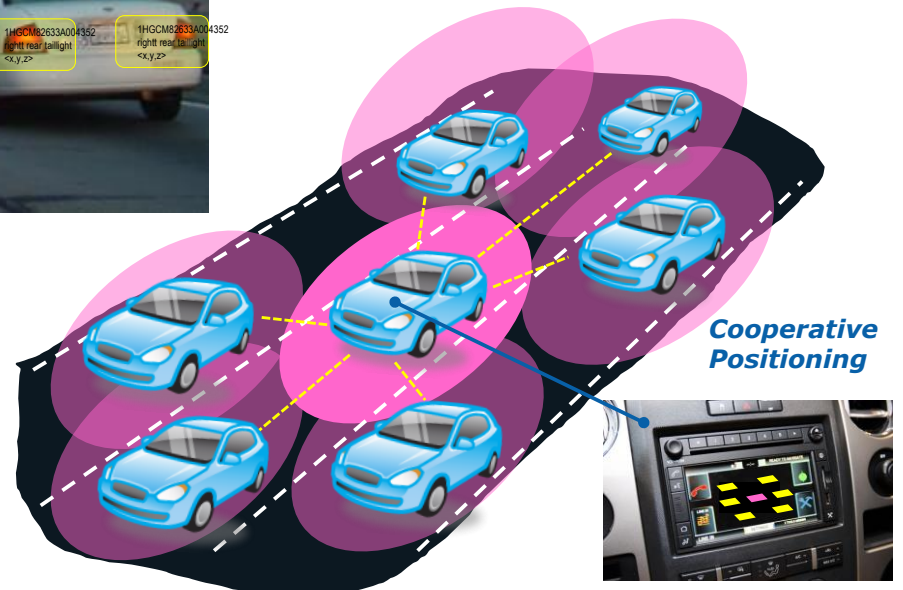

# Optical Camera Communications & Photogrammetry Positioning Applications

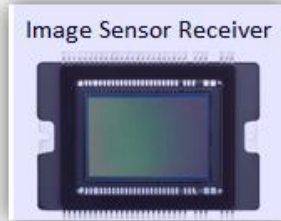
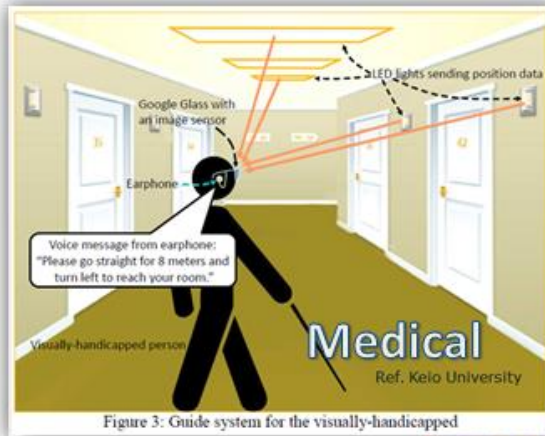
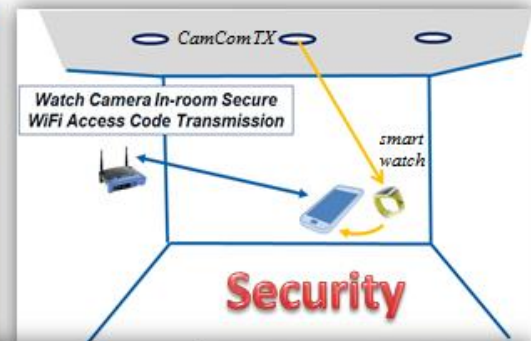
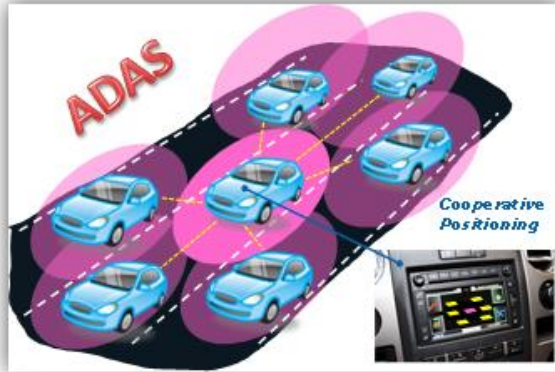

## But first some basics about electronic cameras

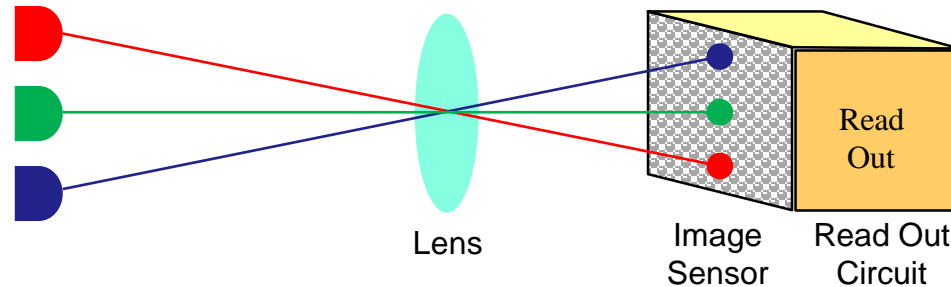

### Camera basic components

- Lens ... spatially separates sources
- Image Sensor ... array of photodiode pixels
- Readout Circuit ... convert pixel signal to digital data

### Cameras differ on how the pixels are exposed

- Global Shutter ... simultaneously expose all the pixels per frame
- Rolling Shutter ... time sequentially expose each row of pixels per frame

**Because of camera lens properties, spatial separation of multiple sources is possible enabling MIMO transmission.**



*Example LED Signage*

This LED sign has 321 LEDs ...

- each LED illuminates a unique pixel in the image sensor
- each LED can transmit a unique data stream
- 321 x 321 MIMO !!!



# *CamCom data recovering algorithm on mobile platform*

University of California Riverside Contribution

Dongfang Zheng, Gang Chen, Jay A. Farrell

[gachen@ee.ucr.edu](mailto:gachen@ee.ucr.edu)

# VLC Aided Navigation System

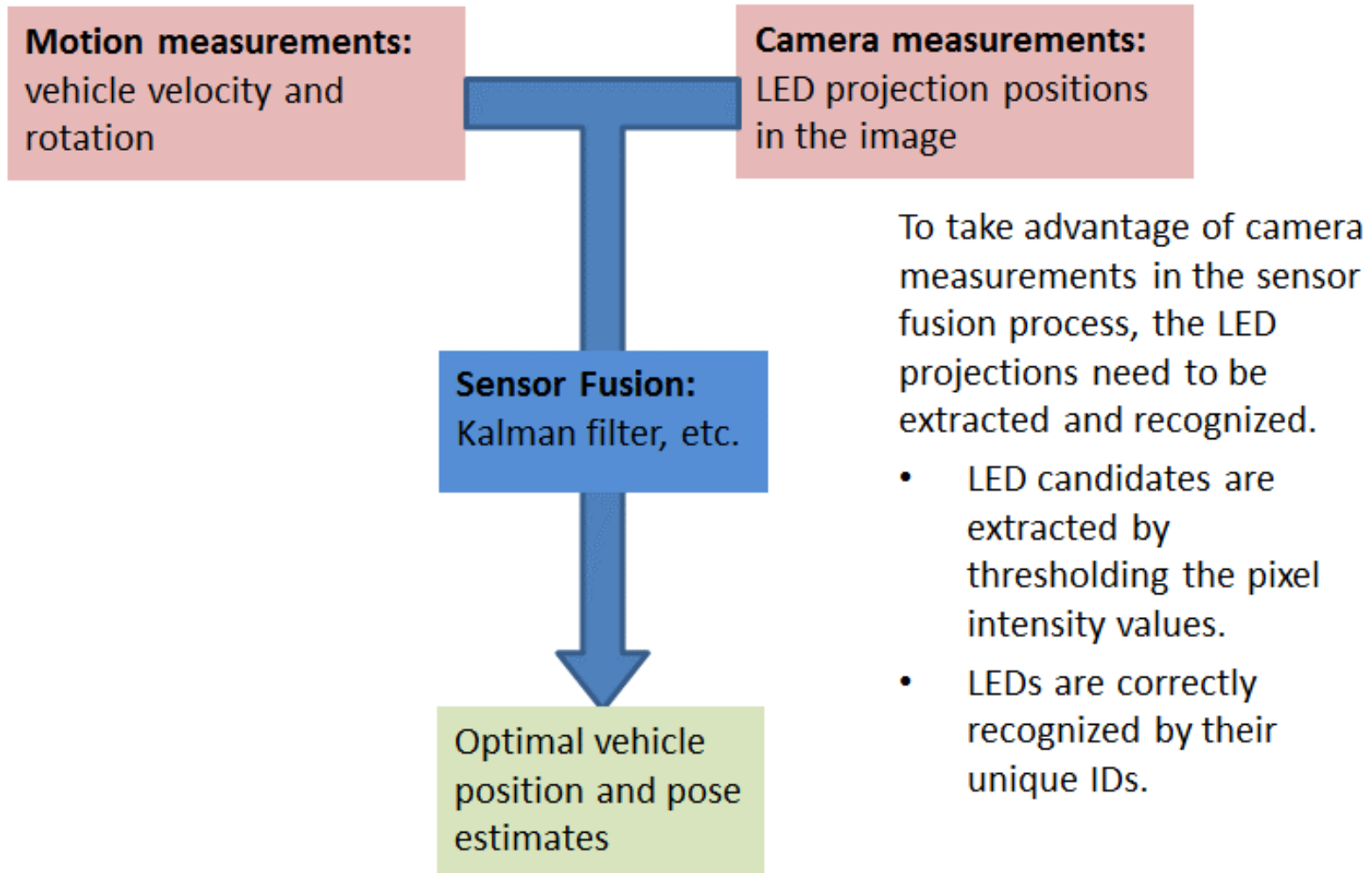

# LED Data Recovery Problem when moving

Why need to recover LED data?

- Communication
- Recognize LED source

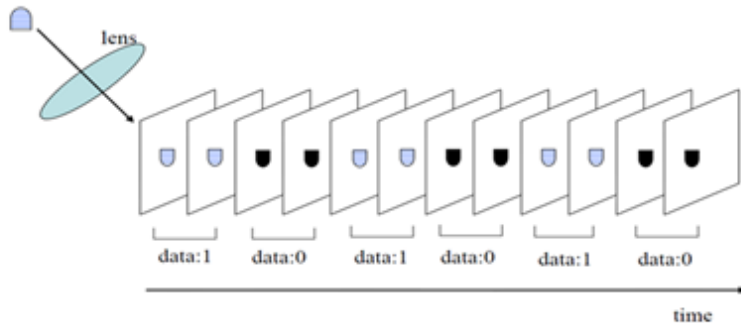

LED projections in a sequence of images

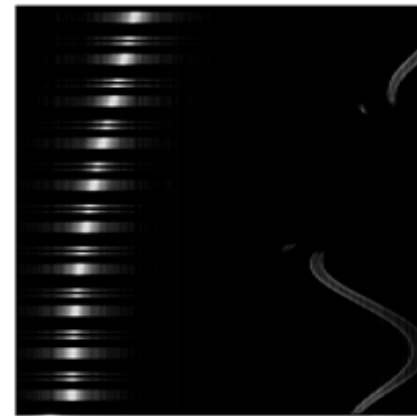

LED projections in a sequence of linear array scans

Recovering the LED data is not straight forward since:

- Multiple LED projections within FOV
- Noise and clutter
- Moving sensor causes moving LED projection onto array.
  - Is this bit a zero or am I looking at the wrong pixel?

3

# One Algorithm: MHT Based Data Recovery

## Multiple hypothesis tracking based algorithm

- Recover the data association hypothesis Instead of searching the LED projection position

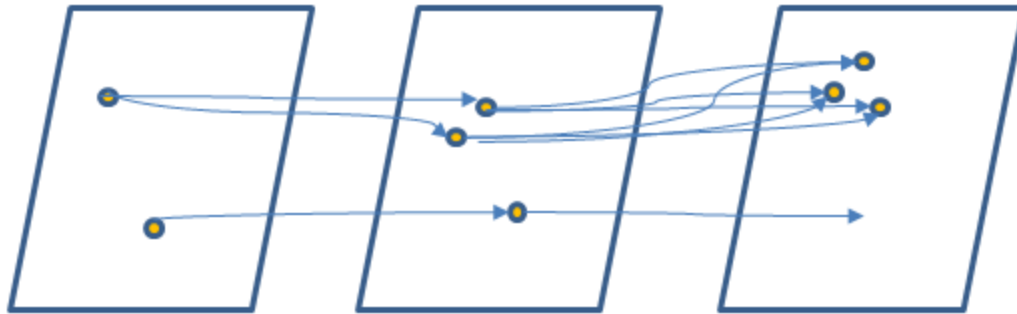

The figure illustrates two LEDs' projections in three consecutive images. The blue lines are the LED projection path hypotheses.

- Each LED projection path corresponds an LED data
- The MHT based algorithm tries to evaluate the probability of each path hypothesis.

# MHT Based Data Recovery

- Multiple hypothesis tracking based algorithm
  - Different idea with Viterbi based algorithm
    - Recover the data association hypothesis Instead of searching the LED projection position

- Applicable when the rover is moving
- Applicable both for camera and linear array
- More computational cost

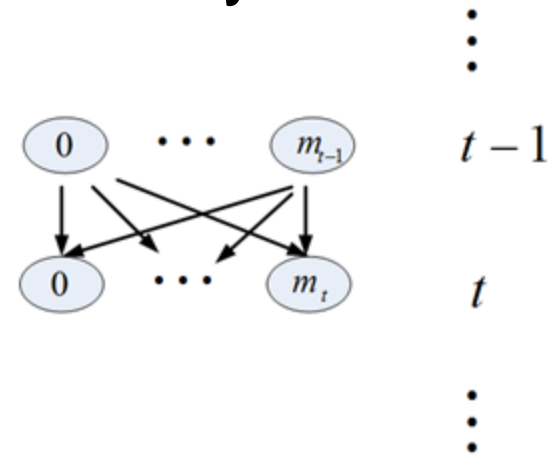

- Evaluate the probability of each pair of data association

$$\{0, 0\}, \{0, 1\} \dots \{i, j\} \dots \{m_{t-1}, m_t\}$$

- If the length of frames is K, the total number of data association hypotheses for one LED is

$$L_K = \prod_{k=1}^K (m_k + 1)$$

# Another Algorithm: Viterbi-based Data Recovery

- Apply Viterbi algorithm to the data recovery problem of linear array.

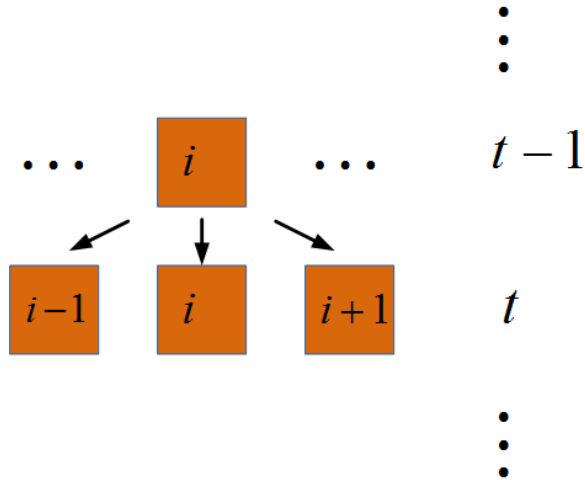

Assumption:

- The movement of LED projection in two consecutive scans if bounded

- The Viterbi based algorithm tries to compute the probability of each pixel that the LED projects on.
- The probability is computed by incorporating the motion and LED measurement information.

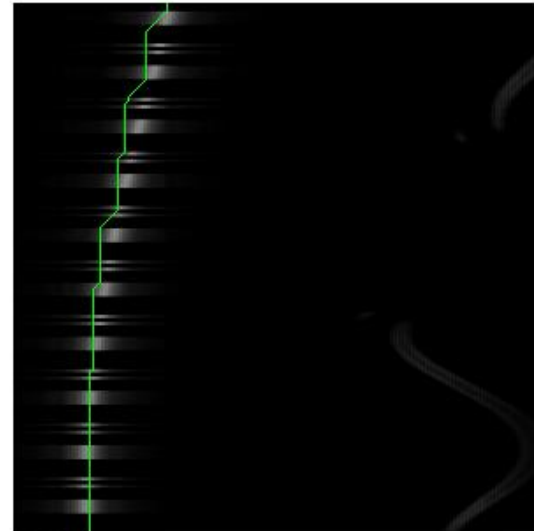

# Viterbi-based Data Recovery Algorithm

- State definition
  - Pixel index  $i$  that the LED projected on
- Observation set definition
  - The pixels that have intensity values higher than the threshold
$$Z(t) \square \{z_j(t)\}_{j=1}^{m_t}$$
- Assumption:
  - Each LED is projected onto only one pixel in the linear array
  - This is invalid but convenient for analysis

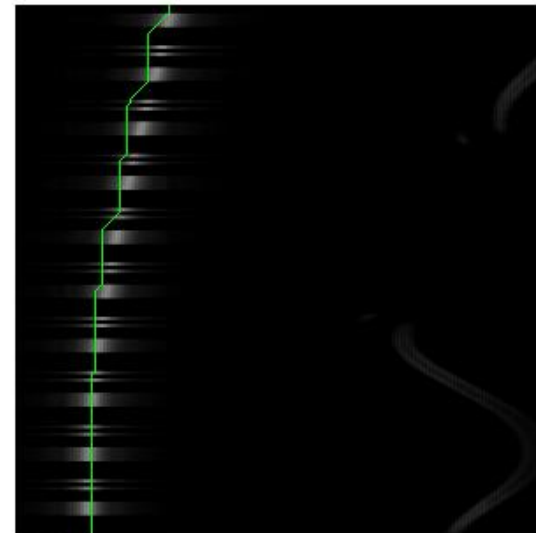
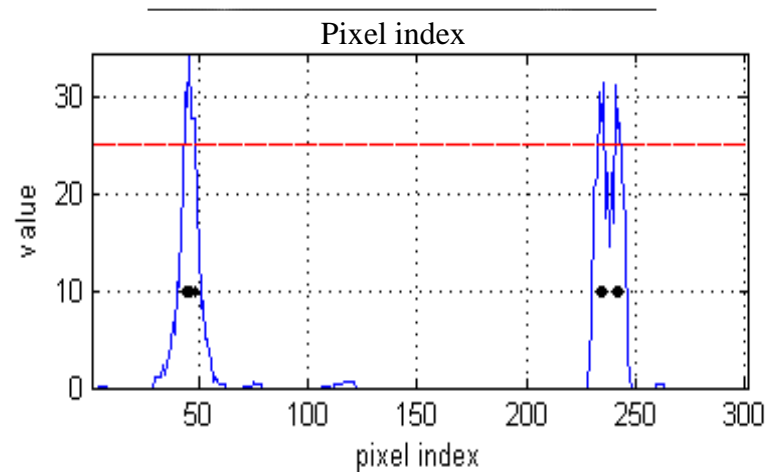

# Kookmin University Contribution

Yeong Min Jang

yjang@kookmin.ac.kr



# Data Decoding Procedure of OCC

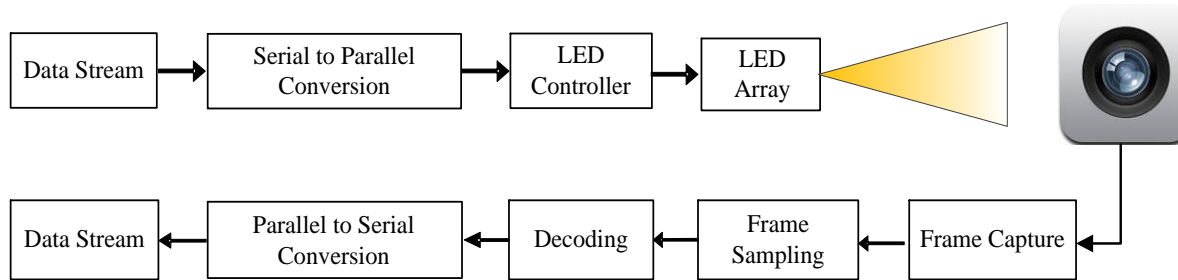

**Proposed block diagram for OCC system**

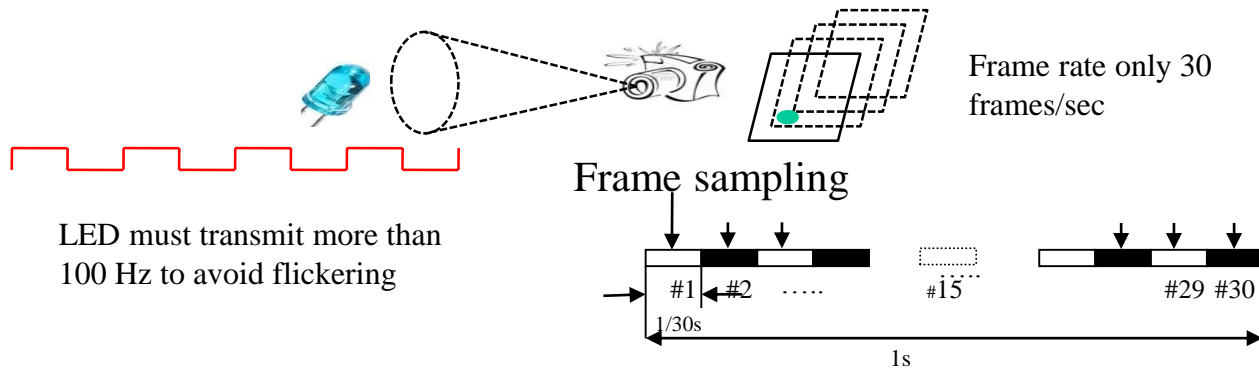

## Data decoding procedure

# Optical MIMO

❖ Low data rate due to low frame rate can be overcome using optical MIMO

❖ **Transmitter:**

❖ Multiple arrays of LEDs should be considered

❖ Each LED or group of LEDs can be used as transmitting antenna.

❖ **Receiver:**

❖ Either camera or image sensor (IS) can be used as receiver

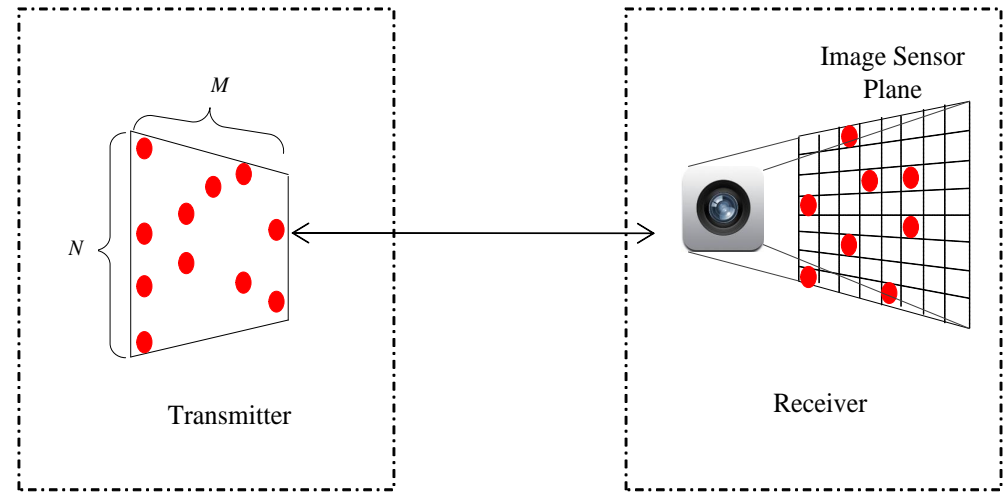

Spatial separation of multiple LED at receiver side

# Challenges for MIMO OCC System

## ❖ Combining multiplexing and diversity for OCC

- ❖ **Objective:** Capacity enhancement (for speed) and robust communication link (for reliability)
- ❖ **Problem:** To achieve optimum gain when both diversity and multiplexing are combined
- ❖ **Remark:** To introduce MIMO coding schemes (V-BLAST and STBC) into OCC

## ❖ Spatial Separation of pixels (channels)

- ❖ **Objective:** Distinguish the multi-channel by successful pixel separation
- ❖ **Problem:** Pixels may overlap and result inter-symbol interference
- ❖ **Remark:** Efficient algorithm to distinguish pixel. Selection and combining schemes (e.g. MRC, generalized selection combining etc.) can be used in OCC to select channels (pixels) with highest SNR values

## ❖ Transmitter and receiver alignment problem

- ❖ **Objective:** To increase the number of rank of the channel matrix
- ❖ **Problem:** Placing receiver in corner of the room reduce the channel rank to one, therefore it is impossible to achieve diversity as well as multiplexing
- ❖ **Remark:** To introduce angle diversity and tilting receiver arrangement

# OCC based Positioning

- ❖ Transmission of ID (coordinate) through LEDs
- ❖ Camera can be used to decode ID information.
- ❖ Triangulation method along with LEDs ID are used to determine user's position.
- ❖ Some legacy positioning methods for OCC are
  - ❖ TOA
  - ❖ TDOA
  - ❖ AOA
  - ❖ RSS
  - ❖ Cell ID

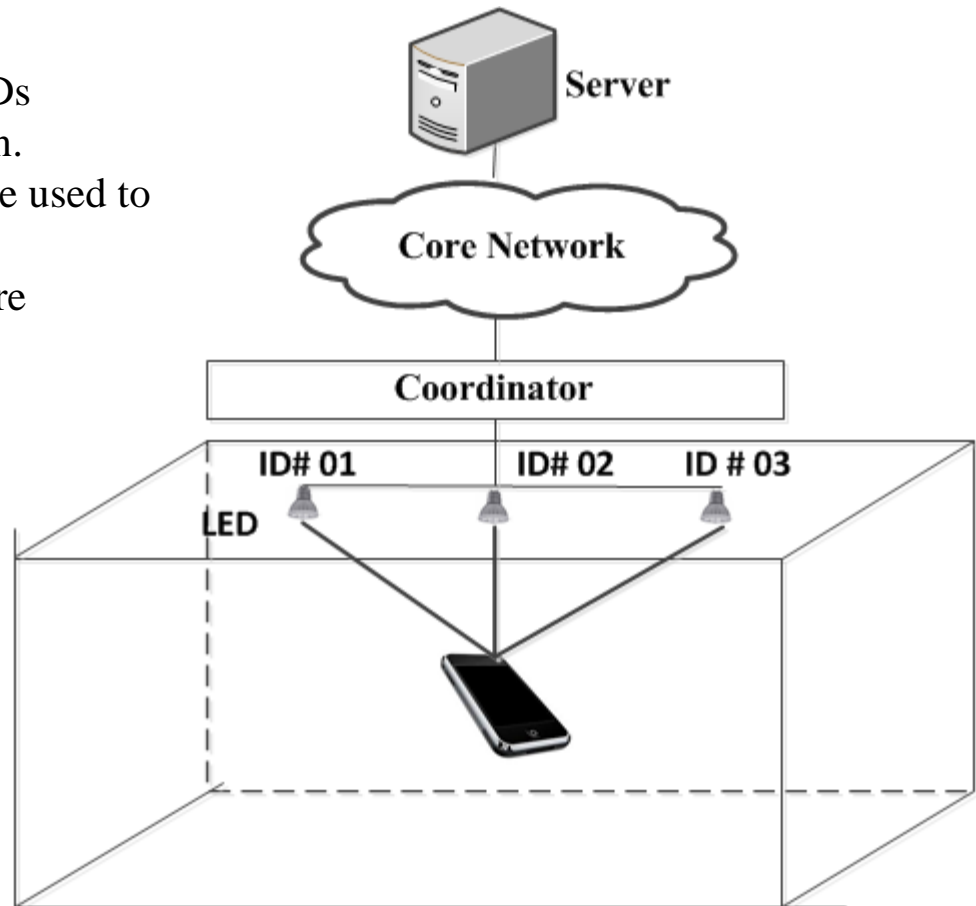

# Positioning based Service Scenario

## LBS using OCC Positioning

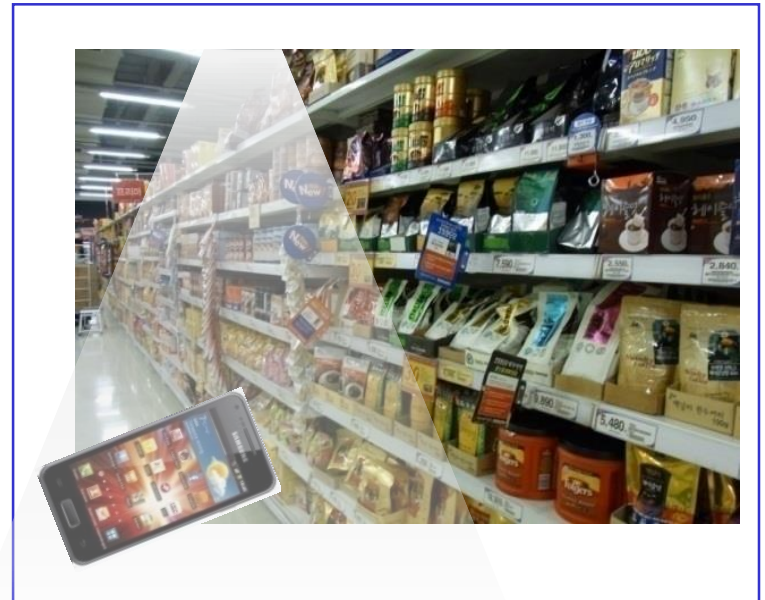
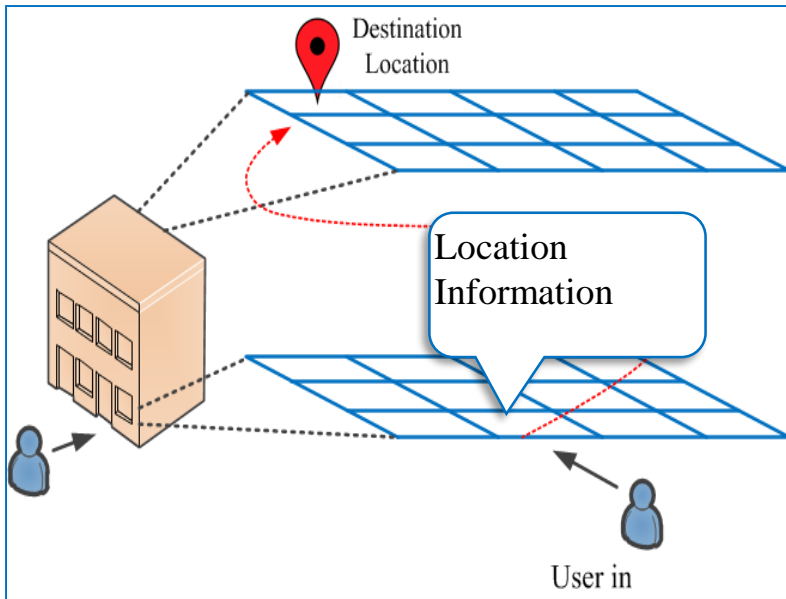

**Indoor navigation**

CASIO COMPUTER CO., LTD

Nobuo IIZUKA

iizukan@casio.co.jp

OCC PHY for Low-speed OCC  
MP2P with Position acquisition in PHY layer

※MP2P:Multi Point to Point  
(LEDs to Camera)

# Use Case

- Unidirectional, MP2P
  - MP2P can provide following functions
    - Bandwidth: By parallel transmission, increasing the amount of information
    - UI: Detail information select on Camera monitor. Lower layers of the communication provides a UI function .
- Low speed, ID Beacon or simple data transmit
  - Low speed: pulse rate 5Hz – 500Hz (Tentative)
- Use at a distance range of 0.5m ~ 100m or more.
- No need of specialized camera architecture.  
Easy to implement in software base at smartphone or other conventional camera system.
- Application: O2O, IoT, M2M ....

# Proof of concept (Demo videos)

- O2O<sub>(smartphone)</sub>
  - Transmit from signage/signboard

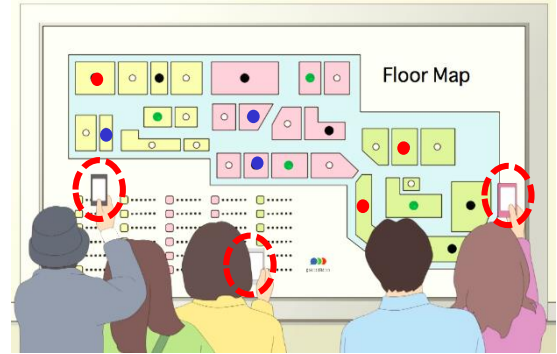

- IoT<sub>(smartphone)</sub>
  - LED indicator of appliances

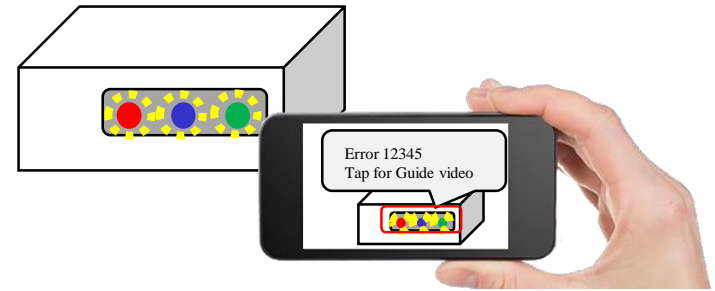

- M2M/IoT<sub>(PC)</sub>
  - Multi data receive with surveillance camera and add-on LED transmitter

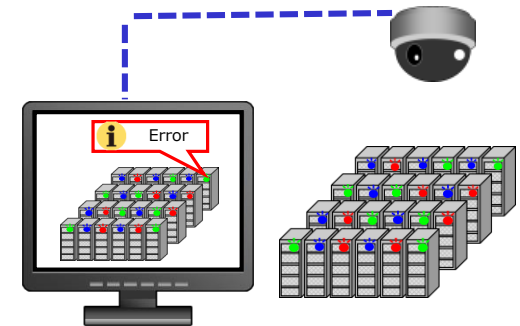



# Processing model

Number of signals, positions, sizes and shapes are all the unknown.

**Discovery** process combined with image processing is important .

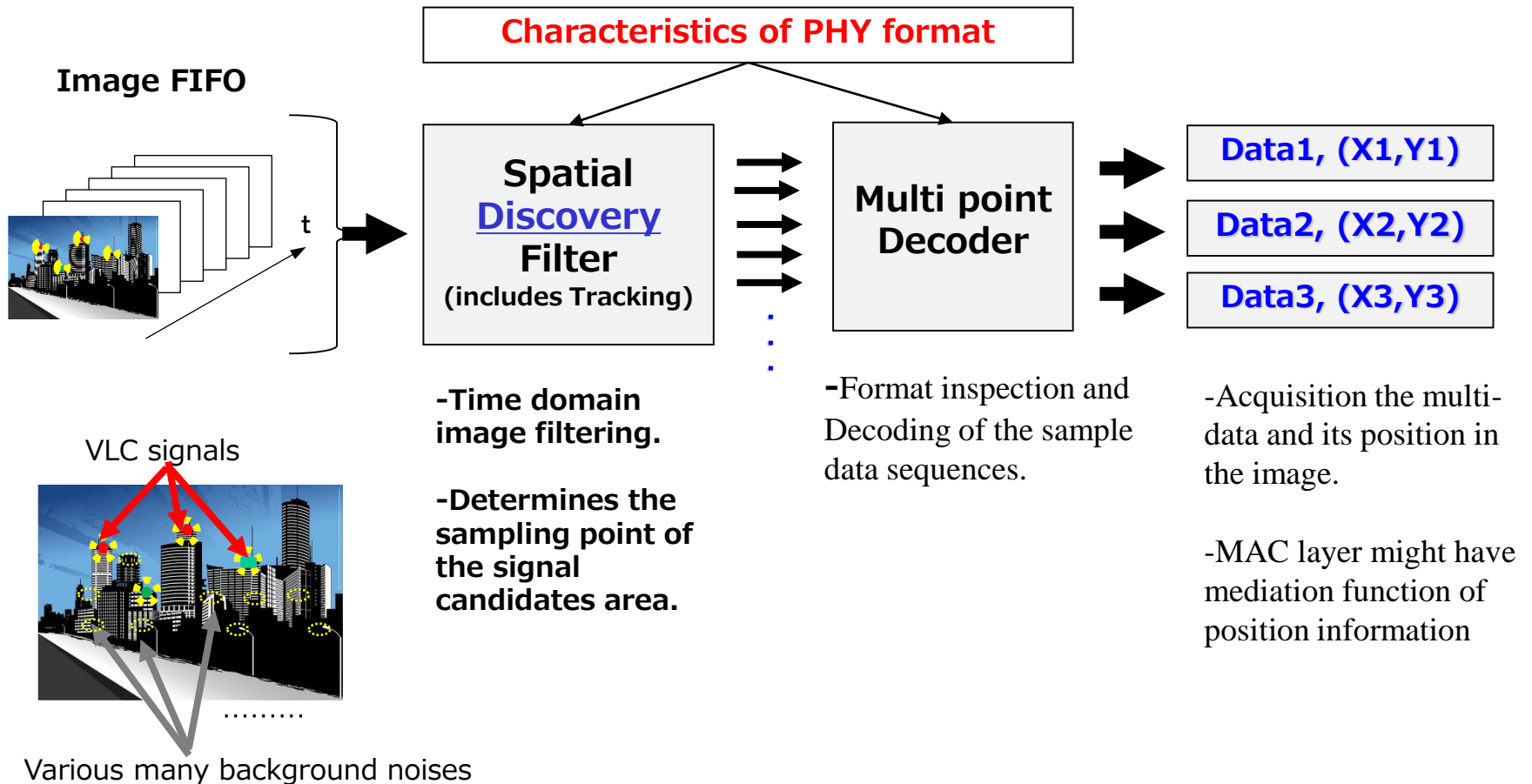

# PHY that is easy to realize the discovery process

What characteristics of PHY is well for implement of “Discovery Filter”.

- Well known methods? ... -Not Suit, especially in low frame rate
  - Frequency base (base-band frequency filter or sub-carrier filter)
  - Ordinary preamble detect

It is difficult to distinguish the signals from a natural scene.
  
- Recommended method –work well in low frame rate
  1. RGB Color code (ternary modulation)
    - 8B6T line coding and guard ternary pulse (8B6T: 8bit to 6Ternary)
  
  2. ON/OFF code with Pseudo header & I-4PPM
    - Suit for Discovery but Inadequate bit rate on 10~30fps. (To be discussed on another occasion)
  
- In the PHY , it might be better to considered these issues
  - Frame drop (Often, It is difficult to clearly detect)
  - White balance, Exposure shift (Can not often control from the application layer)

# PHY format (Tentative)

- DC component of the color pulse fluctuation is suppressed (consecutive prohibited exceed the same three color)

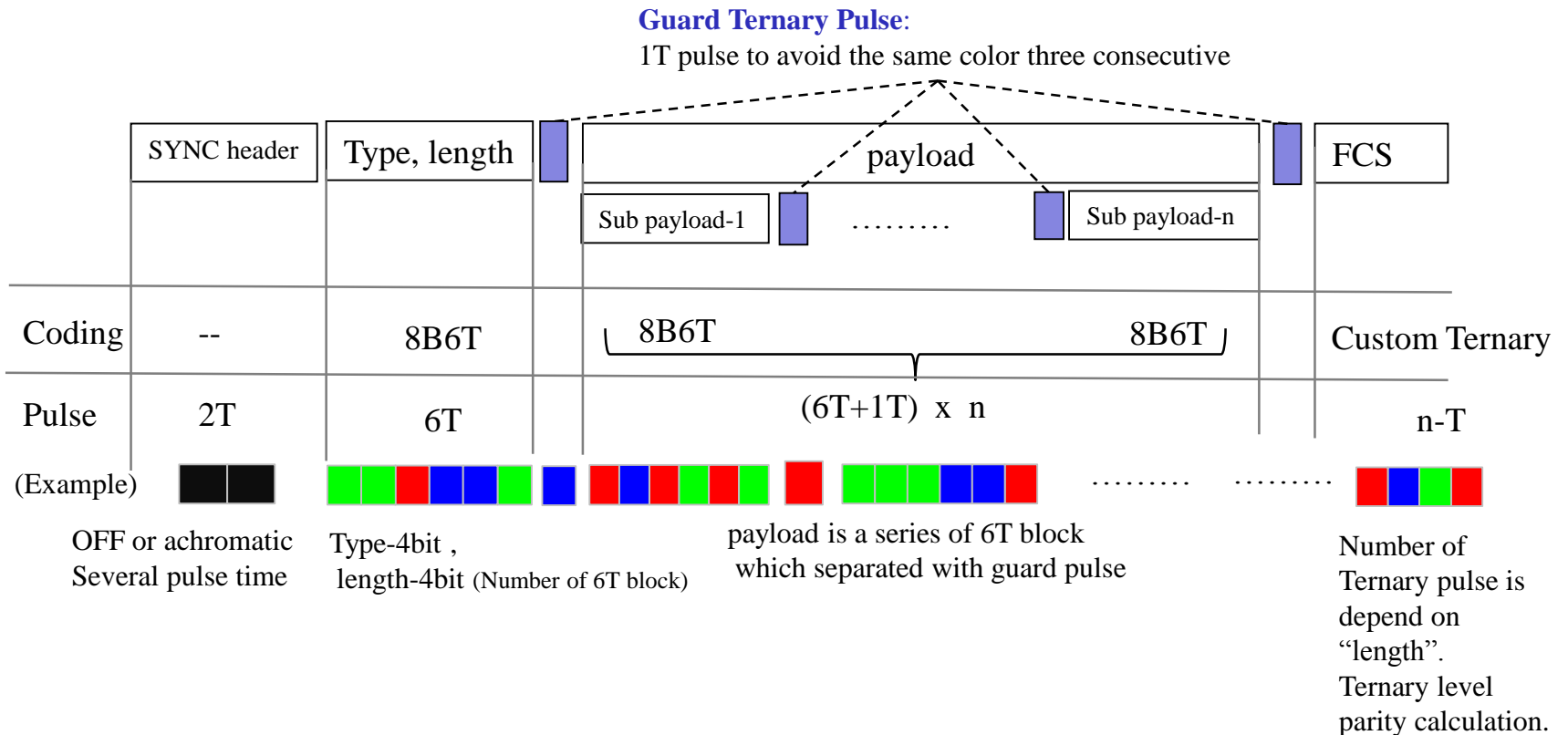

# Conclusion

- MP2P with position acquisition in PHY layer
  - Highly potential of new communication concept of OCC
  - MP2P with position acquisition in PHY layer  
(※Coordinate is in the image frame)
  - Position acquisition is Good Side Effect of PHY.  
Therefore, it is not necessary to care in PHY layer format for MP2P.
- PHY layer format should be considered for “Discovery” process.
  - Favorable properties can be expected in low-speed software-based implementation.
  - 8B6T line coding and guard ternary format was shown.

# Universal Camera Communications with Rolling Shutter – Frequency Shift Keying

National Taiwan University, Mobile and Vehicular  
Network Lab Contribution

Hsin-mu (Michael) Tsai (NTU), Richard Roberts (Intel)

[hsinmu@csie.ntu.edu.tw](mailto:hsinmu@csie.ntu.edu.tw)

# Use Case: Marketing or guide systems

March 2015

doc.: IEEE 802.15-15-0112-03-007a

- Marketing or guide systems:
  - LED transmits URL
  - Mobile devices with **(unmodified)** cameras receives URL and retrieves additional information (with WiFi or cellular data connection) about the item

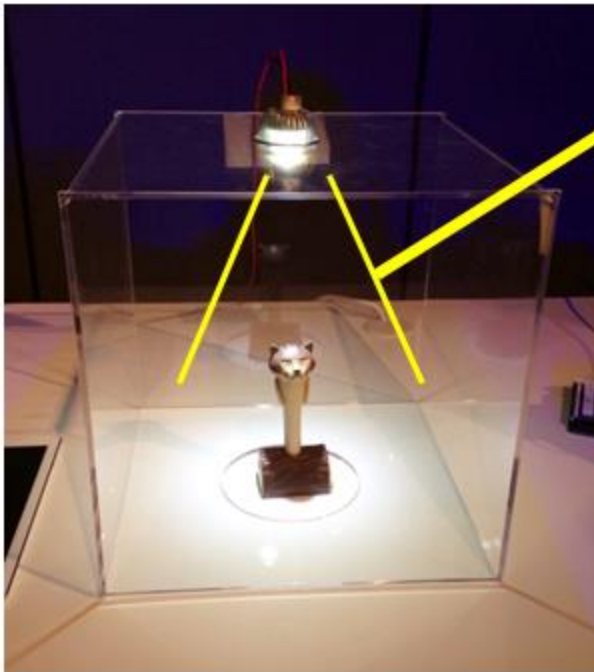

LED transmits URL with info. about the item

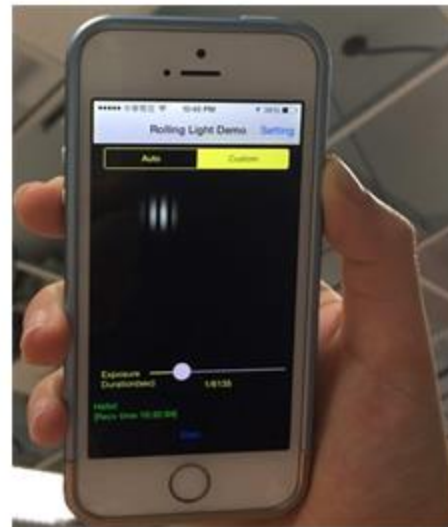

A smartphone's camera receives URL & displays text or video about the item on the screen

# Use Case: Vehicular Communications

March 2015

doc.: IEEE 802.15-15-0112-03-007a

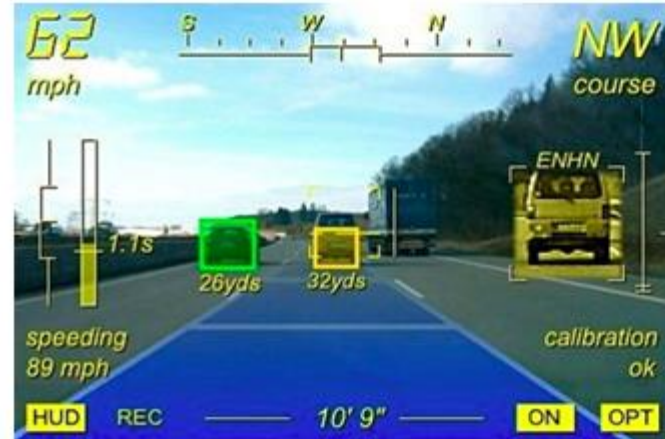

- Vehicular Communications

- Each vehicle broadcasts its license plate number, speed, brake status periodically with the LED lighting (**tail light, head light, etc.**)
- Neighboring vehicles receive information with **existing front & back cameras** (with software upgrade) for use in Advanced Driver Assistance System (ADAS) & other safety systems
- Additional information can be received from DSRC/cellular, but these information can be visually associated with neighboring vehicle's identity (e.g., the car that I see, in front of me and in the same lane) once the license plate number is received via camera communications

# Related Research & Demo

March 2015

doc.: IEEE 802.15-15-0112-03-007a

Our proof-of-concept is demonstrated at:

1. H.-M. Tsai, H.-M. Lin, and H.-Y. Lee, "Demo: RollingLight - Universal Camera Communications for Single LED", ACM Annual International Conference on Mobile Computing and Networking (MobiCom), September 2014.
2. "Demo: Universal Camera Communications," Intel Asia Innovation Summit, Taipei, Taiwan, November 2014

An LED light driven by a simple driver module (Arduino Mega 2560 + a MOSFET switch)

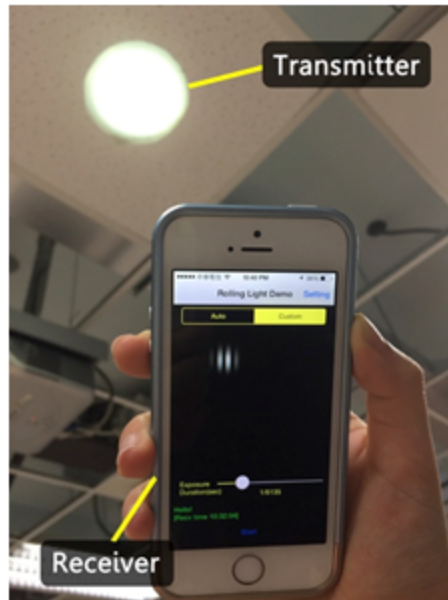

iOS 8 devices (iphone 5S, 5C, iPad Air) + our app can decode simple text transmitted by the light



# Rolling Shutter - Frequency Shift Keying

March 2015

doc.: IEEE 802.15-15-0112-03-007a

## Modulation:

- Square wave (2 levels)
- Different **frequency**  
→ different bit patterns
- Symbol duration = frame duration  
& high-order modulation

## Demodulation:

- Estimate strip width  
(signal period) with  
either FFT or  
autocorrelation methods

$$s_i(t) = I_{\max} \left[ \frac{\cos(2\pi f_i t)}{2} \right]$$

$$W = \frac{1}{f_i T_r}$$

$W$ : pixel width of strip  
 $f_i$ : frequency of symbol  $i$   
 $T_r$ : read-out time

$s_i$ : signal of symbol  $i$

$I_{\max}$ : max intensity

$f_i$ : frequency of symbol  $i$

$t$ : symbol sampling time



(a) 8000 Hz



(b) 4000 Hz



(c) 2000 Hz

Why

## Frequency Modulation?

- Compatible to cameras with **different sampling rates (read-out time)**
- Ability to decode even with **loss of a large portion of signal samples**
- Average intensity stays the same – **transmissions not observable by eyes**

Why

## Square Wave?

- Mitigate the impact due to the **filtering** caused by long exposure
- Only two output levels – **cost effective**
- Change of duty cycle is possible – preserve ability for **dimming support**

- Existing computer vision techniques: identify what a group of pixels are (e.g., A car, lane marks, a traffic signal)
- Camera communications: received information comes from **the same / nearby group** of pixels (e.g., the car's tail light)
- Easily and **visually associate** received information with the identity of the object (a car or a traffic signal)

## Part 3: Higher Rate PHY

University of Science and Technology of China

Wireless-Optical Communication Key Laboratory of

Chinese Academy of Sciences Contribution

Qian Gao, Chen Gong and Zhengyuan Xu

{qgao, cgong, xuzy}@ustc.edu.cn

# Energy-efficient VLC under Lighting Constraints



**To achieve Energy-efficient VLC without interrupting illumination**

- ❖ Highly efficient modulation scheme;
- ❖ LED radiation pattern design;
- ❖ Optimized LED spatial arrangement;
- ❖ “Unshadowable VLC”: a non-line-of-sight system architecture

# The DC-bias also carries information for a highly energy-efficient VLC

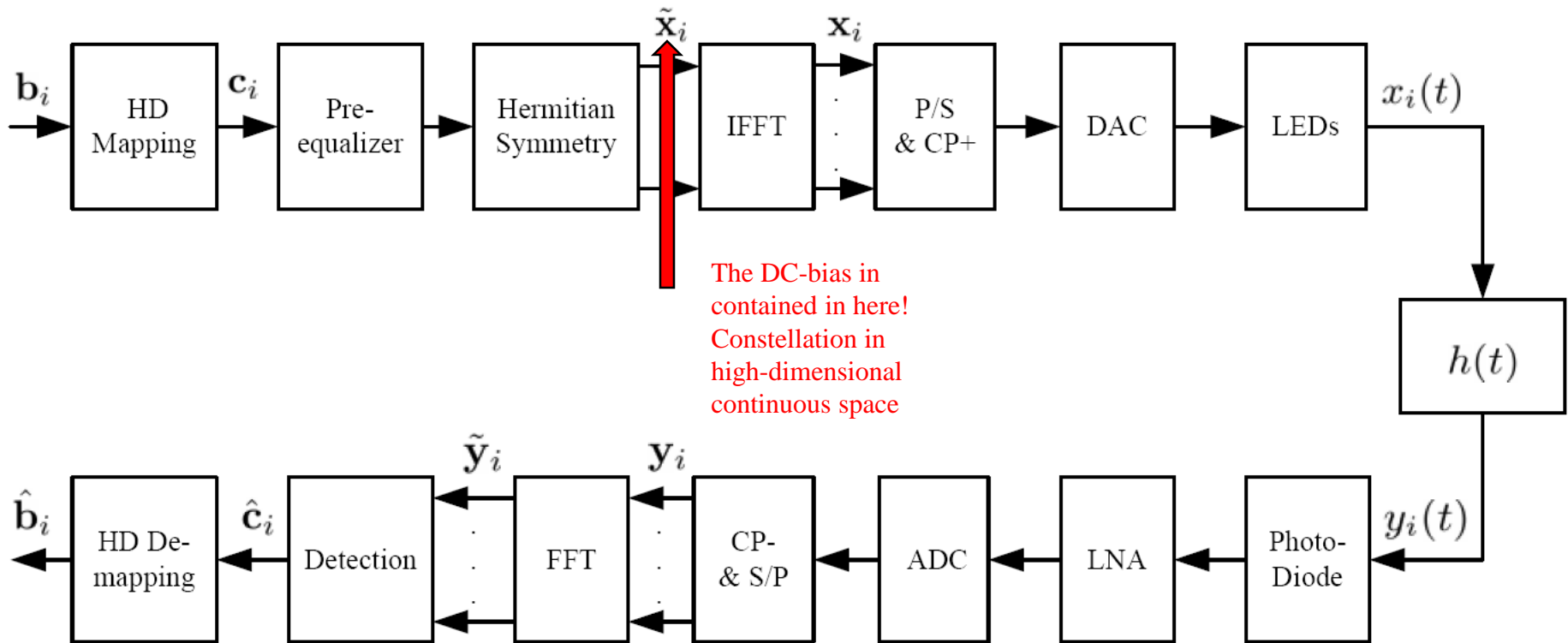

[1]. Q. Gao, C. Gong, R. Wang, Z. Xu, and Y. Hua, "From DC-Biased to DC-Informative Optical OFDM," arXiv:1410.6885 [cs.IT], Oct. 2014.

Employ or design optical devices such structure:

- ❖ Suitable for high-speed VLC;
- ❖ Suitable for high-efficiency VLC;
- ❖ Guaranteed uniformity of illumination;
- ❖ Higher gain, higher field of view, compact type.

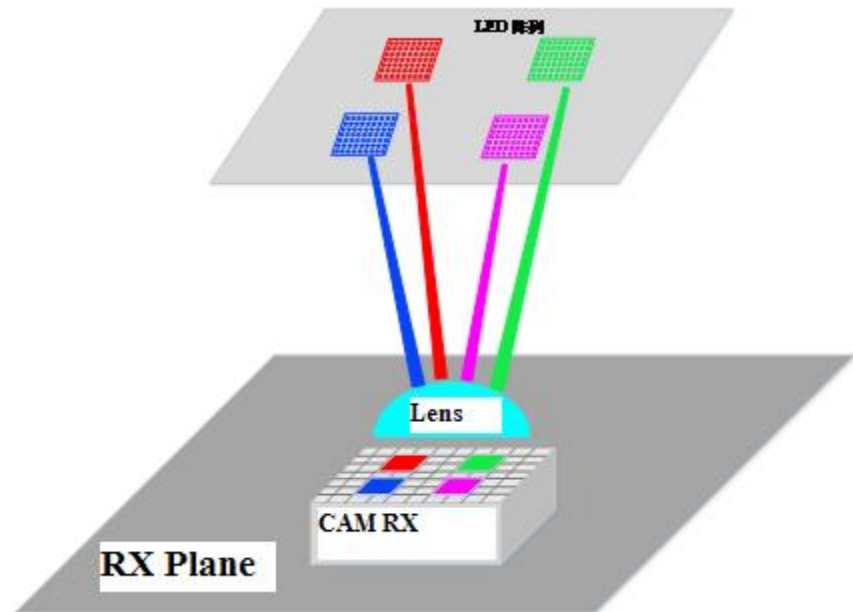
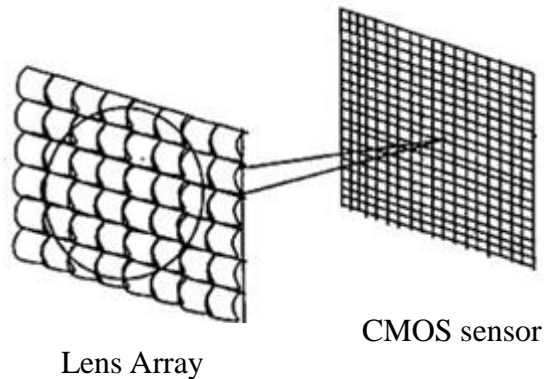





## **LED spatial arrangement For illumination uniformity**

## **LED radiation patter design For illumination uniformity**



# Unshadowable VLC

## A non-line-of-sight transmission experiment

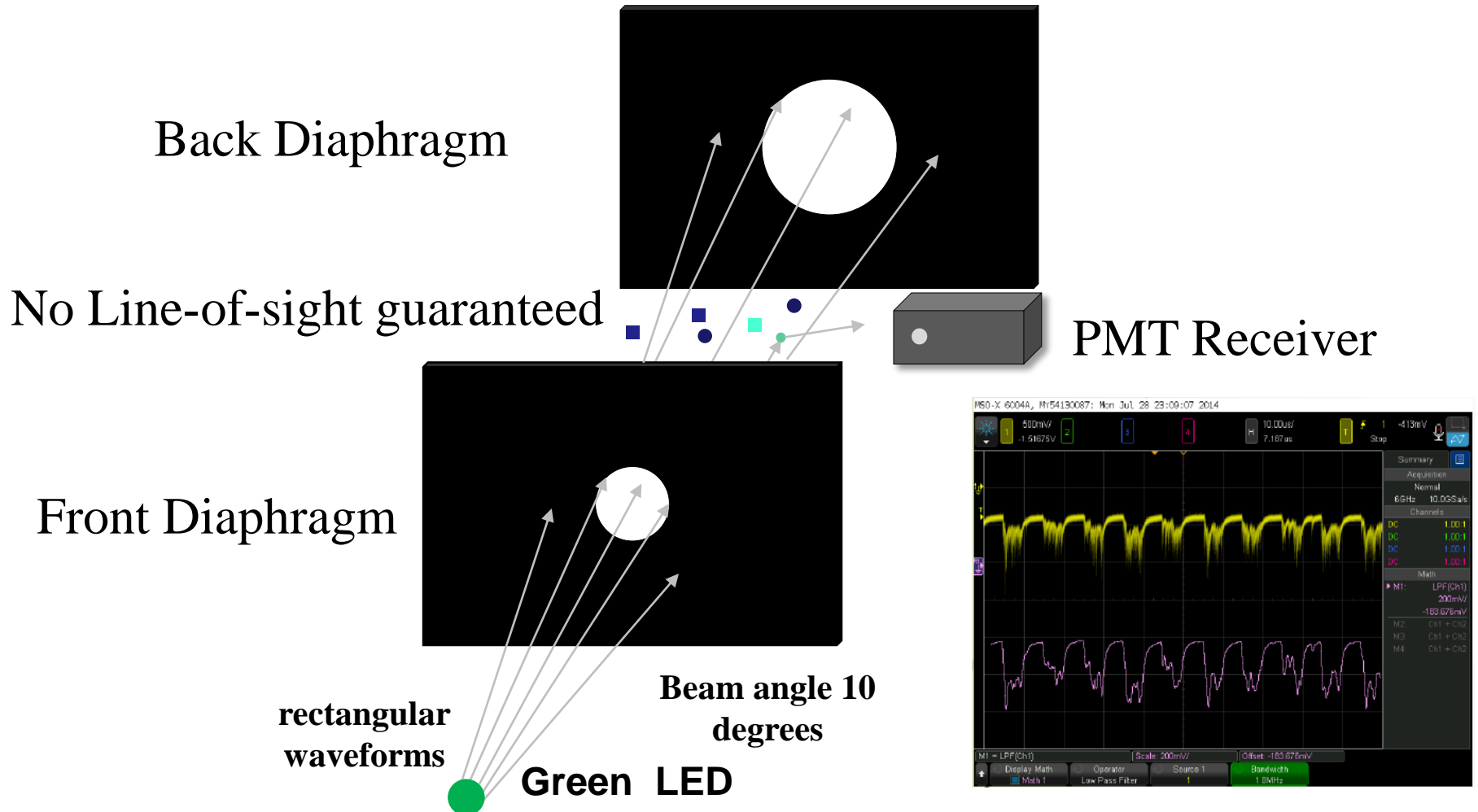

# Conclusion

We address the issue of VLC system design under light constraints from the following aspects:

- ❖ DC-informative modulation design;
- ❖ Methodology on optical structure theory;
- ❖ LED spatial arrangement and radiation pattern design;
- ❖ Unshadowable VLC design and experiment.

# PureLiFi Ltd. Contribution

Nikola Serafimovski

[nikola.serafimovski@purelifi.com](mailto:nikola.serafimovski@purelifi.com)

# Use-Cases



## 802.15.7r1

- Flexibility to deploy a range of more efficient PHY systems
- Improved dimming support
- Enhanced MAC
- Support for greater security

# Proof of Concept

- Li-1st (<http://purelifi.com/li-fire/li-1st/>)
  - ✓ point-to-point, high speed, bidirectional, off-the-shelf lights
  
- Li-Flame ([http://youtu.be/TIAS8BxGe\\_8](http://youtu.be/TIAS8BxGe_8))
  - ✓ high speed, bidirectional, networked and mobile wireless communications using light

# Technical Principles

- Optical OFDM
  - ACO-OFDM
  - DCO-OFDM
  - U-OFDM
  - .....



# High Level Concepts

- High speed
  - efficient use of Optical Bandwidth
- Bidirectional
  - to alleviate spectrum
- Networked & Mobile
  - user expectations of wireless technology
- Secure & Safe
  - Privacy, Cybersecurity and EMI concerns



# **COST Action IC1101**

## **Optical Wireless Communications**

### **- An Emerging Technology**



# **Gbit/s Optical Wireless PHY**

- Joint contribution to IEEE 802 plenary tutorial -

V. Jungnickel, H. Haas, E. Ciaramella, M. Wolf, R. Green,  
P. Haigh, Z. Ghassemlooy, V.P. Gill, T. Baykas, M. Uysal

# ● ● ● Use cases

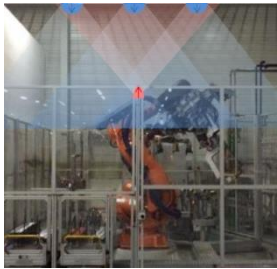

IoT: Flexible Manufacturing



Conference Rooms



Private Households



In-flight Entertainment



Mass transportation



IoT: Car2Car, Car2Infra

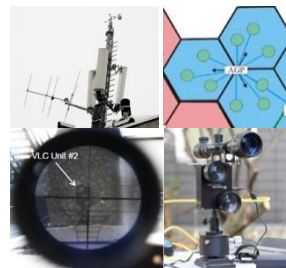

Opt. Backhaul for small cells in 5G



Augmented reality, hospitals, support for disabled people

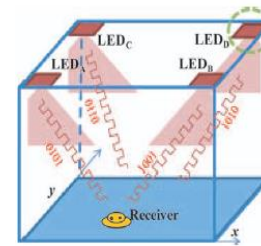

Precise Indoor Positioning



Secure Wireless



# Requirements

- High speed:  $> 1$  Gb/s per link
  - Ultra-dense wireless scenarios, Short range (few meters), High spatial reuse
  - Offload high traffic volumes to “private” optical wireless hot spots
- Robustness:  $< 0.1$  % outage in coverage area
  - Seamless mobility support for heterogeneous wireless environments
  - Multipoint multiuser support  $\rightarrow$  positioning, low latency, handover, integration with WiFi
- Low latency:  $< 1$  ms
  - Short response time for the “Tactile Internet”
  - Car-to-X, Industrial environments, Internet-of-things (IoT)
- Precise positioning:  $< 10$  cm
  - Access points send specific beacon signals, terminals reply  $\rightarrow$  time measurement
  - Enhanced security support: Wireless communications near the user location only

# Research results



High-power LED Tx, low cost



Large-area silicon PD Rx, low cost

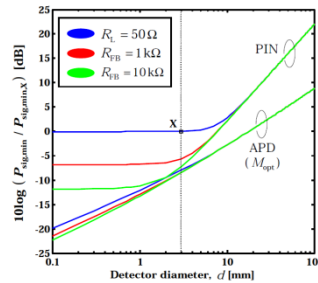

Large PD+TIA similar to APD

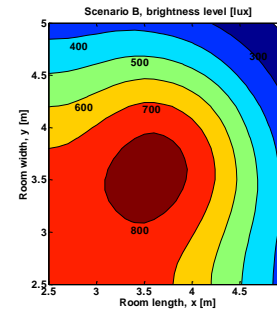

High SNR → high spectral efficiency

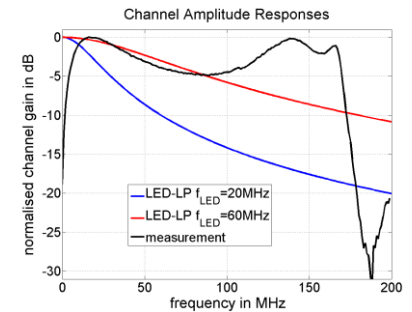

Broadband optical frontends: >100 MHz

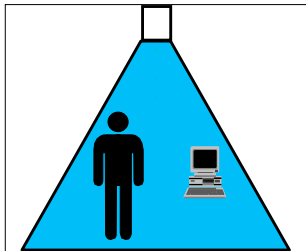

Non-directed LOS+NLOS

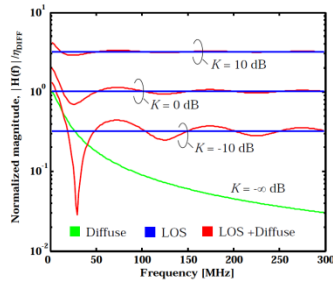

Frequency-selective time-variant channel

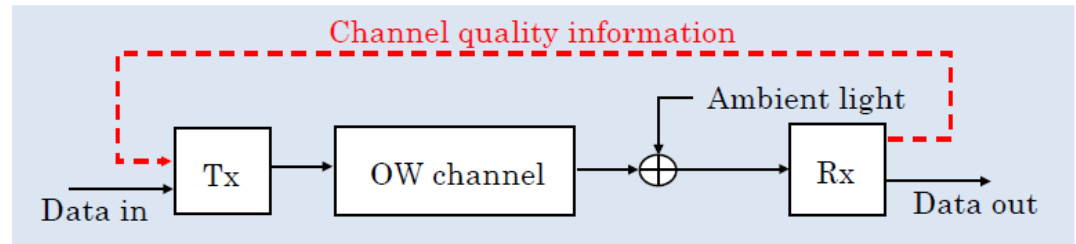

Information theory suggests a multi-carrier system concept which needs adaptation to the channel

# Key technical features

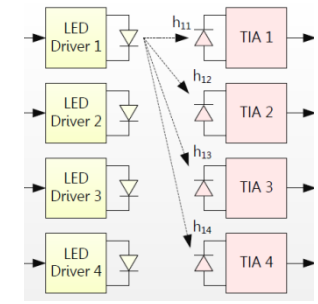
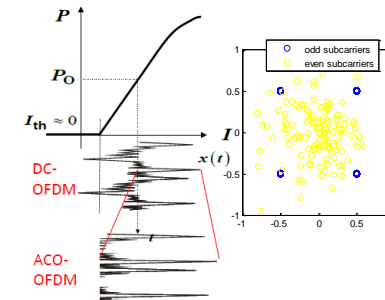
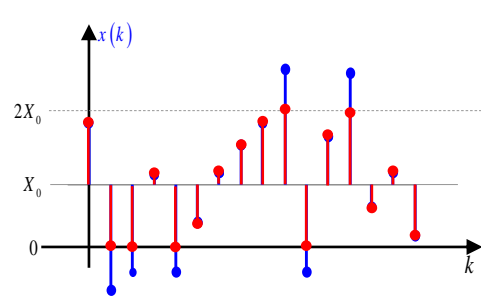
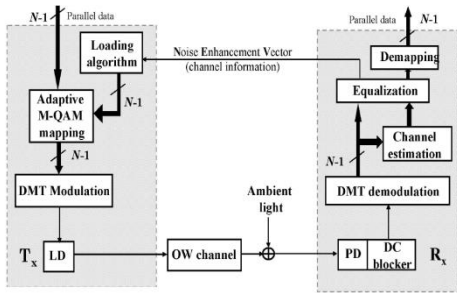

Rate-adaptive OFDM with feedback over reverse link

Clipping is controlled at fixed error rate (DCO):  
*spectral efficiency*

Asym. clipping (ACO),  
enh. unipolar OFDM:  
*energy efficiency*

MIMO, angular  
diversity transmitters  
and receivers

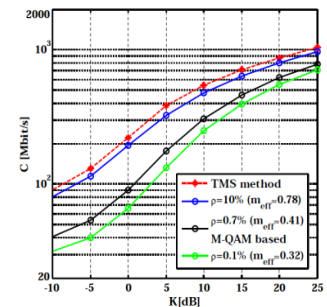
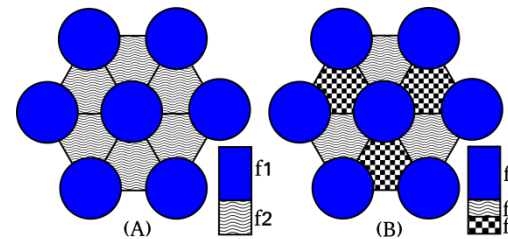
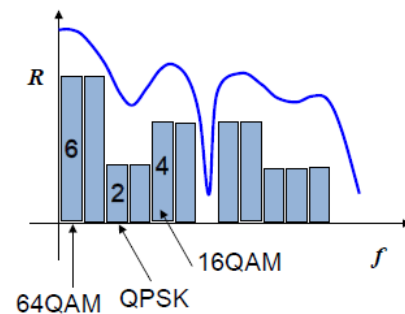
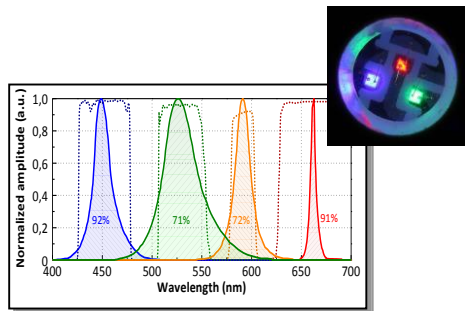

WDM (RYGB LED) to multiply data rates

Closed-loop bit-/power loading, bit-interleaved FEC, HARQ

Cell-specific pilots for positioning, handover, interference coord.

DCO@10% clipping ratio: 2 dB to IM/DD capacity upper bound



# Summary

- Gbit/s optical wireless has many useful applications in WPAN and WLAN
  - Car-to-X, machine-to-machine, WiFi backhaul, conference rooms → SOHO networks
  - Augmented reality, indoor positioning, vertical and horizontal handover
- High-power LEDs and large-area silicon photodiodes are available at low cost
- High SNR, high spectral efficiency, >100 MHz bandwidth → Gbit data rates
- Adaptive OFDM PHY is mature, other options are SC/FDE and M-CAP
- Further performance improvements are possible through cooperation (relaying)
- Robust transmission in multipath and NLOS channels was demonstrated
- Up to 5 Gbit/s and some 100 Mbit/s were demonstrated over several meters using free LOS and diffuse reflections (NLOS), respectively
- Real-time demo with small form factor is available, onsite demo is planned

● ● ● **Supporters**





# Color Space Based Modulation and Color-Independent Visual-MIMO

California State University Sacramento Contribution

Soo-Young Chang

[sychang@ecs.csus.edu](mailto:sychang@ecs.csus.edu)

# Generalized Color Modulation (Color-Space Based Modulation)

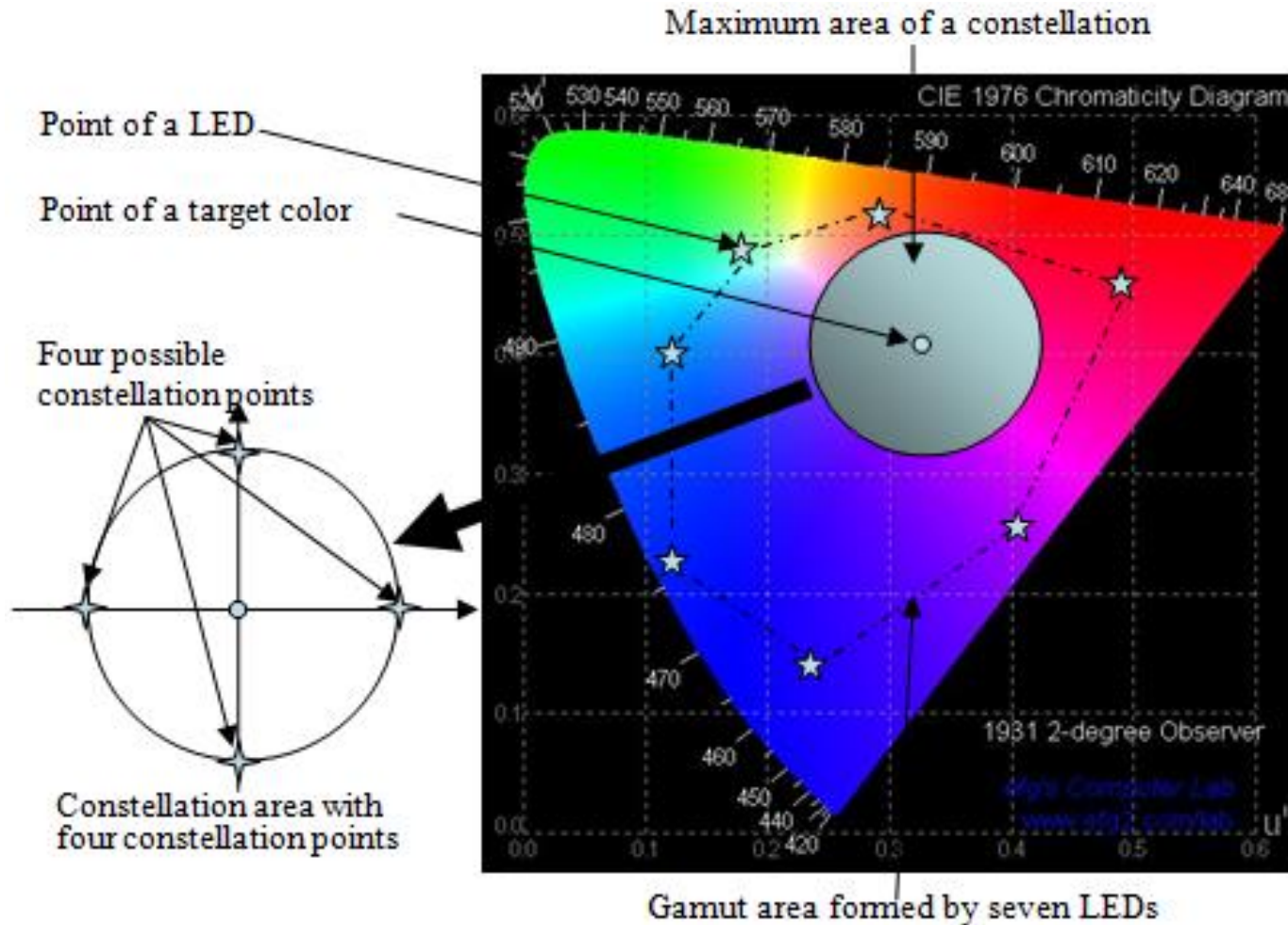

# Constellation Diagram and Various Basic Color Models

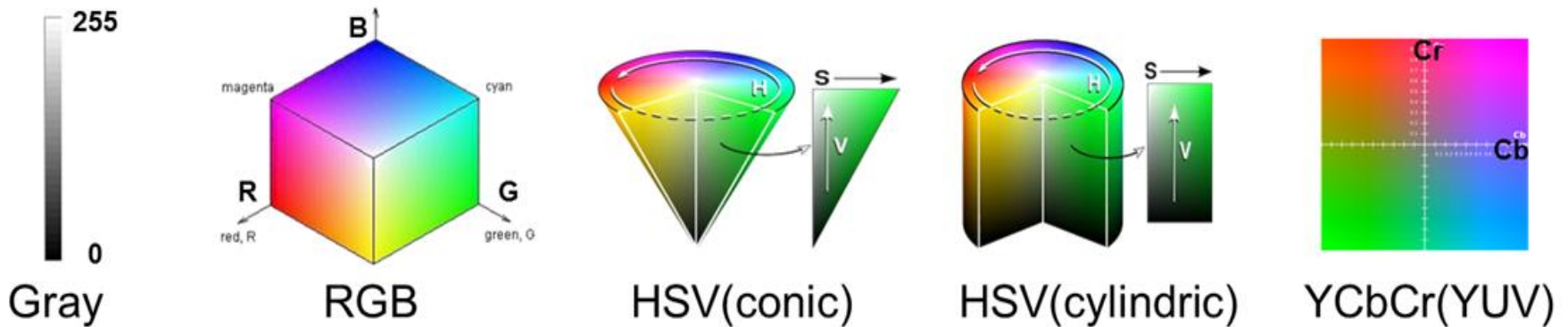
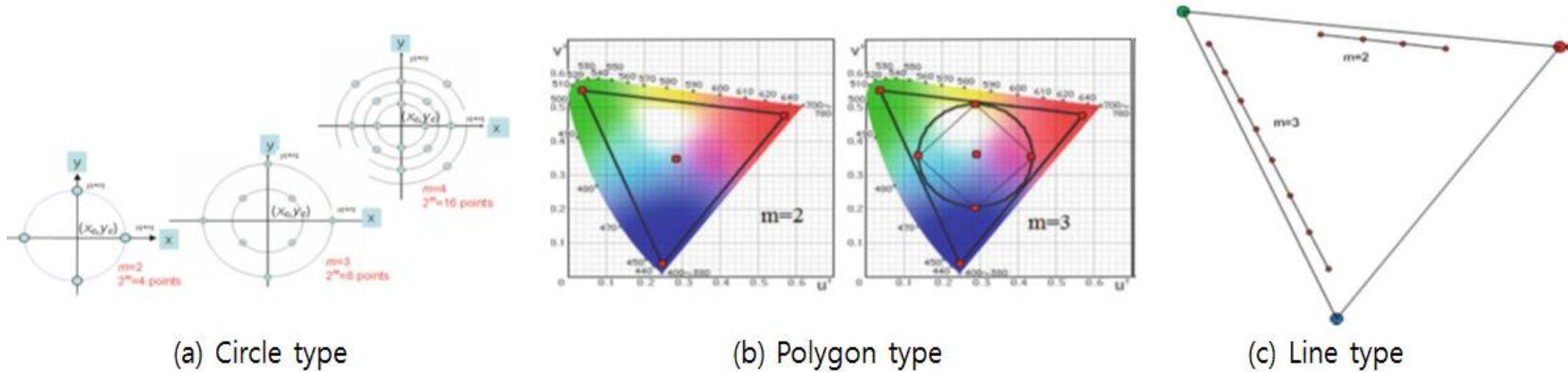

# Simulation Example of SER Comparison under Different Color Models

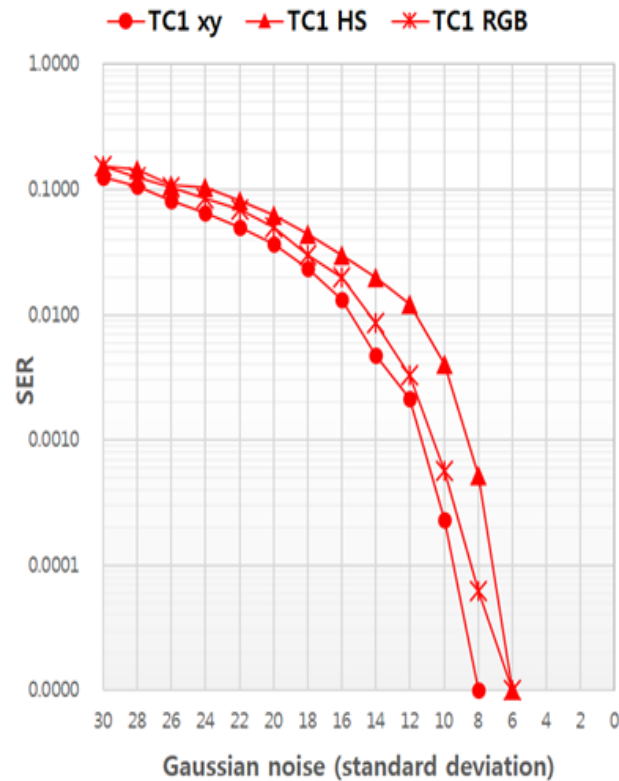
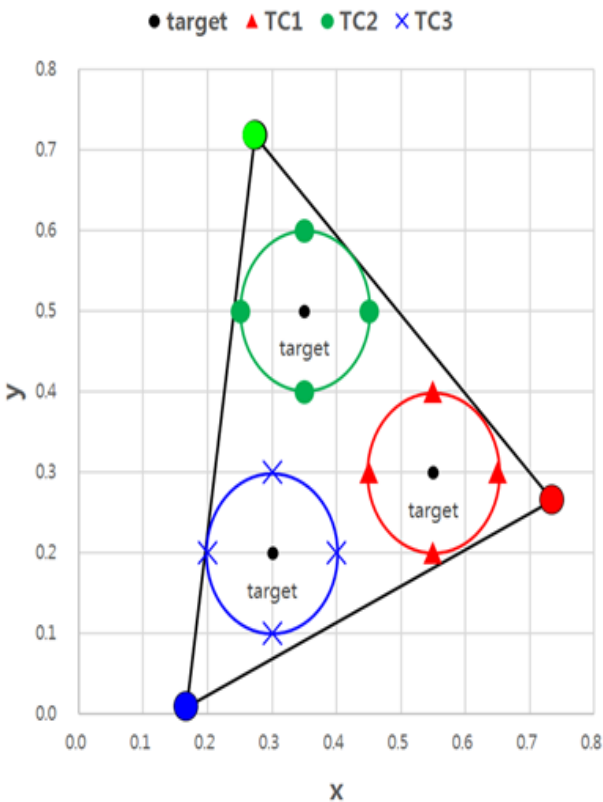

**Constellation diagram and SER graph (TC1 case)**

## Symbol decision methods

1. (x,y) based decision in CIE1931
2. (H,S) based decision in HSV model
3. (R,G,B) based decision in RGB model

# Color-Independent Visual-MIMO

- Independent of Color Variation and Intensity Variation -

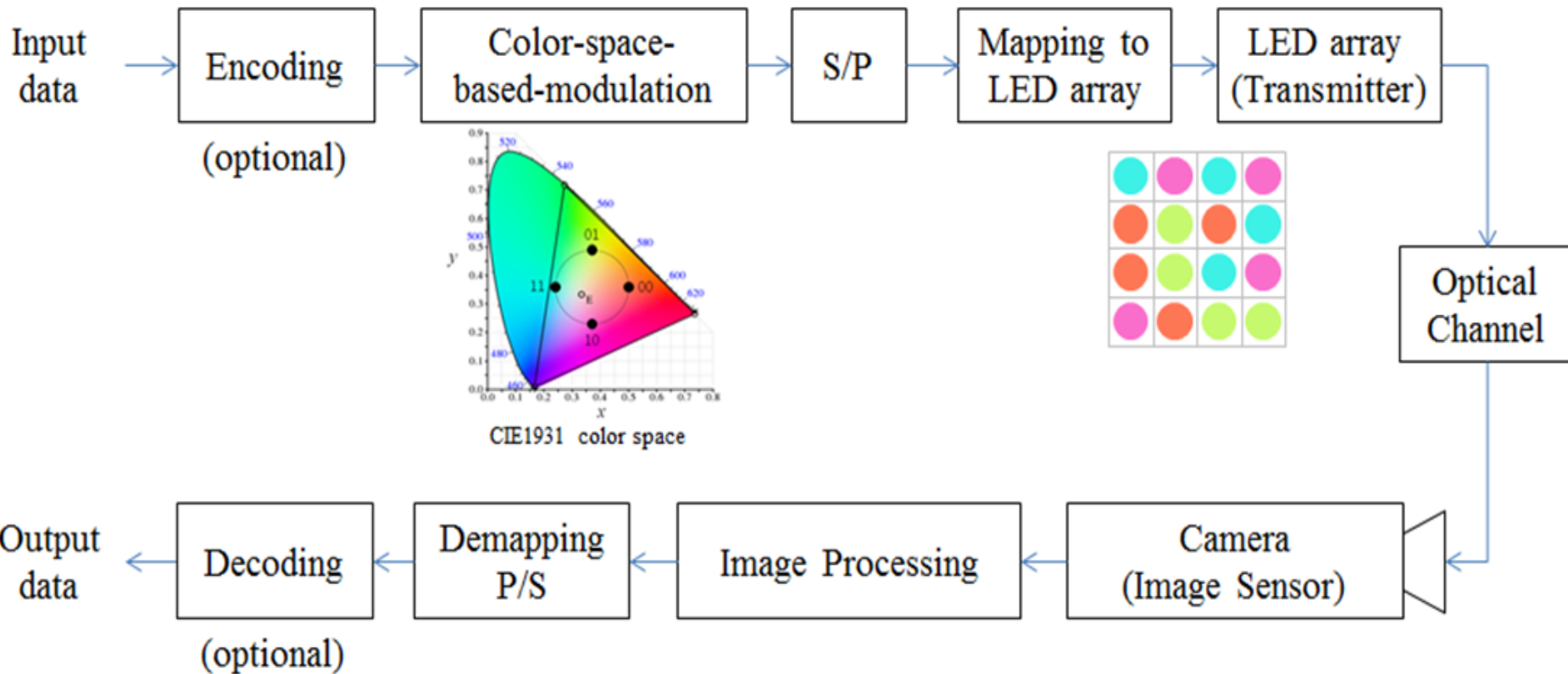

# Data Rate in Visual-MIMO

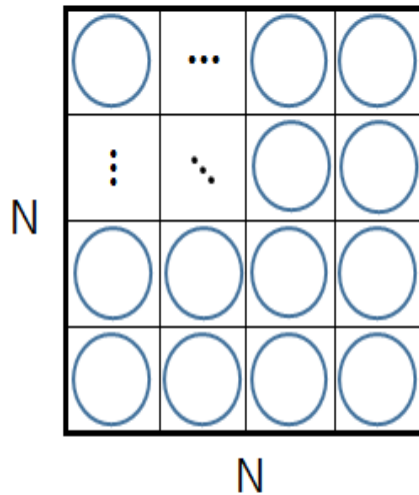
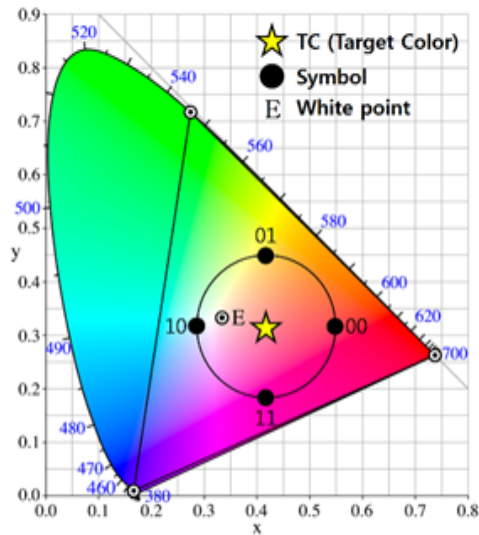

## Encoding

Using  $m(=2^n)$  symbols  
 $\rightarrow n$  [bits/symbol]

## LED Array size

$$N \times N = N^2 \text{ [symbol]}$$

## Camera frame rate

$$F \text{ [fps]}$$

$$\text{Data rate} = n \times N^2 \times F \text{ [bps]}$$

# Example Applications

- Road side-to-vehicle communication
- Vehicle-to-vehicle communication  
LEDs for rear and head-lights and Cameras (e.g. parking assistance, rear-view) are getting common in cars



Visual-MIMO V2V Demo

- Smartphone-to-electronic billboard communication
- Robot-to-robot communication
- Hand-held display to fixed surveillance cameras



Static content

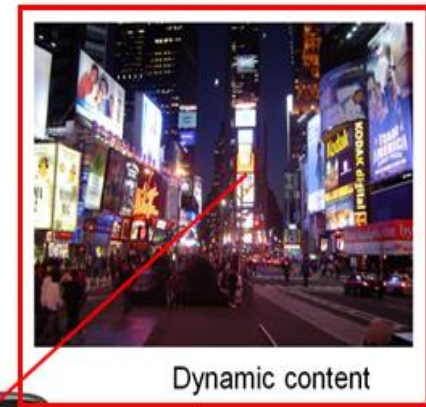

Dynamic content



Visual-MIMO Smartphone-to-electronic billboard comm. examples

# Boston University Contribution

## Dimming Compatible and Spectrally Efficiency Modulation for VLC Lighting

15.7r1 tutorial  
IEEE802 meeting  
Berlin, Germany

March 8-13, 2015

Hany Elgala & Thomas  
Little  
Boston University  
helgala&tdcl@bu.edu

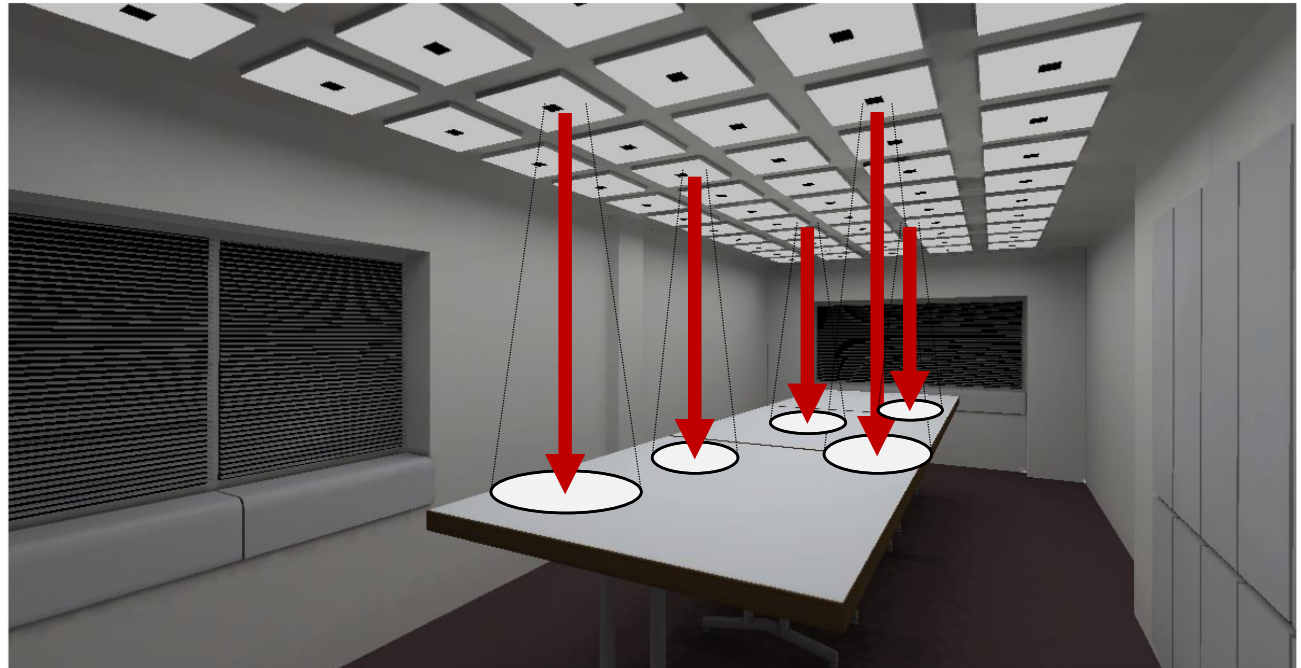



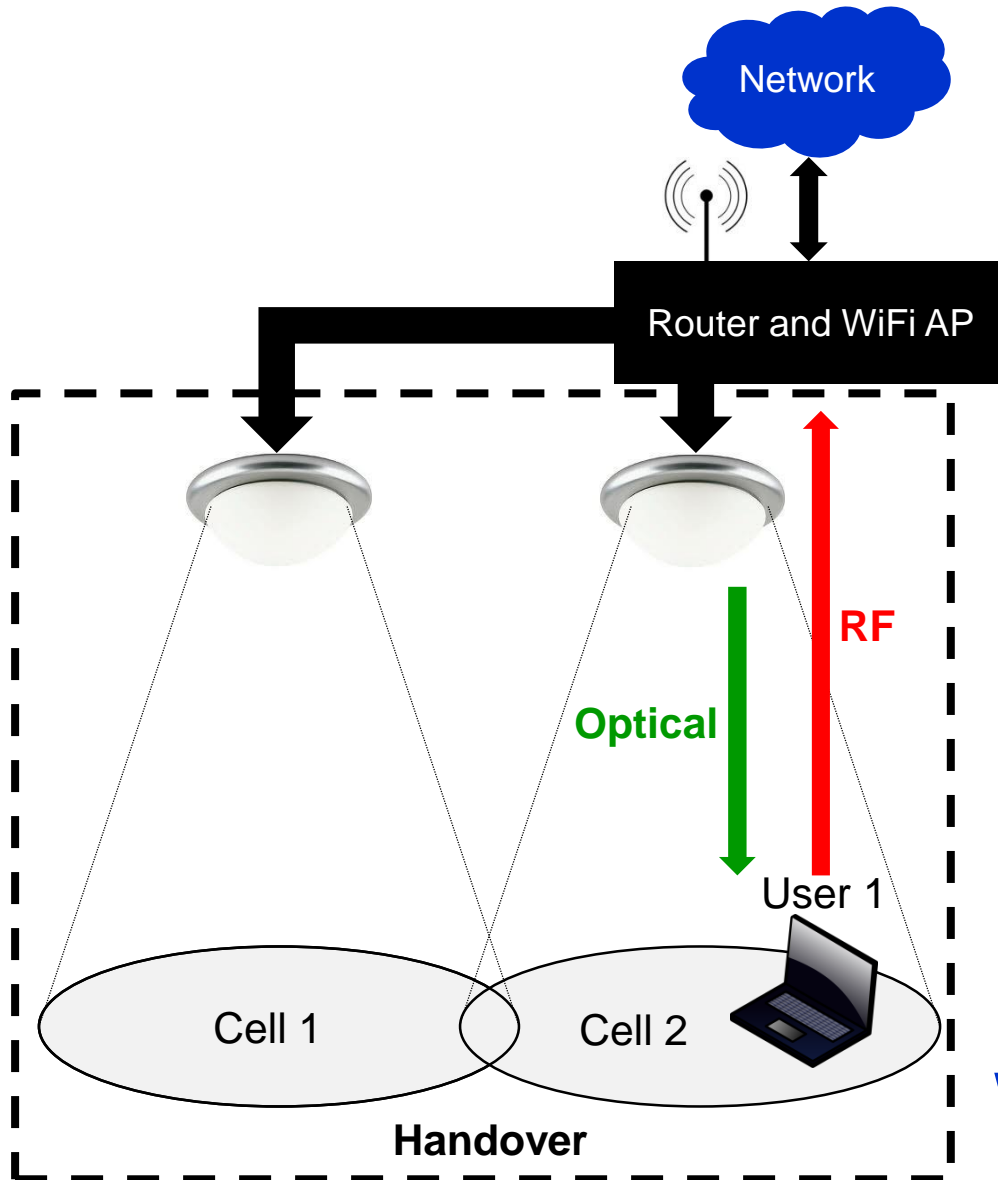

- VLC offloading WLAN and/or cellular traffic in a 3-tier HetNet
- RF for uplink
- Data aggregation in RF and/or optical
- Seamless connectivity in a mobile multiuser access scenario
- Gigabit applications while supporting (our use case):
  1. Illumination functionality
    - a. Color tunable
    - b. Dimmable
  2. High quality lighting
    - a. CCR
    - b. CRI

We focus on dual-use (lighting and Communications)

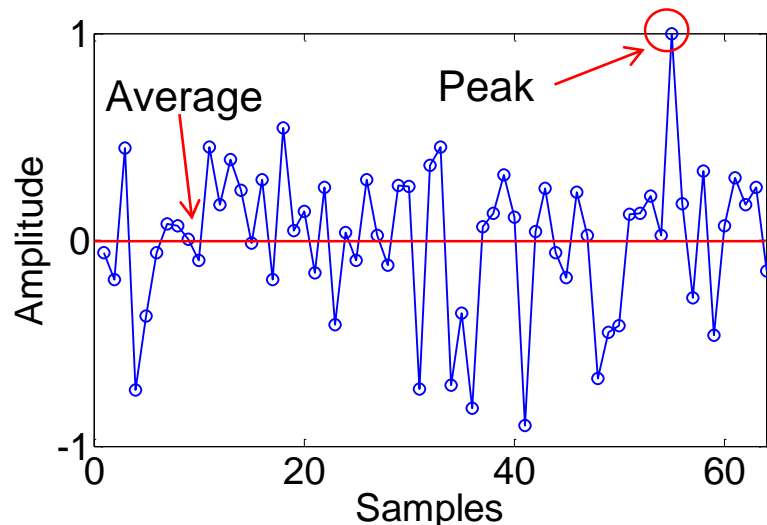
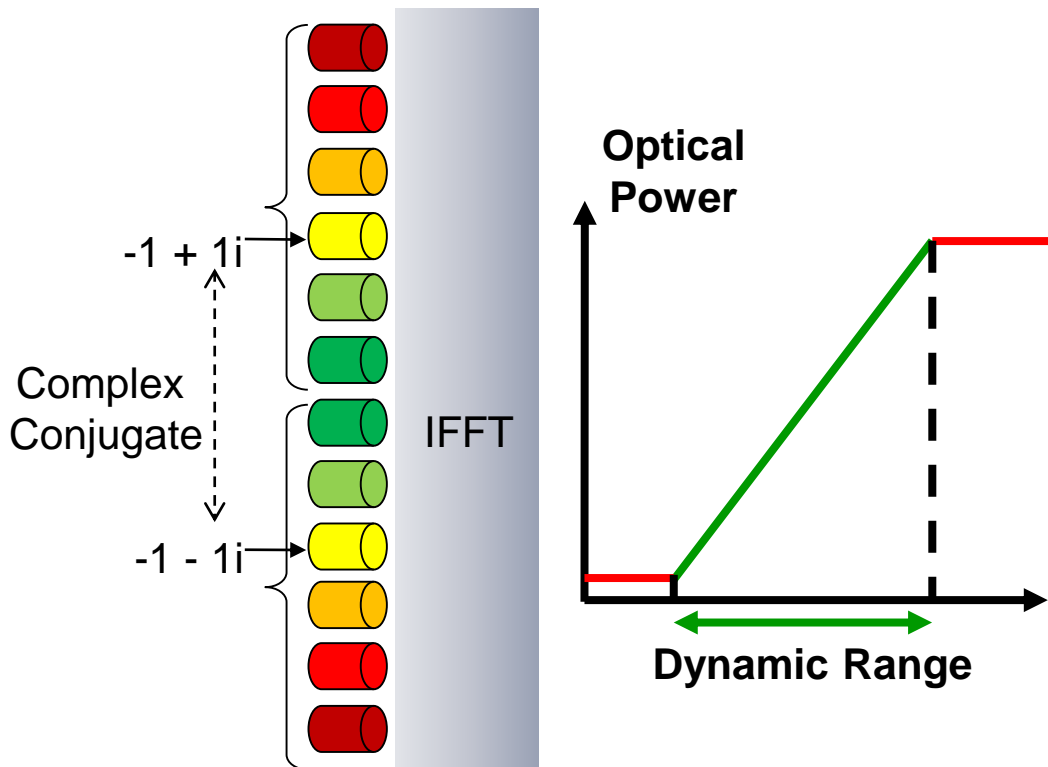

Bipolar DC biased optical OFDM (DCO-OFDM)

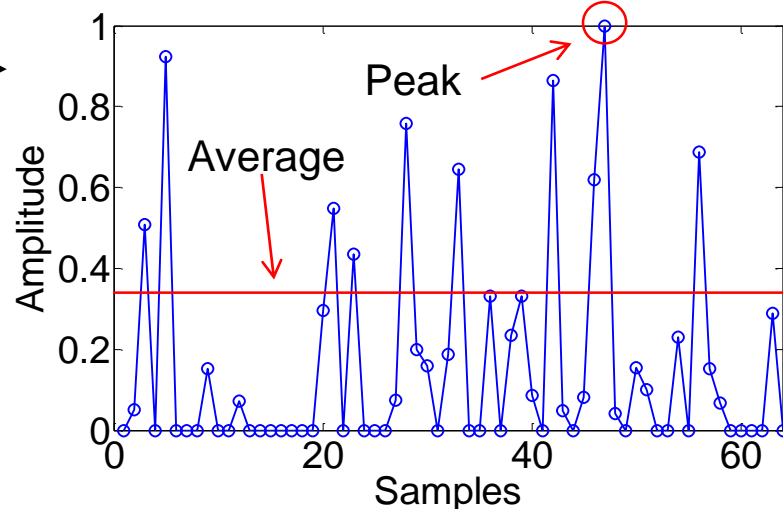

Unipolar Asymmetric clipped optical OFDM (ACO-OFDM)

Other unipolar formats, e.g.:

- Flip OFDM (F-OFDM)
- Unipolar OFDM (U-OFDM)
- Position modulation OFDM (PM-OFDM)

- High spectral efficiency; limited LED modulation bandwidth
- Adaptive bit-loading per subcarrier; transmission impairments
- Adaptive power allocation per subcarrier; transmission impairments
- Fine granularity; network perspective
- CP; multipath propagation causing ISI
- Frequency-domain channel estimation and equalization; transmission impairments
- Possibility to combine it with multiple access schemes; OFDMA
- Availability of OFDM in existing signal processing/chipsets

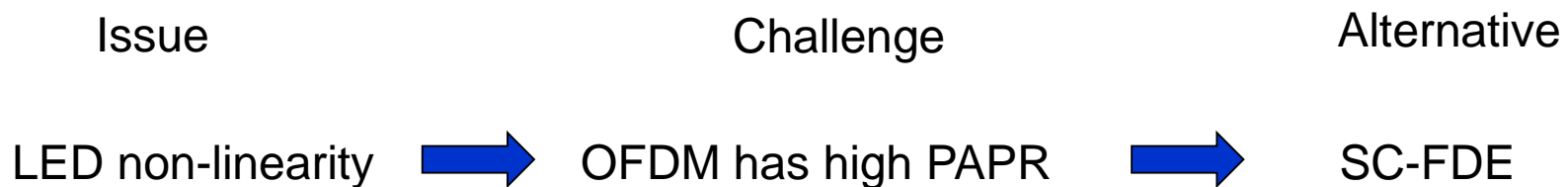

How to efficiently transmit optical OFDM and SC-FDE while sustaining a bit-error performance over a large fraction of the dimming range?

**Existing solutions:**

- Superposition only during the PWM-"on"
- OFDM signal sampling using the PWM
- Average power reduction per OFDM symbol

**Reverse polarity solution:**

- Continuous OFDM transmission

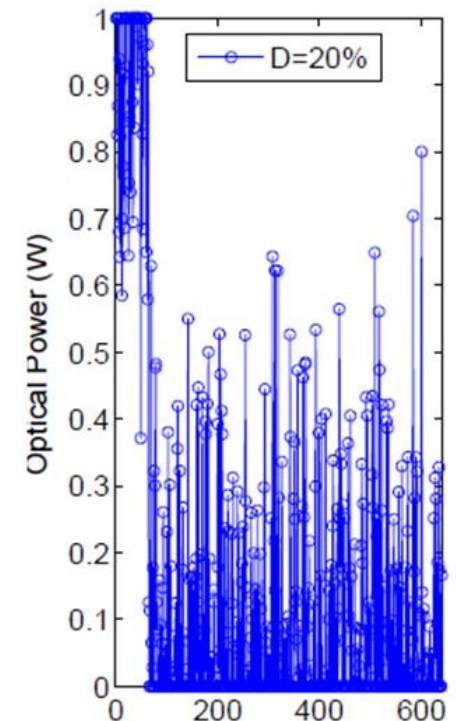
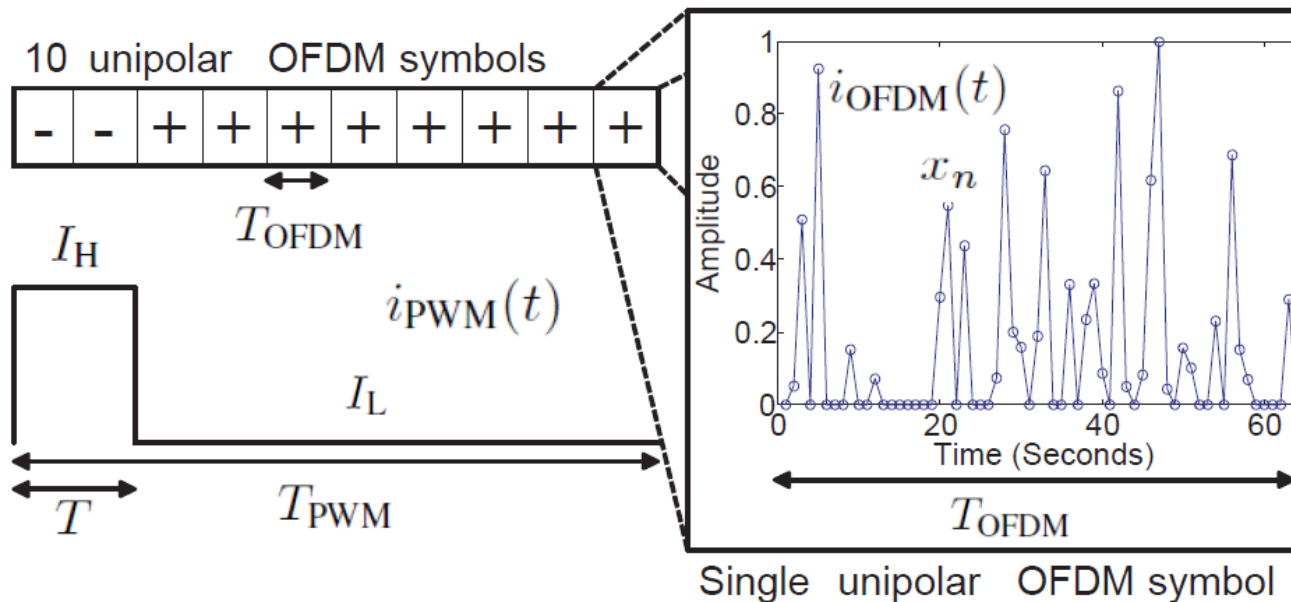
**Example: 20% duty cycle @ 15dBm OFDM average power**

# Reverse polarity modulation simulation results and proof-of-concept setup

March 2015

doc.: IEEE 802.15-15-0112-03-007a

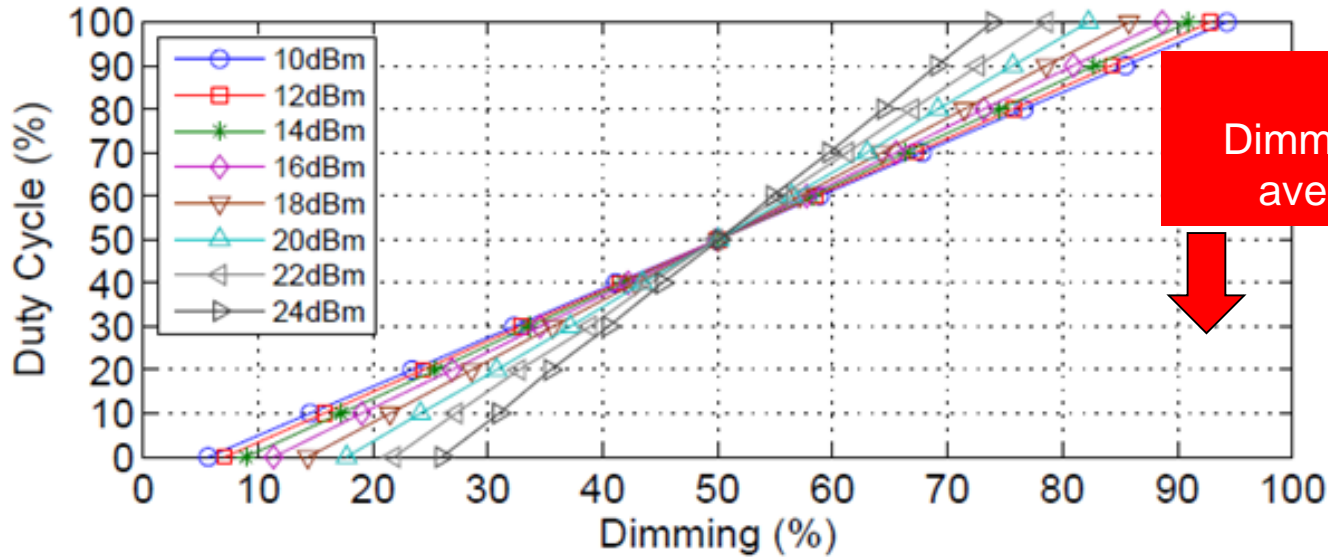

**Simulation**  
Dimming vs. duty cycle; different average OFDM signal power

**Experimental**  
Illuminance/dimming percentage vs. duty cycle; different average OFDM signal power/BER

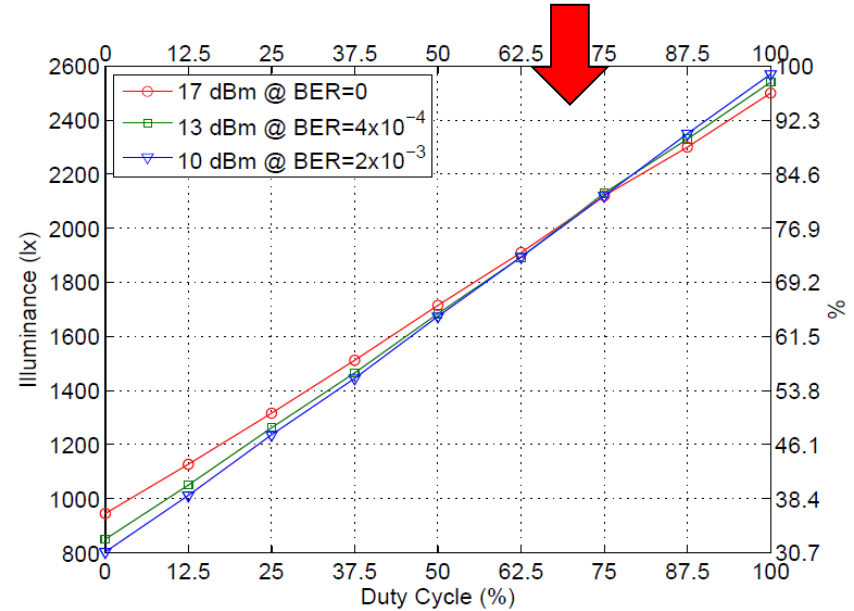
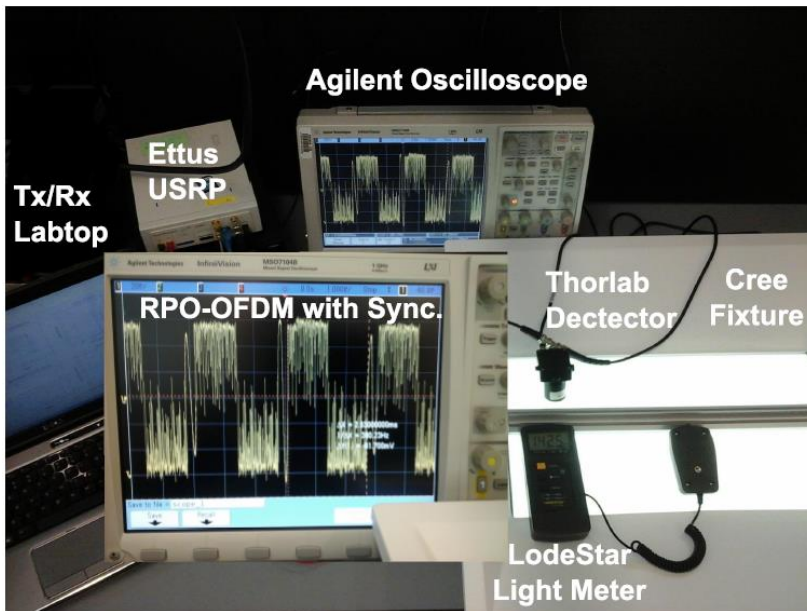

# Conclusion

- Reverse Polarity Modulation:
  - Linear dimming with conventional PWM from lighting industry
  - Performance does not need to be reduced proportional to intensity
  - Bit-error performance is sustained over a large fraction of the dimming range
  - A practical approach; capacity is not limited by the PWM frequency
- Enhanced ACO-OFDM (SEE-OFDM) and Polar Optical Transmitters:
  - Improved spectral efficiency
  - Effective PAPR reduction

## Part 4: LED ID PHY

Seoul National University of  
Science & Technology Contribution

Jaesang Cha

chajs@seoultech.ac.kr





# References and Backup Slides

## Reverse Polarity modulation

- Ali Mirvakili, Rahaim, Michael, Brandon, Valencia J Koomson, Hany Elgala and Thomas D. C. Little, "Wireless Access Test-bed through Visible Light and Dimming Compatible OFDM", the IEEE Wireless Communications and Networking Conference (WCNC 2015), March 09-12, 2015, New Orleans, LA, USA [to appear].
- Hany Elgala and Thomas D. C. Little, "Reverse polarity optical-OFDM (RPO-OFDM): dimming compatible OFDM for gigabit VLC links", OSA Optics Express, Vol. 21, Issue 20, pp. 24288-24299, October 2013.
- Thomas D. C. Little and Hany Elgala, "Adaptation of OFDM under Visible Light Communications and Illumination Constraints", the Asilomar Conference on Signals, Systems, and Computers, November 2-5, 2014, Pacific Grove, California [to appear].

## Enhanced ACO-OFDM (SEE-OFDM)

- H. Elgala and TDC Little, "SEE-OFDM: Spectral and Energy Efficient OFDM for Optical IM/DD Systems", the IEEE International Symposium on Personal, Indoor and Mobile Radio Communications (PIMRC 2014), September 2-5, 2014, Capital Hilton, Washington DC [to appear].

## Polar transmitters (polar OFDM and polar SC-FDE)

- Hany Elgala, Sarah Kate Wilson and Thomas D. C. Little, "Optical polar OFDM: on the effect of time-domain power allocation under power and dynamic-range constraints", the IEEE Wireless Communications and Networking Conference (WCNC 2015), March 09-12, 2015, New Orleans, LA, USA [to appear].
- H. Elgala and TDC Little, "Polar-Based OFDM and SC-FDE Links towards Energy-Efficient Gbps Transmission under IM-DD Optical System Constraints", Journal of Optical Communications and Networking (JOCN), Volume 7, No. 2, 2014.
- H. Elgala and TDC Little, "P-OFDM: Spectrally Efficient Unipolar OFDM", the Optical Fiber Communication Conference and Exposition (OFC 2014), March 9-13, 2014, San Francisco, California.

**Project: IEEE P802.15 Working Group for Wireless Personal Area Networks (WPANs)**

**Submission Title:** [Interference Issue in Visible Light Communications]

**Date Submitted:** [January 23, 2015]

**Source:** [Chen Gong, Qian Gao, and Zhengyuan Xu]  
[University of Science and Technology of China]

Address [443 Huangshan Rd, Hefei, Anhui, China]

Voice:[86-551-63603187], FAX: [86-551-63603995], E-Mail:[{cgong821,qgao, xuzy}@ustc.edu.cn]

**Re:** []

**Abstract:** [The interference issue in visible light communication is presented. Several solutions to either suppress the interference or cancel the interference are discussed.]

**Purpose:** [Contribution to IEEE 802.15.SG7 VLC]

**Notice:** This document has been prepared to assist the IEEE P802.15. It is offered as a basis for discussion and is not binding on the contributing individual(s) or organization(s). The material in this document is subject to change in form and content after further study. The contributor(s) reserve(s) the right to add, amend or withdraw material contained herein.

**Release:** The contributor acknowledges and accepts that this contribution becomes the property of IEEE and may be made publicly available by P802.15.

# VLC with Multiple Transmitting LED

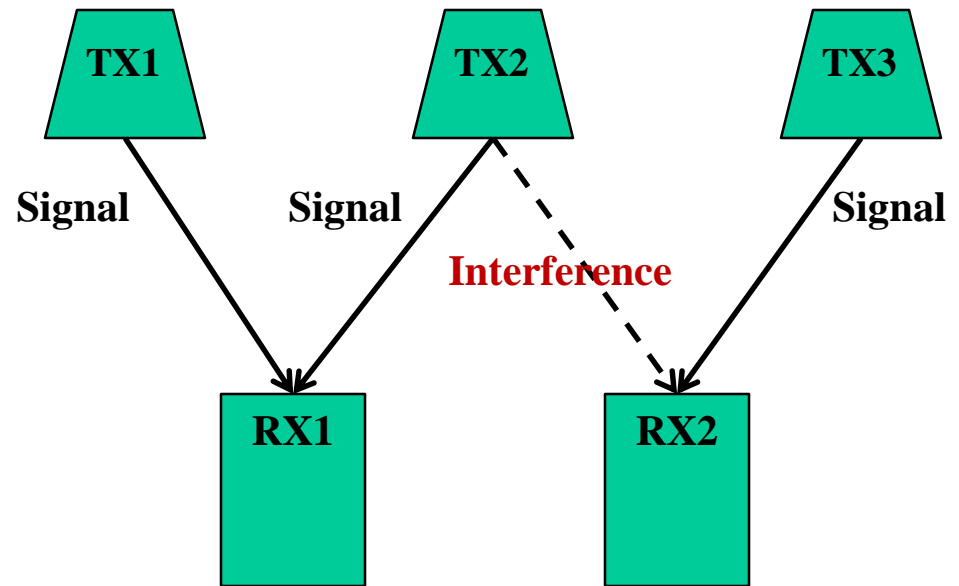
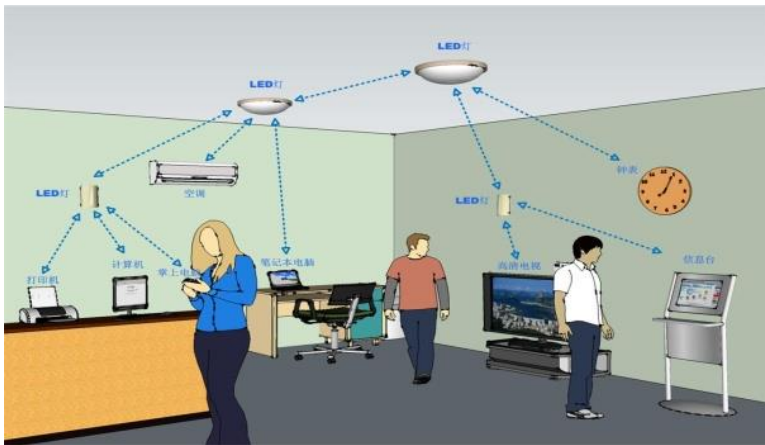

Multi-transmitter multi-receiver indoor visible light communication network

# The Interference Issue

Performance degradation due to the interference:

- ❖ Received signal quality degrades
- ❖ Achievable rate decreases
- ❖ Need to find a solution for the interference management

# Interference Suppression at the Transmitter

Add some blank subframes into the transmission signal frame

-reduce the rate of the interfering user

-alleviate performance degradation due to the interference

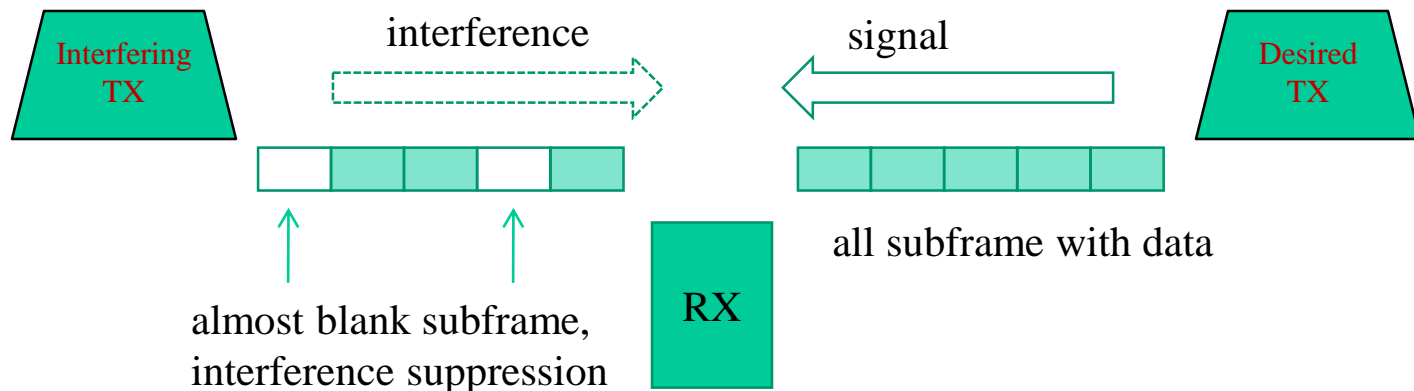

# Layered Transmission with Interference Cancellation

Receiver 3

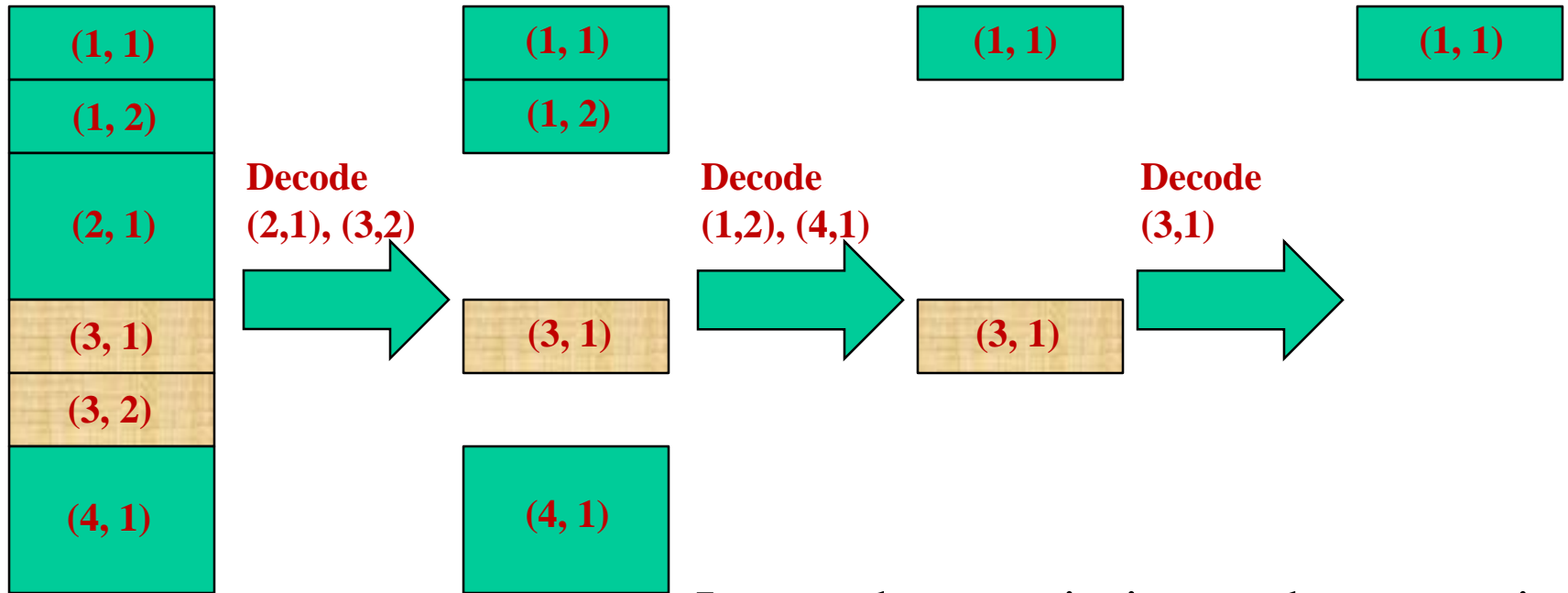

Layered transmission at the transmitter  
 Successive decoding at the receiver



# Conclusion

- Interference due to multi-user visible light communication
- Layer transmission with interference cancellation
  - Frame coordination at the transmitter
  - Interference suppression by successive decoding at the receiver

**Project: IEEE P802.15 Working Group for Wireless Personal Area Networks (WPANs)**

**Submission Title:** [Very High Dimensional Constellation Design for Multi-color VLC]

**Date Submitted:** [January 23, 2015]

**Source:** [Qian Gao, Chen Gong and Zhengyuan Xu]

[University of Science and Technology of China (USTC)]

Address [443 Huangshan Rd, Hefei, Anhui, China]

Voice:[86-63603995], E-Mail:[{qgao, cgong, xuzy}@ustc.edu.cn]

**Re:** []

**Abstract:** [A joint color-frequency modulation scheme is proposed. It utilizes multi-color optical channels to transmit data in color and frequency in parallel, in order to maximize energy efficiency.]

**Purpose:** [Adding another PHY to 15.7r1]

**Notice:** This document has been prepared to assist the IEEE P802.15. It is offered as a basis for discussion and is not binding on the contributing individual(s) or organization(s). The material in this document is subject to change in form and content after further study. The contributor(s) reserve(s) the right to add, amend or withdraw material contained herein.

**Release:** The contributor acknowledges and accepts that this contribution becomes the property of IEEE and may be made publicly available by P802.15.

# Multi-color Visible Light Communication (MC-VLC)

(A Natural Step Towards Exploiting Full VL Band)

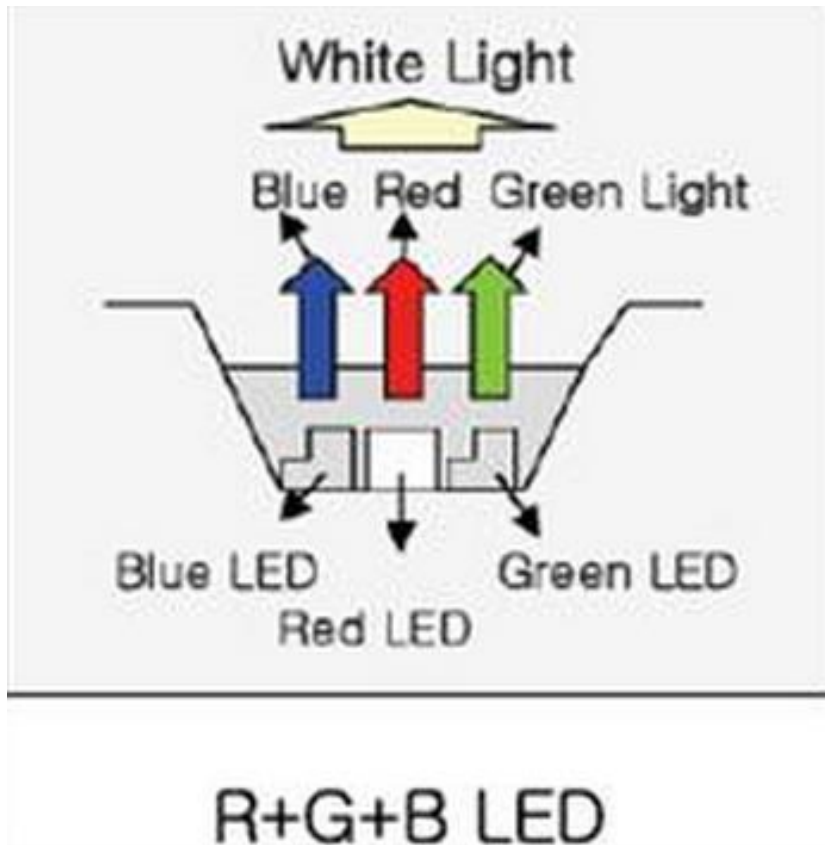

- ❖ With single color LEDs, due to IM/DD, only a small portion of the VL band is utilized, the bandwidth equals that of the RF baseband equivalent;
- ❖ However, all-optical VLC is expensive, manufacture of optical oscillators is not mature;
- ❖ Multi-color VLC, with RGB LEDs, or with  $> 3$  color LEDs are necessary.



# Big Data Needs Fast Server

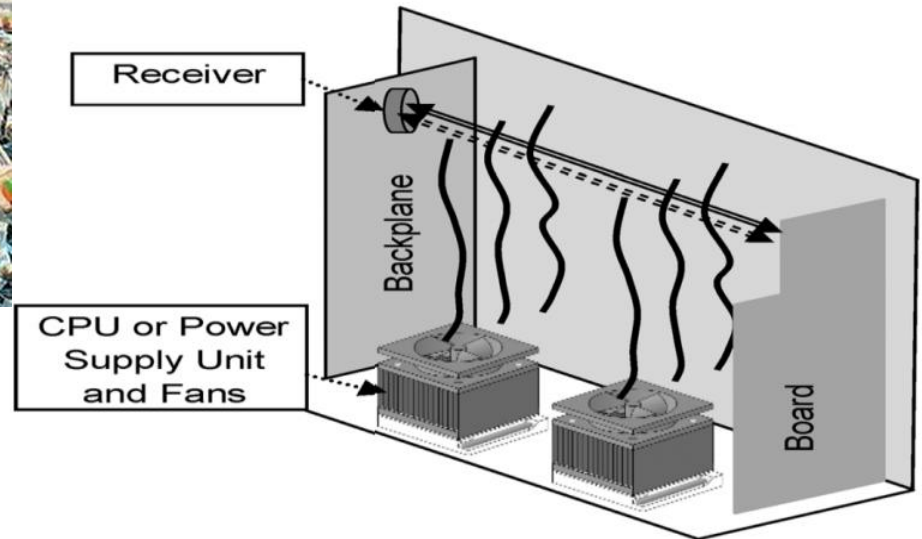

# Fast Server Needs Ultra-wide Band

Fig. in [1]. FSO bus for board-to-backplane interconnections in the presence of air turbulence.

[1]. R. Rachmaci and S. Arnon, ``\_Server backplane with optical wavelength diversity links'', \_IEEE/OSA Journal of Lightwave Technology, Vol. 30, no. 9, pp. 1359 – 1365, May 2012.

# Challenges of MC-VLC

Some challenges for modulation of MC-VLC System:

- ❖ Energy-efficiency Maximizing Modulation Schemes:
  - ❖ It's not optimal to apply, e.g. OFDM for each color channel;
  - ❖ Color-shift Keying (CSK), requiring constant instantaneous sum intensity, is not optimal either;
- ❖ Channel specific modulation design or coding, e.g. air turbulence exists between the baud-to-backplane interconnections.

- ❖ What would Shannon suggest?
- ❖ Rethink about compactness of sphere packing in high dimension space (dimension=number of color channels used).

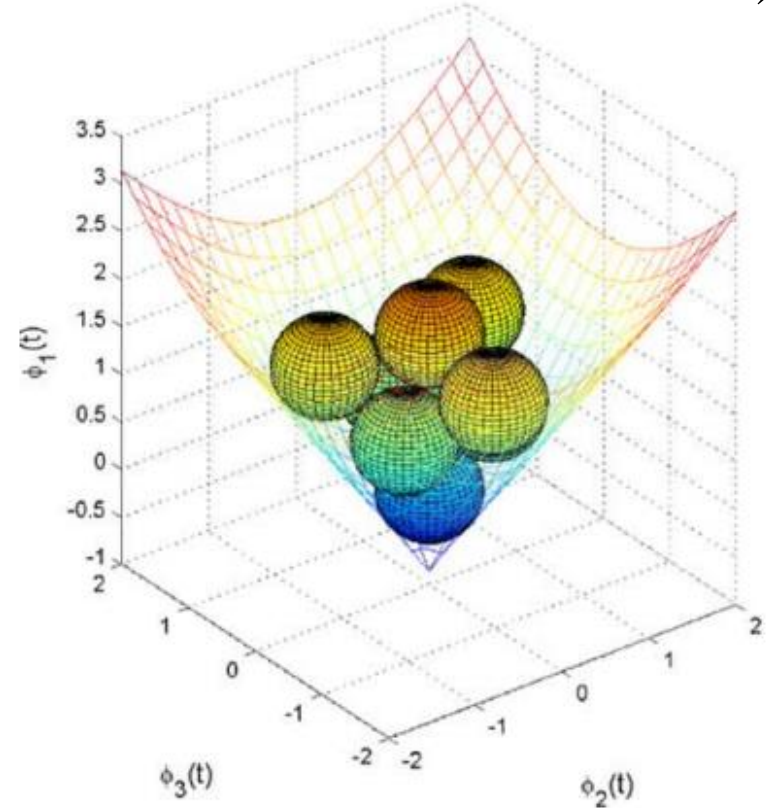
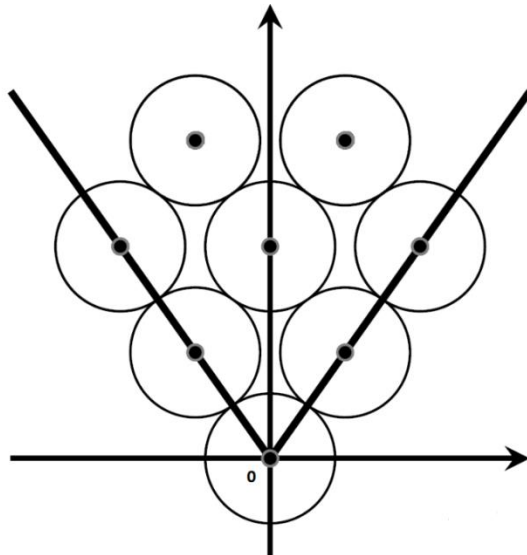
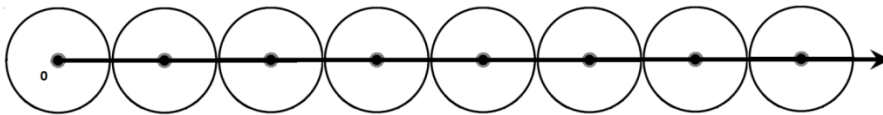

[2]. J. Karout, E. Agrell, K. Szczerba, and M. Karlsson, "Optimizing constellations for single-subcarrier intensity modulated optical systems," *IEEE Trans. Inf. Theory*, vol. 58, no. 7, pp. 4645–4659, July 2012.

## Design in a even higher dimensional space:

- ❖ Larger energy gain is expected;
- ❖ Hybrid the CSK and OFDM, towards a joint color-frequency modulation (JCFM);
- ❖ Generalize the CSK by relaxing the constant instantaneous sum intensity constraint, replaced by a fixed time average intensity constraint for each color channel;
- ❖ Challenge: complexity may increase significantly.

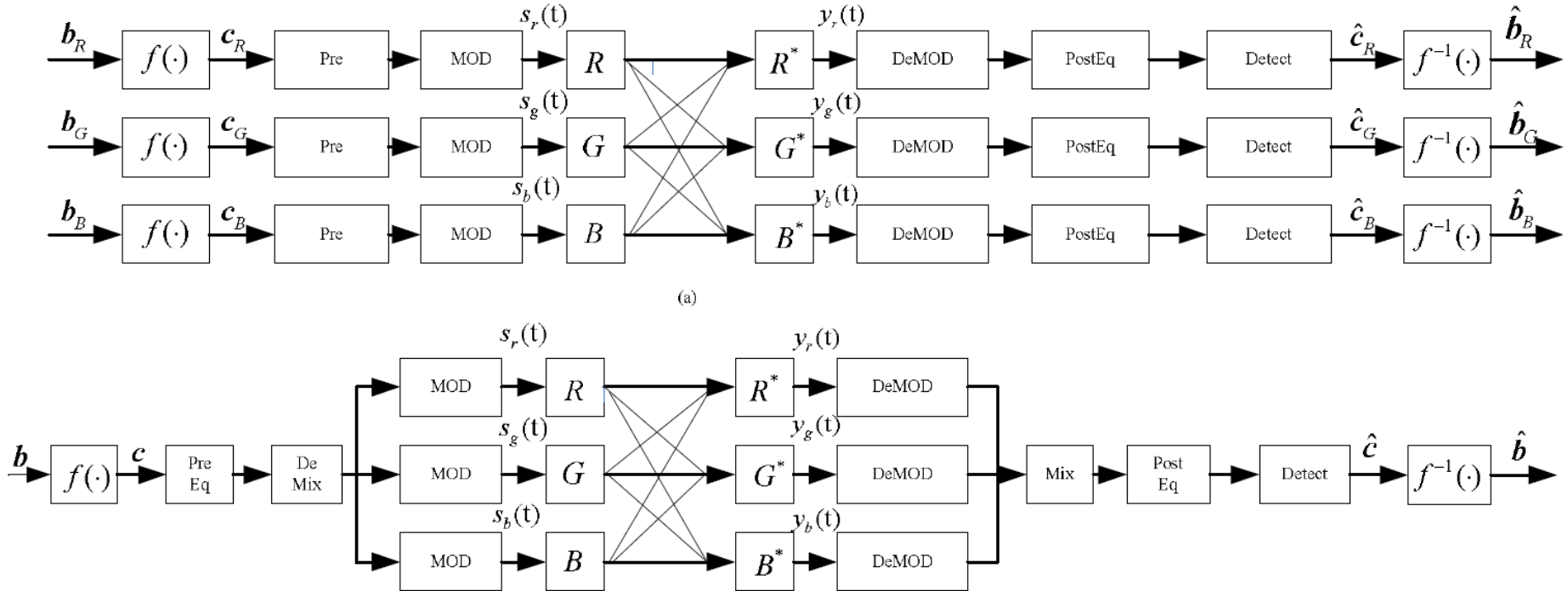

Fig.ure. Block diagram of Optical JCFM scheme, aiming at maximizing energy-efficiency.



# Conclusion

- ❖ Multi-color VLC is suitable for board-to-backplane transmission with a big data server;
- ❖ Considering energy-efficiency, traditional OFDM or CSK schemes are not optimal;
- ❖ Frequency and color diversities are utilized jointly, and very high dimensional constellation can be designed to maximize energy-efficiency;
- ❖ Performance study on the new modulation scheme with air turbulence channel is necessary.