

November 2013

doc.: IEEE 802.15-13-0636-01-0thz_Wireless_Backhauling_Fronthauling

Project: IEEE P802.15 Working Group for Wireless Personal Area Networks (WPANs)

Submission Title: Requirements on Wireless Backhauling and Fronthauling

Date Submitted: 11 November 2013

Source: Thomas Kürner Company TU Braunschweig

Address Schleinitzstr. 22, D-38092 Braunschweig, Germany

Voice:+495313912416, FAX: +495313915192, E-Mail: t.kuerner@tu-bs.de

Re: n/a

Abstract: Wireless backhauling/fronthauling is one of the potential applications for a standard on 100G. In this contribution the terms wireless backhauling and fronthauling are explained and requirements coming from recent developments in cellular networks are explained.

Purpose: Information of IEEE 802.15 SG 100G

Notice: This document has been prepared to assist the IEEE P802.15. It is offered as a basis for discussion and is not binding on the contributing individual(s) or organization(s). The material in this document is subject to change in form and content after further study. The contributor(s) reserve(s) the right to add, amend or withdraw material contained herein.

Release: The contributor acknowledges and accepts that this contribution becomes the property of IEEE and may be made publicly available by P802.15.

Requirements on Wireless Backhauling/Fronthauling

Thomas Kürner

TU Braunschweig

Introduction

- Wireless backhauling/fronthauling is one of the potential applications for a standard on *100G (100 Gbit/s over beam switchable wireless point-to-point links)*
- In the following the terms wireless backhauling and fronthauling are explained and requirements coming from recent developments in cellular networks are explained.

(Simplified) Architecture of Cellular Networks (1/3)

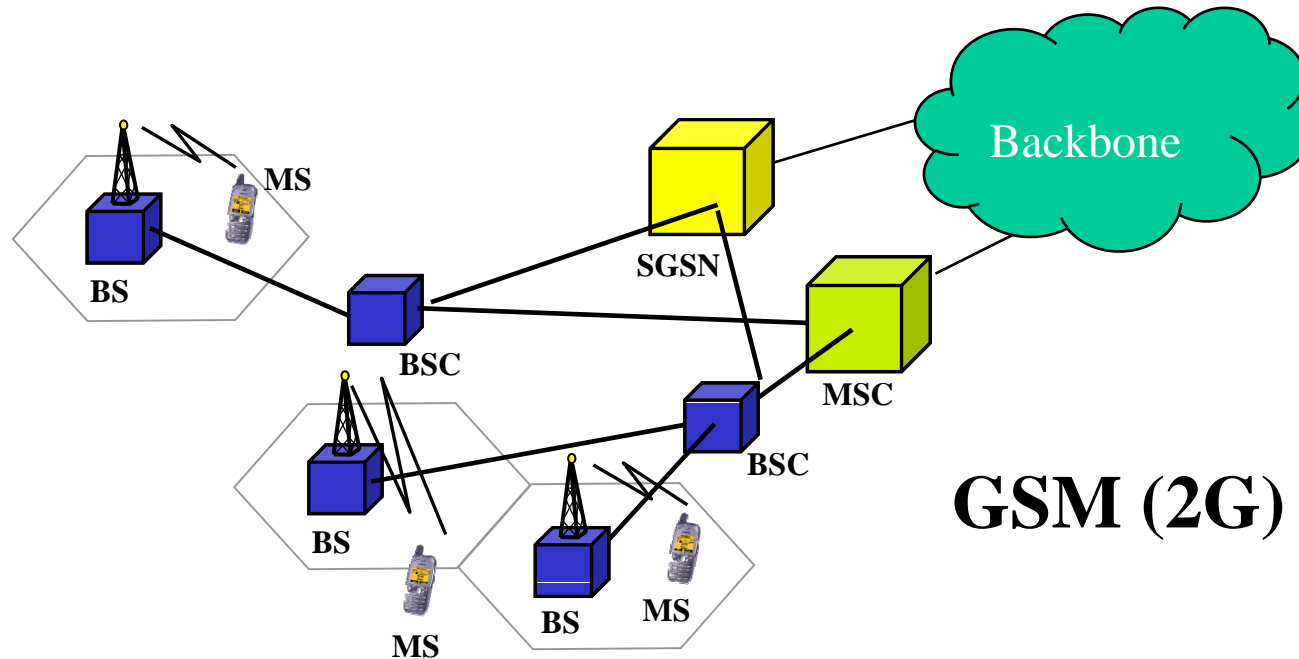

(Simplified) Architecture of Cellular Networks (2/3)

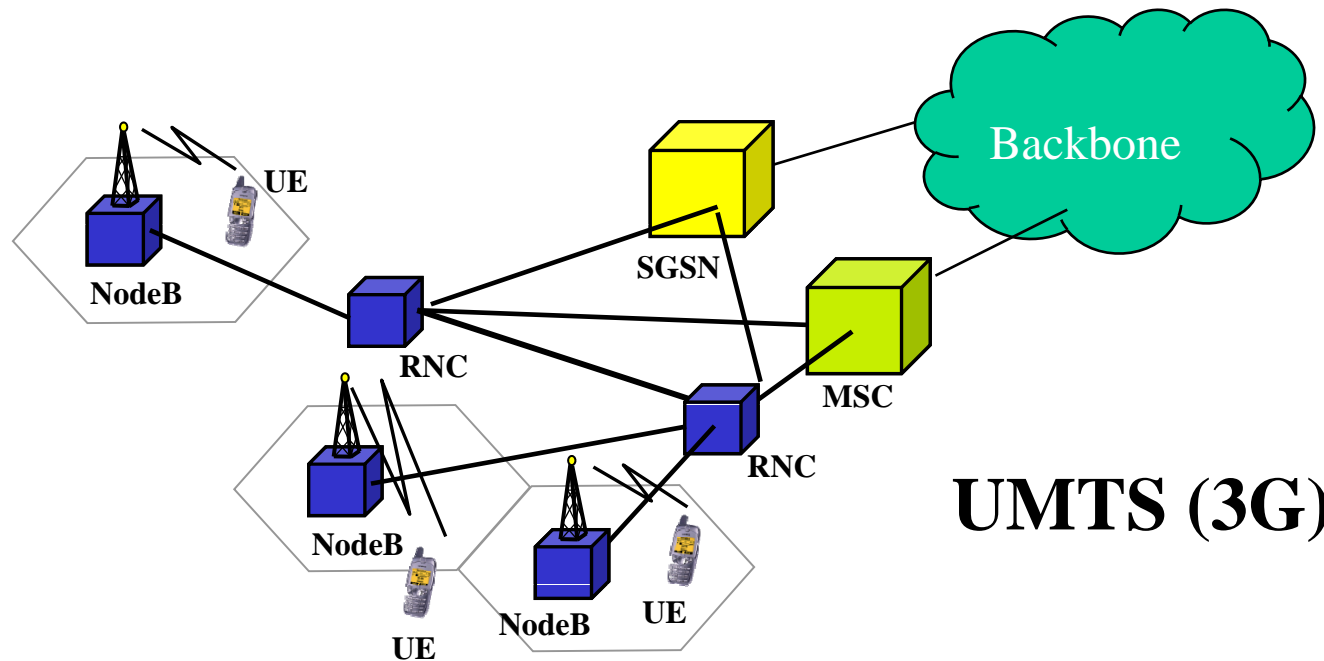

(Simplified) Architecture of Cellular Networks (3/3)

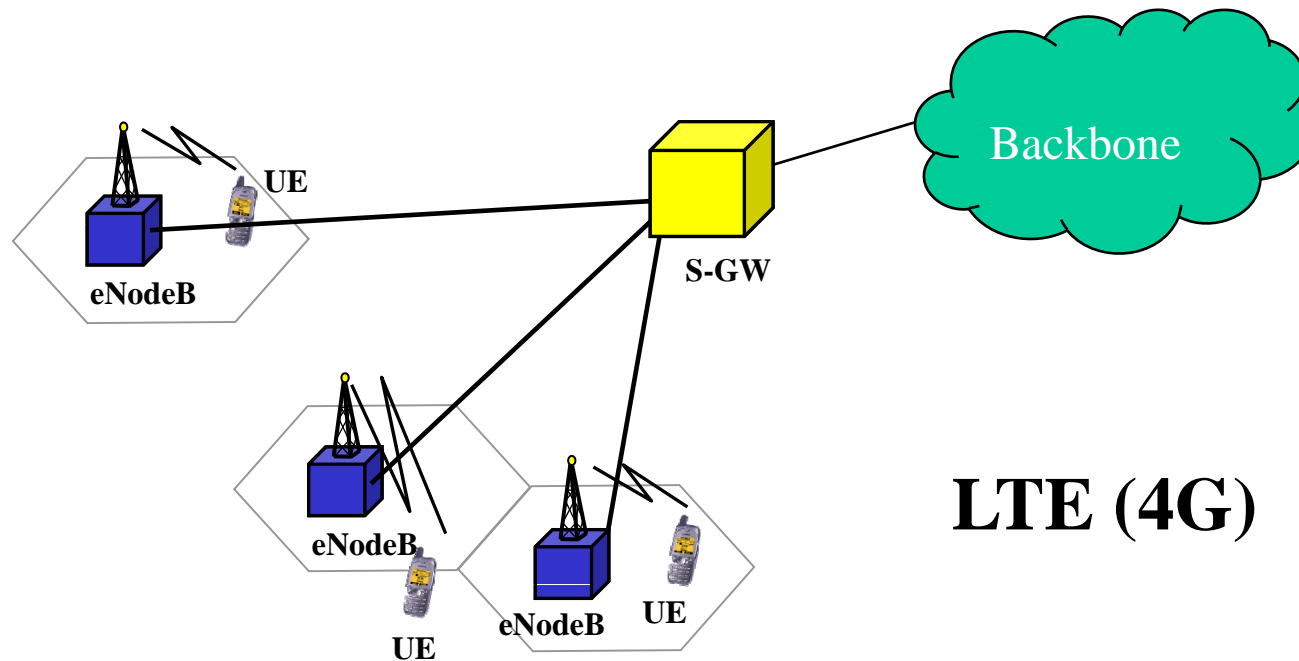

In the following slides the LTE architecture is displayed only

Backhaul Links

- A backhaul link is a connection between the base station and a more centralized network element

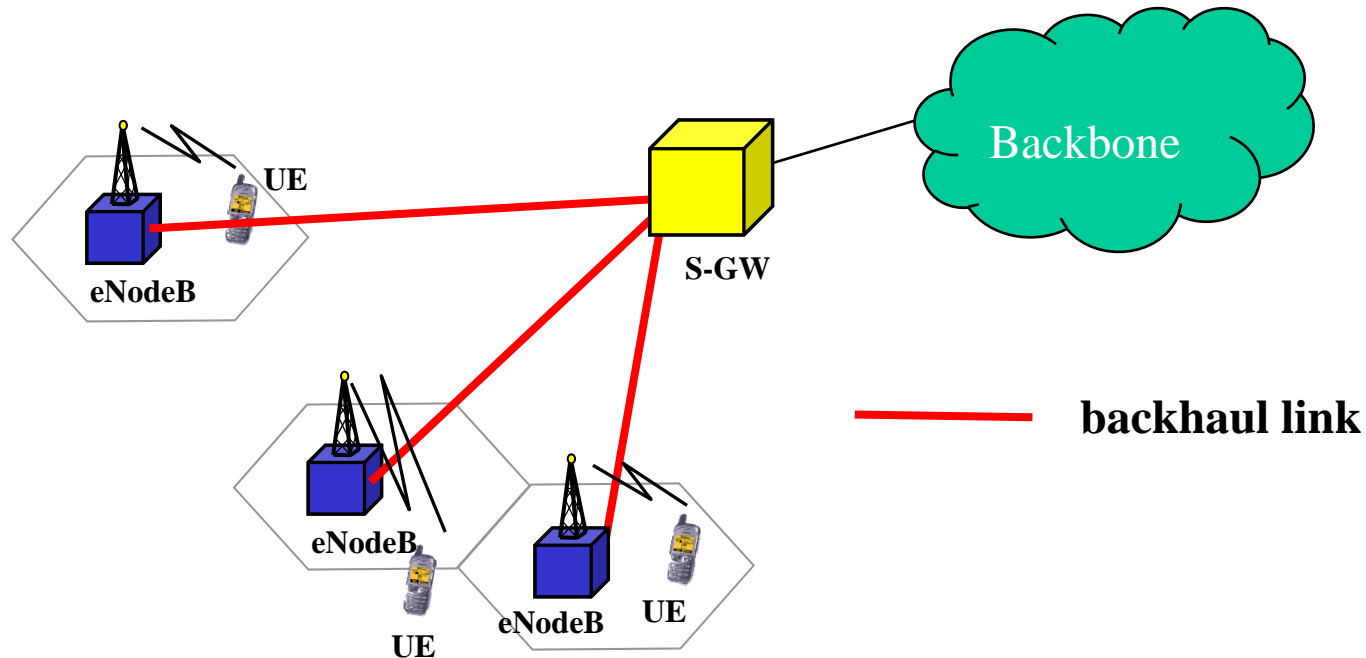

Fronthaul Links

- The fronthaul link is the link between the base station and the remote radio head

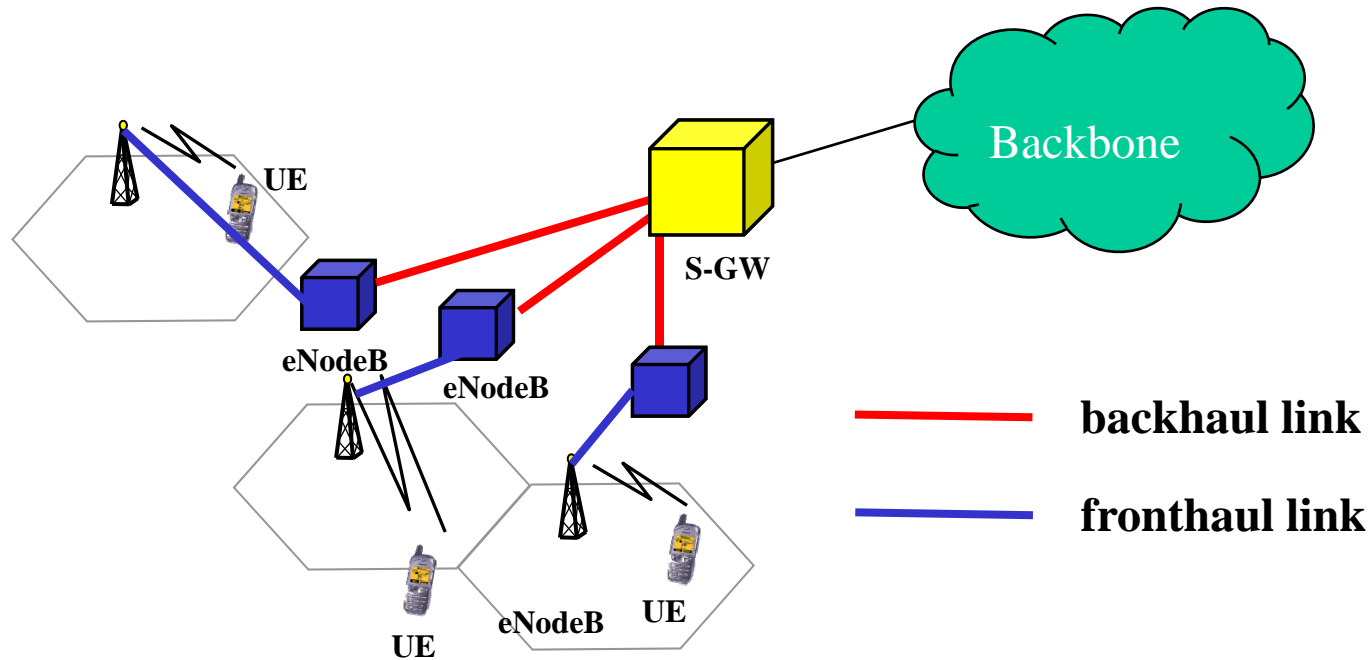

Increase of Traffic in Cellular Networks

- In the near future an enormous increase of mobile data volumes are predicted, e. g. traffic increase by a factor of 25 by 2016 [5]
- Network operators have to increase the capacity of the networks
- Since the income does not increase in the same way the cost per bit has to be reduced at the same time
- More cost efficient and easy-to-deploy solutions are required.

Technical Trends in Cellular Networks to increase the Capacity

- A couple of new techniques are developed in cellular networks
- Some of them require additional backhaul or fronthaul links
- In the following slides three examples are discussed
 - Deployment of Small Cells
 - Cooperative multi-point transmission (CoMP)
 - Centralized radio access networks (C-RAN)

Massive Deployment of Small Cells

- If cell sizes are getting smaller the capacity per area increases.
- Deployment of small cells with coverage areas similar to those of WLAN APs require a large number of backhaul links
- Possibly aggregated high-capacity backhaul links will be used (e.g. backhauling all small cells from a large multi-storey building)

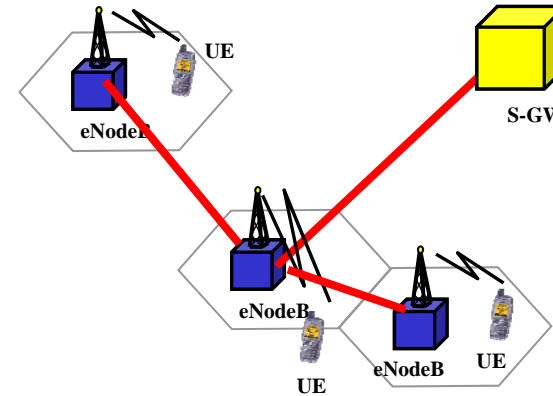

**Aggregation of
backhaul links**

Cooperative Multipoint Transmission

- Tight coordination of transmitted signals by several base stations will reduce interference
- By reducing interference capacity can be increased
- Each base station requires information about about transmission of all other base stations received within a cell
- Requirement for high backhaul capacity currently restricts deployment of CoMP

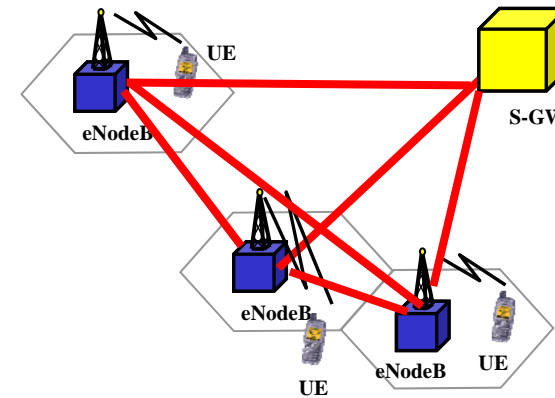

**Backhauling
between base
stations**

C-RAN

- C-RAN centralises the base band part of all base stations at a centralized place
- Coordination among base stations becomes easier
- C-RAN could be an enabler for more intensive use of CoMP
- Additional fronthaul links will be required.

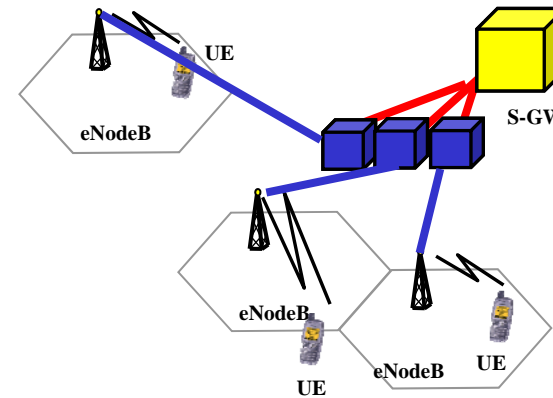

Additional fronthaul links required

Trends in Backhauling Technologies

- There is a trend that IP/Ethernet gets more importance as a transport technology for backhauling in mobile networks [1,2,3]
- Currently fiber is used as the physical medium
- Sometimes microwave links are used as an alternative, if fiber is not available.
- Backhaul Networking flexibility is critical to successful deployments [1]
- This situation offers opportunities for the application of wireless 100 Gbps links.

Specific Requirements on Fronthauling Links [4]

- Fronthauling links use the CPRI (Common Public Radio Interface)
- This protocol is extremely latency sensitive
- Signal synchronisation has to be transferred transparently.
- These requirements may be a challenge for wireless 100 Gbps links.

References

- [1] Alcatel Lucent Application Note; A New Era of Mobile Backhaul;
<http://resources.alcatel-lucent.com/?cid=163517>
- [2] <http://www.ericsson.com/ourportfolio/telecom-operators/mobile-backhaul>
- [3] Transmode Application Note; Ethernet mobile backhaul delivers new services with higher performance and lower costs;
<http://www.transmode.com/en/resource/application-notes?task=document.download&id=15>
- [4] Transmode Application Note; Mobile Fronthaul;
<http://www.transmode.com/en/resource/application-notes?task=document.download&id=901>.
- [5] Alcatel Lucent Application Note; IP/MPLS Mobile Backhauls for Heterogenous Networks; <http://resources.alcatel-lucent.com/?cid=162070>

Technical Expectations Document (TED)

All information contained in this presentation is meant to be included in the technical expectations document 15-11-0745-10-0thz-thz-ig-technical-expectations-document-ted.doc.