

Project: IEEE P802.15 Working Group for Wireless Personal Area Networks (WPANs)

Submission Title: [Final Proposals for IEEE802.15.8]

Date Submitted: [7 July 2012]

Source: [Qing Li, Chonggang Wang, Hongkun Li, Paul Russell Jr.]

Company [InterDigital Communications Corporation]

Address [781 Third Avenue, King of Prussia, PA 19406-1409, USA]

Voice:[610-878-5695], FAX: [610-878-7885], E-Mail:[Qing.Li@InterDigital.com]

Re: []

Abstract: [This document presents final proposals on the PHY/MAC system design for 802.15.8 (PAC)]

Purpose: [To discuss technical feasibility of proposed system design for 802.15.8 (PAC)]

Notice: This document has been prepared to assist the IEEE P802.15. It is offered as a basis for discussion and is not binding on the contributing individual(s) or organization(s). The material in this document is subject to change in form and content after further study. The contributor(s) reserve(s) the right to add, amend or withdraw material contained herein.

Release: The contributor acknowledges and accepts that this contribution becomes the property of IEEE and may be made publicly available by P802.15.

Content

1. PAC Overview
2. A PAC System
3. Frame Structure
4. Context Management
5. Context-aware Fast Discovery Procedures
6. Context-aware Fast Association Procedures
7. Context-aware Synchronization Procedures
8. Context-aware Channel Management Procedures
9. Context-aware Reliable Multicast Transmission Procedures
10. Context-aware Power Control Procedures
11. Cross Layer and Cross Application ACK
12. Conclusion
13. References
14. Backup Slides

1. PAC Overview

1. PAC Overview

PAC Scope

- This standard defines PHY and MAC mechanism for Wireless Personal Area Networks (WPAN) Peer Aware Communications (PAC) optimized for peer to peer and infrastructure-less communications with fully distributed coordination.
- PAC features include: discovery for peer information without association, discovery signaling rate typically greater than 100 kbps, discovery of the number of devices in the network, scalable data transmission rates, typically up to 10 Mbps, group communications with simultaneous membership in multiple groups, typically up to 10, relative positioning, multi-hop relay, security, and operational in selected globally available unlicensed/licensed bands below 11 GHz capable of supporting these requirements.

1.1 Peer Aware Communication

PAC

- A PAC or Peer-to-Peer Network (P2PNW) is formed for a desired service/application within proximity.
- Infrastructure-less and distributed communications among peers within proximity.
- One peer can participate in multiple services or applications, i.e. multiple P2PNWs.
- Group communication and multi-hop are supported.
- Many P2PNWs coexist in proximity.

1.2 PAC Networks in Proximity

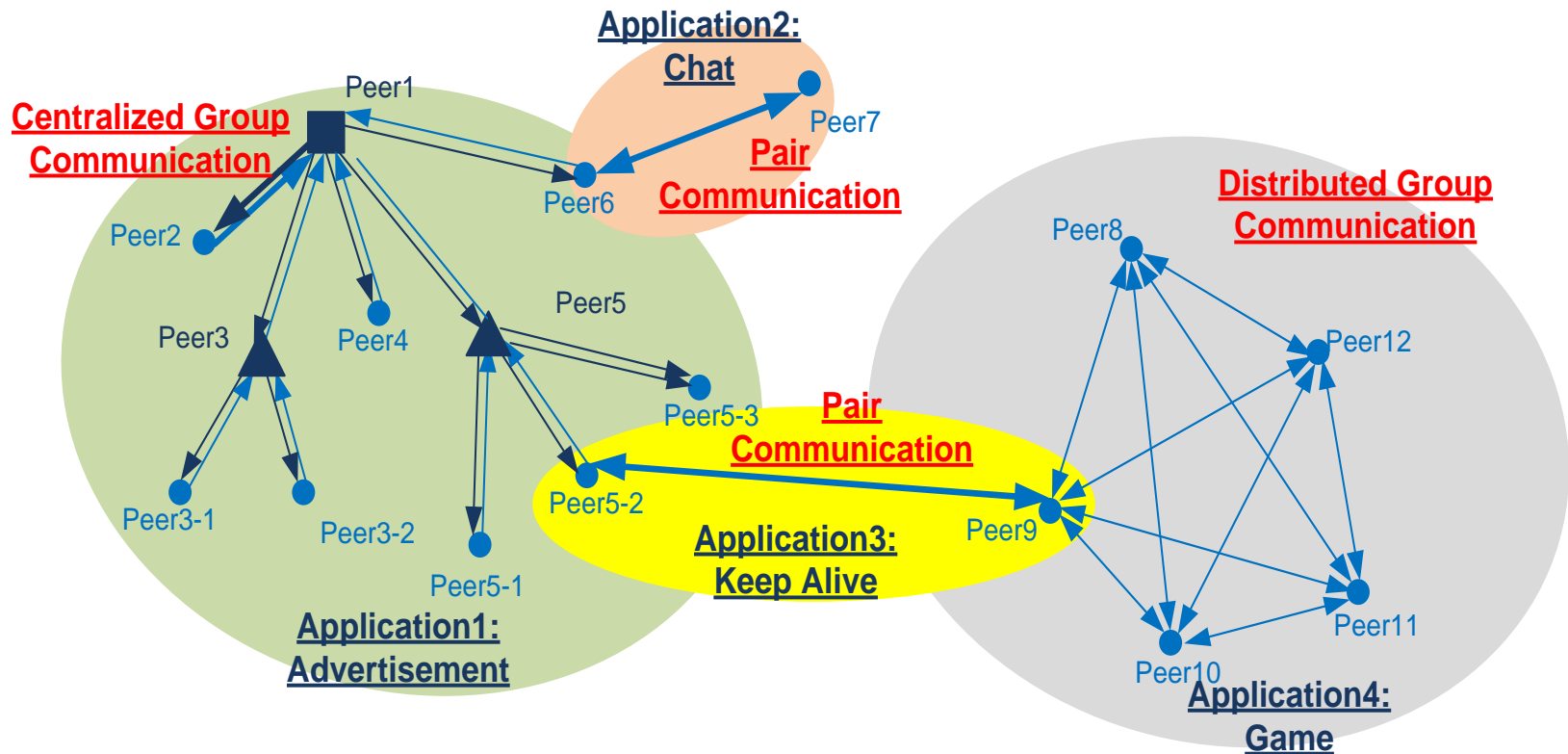

→ Context-Aware Peer-to-Peer Communications

2. A PAC System

2. A PAC System

- Excerpts from IEEE 802.15.8 TGD [1]
 - 6.17 Requirements for high layer and infrastructure interaction: “*IEEE 802.15.8 may be able to interact with higher layers to access suitable infrastructure, if it exists, e.g. to facilitate the set up and maintenance of communication*”, “*IEEE 802.15.8 shall perform measurements at the request of and report the results to higher layers. These measurements may include received signal strength and interference levels*”
 - 7.7 System overhead: “*Overhead, including overhead for control signaling as well as overhead related to data communications shall be reduced as far as feasible without compromising overall performance and ensuring proper support of systems features*”
- Motivation: **Context-aware PAC**
 - 1) Each individual P2P network is context-driven.
 - 2) Context is needed to support multi-applications, i.e. switching between P2PNWs.
- Proposals
 - 2.1 Terms and Concepts
 - 2.2 PAC Challenges
 - 2.3 Control Schemes
 - 2.4 Block Diagram of PAC System Architecture
 - 2.5 State Machine of PAC System Operations
 - 2.6 PAC System Procedures

2.1 Terms and Concepts--Peers in PAC

Virtual Leader (VL):

- A peer defined to represent, manage, and coordinate the P2P communications among a group of peers sharing the same context-based service/application, or intra-P2PNW communications.
- A VL may be dynamically determined and/or changed within the P2PNW.
- One VL for one application; one application can have only one VL.
- The peer initiates a P2P communication or P2PNW is the default VL until a new VL is selected within the P2PNW.

Super Virtual Leader (SuperVL):

- A peer defined to coordinate with all VLs, or inter-P2PNW communications in proximity.
- A super virtual leader may be dynamically determined and/or changed among the virtual leaders.
- The super virtual leader is the top leader of the VLs' hierarchical structure. Only one SuperVL in the proximity.
- The peer initiated the first P2P communication or P2PNW is the default SuperVL until a new SuperVL is selected in the proximity.

Sub-Virtual Leader (SubVL):

- A peer defined to extend coverage through multi-hop. A SubVL is a VL for the subgroup peers under; a peer under the VL or a SubVL.
- The SubVL may have a subset of VL's function.

2.2 PAC Challenges

- Infrastructure-less: no central controller or coordinator.
 - Service driven: the P2P networks are formed and ceased very dynamically based on the desired services.
 - Vast range of use cases: low data rate & low duty cycle, such as the keep alive for social networking; high data rate & long duty cycle, such as gaming.
 - Most end-to-end devices are battery constrained: both end devices may need battery saving mode, i.e. the device won't be there checking or listening all the time.
- ➔ There is no one-fit-all solution. Need multiple control or management approaches are needed to cover all the use cases.

2.3 PAC Control Schemes

1. Fully distributed control
2. Hybrid control
3. Virtually centralized control

2.3.1 Fully Distributed Control Scheme

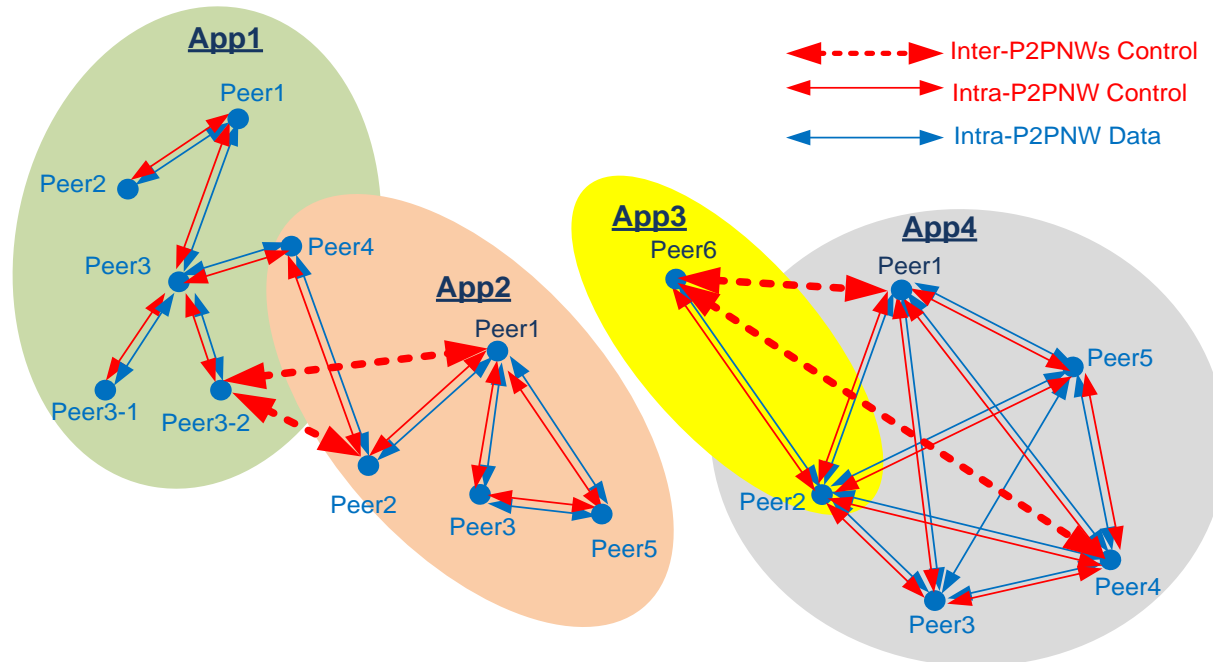

- **Inter-P2PNWs:** distributed control among peers in proximity.
- **Intra-P2PNW:** distributed control among peers within a P2PNW.
- **Typical Scenario:** low density of peers with a few P2P services in proximity, e.g. rural area. For example, P2P communications among the searching or exploring teammates.

2.3.2 Hybrid Control Scheme

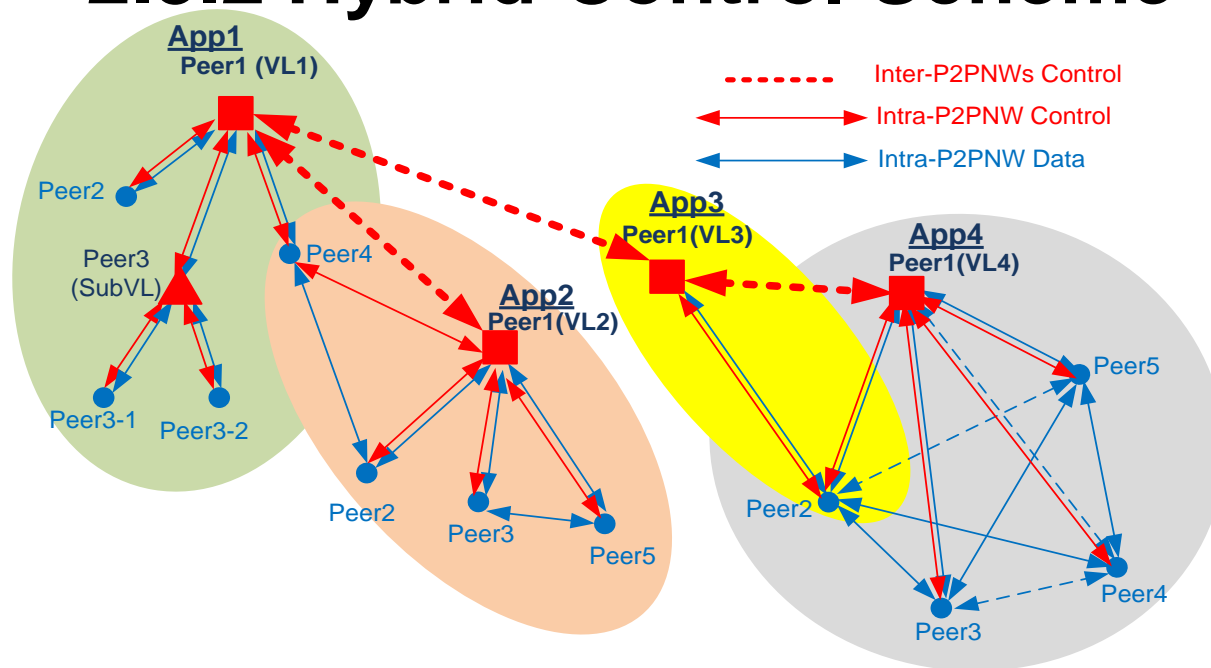

- **Inter-P2PNWs:** distributed control among VLs or P2PNWs in proximity.
- **Intra-P2PNW:** virtually centralized control by VL within a P2PNW, i.e. self organized within a P2PNW.
- **Typical Scenario:** medium density of peers with some P2P services in proximity, e.g. smart office or smart home. For example, P2P conference and P2P brainstorming sessions in the office area.

2.3.3 Virtually Centralized Control Scheme

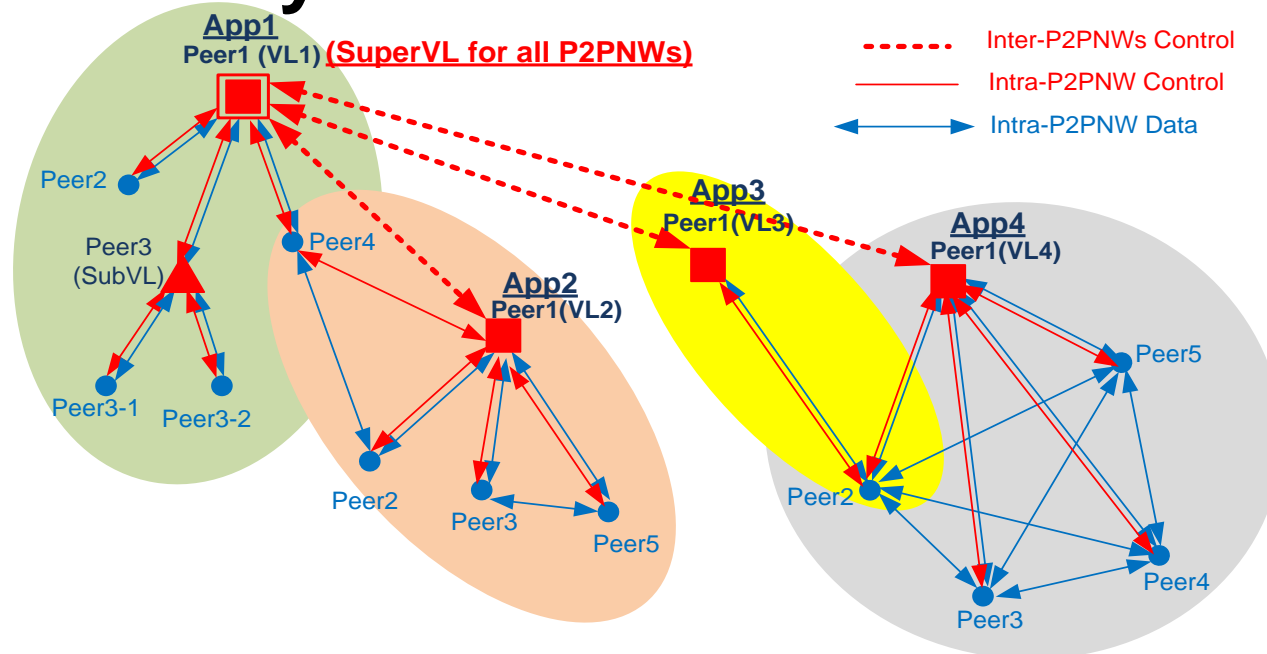

- **Inter-P2PNWs:** virtually centralized control by SuperVL among P2PNWs, i.e. loosely or virtually organized among P2PNWs.
- **Intra-P2PNW:** virtually centralized control by VL within a P2PNW, i.e. self organized with a P2PNW.
- **Typical Scenario:** high density of peers with variety of P2P services, e.g. shopping mall, amusement park, sport arena, etc. For example, a department store's advertisement "Peer" at a shopping mall can be a SuperVL virtually coordinating and managing all the P2P communications in the proximity.

2.6 PAC System Procedures

1. Initiation of PAC Communication
2. Association (Peering) Operations with Idle and Sleep Mode
3. Multi-application Data Transmitting

3. Frame Structure

3. Frame Structure

- Requirement in 802.15.8 TGD:
 - 4.1 Concepts and architecture: IEEE 802.15.8 shall support one-to-one and one-to-many communications. IEEE 802.15.8 shall support scalable data rate to accommodate many applications
 - 5.2 Common communication mode: Common mode (e.g., for discovery and communication) shall be supported for interoperability.
 - 6.16 Coexistence: IEEE 802.15.8 shall support the coexistence of PDs used for different applications.
- Motivation:
 - Current frame structure in 802 standard does not support application-based P2PNW
 - Context information is used to form P2PNW, but is not specified in any existing IEEE 802.15 or 802.11 MAC frame
 - The new features required by PAC, such as fast discovery without association, are not well supported by existing MAC frames defined in 802.15 and/or 802.11.
- Proposal:
 - 3.1 Terms and Concepts
 - 3.2 Superframe Structure
 - 3.3 General MAC Frame Format
 - 3.4 Beacon Frame

3.1 Terms and Concepts

1. CCDCH (Common Control and Data Channel)
2. DCDCH (Dedicated Control and Data Channel)
3. Application Frame

3.1.1 Terms and Concepts – Common Channel

- **CCDCH** (Common Control and Data Channel) is defined for inter-P2PNWs communications and shared by all services or applications or P2PNWs in proximity.
 - Common general control messages for all P2PNWs in proximity, such as inter-P2PNWs channel management and power control messages.
 - Paging or broadcast control/management messages for all P2PNWs in proximity, such as discovery and/or association messages.
 - Short high priority data transmissions to all P2PNWs in proximity, such as emergency messages.

3.1.2 Terms and Concepts – Dedicated Channel

- **DCDCH** (Dedicated Control and Data Channel) is defined for **intra-P2PNW** communications and shared by peers within a service or application, i.e. a P2PNW.
 - Common general control messages for all peers within a P2PNW, such as intra-P2PNWs channel management and power control messages.
 - Paging or broadcast control/management messages for a P2PNW, such as association messages.
 - Short high priority data transmissions within a P2PNW, such as emergency messages.

3.1.3 Terms and Concepts – Application Frame

- **Application Frame** is a period of time within a superframe granted to a specific application.
 - The allocation of application frame is negotiated on CCDCH among P2PNWs.
 - A superframe may include multiple Application Frames for the corresponding services in the proximity .
 - Each Application Frame starts with an Application Beacon, and includes:
 - DCDCH
 - Contention free period

3.2 Superframe Structure

1. Conventional Super Frame Structure
2. Superframe Structure (TDMA): Virtually Centralized Control
3. Super Frame Structure (TDMA): Hybrid Control
4. Superframe Structure (TDMA): Fully Distributed Control
5. Super Frame Structure (OFDMA)
6. Super Frame Structure (CDMA/DSSS)

3.2.1 Conventional Super Frame Structure

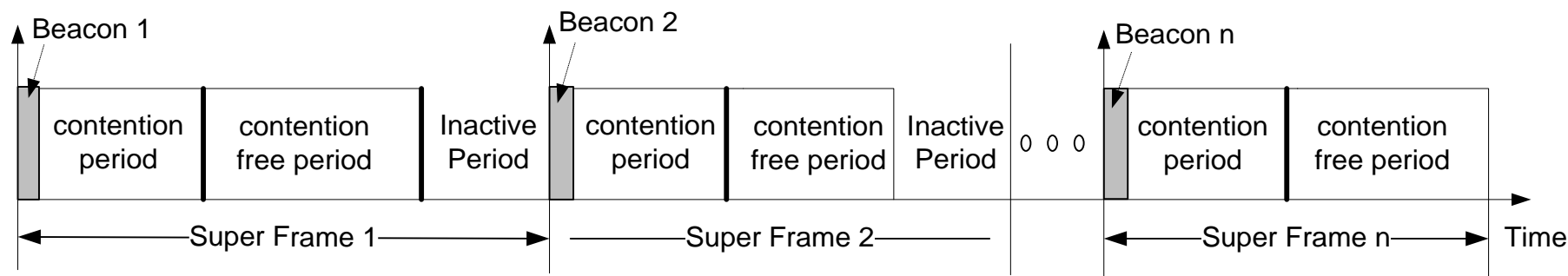

- Pros:
 - Reuse of existing technology (i.e. 802.15.4).
- Cons:
 - Contention overhead grows significantly with increment of number of PDs, i.e. channel utilization is very low.
 - Not application aware.
 - No coordination among applications, not efficient for application-based P2PNW.

3.2.2 Superframe Structure (TDMA): Virtually Centralized Control

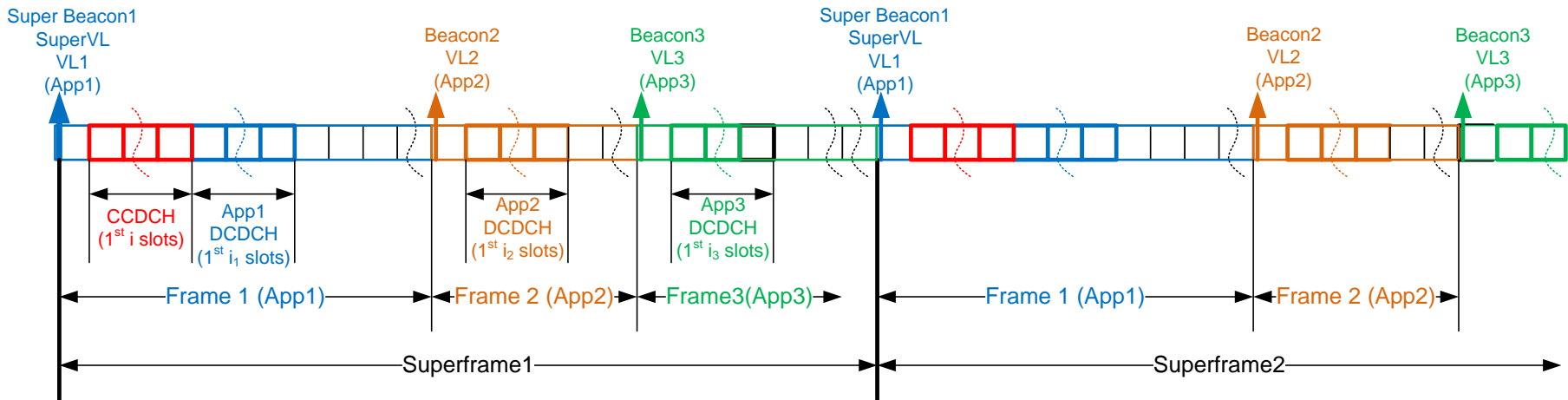

- Super Beacon: indicates the start of a superframe and define the structure of the new superframe
- Common Control/Data Channel: contention based access among all P2PNWs
- Application Frames
 - Application beacon: indicates the start of an application frame and define the structure of the application frame
 - Dedicated Control/Data Channel: contention based access within a P2PNW
 - time slot for communication: Contention Free Period (CFP)

3.2.3 Super Frame Structure (TDMA) Hybrid Control

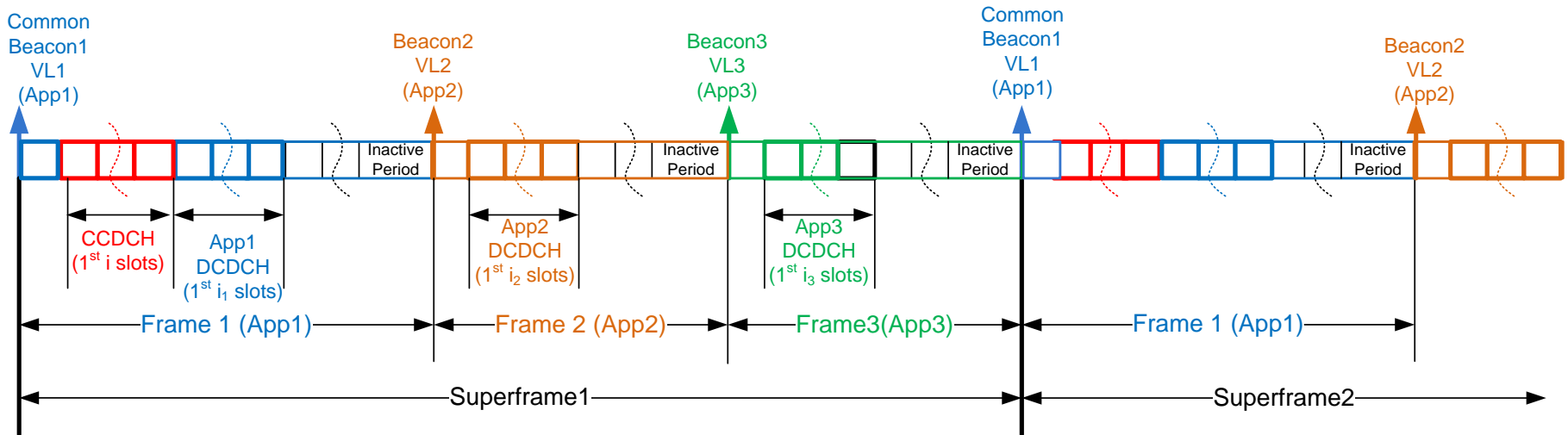

- Centralized control for intra-P2PNW communications by a VL.
- The first VL in proximity is the default VL to insert a Common Beacon to start a new Superframe .
- Each Application frame starts with application beacon, CCDCH and includes DCDCH and CFP.
- Inactive period is inserted for each Application Frame.

3.2.4 Superframe Structure (TDMA): Fully Distributed Control

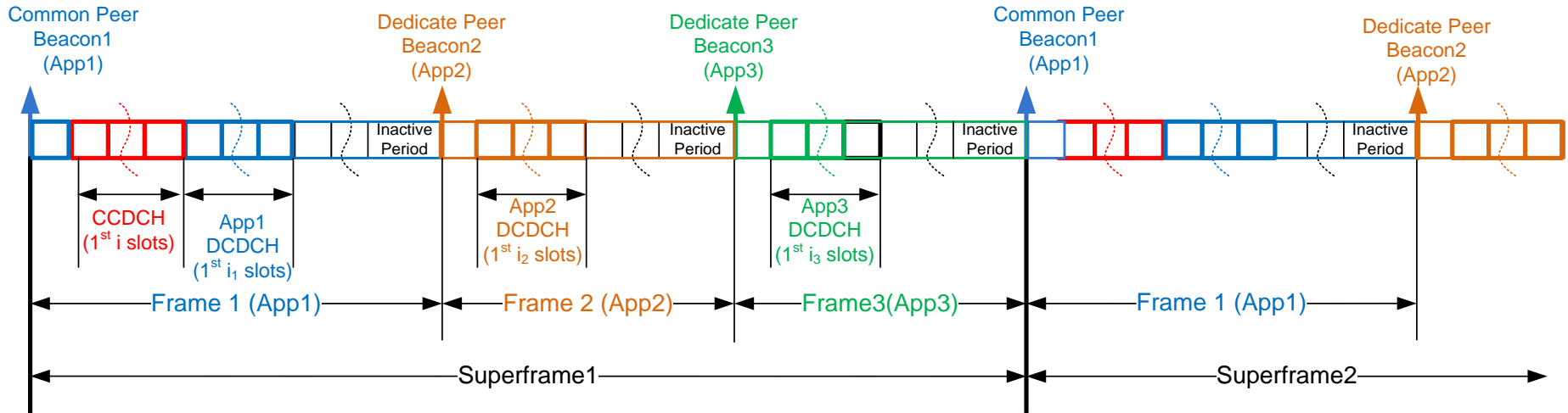

- The first peer in proximity is the default peer to insert common peer beacon to define and start a new superframe through channel management process.
- Coordination among applications are required to establish application frames within a superframe.
- contention based access: CCDCH for inter-P2PNWs and DCDCH for intra-P2PNW.
- Inactive period is inserted for each Application Frame.

3.2.5 Super Frame Structure (OFDMA)

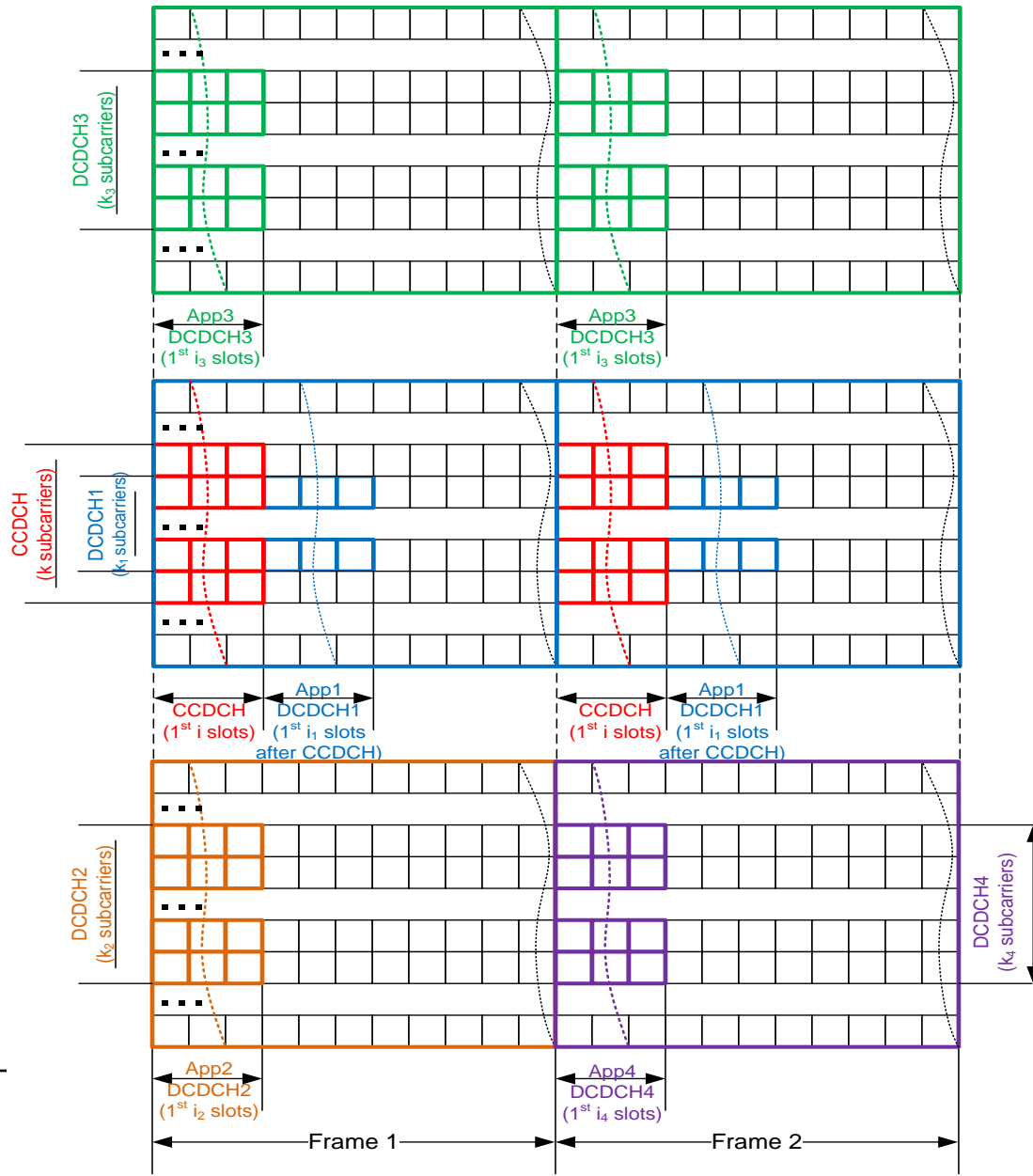

3.2.6 Super Frame Structure (CDMA/DSSS)

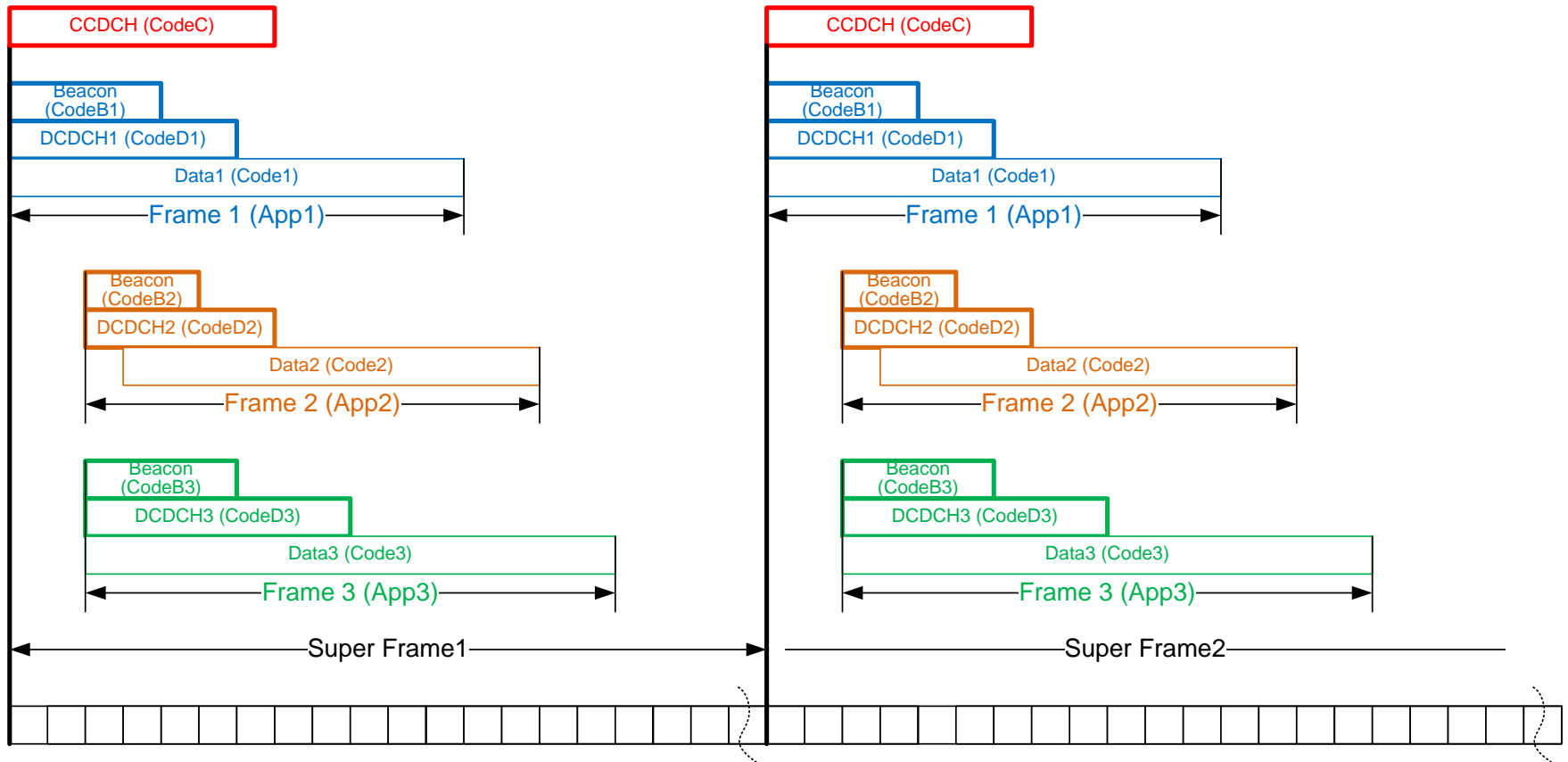

3.3 General MAC Frame

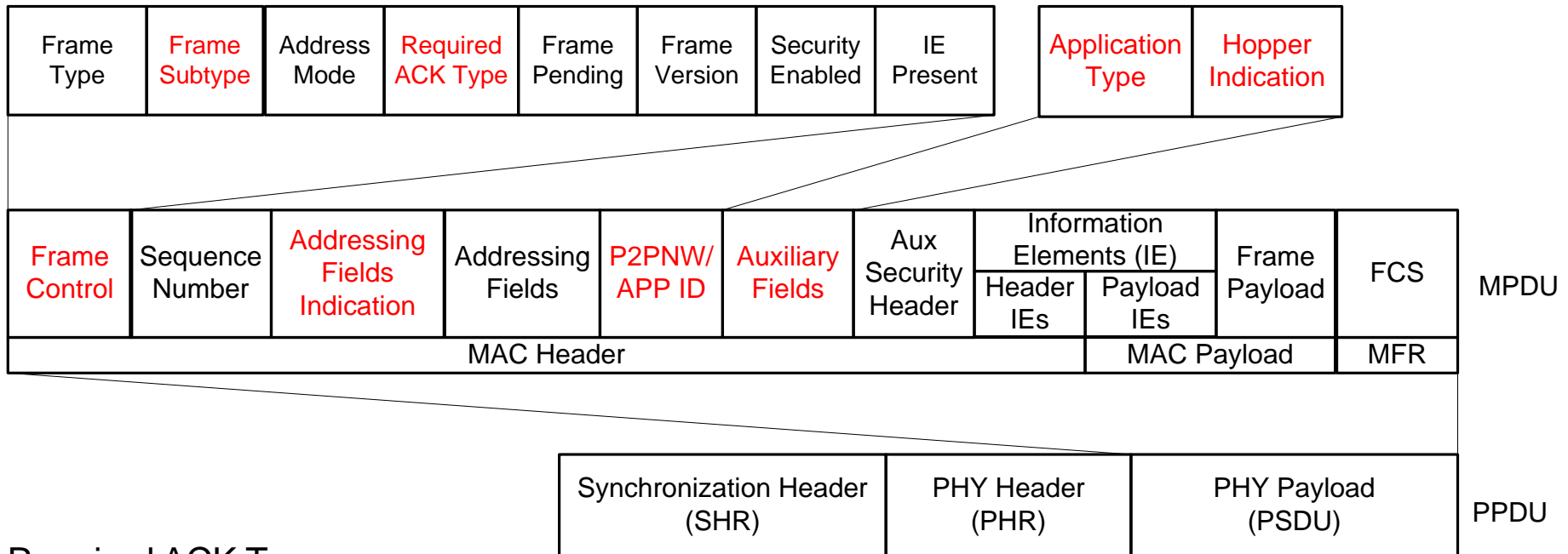

- Required ACK Type:

- Indicate what kind of ACK is required, e.g., No ACK, Conditional ACK, Aggregated ACK, Cross-layer ACK, etc.

- P2PNW/APP ID:

- Indicate the P2P network ID or application ID
- P2P network ID is locally unique and application-dependent.

- Hopper indication:

- Indicate if the frame sender is willing to relay other frames for the multi-hop discovery

- Addressing fields indication:

- Indicate if addressing field includes the transmitting hop address and receiving hop address, used for multi-hop

- Application type:

- Indicate the application/service category for fast discovery, such as emergency service, social networking.

3.4 Beacon Frame

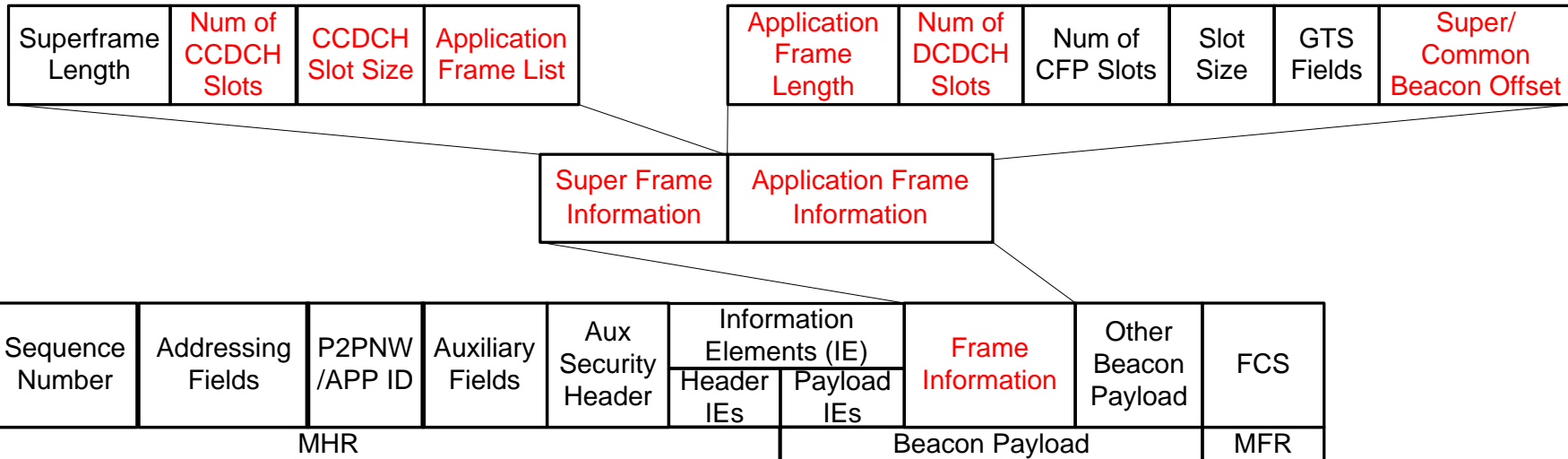

- Super frame information:

- Define the structure of a new super frame.
- Number of CCDCH slots and CCDCH slot size:
 - Define CCDCH
- Application frame list
 - indicate where the established application frame for synchronization

- Application frame information:

- Define the structure of a new application frame.
- Application frame length:
 - Indicate the application frame length
- Number of CCDCH slots:
 - indicate the DCDCH length
- Super beacon or common beacon offset:
 - indicate where the start of the next super frame for synchronization

4. Context Management

4. Context Management

- Excerpts from IEEE 802.15.8 TGD [1]
 - 4.1 Concepts and architecture: “IEEE 802.15.8 shall support scalable data rate to accommodate many applications such as listed in the Application Matrix”
 - 6.17 Requirements for high layer and infrastructure interaction: “IEEE 802.15.8 may be able to interact with higher layers to access suitable infrastructure, if it exists, e.g. to facilitate the set up and maintenance of communication”, “IEEE 802.15.8 shall perform measurements at the request of and report the results to higher layers. These measurements may include received signal strength and interference levels”
 - 7.7 System overhead: “Overhead, including overhead for control signaling as well as overhead related to data communications shall be reduced as far as feasible without compromising overall performance and ensuring proper support of systems features”
 - From 5C – “Discovery without Association”, “Fast Association MAC Layer” → Context Management
- Motivation
 - There are various PAC use cases (i.e. services and applications) as included in the Application Matrix [2]. These applications have different features and requirements (i.e. context information)
 - **PAC needs Context-Awareness**: 1) each individual app is context-driven; 2) context is needed to support multi-apps
 - PAC communications are formed for corresponding context (i.e. the desired services /applications /users /devices etc. in the proximity)
 - Context-Aware PHY/MAC Protocols cater for these diverse applications.
- Proposals
 - 4.1 Terms and Concepts
 - 4.2 Context Modeling
 - 4.3 Context Management Function

4.1. Terms and Concepts

■ Context

- Context is the situational information related to and/or used to describe peers, devices, services, applications, links, networks, etc., in peer-aware communications
- Examples as defined/described in IEEE 802.15.8 TGD [1]
 - IDs:
 - Device ID, Device group ID,
 - Application Type ID, Application-specific ID,
 - Application-specific User ID, Application-specific Group ID
 - Measurements:
 - Received Signal Strength,
 - Interference Level

● Context-Awareness

- PHY/MAC protocols are aware of context information.
 - They can generate, access and manage context information.
 - They can be optimized based on dynamic context information
 - e.g. context-aware discovery, context-aware association, context-aware power control, cross-layer optimization, etc

4.2. Context Modeling

- Peer Information Structure: Hierarchical & Flat

Hierarchical Peer Information

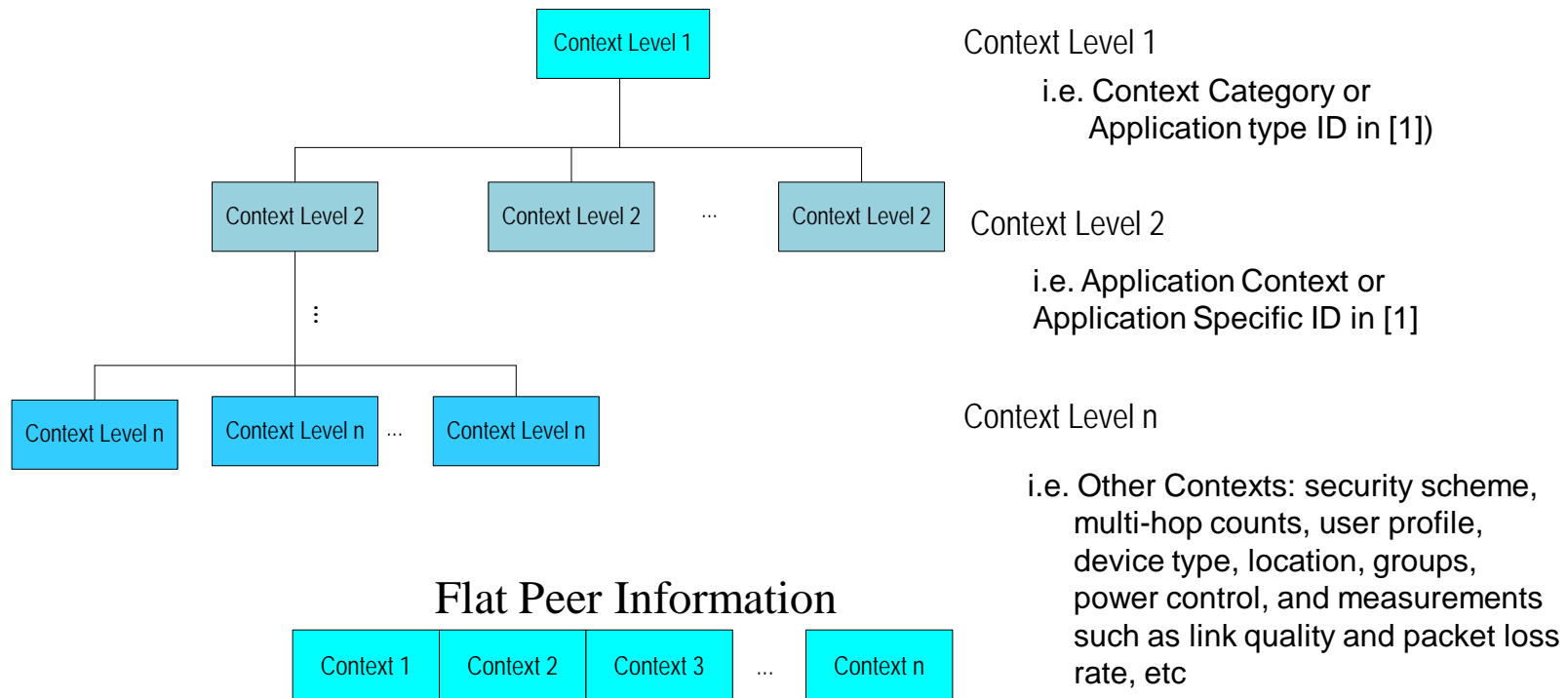

4.3. Context Management Function

- Context Management Function (CMF) has the following functionalities
 - **Remote Context Exchange:** It supports two peer devices (PD) to exchange context information at the MAC layer.
 - Case 1: One-Hop - Two PDs exchange context information directly
 - Case 2: Multi-Hop – Two PDs exchange context information via a proxy PD as an intermediary in the middle
 - **Local Context Exchange:** It supports the exchange of context information across different layers and functions within the same PD via service access points (SAP).
 - Case 1: between MAC layer and higher layers to share and exchange context information
 - Case 2: between MAC layer and PHY layer for measurement reporting
 - Case 3: between CMF and other MAC functions to support context-awareness

4.3. Context Management Function

- Use Case: Two smart phones exchange context info such as their locations (indoor and outdoor, geo-location and civil location, etc)
- Remote Context Exchange Architecture – One-Hop
 - Context Manager: Each PD has a Context Manager as an MAC layer function. The CM on each PD talks to each other using Client/Server model.
 - Step 1: The Context Manager in PD1 as a client sends Context Request to the Context Manager in PD2 as a server. The Context Request can request to perform the following context operations
 - Add, delete, retrieve, update, subscribe a context; aggregate multiple context information, etc.
 - Step 2: The Context Manager in PD2 sends Context Response back to the Context Manager in PD1.

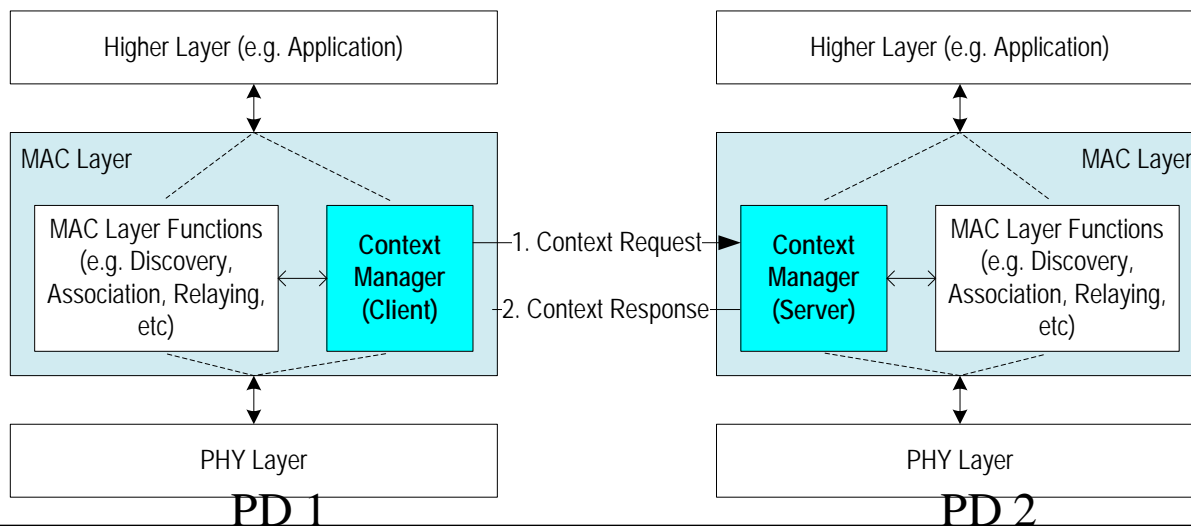

4.3. Context Management Function

- Use Case: A PD as a relay assists context exchanging among other PDs
 - CMS could be located in a cloud. Then end devices/users need a proxy (i.e. CMP) to connect to the CMS. CMS/CMP can perform security check (e.g. authentication)
- Remote Context Exchange Architecture – Multi-Hop
 - CMC in PD1, CMP in PD3, CMS in PD2 are MAC-layer functions.
 - PD3 as a proxy to assist and relay context exchanging MAC frames between PD1 and PD2
 - The Context Request and Context Response message exchanged between PD1 and PD3, between PD3 and PD2, are new MAC frames.
 - Step 1: PD1 sends Context Request to PD3; PD3 forwards the Context Request to PD2
 - Step 2: PD2 sends Context Response to PD3; PD3 forwards the Context Response to PD1

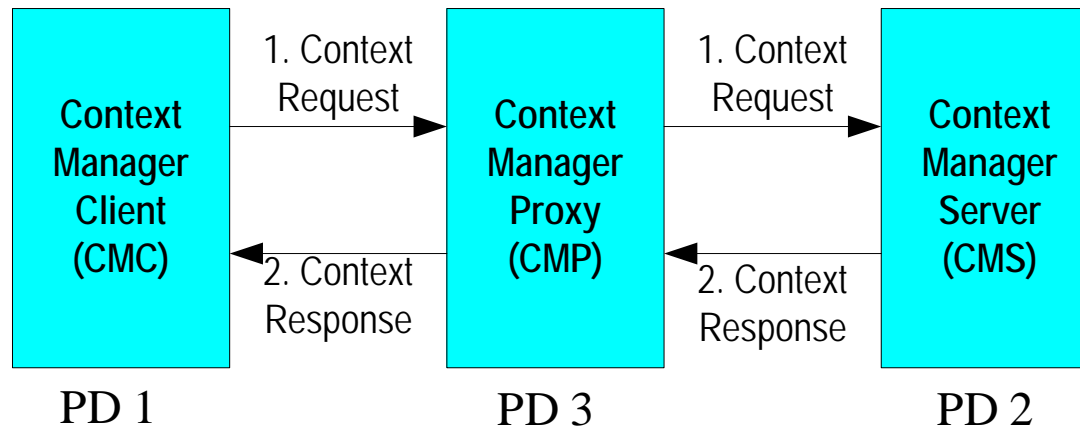

4.3. Context Management Function

- Local Context Exchange Procedures – Within a PD

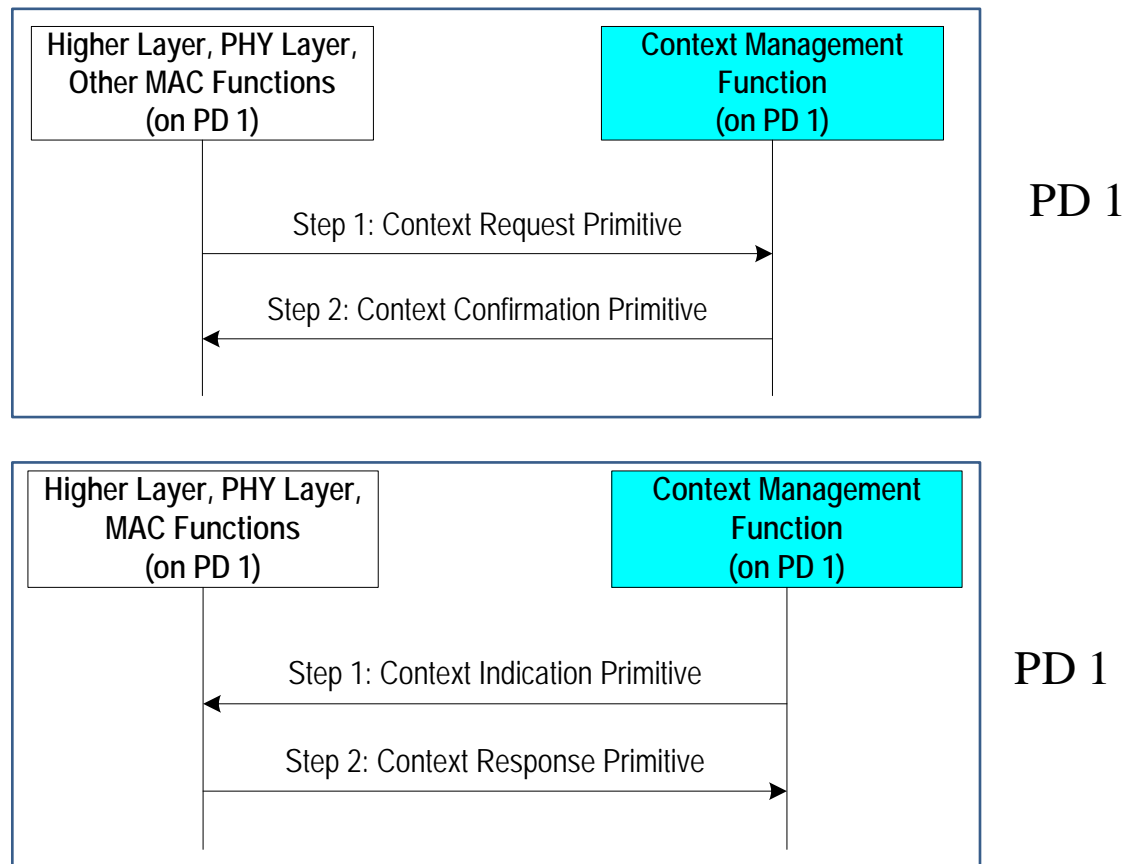

4.3. Context Management Function

- Procedures for One-Hop Remote Context Exchange

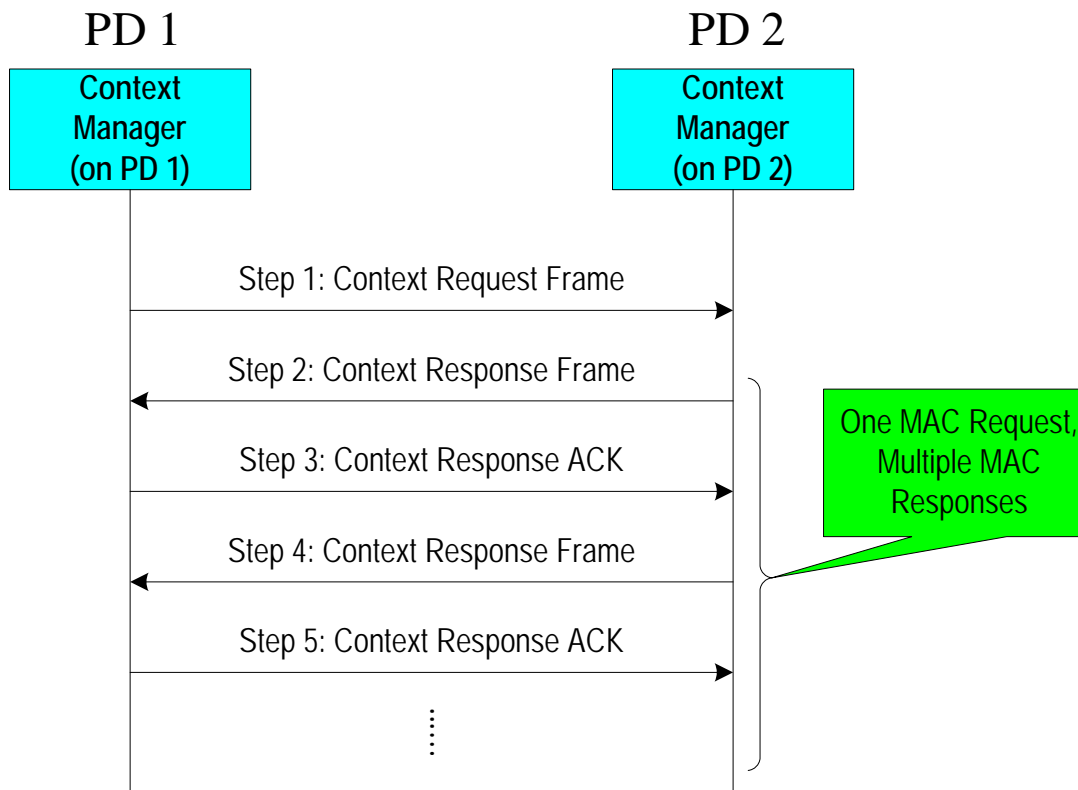

4.3. Context Management Function

- Procedures for Multi-Hop Remote Context Exchange

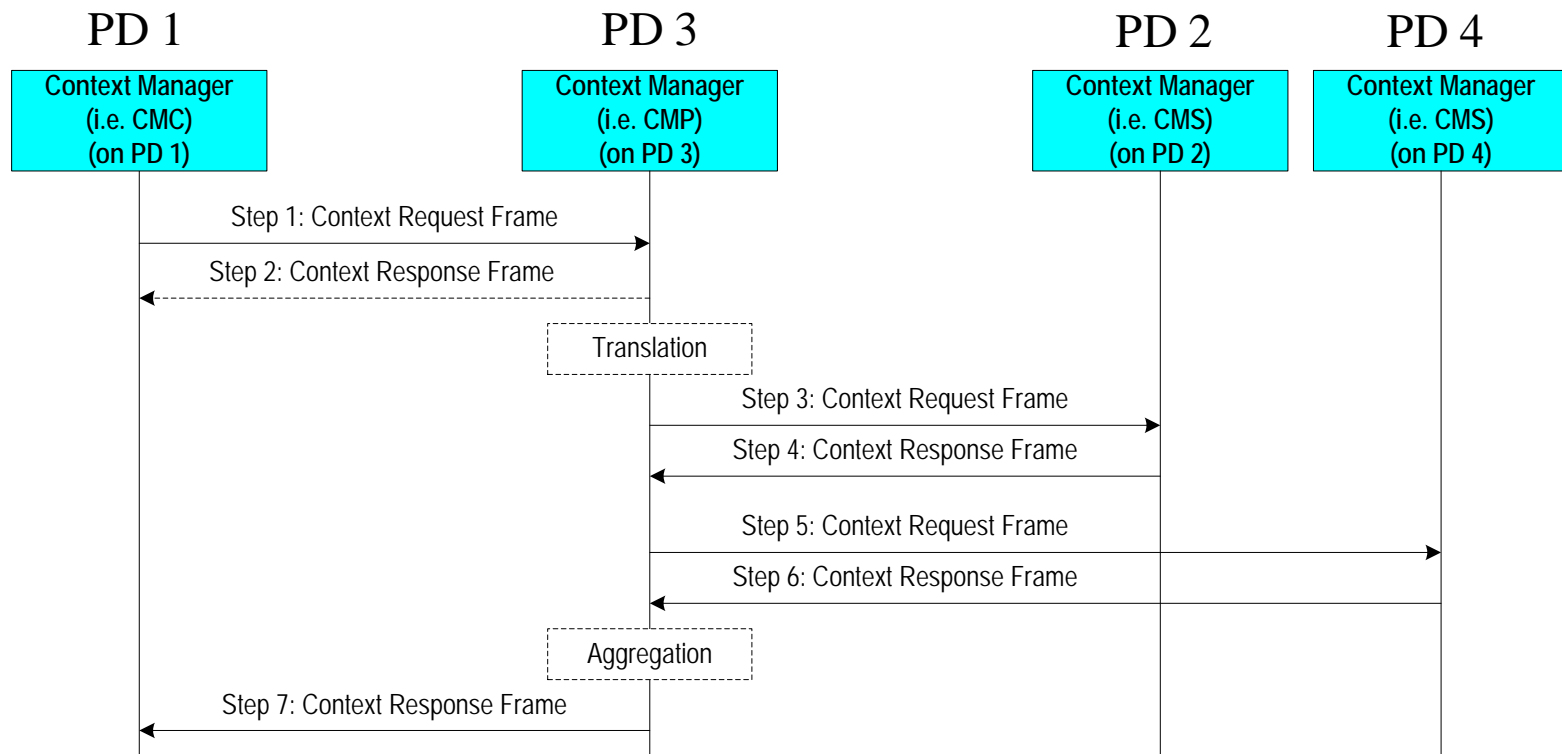

4.3. Context Management Function

- Procedures for Session-based Remote Context Exchange

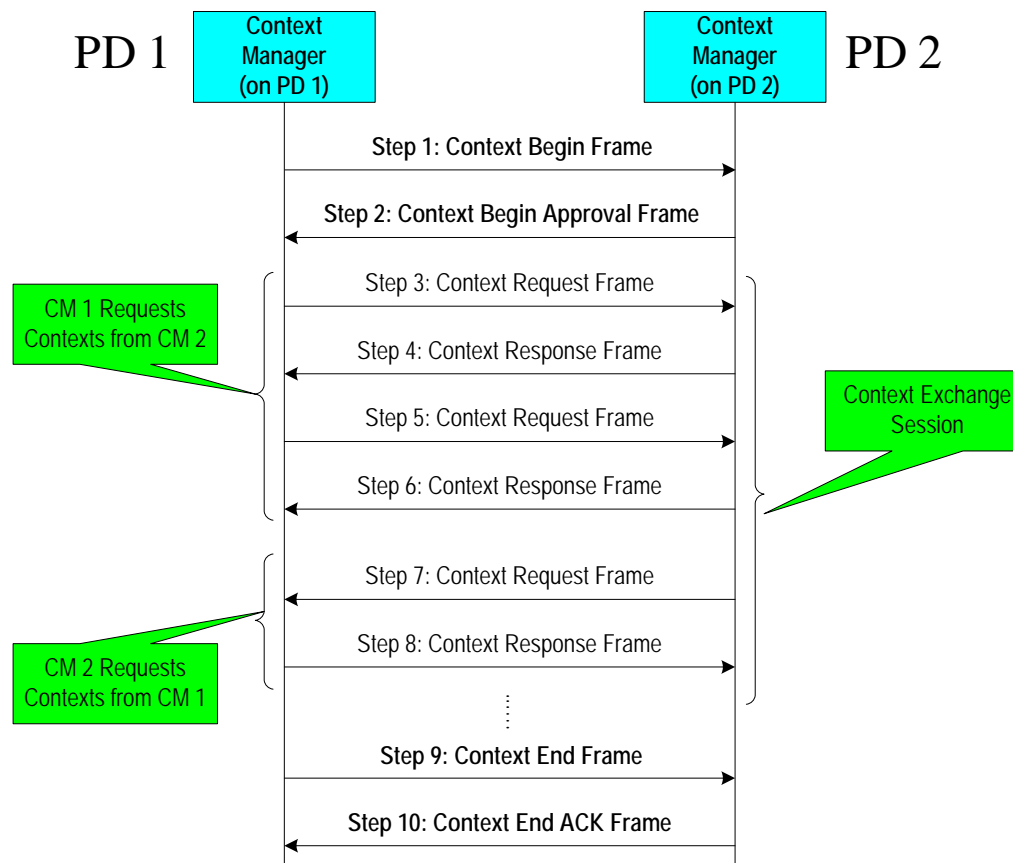

5. Context-aware Fast Discovery Procedures

5. Context-aware Fast Discovery Procedures

- Excerpts from 5C
 - First, it is to be used for peer-to-peer and group communications and to be a part of functions implemented at PHY and MAC layers. Secondly, the discovery process is performed without the association process, which further reduces the latency incurred from the neighbor discovery.
- Excerpts from IEEE 802.15.8 TGD [1] section 6.3
 - The following properties are desirable for discovery process.
 - Expedited discovery
 - Energy-efficient discovery(e.g. low duty cycle)
 - Support high PD density and high discovery traffic
 - Efficient spectrum utilization
 - Prioritized access to discovery
 - For the purpose of discovery of PAC peers, the discovery signal conveys information that may reflect one or more of the following IDs such as Device ID, Device Group ID, Application type ID, Application-specific ID, Application-specific user ID, Application-specific group ID.
- Motivation
 - Context-aware Discovery at MAC
 - Fast Scan using hierarchical context ID
- Proposals
 - 5.1 Terms and Concepts
 - 5.2 General Context-aware Discovery Procedure
 - 5.3 Fast Scan Procedure for Peer Discovery

5.1 Terms and Concepts

Service Based				
<i>Context-aware Category (CACat)</i>	<i>Service ID (SID)</i>	<i>User ID (UID)</i>	<i>AP Parameters (APParam)</i>	<i>Others</i>
Emergency	War Fire Medical ...	Homeland Security Police Patient ...	Region, broadcast/multi-cast... Location, severity, help center... Hospital, doctor, privacy level... ...	
High Priority	Flood watch ...	Weather forecast center ...	Region, time, severity, help center...	
Connection	Facebook ...	Facebook User ID	Chat, status update...	
Advertisement	Service x Product y ...	Agent or store Manufacture or store ...	Price, discount, forward credit... Price, club coupon, expiring date... ...	
User Centric Activities	Content exchange	User ID	Content name, size, privacy...	
Smart Environment	Device Sync	User ID	Device list, items to synchronize...	
Smart Transportation	Traffic	Traffic controller	Location, time, status...	
Network of Network	Network name	Network ID	Context, load, parent network...	
User Based				
<i>Context-aware Category (CACat)</i>	<i>User ID (UID)</i>		<i>User Parameters (UParam)</i>	<i>Others</i>
Gamer	User ID or virtual User ID		Games, game skill level...	
Multi-hopper	User ID		Level of hops, number of peers behind...	
Device Based				
<i>Context-aware Category (CACat)</i>	<i>Device ID (DID)</i>		<i>Device Parameters (DParam)</i>	<i>Others</i>
Tablet	Device ID		Manufacturer, operating system...	
Monitoring System	Device ID		Manufacturer, model...	

5.2 General Context-aware Discovery Procedure

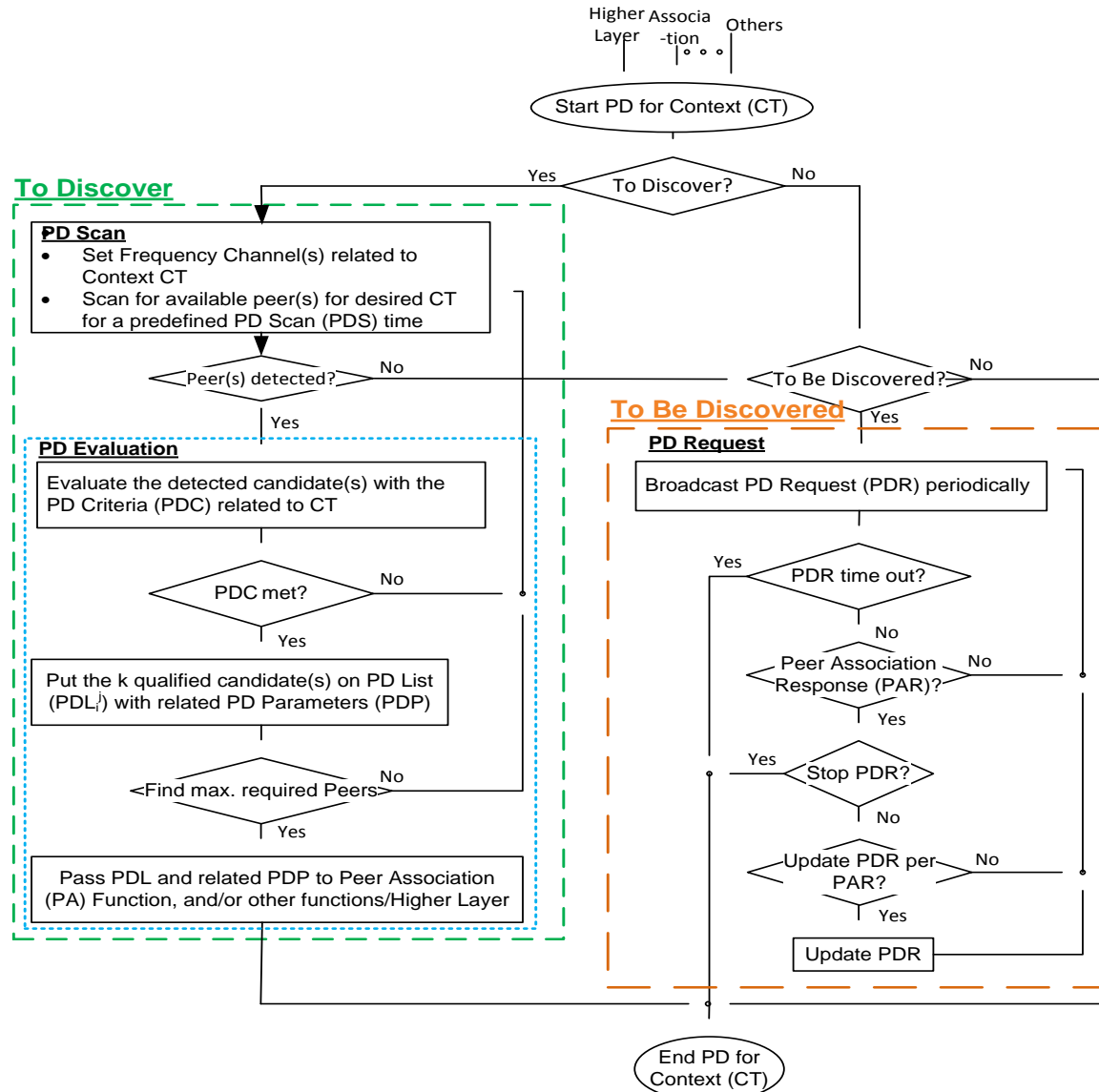

5.3 Fast Scan Procedure for Peer Discovery

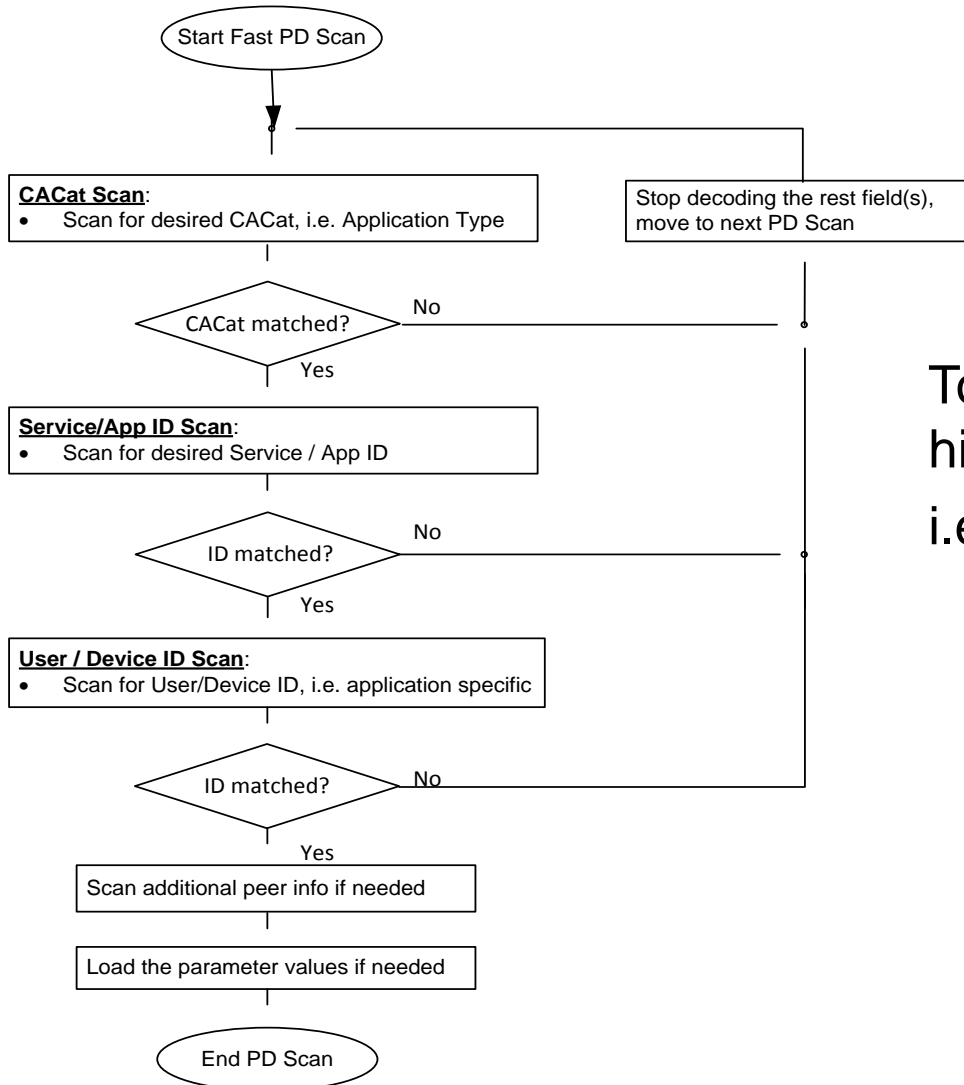

To reduce peer scan time by using hierarchical context ID

i.e. Application Type

➔ Application ID

➔ Application Specific User ID

6. Context-Aware Fast Association (Peering) Procedures

6. Context-Aware Peer Association

- Excerpts from IEEE 802.15.8 TGD [1]
 - 4.1 Concepts and architecture: “IEEE 802.15.8 shall support scalable data rate to accommodate many applications such as listed in the Application Matrix ”
 - 6.4 Peering: “IEEE 802.15.8 shall support peering. Peering is equivalent to link establishment; link establishment is the process at the end of which two or multiple PDs are ready to exchange data.”, “IEEE 802.15.8 shall support re-peering. In the re-peering procedure, discovery may be simplified or omitted”
 - 6.11 Multi-hop support: “IEEE 802.15.8 shall provide at least 2-hop relaying function.”, “Only relay-enabled PD shall relay discovery messages and/or traffic data from PDs in the proximity”
- Motivation
 - Peering or association needs to be fast and support multi-applications and multi-hop
- Proposals – Context-Aware Peer Association
 - 6.1 Terms and Concepts
 - 6.2 Association Context Information (ACI)
 - 6.3 Multi-Level Association
 - 6.4 Unified Peer Association
 - 6.5 Context-Aware Association
 - 6.6 Context-aware Association Update
 - 6.7 Context-aware Disassociation
 - 6.8. Context-aware Re-association

6.1. Terms and Concepts

- **Association (Peering)**
 - It is the peering process through which two or multiple PDs are ready to exchange data.
- **Association Identifier (AID)**
 - The identity of each established association or peering relationship between two or more PDs.
- **Association Context Information (ACI)**
 - The context information related to each established association or peering relationship.
 - Association Identifier is a part of Association Context Information

6.2. Association Context Information

- An ACI contains properties and related information of an established association, for example,
 - AID, Association Type, Creation Time, Association Duration, Association Priority, Current Status, etc
- ACI can be contained in association-related MAC frames
 - For instance, Association Request & Response, Association Update Request & Response, Disassociation Request & Response, Re-association Request & Response
 - ACI in Request Frames
 - device profile, user profile, service profile, association requirement, association history, etc
 - ACI in Response Frames
 - device profile, user profile, service profile, association results (e.g. parameters for forthcoming communications), etc

6.3. Multi-Level Association

- Multi-Level Association → Fast Association

- Device-based Association
 - DAID: Device-based Association Identifier
- Service-based Association
 - SAID: Service-based Association Identifier
- User-based Association
 - UAID: User-based Association Identifier

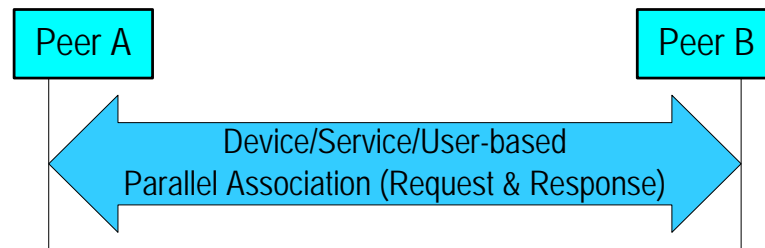
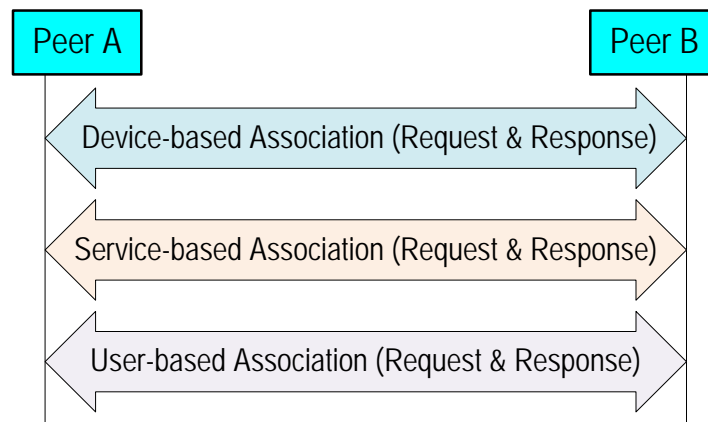
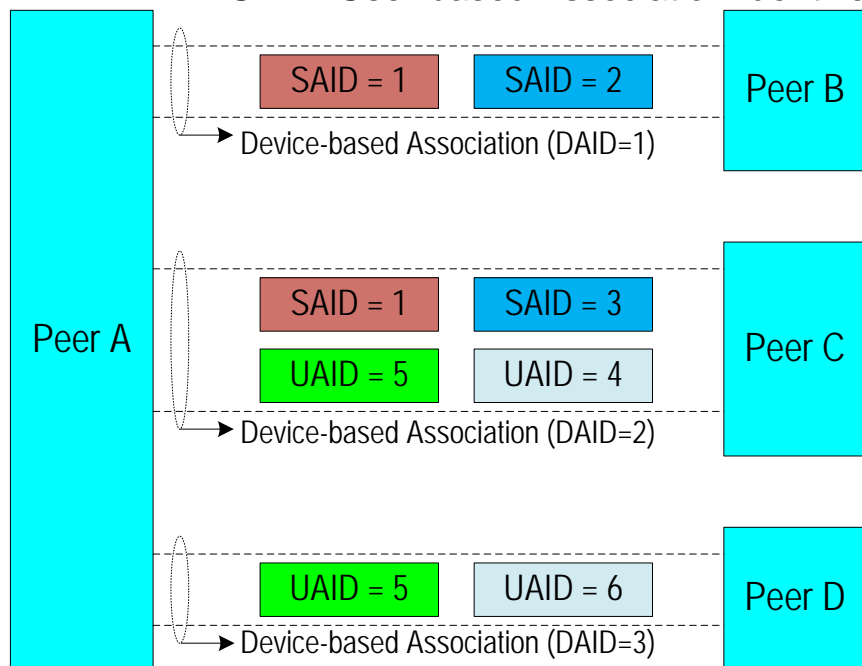

Fast Association

6.4. Unified Peer Association

- Unified Peer Association
 - Context-Aware Association
 - Context-Aware Association Update
 - Context-Aware Disassociation
 - Context-Aware Re-association
- Each PD may maintain two timers:
 - One for performing periodical Association Update
 - Another for performing Disassociation

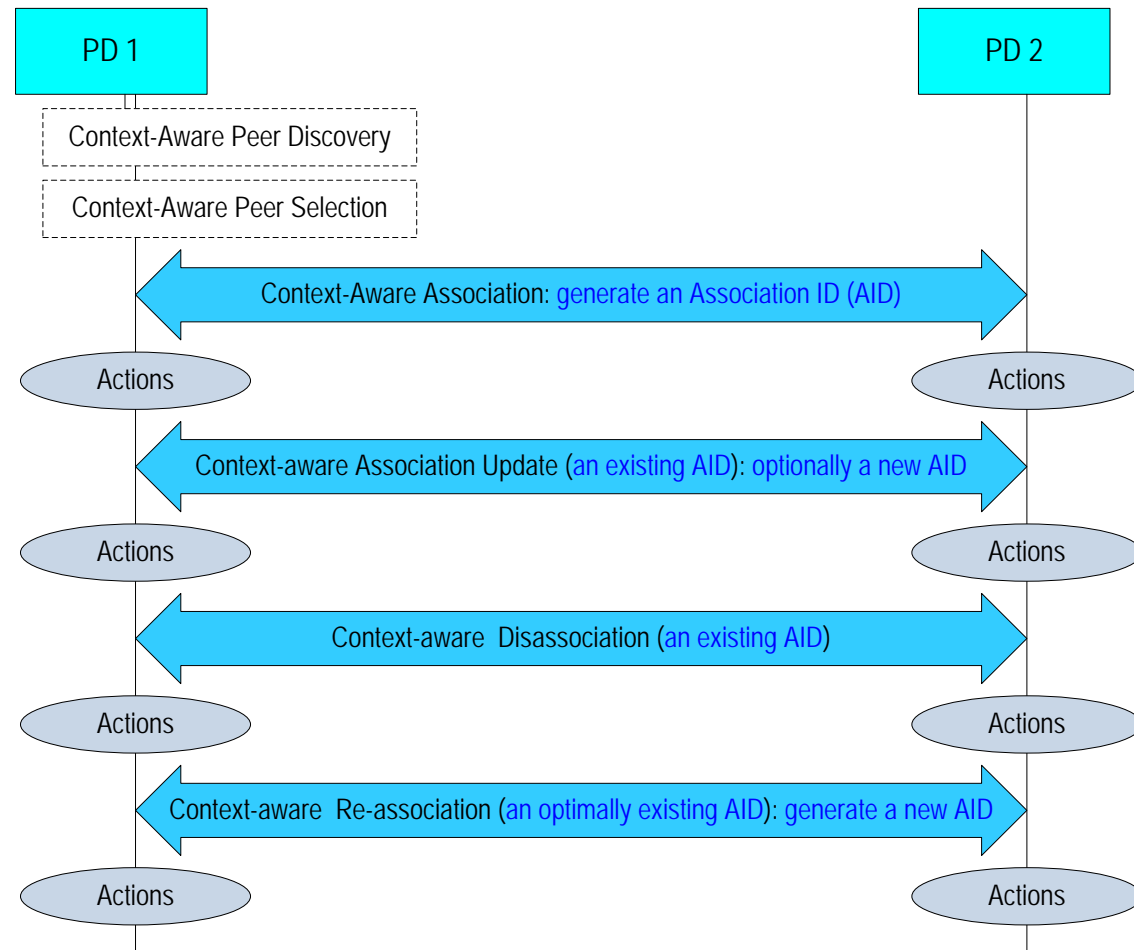

6.5. Context-Aware Association

- Association Request: Requesting association (in Approach 1 & 2)
 - Association Request Info: device profile, service profile, user profile, association requirement, etc
- Association Notification: Requesting mutual association (in Approach 2)
 - Association Notification Info: device profile, service profile, user profile, communication configuration, etc
- Association Response: Responding association requests (in Approach 1 &2)
 - Association Response Info: device profile, service profile, user profile, communication configuration, etc

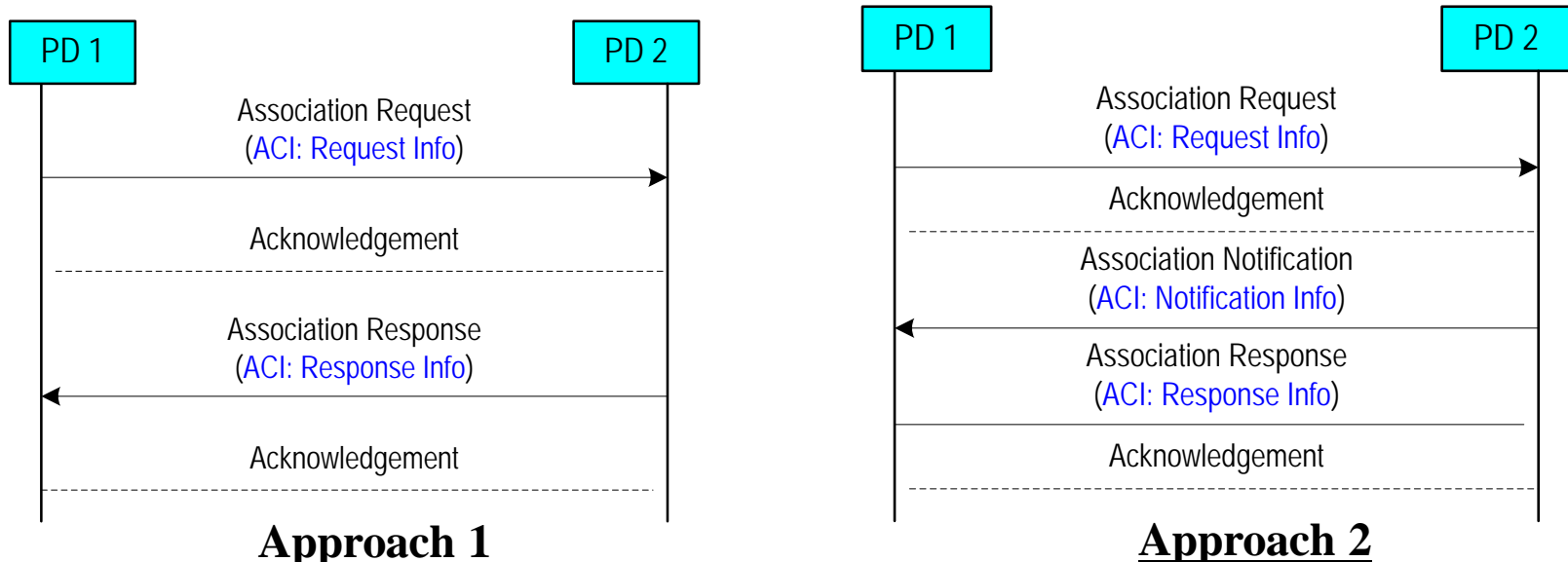

6.6. Context-Aware Association Update

- An existing association can be updated by either PD (1 or 2) to periodically or triggered by a specific condition or event (i.e. context change) change its ACI, for example:
 - Change association duration
 - Trigger peer discovery to find other peers
 - Optimize peer discovery scheme/behavior
 - Trigger association with other peers
 - Change service delivery behavior such as service data rate

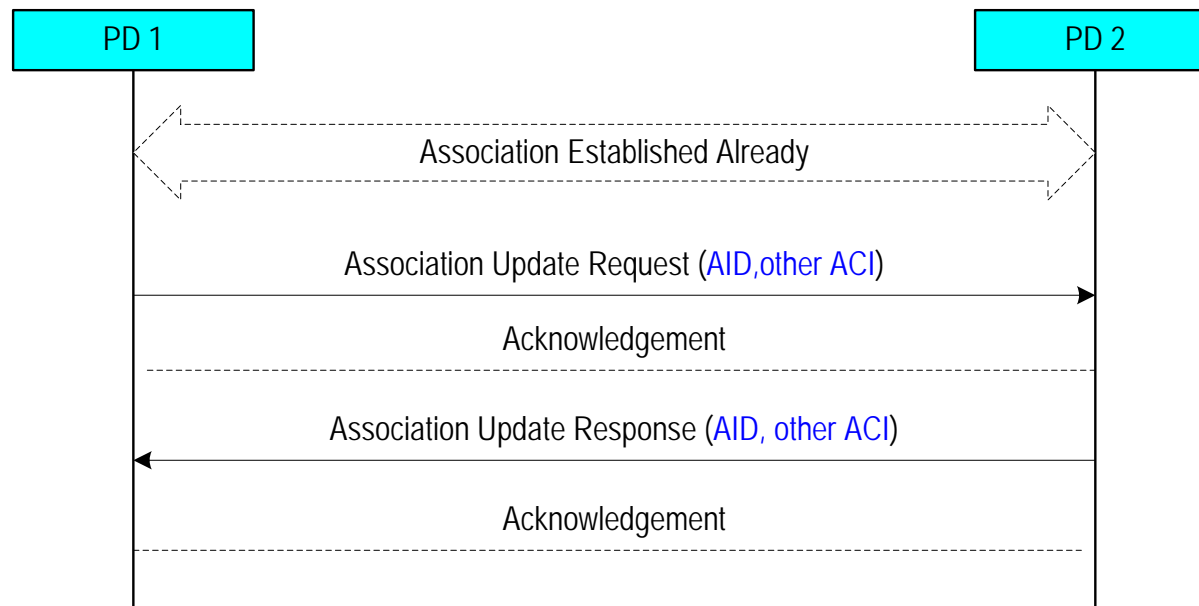

6.7. Context-Aware Disassociation

- Disassociation can be triggered periodically by a pre-configured timer or randomly by an occurring event or condition change.
- Either PD (1 or 2) can trigger disassociation.



6.8. Context-Aware Re-association

- After an existing association is disassociated, either PD (1 or 2) can request to re-associate
- Re-association request introduces less overhead and faster than a new association request

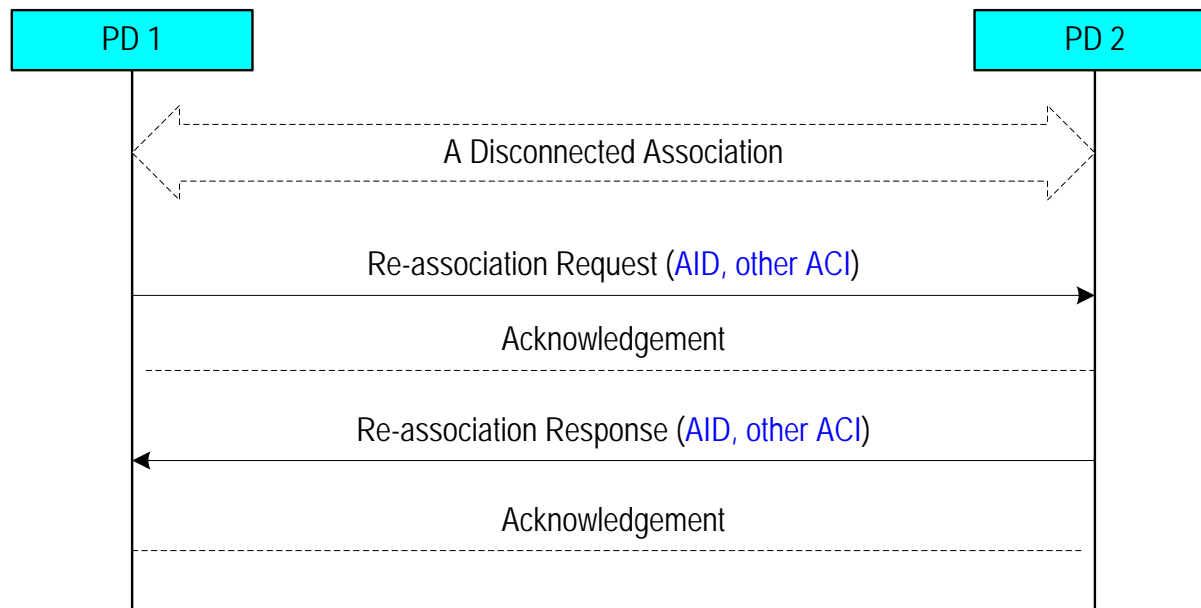

7. Context-Aware Synchronization Procedure

7. Context-Aware Synchronization Procedure

- Excerpt from IEEE 802.15.8 TGD [1]
 - 6.2 Synchronization: IEEE802.15.8 may operate in synchronous or asynchronous mode. When IEEE802.15.8 is operating in synchronous mode, a PD shall maintain synchronization among synchronized PDs.
- Motivation:
 - Find super frame/application frame/slot boundary for communication
 - Support multi-application scenario: maintain the time reference for each application
- Proposal:
 - 7.1 Terms and Concepts
 - 7.2 Synchronization Procedure under Virtually Centralized Control
 - 7.3 Synchronization Procedure under Hybrid Control
 - 7.4 Synchronization Procedure under Distributed Control

7.1 Terms and Concepts

- **Frame Map**: included in the super beacon
 - List of Application Frame Offsets (LAFO): a list of time offsets for different application frames within the superframe.
- **Super Beacon Offset**: included in an application beacon
 - Indicate where the next super/common beacon is in terms of time offset

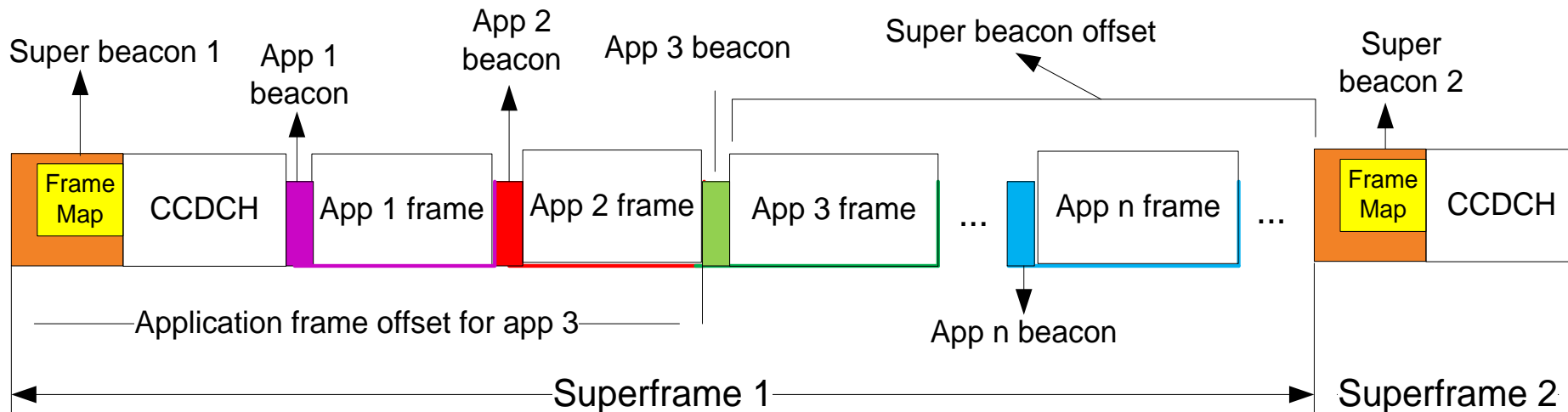

7.2 Synchronization Procedure: Virtually Centralized Control

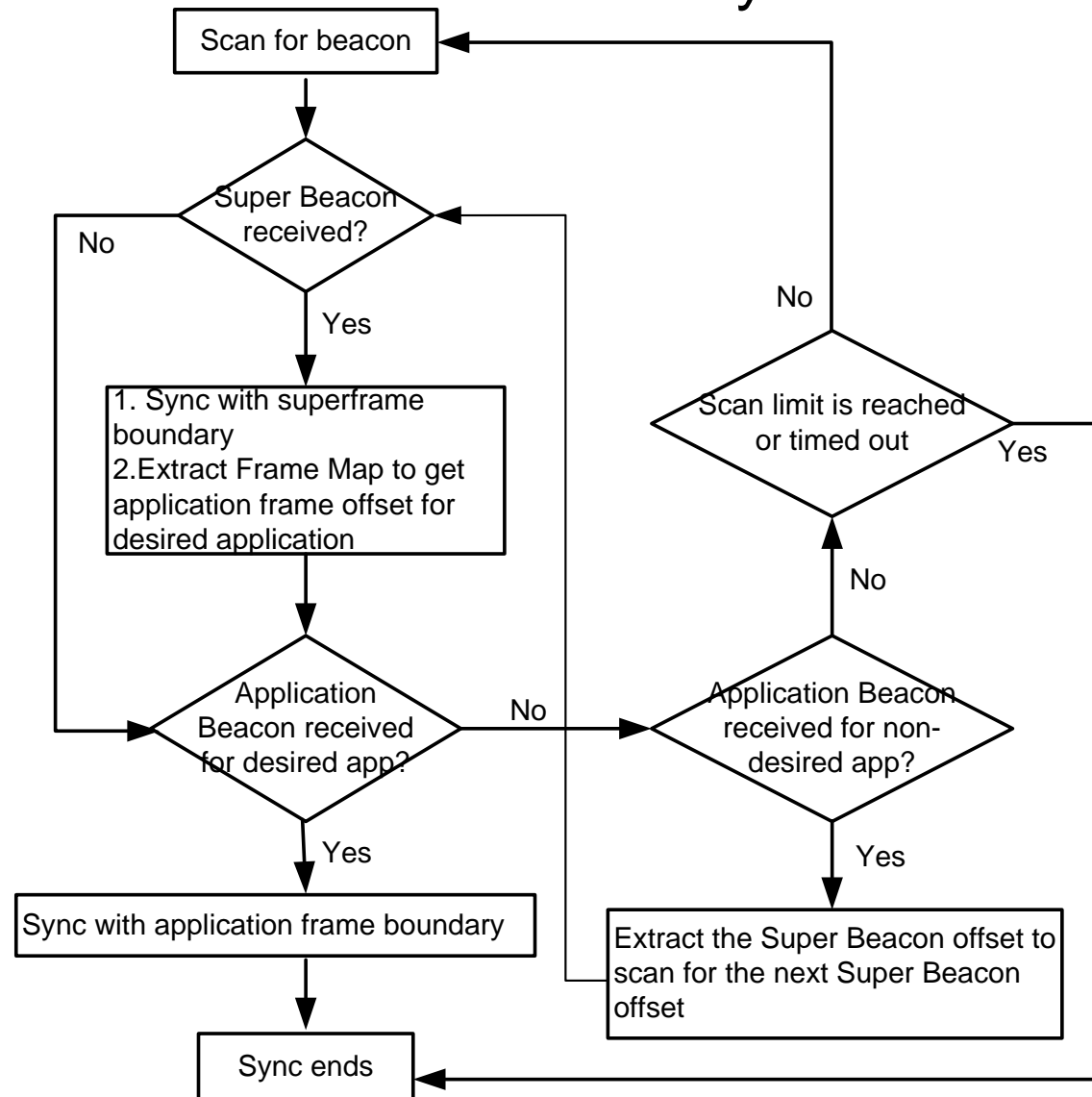

7.3 Synchronization Procedure under Hybrid Control

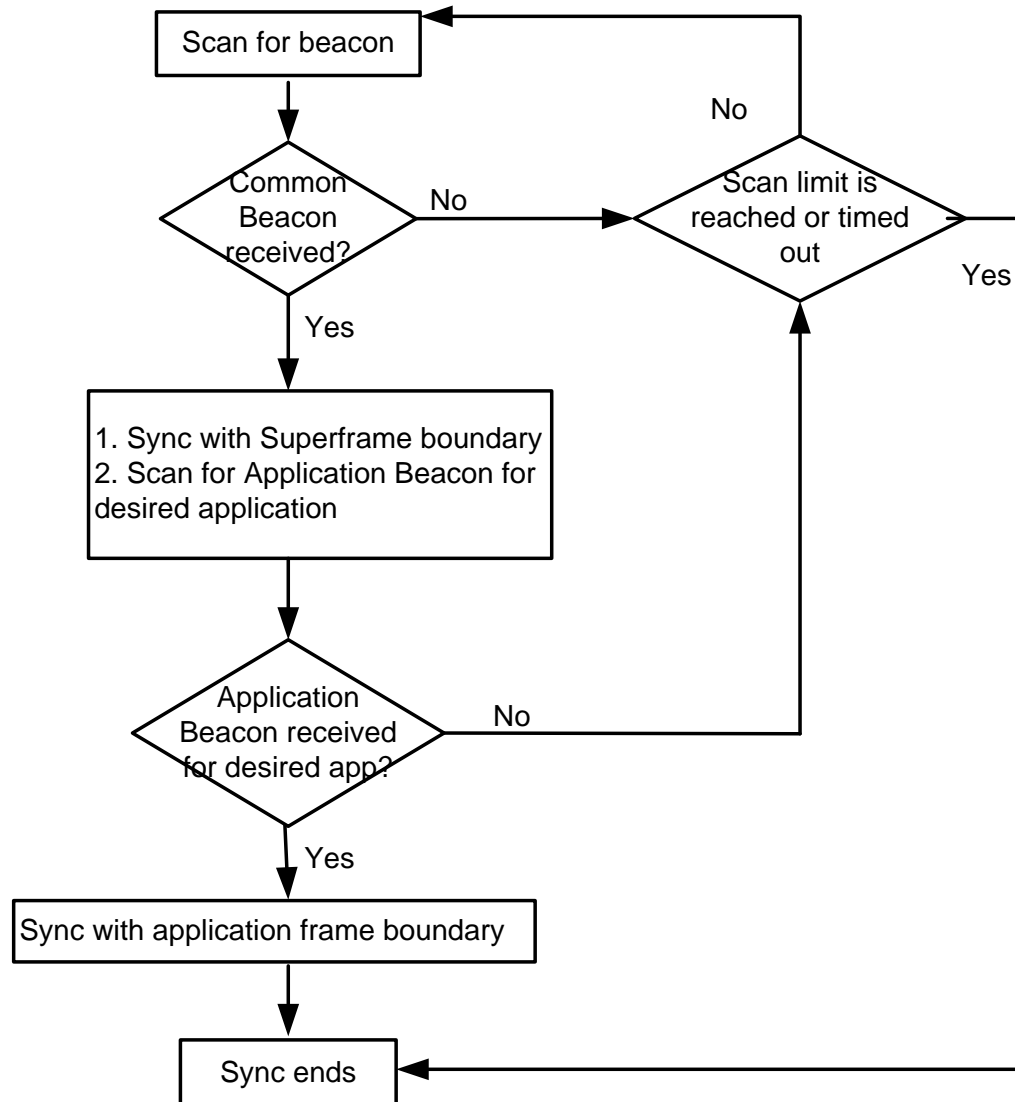

7.4 Synchronization Procedure: Distributed Control

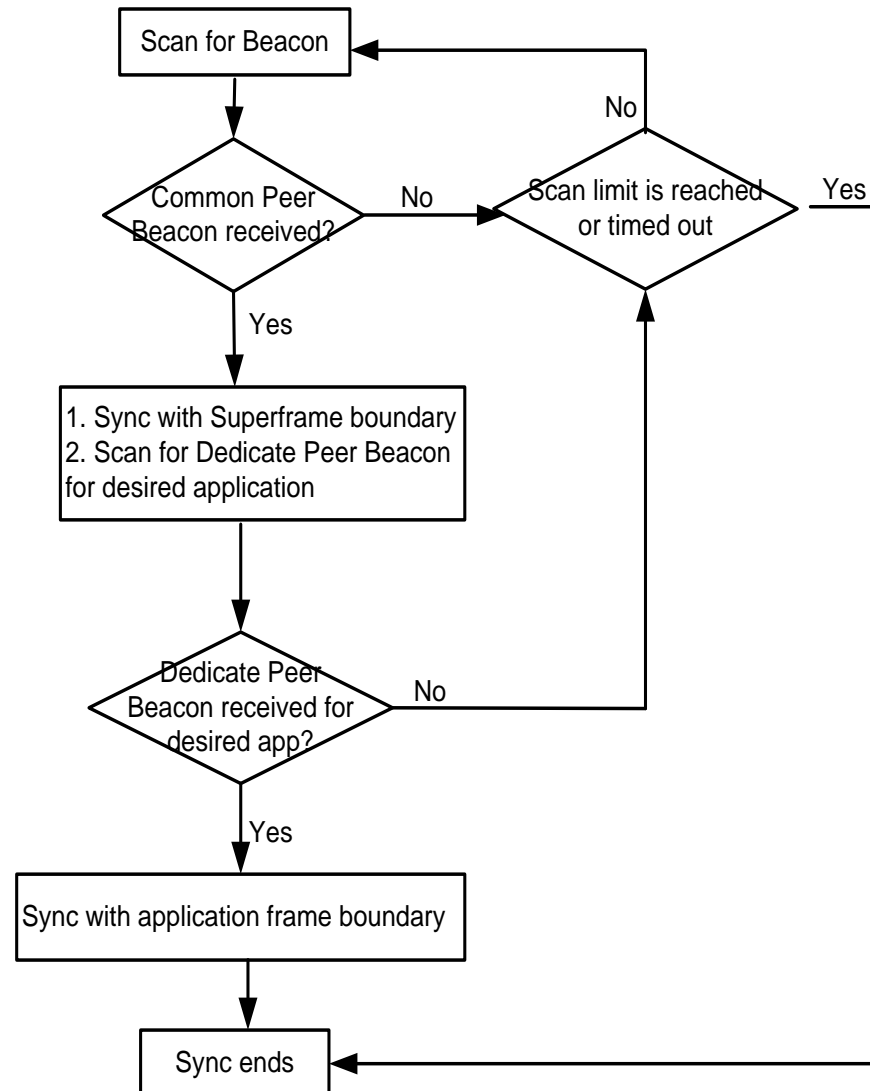

8. Context-aware Channel Management Procedures

8. Context-aware Channel Management Procedures

- Excerpt from IEEE 802.15.8 TGD [1]
 - 6.5 Scheduling: IEEE 802.15.8 shall provide a fully distributed scheduling mechanism.
 - 7.5 Fairness: IEEE 802.15.8 may meet fairness constraints.
- Motivation:
 - To support **vast range of Use Cases** with infrastructure-less and distributive P2PNWs in proximity. **Hence multiple schemes are needed.**
 - A peer joins or leaves a P2PNW very **dynamically** which will **impact the over all scheduling in proximity if a flat scheduling (i.e. per peer) is used.**
 - P2PNWs are formed and ceased very **dynamically** based on the needs for desired services. **Therefore any predefined channel allocation for P2PNWs in proximity is either limiting or inefficient.**
- Proposal:
 - 8.1 Terms and Concepts
 - 8.2 Fast Inter-P2PNW Channel Accessing Procedure
 - 8.3 Fast Intra-P2PNW Channel Accessing Procedure
 - 8.4 Inter-P2PNWs Channel Allocation with P2PNW detection
 - 8.5 Intra-P2PNW Channel Allocation with P2PNW cooperation

8.1 Terms and Concepts

- **CCDCH** (Common Control and Data Channel) is defined for inter-P2PNWs communications and shared by all services or applications or P2PNWs in proximity.
- **DCDCH** (Dedicated Control and Data Channel) is defined for intra-P2PNW communications and shared by peers within a service or application, i.e. a P2PNW.
- **Application Frame** is a period of time within a Superframe granted to a specific application.
- **Inter-P2PNWs Channel Management:**
 - The radio resources or channel usages are detected and negotiated among different P2PNWs, i.e. applications, in proximity.
- **Intra-P2PNW Channel Management:**
 - The radio resources or channel usages are detected and negotiated among different peers within a P2PNW, i.e. an application, in proximity.

8.2 Fast Inter-P2PNWs Channel Accessing Procedure

CCDCH: contention based accessing by all the peers in proximity for Inter-P2PNWs communications

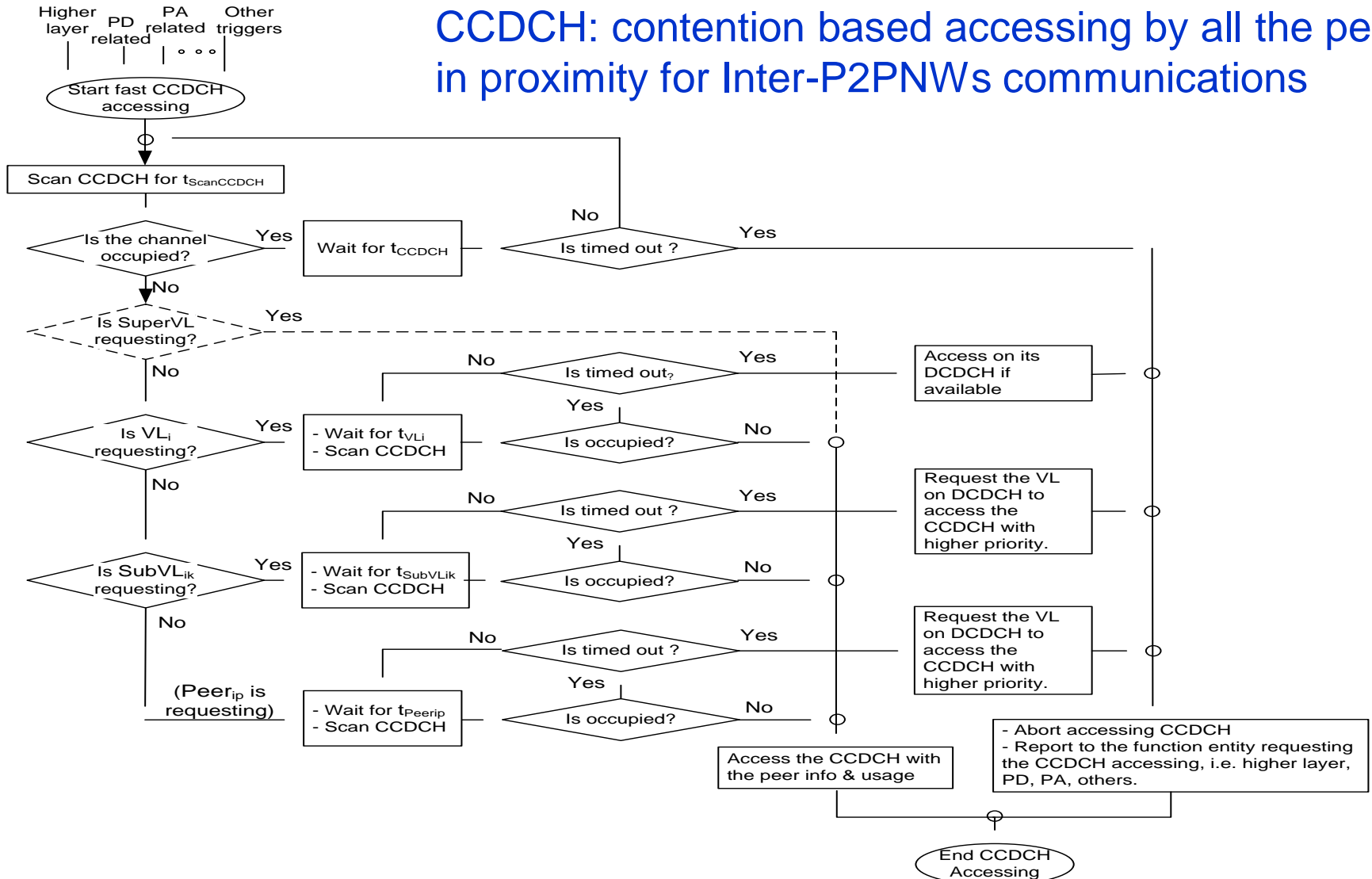

8.3 Fast Intra-P2PNW Channel Accessing Procedure

DCDCH: contention based accessing by all the peers in proximity for Intra-P2PNW communications

Higher layer related triggers
 PD related triggers
 PA related triggers
 Other triggers

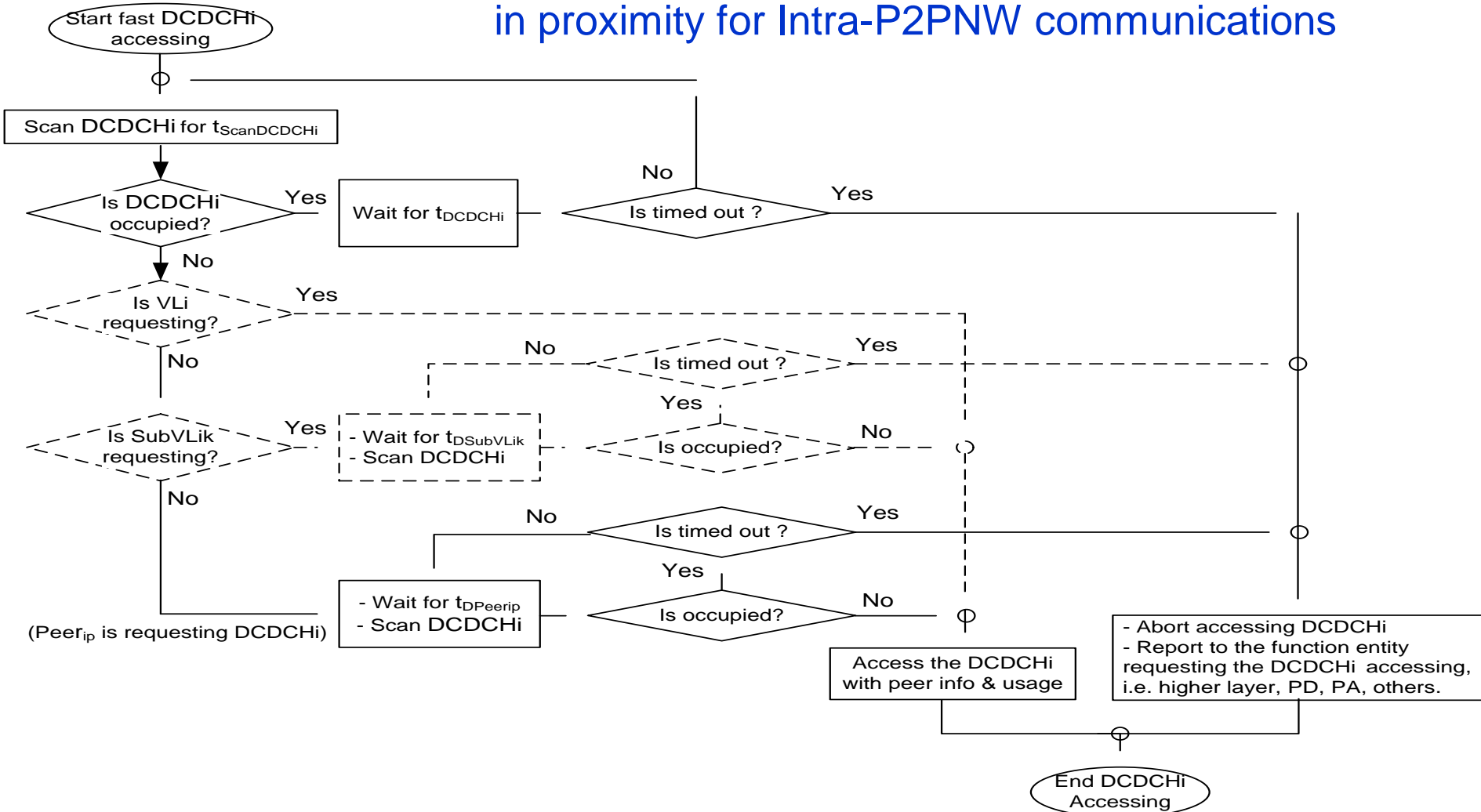

8.4 Inter-P2PNWs CA with P2PNW Detection

Virtually Centralized Control

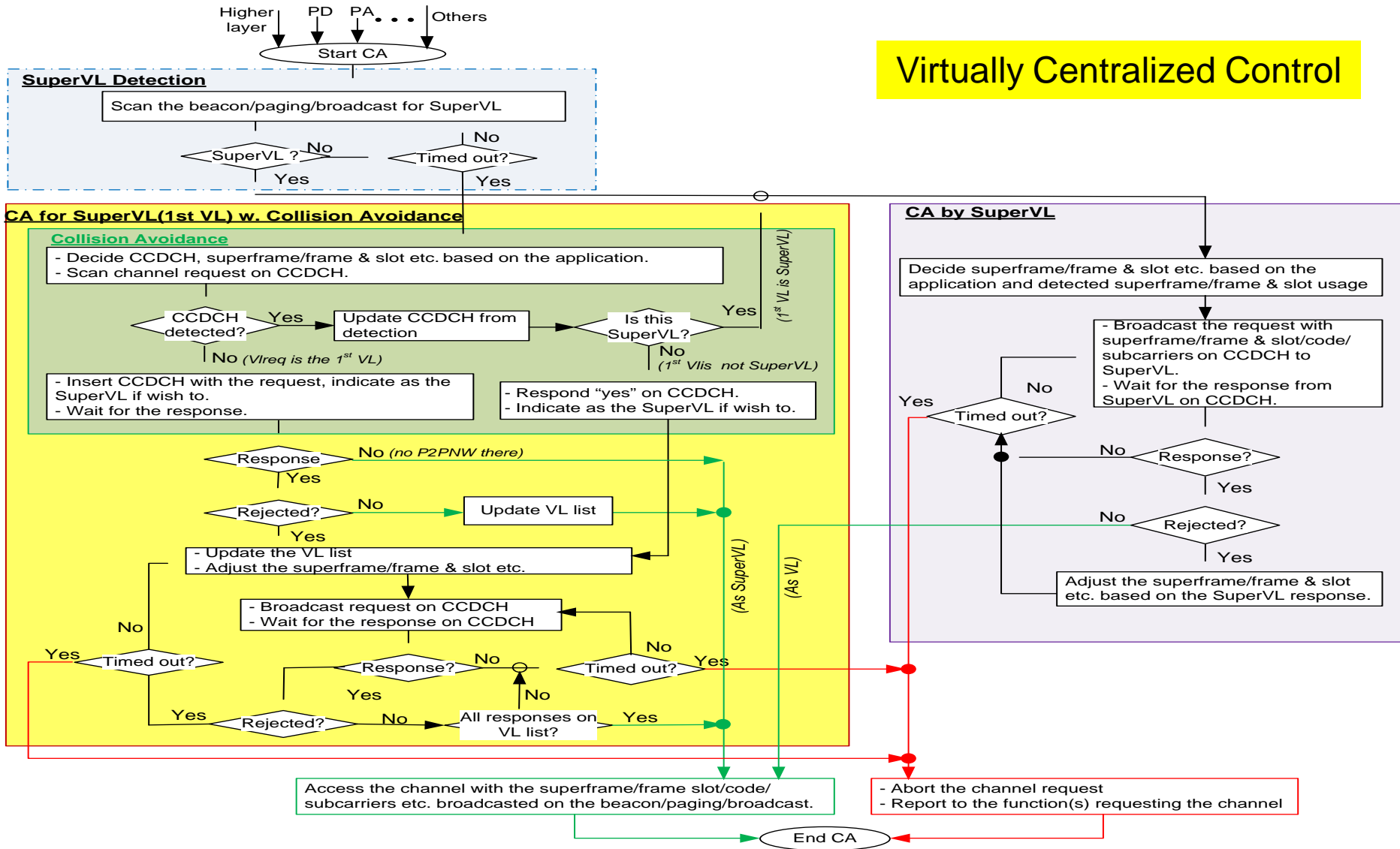

8.5 Intra-P2PNW CA with Peer Cooperation

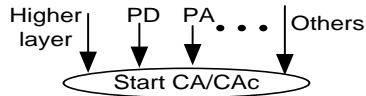

Peer Detection

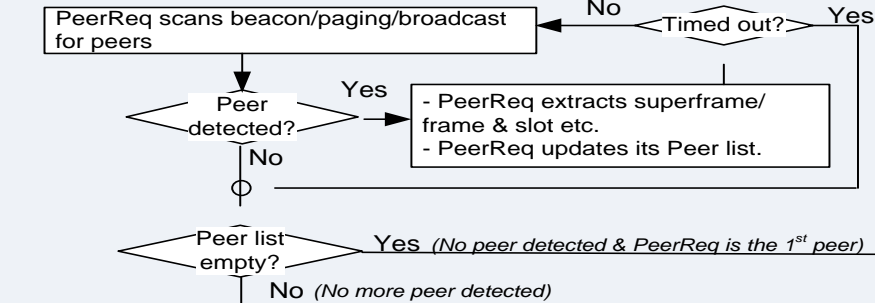

CA for a New Peer

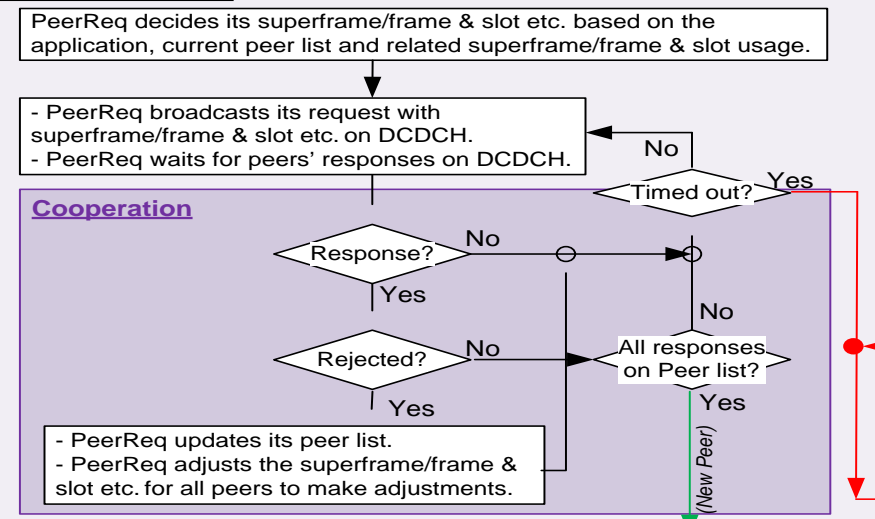

- For CA: PeerReq accesses the channel with its superframe/frame slot etc. broadcasted on the beacon/paging/broadcast.
- For Cac: PeerReq accesses the channel granted.

CA for 1st Peer w. Collision Avoidance

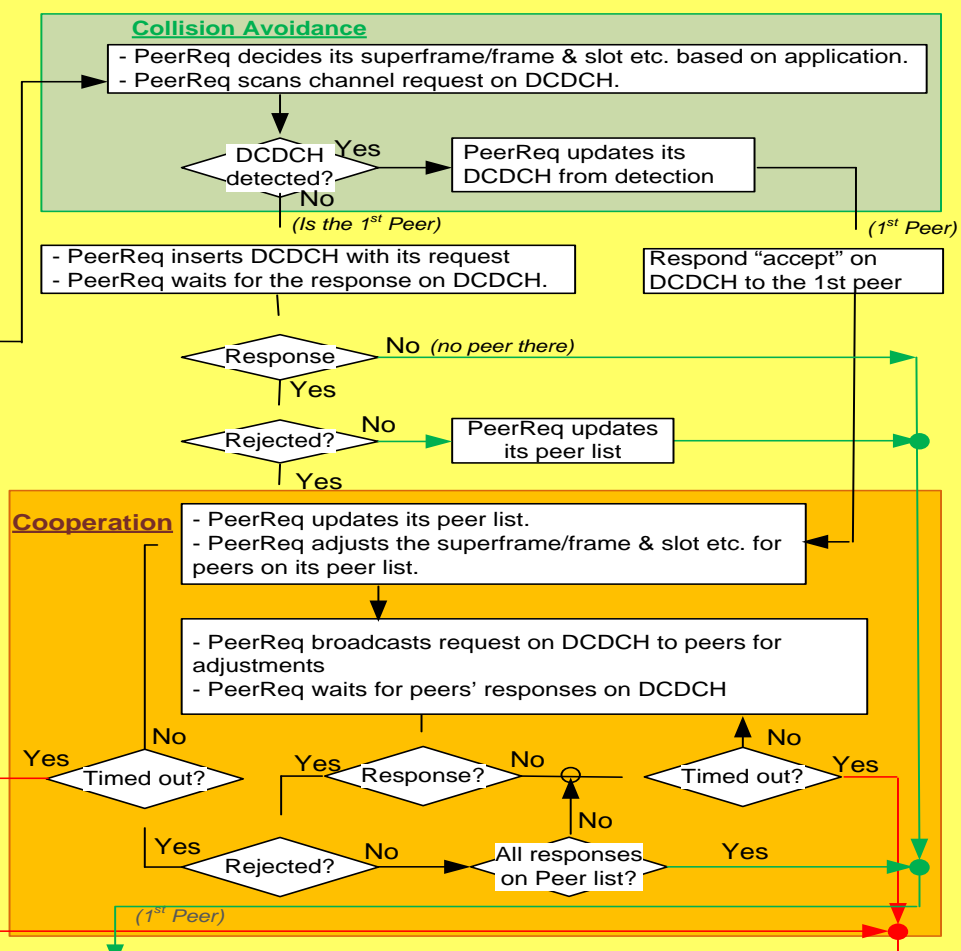

- PeerReq aborts its CA/Cac
- PeerReq reports to the function(s) requesting the CA/Cac

End CA/Cac

Distributed Control

9. Context-aware Reliable Multicast/Broadcast

9. Context-aware Reliable Multicast/Broadcast

- Excerpts from IEEE 802.15.8 TGD [1]
 - 6.9 Multicast: “IEEE 802.15.8 may support a reliable multicast transmission including both one-hop and multi-hop cases.”
 - 6.10 Broadcast: “IEEE 802.15.8 shall support a broadcast transmission including both one-hop and multi-hop cases”
 - 6.11 Multi-hop support: “IEEE 802.15.8 shall provide at least 2-hop relaying function.”, “Only relay-enabled PD shall relay discovery messages and/or traffic data from PDs in the proximity”
- Motivation
 - There are many multicast/broadcast PAC use cases as described in Application Matrix.
 - PAC multicast/broadcast needs to be reliable and efficient.
- Proposals
 - 9.1 Terms and Concepts
 - 9.2 Context-Aware MAC Multicast/Broadcast Architecture
 - 9.3 MAC Multicast/Broadcast Addressing
 - 9.4 Context-Aware MAC Multicast/Broadcast Group Management
 - 9.5 Context-Aware Flexible Multicast/Broadcast Reliability
 - 9.6 MAC Payload and IEs for Multicast/Broadcast

9.1. Terms and Concepts

- **Multicast/Broadcast**
 - One PD transmits data to multiple or all PDs within the same proximity.
- **Reliable Multicast/Broadcast**
 - To provide reliable data transmission in multicast/broadcast from one PD to multiple or all PDs with the same proximity.
- **Flexible Multicast/Broadcast Reliability**
 - Reliable multicast/broadcast data transmission is not required for all receivers/destination, rather some selected receivers/destination based on different criteria.

9.2. Context-Aware MAC Multicast/Broadcast Architecture

- MAC Multicast Control Functions (MMCF): MMCF is responsible to control and manage MAC multicast/broadcast.
- MAC Multicast Data Functions (MMDF): MMDF is responsible to transmit, forward, retransmit MAC frames. It interfaces with and can be invoked by the higher layers, MMCF, and other MAC functions.

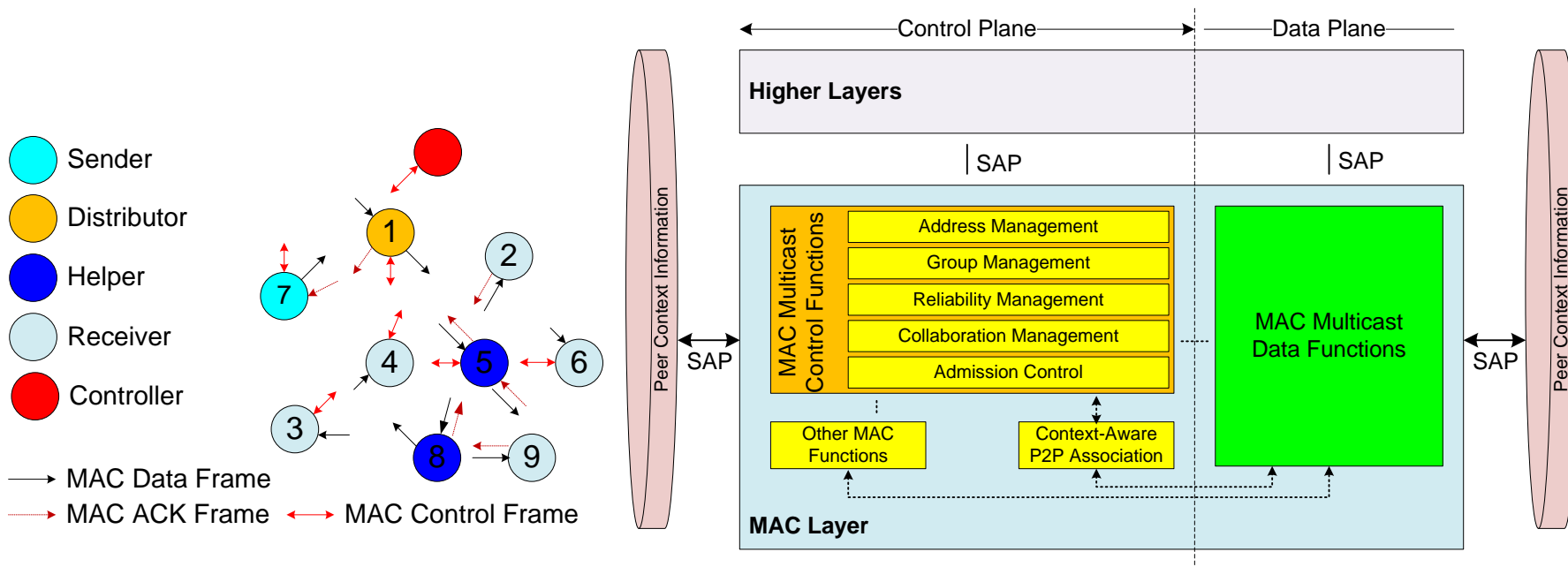

9.3. MAC Multicast/Broadcast Addressing

- **Approach 1:** use the combination of “MAC Broadcast Address” and “Group ID” to address the group of receivers.
 - The “Group ID” could be an application ID, a location-dependent ID, an allocated locally unique ID, or a combination of them, which can be assigned during peer association procedure
- **Approach 2:** use the combination of multiple “Unicast Address” and “Group ID”
- **Approach 3:** To allocate a pool of MAC addresses and standard it to be used for MAC multicast purpose

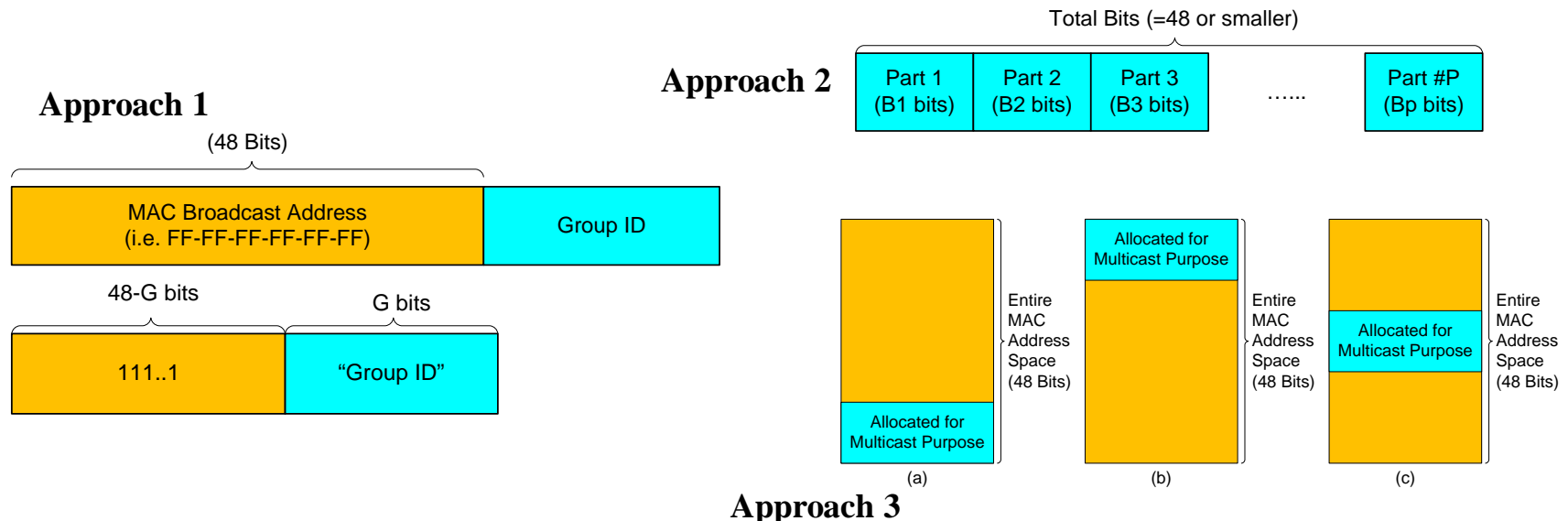

9.4. Context-Aware MAC Multicast/Broadcast Group Management

- Group Establishment: Form a multicast/broadcast distribution tree.
 - Context-aware fast association procedures are leveraged for group establishment.
- Group Update: Join or leave the established group.
 - Context-aware peer association procedures are leveraged for group update
- Receiver Management: Adjust the receiver scope. For example,
 - Scenario 1: the sender does not specify the receivers → Peer Selection
 - Intermediary nodes select peers as receiver based on their context information. For example, all peers at a physical location, all peers with the same or similar device profile, etc.
 - Scenario 2: the sender indicates the receivers → Receiver Scope Control
 - The sender controls how far a MAC frame is to be multicast/broadcast. It can be decided with context-awareness.

9.5. Context-Aware Flexible Multicast/Broadcast Reliability

- Sender: indicates “ACK Type” in each MAC data frame.
- Receivers: performs different acknowledgement according to “ACK Type”
- Example of “ACK Type”
 - Type 1 - Full ACK: All members/peers need to send ACK.
 - Type 2 - Partial ACK: Only a portion of peers sends ACK.
 - Type 3 - Any ACK: ACK is only required from any one of members/peers.
 - Type 4 - Location-based ACK: Only peers around a specific location sends ACK.

→ More Efficient Reliability Guarantee

9.6. MAC Payload and IEs for Multicast/Broadcast

New IE for Reliable Multicast/Broadcast

IE Identifier	IE Length	Hash (Group ID or App ID or VL ID)	Receiver Location	ACK Type	Expiration Time	Multicast/Broadcast Scope	Maximum Retries	ACK Order	ACK Transmission Behavior	Forward Flag
---------------	-----------	------------------------------------	-------------------	----------	-----------------	---------------------------	-----------------	-----------	---------------------------	--------------

New IE (Contained in Multicast/Broadcast Data Frame)

MAC Multicast/Broadcast ACK Frame

Hash (Group ID or App ID or VL ID)	Help Willingness	List of Buffered Data	Traffic Load	List of Neighbors	Other Fields ...
------------------------------------	------------------	-----------------------	--------------	-------------------	------------------

Aggregated MAC Multicast/Broadcast ACK Format

Hash (Group ID or App ID or VL ID)	Multicast Source Addr	Success/Failure Flag	List of Successful or Failed Receivers	Other Fields ...
------------------------------------	-----------------------	----------------------	--	------------------

MAC Payload of Multicast/Broadcast ACK Frame

10. Context-aware Power Control Procedures

10. Context-aware Power Control Procedures

- Excerpt from IEEE 802.15.8 TGD [1]
 - 6.7 Interference Management: IEEE 802.15.8 shall provide the functionality to mitigate interference from other PDs.
 - 6.8 Transmit Power Control: IEEE 802.15.8 shall support the functionality for PDs to control the transmit power to minimize interference and power consumption.
- Motivation:
 - Different P2PNWs require different power control schemes, **therefore service-aware or context-aware power control is essential to ensure the QoS required by a specific service**
 - Many P2PNWs coexist within a short radio range of each other without a central controller to manage the transmission power among and within the P2PNWs. To minimize the interference, **inter-P2PNWs power control is required in addition to intra-P2PNW power control.**
- Proposal:
 - 8.1 Terms and Concepts
 - 8.2 Examples of CPCI Usage
 - 8.3 Context-aware Power Control

10.1 Terms and Concepts

■ Context and Power Control Information (CPCI)

– Proximity Service Based **Context Information**

- **Service Power Category (SPcat)**: classified according to the power control requirements
- **Service Range (SerR)**: the typical service radio range for a P2PNW.
- **Power Control Interval (PCInt)**: the time period for updating or exchanging CPCI & transmit power level..
- **Bandwidth (BW)**: the bandwidth or subcarriers allocated for a peer in a P2PNW.
- **Data Rate (DR)**: the typical data rate for a proximity service.
- **Modulation and Coding Scheme (MCS)**: the modulation and coding used for a proximity service.
- **Latency(Lat)**: the delay tolerance for a proximity service.
- **Location (Loc)**: the location of a peer for a proximity service. This can be used to estimate the path loss.
- **Speed (Sd)**: typical speed of a peer for a proximity service. It can be used to define PCInt.

– Proximity Service Based **Power Control Information**

- **Transmit Power (TxP)**: the power level of a transmission during a PCInt from a transmitter.
- **Maximum Transmit Power (MaxTxP)**: maximum power level allowed for transmission.
- **Minimum Transmit Power (MinTxP)**: minimum power level required for transmission.
- **Power Adjustment (PAdj)**: power adjustment for initial or open loop context-aware power control.
- **Endpoint (EP)**: the receiver of a transmission within a P2PNW.
- **Path Loss (PL)**: the attenuation or propagation loss through the wireless channel.
- **Received Signal Quality (RxSQ)**: the received signal quality may be indicated by the measured Received Signal Strength Indicator (RSSI), received Signal Interference Noise Ratio (SINR), or Channel Quality Indicator (CQI), etc.

10.2 Examples of CPCI Usage

CPCI in Beacon:

CPCI is inserted in the beacon and can be detected and extracted by a peer in the proximity.

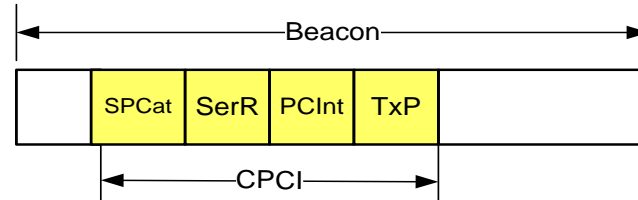

CPCI on Common Control/Data Channel:

CPCI is broadcasted on a common control or data channel to be detected and used for collaborating power control among the peers in proximity.

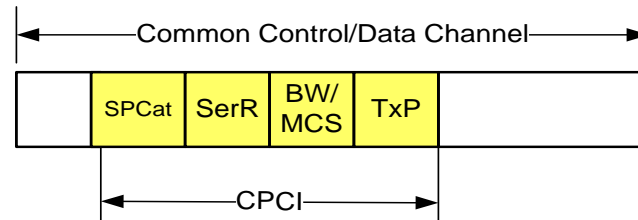

CPCI in a Transmission Frame:

CPCI is transmitted with control information for Point-to-Multipoints power control request, or with data information for initial or open loop power control from a multicast transmitter.

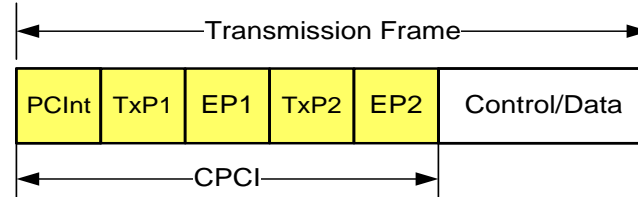

CPCI in a Transmission Frame:

CPCI is transmitted with control information for power control response, or with data information for closed loop power control with required power adjustment from a receiver.

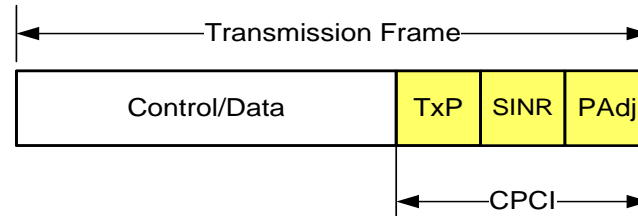

Note

The exact location of CPCI may vary depending on the specification or implementation of CPCI for context-aware power control.

10.3.1 Context-aware Power Control Procedure



Peer1 starts TPC for App_i

CPCI Detection in Proximity

1. Receive CPCI_{AppiPr1} from the higher layer.
2. Extract CPCI from beacon/paging/common channel.
3. Collect measured RxSQ_{ProS} corresponding to CPCI_{ProS}.
4. Update the list of CPCIs in proximity CPCI_{ProS}.

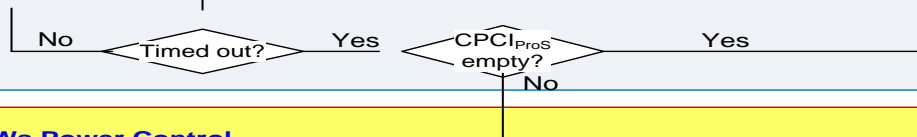

Inter-P2PNWs Power Control

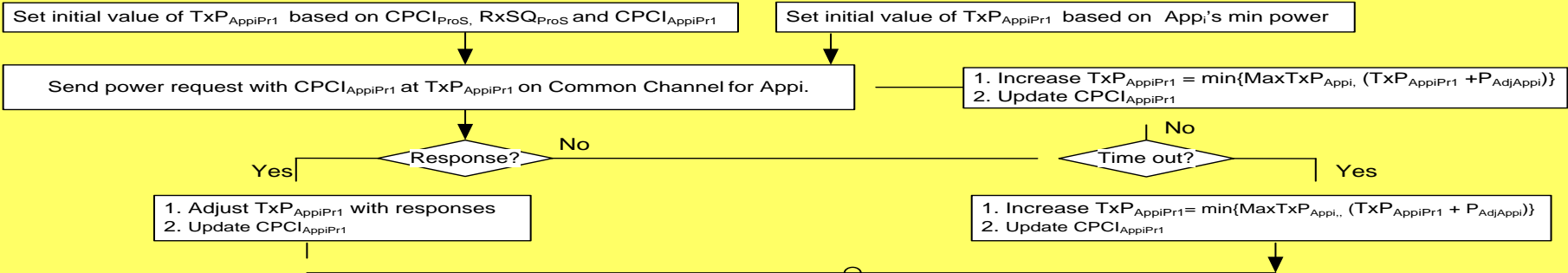

Intra-P2PNW Power Control

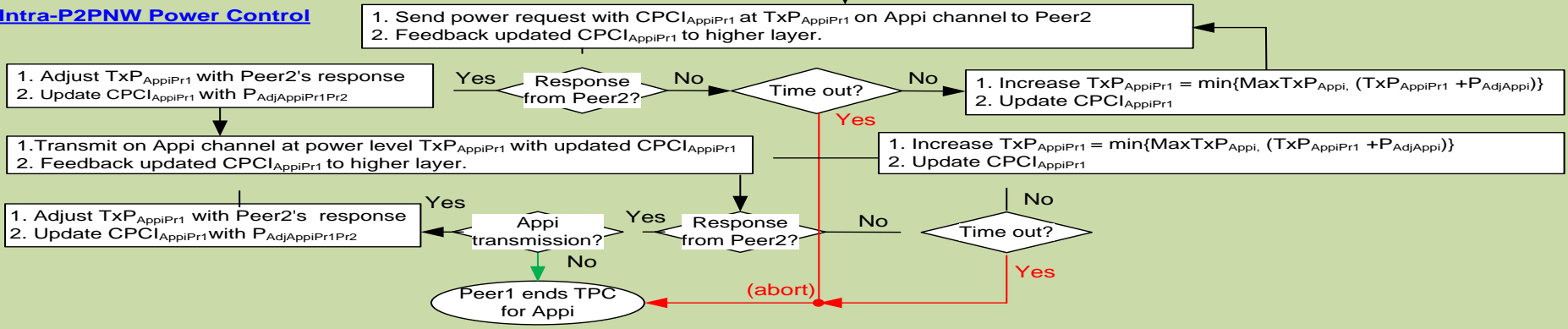

10.3.2 Context-aware Power Control Call Flow

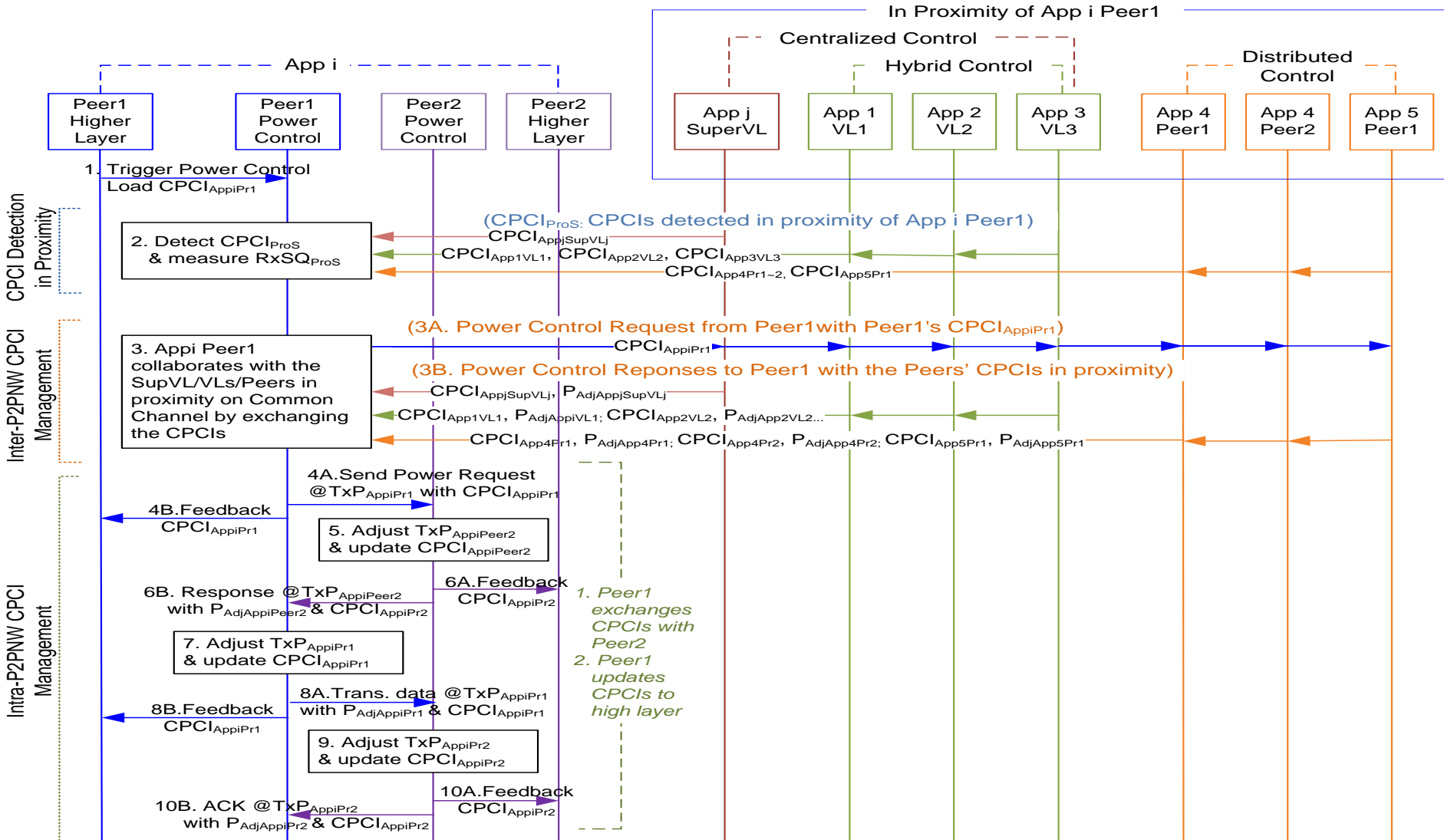

11. Cross-Layer and Cross-Application ACK

11. Cross-Layer and Cross-Application ACK

- Excerpts from IEEE 802.15.8 TGD [1]
 - 6.17 Requirements for high layer and infrastructure interaction: “*IEEE 802.15.8 may be able to interact with higher layers to access suitable infrastructure, if it exists, e.g. to facilitate the set up and maintenance of communication*”, “*IEEE 802.15.8 shall perform measurements at the request of and report the results to higher layers. These measurements may include received signal strength and interference levels*”
 - 7.7 System overhead: “*Overhead, including overhead for control signaling as well as overhead related to data communications shall be reduced as far as feasible without compromising overall performance and ensuring proper support of systems features*”
- Motivation
 - MAC layer has retransmission and higher layer has retransmission mechanisms as well, but both are independent.
 - To coordinate and optimize MAC-layer (re-)transmission and higher-layer (re-)transmission mechanisms for multiple applications can reduce system overhead and in turn improve system performance
- Proposals
 - 11.1 Terms and Concepts
 - 11.2 One-Hop Cross-Layer ACK
 - 11.3 Streamlined Cross-Layer ACK
 - 11.4 Cross-Application ACK

11.1. Terms and Concepts

- Acknowledge (ACK) Message: the receiver sends ACK to the sender to confirm the receipt a previous data message
 - MAC-Layer ACK: There is ACK in MAC protocols to guarantee reliable one-hop data transmission and provide one-hop reliable link
 - Application-Layer ACK: There is ACK in high layers protocols to guarantee end-to-end data transmission between the source and the destination

11.2. One-Hop Cross-Layer ACK

- The New MAC ACK (i.e. Integrated MAC ACK) contains not only the normal MAC ACK but also the application ACK. In other words, the Integrated MAC ACK serves two purposes simultaneously:
 - To acknowledge the previous MAC data frame from the sender to the receiver
 - To acknowledge the application data contained in the previous MAC data frame

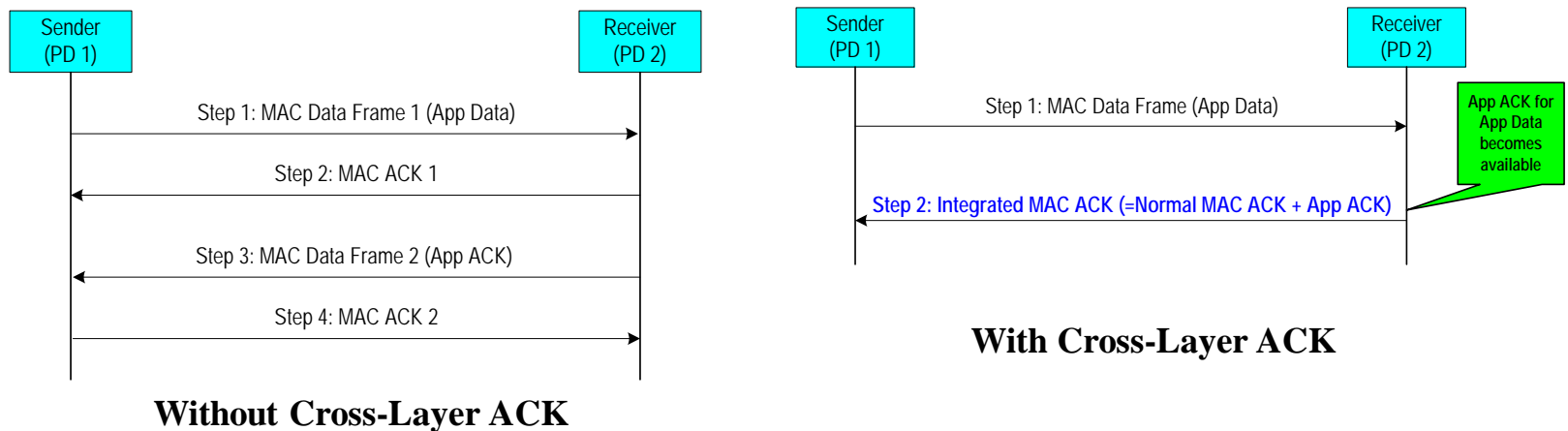

11.3. Streamline Cross-Layer ACK

- **Basic Idea:** An MAC ACK piggyback App ACK for previous application data, which is transmitted in previous MAC data frames.
- **Benefits:** It can reduce the potential long latency in waiting for App ACK as shown in One-Hop Cross-Layer ACK

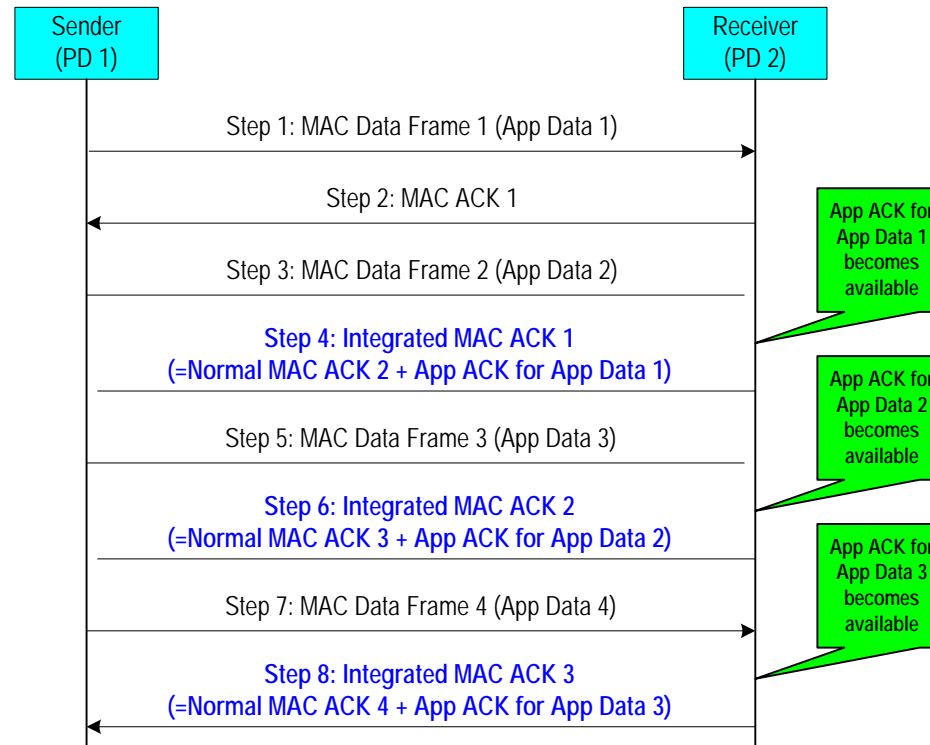

11.4. Cross-Application ACK

- An MAC Data Frame can piggyback App ACK for multiple application.
 - In other word, MAC Data Frame for App 1 can be leveraged to transmit App ACK for another application.

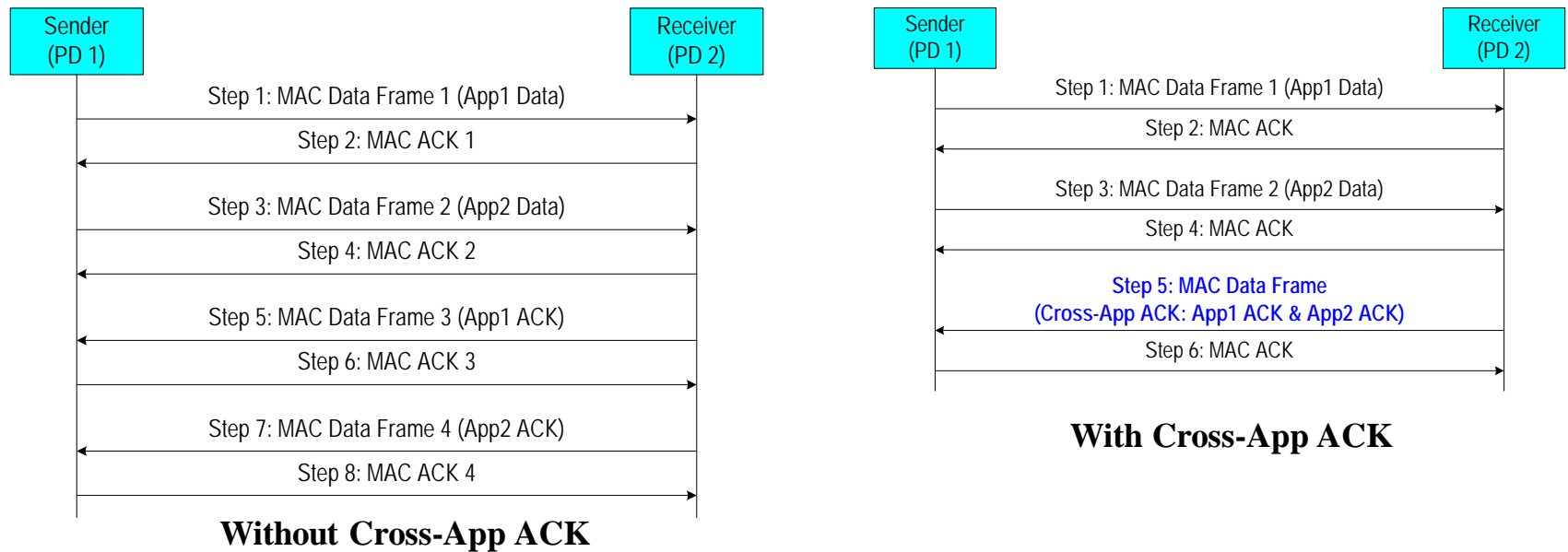

12. Conclusion

A system design is proposed for infrastructure-less P2P communications

- Context-aware
 - Context-aware Management
 - Context-aware Fast Discovery
 - Context-aware Fast Association/Disassociation/Re-association
 - Context-aware Synchronization
 - Context-aware Power Control
 - Context-aware Cross-Layer and Cross-Application ACK
- Infrastructure-less
 - Channel Management / Accessing based on Peer Detection
 - Channel Management / Accessing based on Peer Cooperation
- Group Communication
 - Reliable multicast/broadcast transmission

13. References

- [1] IEEE 802.15.8 Technical Guidance Document
- [2] IEEE 802.15.8 Application Matrix
- [3] PAC PAR
- [4] PAC 5C

Thank You!

Any Questions?

→ Qing.Li@InterDigital.com

14. Backup Slides

2. System Architecture: Logic Functions

Higher Layer: the layer above PHY/MAC, such as service or application layer for an infrastructure-less P2P wireless system.

Context Management Function: manages context information across PHY/MAC and higher layer for context-aware P2P communications.

General Scan Function: scans the beacon, preamble, paging, and/or broad casting channel with context category, context ID, and/or context information. Extracts information for synchronization, peer discovery, channel management, power control, measurements, and/or other functions.

Synchronization Function: performs context-aware initial or periodic time synchronization with superframes, frames, and/or time slots; maintains frequency and/or phase synchronization.

Discovery Function: discovers peer(s) in proximity by using context category, context ID, and/or peer context information; sends messages with context category, context ID, and/or peer context information for to-be-discovered in proximity.

Association Function: requests or responds to association, association updates, disassociation, or re-association by using context ID, and/ or peer context information.

2. System Architecture: Logic Functions (cont.)

Channel Management Function: manages the radio resource or channel allocation among P2P networks based on the context, i.e. services or applications; manages channel accessing within a P2P network based on the peer context information.

Power Control Function: performs transmitting power control and interference management based on context and power control information.

Data Transceiving Function: conducts context-aware reliable data transmitting and/or receiving based on the QoS required by service or application.

Measurement and Report Function: conducts measurements of channel, QoS, etc., and sends data reports from other logic functions to higher layer.

2. System Architecture: Example of Context Information

Context	Logic Functions
Context Category (i.e. emergency, social networking, smart office, etc.)	General Scan, Discovery, Synchronization, Association, etc.
Context ID (i.e. Facebook, NetFlix, GoToMeeting, etc.)	General Scan, Discovery, Synchronization, etc
User / Device Info (i.e. user /device ID, user / device profile, etc.)	Discovery, Synchronization, Association, Power Control, etc.
Service / Application Info (i.e. QoS requirements, required min. peers for a gaming, multi-hop for extending the service range, etc.)	Channel Management, Discovery, Association, etc.
Power Control Info (i.e. Power Category, Max./ Min. Power, Power Control Interval, etc.)	General Scan, Power Control, Measurements, etc.
QoS Info (i.e. data rate, latency, priority, etc.)	Channel Management , Power Control, Data Transceiving, Measurements, etc.
Others (i.e. location, speed, channel, etc.)	General Scan, Channel Management, Discovery, Synchronization, Association, Power Control, Measurements, etc.

2. System Architecture: Example of Measurements and Reports

Measurement / Report	Logic Functions
Channel condition (i.e. SINR, Received Signal Strength, Channel Quality Indicator, etc)	Measurements, Power Control, etc.
QoS (i.e. data rate, error rate, etc.)	Data Transceiving
Channel status (i.e. allocation, usage, etc)	Channel Management, etc
Synchronization results (i.e. success, failure, time or frequency offset, etc.)	Synchronization
Discovery results (i.e. peer candidates, P2P network(s) detected in proximity, etc.)	Discovery
Association results (i.e. association log, association successful rate, etc.)	Association
Power Control Info (i.e. Max. / Min. transmitting power, averaged transmitting power, power adjustment, etc.)	Power Control

3. Frame Structure: Beacon Subtype

Frame Type	Frame Subtype		Description
	Discovery Bit	Beacon Subtype	
0: Beacon	0: not for discovery 1: for discovery	0: super beacon	<ul style="list-style-type: none"> •Sent by SuperVL under virtually centralized control •Define a new superframe
		1: application beacon	<ul style="list-style-type: none"> •Sent by VL under virtually centralized control or hybrid control •Define a new application frame.
		2: common beacon	<ul style="list-style-type: none"> •Sent by VL under hybrid control •Define a new super frame
		3: peer beacon	<ul style="list-style-type: none"> •Sent by any peer under distributed control •Carry application information for discovery
		4: common peer beacon	<ul style="list-style-type: none"> •Sent by a peer under distributed control to define a new super frame
		5: dedicate application beacon	<ul style="list-style-type: none"> •Sent by a peer under distributed control to define a new application frame
		6-7: reserved	<ul style="list-style-type: none"> •reserved

Beacon type could be uniquely mapped to the control scheme and role of the sender (i.e., superVL, VL or peer)

3. Frame Structure: Management Frames

Management frames are designed to facilitate the information exchange for several MAC functionalities, such as context-aware power control, context-aware association, context-aware channel management.

Frame Type	Frame Subtype	Transmitted on Which Channel or Period
1: Management	0:Association request	DCDCH, CFP
	1: Association response	
	2:Re-association request	
	3:Re-association response	
	4:Disassociation request	
	5:Disassociation response	
	6:Association update notification	
	7:Association update response	CCDCH, DCDCH
	8:Power control request	
	9:Power control response	CCDCH
	10:Inter-P2PNWs channel allocation request	
	11:Inter-P2PNWs channel allocation response	
	12:Intra-P2PNWs channel allocation request	DCDCH
	13:Intra-P2PNWs channel allocation response	
	14-15: Reserved	NA

3. Frame Structure: Context Information IE

- Context information IE includes the application information of a peer, and could be carried by any frame.

Field	Description	Mandatory/Option
IE identifier	Identify the type of IE	M
IE length	Indicate the total length of the IE	M
Context category	Context category indicates the application/service category, such as emergency service, social networking, smart office, etc.	O
App ID/ Device ID/ User ID	indicate the identifier of context according to the type of applications, such as service-based, device-based or user-based	O
App/Device/User parameters	Indicate more specific context information. For example, the price and discount information for advertisement service; game skill level information for a game	O