

Project: IEEE P802.15 Working Group for Wireless Personal Area Networks(WPANs)

Submission Title: OFDM PHY Merge Proposal for TG4m

Date Submitted: September 13, 2012

Source: Soo-Young Chang (CSUS), Cheol-ho Shin , Mi-Kyung Oh and Sangsung Choi (ETRI), Hiroshi Harada, Fumihide Kojima, Ryuhei Funada, Alina Lu Liru, Ming-Tuo Zhou, Zhou Lan, Chin-Sean Sum(NICT), Cristina Seibert (SSN), Jeritt Kent (ADI), Khurram Waheed (Freescale), Shigenobu Sasaki, Takuya Inoko, Yutaro Fukaishi, Hiromu Niwano and Bingxuan Zhao (Niigata University)

Contact: Soo-Young Chang (sychang@ecs.csus.edu)

Voice: 530 574 2741 (USA), E-Mail: sychang@ecs.csus.edu

Re: All proposals presented in July 2012 and contributions for merge efforts for OFDM PHY

Abstract: This contribution presents a merge proposal for the TG4m OFDM with the efforts from all OFDM proposers . The scope of this work does not include narrow band OFDM , which will be presented by another group.

Purpose: Final baseline document in OFDM area to 802.15m

Notice: This document has been prepared to assist the IEEE P802.15. It is offered as a basis for discussion and is not binding on the contributing individual(s) or organization(s). The material in this document is subject to change in form and content after further study. The contributor(s) reserve(s) the right to add, amend or withdraw material contained herein.

Release: The contributor acknowledges and accepts that this contribution becomes the property of IEEE and may be made publicly available by P802.15.

CONTENTS

- Introduction
 - Introduction
 - Requirements for TVWS
- Summary of merged OFDM proposal
 - Key parameters and data rates
 - Pilot and null tone pattern
 - OFDM symbol structure
 - OFDM PPDU format
 - STF of OFDM PPDU
 - LTF of OFDM PPDU
- PHY header fields (PHR)
- Tail bit field (TAIL)
- Pad bit field (PAD)
- Reference modulator diagram
- Bit-to-symbol mapping
- Forward error correction (FEC)
- Scrambler
- Pulse shaping
- Conclusion
 - Conclusion

INTRODUCTION

INTRODUCTION

- Goal of this work
 - To specify key components and their parametric values for TG4m OFDM PHY baseline proposal.
- In this document, key parameters and features for TVWS OFDM PHY baseline are identified
 - By merging four proposals so far presented.
 - The merged text draft was uploaded: 15-12-0xxx-00
- Proposals considered to prepare this document are:
 1. 15-12-0332-03-004m-etri-ofdm-phy-proposal-for-tg4m, ETRI OFDM proposal,
 2. 15-12-0336-02-004m-full-proposal-on-phy-and-mac-for-ieee-802-15-4m-by-nict, NICT proposal,
 3. 15-12-0338-00-004m-phy-proposal-for-tg4m, Silver Spring Networks PHY proposal, and
 4. 15-12-0340-01-004m-phy-proposal-for-the-ieee-802-15-4m-by-niigata-univ, Niigata University PHY proposal.

REQUIREMENTS FOR TVWS

- Operations in TVWS frequency bands under regulatory constraints:
 - Meet at least one, and as many as practical, TV White Space regulatory requirements.
- Data rate of typically 40Kbps to 2Mbps & optionally 10Mbps
- Optimal & power efficient device command & control applications
- Operating range of at least 1Km
- At least 1000 direct neighboring devices operated
- Opportunistic coexistence with primary users (TV broadcasting): not interfere with other primary users

SUMMARY OF MERGED OFDM PROPOSAL

KEY PARAMETERS AND DATA RATES

Description	Mandatory mode	Optional mode (4 times overclock mode)
Nominal bandwidth (kHz)	1064.5	4258
Channel spacing (kHz)	1250	4*1250
Subcarrier spacing (kHz)	1250/128	4*1250/128
DFT Size	128	128
Number of pilot tones	8	8
Number of data tones	100	100
BPSK ½ rate	390.625: MCS0 Mode	1562.5: MCS3 Mode
QPSK ½ rate	781.250: MCS1 Mode	3125: MCS4 Mode
16-QAM ½ rate	1562.5: MCS2 Mode	6250: MCS5 Mode

* Baseline for narrowband OFDM PHY for 400kHz bandwidth is being prepared and will be presented by another group led by Harada San (NICT).

PILOT AND NULL TONE PATTERN

- 128 IFFT: (**100 data** + **8 pilot** + **19 guard** + **1 DC**) tones

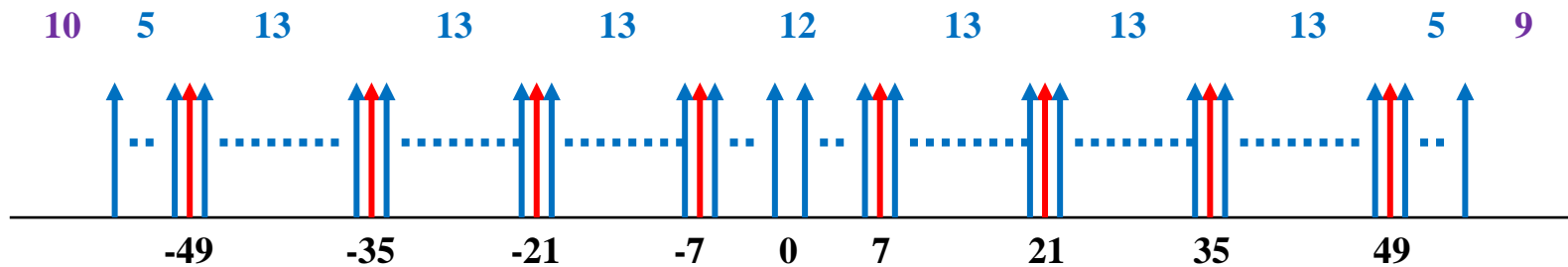

- The data carried on the pilot tones shall be determined by a pseudo-noise sequence PN9 with the seed “11111111”.

Mapping from PN9 sequence to pilot BPSK symbols

Input bit (PN _{9,n})	BPSK symbol
0	$-1 + (0 \times j)$
1	$1 + (0 \times j)$

OFDM SYMBOL STRUCTURE

- Cyclic prefix (CP)
 - 1/4 of the base symbol

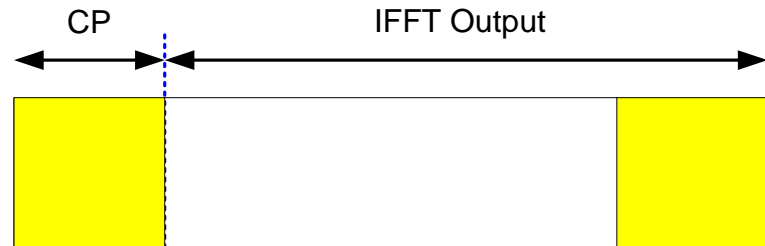

- Structure of OFDM Symbol
 - Except for STF and LTF

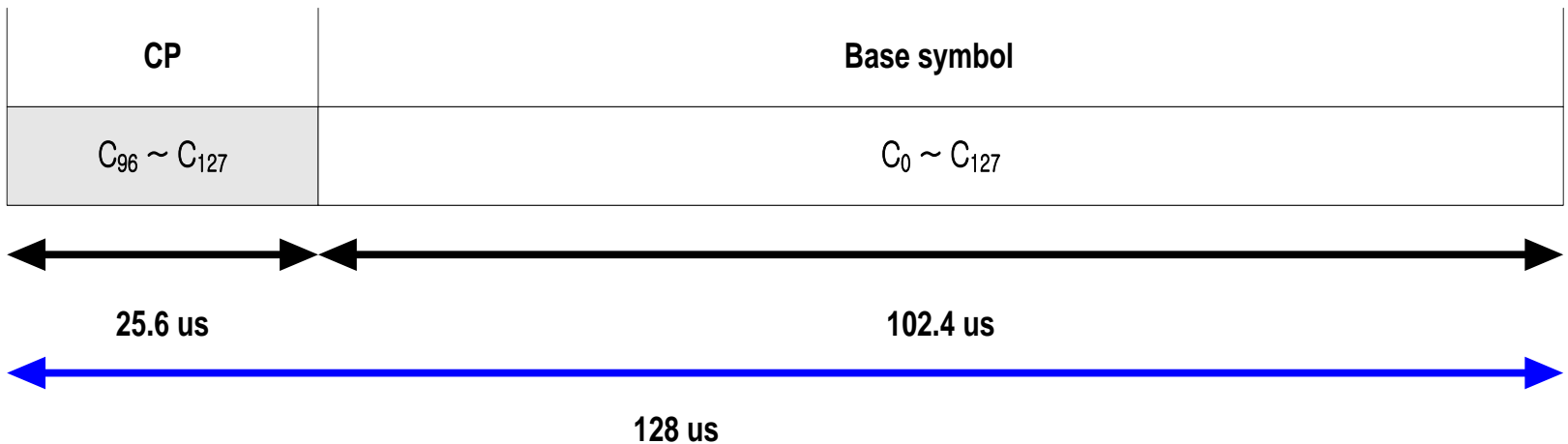

OFDM PDU FORMAT

Number of OFDM symbols					
Variable (1 – 4)	2	1	Variable	6 bit	Variable
STF	LTF	PHR	PSDU	TAIL	PAD
SHR		PHY Header	PHY payload		

STF OF OFDM PPDU (2)

- Time domain STF generation
 - Given a sequence of 128 samples $f(n)$, indexed by $n=0, \dots, 127$, the discrete Fourier transform (DFT) is defined as $F(k)$, where $k=0, \dots, 127$:

$$F(k) = \frac{1}{\sqrt{128}} \sum_{n=0}^{127} f(n) e^{-j2\pi kn/128}$$

- The sequence $f(n)$ can be calculated from $F(k)$ using the inverse discrete Fourier transform (IDFT), where the k values numbered from 0 to 63 correspond to tones numbered from 0 to 63 and the k values numbered from 64 to 127 correspond to tones numbered from -64 to -1, respectively:

$$f(n) = \frac{1}{\sqrt{128}} \sum_{k=0}^{127} F(k) e^{j2\pi nk/128}$$

- The time domain STF is obtained as follows:

$$\text{STF}_{\text{time}} = \text{IDFT}(\text{STF}_{\text{freq}})$$

- The CP is then prepended to the OFDM symbol.

STF OF OFDM PPDU (3)

- Time domain STF repetition
 - The STF is repeated eight times per STF symbol and the CP is also 1/4 symbol. Therefore, there are **10 repetitions of 1/8 STF symbol in each STF OFDM symbol**. The number of STF OFDM symbols varies from 1 to 4.

Each "s" represents one time-domain repetition of a subsequence of TVWS-OFDM.

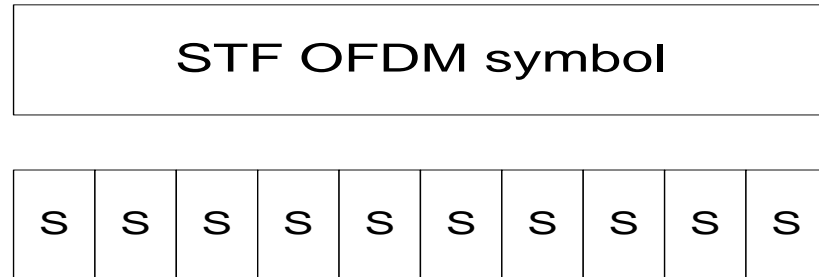

- STF power boosting
 - Power boosting shall be applied to the STF OFDM symbols in order to aid preamble detection, The boost should be a multiplication by **TBD**.

LTF OF OFDM PPDU

- Frequency domain LTF: **TBD**
- Time domain LTF generation
 - The time domain LTF is obtained as follows:
$$\text{LTF}_{\text{time}} = \text{IDFT}(\text{LTF}_{\text{freq}})$$
 - A 1/2 symbol CP is prepended to two consecutive copies of the base symbol.
 - T_{DFT} is the duration of the base symbol.

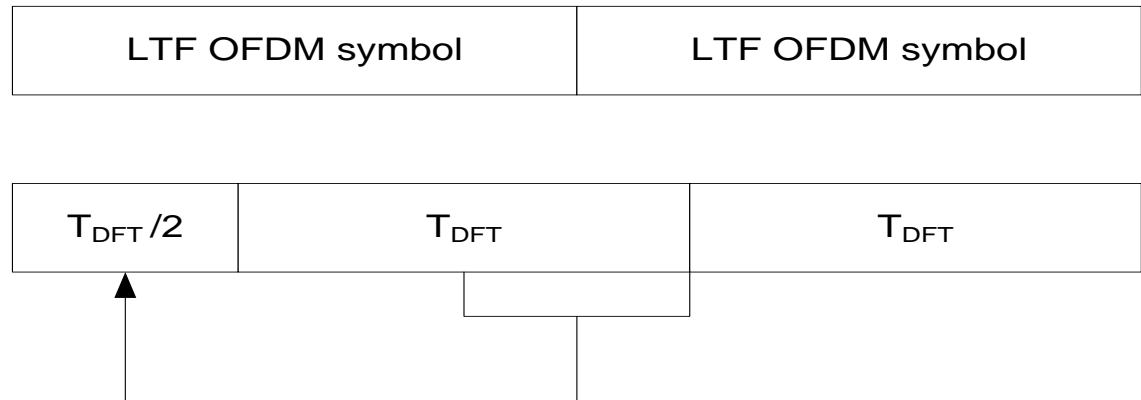

PHY HEADER FIELDS (PHR) (1)

Bit string index	0-5	6-7	8-18	19-27	28-43	44-49
Bit mapping	R_5-R_0	RA_1-RA_0	$L_{10}-L_0$	S_8-S_0	$H_{15}-H_0$	T_5-T_0
Field name	Reserved	Rate	Frame Length	Scrambling seed	HCS	Tail

- The PHR occupies one OFDM symbol.
- The PHR shall be transmitted using the lowest supported modulation and coding scheme (MCS) level, MCS0 mode.
- It is sent directly to the convolutional encoder without being scrambled.
- Rate field (RA_1-RA_0):
 - Data rate of the payload
 - 00: MCS0 or MCS3, 01: MCS1 or MCS4, 10: MCS2 or MCS5
- Scrambler Seed field (S_8-S_0):
 - The scrambling seed used to scramble the PHY payload (PSDU) of that packet

PHY HEADER FIELDS (PHR) (2)

- Frame Length field (L_{10} - L_0):
 - Total number of octets contained in the PSDU (prior to FEC encoding)
- Header Check Sequence (HCS) field (H_{15} - H_0)
 - 16-bit CRC taken over the PHY header (PHR) fields.
 - The HCS shall be computed using the first 28 bits of the PHR.
 - The HCS shall be calculated using the polynomial, $G_{16}(x)=x^{16}+x^{12}+x^5+1$.
- Tail bit field (T_5 - T_0)
 - Consists of all zeros
 - For Viterbi decoder flushing
- Reserved field (R_5 - R_0)
 - Set to zero upon transmission
 - Shall be ignored upon reception.

TAIL BIT FIELD (TAIL)

- Tail bit field (T_5-T_0)
 - The PPDU tail bit field shall be six bits of “0,” which are required to return the convolutional encoder to the “zero state.”
 - This procedure reduces the error probability of the convolutional decoder, which relies on future bits when decoding and which may not be available past the end of the message.
 - The PPDU tail bit field shall be produced by replacing six scrambled “zero” bits following the message end with six nonscrambled “zero” bits.

PAD BIT FIELD (PAD)

- The length of the message is extended so that it becomes a multiple of N_{dbps} , the number of data bits per OFDM symbol.
- The number of pad bits, N_{PAD} , are computed from the length, in octets, of the PSDU (LENGTH is equal to the content of the Frame Length field in PHR):

$$N_{\text{SYM}} = \text{ceiling} [(8 \times \text{LENGTH} + 6) / N_{\text{dbps}}] *$$

$$N_{\text{DATA}} = N_{\text{SYM}} \times N_{\text{dbps}}$$

$$N_{\text{PAD}} = N_{\text{DATA}} - (8 \times \text{LENGTH} + 6)$$

- The appended bits (i.e., pad bits) are set to “zeros” and are subsequently scrambled with the rest of the bits in the DATA field.

* The function ceiling() returns the smallest integer value greater than or equal to its argument value.

REFERENCE MODULATOR DIAGRAM

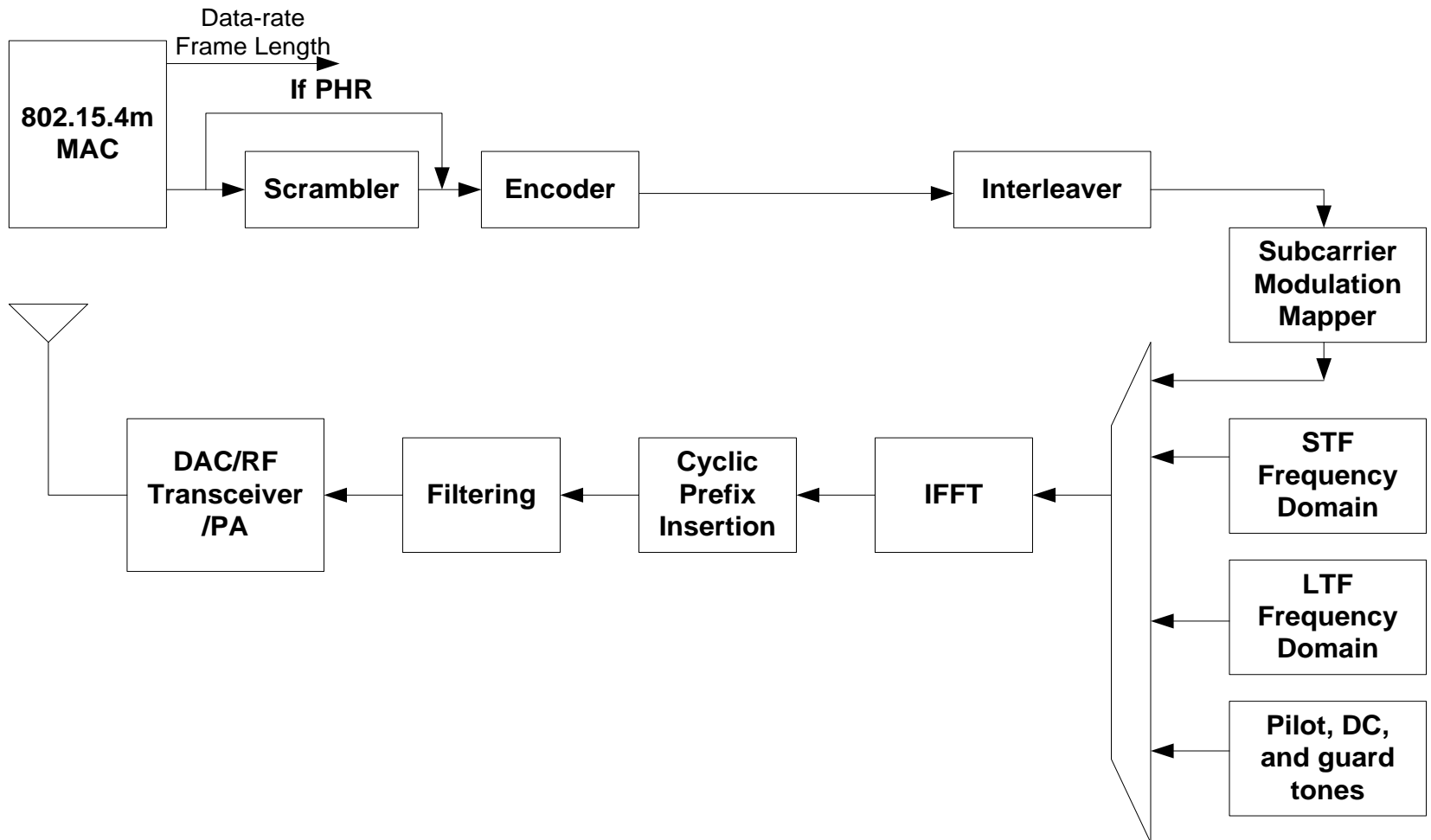

BIT-TO-SYMBOL MAPPING

- Bit-to-symbol mapping for BPSK, QPSK, and 16-QAM

The output values, d , are formed by multiplying the resulting $(I + jQ)$ value by a normalization factor K_{MOD} :

$$d = (I + jQ) \times K_{MOD}$$

The normalization factor, K_{MOD} , depends on the base modulation mode. The purpose of the normalization factor is to achieve the same average power for all mappings.

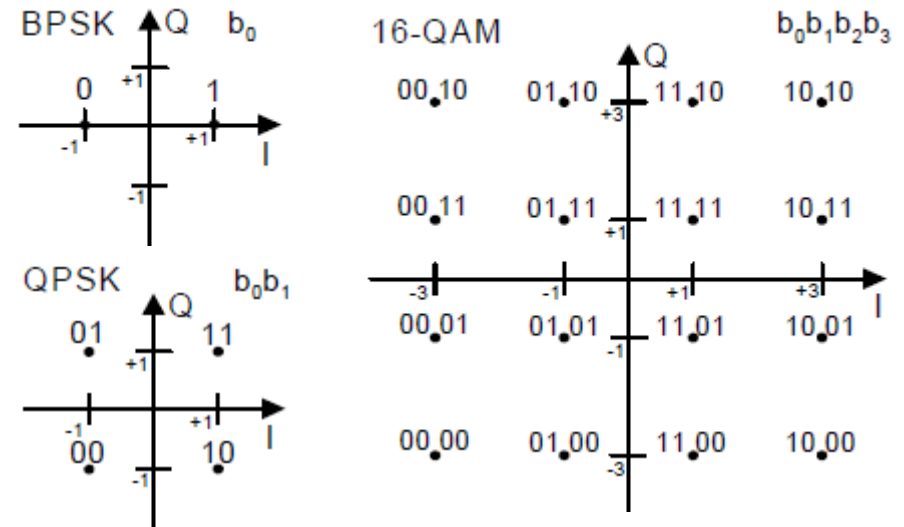

Modulation	K_{MOD}
BPSK	1
QPSK	$1/(\sqrt{2})$
16-QAM	$1/(\sqrt{10})$

FORWARD ERROR CORRECTION (FEC)

- The DATA field shall be coded with a convolutional encoder of coding rate $R = 1/2$.
- The convolutional encoder shall use the generator polynomials expressed in octal representation, $g_0=133_g$ and $g_1=171_g$.

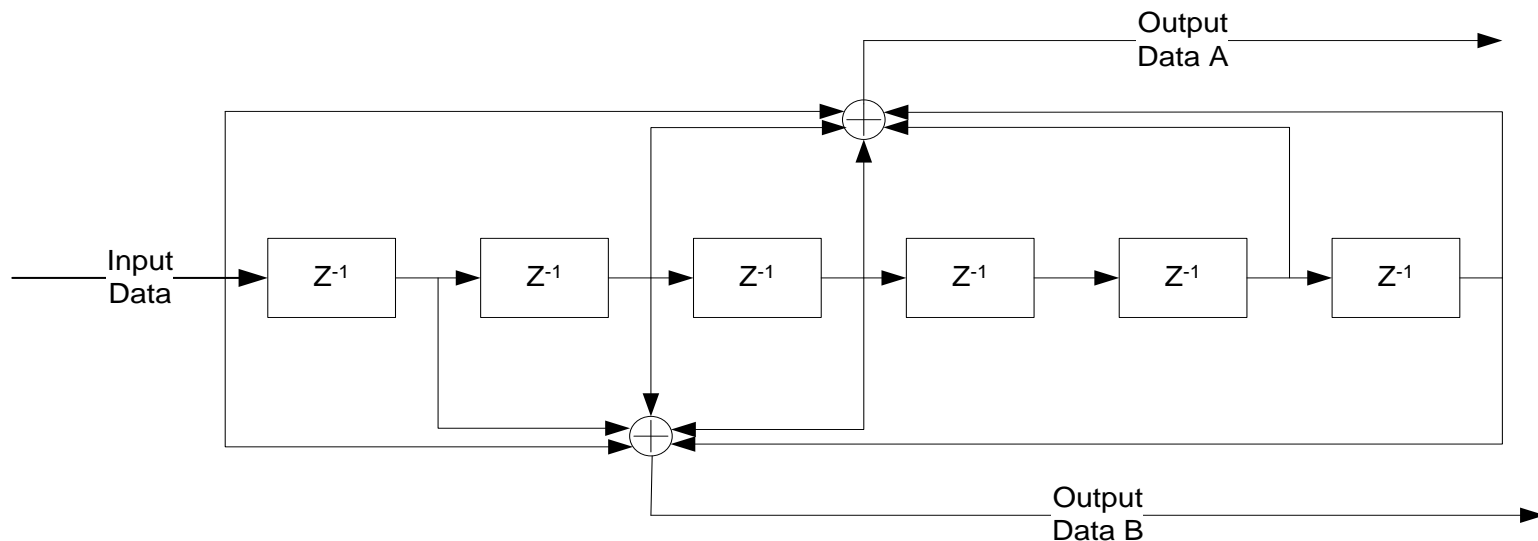

Convolutional Encoder: Rate $\frac{1}{2}$, constraint length $K=7$
Octal generator polynomials [133, 171]

SCRAMBLER

- The input to the scrambler is the data bits followed by tail bits and then pad bits.
- The scrambler uses a PN9 sequence.
 - The PN9 scrambler is initialized by the scrambling seed specified by 9 bits in the PHR.
 - The PN9 generator shall be reinitialized to the seed after each packet (either transmit or receive).
 - The scrambled bits are found using an XOR operation of each of the input bits with the PN9 sequence:

$$\text{bit}_n = (\text{input bit}_n) \text{ XOR } (\text{PN9}_n)$$

- After scrambling, the tail bits are reset to all zeros.

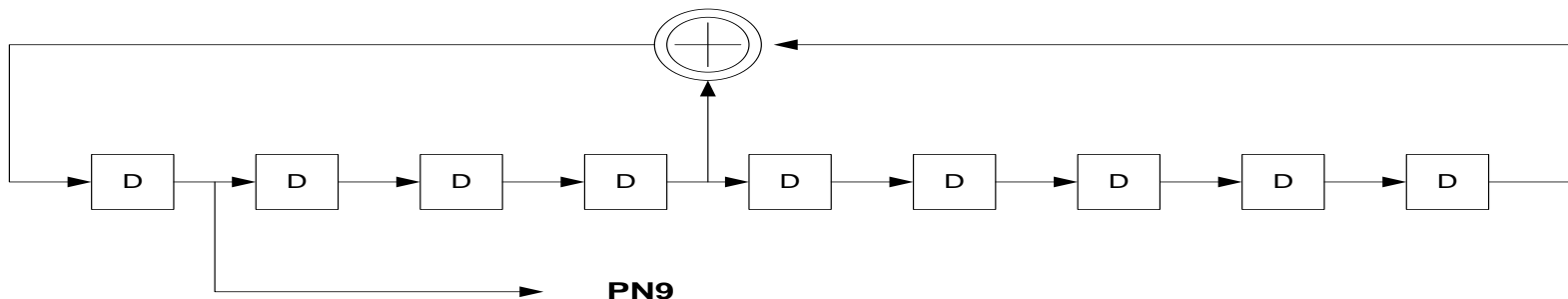

PULSE SHAPING

- Pulse shaping
 - Pulse shaping is applied at the transmitter. The pulse shaping method is as needed to meet regulatory requirements in the band of operation

CONCLUSION

CONCLUSION

- For the baseline of TVWS OFDM PHY for 15.4m standard,
 - All four proposals so far presented are considered for merging.
 - All features and parameters which should be specified in the standard are identified through proposal merging work.

- As the result of this work,
 - The text draft of the merged OFDM PHY proposal was prepared and uploaded: 15-12-0xxx-00.
 - This text document will be utilized as a baseline for drafting 15.4m standard in this area.