

**Project: IEEE P802.15 Working Group for Wireless Personal Area Networks (WPANs)**

**Submission Title:** [ETRI NB PHY proposal for TG4k LECIM networks]

**Date Submitted:** [21 July, 2011]

**Source:** Mi-Kyung Oh, Sangsung Choi, Kwang-Roh Park (ETRI)

Voice: +82 42 860 5680, FAX: +82 42 860 5218, E-Mail: ohmik@etri.re.kr

**Re:** [802.15.TG4k]

**Abstract:** This contribution is prepared to propose the PHY for LECIM networks

**Purpose:**

**Notice:** This document has been prepared to assist the IEEE P802.15. It is offered as a basis for discussion and is not binding on the contributing individual(s) or organization(s). The material in this document is subject to change in form and content after further study. The contributor(s) reserve(s) the right to add, amend or withdraw material contained herein.

**Release:** The contributor acknowledges and accepts that this contribution becomes the property of IEEE and may be made publicly available by P802.15.

# Contents

- Requirements overview
- Operating band & TX power
- LECIM channel
- FSK-based modulation
- FEC, data whitening and spreading
- PHY packet format & system block diagram
- PHY channel plan & link budget
- Co-located networks & coexistence
- Power efficiency & reliability enhancing features
- Conclusions

# Requirements Overview (1/3)

- LECIM Networks

- Mains powered coordinator should manage thousands of battery powered endpoint devices that are widely dispersed
- Power consumption and lifetime are the major design requirements for long deployment life without human contact
- Reliable operation against high path loss is essential

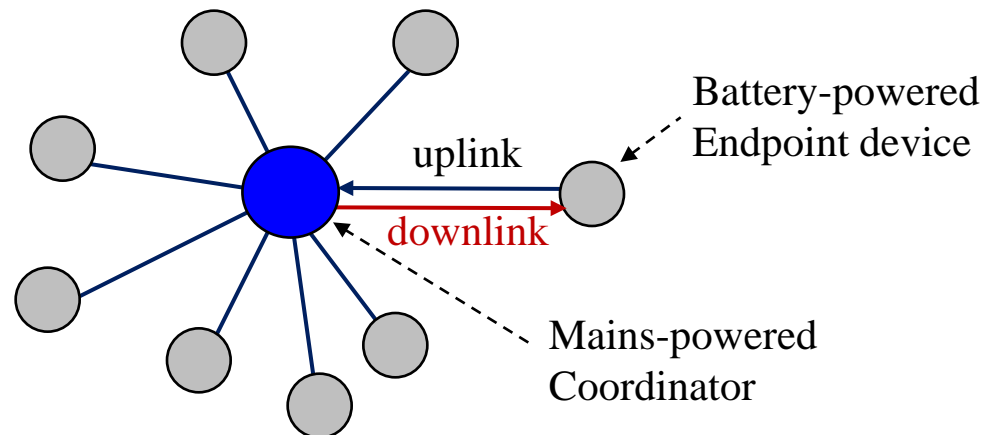

## Requirements Overview (2/3)

- Operation in any of the regionally available licensed, license exempt, and special purpose frequency bands
- Simultaneous operation for at least 8 co-located orthogonal networks
- Application data rate of less than 40 kbps
- Propagation path loss of at least 120 dB
- >1000 endpoints per mains powered infrastructure
- Asymmetric application data flow

# Requirements Overview (3/3)

- Extreme difference in capabilities and performance between endpoint devices and coordinating devices
  - Coordinator may support all standardized modulations (MCS) and data rates
  - Coordinator may be required to support antenna diversity or antenna beam steering
  - Endpoint must be able to conserve energy
- Reliable operation in dramatically changing environments (no control over environment)
- Mechanisms that enable coexistence with other systems in the same band(s)

# Key Aspects of PHY Proposal (1/2)

Parameter	Proposed narrowband PHY
Operating band	Sub-GHz, 2.4GHz
Modulation	FSK-based orthogonal signaling
Symbol rate	40KHz (uplink), 20 KHz (downlink)
Spreading	Spreading factor: 0, 2, 4, 8,16, 32
FEC	Convolutional code with interleaving
Data whitening	XOR(PSDU,PN9 sequence)
PHY frame structure:	
- SHR	Multiples of "01010101" + 64 bit SFD
- PHY header	16-bit including length 7-bit, rate 2-bit, spreading factor 3-bit, interleaving depth 2-bit, odd parity 1-bit
- Max. PSDU	127-octet
- CRC	16-bit ITU-T CRC

# Key Aspects of PHY Proposal (2/2)

Parameter	Proposed narrowband PHY
Channel spacing	160 KHz, 80 KHz
Transmit Power	As allowed by regulatory regimes
PSD	As allowed by regulatory regimes
Link Quality Indication	RSSI
Co-located networks features	Channel diversity
Co-existence features	Channel diversity
Power efficiency features	FSK-based modulation, parity in PHR, low-power consumption endpoint device
Reliability enhancing features	FEC, whitening, spreading, long preamble & SFD sequence, etc

# Operating Bands and TX Power

- Large number of narrowband channels across regionally available multiple bands
  - 868-870 MHz
  - 902-928 MHz
  - 2400-2483.5 MHz
  - Other available bands
- Maximum transmit power in each operating band: allowed by regulations
  - e.g., 917~923.5 MHz (Korea) : transmission power is limited by 10dBm for USN utilization



# LECIM Channel

- LECIM path loss models
  - 900MHz (Okumura-Hata) v.s. 2.4GHz (COST 231-Hata) cf) Doc. 571/r0

$f_c = 900 \text{ MHz}$ ,  $h_b = 30\text{m}$ ,  $h_m = 2\text{m}$

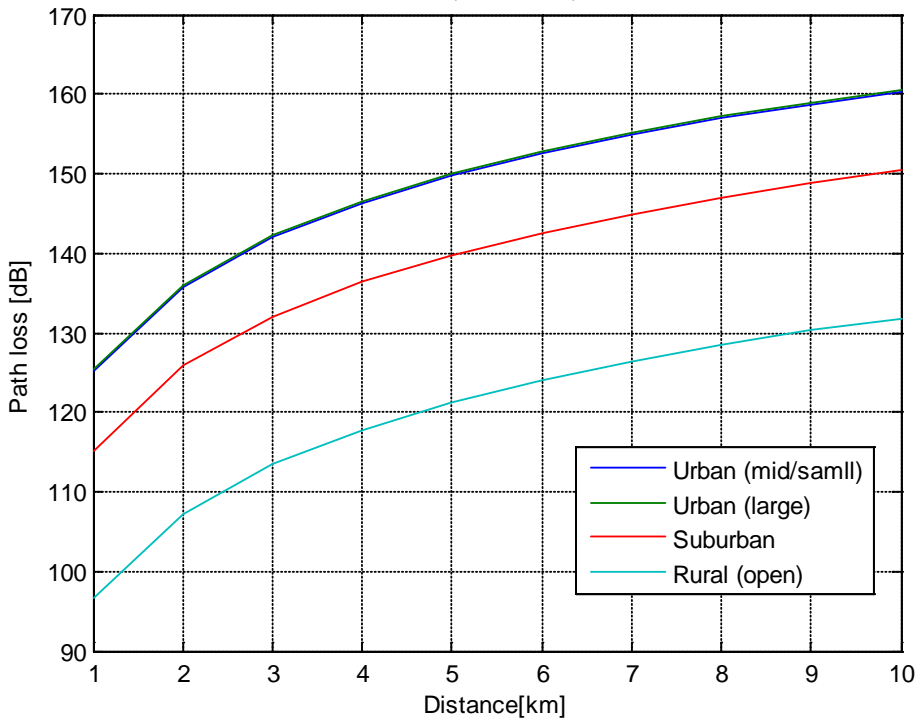

$f_c = 2400 \text{ MHz}$ ,  $h_b = 30\text{m}$ ,  $h_m = 2\text{m}$

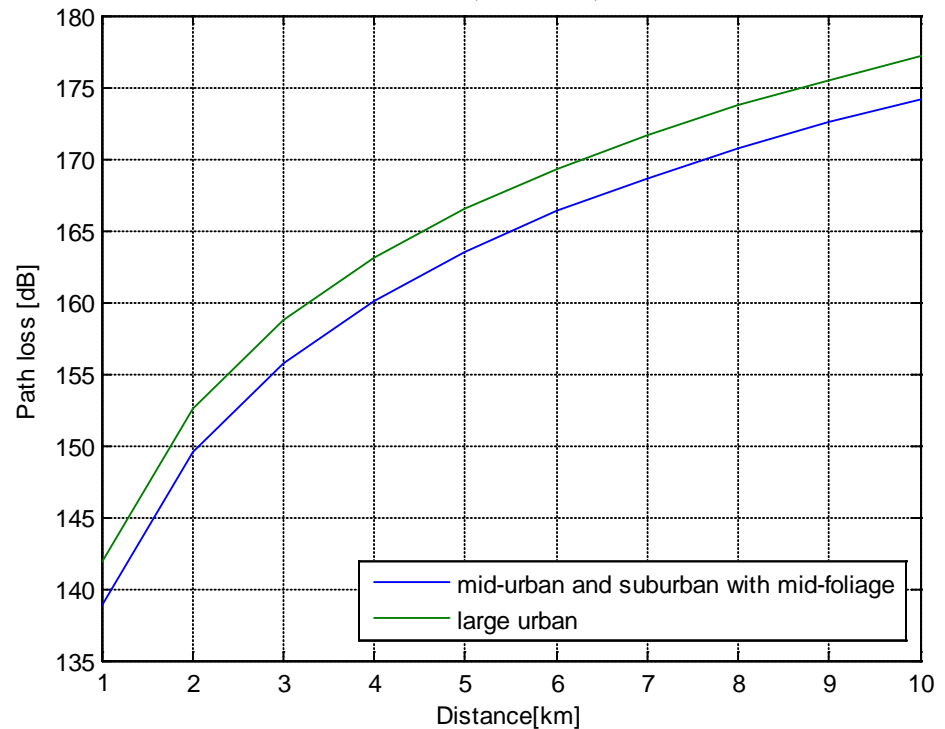

# LECIM Channel: 900MHz Large Urban

cf) Doc. 464/r1

Channel Model Parameters		Notes
Frequency (MHz)	900	Valid Range 150–2400 MHz
Collector Antenna Height (m)	30	Hata Valid Range 30–200 m, including terrain. Erceg Valid Range 10–80m, including terrain
Endpoint Antenna Height (m)	2	Hata Valid Range 1–10 m, Erceg Fixed to 2m.
Distance (km)	1	Valid Range 1–20 km

Downlink Path Loss Calculation		Notes
Collector Tx Power (dBm)	10	Subject to Tx Power Regulations
Collector Tx Antenna Gain (dBi)	6	Subject to Tx Power Regulations
Path Loss (dB)	-125.40	Must reference the right path loss from the Hata or Erceg worksheet
Shadowing Margin (dB)	-12	To buffer against variable shadowing loss
Penetration Loss (dB)	0	For underground vaults, etc.
Endpoint Rx Antenna Gain (dBi)	2	If using same antenna for Tx, must be same as in Uplink Table
Endpoint Interference (dB)	1	Rise over Thermal Interference
Rx Power at Endpoint (dBm)	<b>-118.40</b>	Compare against Rx sensitivity

Uplink Path Loss Calculation		Notes
Endpoint Tx Power (dBm)	10	Subject to Tx Power Regulations. Can be different from Collector
Endpoint Tx Antenna Gain (dBi)	2	Subject to Tx Power Regulations
Penetration Loss (dB)	0	For underground vaults, etc.
Path Loss (dB)	-125.40	Same as Downlink
Shadowing Margin (dB)	-12	Same as Downlink
Collector Rx Antenna Gain (dBi)	6	If using same antenna for Tx, must be same as in Downlink Table
Collector Interference (dB)	2	Rise over Thermal Interference
Rx Power at Collector (dBm)	<b>-117.40</b>	Compare against Rx sensitivity

\* Mains powered collector: capability of beam-forming and antenna diversity (included in Tx/Rx antenna gain)

# PHY Proposal Consideration

- LECIM channel: harsh, high path loss environment
  - Rx power: -118.4dBm @ endpoint device
  - SNR @ RX antenna: ~ less than 0dB
- Reliability: How to recover the information bit from the weak signal?
  - Narrowband PHY to lower the noise level
  - Modified FSK modulation for Increased performance
  - Channel coding gain
  - Spreading gain
  - Antenna gain and etc.
- Energy efficiency (low-power consumption) at battery-powered endpoint is also main consideration

# FSK-based Modulation (1/4)

- Narrowband PHY modulation: FSK
- Benefits
  - No need of high-linearity power amplifier (PA)
  - Non-coherent receiver: low-power consumption
    - No need to track the phase of the carrier
    - Performance difference between coherent receiver and non-coherent receiver: roughly 1dB
    - Suitable for battery-powered endpoint devices
  - Simple, cheap and proven technology

# FSK-based Modulation (2/4)

- Conventional FSK: relatively poor performance
- Reliable operation over high path loss channel
  - SNR gain obtained from modulation is beneficial
- High-dimension orthogonal signaling
  - Can reduce the SNR per bit required to achieve a target BER
  - 2-level FSK: 2-dimension orthogonal signals (freq. domain)
  - 2-ary PPM (Pulse position modulation): 2-dimension orthogonal signals (time domain)
  - Combination of FSK and PPM
    - Can construct 4-dimension orthogonal signals while keeping the same bit rate and signal bandwidth

# FSK-based Modulation (3/4)

- Position-based FSK (P-FSK)
  - Two bits are encoded by transmitting a FSK-modulated signal in one of two possible positions (time-shifts)
  - 4-dimension orthogonal signaling
    - 4 waveforms that indicate “00”, “01”, “10”, “11”

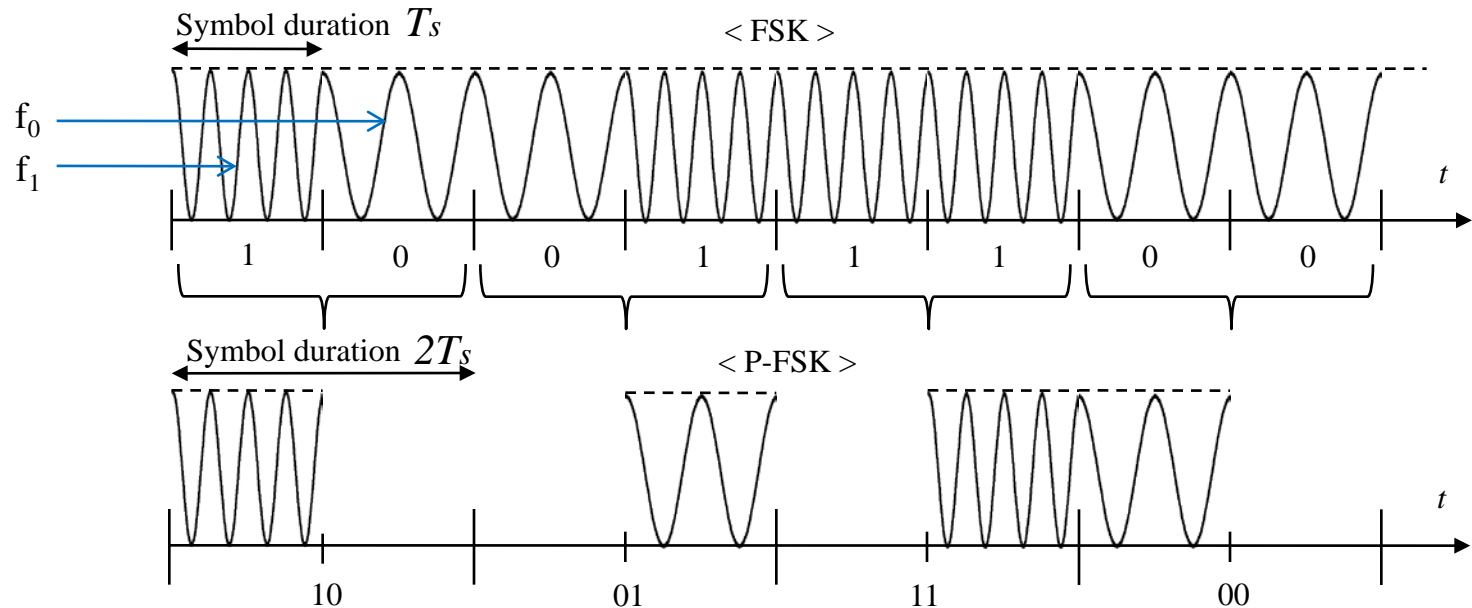

# FSK-based Modulation (4/4)

- BER performance of P-FSK: 2.7dB gain at BER  $10^{-5}$

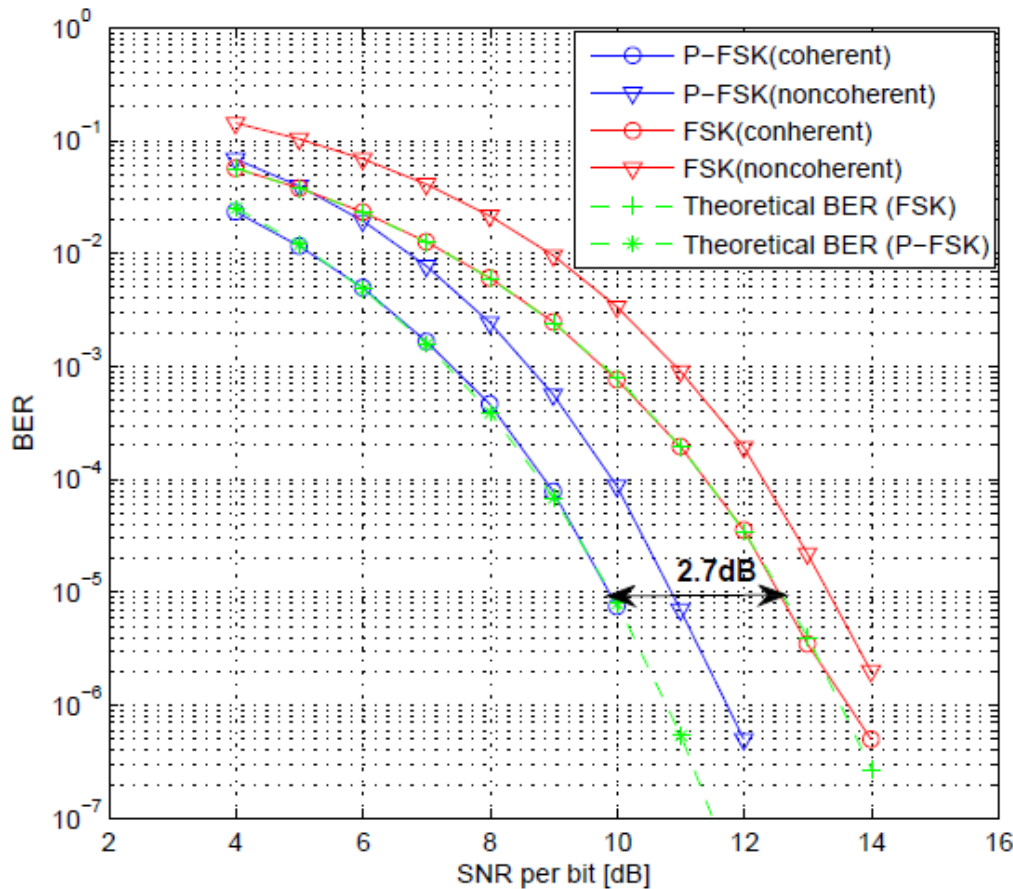

- Mains powered coordinator
  - : recommend the coherent receiver
  - : performance enhancement
- Battery powered endpoint
  - : recommend the non-coherent receiver
  - : low power consumption
- Non-coherent receiver for P-FSK
  - : same as the conventional FSK
  - : computational overhead is negligible

# Forward Error Correction

- Error correction capability is required for reliable operation in dramatically changing environments
- Long burst errors are more likely than random bit error
- FEC
  - Rate  $\frac{1}{2}$  (133,171) convolutional code with interleaving
  - Already specified in 15.4 PHYs
  - 5 dB coding gain with soft decision
- Viterbi decoder at the receiver
  - Mains powered coordinator: soft decision
  - Battery powered endpoint: hard decision
  - 2dB performance difference between SDD & HDD



# Data Whitening

- Long runs of 1s and 0s in data (payload) may degrade the performance of bit timing recovery and tracking in FSK system
- PSDU Data whitening (applied to FSK-modulated bits)
  - Same as 15.4g
  - Whitened bit = XOR(incoming bit, PN9)

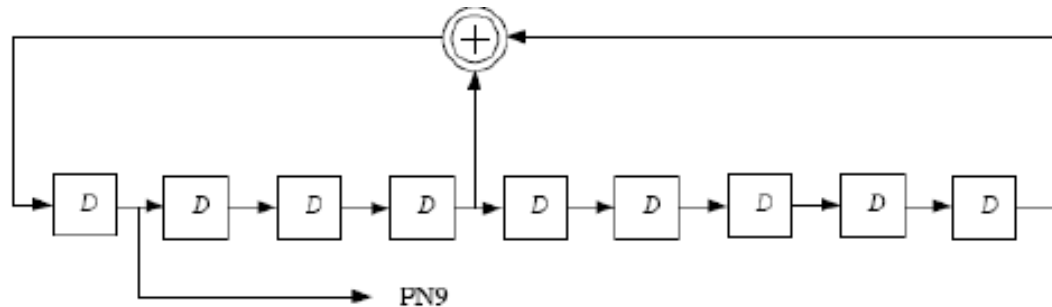

< Schematic of the PN9 sequence generator >

# Spreading

- LECIM channel: RF link with high path loss ( $>120\text{dB}$ )
- Simple spreading scheme
  - $A \Rightarrow$  repetition of “ $A\bar{A}$ ” where  $A$  is a symbol
    - e.g.)  $0 \Rightarrow$  repetition of “01”,  $1 \Rightarrow$  repetition of “10”
    - e.g.)  $01 \Rightarrow$  repetition of “0110”, “11”  $\Rightarrow$  repetition of “1100”
  - Repetition of “ $A\bar{A}$ ”: useful for FSK based system
  - Repetition rate depends on spreading factor
- Spreading factor
  - 1(0dB), 2(3dB), 4(6dB), 8(9dB), 16(12dB), 32(15dB)
  - Can be selected according to channel condition

# Symbol Rate & Data Rate

- Asymmetric data flow between uplink and downlink
  - More data from endpoint device to coordinator
- Symbol rate : 40KHz & 20KHz
  - 40KHz (Mandatory for uplink), 20KHz(Mandatory for downlink)
- Data rate depends on coding rate and spreading factor

< Data Rate Table >

SF \ Symbol Rate	40 KHz	20 KHz
1	20 Kbps	10 Kbps
2	10 Kbps	5 Kbps
4	5 Kbps	2.5 Kbps
8	2.5 Kbps	1.25 Kbps
16	1.25 Kbps	0.625 Kbps
32	0.625Kbps	0.3125 Kbps

# PHY Packet Format

- PHY packet format

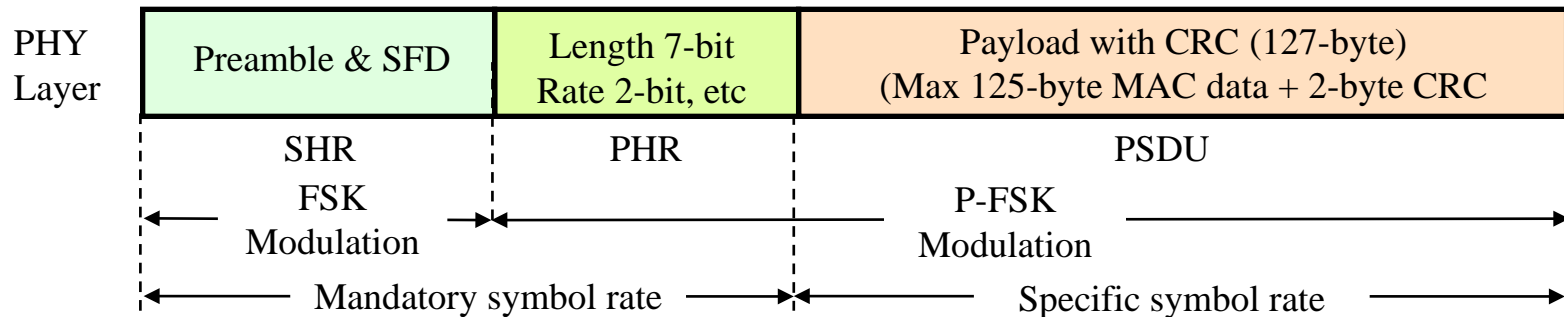

- SHR: modulated by FSK
- PHR and PSDU: modulated by P-FSK
- SHR & PHR: transmitted at mandatory symbol rate
- PSDU: transmitted at symbol rate specified in PHR

# Preamble & SFD

- Long preamble and SFD sequence are necessary due to harsh and high path loss channel environment
- Preamble
  - Multiples of “01010101” as specified in 15.4g
  - Enough octets for packet detection and synchronization
- SFD
  - At least 64-bit sequence
  - 4-repetition of short sequence with length 16
  - Short sequence: “0110111101001110” as specified in 15.4g
  - Benefit
    - SFD detector can use full SFD sequence or part of SFD sequence according to its capability and channel condition

# PHR

- PHR sequence
  - Length: 7-bit → max. PSDU 127-octet
  - Rate: 2-bit → symbol rate 40KHz and 20KHz
  - Spreading factor (SF): 3-bit
  - Interleaving depth (IDepth): 2-bit
    - 4 cases for PSDU interleaving depth
  - Odd parity (OP): 1-bit
    - Simply detect PHR error to stop demodulation process

Octets: 1				1	
Bits: 1	2	3	2	1	7
OP	IDepth	SF	Rate	EXT	Length
PHR					

# PHR & PSDU

- PHR and PSDU are encoded by  $\frac{1}{2}$  (133,171) convolutional code with interleaving
- Interleaving depth
  - Different value for PHR and PSDU
  - PHR: corresponding to the length of encoded PHR
    - PHR recovery without latency
  - PSDU: specified in PHR
    - Consider channel coherence time
- Spreading
  - PHR: spreading with mandatory spreading factor (SF)
  - PSDU: spreading with SF specified in PHR

# System Block Diagram

- PHY data flow

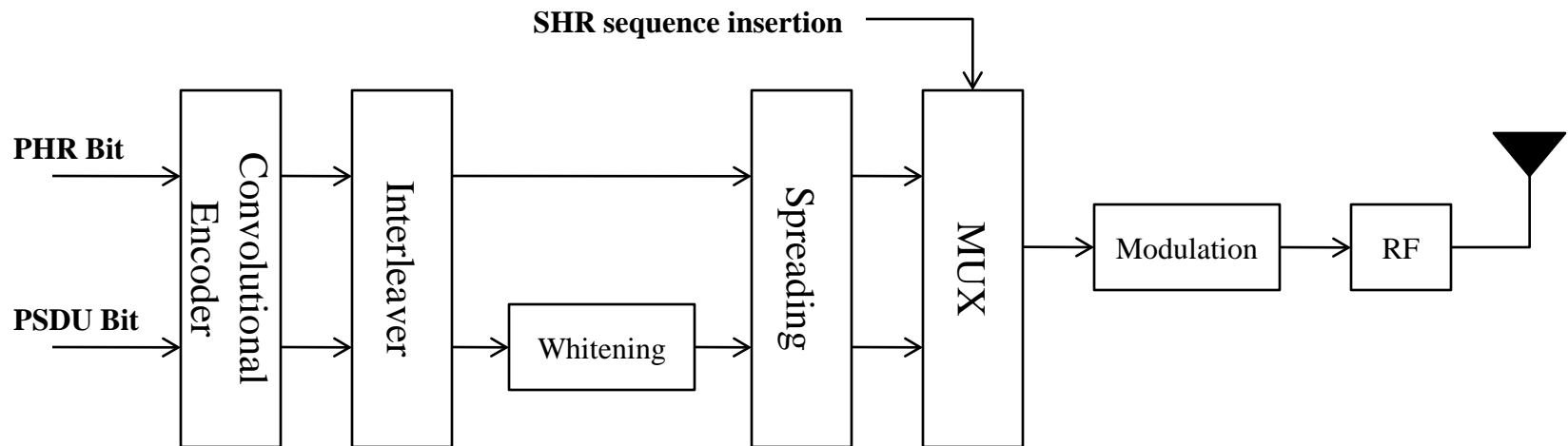



# PHY Channel Plan

- Number of channels per band
  - Symbol rate 40KHz: 160KHz channel spacing
  - Symbol rate 20KHz: 80KHz channel spacing

Band	# of Channels	
	40KHz	20KHz
868-870 MHz	12	25
902-928 MHz	162	325
2400-2483.5 MHz	521	1043

# Coordinator/Endpoint Features

- Mains-powered coordinator
  - (+) Beam forming & Antenna diversity
  - (+) P-FSK modulation
  - (-) Twice increased noise level than endpoint device  $\Rightarrow$  3dB loss
  - (+) Coherent receiver
  - (+) Soft decision Viterbi decoding }  $\Rightarrow$  3dB gain
- Battery-powered endpoint device
  - (+) P-FSK modulation
  - (+) Twice lowered noise level than coordinator  $\Rightarrow$  3dB gain
  - (-) Non-coherent receiver
  - (-) Hard decision Viterbi decoding }  $\Rightarrow$  3dB loss

**$\Rightarrow$  Balanced receiver sensitivity between coordinator and endpoint device**

# Link Budget (900MHz Large Urban)

- Minimum Eb/No for P-FSK:
  - Coherent receiver: 10dB @ BER  $10^{-5}$
  - Non-coherent receiver: 11dB @ BER  $10^{-5}$
  - Channel coding gain: SDD 5dB, HDD 3dB

Downlink		
Parameters	Unit	Value
Symbol rate [Rb]	KHz	20
Bandwidth [BW]	MHz	0.08
RX power at Endpoint [Pr]	dBm	-118.4
Receiver AWGN noise floor [N=-174+10log(BW)]	dBm	-125.0
RF noise figure of Endpoint [Nf]	dB	7.0
Average noise power [Pn=N+Nf]	dBm	-118.0
Minimum Eb/No [S]	dB	8.0
Implementation loss [I]	dB	3.0
Processing gain [PG]	dB	15
Link Margin [LM=Pr-Pn-S-I+PG]	dB	3.6
Proposed Min. Rx Sensitivity Level (Endpoint) [Pmin]	dBm	-122.0

Uplink		
Parameters	Unit	Value
Symbol rate [Rb]	KHz	40
Bandwidth [BW]	MHz	0.16
RX power at Collector [Pr]	dBm	-117.4
Receiver AWGN noise floor [N=-174+10log(BW)]	dBm	-122.0
RF noise figure of Collector [Nf]	dB	7.0
Average noise power [Pn=N+Nf]	dBm	-115.0
Minimum Eb/No [S]	dB	5.0
Implementation loss [I]	dB	3.0
Processing gain [PG]	dB	15
Link Margin [LM=Pr-Pn-S-I+PG]	dB	4.6
Proposed Min. Rx Sensitivity Level (Collector) [Pmin]	dBm	-122.0

# Link Budget (900MHz Suburban)

- Minimum Eb/No for P-FSK:
  - Coherent receiver: 10dB @ BER  $10^{-5}$
  - Non-coherent receiver: 11dB @ BER  $10^{-5}$
  - Channel coding gain: SDD 5dB, HDD 3dB

Downlink		
Parameters	Unit	Value
Symbol rate [Rb]	KHz	20
Bandwidth [BW]	MHz	0.08
RX power at Endpoint [Pr]	dBm	-108.2
Receiver AWGN noise floor [N=-174+10log(BW)]	dBm	-125.0
RF noise figure of Endpoint [Nf]	dB	7.0
Average noise power [Pn=N+Nf]	dBm	-118.0
Minimum Eb/No [S]	dB	8.0
Implementation loss [I]	dB	3.0
Processing gain [PG]	dB	6
Link Margin [LM=Pr-Pn-S-I+PG]	dB	4.8
Proposed Min. Rx Sensitivity Level (Endpoint) [Pmin]	dBm	-113.0

Uplink		
Parameters	Unit	Value
Symbol rate [Rb]	KHz	40
Bandwidth [BW]	MHz	0.16
RX power at Collector [Pr]	dBm	-107.2
Receiver AWGN noise floor [N=-174+10log(BW)]	dBm	-122.0
RF noise figure of Collector [Nf]	dB	7.0
Average noise power [Pn=N+Nf]	dBm	-115.0
Minimum Eb/No [S]	dB	5.0
Implementation loss [I]	dB	3.0
Processing gain [PG]	dB	6
Link Margin [LM=Pr-Pn-S-I+PG]	dB	5.8
Proposed Min. Rx Sensitivity Level (Collector) [Pmin]	dBm	-113.0

# Co-located Networks

- Channel diversity of NB PHY
  - 902MHz band: 162 Channels
  - 2.4GHz band: 521 Channels
- NB PHY with large number of available channels per band enables co-located networks

# Coexistence

- Channel diversity of NB PHY
  - 902MHz band: 162 Channels
  - 2.4GHz band: 521 Channels
- Low duty cycle
  - Small and infrequent messages
- NB PHY with large number of available channels per band and low duty cycling property enable to coexist with other services in the same band

# Power Efficiency Features

- Simple & low-power FSK based narrowband PHY
- Parity in PHR
  - Simply detect PHR error to stop payload demodulation process
- Endpoint device
  - Non-coherent FSK receiver and hard decision decoding enables endpoint device to conserve energy at PHY level

# Reliability Enhancing Features

- SHR: Long preamble & SFD sequence
- PHR: protection with convolution coding and spreading
- PSDU
  - Error detection: 16-bit ITU-T CRC
  - Error correction: Convolutional coding with interleaving
  - Spreading: SNR gain
- Mains-powered coordinator
  - Antenna diversity and beam forming
  - Coherent receiver
  - Soft decision decoding



# Conclusions

- The PHY proposal is consistent with the scope of LECIM PAR
  - LECIM channel consideration
  - Reliability enhancement
  - Energy efficiency
  - Low data rate
  - Operation in unlicensed spectrum

# References

- **802.15-11-0061-00-004k-tg4k PAR as approved by NesCom**
- **802.15-11-0359-04-004k-tg4k technical guidance document**
- **802.15-11-0464-00-004k-tg4k hata channel model worksheet**
- **802.15-11-0465-00-004k-tg4k channel characteristics**
- **802.15-11-0571-00-004k-channel model comparison for 802.15.4k**