

Project: IEEE P802.15 Working Group for Wireless Personal Area Networks (WPANs)

Submission Title: Towards a 300 GHz Channel Model

Date Submitted: 8 July, 2010

Source: Sebastian Priebe, Technische Universität Braunschweig

Address: Schleinitzstraße 22, D-38092 Braunschweig, Germany

Voice: +49-531-391-2417, FAX: +49-531-391-5192, E-Mail: priebe@ifn.ing.tu-bs.de

Re: doc.: IEEE 802.15-15-09-0496-00-0thzr1-channel-measurements

Abstract: In addition to the first detailed ultra wideband propagation measurements (cf. doc.: IEEE 802.15-15-09-0496-00-0thzr1-channel-measurements), a detailed characterization of the used measurement system is presented. Short range indoor channel measurements with regard to distance and module displacement are shown. The measurements demonstrated in IEEE 802.15-15-09-0496-00-0thzr1-channel-measurements are compared to ray tracing simulations. The suitability of ray tracing for the derivation of a first 300 GHz channel model is discussed.

Purpose: Input of preliminary results for the modeling of channel characteristics at 300 GHz

Notice: This document has been prepared to assist the IEEE P802.15. It is offered as a basis for discussion and is not binding on the contributing individual(s) or organization(s). The material in this document is subject to change in form and content after further study. The contributor(s) reserve(s) the right to add, amend or withdraw material contained herein.

Release: The contributor acknowledges and accepts that this contribution becomes the property of IEEE and may be made publicly available by P802.15.

Towards a 300 GHz Channel Model

Sebastian Priebe¹, Martin Jacob¹, Thomas Kürner¹
Christian Jastrow², Thomas Kleine-Ostmann², Thorsten Schrader²

¹ Institut für Nachrichtentechnik, Technische Universität Braunschweig, Germany

² Physikalisch-Technische Bundesanstalt, Braunschweig, Germany

Outline

- 1. Introduction**
2. The 300 GHz Measurement System
3. Measurement Results
4. Summary/Outlook

Introduction (1)

- Material parameter investigation in the THz range using Terahertz Time Domain Spectroscopy by the Terahertz Communications Lab (TCL)

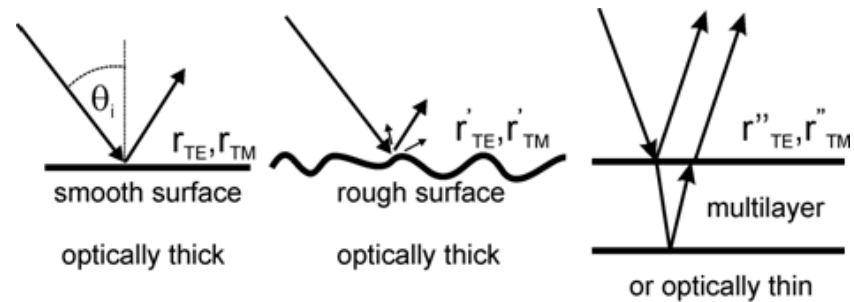
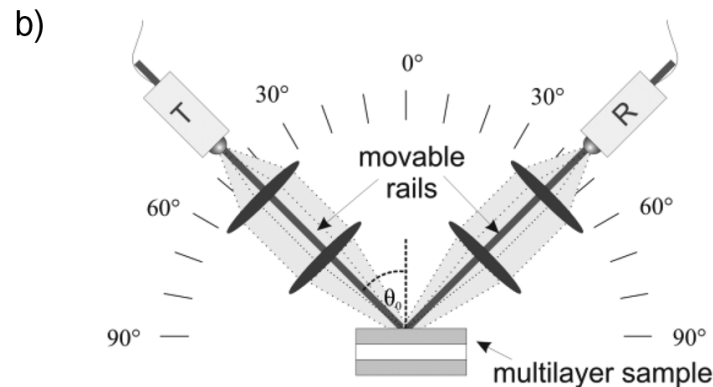
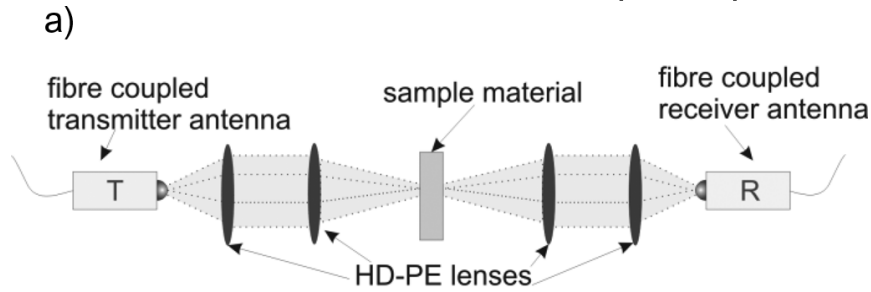

M. Jacob et al.: Propagation modeling and system analysis for future multi gigabit THz communication, Frequenz - Journal of RF Engineering and Telecommunications, Special issue on „Terahertz Technologies and Applications“, May 2008

C. Jansen et al.: The Impact of Reflections From Stratified Building Materials on the Wave Propagation in Future Indoor Terahertz Communication Systems, IEEE Transactions on Antennas and Propagation, Vol. 56, No. 5, May 2008

Introduction (2)

- Theoretical ray tracing simulations with realistic material parameters
- Simplifications/open issues:
 - Only narrowband channel characterization
 - No diffuse scattering
 - No comparison with measurements

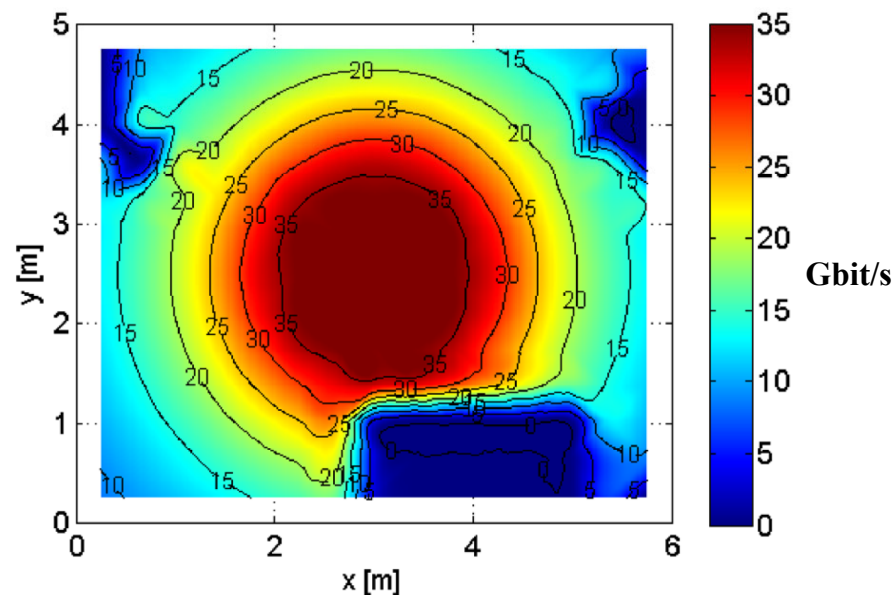
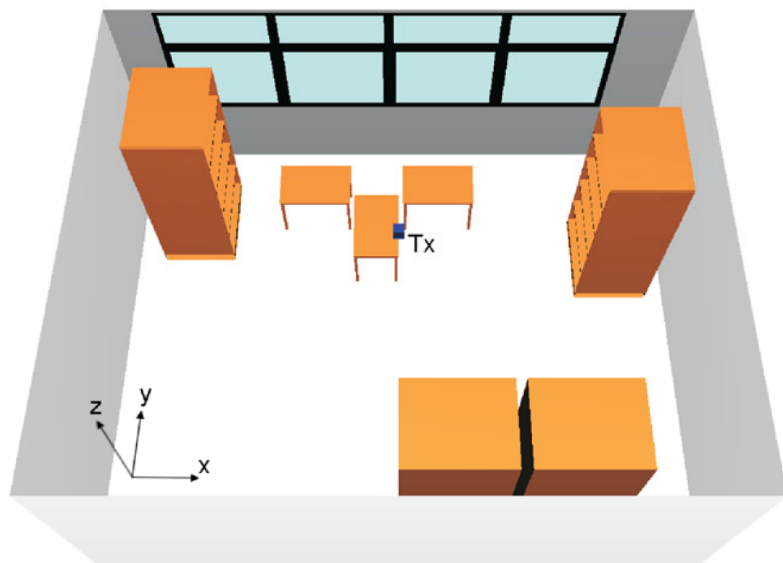

R. Piesiewicz, M. Jacob, J. Schöbel, T. Kürner: Influence of hardware parameters on the performance of future indoor THz communication systems under realistic propagation conditions, European Microwave Week 2007, Munich, October 2007

Outline

1. Introduction
- 2. The 300 GHz Measurement System**
 - **The System Setup**
 - **System Characterization**
3. Measurement Results
4. Summary/Outlook

The System Setup (1)

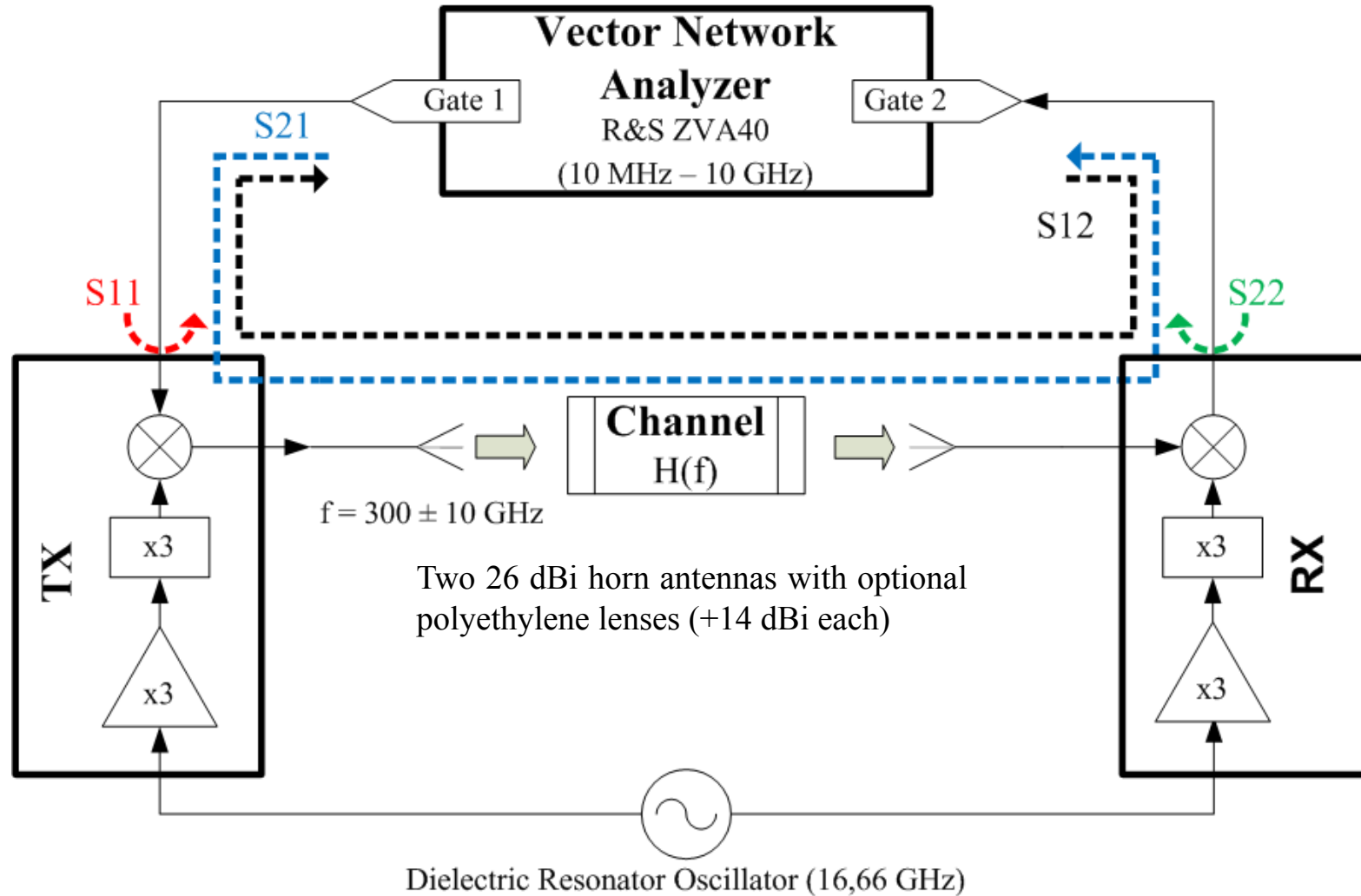

The System Setup (2)

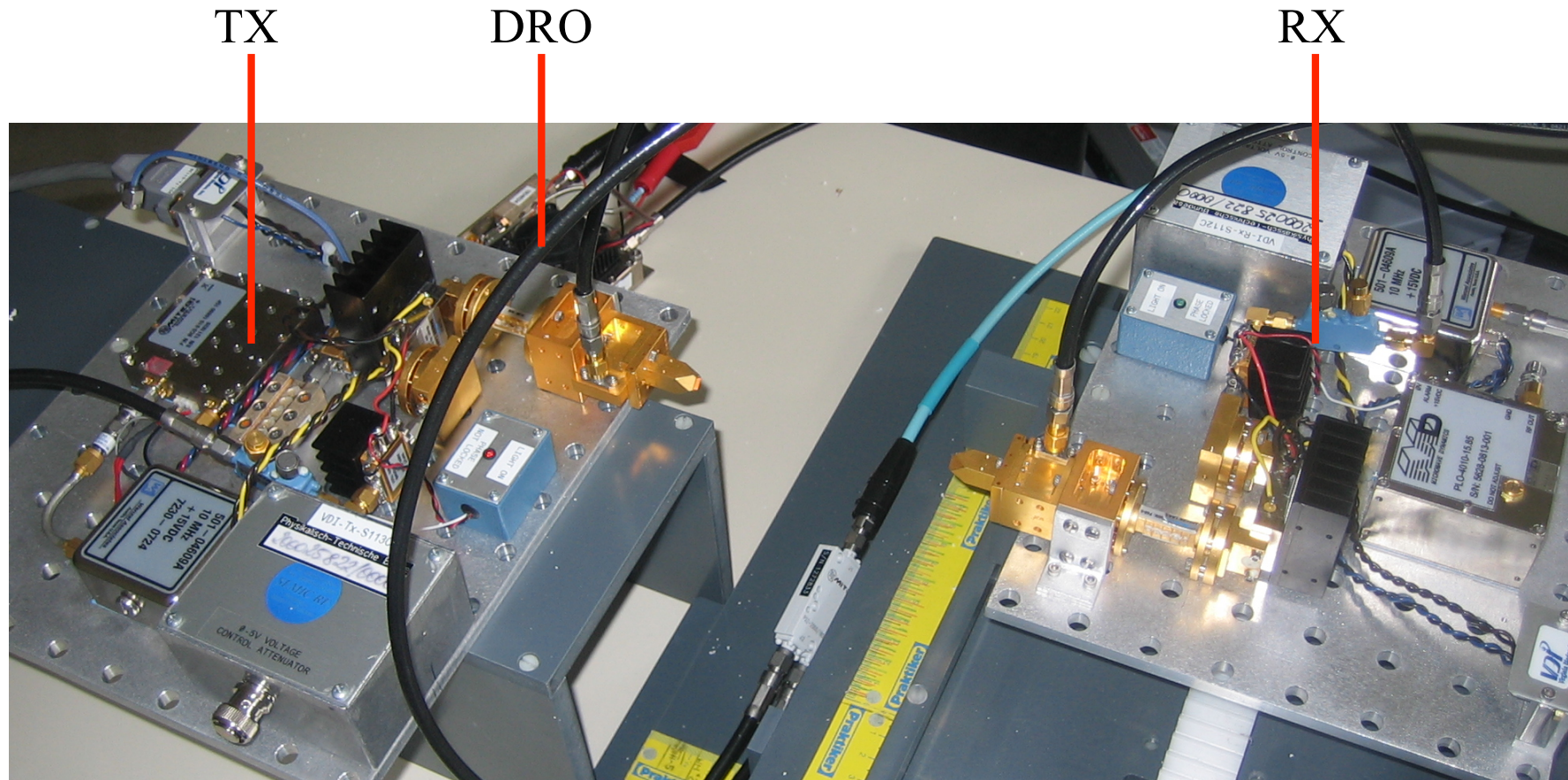

The System Setup (3)

Parameter	Symbol	Value
Measurement points	N	801
IF filter bandwidth	Δf_{IF}	10 kHz
Average noise floor	P_{N}	-113.97 dBm
Noise standard deviation	σ	6.74 dB
Power of test signal	P_{Test}	-5 dBm
Start frequency	f_{Start}	10 MHz
Stop frequency	f_{Stop}	10 GHz
Bandwidth	B	9.99 GHz
Time domain resolution	Δt	0.1 ns
Smallest resolvable distance	Δl	3 cm
Maximum excess delay	T_{m}	80 ns
Maximum detectable path length	l_{m}	24 m

System Calibration (1)

- System response of 300 GHz transceiver system not included in VNA calibration
- Reference measurements with connected waveguides

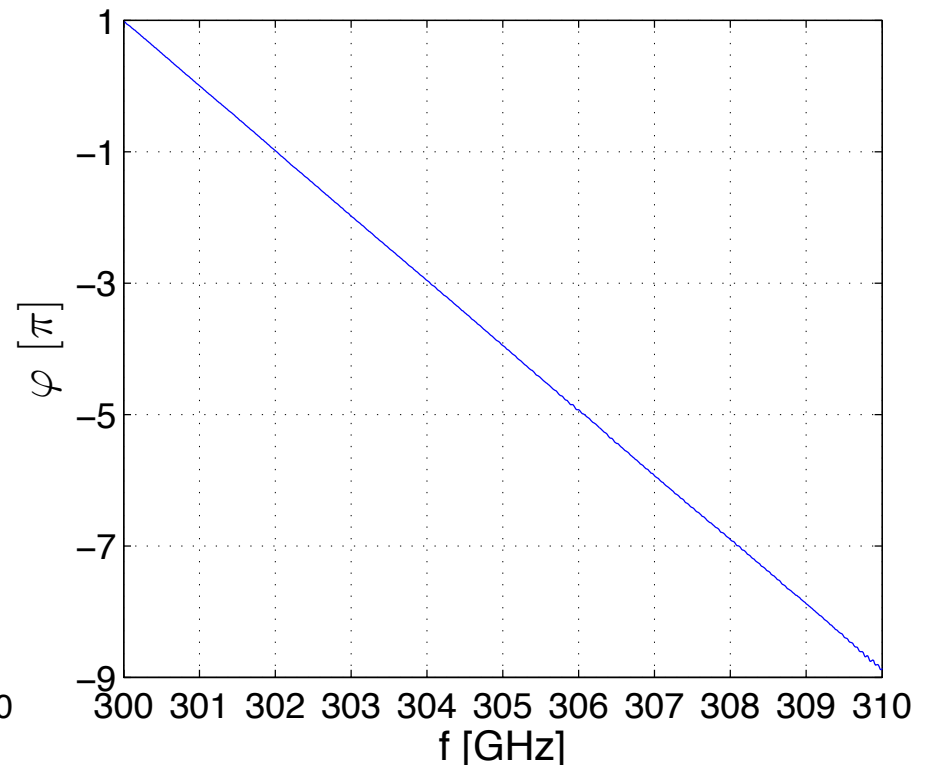
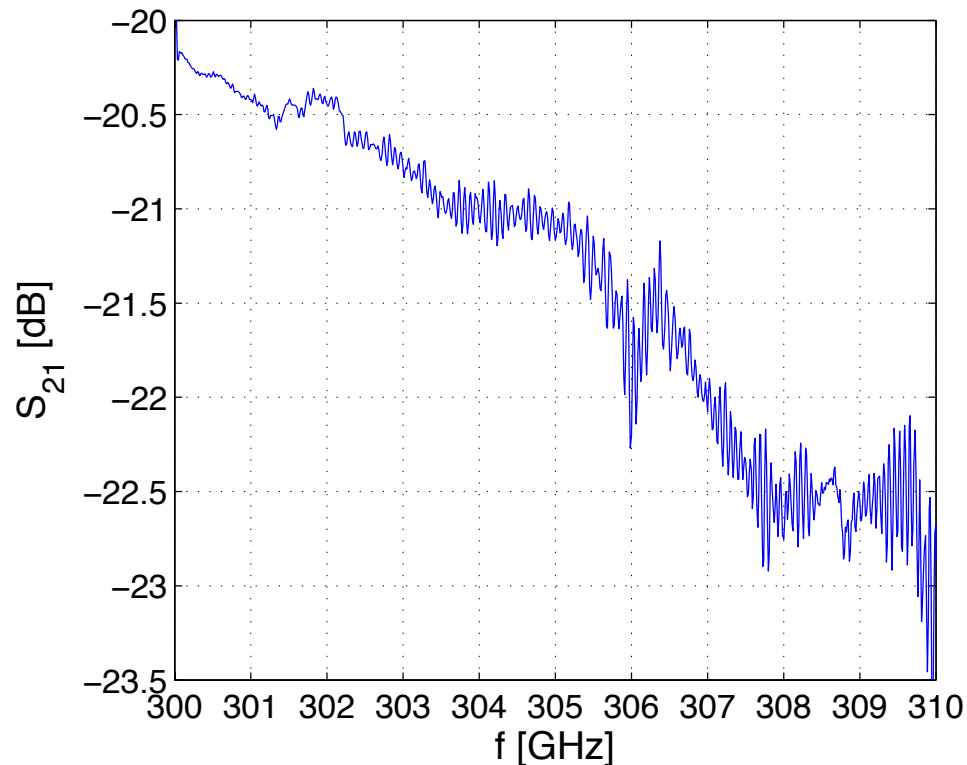

System Calibration (2)

- Double sideband mixers used
- Lower ($300 \text{ GHz} - f_{\text{Test}}$) and upper ($300 \text{ GHz} + f_{\text{Test}}$) sideband overlap in baseband due to homodyne downconversion

$$S(f) = \frac{P(f)}{2} \cdot \left(\frac{c}{4\pi r(f_{LO} + f)} \right)^2 \cdot e^{j\left(\frac{2\pi f}{c}d + \varphi_0\right)}$$

$$\cdot \left[\delta(f + f_{\text{Test}}) \cdot \left\{ \cos\left(\frac{2\pi f_{LO}}{c}d\right) + j \cdot k(f) \cdot \sin\left(\frac{2\pi f_{LO}}{c}d\right) \right\} \right. \\ \left. + \delta(f - f_{\text{Test}}) \cdot \left\{ k(f) \cdot \cos\left(\frac{2\pi f_{LO}}{c}d\right) + j \cdot \sin\left(\frac{2\pi f_{LO}}{c}d\right) \right\} \right]$$

with

$$k(f) = \left(\frac{f_{LO} - f}{f_{LO} + f} \right)^2$$

→ Slight correctable amplitude distortion

Outline

1. Introduction
2. The Measurement Setup
- 3. Measurement Results**
 - **Short Range Channel Measurements**
 - **Indoor Channel Measurements**
4. Summary/Outlook

Short Range Channel Measurements (1)

- Exemplary application: Ultra fast data exchange between a PC and a flash drive
- Distance- and antenna mispointing-dependent measurements (26 dBi horn antennas)

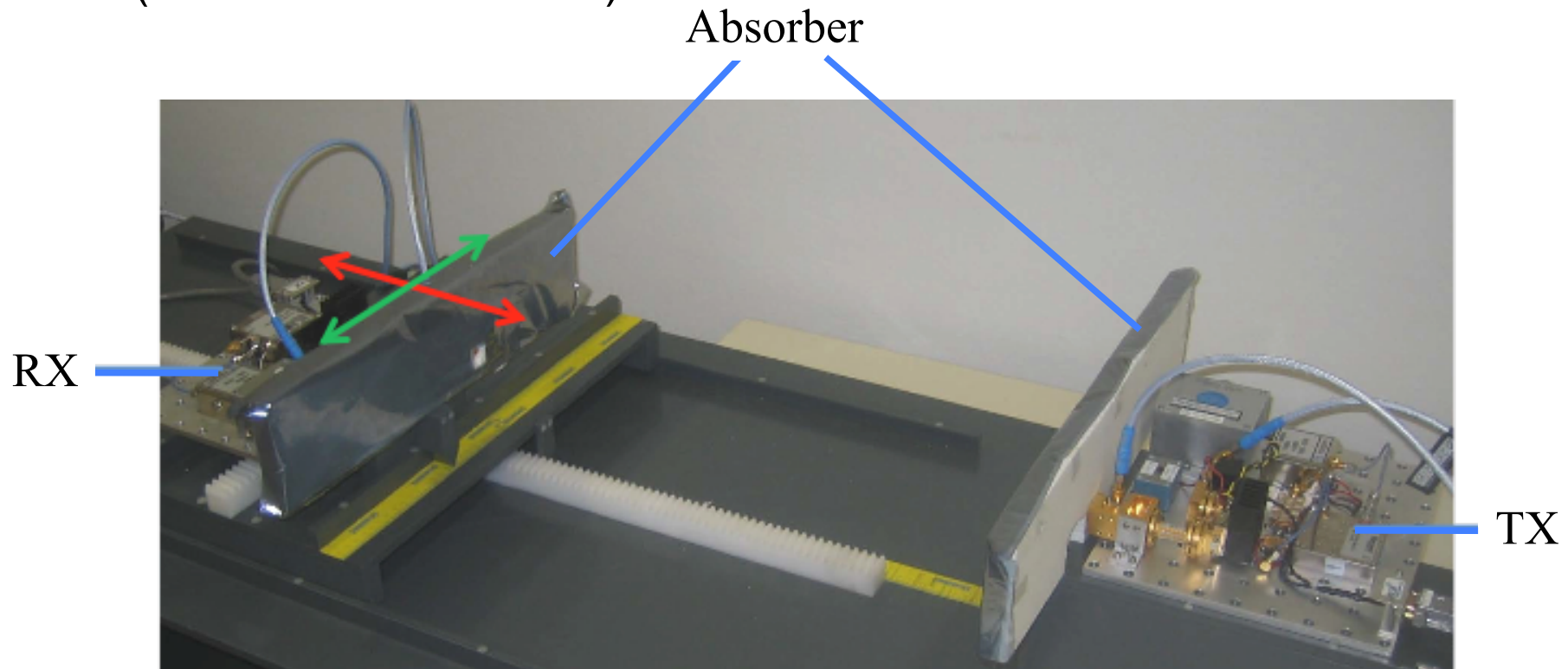

Short Range Channel Measurements (2)

- Module distance $d = 20$ cm:

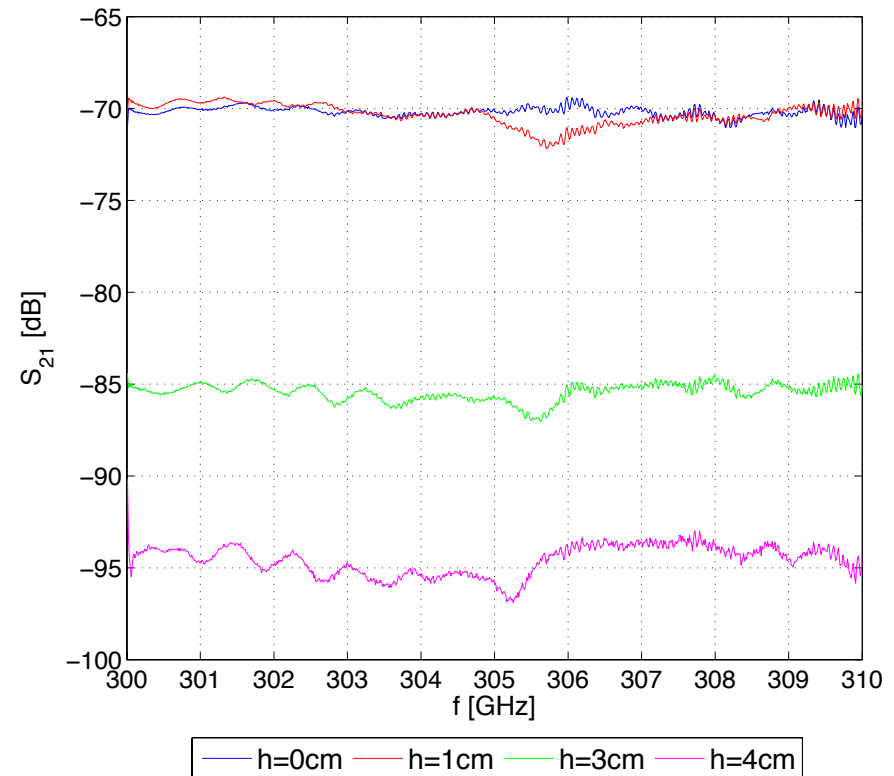
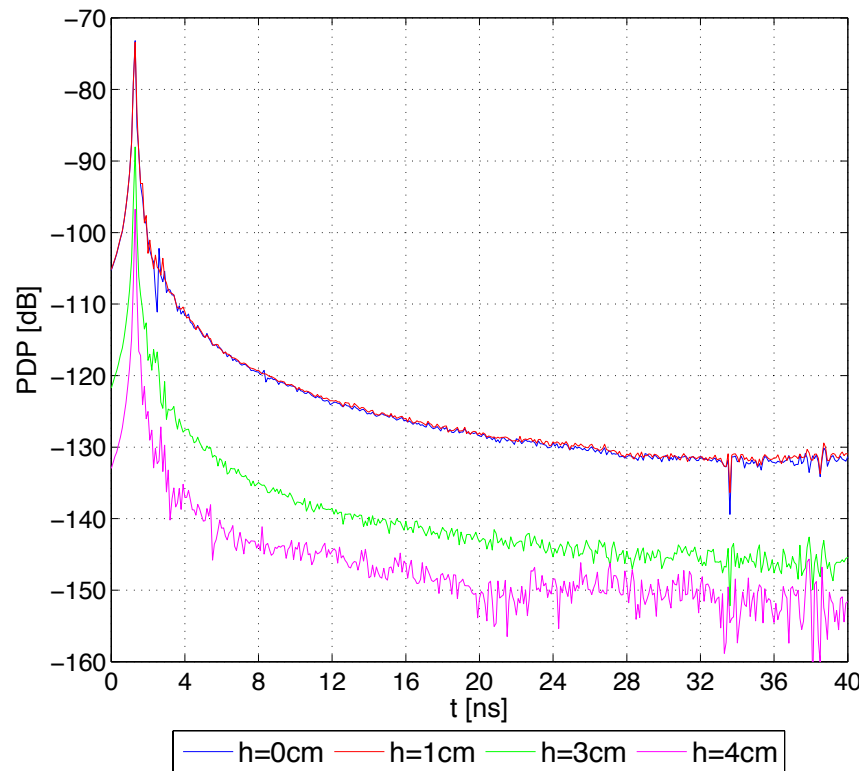

- High additional attenuations for small antenna mispointings
- No real multipath propagation, only reflections due to non-perfect absorber panels

Short Range Channel Measurements (3)

- Module distance $d = 40$ cm:

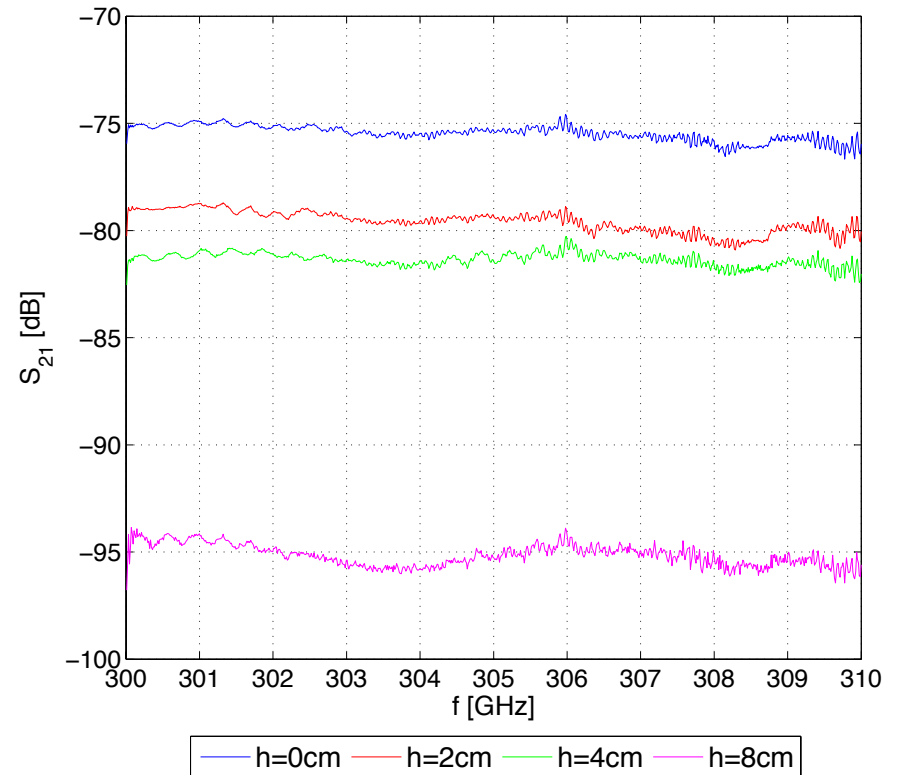
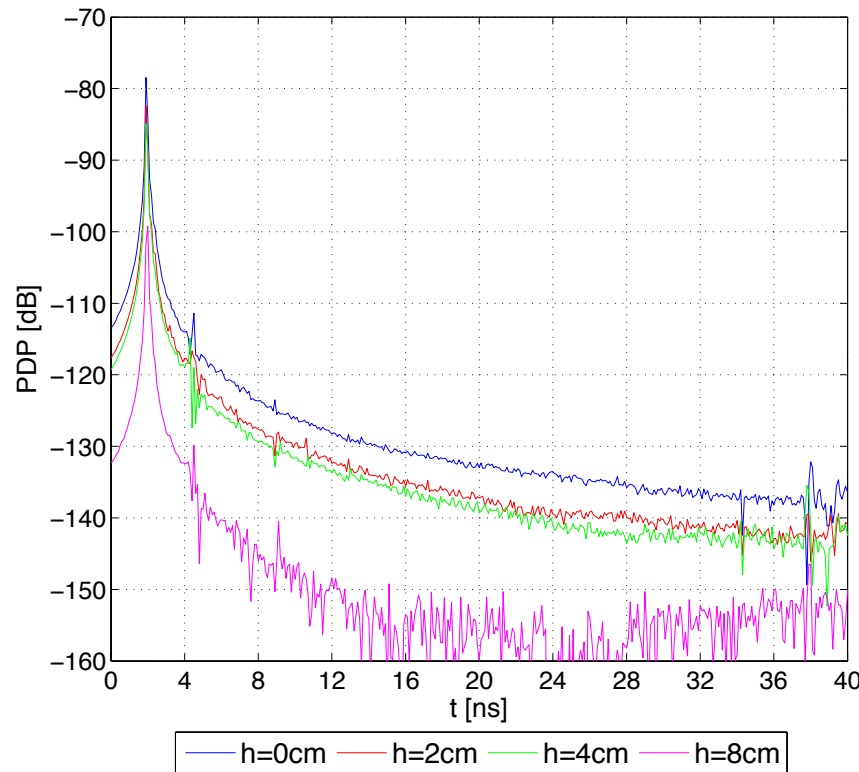

→ Almost flat channels over whole bandwidth

Short Range Channel Measurements (4)

Distance	Mispointing	Theoretical FSL (f = 300 GHz)	Measured propagation loss	RMS delay spread
20 cm	0 cm	68 dB	69.7 dB	0.13 ns
	1 cm	68.02 dB	70.1 dB	0.15 ns
	3 cm	68.1 dB	86.1 dB	0.14 ns
	4 cm	68.18 dB	93.8 dB	0.12 ns
40 cm	0 cm	74.03 dB	75.4 dB	0.18 ns
	2 cm	74.04 dB	79.1 dB	0.17 ns
	4 cm	74.07 dB	81.8 dB	0.2 ns
	8 cm	74.2 dB	95.1 dB	0.2 ns

- Antenna mispointing must be respected in future link budgets
- Channels allow for symbol rates of several GSymbols/s without ISI to be expected

Indoor Channel Measurements (1)

- Exemplary application: Connection of laptop to access point
- Mispointing-dependent measurements

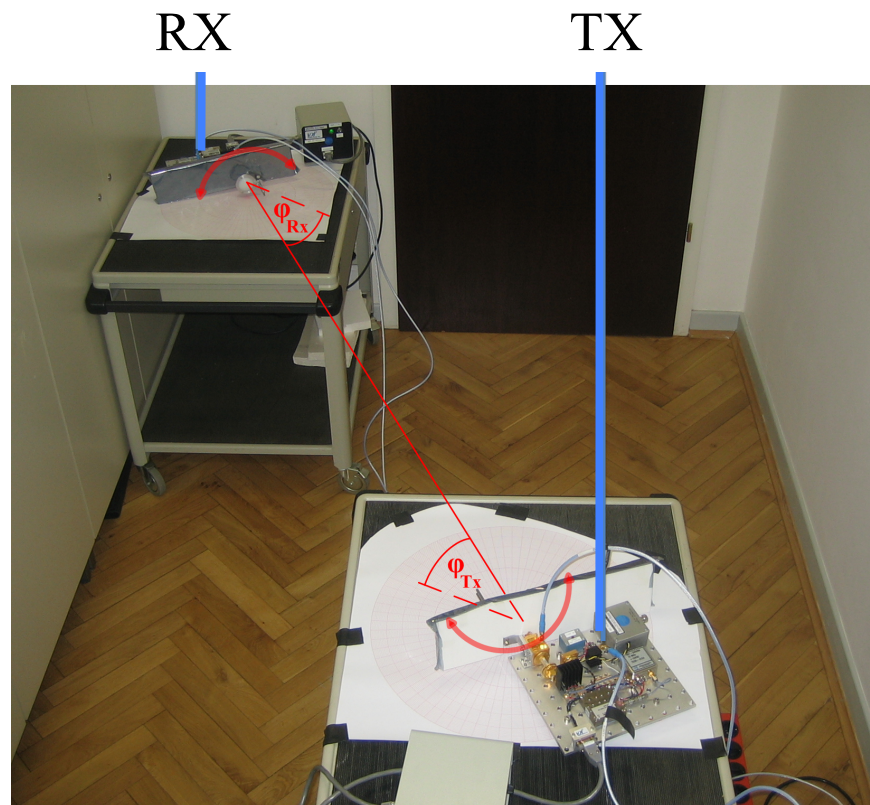

doc.: IEEE 802.15-15-09-0756-00-0thz

Indoor Channel Measurements (2)

- 3D-model of room for ray tracing
- Comparison of measurements and ray tracing simulations

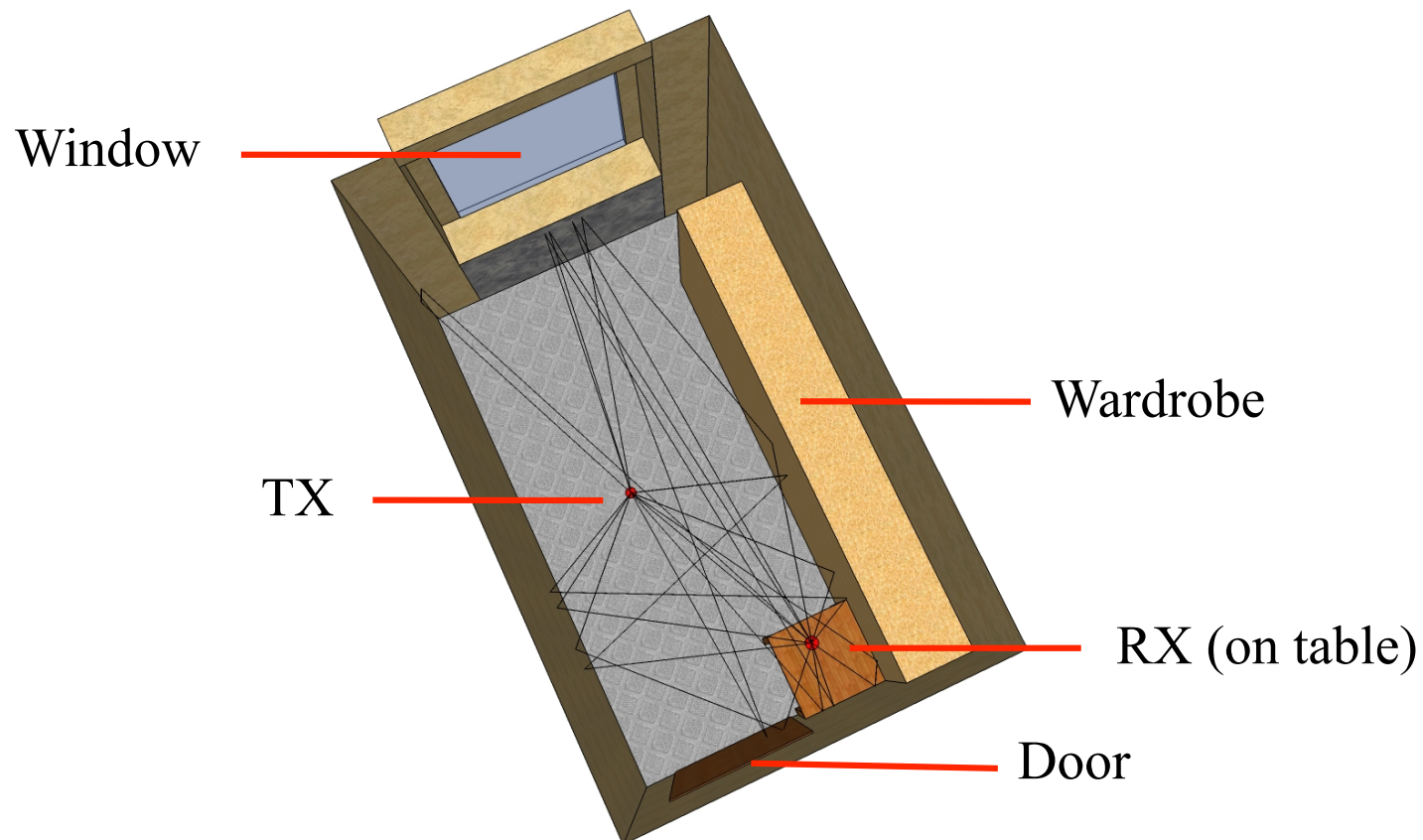

Indoor Channel Measurements (3)

- Measured path loss over AoA/AoD for $f = 300$ GHz:

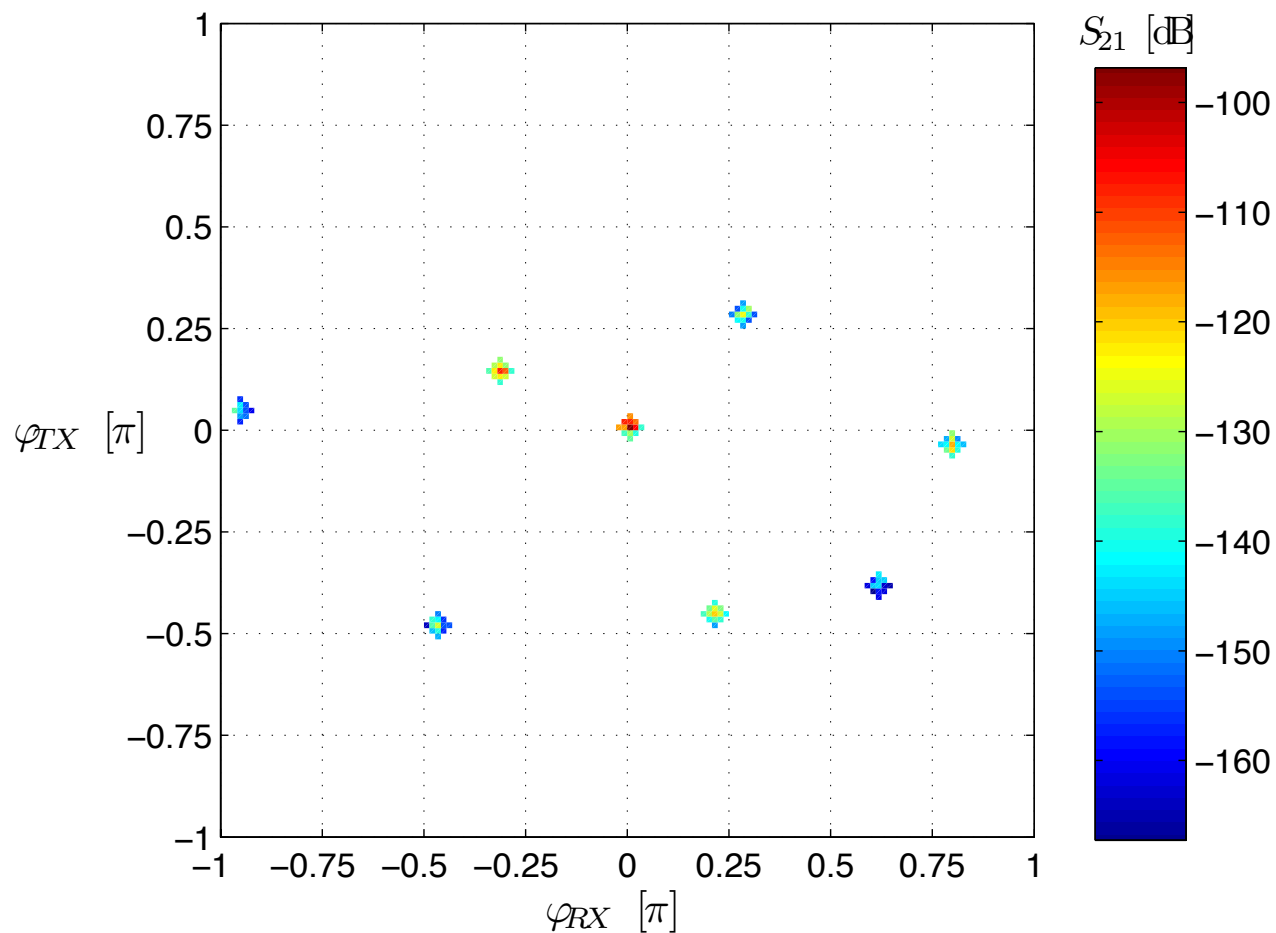

Indoor Channel Measurements (4)

- Composition of complete channel impulse response by addition of single path reponses:

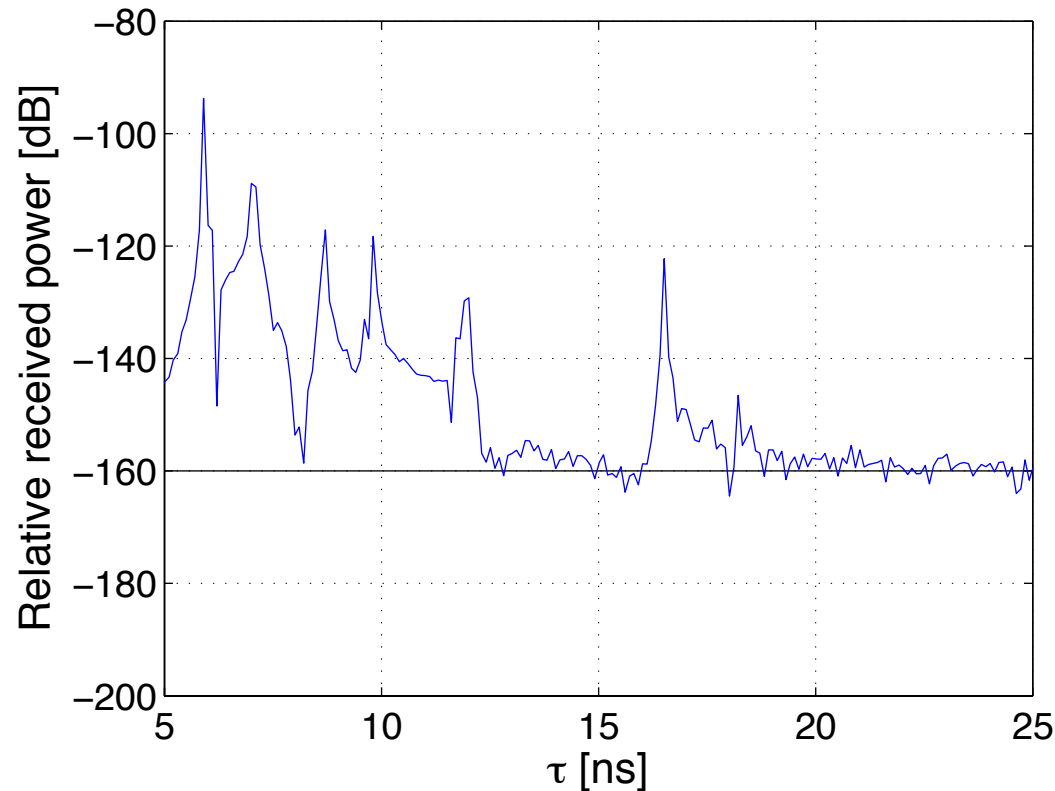

→ Complete CIR and AoAs/AoDs as required, if antenna arrays are employed

Indoor Channel Measurements (5)

- Corresponding transfer function:

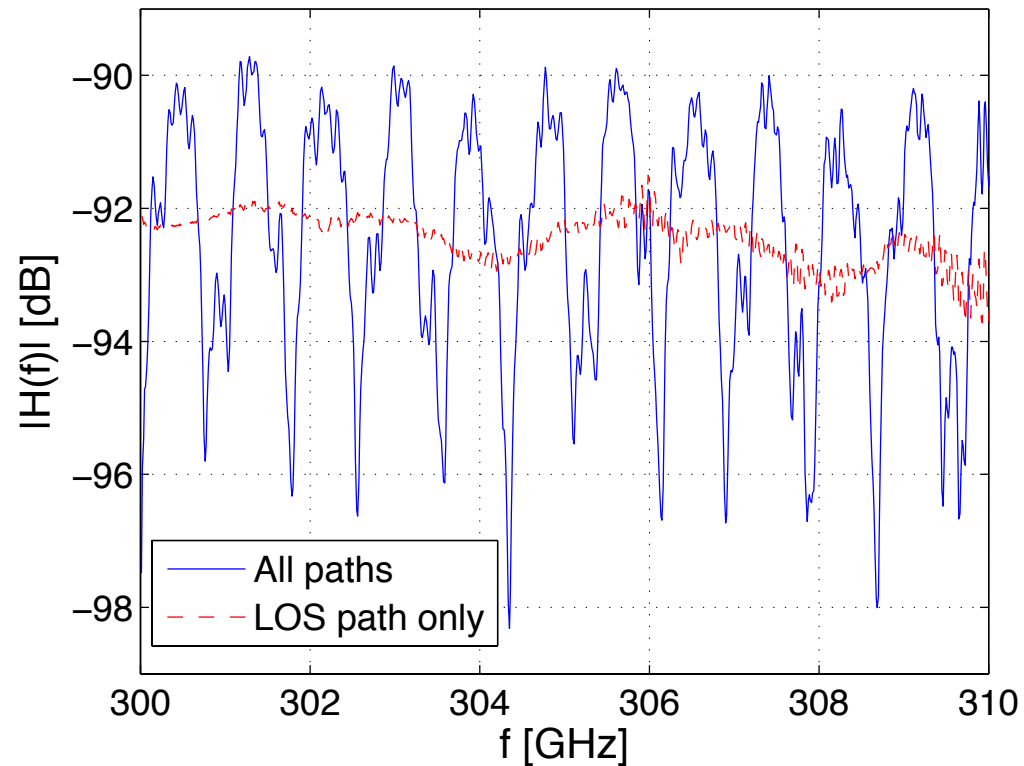

→ Multipath propagation, if no high gain antennas are used

Indoor Channel Measurements (6)

- Reflection losses of building materials necessary for ray tracing simulations

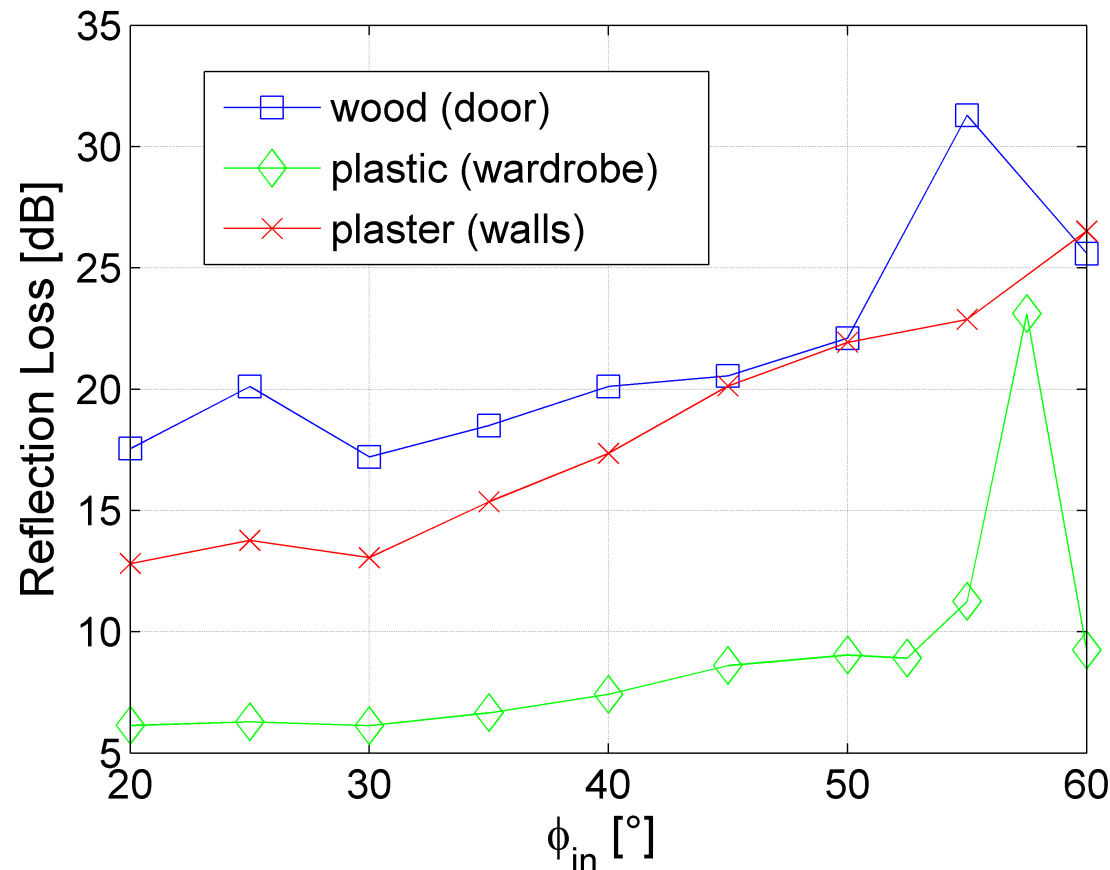

Indoor Channel Measurements (7)

- Propagation mechanisms included in ray tracing simulations:
 - Free space loss
 - Fresnel reflection coefficients
 - Correction of reflection coefficients of rough surfaces by the Rayleigh roughness factor
 - Once scattered rays: implemented by Kirchoff scattering at rough materials
 - Geometrical depolarization by means of the Jones calculus
- Open points:
 - Diffraction, e.g. by the UTD
 - Multilayer materials
 - Incoherent scattering

Indoor Channel Measurements (8)

- Comparison of simulated and measured CIR:

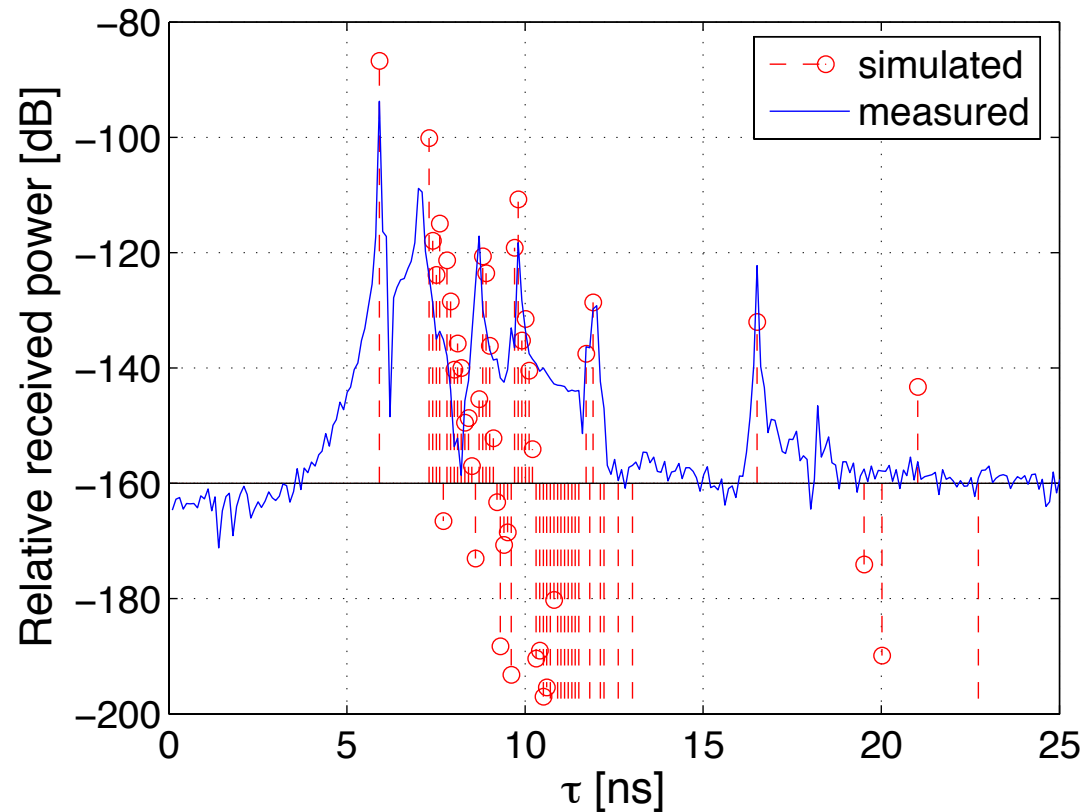

- Good agreement between measurements and simulations
- Small deviation due to non-perfect module alignment

Indoor Channel Measurements (9)

- Comparison of measured and simulated transfer function:

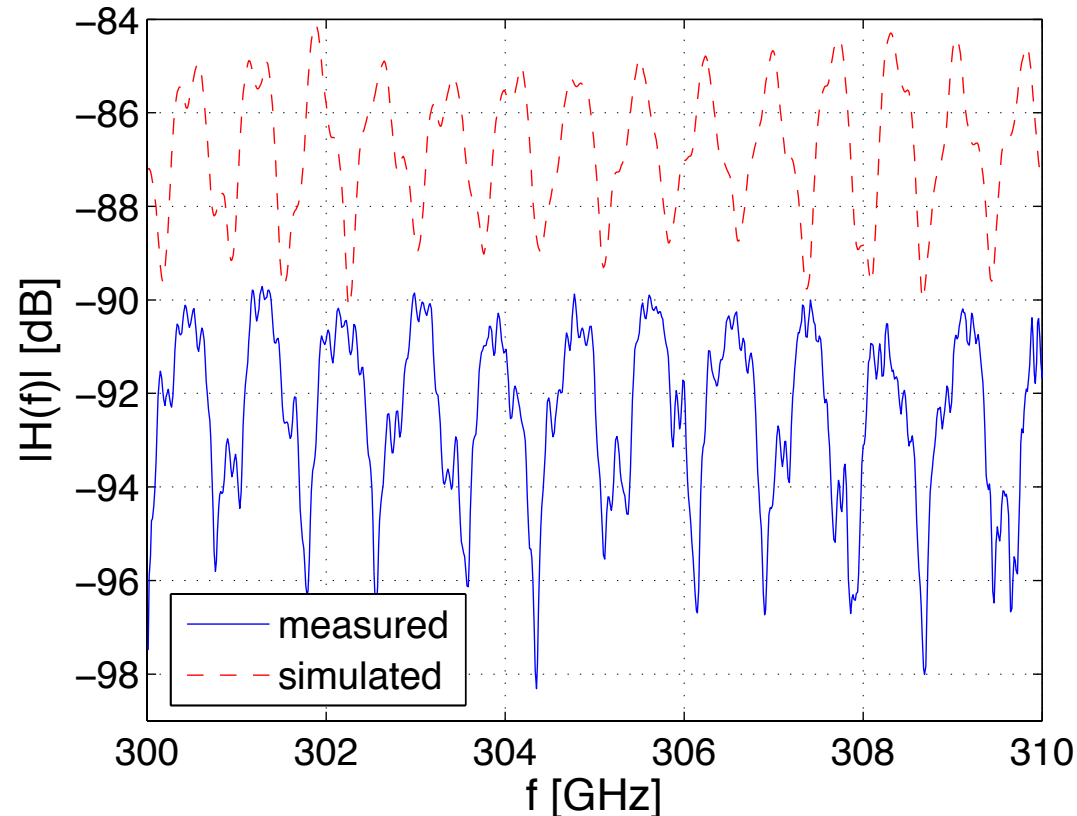

→ Difference caused by non-perfect module placement

→ Ray tracing suitable to derive channel characteristics at 300 GHz

Outline

1. Introduction
2. The Measurement Setup
3. Measurement Results
- 4. Summary/Outlook**

Summary

- A 300 GHz measurement system has been introduced
- Ultra broadband short range channel measurements have been presented
 - No multipaths have been observed due to high gain antennas
 - High mispointing losses must be avoided
 - Symbol rates easily exceeding 1 GSymbol/s can be achieved without ISI
- Indoor channel measurements have been compared to ray tracing simulations
 - Multipath propagation occurs, if no highly directive antennas are employed
 - Complete channel impulse response and AoAs/AoDs are necessary to include antenna arrays in future channel model
 - Ray tracing is well suited for the derivation of a 300 GHz channel model

Outlook

- **All relevant propagation mechanisms** need to be included in ray tracer (e.g. multilayer materials)
 - Further indoor channel measurements required for **calibration of ray tracing algorithm**
- Derivation of first 300 GHz channel model

Thank you for paying attention.

Dipl.-Ing. Sebastian Priebe
priebe@ifn.ing.tu-bs.de