

Project: IEEE P802.15 Working Group for Wireless Personal Area Networks (WPANs)

Submission Title: [SFF PHY revised proposal in Atlanta meeting]

Date Submitted: []

Source: [Hiroshi Harada¹, Fumihide Kojima¹, Sum Chin Sean¹, Ryuhei Funada¹, Takaaki Hatauchi², Minoru Tanabe³, Kentaro Sakamoto⁴, Aiichiro Kashiwagi⁵, Takahiro Banno⁶, Hirohito Nishiyama⁷]

Company [1NICT, 2Fuji Electric, 3Panasonic, 4Tokyo Gas, 5Osaka Gas, 6Toho Gas, 7Mitsubishi Electric Corp.]

Address [13-4, Hikari-no-oka, Yokosuka-shi, Kanagawa239-0847, Japan]

Voice: [1+81-46-847-5074]

FAX: [1+81-46-847-5440]

E-Mail: [f-kojima@nict.go.jp, harada@nict.go.jp]

Re: [In response to TG4g Call for Proposals]

Abstract: [Proposal of PHY and MAC for low-power consumption SUN]

Notice: This document has been prepared to assist the IEEE P802.15. It is offered as a basis for discussion and is not binding on the contributing individual(s) or organization(s). The material in this document is subject to change in form and content after further study. The contributor(s) reserve(s) the right to add, amend or withdraw material contained herein.

Release: The contributor acknowledges and accepts that this contribution becomes the property of IEEE and may be made publicly available by P802.15.

Authors

This is a merged proposal from the following authors

- NICT
- Fuji Electric
- Panasonic
- Tokyo Gas
- Osaka Gas
- Toho Gas
- Mitsubishi Electric Corp.

This merged proposal is supported by:

- Silicon labs

What is revised from the previous Hawaii proposal

- Channelization summarized for allocation on both 950MHz and 400MHz band assuming 200kHz spacing with overlapping
- PHY parameter revision in symbol rate and modulation index
- FEC by systematic convolutional code that effectively realizes low rate transmission
- SFD proposal to identify PHR+PSDU
- PSDU modification for flexibility

Hawaii proposal

- FSK based SUN is considered to work well in Japanese region(400/950MHz) without suffering from multi-path degradation
 - No serious multi-paths are found in the propagation range assumed in Japanese SUN
 - Multi-hop capability for service area expansion could also provide route with less multi-path effects
- Link budget analysis and outdoor experiment results confirm that:
 - Up to 150m propagation range to achieve -60dBm received power with 10mW transmission power
 - 300m with 700mW
 - No notch attenuation more than 20dB over 300m radius area
- Computer simulation results confirm that frames are successfully relayed to the collection station where 80% of all radio links are seriously degraded over 400m x 400m area, while only 20% of frames are successfully sent without multi-hop transmission

Latest status for modulation and channel parameters

- With channelization revisions on both 950MHz and 400MHz thereby number of channels for each rate has been determined
 - Overlapping channels assumed: 400/600kHz width with 200kHz spacing
- Modulation indexes are reconsidered for 200ksymbols/s
 - Previous become (1.0, 0.33) for (200kbps, 400kbps)

For Japanese bands

Note: BT of 0.5 used with GFSK

***; Mandatory mode**

Frequency band (MHz)	Parameter	Low rate 50 kbps		Medium rate 100 kbps	High rate 200/400 kbps
		Non FEC	FEC		
950.9-955.7 (Japan, 23/22 Ch.)	Symbol rate	50ksymbol/s*	100ksymbol/s*	100ksymbol/s*	200ksymbol/s
	Signal bandwidth(kHz)	200	400	400	600
	Channel spacing (kHz)	200	200	200	200
	Modulation	GFSK	GFSK	GFSK	GFSK/4GFSK
	Modulation Index	1.0	1.0	1.0	(1.0, 0.33) for (2, 4GFSK)
	# of channels within band	24	23	23	22
	Channel overlap	N	Y	Y	Y
400-430 (1.0MHz BW) (Japan, 4/5 Ch.)	Symbol rate	50ksymbol/s*	100ksymbol/s*	100ksymbol/s*	200ksymbol/s
	Signal bandwidth(kHz)	400	400	400	600
	Channel spacing (kHz)	200	200	200	200
	Modulation	GFSK	GFSK	GFSK	GFSK/4GFSK
	Modulation Index	1.0	1.0	1.0	(1.0, 0.33) for (2, 4GFSK)
	# of channels within band	5 (TBD)	4 (TBD)	4 (TBD)	3(TBD)
	Channel overlap	N	Y	Y	Y

Allocation on 950MHz band

- Channel BW: 400kHz for 50/100kbps, 600kHz for 200/400kbps
 - 2 or 3 bundling of 200kHz BW channels
- Channel spacing: 200kHz
 - Channel overlap is necessary to accommodate with Japanese regulatory requirements

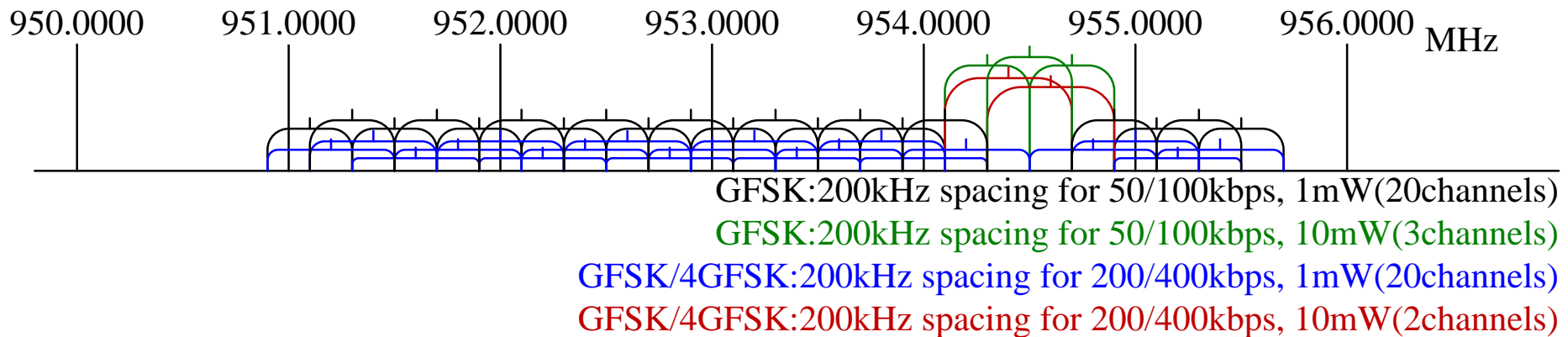

Allocation on 400MHz band

- About 1MHz system bandwidth are under consideration out of 400-430MHz band
- Channel allocation is similarly done to 950MHz case

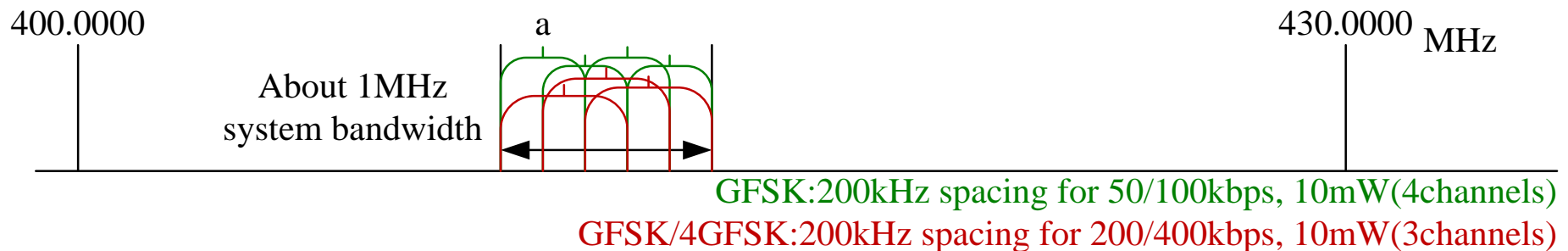

Allocation Table

Channel page (decimal)	Channel page (binary) (b31, b30, b29, b28, b27,)	Channel number (decimal)	Channel number description
6	0 0 1 1 0		
7	0 0 1 1 1	0 - 10	(additional) Channels 0 to 10 in 950 MHz band using GFSK at 100 kbps
		11 – 26	Reserved
8	0 1 0 0 0	0 - 22	Channels 0 to 22 in 950 MHz band using GFSK at 50 kbps
		23 - 26	Reserved
9	0 1 0 0 1	0 - 21	Channels 0 to 21 in 950 MHz band using GFSK at 200 kbps
		22 - 26	Reserved
10	0 1 0 1 0	0 - 21	Channels 0 to 21 in 950 MHz band using 4GFSK at 400 kbps
		22 - 26	Reserved
11	0 1 0 1 1	0 - 3	Channels 0 to 3 in 400 MHz band using GFSK at 100 kbps
		4- 7	Channels 4 to 7 in 400 MHz band using GFSK at 50 kbps
		8 - 10	Channels 8 to 10 in 400 MHz band using GFSK at 200 kbps
		11 - 13	Channels 11 to 13 in 400 MHz band using 4GFSK at 400 kbps
		14-26	Reserved
6 12-31	0 1 1 0 0 - 1 1 1 1 1	Reserved	

Backup: MCS determination for Japan band

950MHz band

Data rate	Parameter candidate				T-96 compliance	Note; "Why it must be eliminated?" (Need to be validated)
	Mod. scheme	Symbol rate	Modulation index	Channel bundling		
Low and Medium rate (50 and 100kbps)	2GFSK	100ksps	1.0	3	Y	Excess bandwidth
				2	Y	Tentatively employed (same as 802.15.4d)
				1	N	-
			0.5	3	Y	Excess bandwidth
				2	Y	Worse sensitivity than MI:1.0
				1	???	???
			0.3	3	Y	Excess bandwidth
				2	Y	Worse sensitivity than MI:1.0
				1	???	???
High rate (200/400kbps)	2GFSK	200ksps	1.0	3	Y	May better accommodate with 400kbps
				2	N	
				1	N	
			0.5	3	Y	Better accommodate with 400kbps
				2	Y	Best choice for performance and spectrum efficiency
				1	N	
			0.3	3	Y	Worse sensitivity than MI:0.5
				2	Y	Worse sensitivity than MI:0.5
				1	N	-
	4GFSK	200ksps	1.0	3	N	-
				2	N	-
				1	N	-
			0.5	3	Y	Best choice for performance and spectrum efficiency
				2	N	-
				1	N	-
0.33	3	Y	Better accommodate with 200kbps			
	2	Y	Possible NG for practical design (little margin)			
	1	N	- (anticipated from 2 ch bundling simulation)			

Appendix 1: PSD on 950MHz for 400kHz-bandwidth

Frequency band	Frequency	Absolute limit
950 MHz band (for 10mW GFSK channels)	$ f-f_c > 0.4\text{MHz}$	-39dBm
	$0.4\text{MHz} > f-f_c > 0.2\text{MHz}$	-18dBm (within 200kHz width)

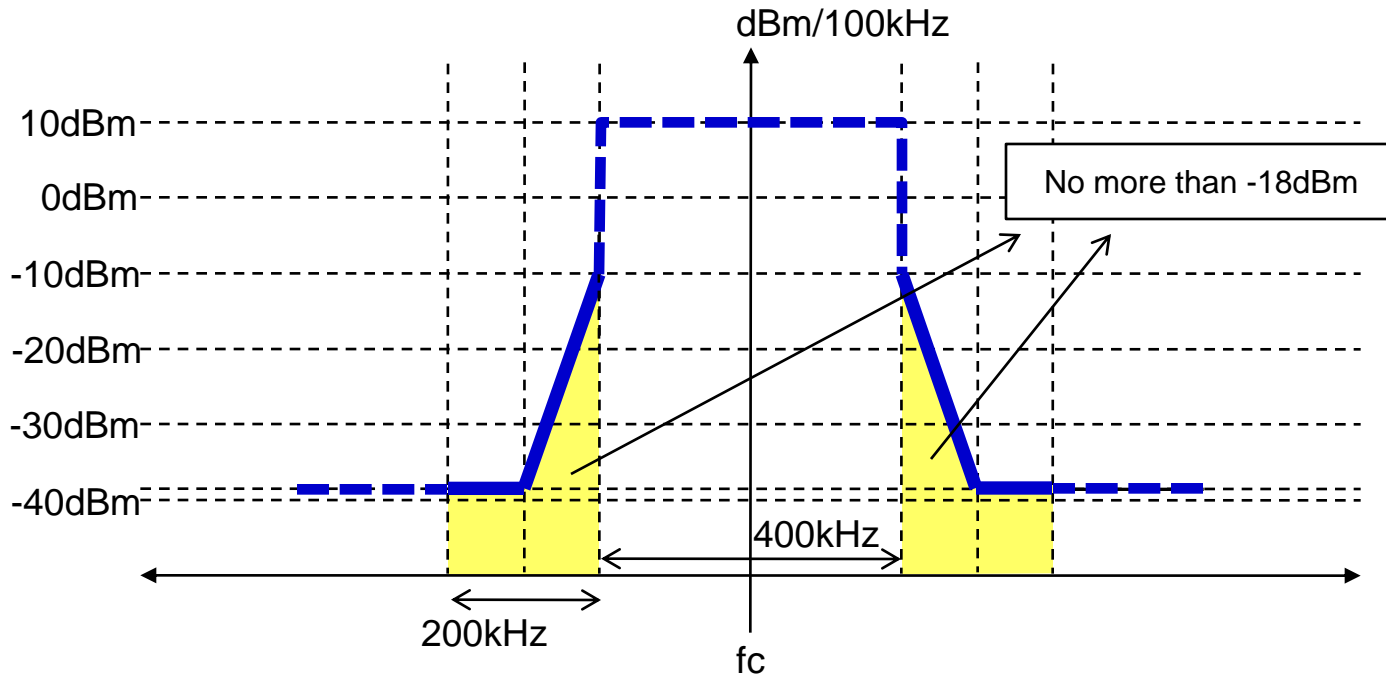

Appendix2: PSD on 950MHz for 600kHz-bandwidth

Frequency band	Frequency	Absolute limit
950 MHz band (for 10mW GFSK channels)	$ f-f_c > 0.5\text{MHz}$	-39dBm
	$0.5\text{MHz} > f-f_c > 0.3\text{MHz}$	-18dBm (within 200kHz width)

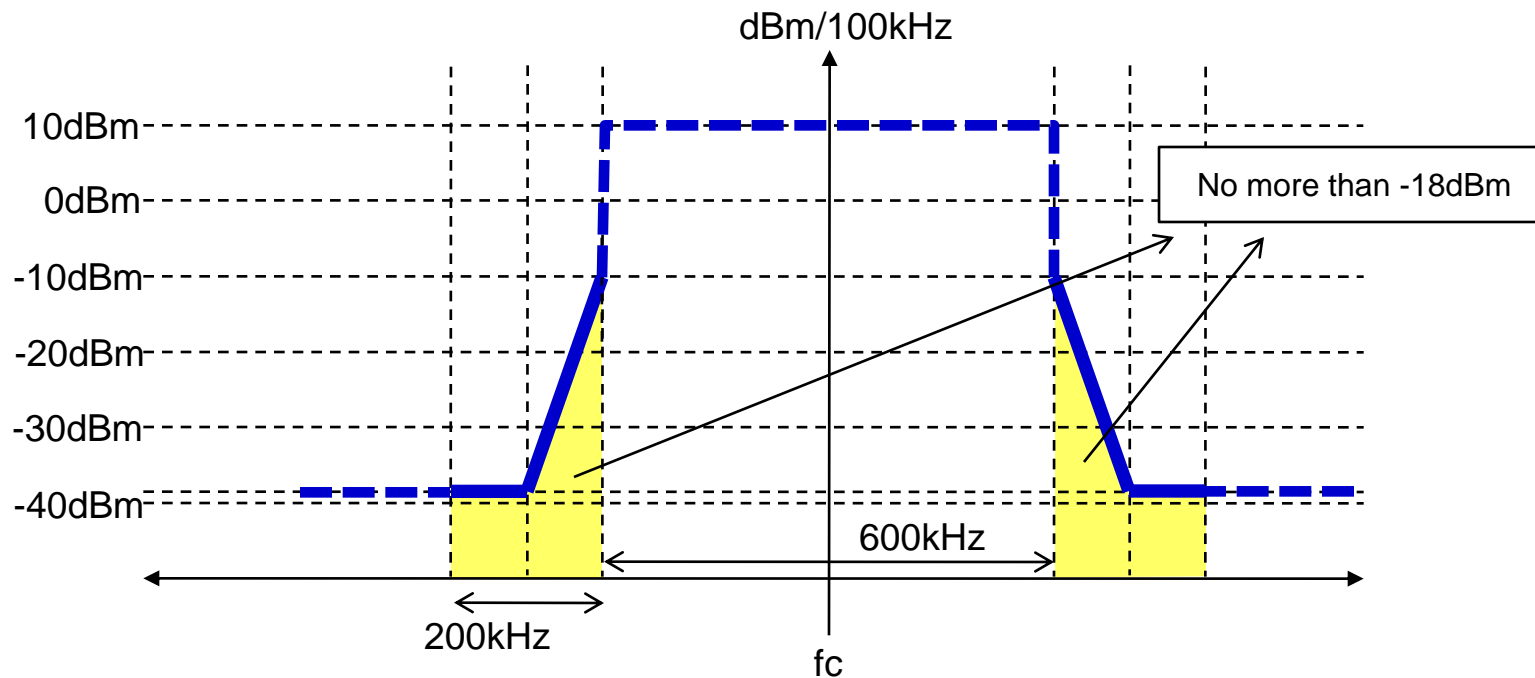

PHR coding and whitening

- SFF proposes data whitening on whole PHR + PSDU input, as in 15.4d
- Since SFF employs single sequence for scrambling, the received PHR part can be read after descrambling without scrambler seed information
- Then, the following PSDU with variable length can be successfully received based on the PSDU length information in the descrambled PHR

Modulation and coding for each field

- First cut of PPDU design

SHR		PHR	PSDU
Preamble	SFD		

50kbps (mandatory)	50ksymbols/s (no spreading, no FEC, 2GFSK)	50ksymbols/s (no spreading, no FEC, 2GFSK)	50ksymbols/s (no spreading, no FEC, 2GFSK)
50kbps (optinal)	100ksymbols/s (Spreading factor:2* , no FEC, 2GFSK)	100ksymbols/s (no spreading, no FEC, 2GFSK)	100ksymbols/s (no spreading, FEC, 2GFSK)
100kbps (mandatory)	100ksymbols/s (no spreading, no FEC, 2GFSK)		
200kbps (optional)	200ksymbols/s (no spreading, no FEC, 2GFSK)		
400kbps (optional)	200ksymbols/s (no spreading, no FEC, 2GFSK)		200ksymbols/s (no spreading, no FEC, 4GFSK)

*; Spreading methods would be discussed

Systematic convolutional coding for FEC

- Better coding gain with moderate gate count (10k@R=1/2, K=5,3 soft bit) is achieved.
- Same as other systematic coders, a systematic convolutional encoder **outputs original input data** (see the following figure), which means the receiver can **demodulate the received encoded data without Viterbi decoding**.
 - The receiver can choose decoding method (Viterbi decoding or without-decoding) according to link performance or power consumption he want to achieve.
 - Manufacturer also can decide to implement the Viterbi decoder in the receiver according system they use.
- Smaller K is possible to use for lower burden with moderate coding gain.

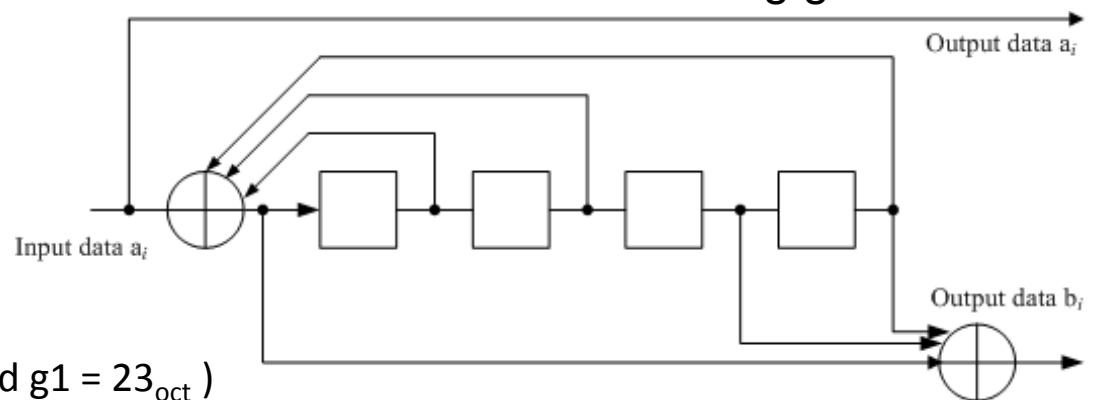

The proposed encoder
(generator polynomials: $g_0 = 35_{\text{oct}}$ and $g_1 = 23_{\text{oct}}$)

Computer simulation for evaluating

- The following PHY Set candidates are evaluated by computer simulation
 - 40kbps transmission (40ksymbol/s, no FEC)
 - 50kbps transmission (50ksymbol/s, no FEC)
 - 100kbps transmission (100ksymbol/s, no FEC)
 - 46.7kbps transmission (100ksymbol/s, BCH(15, 7, 2))
 - 73.3kbps transmission (100ksymbol/s, RS(15, 11, 2))
 - 50kbps transmission (100ksymbol/s, Systematic CC(R=1/2, K=5))

Evaluation results

- When decoded by the receiver, it can achieve 50kbps rate transmission performance with 5.1dB coding gain compared with 50kbps based on 50ksymbol/s

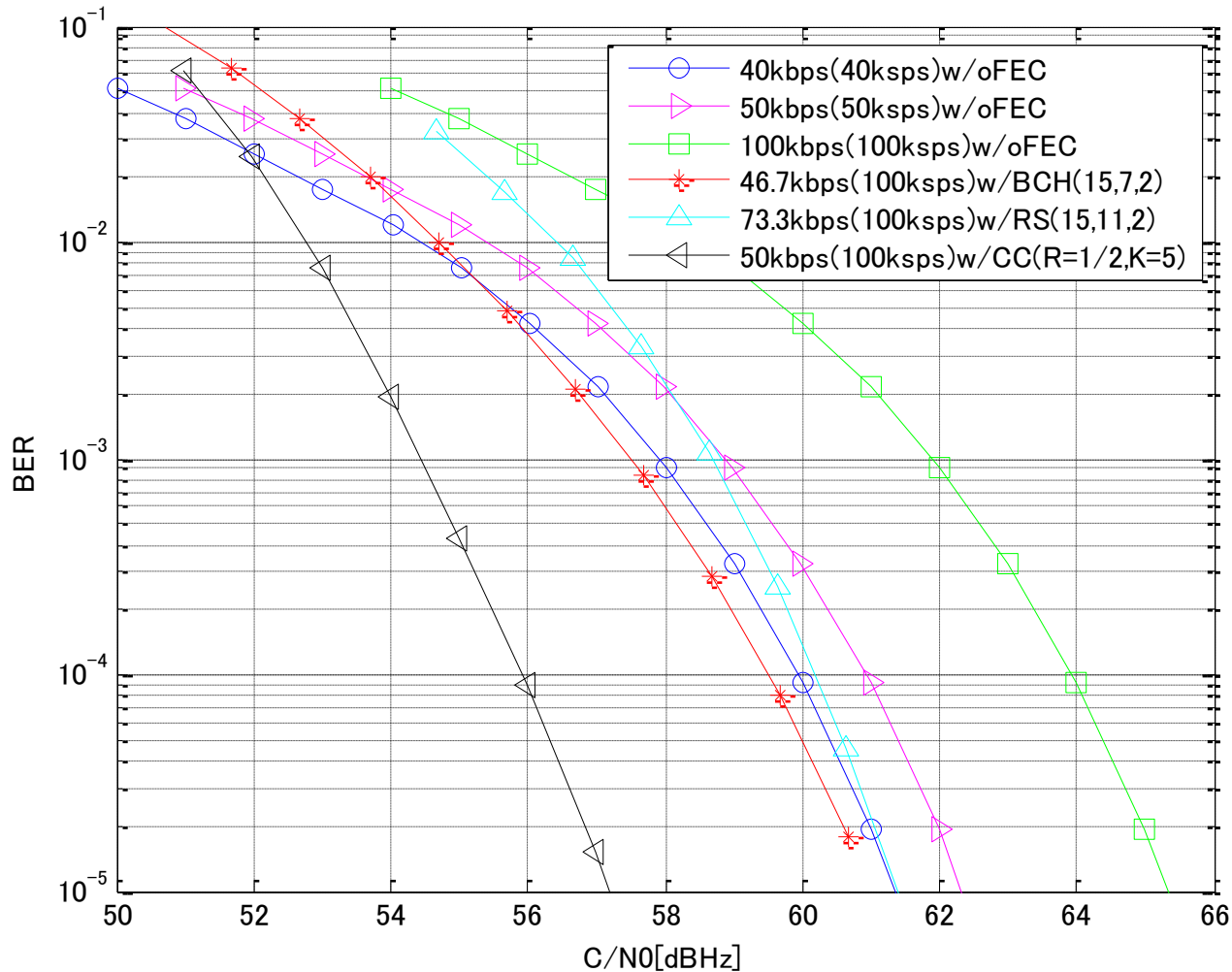

FEC candidates evaluated

- FEC candidates listed in the following table were evaluated in NICT for the lowest data-rate mode using 2GFSK with 100 ksymbol/s
- We concluded that **plan A** is the best in the all

Plan	PHR/PSDU FEC	Information bit rate	Coding gain (@BER = 10^{-5} in AWGN)	Required CNR (@BER = 10^{-5} in AWGN)
A	Systematic convolutional code with Viterbi dec. (R=1/2,K=5)	50 kbps	5.1 dB	7.2dB
B	RS(15,11,2)	73.3 kbps (=11/15*100 ksymbol/s)	2.5 dB	11.2dB
C	BCH (15,7,2)	46.7 kbps (=7/15*100 ksymbol/s)	0.9 dB	11.1dB

Proposed SFD patterns

- Four types of SFD pattern proposed to identify other FSK camps and No-FEC mode:

SHR (repetitions of [-1 1])	SFD		PHR
• SFD#1	SFD1(8btis): Golay seq <i>a</i>	SFD2(8btis): Golay seq <i>-b</i>	
• SFD#2	SFD1(8btis): Golay seq <i>b</i>	SFD2(8btis): Golay seq <i>a</i>	
• SFD#3	SFD1(8btis): Golay seq <i>b</i>	SFD2(8btis): Golay seq <i>-a</i>	
• SFD#4	SFD1(8btis): Golay seq <i>a</i>	SFD2(8btis): Golay seq <i>b</i>	

- All SFD patterns composed of 8-bit complementary Golay sequences *a* and *b*:

$$a = [-1 \quad 1 \quad -1 \quad -1 \quad -1 \quad -1 \quad -1 \quad 1]$$

$$b = [1 \quad -1 \quad 1 \quad 1 \quad -1 \quad -1 \quad -1 \quad 1]$$

Appendix3: Features of Golay sequences

- Golay sequences consist of a pair of binary sequences **a** and **b** with length of 2^N chips, where N is a positive integer.
- Sum of the autocorrelations results in unique main peak without side-lobe.
- Golay sequences can carry 2-bit (4-state) information by using **+a**, **-a**, **+b** and **-b**.

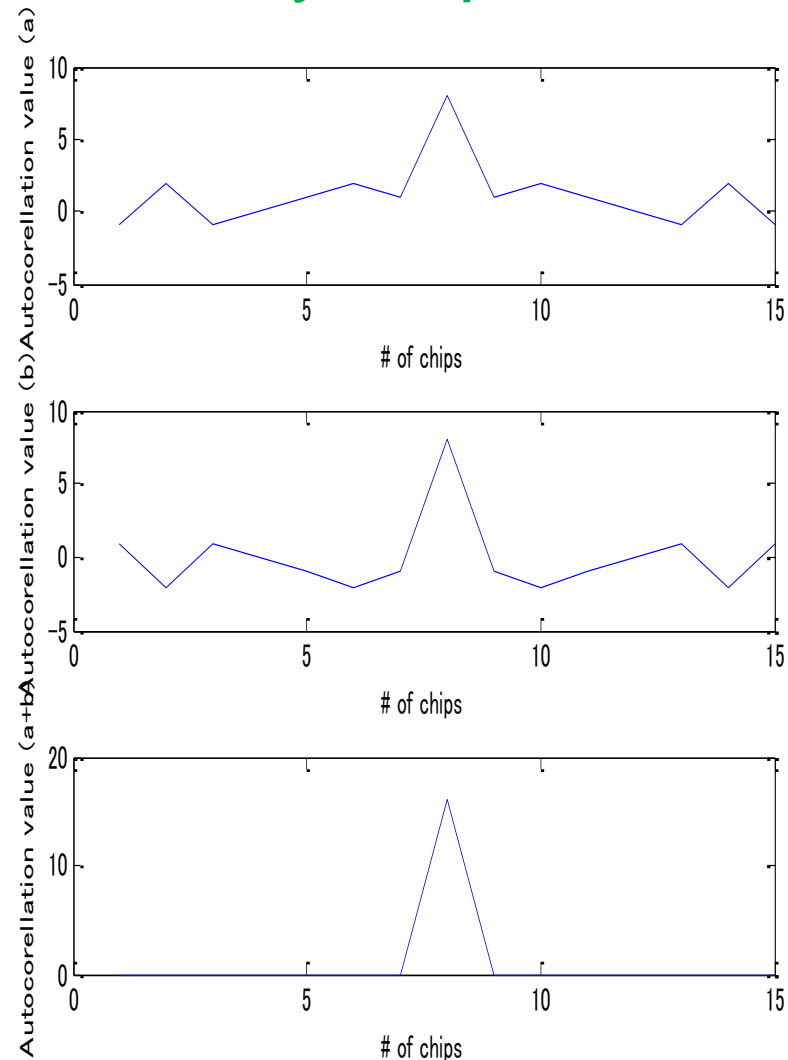

SFF PPDU

- Different SFD to distinguish between 802.15.4d and 802.15.4g in 950MHz band in Japan
 - One octet (802.15.4d) vs. two octets
- Support for short frame (with CRC-16) for efficiency
- Frame control field to define
 - CRC option (16 or 32)
 - Others (TBD)
 - FEC option
 - Data rate (modulation order, 2/4GFSK for high data rate)
- 2bit scrambler seed field is eliminated in the latest proposal

Proposed PPDU format

Octet: variable	2	2			variable	2/4
Bit: variable	16	4	1	11	variable	16/32
SHR		PHR			PSDU	
Preamble	SFD	Frame control		Frame length (MSB first)	PHY payload excluding FCS	FCS
		Reserved	CRC option			

* FEC option
 * Data rate (2/4 GFSK)
 -> no change in symbol rate
 * Others ...

1: CRC-16
 0: CRC-32