

Project: IEEE P802.15 Working Group for Wireless Personal Area Networks (WPANs)

Submission Title: [Merged PHY and MAC Proposals for low-power consumption SUN revised for Hawaii]

Date Submitted: []

Source: [Hiroshi Harada¹, Fumihide Kojima¹, Sum Chin Sean¹, Takaaki Hatauchi², Minoru Tanabe³, Kentaro Sakamoto⁴, Aiichiro Kashiwagi⁵, Takahiro Banno⁶, Hirohito Nishiyama⁷]

Company [1NICT, 2Fuji Electric, 3Panasonic, 4Tokyo Gas, 5Osaka Gas, 6Toho Gas, 7Mitsubishi Electric Corp.]

Address [13-4, Hikari-no-oka, Yokosuka-shi, Kanagawa239-0847, Japan]

Voice: [1+81-46-847-5074]

FAX: [1+81-46-847-5440]

E-Mail: [f-kojima@nict.go.jp, harada@nict.go.jp]

Re: [In response to TG4g Call for Proposals]

Abstract: [Proposal of PHY and MAC for low-power consumption SUN]

Notice: This document has been prepared to assist the IEEE P802.15. It is offered as a basis for discussion and is not binding on the contributing individual(s) or organization(s). The material in this document is subject to change in form and content after further study. The contributor(s) reserve(s) the right to add, amend or withdraw material contained herein.

Release: The contributor acknowledges and accepts that this contribution becomes the property of IEEE and may be made publicly available by P802.15.

Authors

This is a merged proposal from the following authors

- NICT
- Fuji Electric
- Panasonic
- Tokyo Gas
- Osaka Gas
- Toho Gas
- Mitsubishi Electric Corp.

This merged proposal is supported by:

- Silicon labs

What is revised from the Sun Francisco meeting

SFF(Short Frame FSK) proposal that is composed of the following modifications

- PPDU format revised
 - Efficient transmission for short frame is considered
- PHY mode operation is considered
 - Concept of common signaling (CR) is proposed with operational rules
- Performance for Japanese SUN with multi-path characteristics are studied
 - Outdoor experiment results and computer simulation results are reported

San Francisco Proposal (09/478r3)

Summary of Sun Francisco proposal

- Confirmation of proposal on the following PHY with MAC modification
 - PHY: modification from 15.4 to support low-power multi-hop transmission for meter reading utility
 - 950MHz, 400MHz and lower frequency for simple single carrier transmission
 - 200kHz channel spacing assuming two carrier bundling to support 400kHz signal bandwidth
 - 50kbps(2GFSK), 100kbps(2GFSK), 200kbps(2GFSK; Option), 400kbps(4GFSK; Option)
 - No SS option
 - MAC: modification and addition of functions on the basis of 15.4MAC
 - See 09/478r3 in detail

PPDU format revision

PPDU format proposal for short frame transmission

- Different SFD to distinguish between 802.15.4d and 802.15.4g in 950MHz band in Japan
 - One octet (802.15.4d) vs two octets
- Support for short frame (with CRC-16) for efficiency
- Frame control field to define
 - FEC option
 - Data rate (modulation order, 2/4GFSK for high data rate)
 - CRC option (16 or 32)

Proposed PPDU format

Octet: variable	2	2			variable	2/4
Bit: variable	16	4	1	11	variable	16/32
SHR		PHR			PSDU	
Preamble	SFD	Frame control CRC option		Frame length (MSB first)	PHY payload excluding FCS	FCS

- * FEC option
- * Data rate (2/4 GFSK)
-> no change in symbol rate
- * Others ...
- 0: CRC-16 (mandatory)
- 1: CRC-32 (optional)

Concept of Unified FSK Framework

- Supporting the “Unified FSK Framework (UFF)” that consists of PHY specifications from three FSK camps

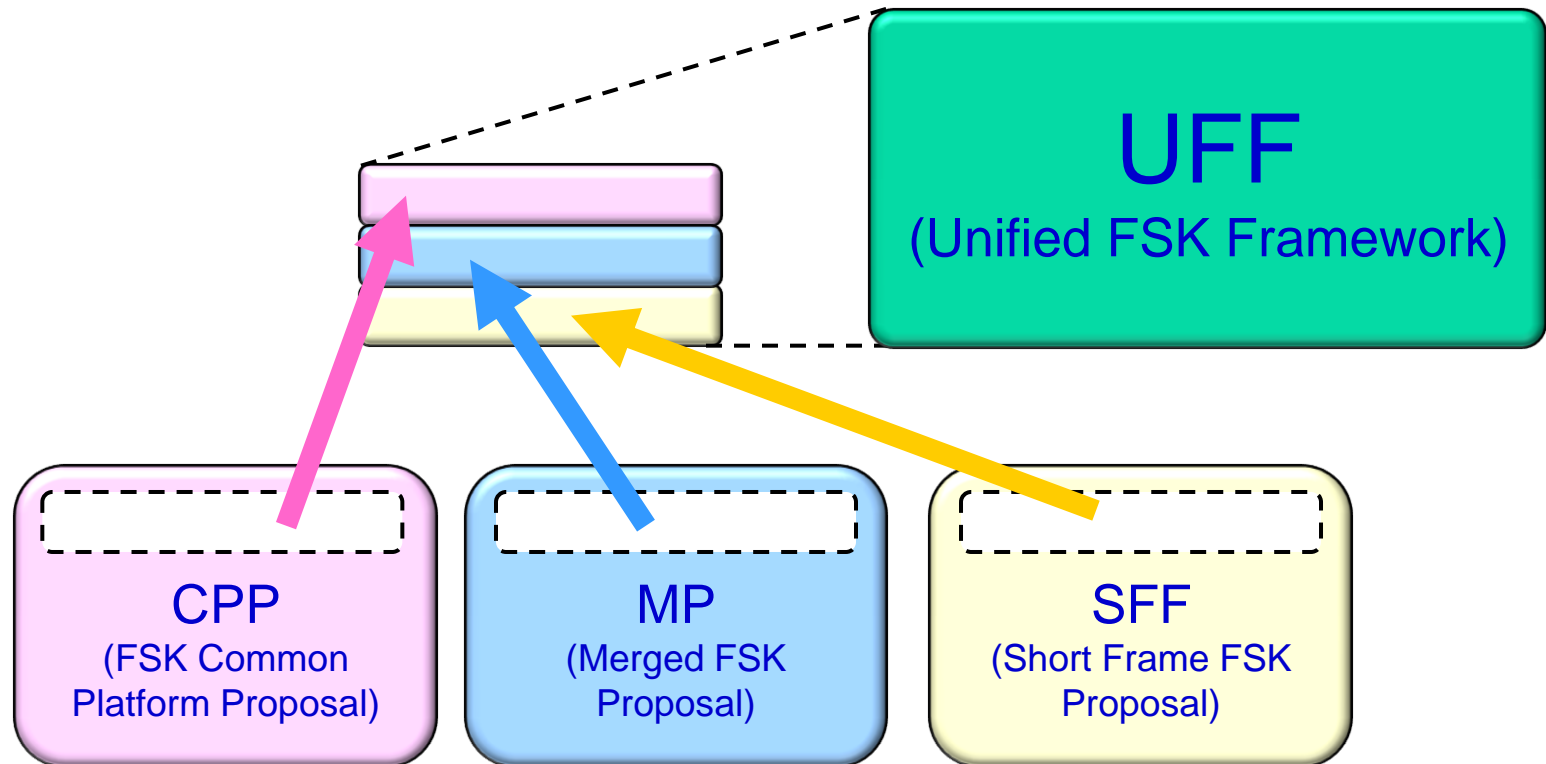

PPDU compatibility

- Desire to get to a common PPDU format, but work is still in progress. Current state shown below (MP PHR needs to be updated to the latest proposal – see document #0628)
- SFD indicates the employed PHR setting out of the following capabilities
 - 15.4d PHR setting (by 0xDD4H?)
 - SFF PHR setting (by 0XXXX)
 - CPP PHR setting (by 0YYYY)
 - MP PHR setting (by 0xAA2D)
- Mandatory/Optional PHR can be decided when “common mode signal” is determined

Compatible PPDU format

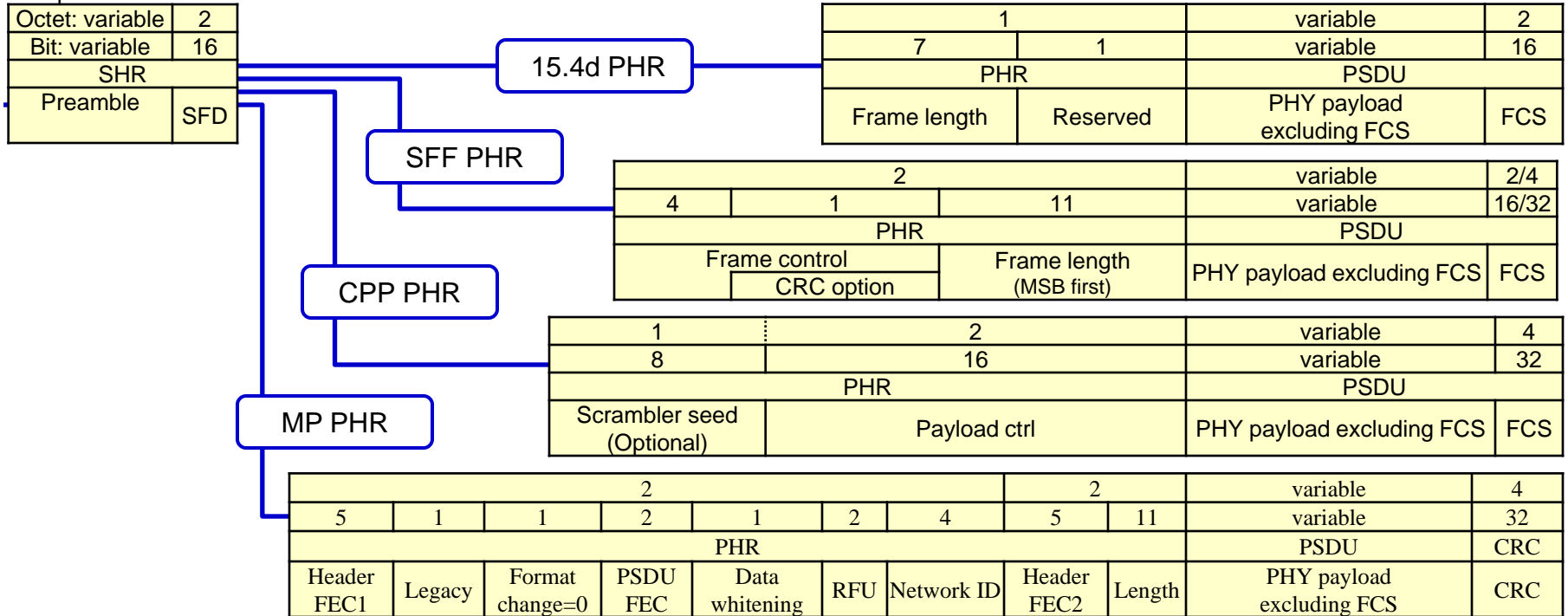

Multi PHY Mode Operation in PAN

~ Basic Common Signaling Rules and MAC Operation Description ~

Summary

- This document proposes the employment of Common Signaling (CS) for multi-PHY-mode-management in a single PAN
- This document draws four mandatory rules for the usage of CS
- This document also describes the MAC operation procedures and identified the signaling that are mandated to employ the CS
- This document reflects NICT's preference in multi-PHY mode management solution

Motivation

- A total of 3 PHY modes are proposed as potential candidates for the TG4g PAN
 - FSK
 - OFDM
 - DSSS
- A mechanism that enables coexistence among the three PHY modes in a single PAN must be specified to avoid mutual co-channel interference
- A mechanism that enables interoperability among the three PHY modes is preferable

Proposed Solution

- This document specifies a common signaling (CS) design as the bridge for synchronization control among three PHY modes
- The CS is a PHY layer specification that has to be supported by all three candidate PHY modes
- Several CS-related rules are specified to facilitate the coexistence and interoperability among candidate PHY modes

CS-related Rules

- All devices shall be able to transmit and receive the CS
- The CS shall be mandatory for the following frame types in CSMA/CA:
 - Beacon frame
 - MAC command frames
- The CS shall be used for the following MAC functionalities
 - Starting and maintaining PANs
 - Association/disassociation
 - Device synchronization
 - Guaranteed time-slot (GTS) allocation and management
- The CS shall be used in the CSMA/CA-based contention access period (CAP)

MAC Operation Description (1/6)

- The detailed MAC operation description is presented in the following slides
- The simplified message sequence charts (MSCs) show the command/control signaling exchange and data transmission
- In the MSCs, the signal in yellow boxes indicate that the CS is mandatory, and the boxes in green indicate that any of the candidate PHY modes can be used
- The MSCs are for beacon-enabled PANs
- MCSs for non-beacon-enabled PANs as for CS employment is TBD

MAC Operation Description (2/6)

~MSC for Association~

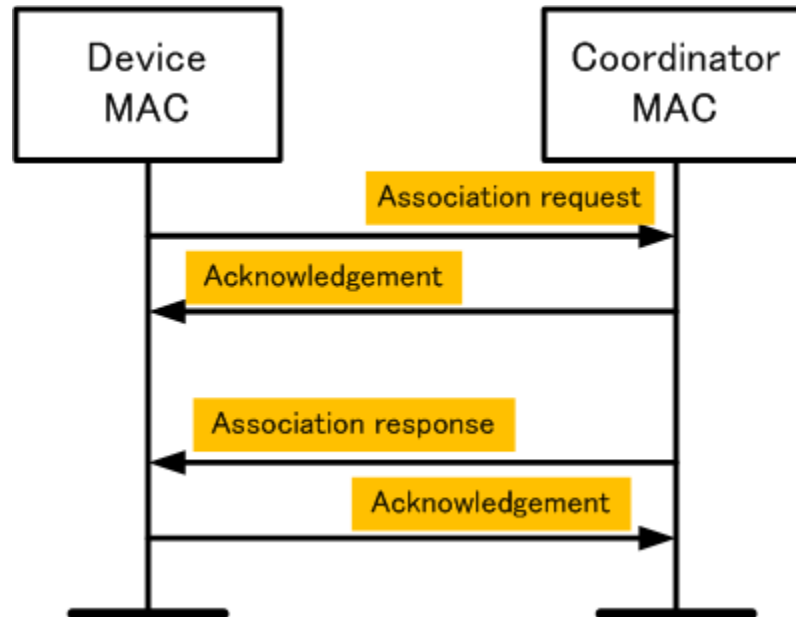

MAC Operation Description (3/6)

~MSC for Disassociation~

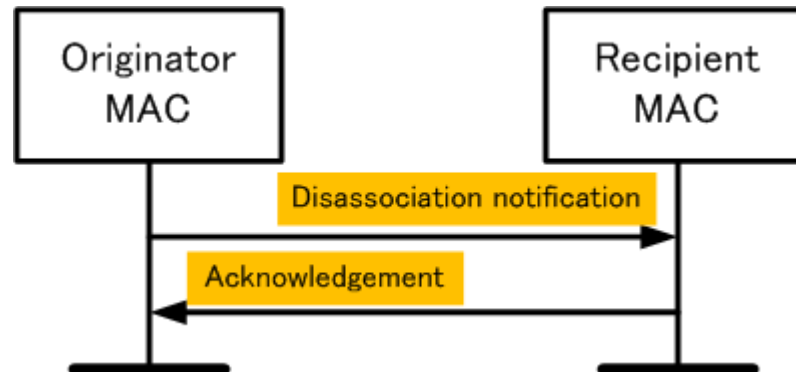

MAC Operation Description (4/6)

~MSC for GTS Allocation~

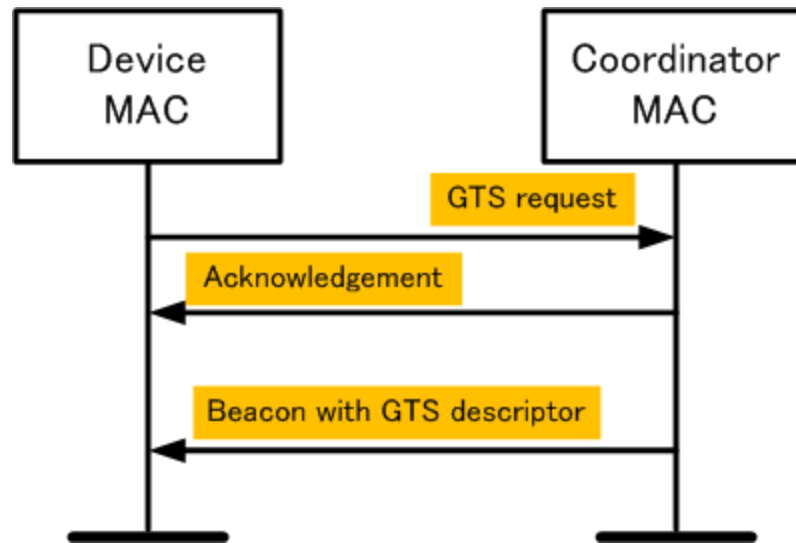

MAC Operation Description (5/6)

~MSC for GTS Deallocation~

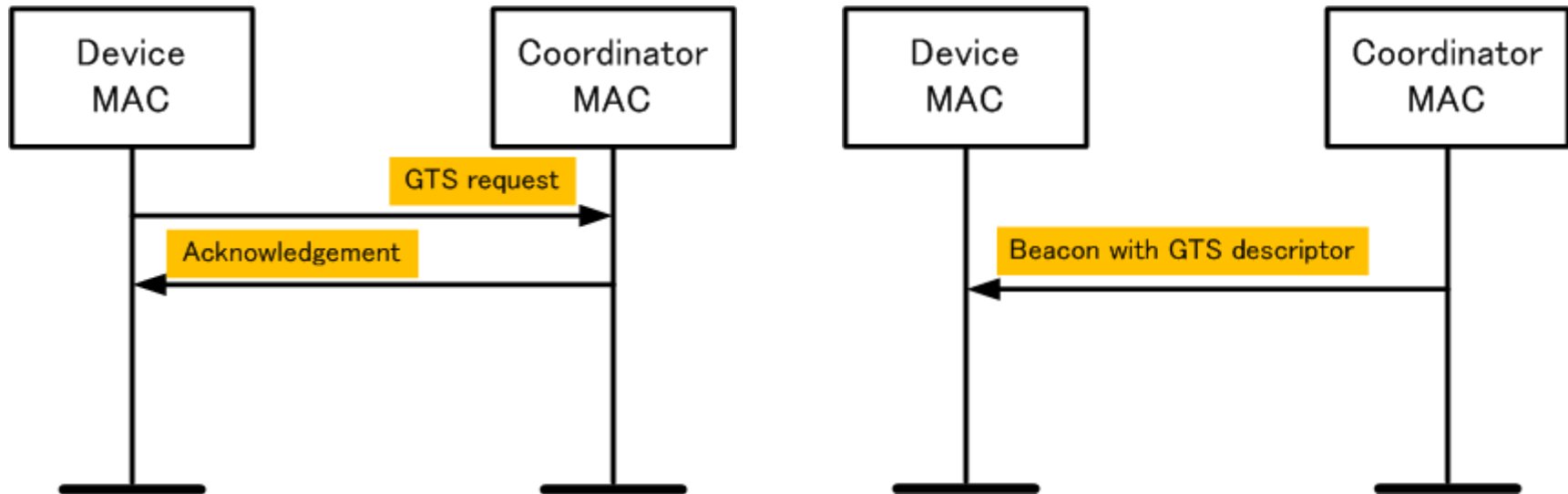

Initiated by network device

Initiated by PAN coordinator

MAC Operation Description (6/6)

~MSC for Data Transfer~

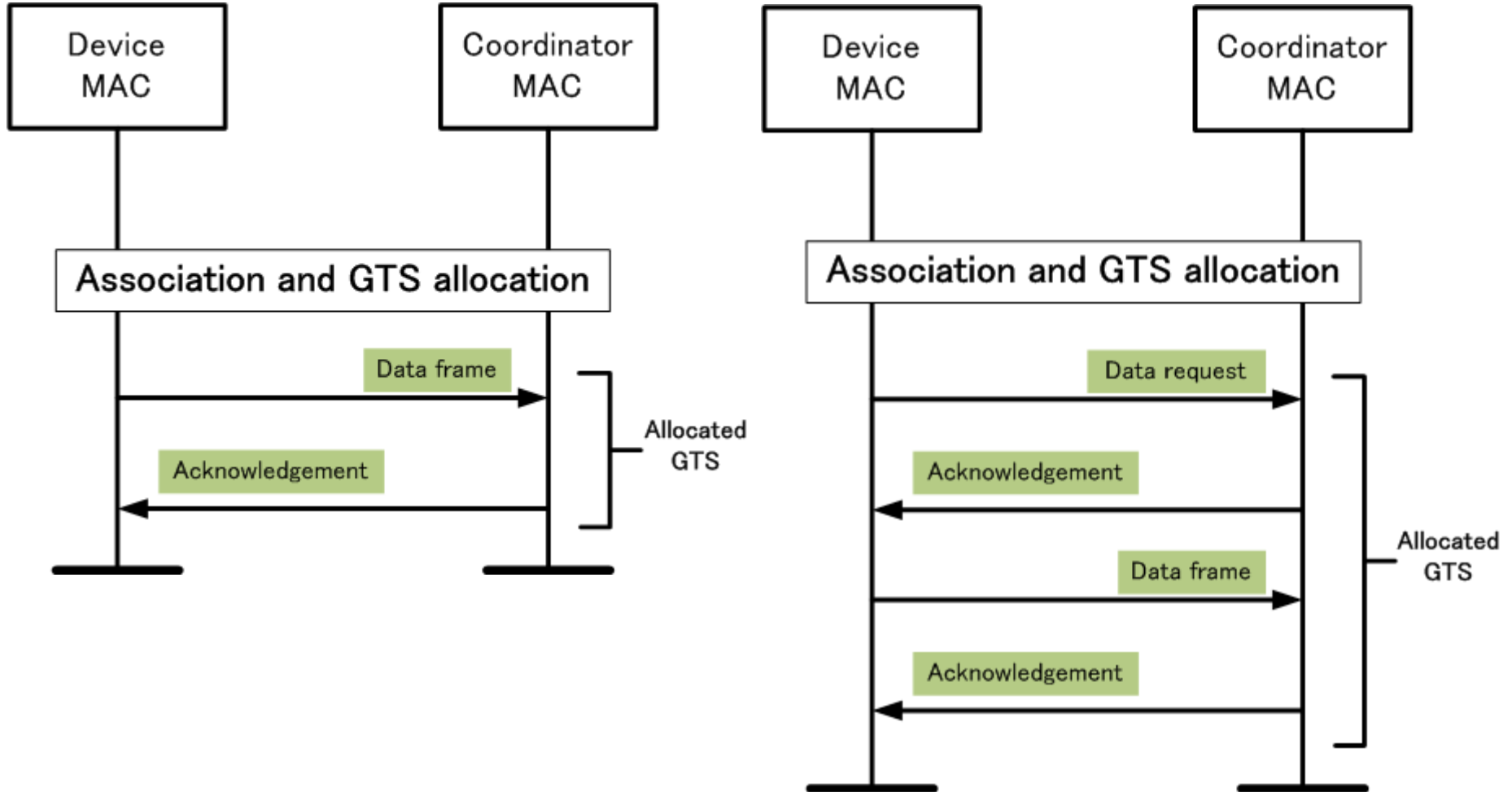

Data transfer to PAN coordinator

Data transfer from PAN coordinator

Action items for multi PHY mode operation

Need to clarify the following items in order to provide effective PHY mode operation

- Frame format for CS
- MCS for CS
- MAC amendment for CS

Conclusion

- This document proposes the employment of Common Signaling (CS) for multi-PHY-mode-management in a single PAN
- Four mandatory CS-related rules are drawn
- MAC operation procedures are described

A study on Multi-path characteristics as for FSK based SUN in Japan

Summary

- FSK based SUN is considered to work well in Japanese region(400/950MHz) without suffering from multi-path degradation
 - No serious multi-paths are found in the propagation range assumed in Japanese SUN
 - Multi-hop capability for service area expansion could also provide route with less multi-path effects
- Link budget analysis and outdoor experiment results confirm that:
 - Up to 150m propagation range to achieve -60dBm received power with 10mW transmission power
 - 300m with 700mW
 - No notch attenuation more than 20dB over 300m radius area
- Computer simulation results confirm that frames are successfully relayed to the collection station where 80% of all radio links are seriously degraded over 400m x 400m area, while only 20% of frames are successfully sent without multi-hop transmission

Link budget analysis on 400MHz band

Operating ranges are from **270m to 190m in typical suburban model** by employing GMSK or 4GFSK without FEC on Japanese 400 MHz band

Environment				
	GFSK	GFSK	GFSK	4GFSK
Transmitter				
Information Data Rate (Rb)	0.05	0.10	0.20	0.40
Coding Rate	1.00	1.00	1.00	1.00
Modulation Level	1	1	1	2
Center Frequency	400.000	400.000	400.000	400.000
Tx Antenna Gain (GT)	2.5	2.5	2.5	2.5
Tx Average Power (PT)	10.00	10.00	10.00	10.00
Receiver				
Average Noise Power per Bit ($N = -174 + 10 \times \log(Rb)$)	-127.0	-124.0	-121.0	-118.0
Rx Noise Figure Referred to the Antenna Terminal (NF)	8.0	8.0	8.0	8.0
Average Noise Power per Bit ($PN = N + NF$)	-119.0	-116.0	-113.0	-110.0
Payload Eb/N0 (S)	12.8	12.8	12.8	9.8
Payload CNR	12.8	12.8	12.8	12.8
Implementation Loss (I)	3.0	3.0	3.0	3.0
Rx Antenna Gain (GR)	2.5	2.5	2.5	2.5
Sensitivity				
Minimum Rx Sensitivity Level ($S_{min} = PN + S + I$)	-103.2	-100.2	-97.2	-97.2
Shadow Margin (M)	20.0	20.0	20.0	20.0
in Hata Typical Suburban Model				
Tolerable Path Loss	98.21	95.20	92.19	92.18
Operating Range [m]	272.31	229.30	193.09	192.97
in Hata Urban Model				
Tolerable Path Loss	98.21	95.20	92.19	92.18
Operating Range [m]	169.75	142.94	120.36	120.29

Link budget analysis on 950MHz band

Operating ranges are from **170 m to 120 m in typical suburban model** by employing GMSK or 4GFSK without FEC on Japanese 950 MHz band

Environment				
	GFSK	GFSK	GFSK	4GFSK
Transmitter				
Information Data Rate (Rb)	0.05	0.10	0.20	0.40
Coding Rate	1.00	1.00	1.00	1.00
Modulation Level	1	1	1	2
Center Frequency	950.000	950.000	950.000	950.000
Tx Antenna Gain (GT)	2.5	2.5	2.5	2.5
Tx Average Power (PT)	10.00	10.00	10.00	10.00
Receiver				
Average Noise Power per Bit ($N = -174 + 10 \times \log(Rb)$)	-127.0	-124.0	-121.0	-118.0
Rx Noise Figure Referred to the Antenna Terminal (NF)	8.0	8.0	8.0	8.0
Average Noise Power per Bit ($PN = N + NF$)	-119.0	-116.0	-113.0	-110.0
Payload Eb/N0 (S)	12.8	12.8	12.8	9.8
Payload CNR	12.8	12.8	12.8	12.8
Implementation Loss (I)	3.0	3.0	3.0	3.0
Rx Antenna Gain (GR)	2.5	2.5	2.5	2.5
Sensitivity				
Minimum Rx Sensitivity Level ($S_{min} = PN + S + I$)	-103.2	-100.2	-97.2	-97.2
Shadow Margin (M)	20.0	20.0	20.0	20.0
in Hata Typical Suburban Model				
Torelable Path Loss(*)	98.21	95.20	92.19	92.18
Operating Range [m]	172.62	145.36	122.40	122.33
in Hata Urban Model				
Torelable Path Loss(*)	98.21	95.20	92.19	92.18
Operating Range [m]	96.84	81.55	68.67	68.63

Back-up: BER performances of GFSK and 4GFSK in AWGN

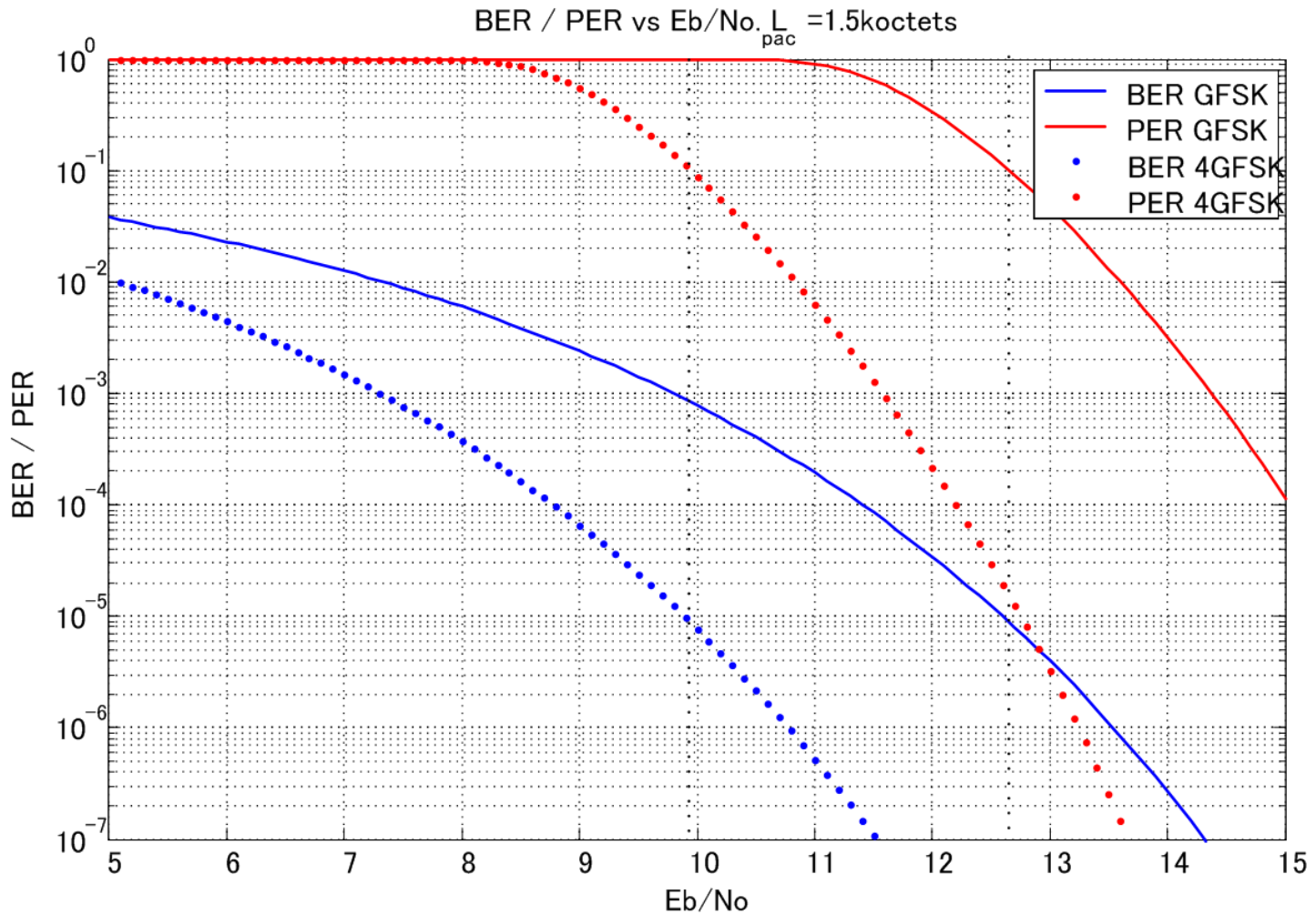

Outdoor experiments

The following two experiment results confirms that no serious multi-path degradation occurs in the propagation range assumed in Japanese SUN

1. Received power strength evaluation on 400MHz band
 - Service area validation
2. Multi-path evaluation on 400MHz band
 - Multi-path effect on the received spectrum validation

Received power strength for 10mW Tx power

More than -60dBm received power is achieved up to the propagation range of 150m in both case of 5.2m and 1.5m antenna height.

Center frequency	426.0375MHz
Transmission power	10mW
Antenna gain	2.15dBi
Antenna height	5.2m/1.5m
Modulation scheme	BPSK
Signal bandwidth	768kHz
Symbol rate	312.5kbps



Tx 5.2m

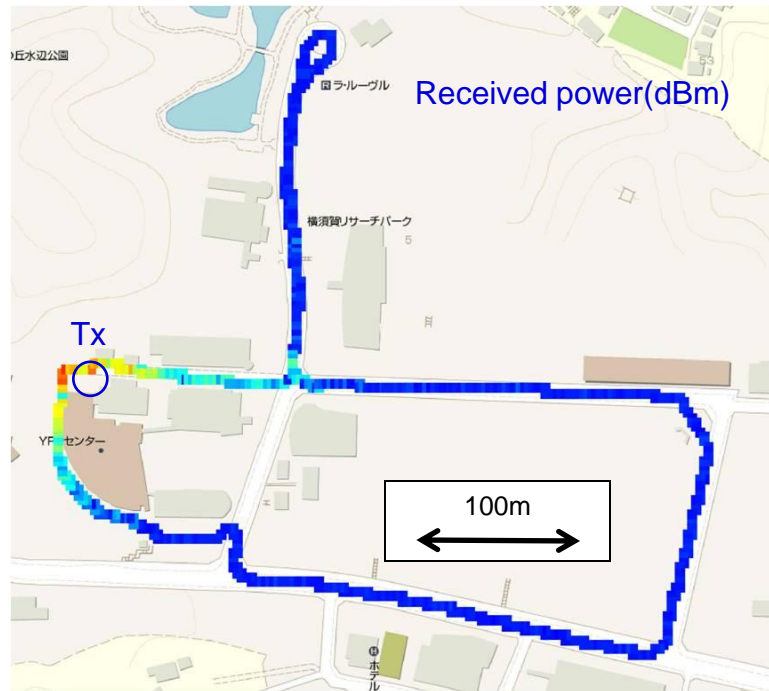

Tx 1.5m

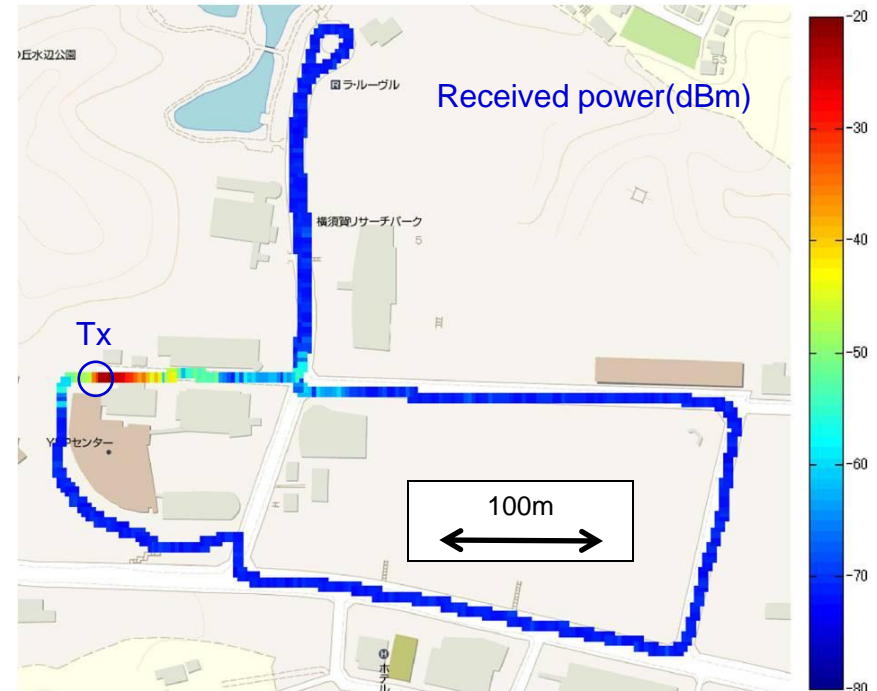

Received power strength for 700mW Tx power(1/2)

More than -60dBm received power is achieved up to the propagation range of 300m in both case of 5.2m and 1.5m antenna height.

Center frequency	413MHz
Transmission power	700mW
Antenna gain	2.15dBi
Antenna height	5.2m/1.5m
Modulation scheme	BPSK
Signal bandwidth	768kHz
Symbol rate	312.5kbps



Tx 5.2m

Tx 1.5m



Received power strength for 700mW Tx power(2/2)

More than -100dBm received power is achieved up to the propagation range of 500m in both case of 5.2m and 1.25m antenna height.

Center frequency	413MHz
Transmission power	700mW
Antenna gain	2.15dBi
Antenna height	5.2m/1.25m
Modulation scheme	BPSK
Signal bandwidth	768kHz
Symbol rate	312.5kbps

Tx 5.2m

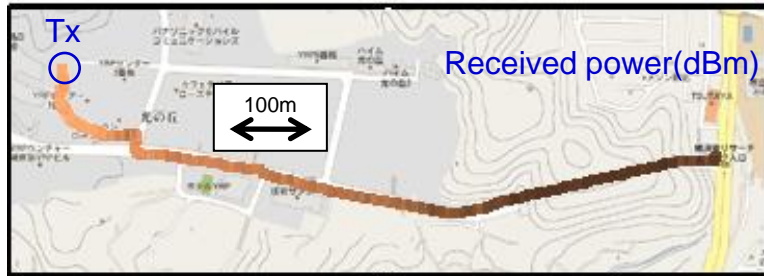

Tx 1.5m

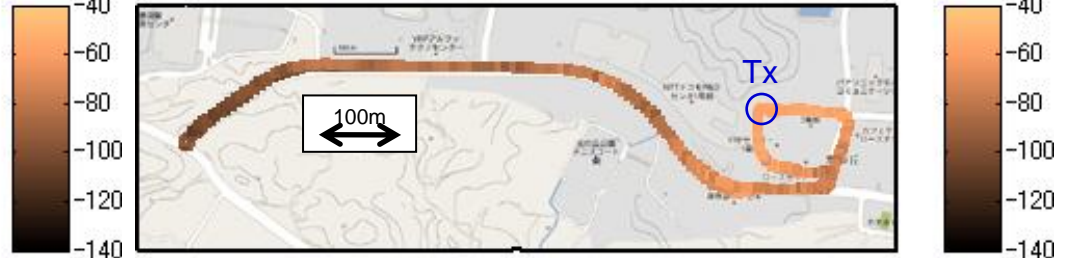
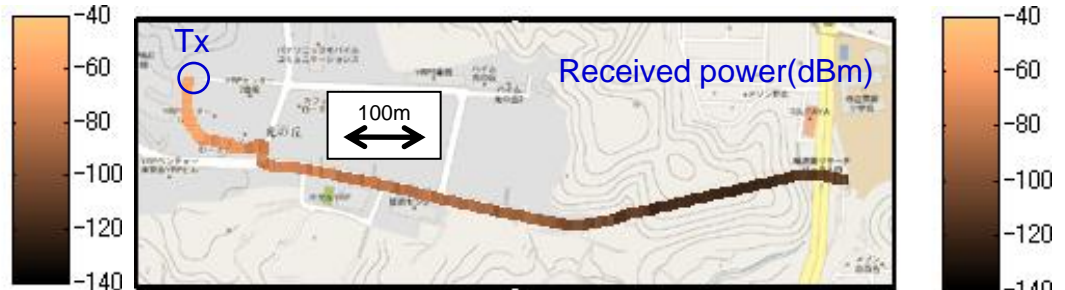

Multi-path characteristics evaluation on 400MHz band

1. Received spectra of multi-carrier signal are evaluated over the two courses
 - Course1: LOS environment
 - Course2: including NLOS environment
2. Two Tx antenna heights is used
 - 5.2m
 - 1.5m

Tx power	10dBm
Frequency	416MHz
Bandwidth	768kHz
Subcarrier number	340
Antenna gain	2.15dBi for Tx and Rx
Rx points	1600 points for Course1 2500 points for Course2

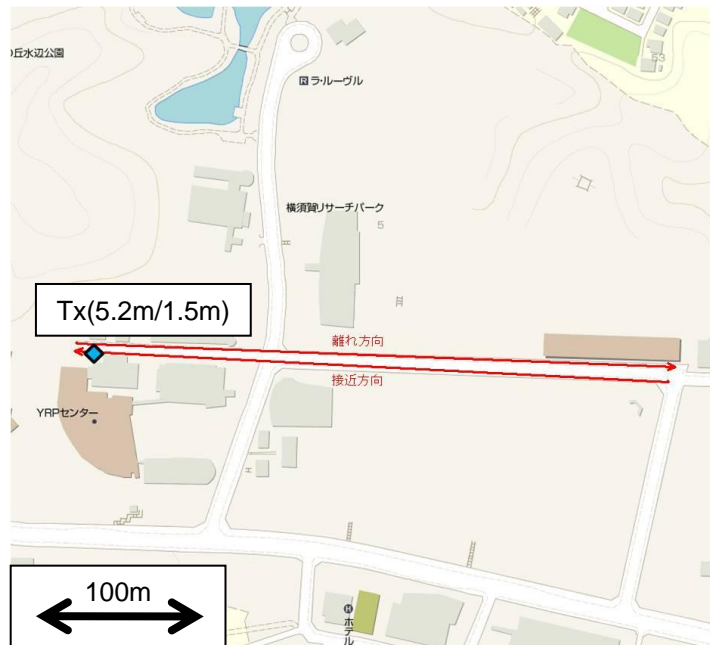

Multi-path characteristics on 400MHz band(1/3)

In order to evaluate multi-path characteristics on 400MHz band, outage probability for assumed area is evaluated

- Definition of “**Outage probability**” : Spatial probability where more than 5% of total subcarriers become “**degraded subcarriers**”
- Definition of “**Degraded subcarrier**” : A subcarrier that suffers from over-**threshold**-attenuation compared with the subcarrier with highest level

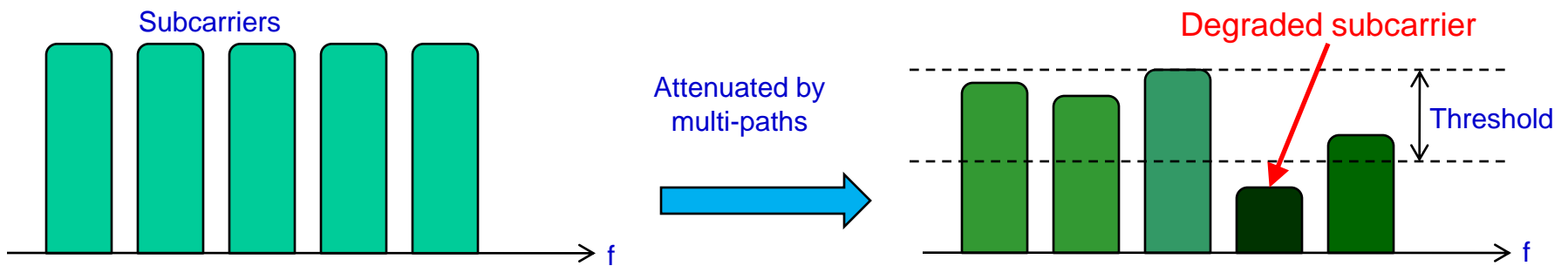

Multi-path characteristics on 400MHz band(2/3)

Course1 characteristics

- Outage probability for more than 20dB attenuation is almost 0%, and that for 10dB-20dB attenuation is 5% for Tx5.2m case, and 15% for Tx1.5m case, respectively

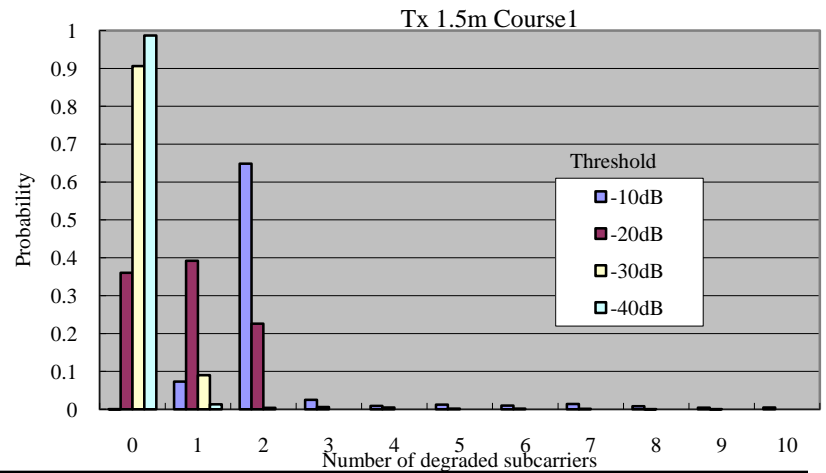
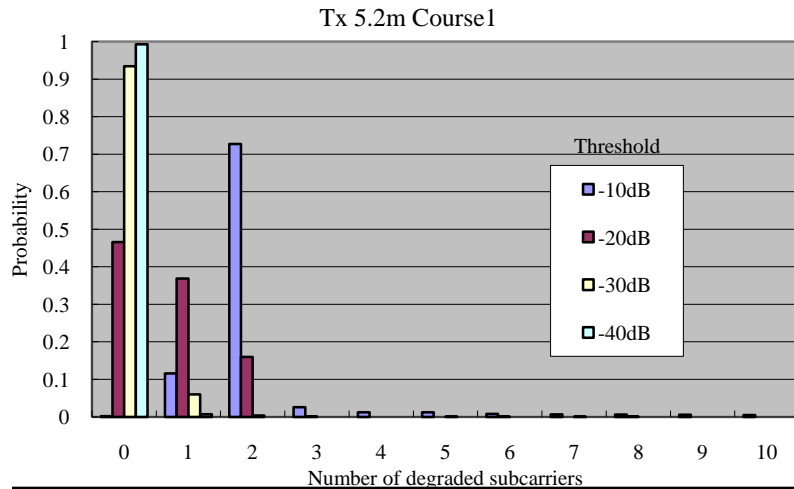
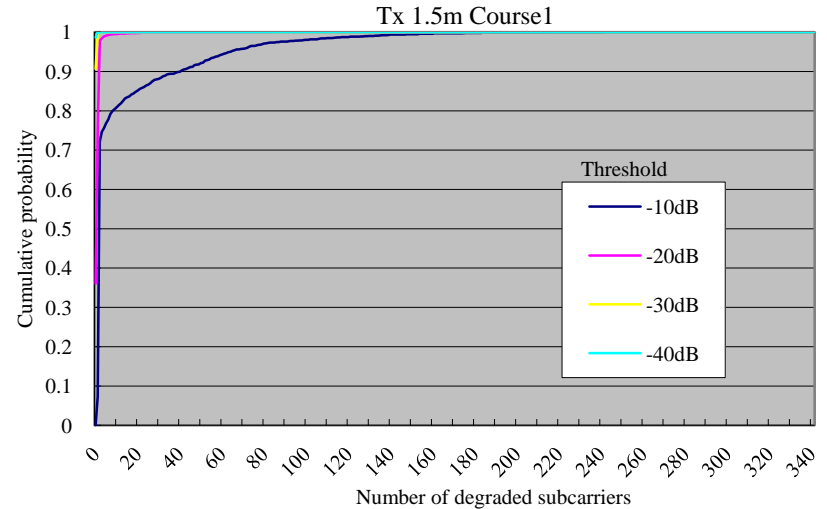
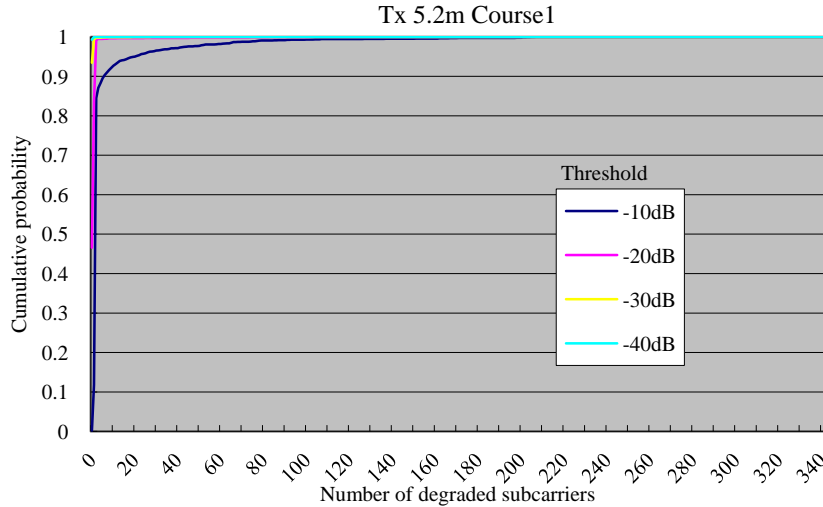

Multi-path characteristics on 400MHz band(2/3)

Course2 characteristics

- Outage probability for more than 20dB attenuation is almost 0%, and 10dB-20dB attenuation is 15% for Tx5.2m case, and 30% for Tx1.5m case, respectively

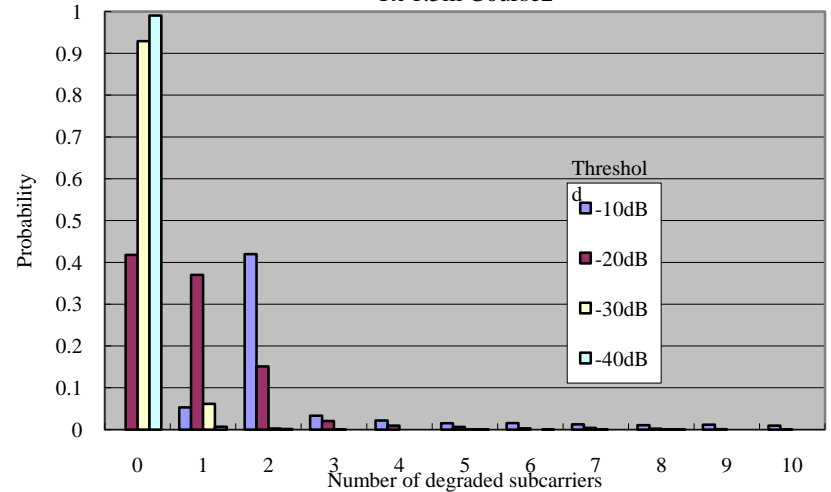
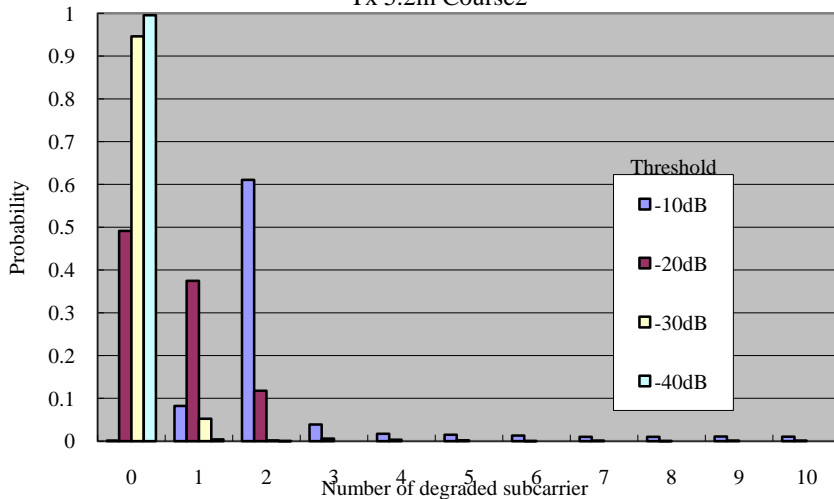
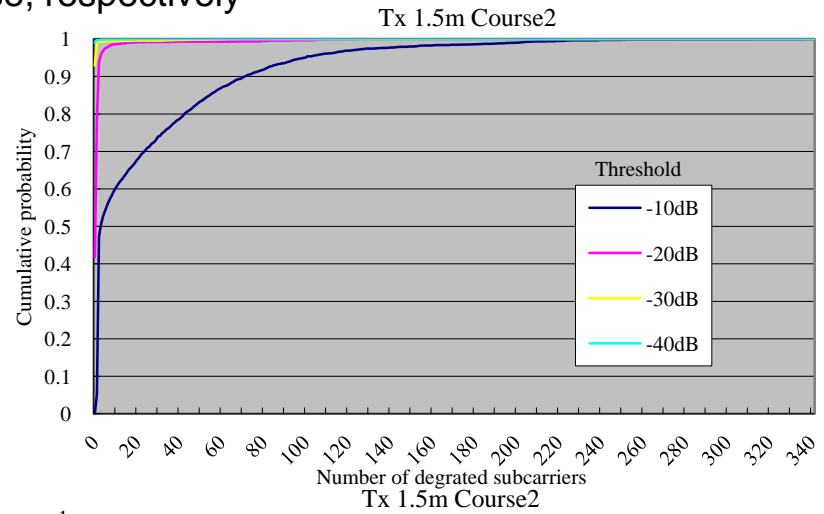
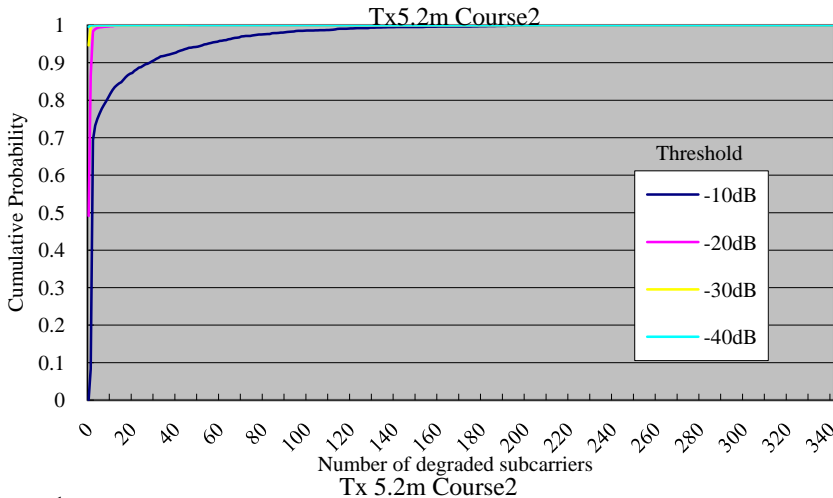

Computer simulation

Multi-hop transmission performance to avoid the degraded link due to multi-path is evaluated by computer simulations

•assumptions:

- A) Squared area where collection station is located in the center
- B) Periodical short data collection assuming meter reading
- C) Any of all possible links randomly suffers from serious degradation
- D) Tree topology based routing
- E) 15.4(e) MAC
- F) No retransmission

Computer simulation conditions

Tx power	10mW
Frequency	400MHz/950MHz
Environment	Large City/Suburban
Fading mode	Shadowing only
Standard deviation of log-normal shadowing	4.0dB
Multi-path degradation	40dB/link (assumed)
Modulation	GFSK
Required PER	0.1 for 1500octet payload assumption
Area	400x400m
Terminal number	50 (1: collection center(5m), 49: meters(1m))
MAC	15.4e (beacon-enabled PAN with turn off beacons)
Routing	Tree routing on 15.4e PAN
Beacon interval	2s
Superframe duration	100ms
Frame length	10ms
Frame arrival rate	1/30s on each meter

Computer simulation results(1/4):

Frame success rate without multi-hop transmission

- On 400MHz band, almost all terminals can conduct direct transmission towards collection station, but such direct links fail to transmit frames proportionally to the degraded link ratio
- On 950MHz band, frame success rate performance can be degraded further by propagation loss especially in large city environment case

400MHz band

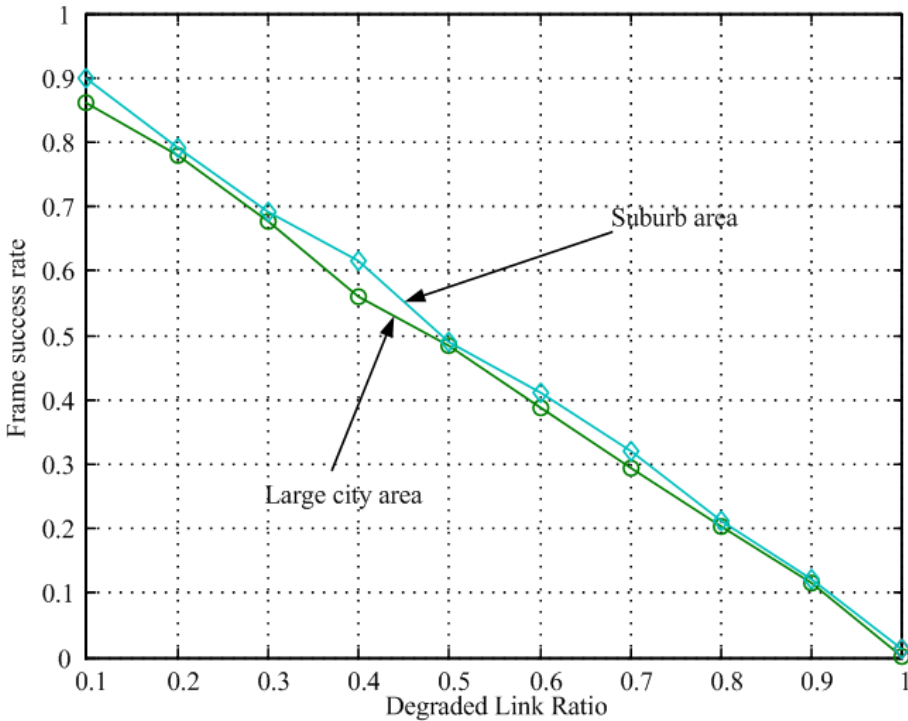

950MHz band

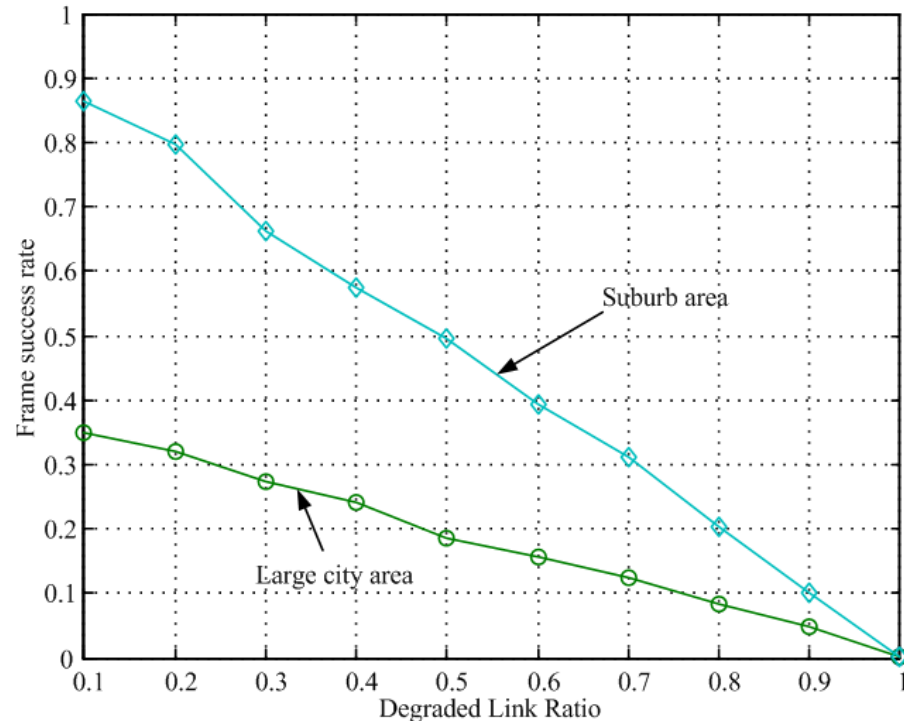

Computer simulation results(2/4):

Frame success rate with multi-hop transmission

- On 400MHz band, frames are successfully relayed to the collection station where 80% of all radio links are seriously degraded due to multi-path
- On 950MHz band, frames are successfully relayed where 80% and 50% (for large city and suburb area) of all radio links are degraded

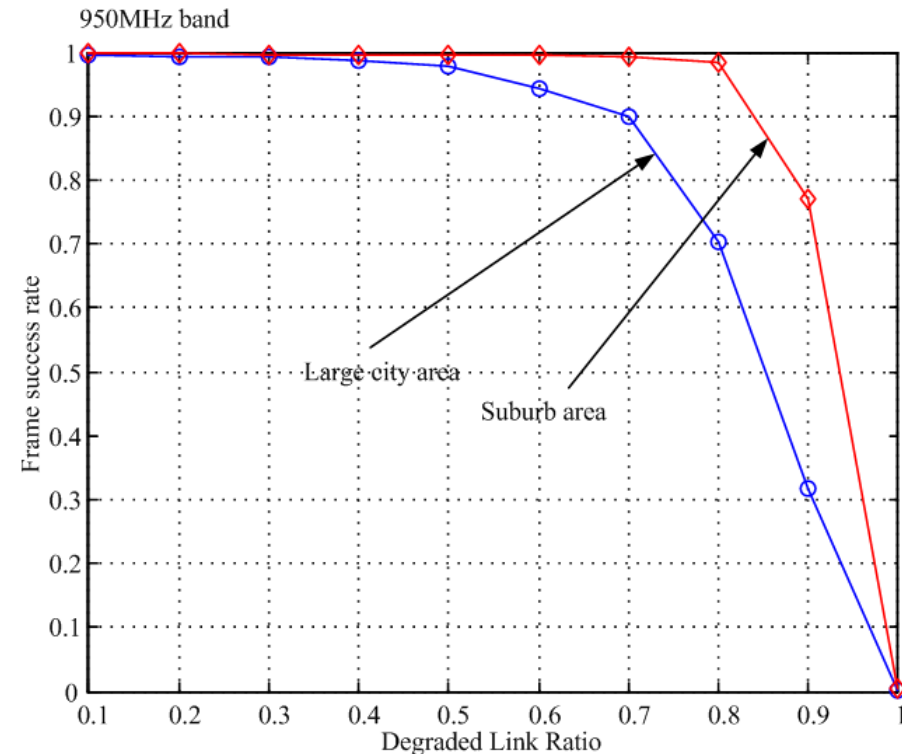
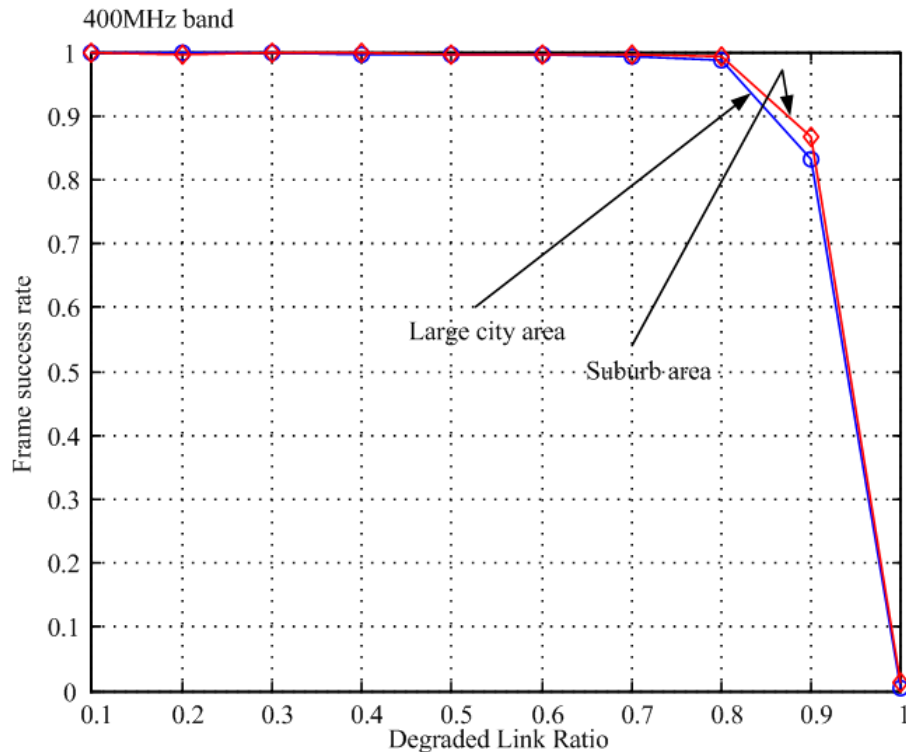

Computer simulation results(3/4):

Average hop number in multi-hop transmission

- It is confirmed that higher ratio of degraded links causes necessity of multi-hop transmission not direct transmission, thereby increases average hop number

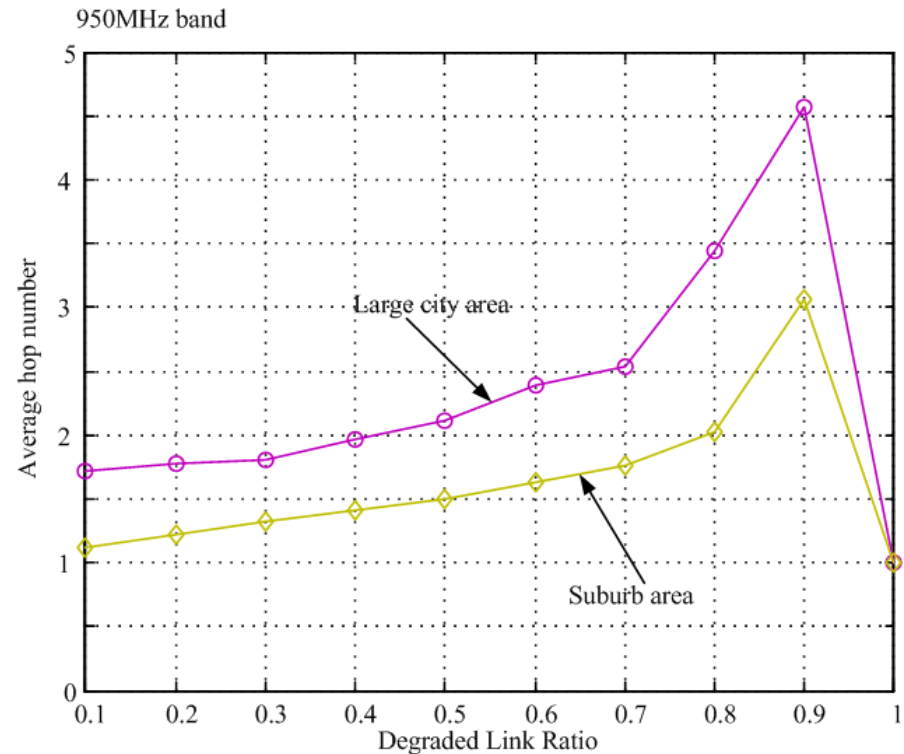
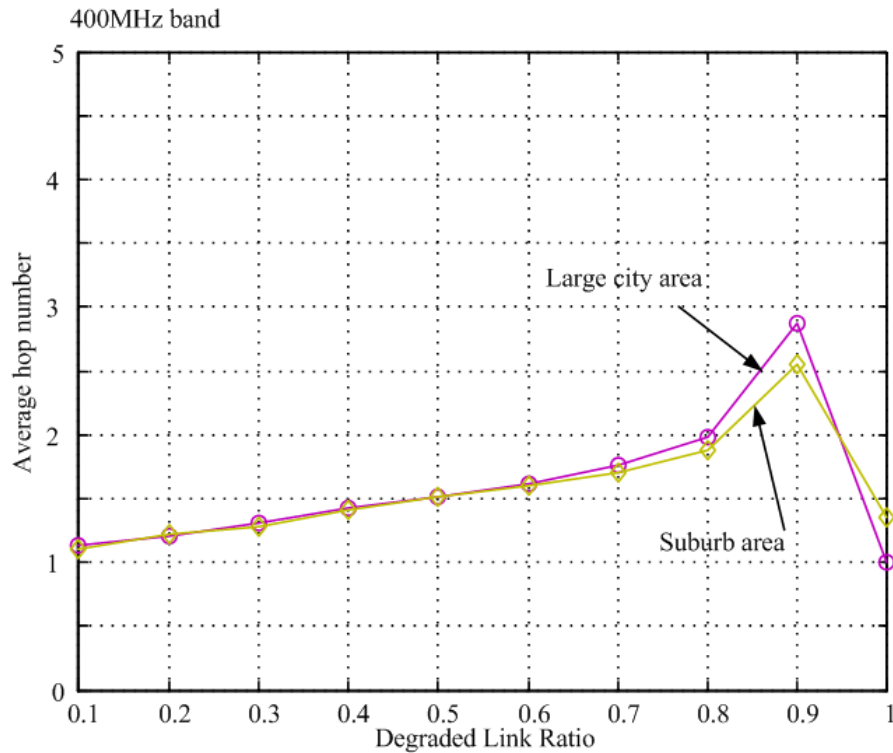

Computer simulation results(4/4): Comparison for multi-hop transmission capability

- On 400MHz band, frames are successfully relayed to the collection station where 80% of all radio links are seriously degraded due to multi-path, while only 20% of frames are successfully sent without multi-hop transmission
- On 950MHz band, frames are successfully relayed where 80% and 50% (for large city and suburb area) of all radio links are degraded, while only 20% (for both area) of frames are successfully sent without multi-hop transmission

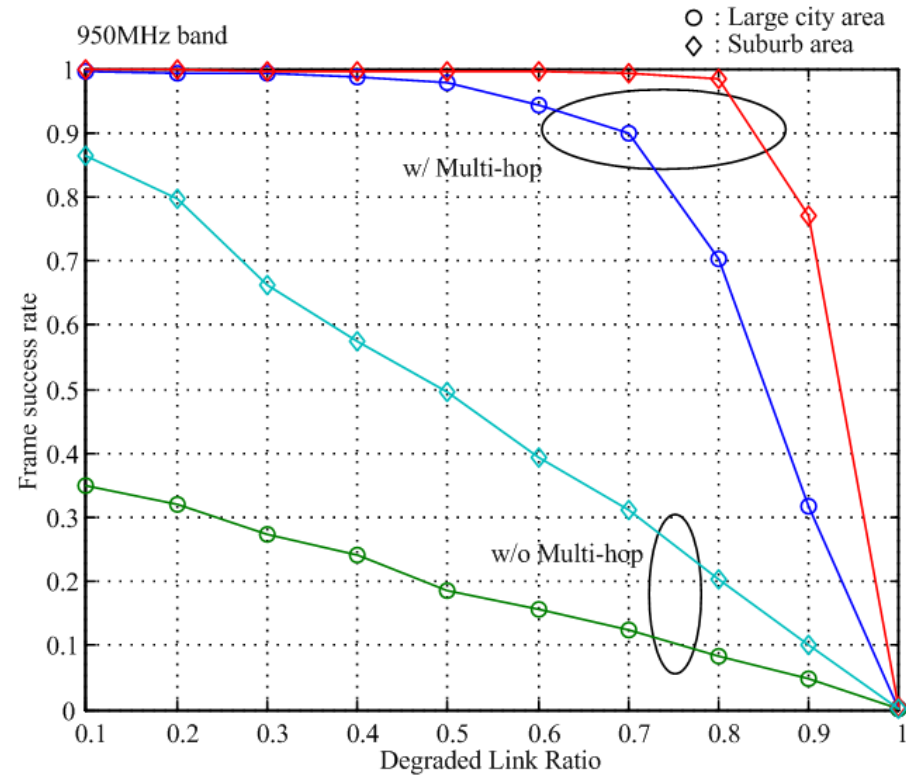
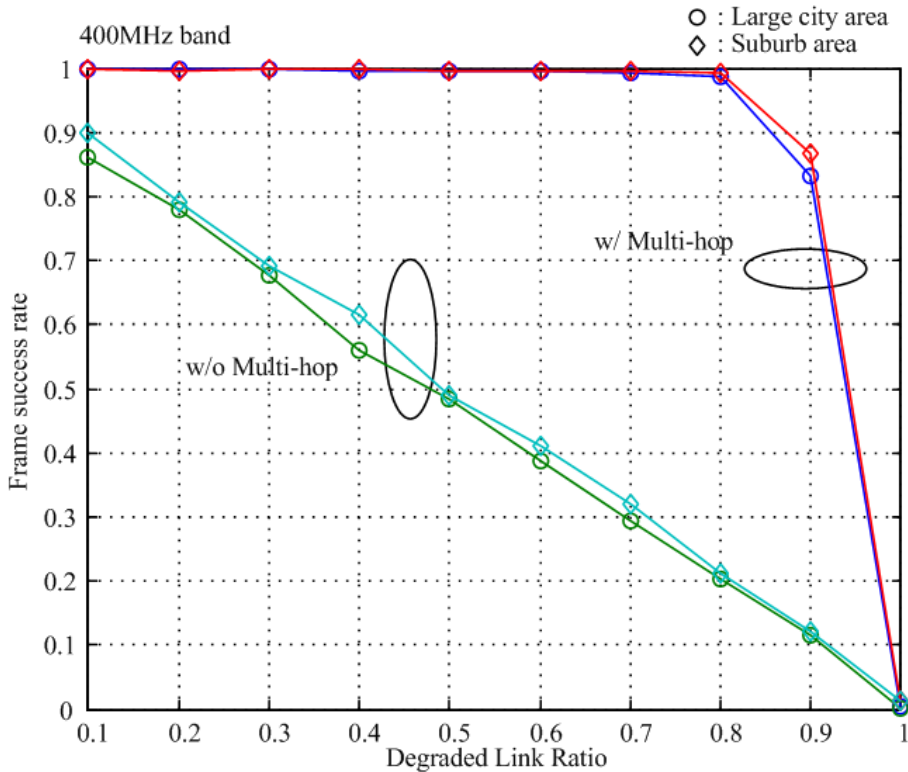

Conclusions

- FSK based SUN is considered to work well in Japanese region(400/950MHz) without suffering from multi-path degradation
 - No serious multi-paths are found in the propagation range assumed in Japanese SUN
 - Multi-hop capability for service area expansion could also provide route with less multi-path effects
- Link budget analysis and outdoor experiment results confirm that:
 - Up to 150m propagation range to achieve -60dBm received power with 10mW transmission power
 - 300m with 700mW
 - No notch attenuation more than 20dB over 300m radius area
- Computer simulation results confirm that frames are successfully relayed to the collection station where 80% of all radio links are seriously degraded over 400m x 400m area, while only 20% of frames are successfully sent without multi-hop transmission

Conclusions

SFF(Short Frame FSK) proposal that is composed of the following modifications

- PPDU format revised
 - Efficient transmission for short frame is considered
- PHY mode operation is considered
 - Concept of common signaling (CR) is proposed with operational rules
- Performance for Japanese SUN with multi-path characteristics are studied
 - Outdoor experiment results and computer simulation results are reported