

11 March 2009

Project: IEEE P802.15 Working Group for Wireless Personal Area Networks (WPANs)

Submission Title: [Elements of an IR-UWB PHY for Body Area Networks]

Date Submitted: [10 March, 2009]

Source: Olivier Rousseaux, Dries Neiryneck (WiPulse c/o IMEC-NL)

Address: High Tech Campus 31, 5656AE Eindhoven, Netherlands

Voice: +31 40 277 40 51, E-Mail: olivier.rousseau@imec-nl.nl

Re: [If this is a proposed revision, cite the original document.]

Abstract: [Elements of an IR-UWB PHY suited for BAN are outlined and the resulting expected performance of a system adopting such elements are highlighted]

Purpose: [Trigger discussions amongst groups and companies willing to propose an UWB PHY; and initiate consolidation of different UWB PHY proposals in view of hearing of formal answers to the call for proposals]

Notice: This document has been prepared to assist the IEEE P802.15. It is offered as a basis for discussion and is not binding on the contributing individual(s) or organization(s). The material in this document is subject to change in form and content after further study. The contributor(s) reserve(s) the right to add, amend or withdraw material contained herein.

Release: The contributor acknowledges and accepts that this contribution becomes the property of IEEE and may be made publicly available by P802.15.

Presentation outline

- Introduction
 - Advantages and Drawbacks of IR-UWB in BAN context
 - Existing UWB-IR systems
- Elements of an IR-UWB PHY for BAN
 - Burst concatenation & Data encoding
 - Coping with ISI
 - Proposed system overview
- Performance analysis
 - Receiver types
 - Link budgets
 - Power consumption
- Conclusions

Intro: Advantages of IR-UWB in WBAN

- Flexible Datarates
 - Constant PRF, changing # pulses per bit
 - Datarate vs. range tradeoff
- Multi User Capabilities
 - Scarce nature of air interface -> few collisions
 - Spreading gain of many pulses per bit
 - Uncoordinated operation possible with smooth performance impact
 - High node density
- Reduced Interference – Low Radiated Power (-40 dBm/MHz)
 - To medical instruments
 - To existing CE devices and services
 - Limited RF energy transfer to human body
- Interference robustness
 - Plenty of spectrum to chose from (3-10 GHz)
 - Few services currently operating at such frequencies

Intro: Advantages of IR-UWB in WBAN

- Ultra Low Power Consumption
 - Rely on low duty cycle of IR-UWB signal (typically <10%)
 - Switch off Radio between Pulses at both Tx and Rx
 - Low Complexity Tx/Rx schemes

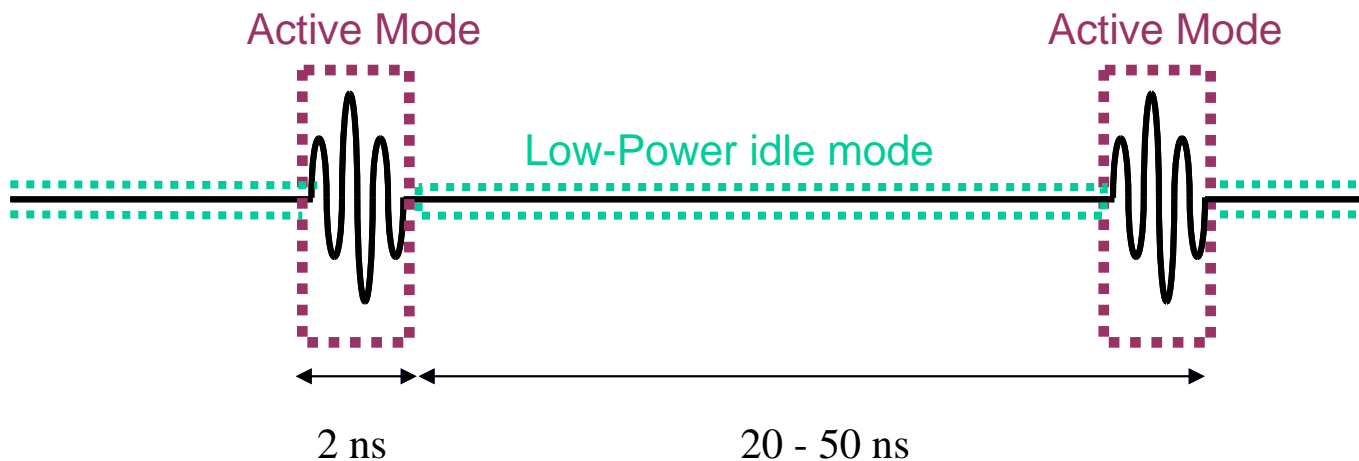

Intro: Challenges for IR-UWB in WBAN

- High attenuation @ considered frequencies
 - Shadowing effect of the body
 - Limited range especially at higher datarates
 - No communication through the body
 - Challenge for implants
 - Would sub-GHz UWB be an option?
 - Challenge is also an opportunity: higher spatial reuse possible
 - Allows higher node density
- Accurate timing references usually required
 - Information in very short pulses, timing needs to be known accurately
 - Need to maintain timing information over silent portions between pulses

Existing IR-UWB systems: Isolated Pulses & IEEE 802.15.4a

UWB IP

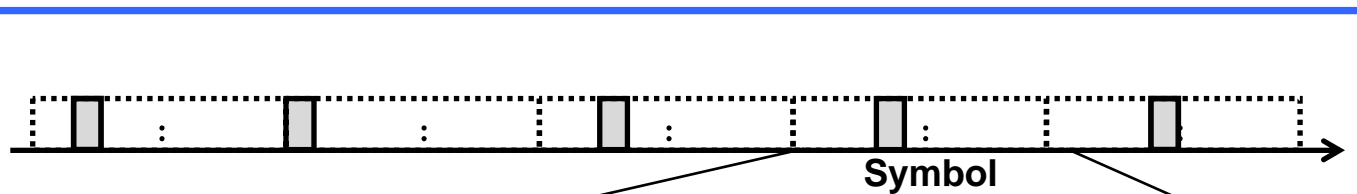

UWB 4a

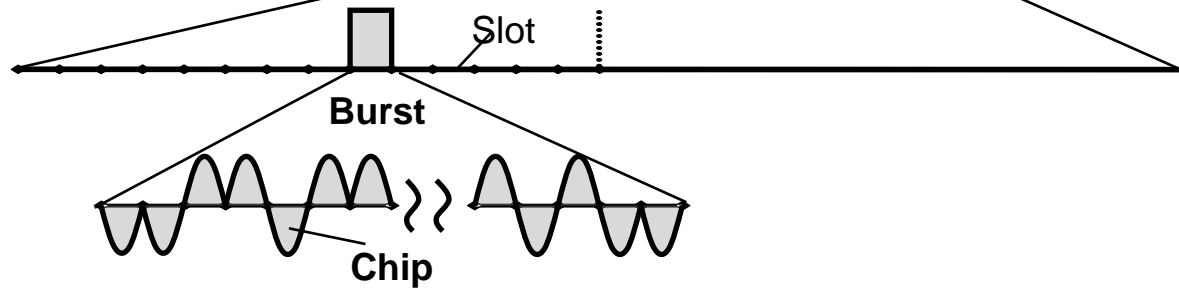

Pros and Cons of Isolated Pulses UWB

- Information encoding:
 - PPM, BPSK, OOK & combinations thereof
- Advantages
 - One pulse processed at a time
- Drawbacks
 - Power consumption increase by start-up and shut-down overheads

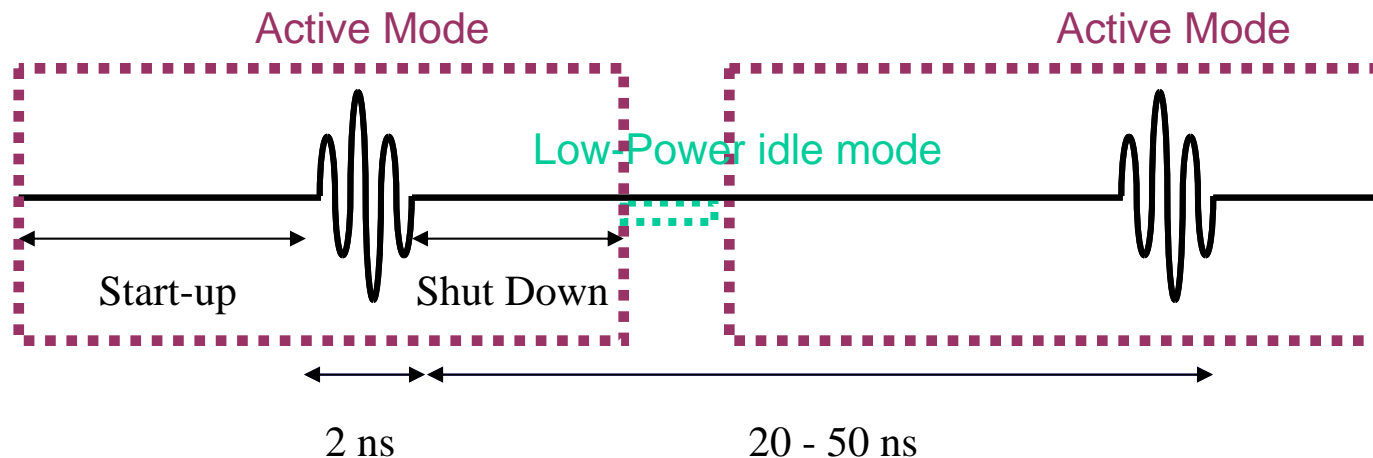

Pros and Cons of Isolated Pulses UWB

- Drawbacks
 - Channel Delay Spread
 - Impact on multi-User interference: Pulses from several users well separated in time @ Tx overlap @ Rx

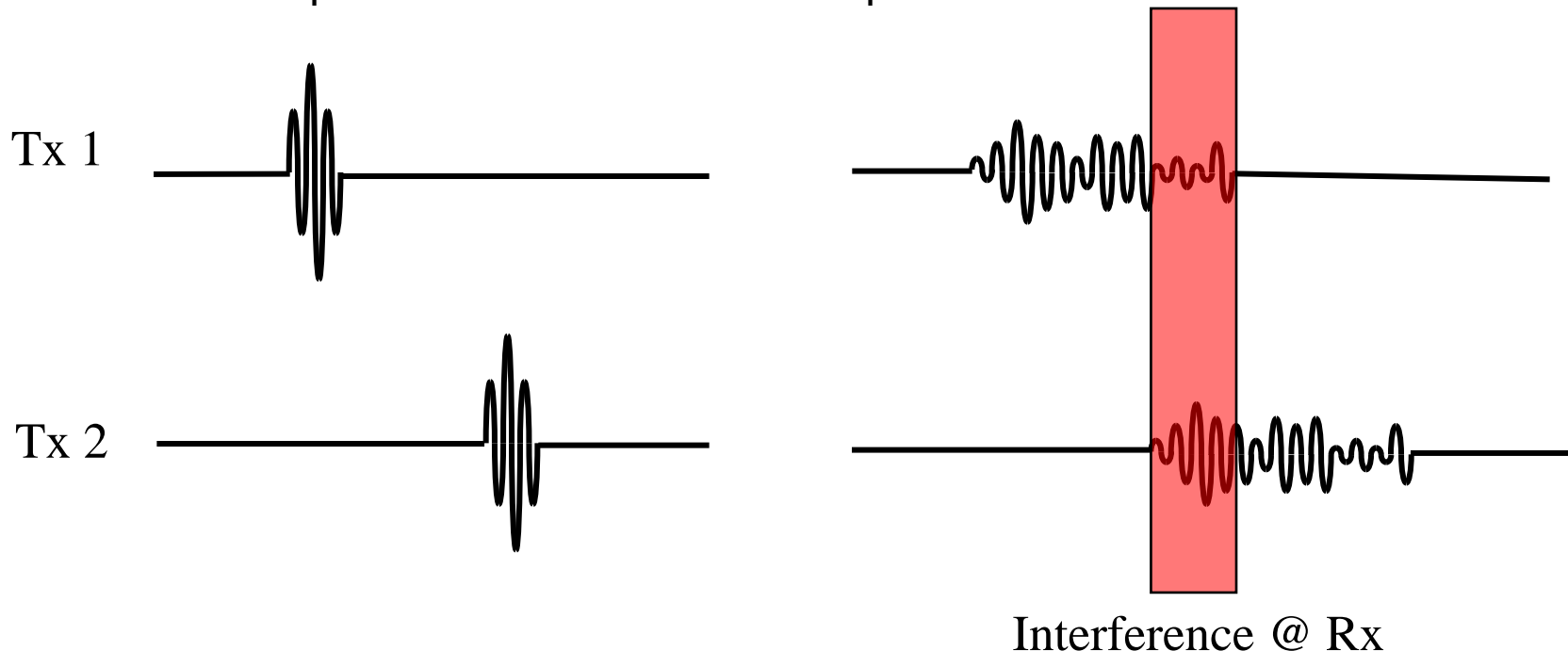

IEEE 802.15.4a – Key aspects

- Mean PRF “fixed” (3.9 MHz, 15.6 MHz or 62.4 MHz)
- Isolated Pulses in Timing Acquisition Preamble
- Spectrum Divided in Channels of 500 MHz – Broader channels overlap
- Data encoded in both Phase and Position (PPM + BPSK)
- Various Datarates supported (0.11 – 27 Mbps)
 - Change Symbol Duration and # Pulses per bit to change datarate
 - Isolated Pulses at highest supported datarates

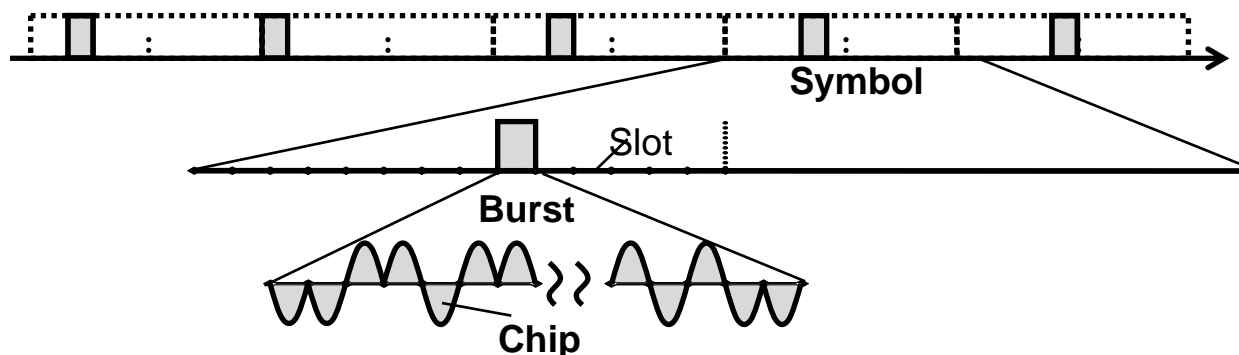

Pros & Cons of 15.4a @ Low Datarates

- Low data rate properties
 - Very long bursts of adjacent pulses (up to 512)
 - Very long silent portions between bursts (up to 10 microseconds)
- Key advantages
 - Power Consumption: Low startup overhead makes duty cycling efficient
 - Multi User Interference:
 - low probability of collision between bursts
 - Large spreading gains allow to survive such collisions
 - ALOHA is foreseen as an option in MAC
- Drawback:
 - Required timing reference accuracy:
 - Information encoded in absolute phase of the burst
 - Avoiding phase ambiguity @ start of a burst
 - Maintain accurate enough timing reference between bursts is a challenge
 - Ex: 45 degrees @ 10 GHz = 0.0125 ns accuracy.
 - Maintain this over 10 microsec requires about 1ppm timing ref accuracy

Pros & Cons of 15.4a @ High Datarates

- Low data rate properties
 - Very short bursts of adjacent pulses – isolated pulses eventually
 - Short silent portions between bursts (down to 16 ns)
- Key drawbacks
 - Power Consumption: Low startup overhead makes duty cycling unefficient
 - Multi User Interference
- Advantage:
 - Required timing reference accuracy is less
 - Absolute phase information easier to exploit

Elements of an IR-UWB PHY for BAN

- Key target
 - Maintain efficient duty cycle at higher data rates
 - Get rid of accurate timing reference requirements
 - Maintain Multi-User Access capabilities
- Key concept
 - Freely inspired by 15.4a
 - Concatenate several *bursts* into relatively long *strings*
 - Fixed symbol duration, Fixed string duration, burst length & number of bursts per string adapted in function of data rate

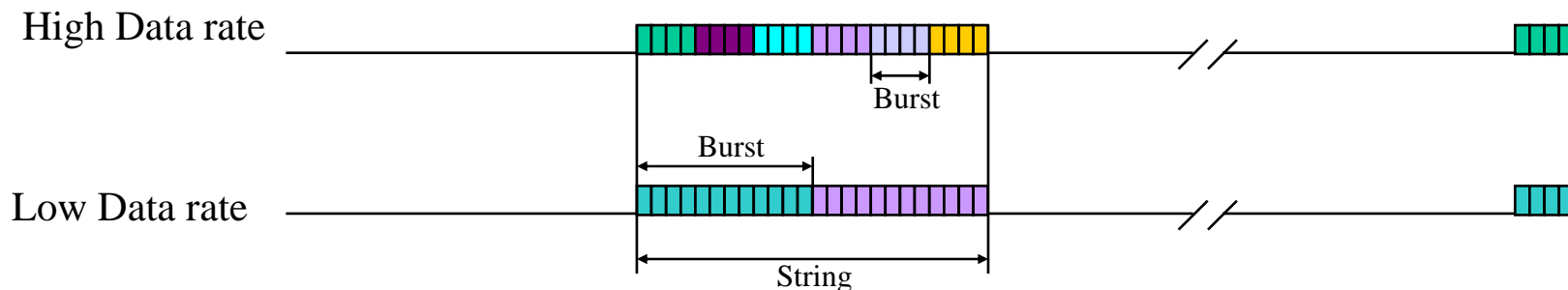

Elements of an IR-UWB PHY for BAN

- Data Encoding
 - PPM is no longer an option
 - OOK & Phase information remain possible
- OOK
 - Each bit is spread into a burst with a BPSK spreading code
 - Presence or absence of the burst to notify '0' or '1'
 - No absolute phase information required
- D-BPSK:
 - Start string with a fixed reference burst (BPSK spreading code)
 - First bit encoded as phase difference between first reference burst and second burst
 - Phase reference re-established @ Rx by reference burst
 - No need of RF phase-accurate timing reference throughout silent period
 - Phase-accurate reference only needed throughout a burst

Elements of an IR-UWB PHY for BAN

- Inter-Symbol Interference
 - No silent interval between bursts + multipath channel
 - Interference between consecutive bursts
 - Problem especially accurate at higher datarates
- Low Datarates & ISI
 - Impact limited to a portion of a burst
 - Rake receivers should allow to cope
 - Possibly multiple fingers

Elements of an IR-UWB PHY for BAN

- High Datarates & ISI
 - Interference from several bursts
 - Low spreading gain
 - Equalization probably required
- Frequency domain equalization
 - Zeros surrounding string act like a cyclic prefix
 - Channel matrix becomes circulant
 - Low complexity equalizers relying on FFT / IFFT become possible

Frequency Domain Equalization Receiver

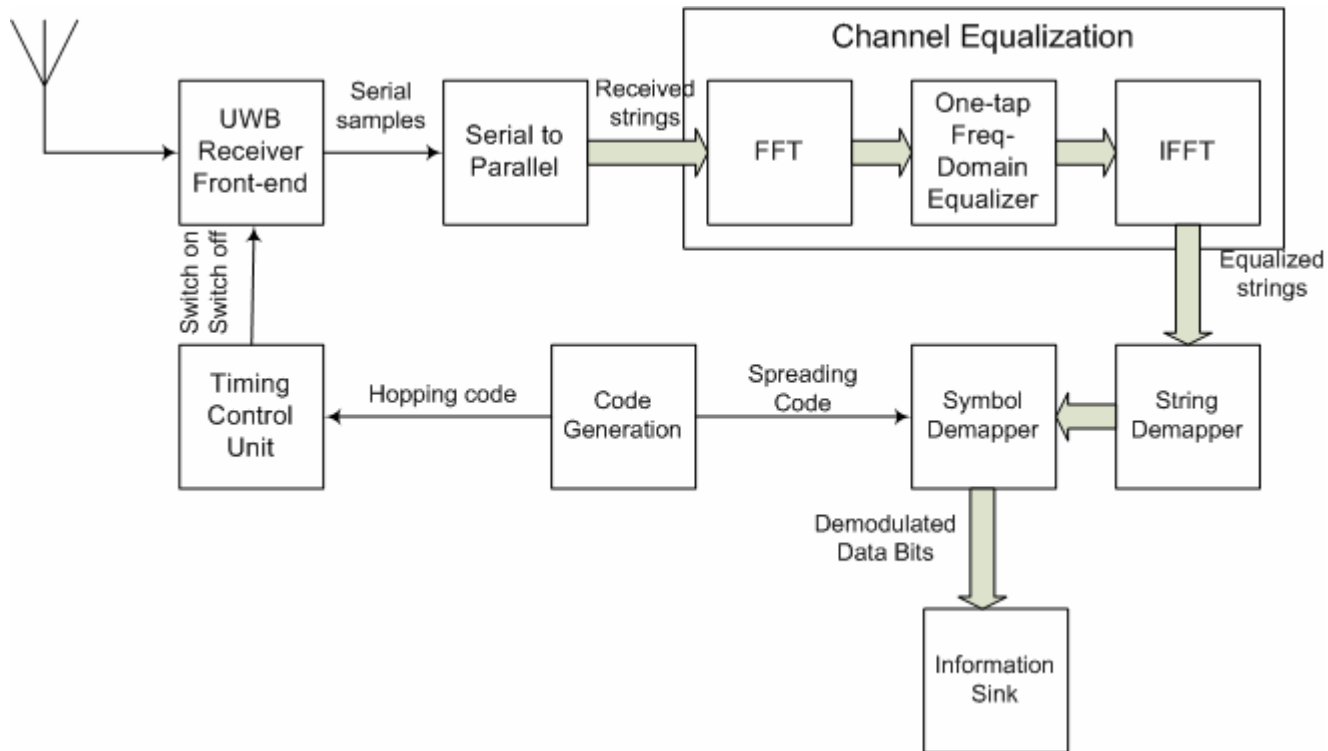

Key aspects of a possible UWB PHY proposal for BAN

- Pulse shapes inspired by 15.4a
 - 500 MHz channels
 - Pulse shape '*close to*' root raised cosine
 - Pulse amplitude 316 mV (max in 90nm CMOS @ 1V)
 - 17.4 MHz fills the FCC mask with that amplitude
- Stings, bursts & data rates
 - String length set to 512
 - Burst length from 1 to 512 Pulses
 - OOK for low data rates, DBPSK for higher data rates
 - Resulting data rates from 0.07 to 17.4 Mbps
 - 0.07 Mbps, 0.14 Mbps, 0.27 Mbps, 0.54 Mbps, 1.09 Mbps, 2.17 Mbps, 4.35 Mbps, 8.7 Mbps, 17.4 Mbps

Performance Analysis

- Different receivers considered
 - Energy-Based receiver
 - Rake Receiver (1 & 3 fingers)
 - Frequency Domain Equalization
- Different Channels Considered
 - AWGN (reference)
 - Channel model 3 (on-body to on-body)
 - Channel Model 4 (on-body to off-body)
- Different Modulation Schemes considered
 - OOK
 - DBPSK
- No FEC coding considered!

DBPSK – 1-finger rake

- Synchronised to strongest channel tap
- CM3: on-body to on-body
- CM4: on-body to off-body

DBPSK – 1 finger – CM3

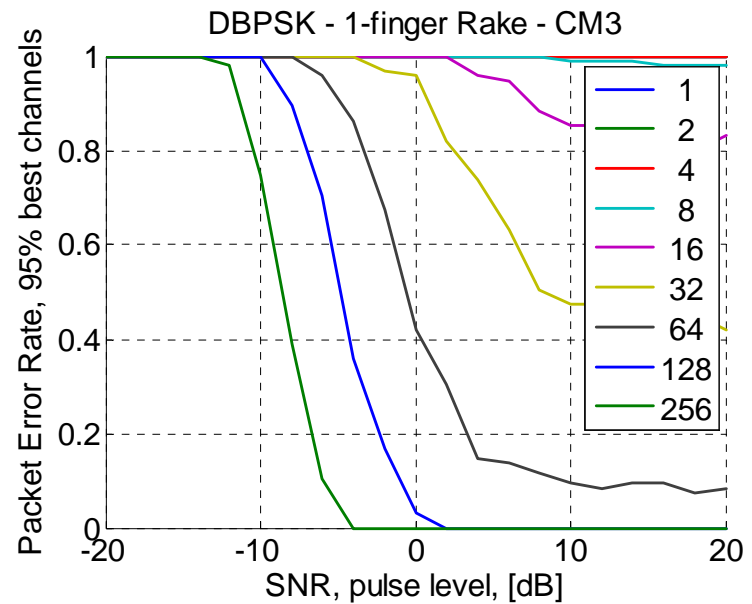
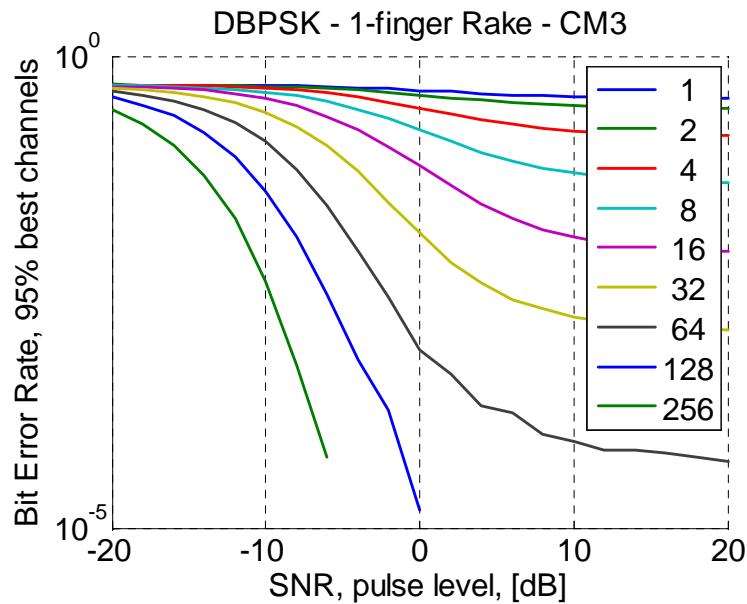

DBPSK – 1 finger – CM4

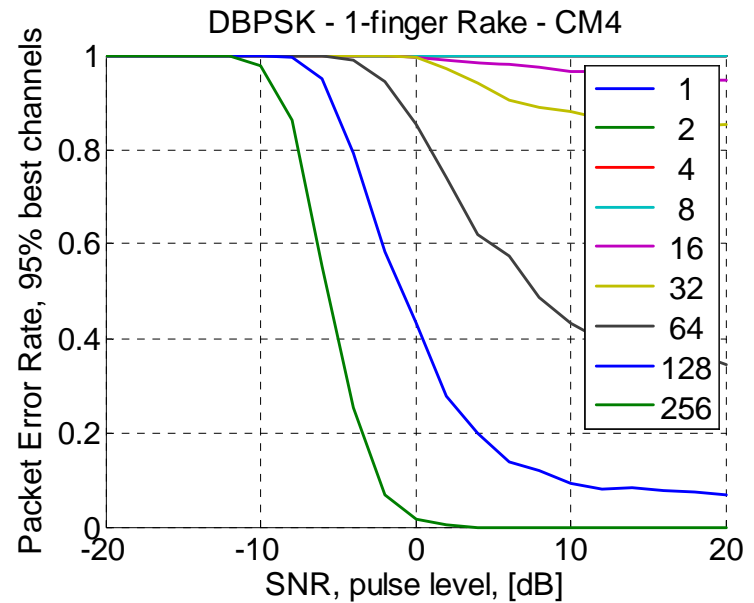
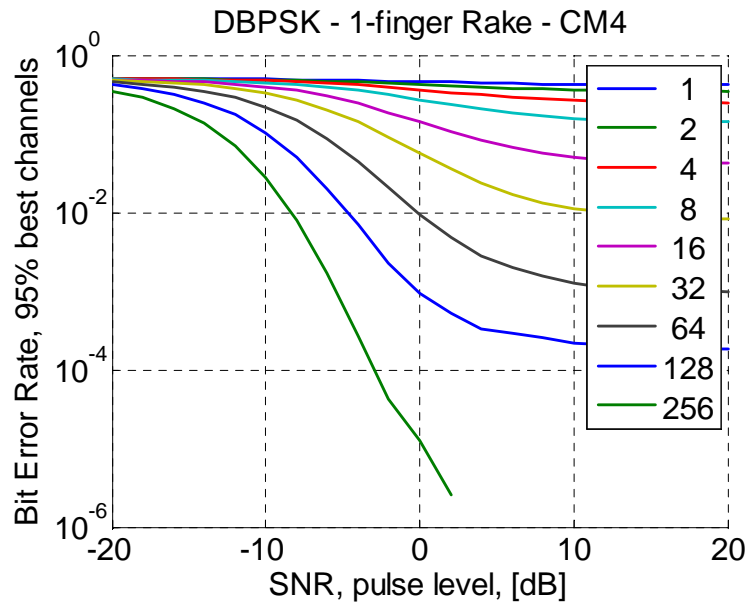

DBPSK – 3 finger rake

- Selective 3 finger rake,
using 3 most powerful channel taps
- Equal gain combining

DBPSK – 3 finger – CM3

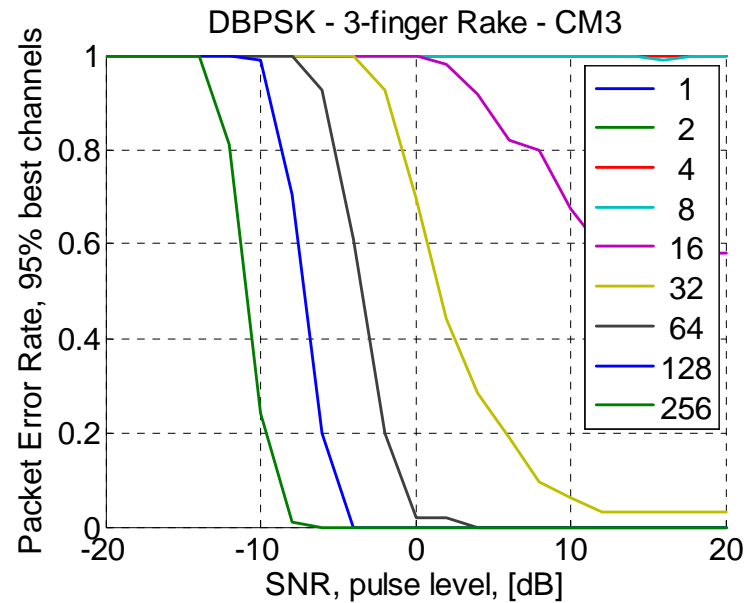
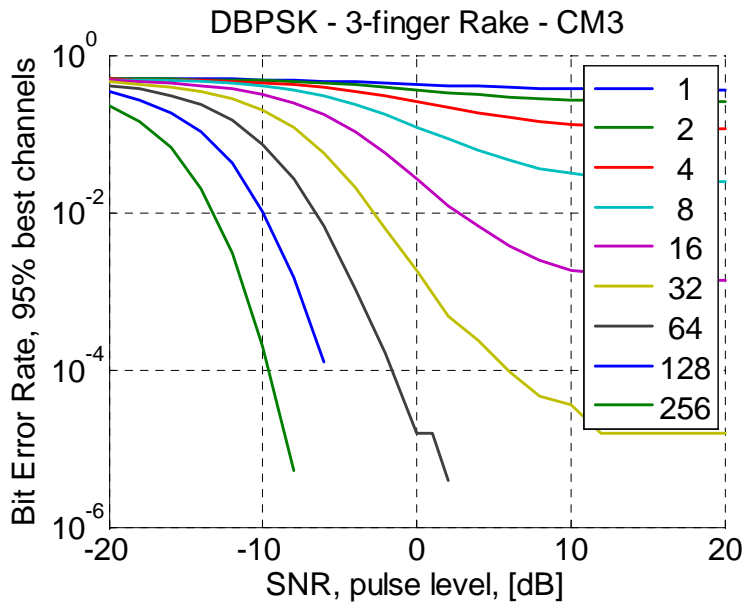

DBPSK – 3-finger – CM4

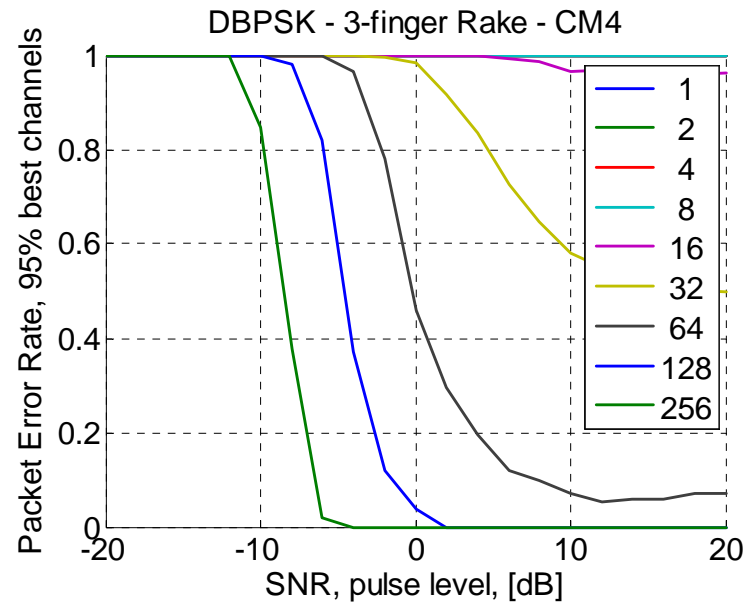
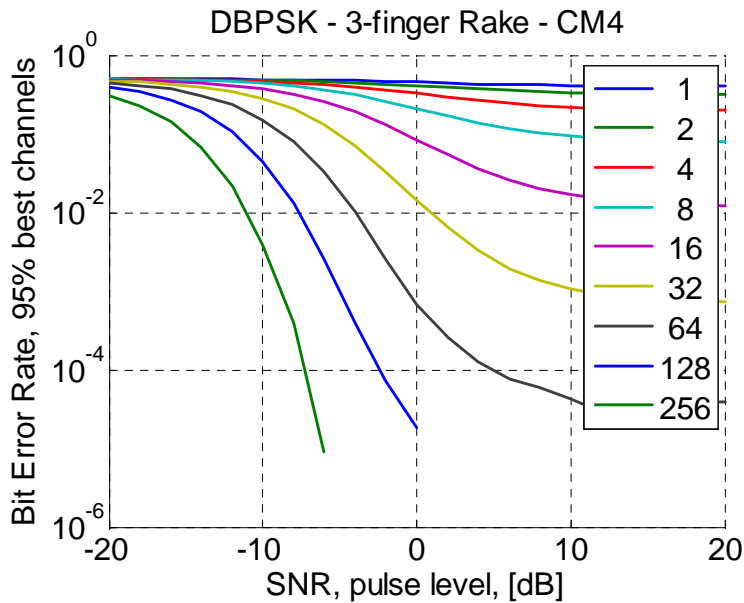

DBPSK – MMSE-FDE

- Frequency domain equaliser
- MMSE coefficients based on perfect channel knowledge

DBPSK – MMSE-FDE – CM3

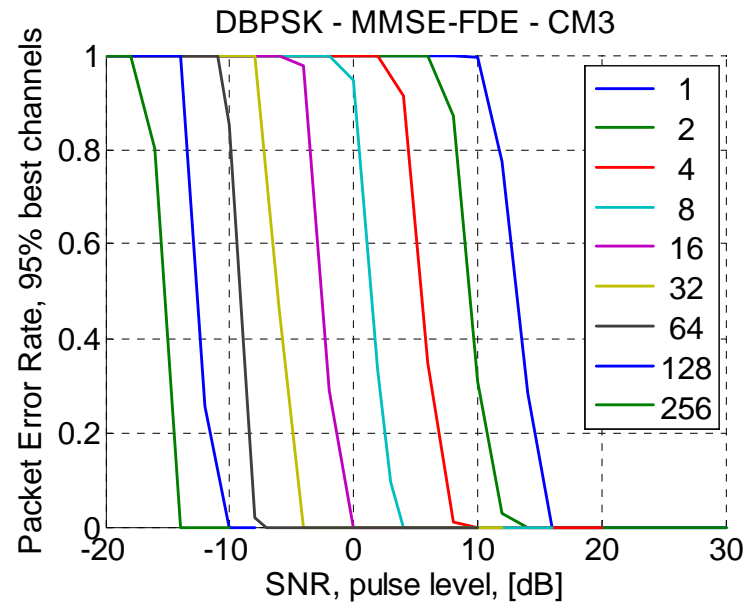
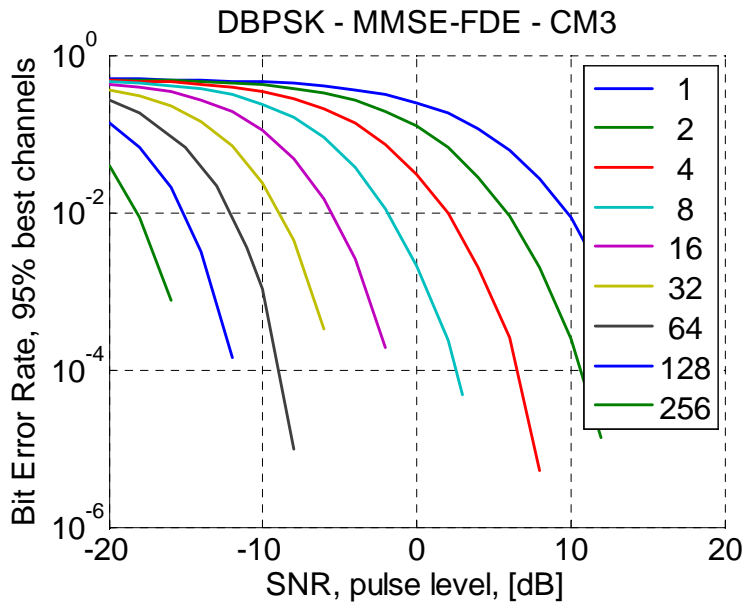

DBPSK – MMSE-FDE – CM4

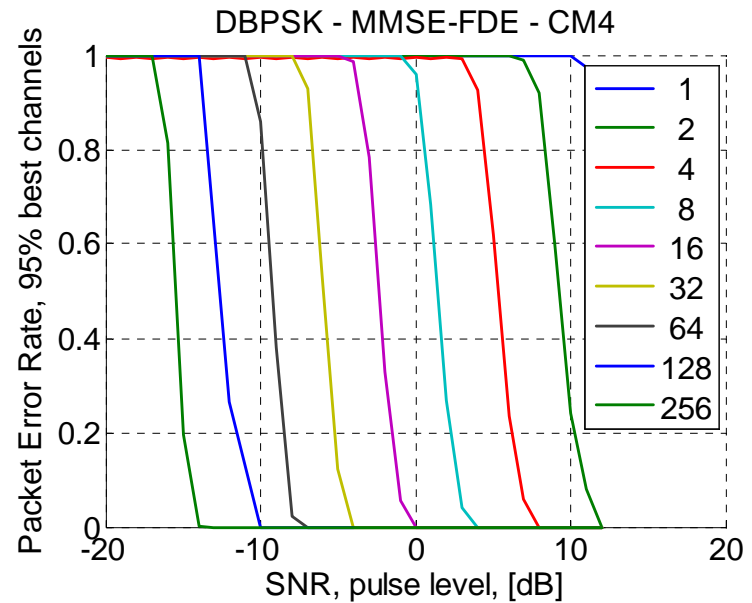
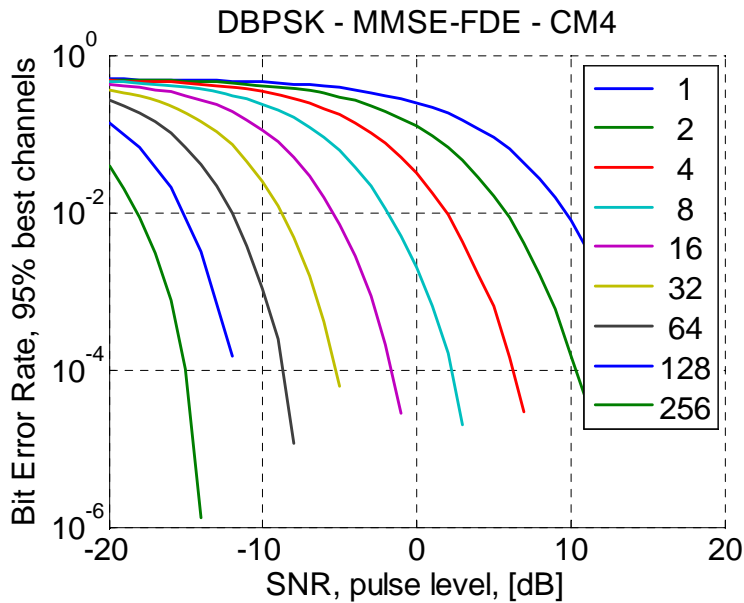

DBPSK – Link budget

- Thermal noise (30°C, 500 MHz),
- Receiver noise figure 12 dB
- TX power 0 dBm
 - Based on 316 mV peak amplitude
- Isotropic antennas
- 9 dB body shadowing, multipath fading, matched filter mismatch
- 2 dB board losses

DBPSK – Path loss

- According to channel model document 08-0780-06-0006
- CM3:
$$PL [dB] = 19.2 * \log_{10}(d [mm]) + 3.38$$
- CM4:
 - Free space path loss
 - Centre frequency: 6 GHz

DBPSK – Uncoded Range – CM3

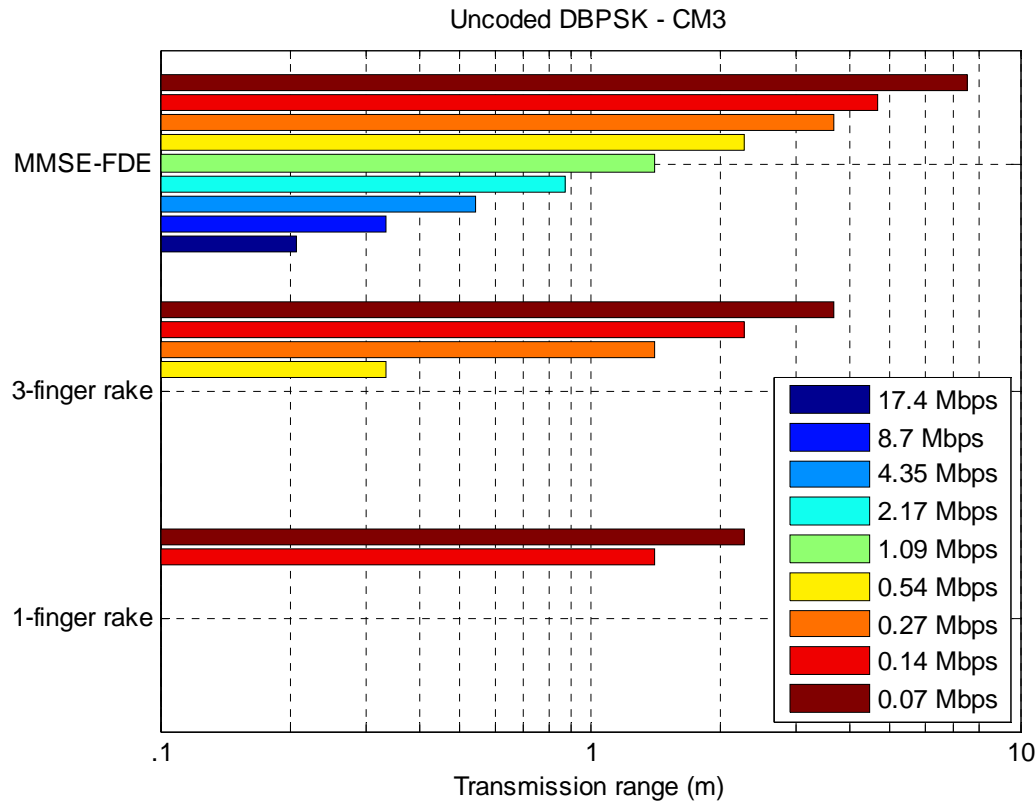

DBPSK – Uncoded Range – CM4

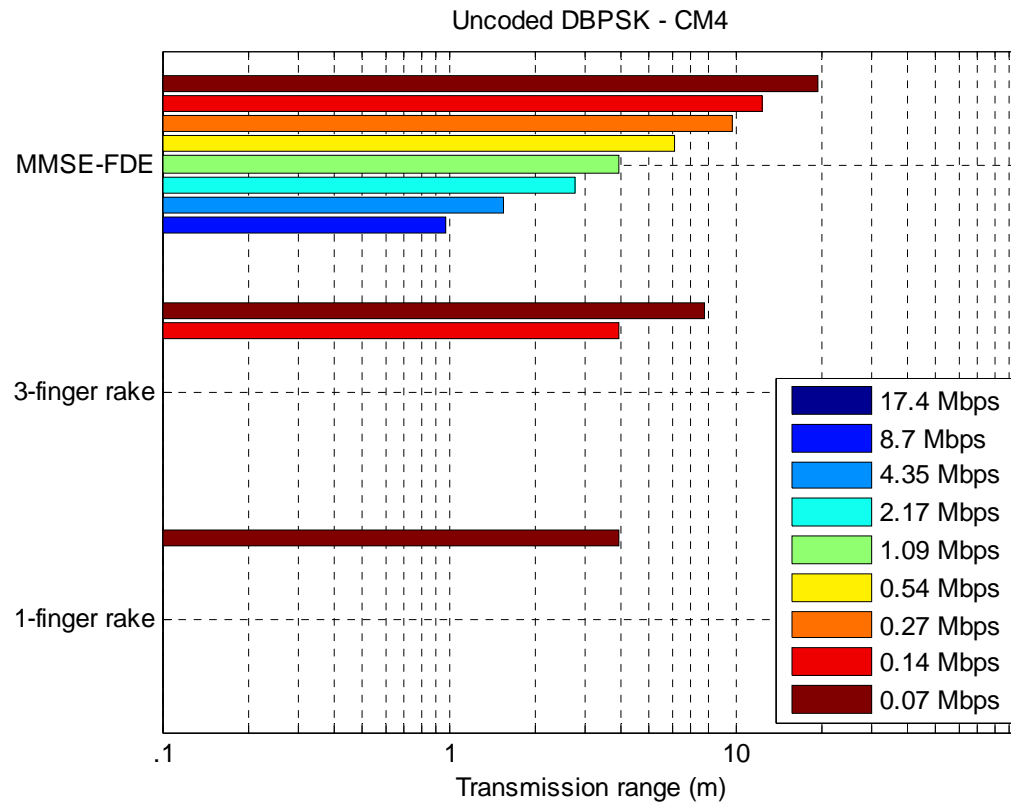

DBPSK - Comments

- Forward error correction not included yet:
 - Will eliminate/lower error floor for rake receivers;
 - Will extend range for all receivers

OOK – Energy Detector

- Energy detector chosen as simplest possible OOK receiver
- Threshold set at average signal power observed through the burst

OOK – Energy detector – CM3

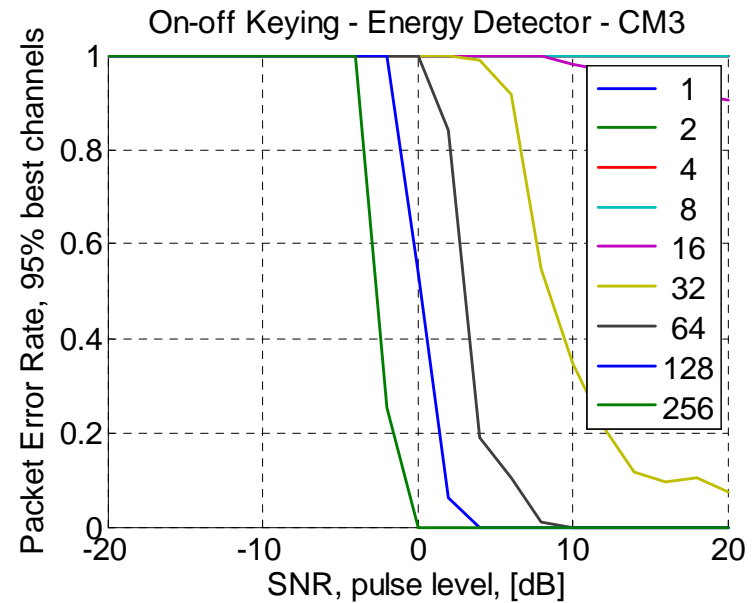
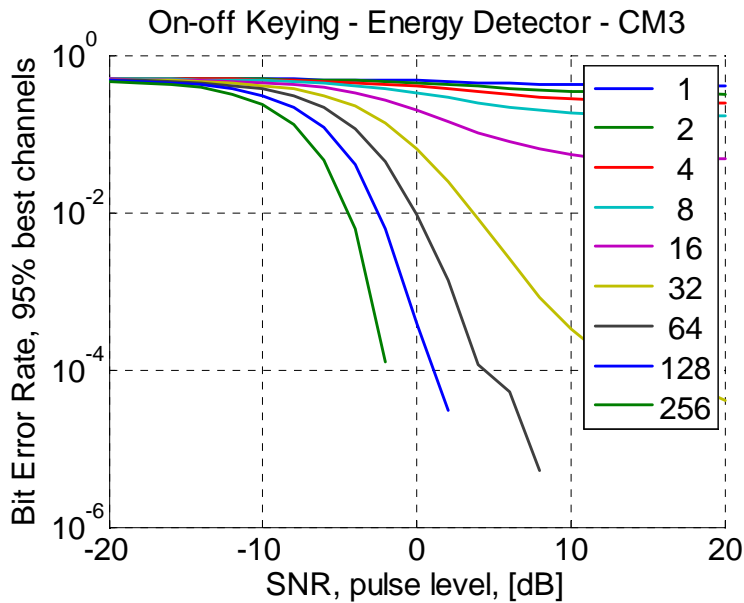

OOK – Energy Detector – CM4

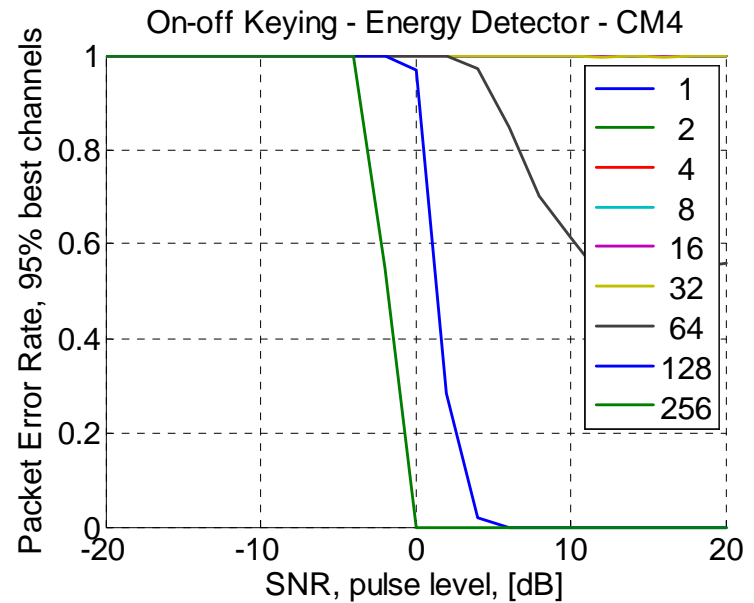
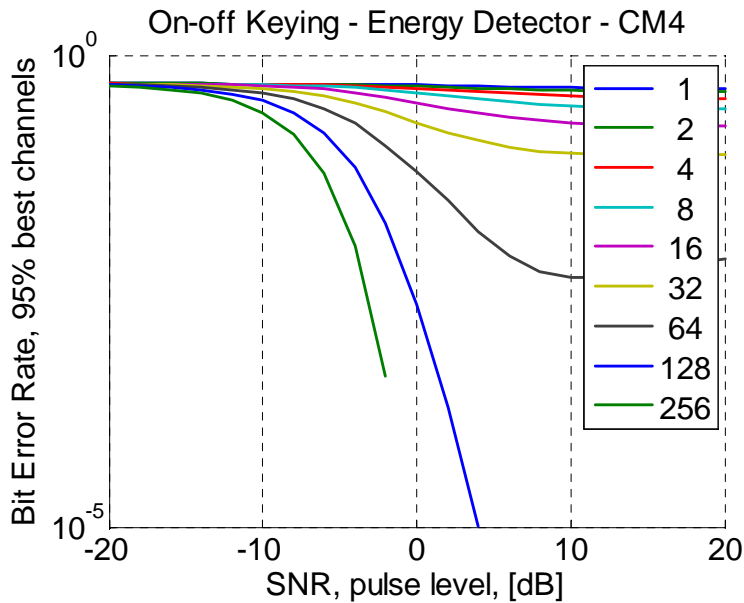

OOK – MMSE-FDE – CM3

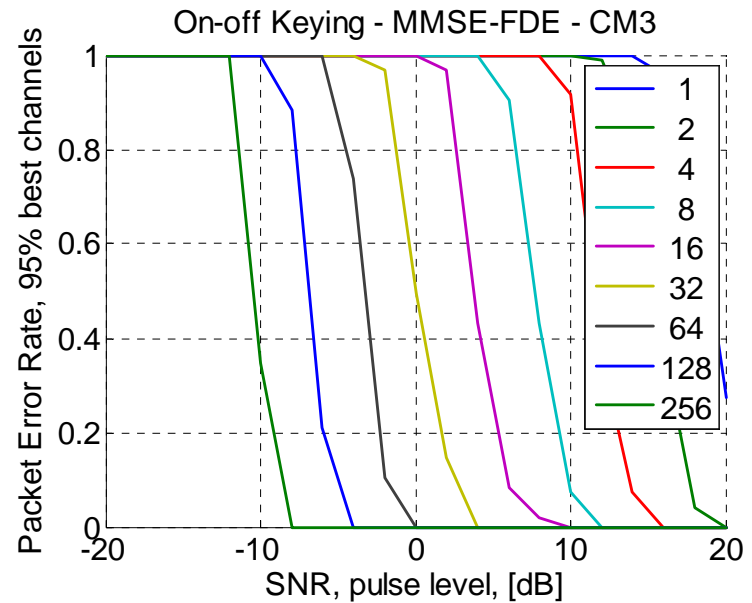
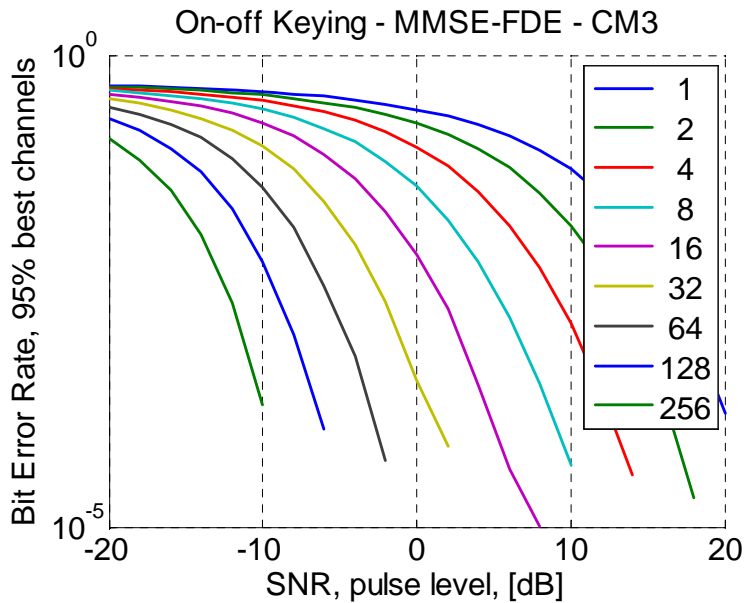

OOK – MMSE-DFE – CM4

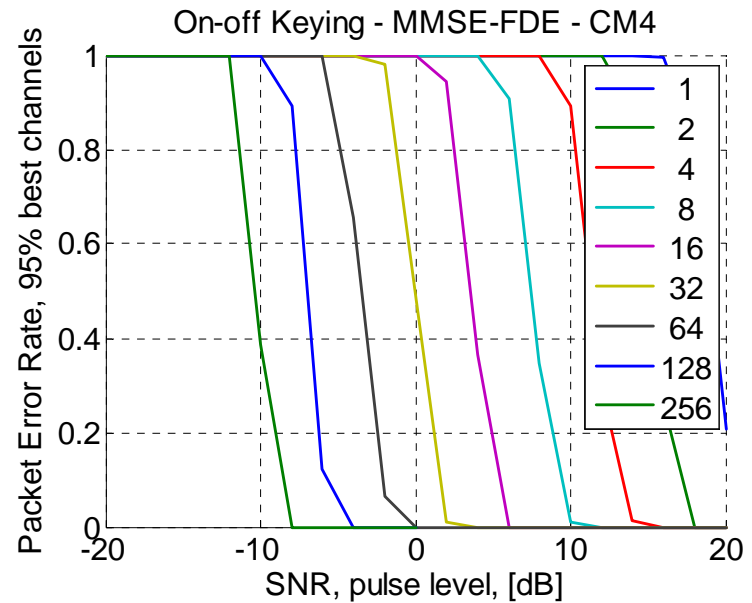
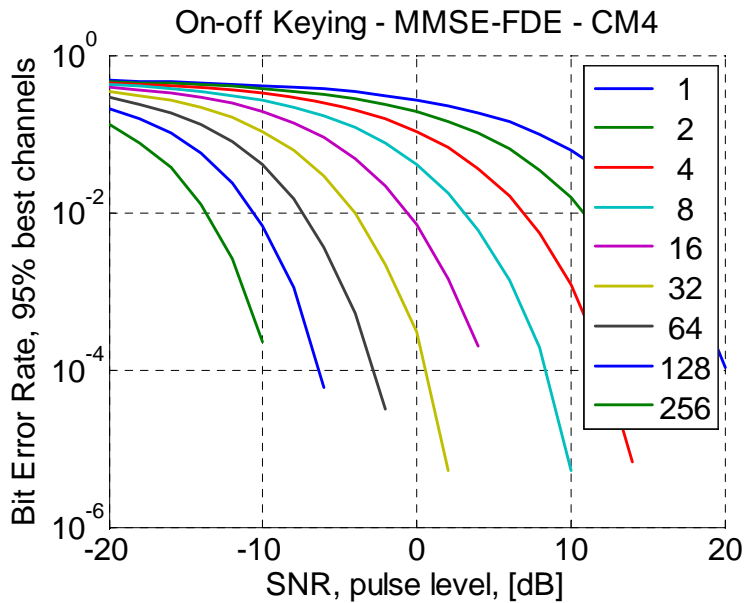

OOK – Uncoded Range – CM3

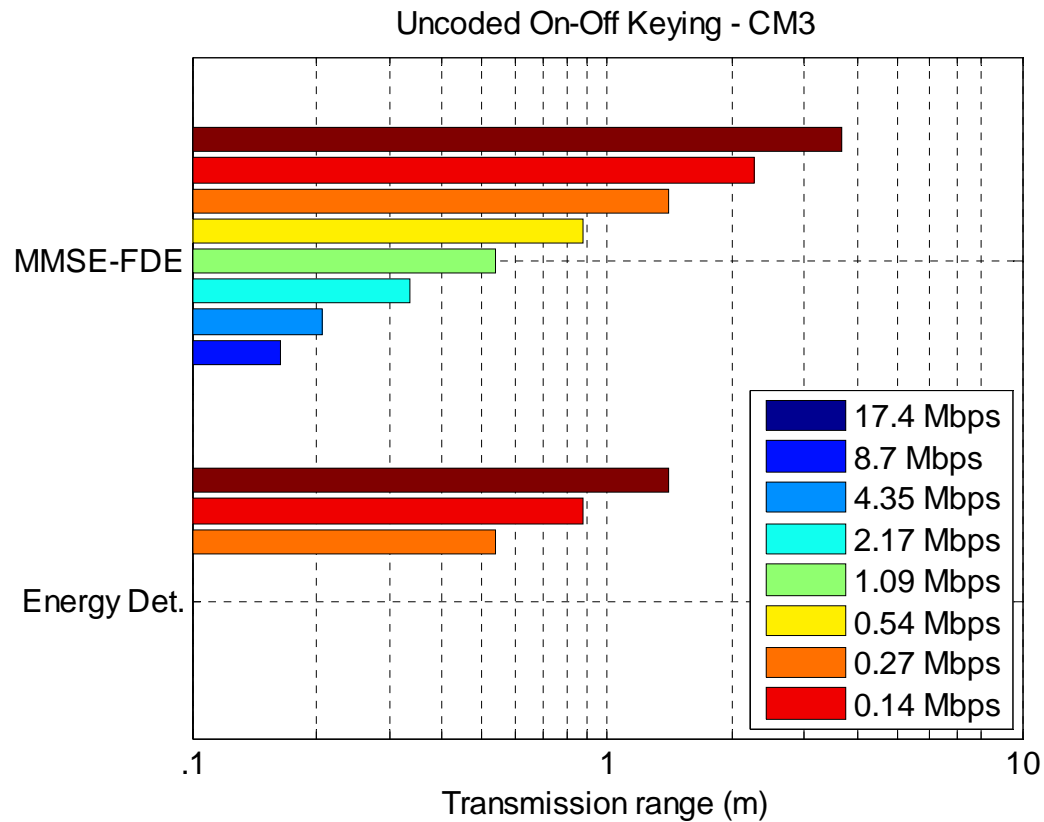

OOK – Uncoded Range – CM4

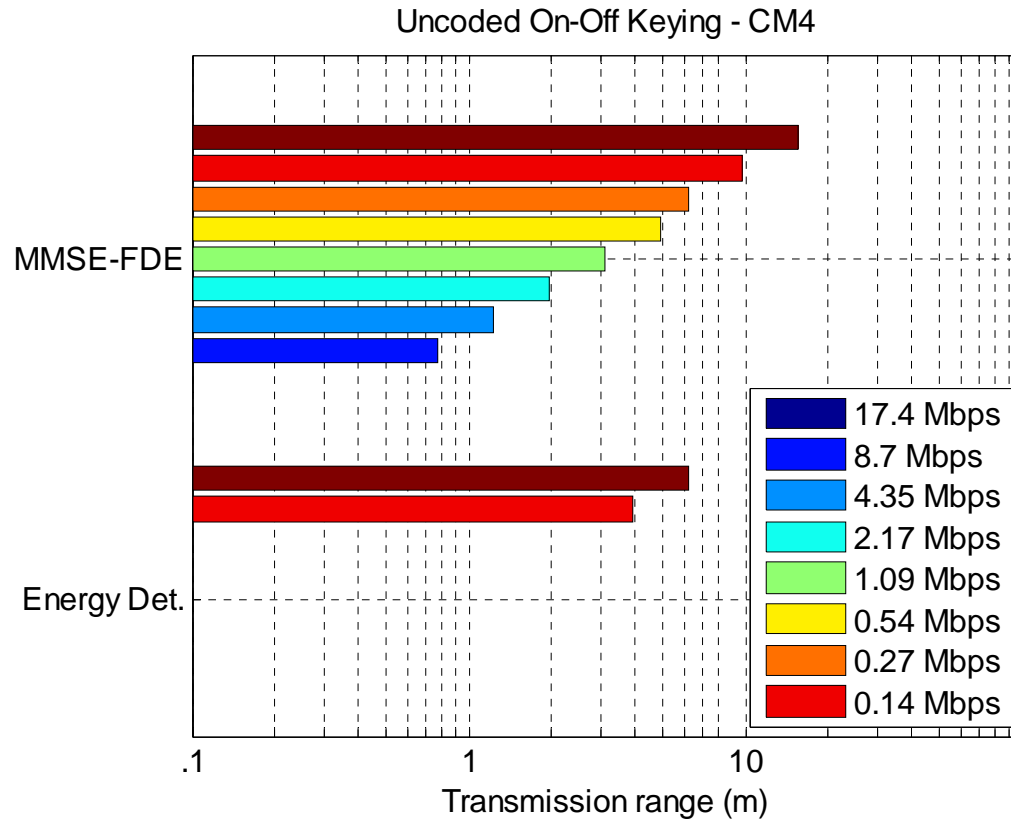

Expected Power Consumption Figures

- Power consumption pattern

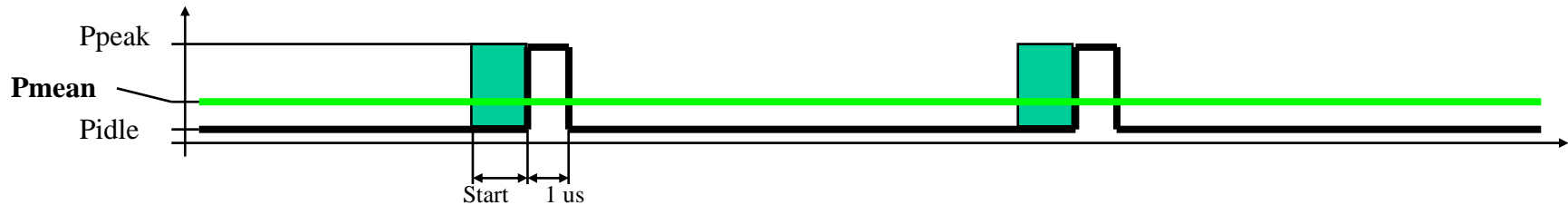

- Limiting peak current drawn from Battery
 - Use Capacitor to store energy from battery between strings
 - Draw current from capacitor to power-up during strings
 - Dimensioning Capacitor:
 - 0.1 V voltage drop for 50 mA supply over that duration of the string
 - 500 nF is sufficient, SMD component – Scales with string duration
 - Battery 'sees' only P_{mean}

Expected Power Consumption Figures

- Consider comparable figures for Tx & Rx:
 - P peak = 50 mW
 - P idle = 0.1 mW
 - Start time = 1 us
- Mean Power = 3.5 mW

Evidence of practical feasibility

- ICs in our labs - Published Material
- Full Transmitter in C90 CMOS
 - Fully Duty Cycled
 - 1 mW Power consumption (P mean)
- ISSCC 2007

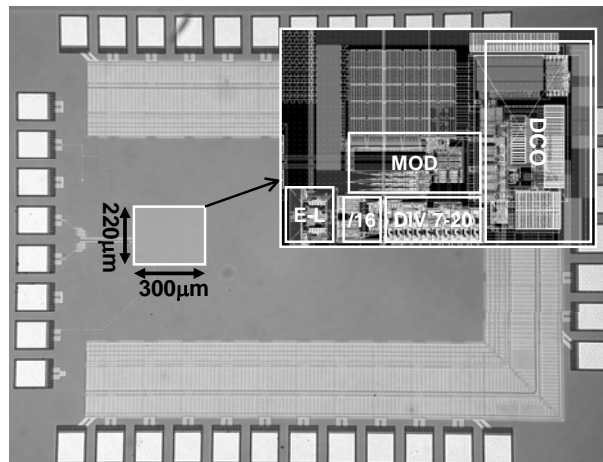

Evidence of practical feasibility

- 180 nm CMOS UWB Receiver successfully demodulates UWB signal @ Low Power
 - 3.1 – 5 GHz (UWB lower band)
 - 30 mW Power Consumption
 - No Signal Duty Cycling
- ISSCC 2006

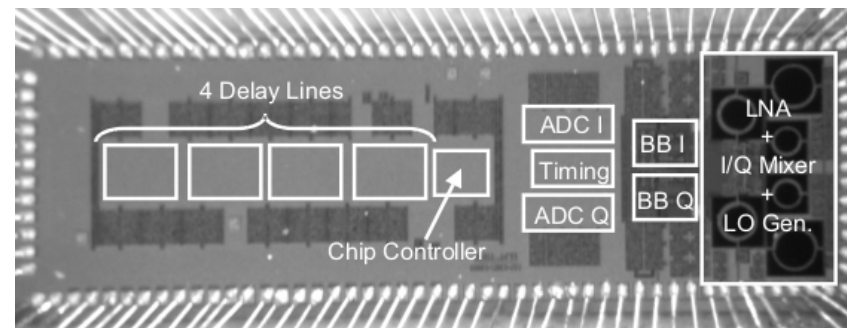

Conclusions

- Group Bursts to increase Duty Cycling Efficiency @ High Datarates
- Use OOK @ low data rates to let simple receivers operate
- Use DBPSK @ higher datarates to avoid costly timing reference
- Use FD-Equalizer at high datarates to avoid ISI-Induced performance issues