

## IEEE P802.15 Wireless Personal Area Networks

Project	IEEE P802.15 Working Group for Wireless Personal Area Networks (WPANs)	
Title	<b>Coexistence assurance</b>	
Date Submitted	[19 January, 2009]	
Source	[James P. K. Gilb] [SiBEAM] [555 N. Mathilda, Suite 100, Sunnyvale, CA 94085]	Voice: [408-245-3120] Fax: [408-245-3120] E-mail: [last name at ieee dot org]
Re:	[]	
Abstract	[Analyze the coexistence of 802.15.3c with other systems in the band.]	
Purpose	[Address coexistence capabilities of 802.15.3c.]	
Notice	This document has been prepared to assist the IEEE P802.15. It is offered as a basis for discussion and is not binding on the contributing individual(s) or organization(s). The material in this document is subject to change in form and content after further study. The contributor(s) reserve(s) the right to add, amend or withdraw material contained herein.	
Release	The contributor acknowledges and accepts that this contribution becomes the property of IEEE and may be made publicly available by P802.15.	

Additional authors (in alphabetical order by last name)

- Tuncer Baykas, NICT
- Hiroshi Harada, NICT
- Shu Kato, NICT
- Zhou Lan, NICT
- M. Azizur Rahman, NICT
- Chin Sean Sum, NICT
- Junyi Wang, NICT

1  
2  
3  
4  
5  
6  
7  
8  
9  
10  
11  
12  
13  
14  
15  
16  
17  
18  
19  
20  
21  
22  
23  
24  
25  
26  
27  
28  
29  
30  
31  
32  
33  
34  
35  
36  
37  
38  
39  
40  
41  
42  
43  
44  
45  
46  
47  
48  
49  
50  
51  
52  
53  
54

## 1. Introduction

The 60 GHz band has been allocated in many geographic regions because it coincides with an oxygen absorption band. In the center of this band, this increases the attenuation in air by about 15 dB/km. However, at the 10 m range envisioned for 802.15.3c, this attenuation is only 0.15 dB.

Many of the geographic regions in the world have made available a very large spectrum for unlicensed or similar operation, typically 7 GHz. This makes it possible to easily send > 1 Gbps of data using just a portion of this allocation. However, because of the higher frequency, relatively high gain transmit and receive antennas (about 10-15 dBi) are required to satisfy the link budget. This is an advantage from the point of view of coexistence in that the transmitters are focusing the transmit power in a specific direction, rather than spreading the transmit energy in an omni-directional manner. Likewise, the receiving antennas are focused in the direction of the transmit power and attenuate the power from potential interferers in other directions.

For hand-held devices, e.g., cell phones, personal music players or personal video players, the user will simply point the device in the general direction of the receiver. These devices will typically have fixed antenna patterns with somewhat lower gain antennas and connect over relatively short distances (about 2 m).

For video sources, e.g., video disc players, set-top boxes, and video sinks, e.g., flat panel displays, the location and position of the devices is typically fixed. Therefore, these devices will typically use dynamically adaptable transmit and receive antennas to be able to adapt to a changing environment due to the movement of people in a room. These devices will need to make connections over a somewhat greater distance (5–10 m).

### 1.1 Regulatory information

A summary of key requirements for selected regulatory regions is given in Table 1. The list is neither exhaustive nor complete. In addition, the rules in many countries are under development and may change.

**Table 1—Requirements for selected geographic regulatory regions**

Region	Regulatory document	Band	Maximum EIRP	Other
Canada	RSS-210, Issue 6, September 2005	57.05-64 GHz	40 dBm average 43 dBm peak	
Japan	Regulations for the enforcement of radio law, 6-4.2 specified low power radio station (17) 59-66 GHz band	59-66 GHz	57 dBi	< 2.5 GHz occupied bandwidth
USA	47CFR15.255	57.05-64 GHz	40 dBm average 43 dBm peak	
EU	ETSI DTR/ERM-RM-0491	59-66 GHz	57 dBm	ETSI recommendation
South Korea		57-64 GHz	27 dBm	Under development
New Zealand	Radiocommunication Regulation (General User Radio License for Short Range Devices) Notice 2007	57.05-64 GHz	40 dBm average 43 dBm peak	

## 1.2 Overview of 802.15.3c

This standard defines the PHY specification and MAC extension based on 802.15.3 for high data rate mmWave WPAN systems. An objective of this standard is to achieve coexistence with other systems operating on 60 GHz band. A number of methods are specified for coexistence, including common channelization, common transmission power spectral density (PSD) mask, enhanced clear channel assessment (CCA) by common mode signaling (CMS), transmission directivity and Sync frame transmission.

### 1.2.1 Common channelization

The frequency band available for mmWave WPAN systems is allocated in the range of 57.0-66.0 GHz. 802.15.3c generates four channels with central frequencies of 58.320, 60.480, 62.640, 64.800 GHz. This channelization is also adopted by ECMA and WirelessHD, which gives the basis of harmonized co-existence of mmWave WPAN systems in unlicensed bands. The channelization for the mmWave PHY is defined in Table 2.

**Table 2—mmWave PHY channelization**

CHNL_ID	Start frequency <sup>a</sup>	Center frequency	Stop frequency <sup>a</sup>
1	57.240 GHz	58.320 GHz	59.400 GHz
2	59.400 GHz	60.480 GHz	61.560 GHz
3	61.560 GHz	62.640 GHz	63.720 GHz
4	63.720 GHz	64.800 GHz	65.880 GHz

<sup>a</sup>The start and stop frequencies are nominal values. The frequency spectrum of the transmitted signal needs to conform to the transmit power spectral density (PSD) mask for the PHY mode as well as any regulatory requirement

### 1.2.2 Common transmission PSD mask

A common transmission power spectral density (PSD) mask is used for all three PHYs. The transmission PSD mask for the PHYs is illustrated in Figure 1.

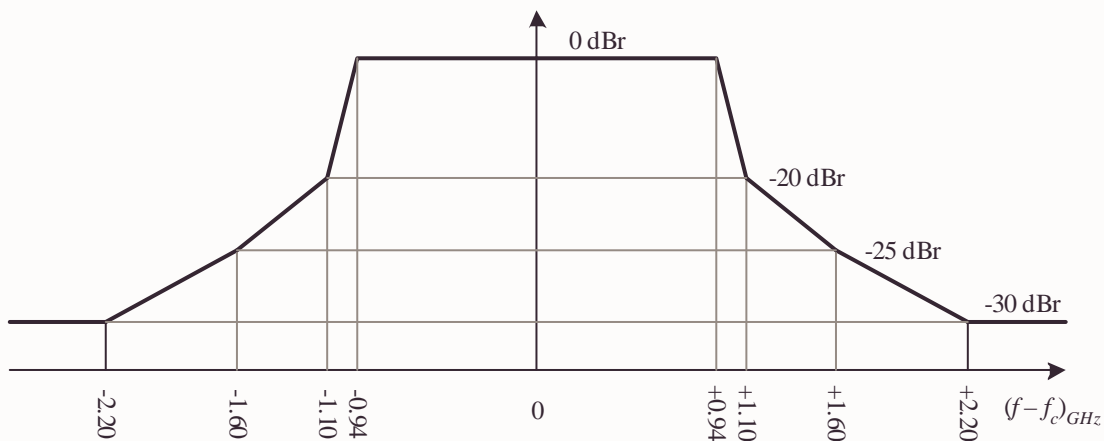

**Figure 1—Transmit spectral mask**

Devices that implement the mmWave PHY support at least one of the following three PHYs.

- a) Single carrier mode in mmWave PHY (SC PHY),
- b) High speed interface mode in mmWave PHY (HSI PHY),
- c) Audio/visual mode in mmWave PHY (AV PHY),

The common transmission PSD mask limits the allowable out-of-band spectrum, so to limit the adjacent channel interference (ACI) for better coexistence.

### 1.2.3 Passive scanning

All 802.15.3c PNC capable DEVs (i.e. ACs) are required to passively scan, as described in 8.2.1, a potential channel before attempting to start a piconet, as described in 8.2.2. The PNC capable DEV will, at a minimum, be looking for a channel that is relatively quiet. Passive scanning implies that the PNC capable DEV, when starting a piconet, or other DEVs that wish to join an existing piconet will not cause interference while searching the channels.

### 1.2.4 Dynamic channel selection

The PNC will periodically request channel status information, as described in 8.9.4, from the DEVs in the piconet via the Channel Status Request command, as described in 7.5.7.1. If the PNC determines, from the number of lost frames, that the channel is having problems then it would search for a new channel, as described in 8.11.1, that had a lower level of interference. If the PNC finds a channel with less interference then the PNC uses the Piconet Parameter Change IE in the beacon, as described in 7.4.6, to move the piconet to a quieter channel.

Thus, if another network is present, the 802.15.3c piconet would change channels to avoid interfering with the other network.

### 1.2.5 The ability to request channel quality information

Dynamic channel selection, as described in 8.11.1, requires the ability to obtain an estimate of the interference in a channel. In the case of 802.15.3, not only does the DEV sense the channel in its area, but it is also capable of asking any other DEV to respond with its own estimate of the channel status, as described in 8.9.4. These commands indicate the frame error rate at a remote DEV. This command is useful for detecting coexistence problems in remote DEVs by the PNC or other DEVs that are unable to detect an interference environment (for example during a passive scan).

### 1.2.6 Link quality and RSSI

The mmWave PHY specifies that a DEV returns the received signal strength indication relative to the sensitivity (RSSI<sub>r</sub>), signal and interference to noise ratio (SINR), and frame error ratio (FER) as described in 12.1.8.3. The RSSI<sub>r</sub> provides an estimate of the strength of the received signal relative to the DEV's sensitivity, which is useful for transmit power control. The RSSI combined with SINR, provides a method to differentiate between low signal power and interference causing the loss of frames. For example, if the RSSI<sub>r</sub> is low and frames are being lost, then the cause is low receive power. On the other hand, if the RSSI<sub>r</sub> is relatively high, but the SINR is low, that would indicate the possibility of interference in the channel.

### 1.2.7 Neighbor piconet capability

The neighbor piconet capability, as described in 8.2.6 of IEEE Std 802.15.3-2003, allows a DEV, which may not be fully 802.15.3c compliant, to request time to operate a network that is co-located in frequency with the 802.15.3c network. This allows a dual mode (e.g., 802.15.3c/802.11ad) device to cooperatively share the time in the channel.

### 1.2.8 Directivity

Transmission directivity, an effective way to avoid interference and improve the coexistence capability due to narrow directional beam for transmission and reception, is supported by the standard with the beam forming technology. Two types of beam forming procedures, namely pro-active beam forming and on-demand beam forming. Both of them support a multitude of antenna configurations. Pro-active beam forming may be used when the PNC is the source of data to one or multiple devices. It allows multiple devices to train the receiver antennas for optimal reception from the PNC with low overhead. On-demand beam forming may be used between two devices or between the PNC and a device. Both of these two beam forming procedures can be completed within one super frame, which minimizes the potential interference to other systems during beam forming set-up.

### 1.2.9 Sync frame transmission

Hidden devices in the different piconets may generate strong interference which may dramatically impact the performance. This standard defines an optional Sync frame transmission function to address this issue. A device capable of Sync frame transmission may transmit a Sync frame in the obtained CTA to extend the detection range of the exiting piconet. The Sync frame contains CTA information of the existing piconet, which can be utilized by a device receiving it as time reference to mitigate interference and enhance coexistence.

### 1.2.10 Enhanced CCA with CMS

To promote coexistence and interoperability, a CMS is defined based on a robust SC PHY mode. All PNC capable devices shall transmit and receive CMS to improve CCA capability by detecting signals instead of detecting energy. The start of a valid CMS preamble sequence at a receive level equal to or greater than the minimum sensitivity for the CMS shall indicate medium busy with a probability of  $> 90\%$  within  $5\ \mu\text{s}$ . The receiver CCA function shall in all circumstances report medium busy with any signal 20 dB above the minimum sensitivity for the CMS.

### 1.2.11 Limited propagation range

Because of the attenuation of typical walls, devices implementing the 802.15.3c standard will normally be limited to connections within a single room. Devices will see little to no energy from the transmitters in adjacent rooms

## 1.3 Characteristics of typical implementations

Typical implementations of 802.15.3c systems include uncompressed video content streaming, PC/laptop peripherals connection and handheld device sync-and-go applications. For uncompressed video streaming, the typical settings are TX power of 10 dBm, antenna gain of 13 dB (half power bandwidth (HPBW)  $30^\circ$  for 15 dBi) and non-line-of-sight (NLOS) channel over a 5 m range. For PC peripheral connections, the typical settings are TX power of 10 dBm, antenna gain of 10 dB (HPBW  $60^\circ$  for 9 dBi) and line-of-sight (LOS)/NLOS over 2-3 m. For sync-and-go applications, the typical settings are TX power of 0 dBm, antenna gain of 10 dBi and LOS channel over 1 m. For fixed devices, steerable antennas are assumed, and for handheld devices and PCs, fixed antennas are assumed.

Different networks are supposed to perform channel scanning and occupy different channels for operation. For example, a laptop-to-handheld network before occupying a channel shall scan the channels for any existing network. If it discovers an existing network already operating in the same channel, it seeks to search for adjacent or alternate channels. If all channels are full, no further networks are permitted in the same location.

This channel scanning feature prevents multiple networks to collide in the same channel. If the channel scanning fails, the new incoming network will occupy the same channel as the existing network, thus generating co-channel interference (CCI). Successful channel scanning although preventing the generation of CCI, networks occupying adjacent channels may still interfere with each other through undesired out-of-band spectrum in fading environment, adjacent channel interference (ACI). This is also known as the near-to-far problem.

In a typical scenario, a victim receiver (e.g. a video streaming network with TX power 10 dBm, TX antenna gain 13 dB) may be separated 5 m away from the desired transmitter and 1m away from the interferer (e.g. a handheld device connection with TX power 0dBm, TX antenna gain 10 dB). In this case, the desired-to-undesired signal ratio (DUR) is -1 dB. This gives the equivalent carrier-to-interference ratio (CIR) (i.e. the ACI after filtering or CCI-equivalent) of approximately 30 dB. With this amount of interference, the observed degradation is insignificant in the victim receiver. In the worst scenario, the interferer may have even a nearer distance to the victim receiver of say, 0.1 m. In this case, the DUR becomes -20 dB and the CIR becomes 10 dB. This causes a considerable degradation to the victim receiver. Details of the calculation can be found in Table 3.

**Table 3—DUR calculation**

Scenario	Network	Tx Power (dBm)	Antenna Gain (dB)	Distance (m)	Path loss (dB)	Power at receiver (dBm)
	Victim Network	10	13	5	82	-59
Typical case	Interferer Network	0	10	1	68	-58
Worst case	Interferer Network	0	10	0.1	48	-38

## 1.4 Other systems using the 60 GHz band

The 802.11ad task group is developing a high-speed wireless system that will share the 60 GHz band with 802.15.3c. The 802.11ad TG has not yet selected a PHY or the MAC modifications that they will put in the standard. However, it is important to consider the potential impact of these systems with 802.15.3c systems.

In order to model this unknown system, some assumptions need to be made. In this analysis, the following assumptions are made about the future 802.11ad:

- The RF channelization is roughly the same in bandwidth (~2.1 GHz) and center frequencies
- Because the data rate targets are similar to 802.15.3c, assume that the sensitivity levels are similar
- The traffic on the network is predominantly data
- The transmit power and antenna gains are similar to those for either hand held devices or laptops

## 2. Coexistence scenarios and analysis

Although there are many features of 802.15.3c to prevent destructive co-channel interference (CCI), such as the common mode signaling and sync frame. There could be situations, where co-channel interference may occur. In such a situation, video transmission with low BER requirement and higher sensitivity to latency is more sensitive to interference compared to a data receiver.

For all scenarios considered, all of the devices are indoor, within a single room. This is the expected usage model for 802.15.3c.

In the anticipated usage model for 802.15.3c devices, we expect that there will typically be only one video network active in a room (because there would be a single display). In the case that there are two WPANs streaming video in a room, the beam forming protocol selects the antenna directions for TX and RX based on the link quality. This process substantially minimizes the CCI in a WPAN created by the other WPAN in the room. Handheld 802.15.3c devices, however, may not implement the beam forming technology, instead relying on the user to point the device in the correct direction. Because of this, the scenarios considered contain at least one handheld device.

## 2.1 Scenario 1: Video and data transmission

The first scenario is illustrated in Figure 2. The video devices DEV1 and PNC1 both have antenna gains of 15 dB with 3 dB beamwidth of 30 degrees. PNC1 streams video and has the transmit power of 10 dBm. RX1 is the PNC controller.

PC peripheral (non-video) PNC2 may start a piconet in the same channel, if all 802.15.3c channels are occupied and it cannot decode the CMS beacon correctly. In this case DEV2, which tries to communicate with PNC2, will cause CCI to the DEV1. For CCI calculation, we assume DEV2 has transmit power of 0 dBm, with antenna gain of 10 dB and 3dB beamwidth of 60 degrees. The relative positions are illustrated in Figure 2.

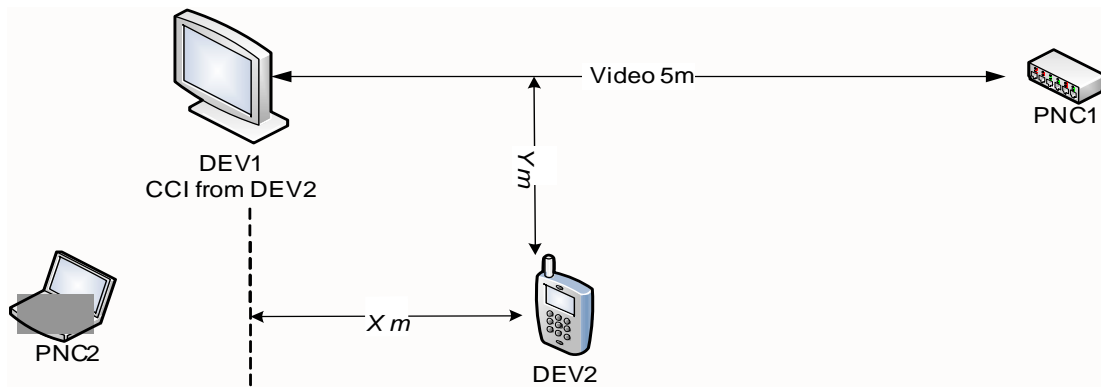

Figure 2—Relative position of devices for coexistence scenario 1.

In order to calculate the worst case results, we assume that DEV2's antenna is pointed at DEV1, rather than PNC2. In this configuration, DEV2 can still communicate with PNC2 because its antenna pattern is sufficiently broad.

The  $C/I$  level used as the metric for uncompressed video applications is the value at which BER has increased to an unacceptable level, which is set to  $10^{-4}$ . The threshold  $C/I$  level is 10 dB for uncompressed HD content streaming (1080p, 24 bit color, 60 Hz refresh rate). At this BER, the video quality will be visibly degraded. However, the difference between the  $C/I$  for acceptable video quality (11 dB for  $10^{-7}$  BER) and unacceptable (10 dB for  $10^{-4}$  BER) is only 1 dB. With a limited number of retries and subframe sizes of approximately 20 kbytes, a  $10^{-7}$  BER gives an application error rate of less than  $4 \times 10^{-11}$ , which is equivalent to the requirements for wireline uncompressed video solutions.

The results indicate that if the DEV2 is in a zone in front of the video receiver approximately 3 m long and 2 m wide, it will create a  $C/I$  level lower than 10 dB. For the AV receiver, the high interference zone in which it would have visibly degraded video quality is illustrated in Figure 3

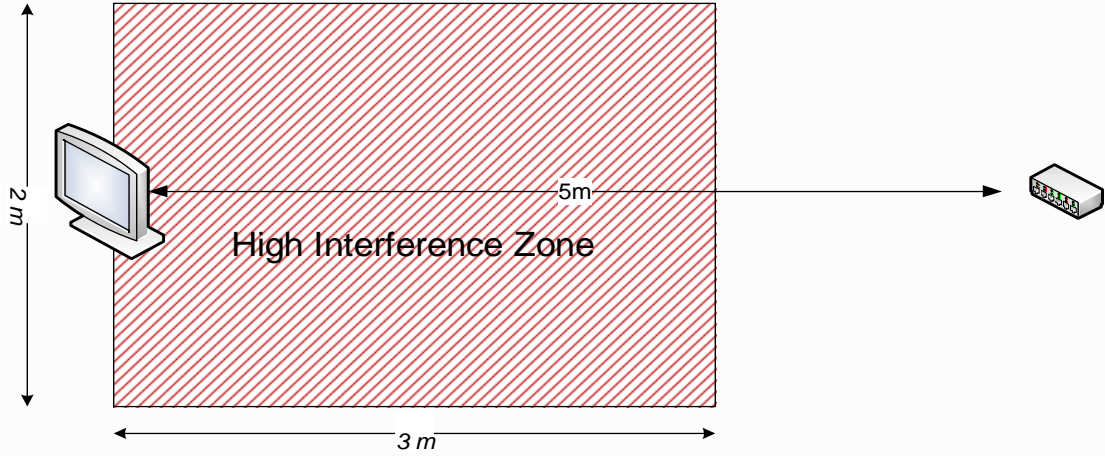

Figure 3—High interference zone for AV receiver.

Even in this case video receiver can beamform to a reflection other than the LOS path to improve performance or reduce the video resolution into half to keep the system.

An example of the link calculation for a single x and y position is shown in Table 4

Table 4—Example link budget calculation

Paramter	Value
Video communication link	
Tx Average Power ( $P_T$ )	10.00 dBm
Tx Antenna Gain ( $G_T$ )	15.0 dBi
Path Loss at 1m	68.00 dB
Propagation Loss Index	2
Distance	5 m
Rx Antenna Gain ( $G_R$ )	15.0 dBi
Carrier Power	-42 dBm
Interferer calculation	
Tx Average Power ( $P_T$ )	0.00 dBm
Tx Antenna Gain ( $G_T$ )	10.0 dBi
Path Loss at 1m ( $P_{L0}$ )	68.00 dB
Propagation Loss Index	2
x distance	2 m
y distance	0.5 m

1  
2  
3  
4  
5  
6  
7  
8  
9  
10  
11  
12  
13  
14  
15  
16  
17  
18  
19  
20  
21  
22  
23  
24  
25  
26  
27  
28  
29  
30  
31  
32  
33  
34  
35  
36  
37  
38  
39  
40  
41  
42  
43  
44  
45  
46  
47  
48  
49  
50  
51  
52  
53  
54



Table 4—Example link budget calculation (*continued*)

Parameter	Value
Distance(m)	2.0616 m
Rx Antenna Gain ( $G_R$ )	13.0 dBi
Interference Power ( $P_I$ )	-51 dBm
C/I Ratio	9 dB

## 2.2 Scenario 2: Data communication

In this scenario, both networks are engaged in data communication. The devices DEV1 and PNC1 both have antenna gains of 10 dB with 3 dB beamwidth of 60 degrees. PNC1 streams data at 3 Gb/s and has the transmit power of 10 dBm. RX1 is the PNC controller.

Assuming PNC2 started a piconet in the same channel, PNC2, which tries to communicate with DEV2, will cause CCI to the DEV1. For CCI calculation, we assume PNC2 has transmit power of 10dBm, with antenna gain of 10dB and 3dB beamwidth of 60 degrees. The relative positions are illustrated in Figure 4.

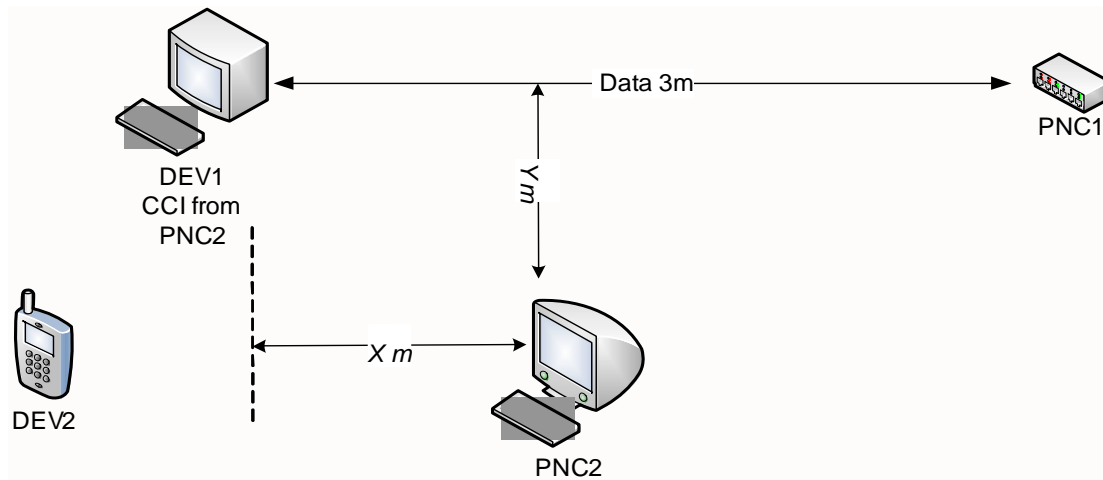

Figure 4—Relative position of devices for coexistence scenario 2.

We assume that PNC2 antenna is aligned towards to DEV2 and that the antenna of DEV1 is aligned with PNC1. At 3 m, the SNR is high enough that the CCI determines the throughput. We also assume that the CCI behaves like AWGN with a 2 dB difference loss. In this case any CCI level more than 12.5 dB won't have any performance degradation. A CCI level of 12.2 dB will cause BER of  $10^{-6}$  and approximately 98.4% throughput with 2 kbyte frame size, whereas 11.5 dB will decrease the BER to  $7 \times 10^{-5}$  to with a throughput of 31% and at 7 dB, the throughput will diminish to zero. According to previous results, the limitation due to CCI happens in at 3 m to 11 m range.

The results are summarized in Table 5. The results presented are valid for 802.15.3c WPANs. We expect that the impact on 802.11 TGad devices would be similar.

**Table 5—Throughput results for data interference scenario 2**

y	x									
	2m	3m	4m	5m	6m	7m	8m	9m	10m	11m
0.0 m	0 %	0 %	0 %	0 %	0 %	0 %	0 %	0 %	0 %	20 %
0.5 m	0 %	0 %	0 %	0 %	0 %	0 %	0 %	0 %	0 %	30 %
1.0 m	0 %	0 %	0 %	0 %	0 %	0 %	0 %	0 %	0 %	40 %
1.5 m	0 %	0 %	0 %	0 %	0 %	0 %	0 %	0 %	0 %	80 %
2.0 m	100 %	0 %	0 %	0 %	0 %	0 %	0 %	0 %	20 %	95 %
2.5 m	100 %	100 %	0 %	0 %	0 %	0 %	0 %	31 %	95 %	100 %
3.0 m	100 %	100 %	100 %	98.4 %	80 %	40 %	95 %	90 %	100 %	100 %

**3. Reference subclauses from 802.15.3c draft**

This section contains subclauses from the 802.15.3c draft D04 related to CMS mode and Sync frame. The are reproduced here for the convenience of the reader.

**3.1 Sync frame**

**3.1.1 Sync frame**

The Sync frame shall be formatted as illustrated in Figure 23a.

octets: 4	4	...	4	4	10
FCS	CTA block-n	...	CTA block-1	Synchronization parameters	MAC header

**Figure 23a—Sync frame format**

The Synchronization Parameters field shall be formatted as illustrated in Figure 23b.

octets: 2	2
Frame start time	Superframe duration

**Figure 23b—Synchronization parameters field format**

The Superframe Duration field indicates the duration of the current superframe, as described in 7.3.1.1.

The Frame Start Time field indicates the time stamp for the Sync frame which is the start time of the preamble of a Sync frame.

1  
2  
3  
4  
5  
6  
7  
8  
9  
10  
11  
12  
13  
14  
15  
16  
17  
18  
19  
20  
21  
22  
23  
24  
25  
26  
27  
28  
29  
30  
31  
32  
33  
34  
35  
36  
37  
38  
39  
40  
41  
42  
43  
44  
45  
46  
47  
48  
49  
50  
51  
52  
53  
54

The CTA Block field shall be formatted as illustrated in Figure 23c.

octets: 2	2
CTA duration	CTA location

**Figure 23c—CTA block field format**

The CTA Location field indicates the start time of the allocation, as described in 7.3.1.1.

The CTA Duration field specifies the duration of the CTA, as described in 7.3.1.1.

## 3.2 CMS mode

### 3.2.1 Common Mode Signaling (CMS)

Common mode signaling (CMS) is a low data rate SC PHY mode specified to enable interoperability among different PHY modes. The CMS is used for transmission of the beacon frame defined in 8.6.2, and, if supported, the sync frame defined in 7.3.6 and 12.1.9. The CMS is also used for transmission of command frame and training sequence in the beamforming procedure, as defined in Clause 13, for the SC and HSI PHYs.

The frame format of CMS is illustrated in Figure 24. The structure and details of the CMS PHY preamble are given in 3.2.1.5.



**Figure 24—CMS frame format**

The structure of the CMS frame header is illustrated in Figure 25, and the details are given in 3.2.1.6.



**Figure 25—CMS frame header format**

The details of the PHY Payload field in a CMS frame (i.e. the scrambled, encoded, spread and modulated MAC frame body) are given in 3.2.1.7.

When a CMS frame is transmitted, the PHY preamble is sent first, followed by the frame header, and then the PHY Payload field.

The chip rate of CMS is 1728 Mchips/s. The entire CMS frame shall be modulated with  $\pi/2$  BPSK/(G)MSK as specified in 3.2.1.1. The FEC for the CMS frame shall be the RS code as specified in 3.2.1.2. The frame header and MAC frame body shall be spread by a Golay sequence as specified in 3.2.1.3. The CMS preamble shall be excluded from the spreading process. The chips in the frame header, MAC frame body shall be grouped into subblocks, each of length 512 chips.

The header rate dependant parameters for CMS shall be set according to Table 6.

The last part of the CMS frame is the PHY Payload field. The MCS dependant parameters for the CMS PHY Payload field is given in Table 7.

**Table 6—Header rate dependant parameters for CMS**

Header rate (Mb/s)	Modulation	Spreading factor, $L_{SF}$	FEC type	FEC rate, $R_{FEC}$
12.3	$\pi/2$ BPSK / (G)MSK	64	RS(33,17)	17/33

**Table 7—MCS dependant parameters for CMS PHY Payload field**

MCS Identifier	Data rate (Mb/s)	Modulation	Spreading factor, $L_{SF}$	FEC type	FEC rate, $R_{FEC}$
CMS	25.3	$\pi/2$ BPSK / (G)MSK	64	RS(255,239)	239/255

**3.2.1.1 Modulation for CMS**

The modulation for CMS shall be the  $\pi/2$ -shift BPSK ( $\pi/2$  BPSK) / pre-coded MSK/GMSK ((G)MSK). The  $\pi/2$  BPSK modulation is a binary phase modulation with  $\pi/2$  phase counter-clockwise shift. The pre-coded MSK/GMSK ((G)MSK) modulation is a continuous phase modulation by applying differential pre-coding before the (G)MSK modulation. The use of MSK/GMSK modulations with appropriate filtering and pre-coding as an alternative way to generate  $\pi/2$  BPSK waveform signals for the CMS is allowed. Details of the modulation are given in 12.2.2.5.1.

**3.2.1.2 Forward error correction for CMS**

The FEC scheme for CMS shall be RS coding. The RS(255,239), which is the mother code, shall be used for encoding the MAC frame body of CMS. The RS(33,17), a shortened version of RS(255,239), shall be used for encoding the frame header of CMS. Details of the coding are provided in 12.2.2.6.1.

**3.2.1.3 Code spreading for CMS**

To increase robustness in the frame header and MAC frame body of the CMS, code spreading shall be applied using Golay sequences. The code spreading factor shall be 64, and the Golay sequence specified in Table 8 shall be used. The frame header and the MAC frame body shall be spread according to Figure 26. Note that in each hexadecimal-equivalent 4-binary-digit group, the leftmost bit shall be the msb, and the rightmost bit, the lsb. For example, 3 is denoted as 0011.

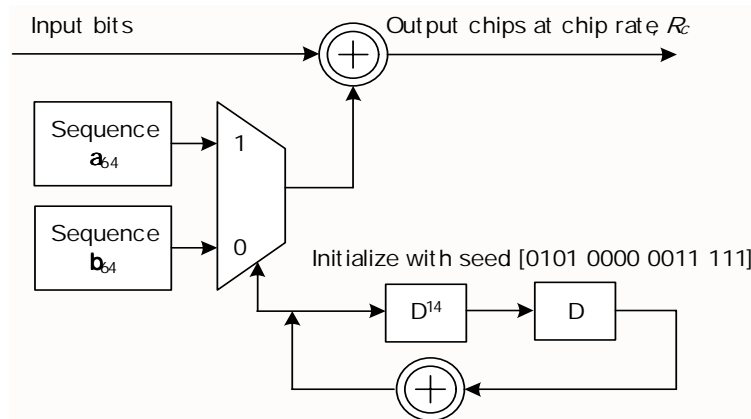

**Figure 26—Realization of the CMS code spreading**

1  
2  
3  
4  
5  
6  
7  
8  
9  
10  
11  
12  
13  
14  
15  
16  
17  
18  
19  
20  
21  
22  
23  
24  
25  
26  
27  
28  
29  
30  
31  
32  
33  
34  
35  
36  
37  
38  
39  
40  
41  
42  
43  
44  
45  
46  
47  
48  
49  
50  
51  
52  
53  
54

**Table 8—Golay sequences with length 64**

Sequence name	Sequence value
$\mathbf{a}_{64}$	1144DD88E14B2D87
$\mathbf{b}_{64}$	EEBBDD881EB42D87

### 3.2.1.4 Scrambling for CMS

To avoid spikes in the spectrum, scrambling shall be applied on the MAC header, HCS and MAC frame body of the CMS. The details of the scrambling process are given in 12.2.2.10.

### 3.2.1.5 PHY preamble for CMS

A PHY preamble shall be added prior to the CMS frame header to aid receiver algorithms related to AGC setting, timing acquisition, frame synchronization and channel estimation. The CMS preamble is shown in Figure 27.

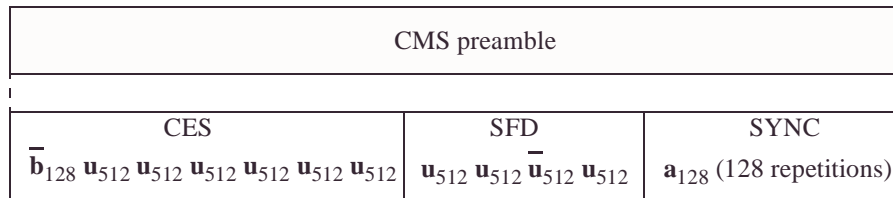
**Figure 27—PHY preamble structure for CMS**

Golay sequence of length 128 shall be used in the CMS preamble. The Golay complimentary sequences of length 128, denoted by  $\mathbf{a}_{128}$  and  $\mathbf{b}_{128}$ , are shown in Table 9. The code  $\mathbf{u}_{512}$  shall be constructed as below:

$$\mathbf{u}_{512} = [\mathbf{a}_{128} \bar{\mathbf{b}}_{128} \bar{\mathbf{a}}_{128} \bar{\mathbf{b}}_{128}]$$

Note that the binary-complement of a sequence  $x$  is denoted by an overline on  $x$  (i.e.  $\bar{x}$ ).

The SYNC field, mainly used in frame detection, shall consist of 128 code repetitions of  $\mathbf{a}_{128}$ . The SFD field, used to validate the beginning of a frame, shall consist of  $[\mathbf{u}_{512} \mathbf{u}_{512} \bar{\mathbf{u}}_{512} \mathbf{u}_{512}]$ . The CES field, used for channel estimation, shall consist of  $\bar{\mathbf{b}}_{128}$  followed by 6 repetitions of  $\mathbf{u}_{512}$ .

**Table 9—Golay sequences with length 128**

Sequence name	Sequence value
$\mathbf{a}_{128}$	C059950CC0596AF33FA66AF3C0596AF3
$\mathbf{b}_{128}$	30A965FC30A99A03CF569A0330A99A03

**3.2.1.6 Frame Header for CMS**

A frame header shall be added following the CMS preamble. The frame header conveys information in the PHY and MAC headers necessary for successfully decoding the frame. The construction of the CMS header is shown in Figure 28. The detailed process of the construction is as follows:

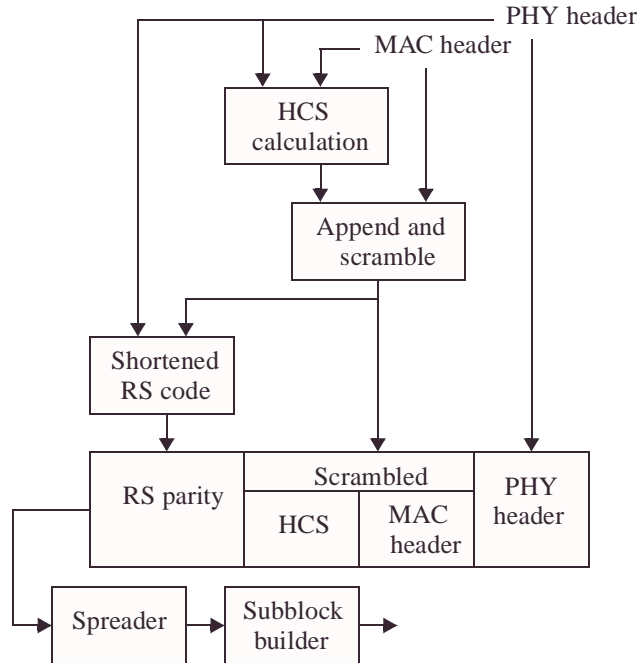

**Figure 28— Frame header construction process for CMS**

- a) Construct the PHY header based on information provided by the MAC,
- b) compute the HCS as described in 12.2.3.2.2 over the combined PHY and MAC headers
- c) append the HCS to the MAC header
- d) scramble the combined MAC header and HCS as described in 3.2.1.4.
- e) compute the RS parity bits by encoding the concatenation of the PHY header, scrambled MAC header and scrambled HCS into a shortened RS block code as described in 3.2.1.2, and
- f) form the base frame header by concatenating the PHY header, scrambled MAC header, scrambled HCS and RS parity bits.
- g) spread the frame header as described in 3.2.1.3,

**3.2.1.6.1 PHY header for CMS**

The CMS PHY header shall be formatted as illustrated in Figure 29.

<b>bits: 2</b>	<b>1</b>	<b>2</b>	<b>1</b>	<b>1</b>	<b>2</b>	<b>20</b>	<b>5</b>	<b>1</b>	<b>1</b>	<b>4</b>
Reserved	PCES	Pilot word length	Low latency mode	Beam tracking	Preamble type	Frame length	MCS	UEP	AGG	Scrambler seed ID

**Figure 29—PHY header format for CMS**

The description of each field is provided in 12.2.3.2.1. In this subclause, the field values for the CMS PHY header are specified.

1  
2  
3  
4  
5  
6  
7  
8  
9  
10  
11  
12  
13  
14  
15  
16  
17  
18  
19  
20  
21  
22  
23  
24  
25  
26  
27  
28  
29  
30  
31  
32  
33  
34  
35  
36  
37  
38  
39  
40  
41  
42  
43  
44  
45  
46  
47  
48  
49  
50  
51  
52  
53  
54

The Scrambler Seed ID field contains the scrambler seed identifier value, as defined in 3.2.1.4.

The AGG bit shall be set to zero.

The UEP bit shall be set to zero.

The MCS field shall be set to 0b00000.

The Frame Length field shall be an unsigned integer that indicates the number of octets in the MAC frame body, excluding the FCS.

The Preamble Type field shall be set to 0b00.

The Beam Tracking field shall be set to one if the training sequence for beam tracking is following the current frame, and shall be set to zero otherwise.

The Low Latency mode bit shall be set to zero.

The Pilot Word Length field shall be set to 0b00.

The PCES field shall be set to zero.

### 3.2.1.7 PHY Payload field for CMS

The PHY Payload field is the last component of the CMS frame, and is constructed as shown in Figure 30. The PHY Payload field of the CMS shall be constructed as follows:

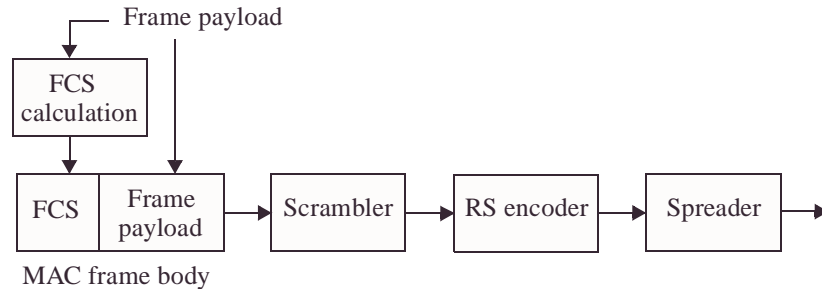

**Figure 30—PHY Payload field construction process for CMS**

- compute the FCS, as defined in 7.2, over the Frame Payload field,
- form the MAC Frame Body field by appending the FCS to the Frame Payload field,
- scramble the MAC Frame Body field according to 3.2.1.4,
- encode the scrambled MAC Frame Body field as specified in 3.2.1.2,
- spread the encoded and scrambled MAC Frame Body field using the spreading code as detailed in 3.2.1.3.