Project: IEEE P802.15 Working Group for Wireless Personal Area Networks (WPANs)

Submission Title: [VLC use case with image sensors]

Date Submitted: [9 November 2008]

Source: [(1)Shuji Suzuki, NEC]

Address [(1)1753 Shimonumabe Nakahara-ku Kawasaki 211-8666 Japan]

Voice:[(1)81-44-396-2245]

E-Mail:[(1) s-suzuki@dl.jp.nec.com]

Re: []

Abstract: [Advantage of image sensor for optical signal and position detector is explained. The example of high-speed image sensor also are presented.]

Purpose: [Contribution to IEEE 802.15 SG-VLC]

Notice: This document has been prepared to assist the IEEE P802.15. It is offered as a basis for discussion and is not binding on the contributing individual(s) or organization(s). The material in this document is subject to change in form and content after further study. The contributor(s) reserve(s) the right to add, amend or withdraw material contained herein.

Release: The contributor acknowledges and accepts that this contribution becomes the property of IEEE and may be made publicly available by P802.15.

VLC use case with image sensors

Shuji Suzuki

NEC

Image Sensor Use case

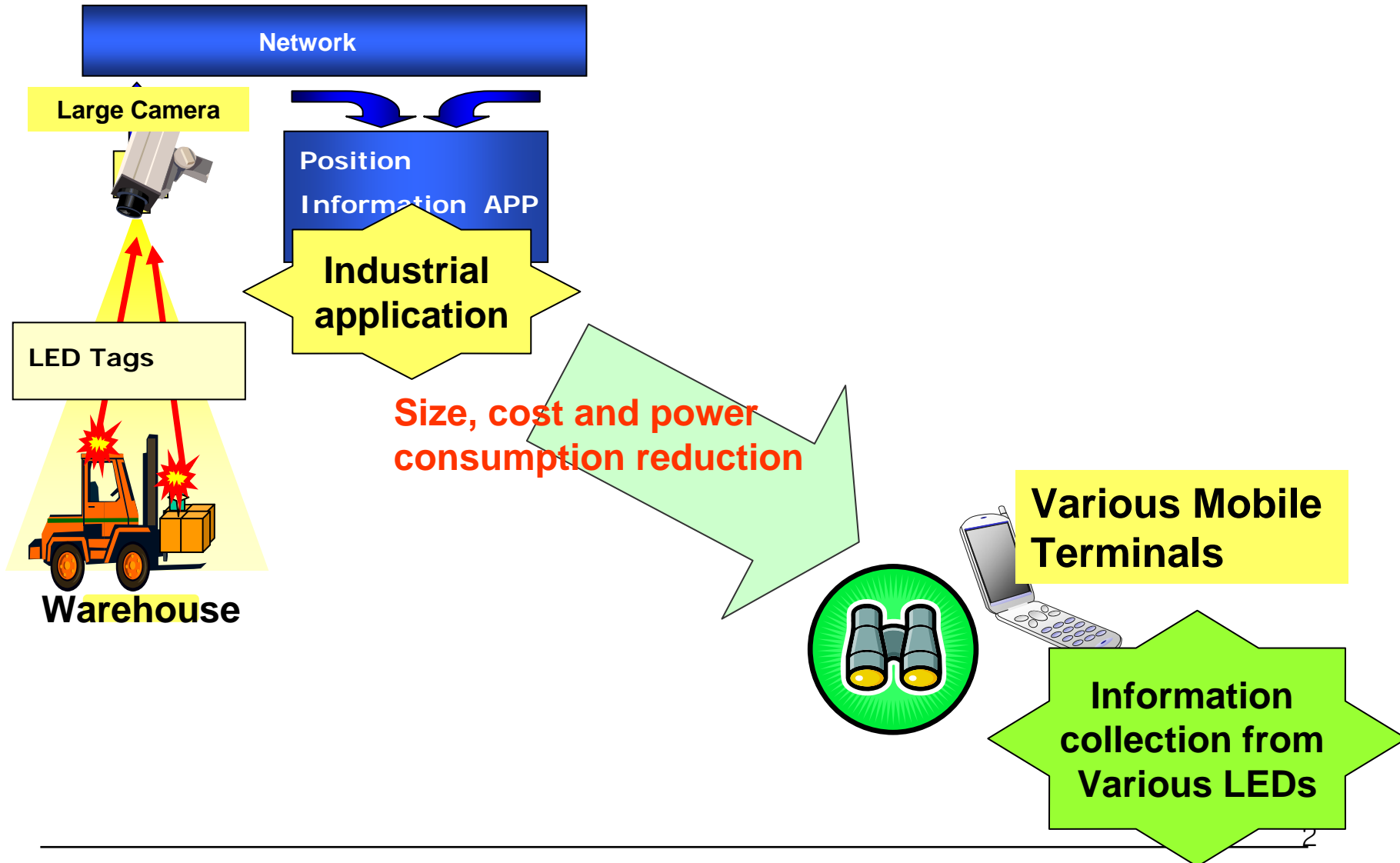

Application for Warehouse Management

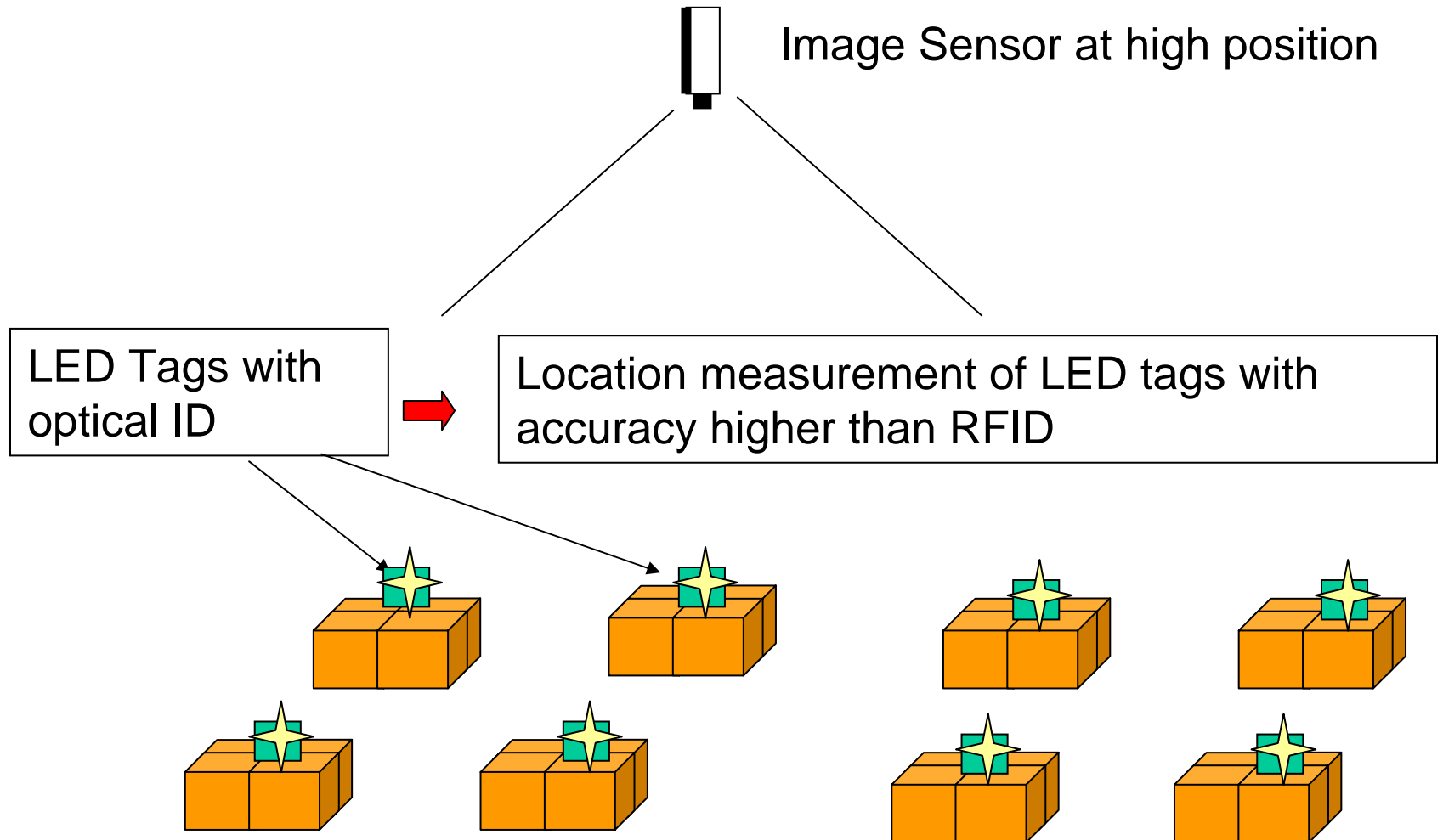

Location measurement accuracy

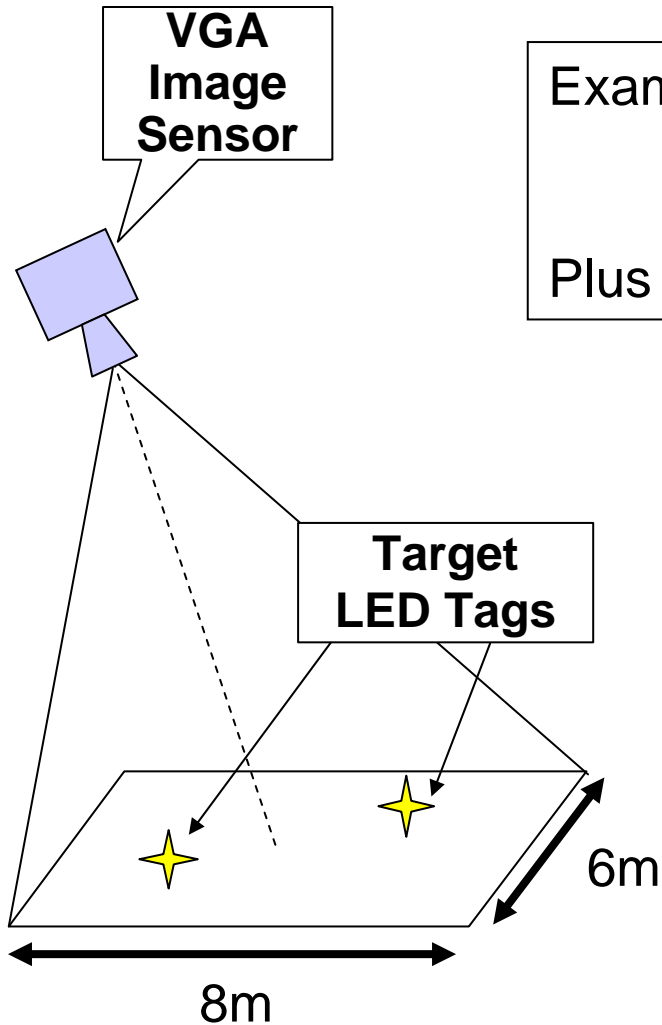

Example: 640 x 480 pixels (VGA) resolution

→ 1.25cm resolution for 8m x 6m

Plus Measurement error of distortion by optical lens

Experimental Results

5cm resolution for 8m x 6m plane with equalization software for lens distortion

Pretty good measurement accuracy

Image sensor in future mobile phone

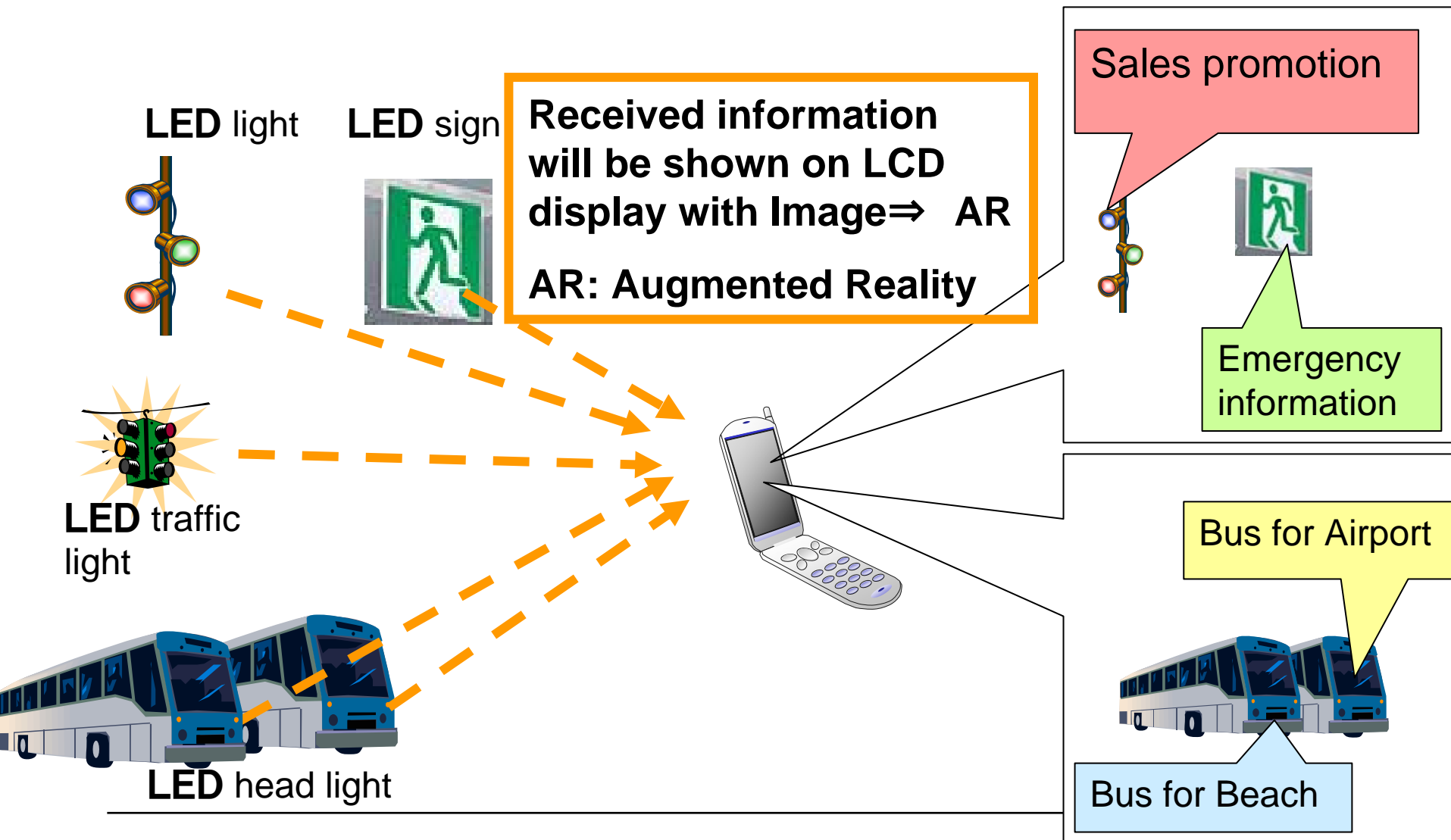

Optical signal receivers

1. Photo diode

Already used for free-space optics receiver (IrDA etc.)

Easy to receive high-speed optical signal

Limited space-division selectivity

→ Weakness for Interference light

2. Image Sensor:

Optical receiver with position detection

Capability of interference rejection

Low dependency for transmission distance

Limited frame-rate → Limited LED signal speed

Example of VL high-speed transmission

Received optical waveform 2.5 Gbps
650nm Laser Diode

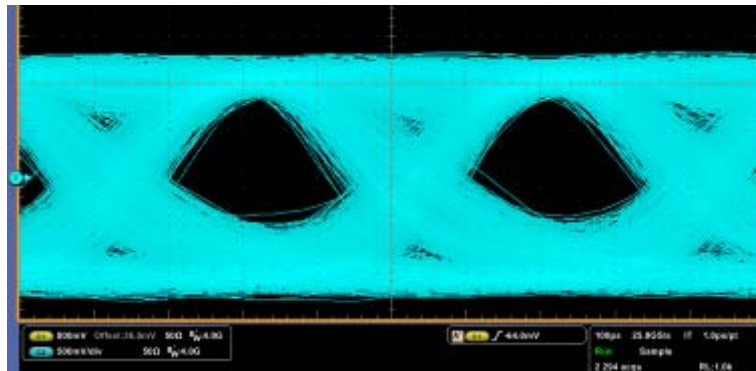

Received optical waveform 2.5 Gbps
780nm Laser Diode

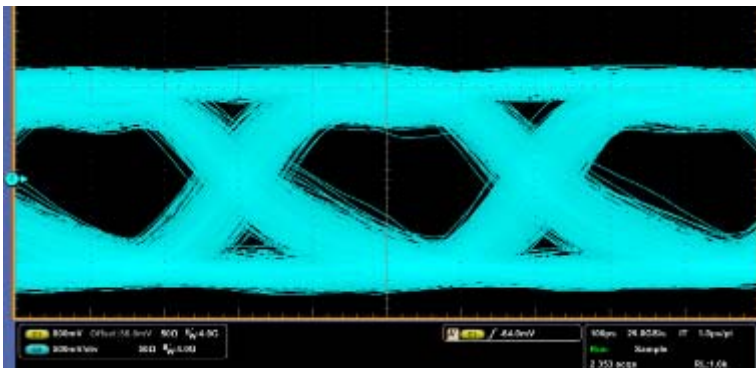

**Error free for
10cm
transmission
experiment**

Example of High-speed Image Sensor

2400 fps Image Sensor is used to receive 1200bps Optical Signal

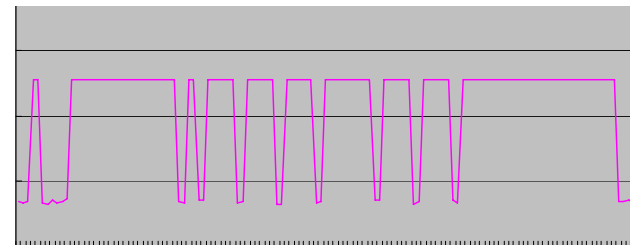
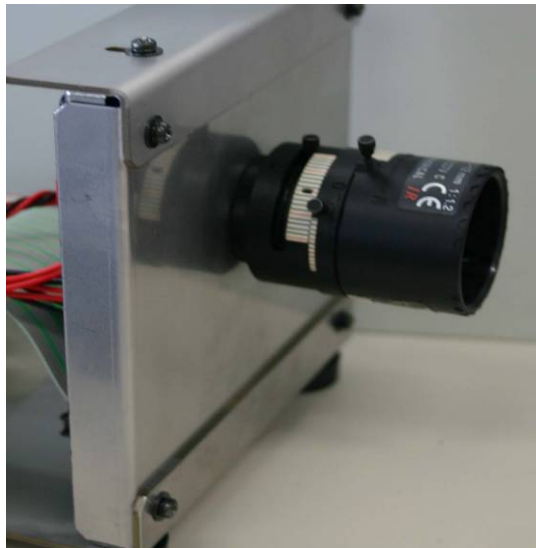

LED Light house: (70% of Japanese Light house)

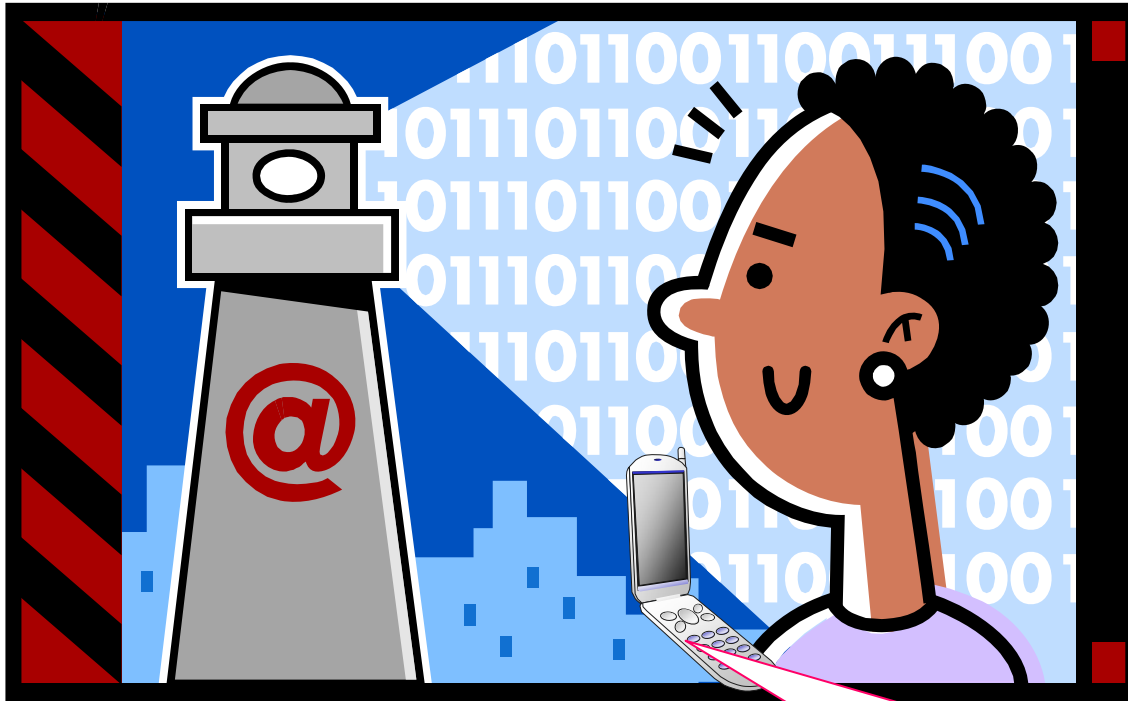

Weather forecast
Tidal wave
Sea condition

500m Transmission Experiment

Image Sensor

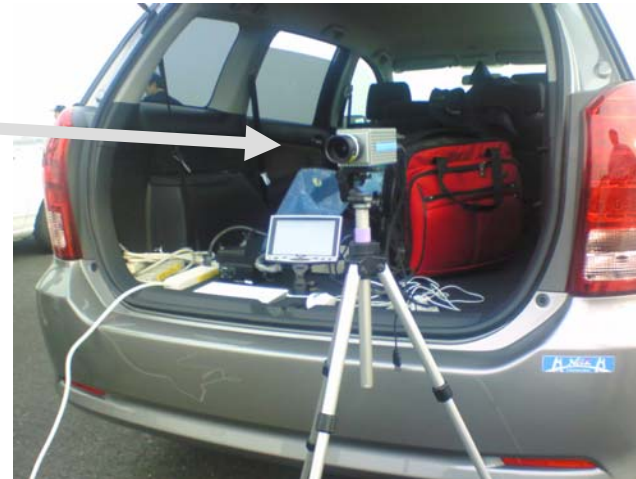

Received Optical Signal Waveform

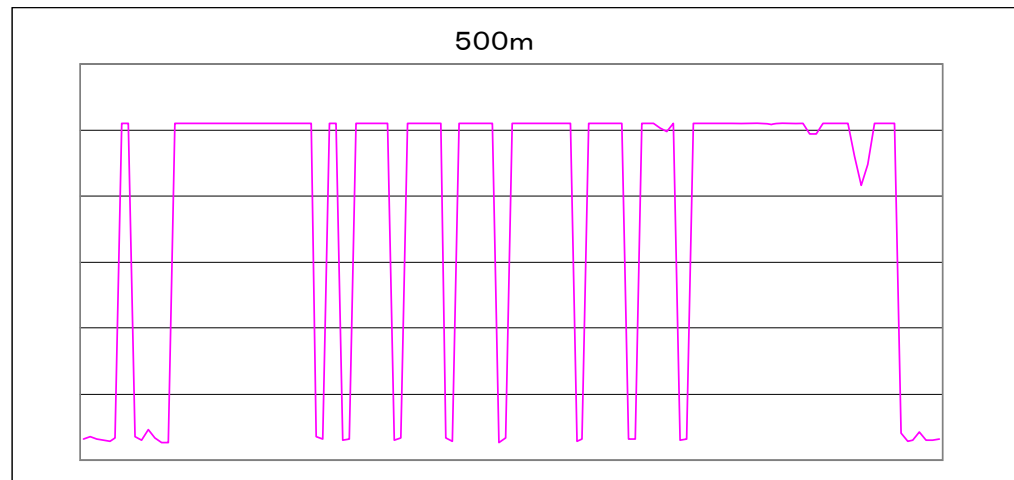

Is there any solution to take advantage of Image sensors and photo diodes ?

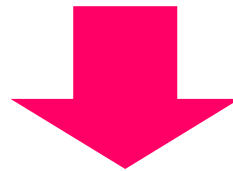

Possible Solution: Hybrid of Image sensors and Photo diode array

Hybrid of Image sensors and Photo diode array

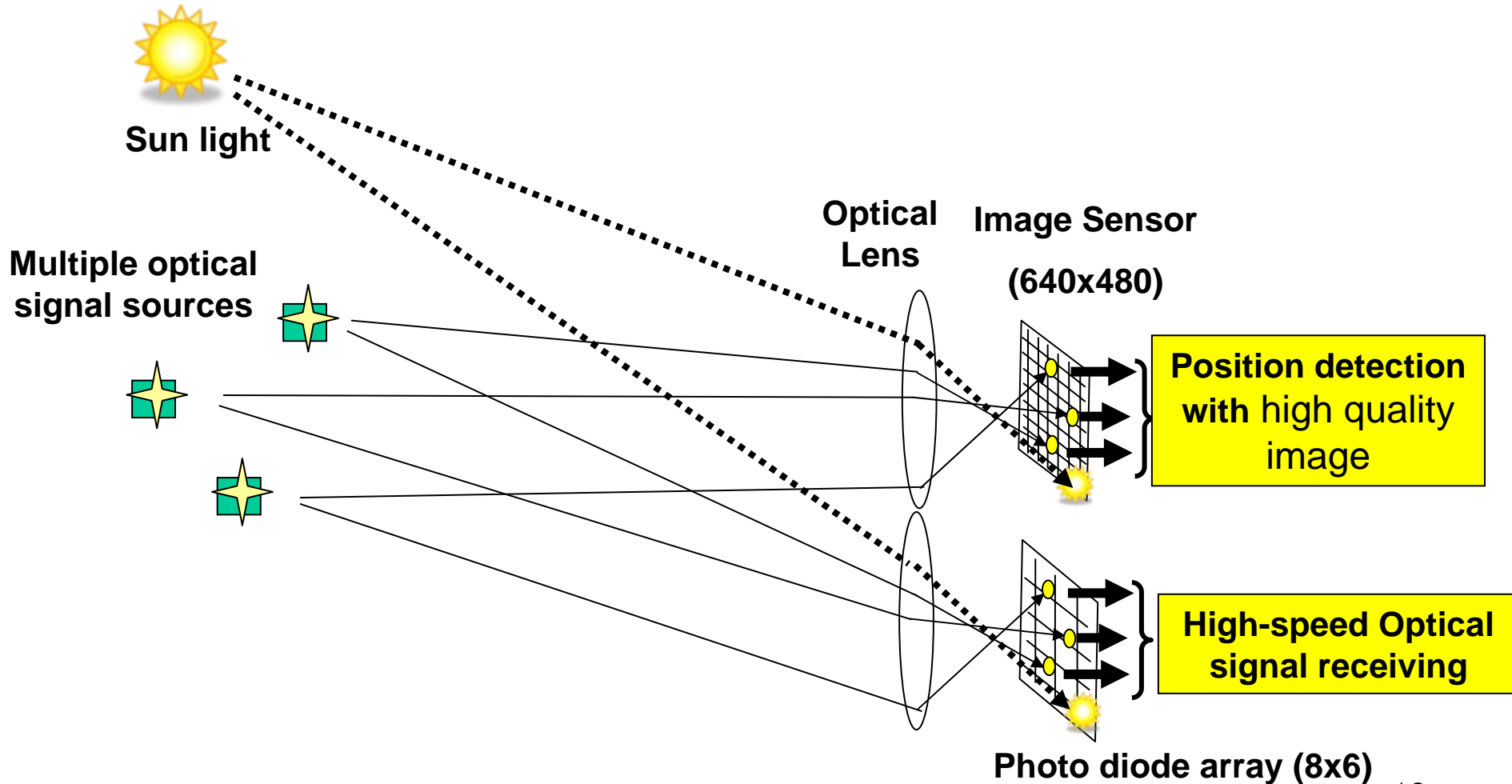

Possible structure of Hybrid sensors

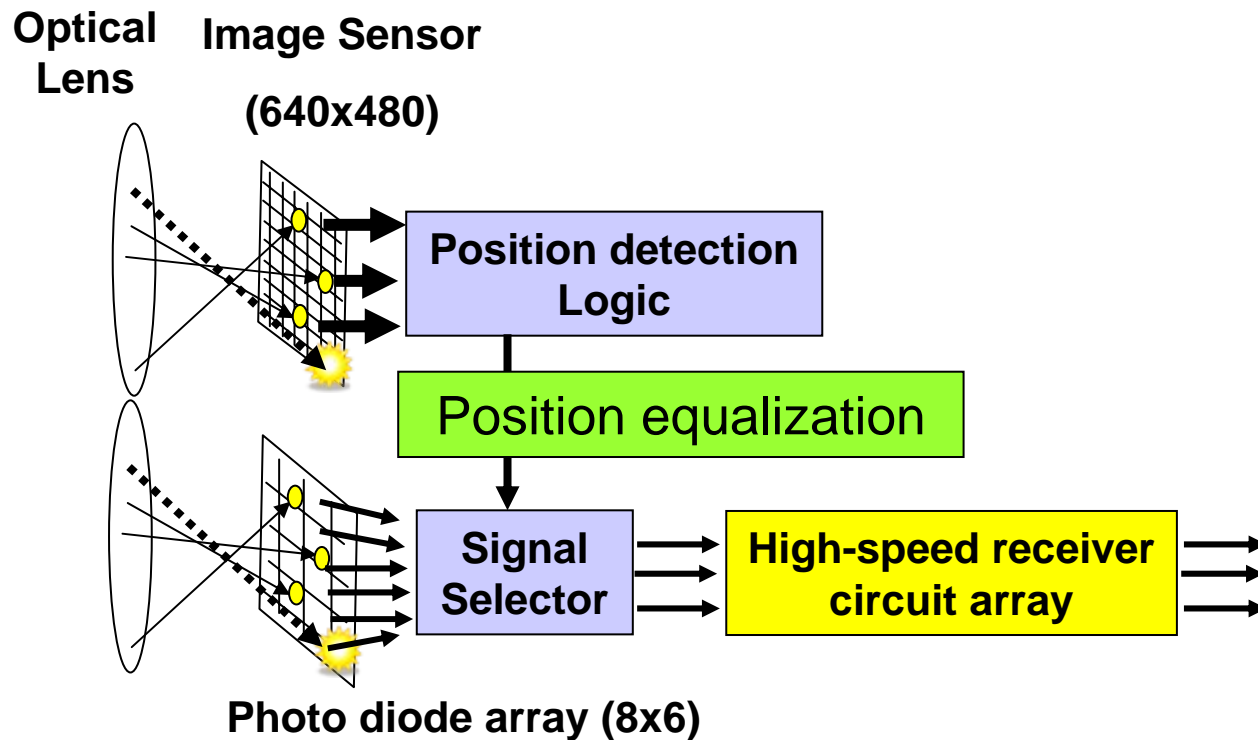



Q&A