

---

## **Project: IEEE P802.15 Working Group for Wireless Personal Area Networks (WPANs)**

**Submission Title:** [Enhancement to 802.15.4-2006 for hybrid contention access and scheduled access]

**Date Submitted:** [06 September, 2008]

**Source:** [Peng Zeng / Qin Wang], Company [Shenyang Institute of Automation-Chinese Academy of Sciences / University of Science & Technology Beijing]

**Address** [ / 30 Xueyuan Road, Beijing 100083, China]

**Phone:** [+8610-62334781], **FAX:** [+8610-82372028 ], **E-Mail:** [ wangqin@ies.ustb.edu.cn]

**Re:** [IEEE P802.15.4e Call For proposal]

**Abstract:** [This document proposes an enhancement to IEEE 802.15.4-2006 MAC Layer for the Reliability and Deterministic Aware Applications, which needs hybrid contention access and scheduled access]

**Purpose:** [This document is a response to Item a) better support the industrial markets in IEEE P802.15.SG4e Call for Application on 14 November, 2007]

**Notice:** This document has been prepared to assist the IEEE P802.15. It is offered as a basis for discussion and is not binding on the contributing individual(s) or organization(s). The material in this document is subject to change in form and content after further study. The contributor(s) reserve(s) the right to add, amend or withdraw material contained herein.

**Release:** The contributor acknowledges and accepts that this contribution becomes the property of IEEE and may be made publicly available by P802.15.

---

# Enhancement to 802.15.4-2006 for hybrid contention access and scheduled access

Peng Zeng<sup>1)</sup>, Qin Wang<sup>2)</sup>

1) Shenyang Institute of Automation-Chinese Academy of Sciences

2) University of Science & Technology Beijing

06 September 2008

[wangqin@ies.ustb.edu.cn](mailto:wangqin@ies.ustb.edu.cn)

## ***Application Requirements and Constraints***



- Large scale
- High Reliability requirement
- Fast communication for emergency information and very low duty cycle communication for regular information.

---

## ***Application Requirements and Constraints***

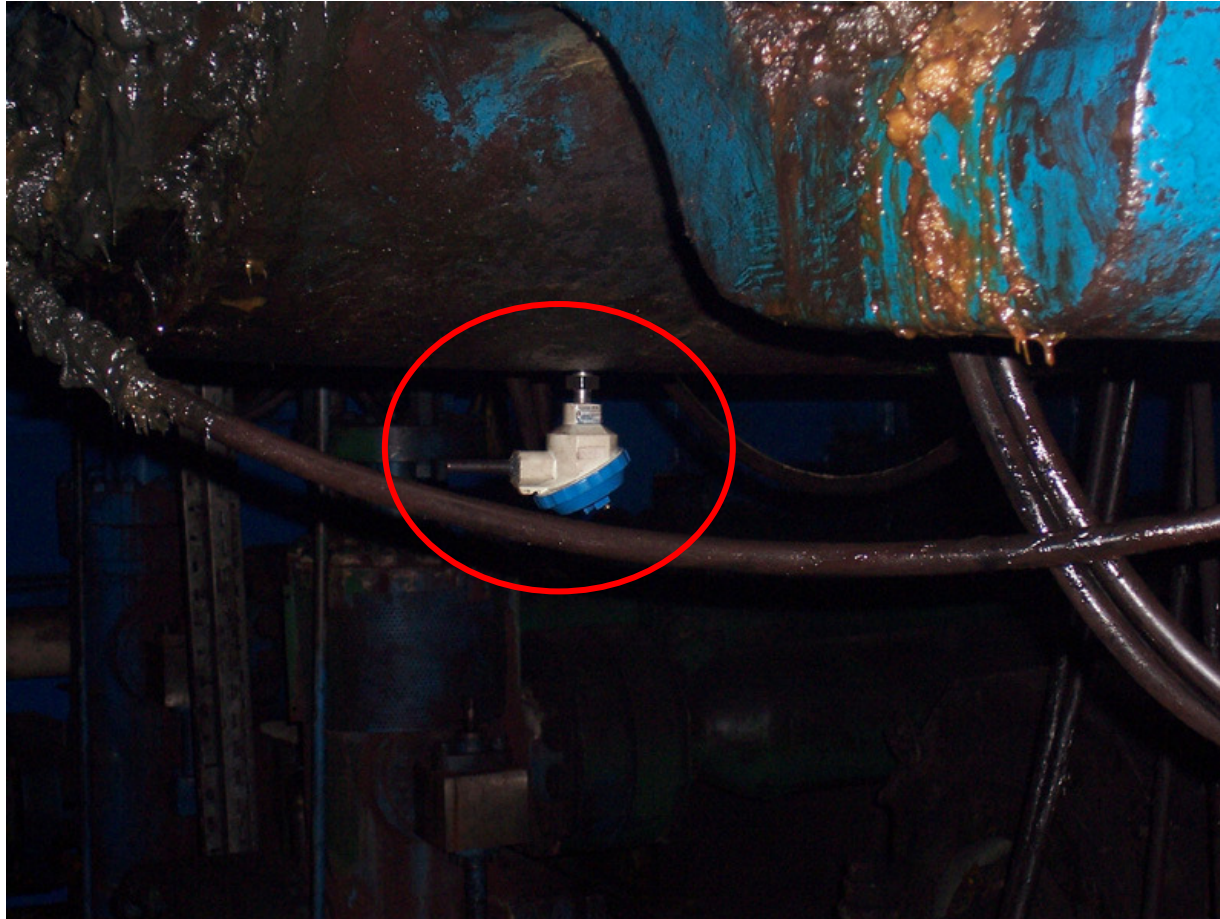

## *Application Requirements and Constraints (cont.)*

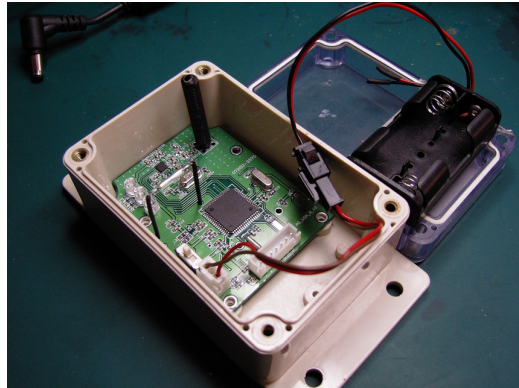

- Placement constraints
- Lifetime constraints

---

## ***Objective***

1. Increase reliability
2. Increase deterministic degree of end-to-end communication
3. Balance the fast communication for emergency information and the very low duty cycle communication for regular information
4. Compatible with IEEE 802.15.4-2006 device

## ***Components.***

1. Mesh+Star topology
2. Extended superframe
3. CSMA/TDMA+FDMA during CAP+CFP period
4. TDMA+FH/AFD during scheduled period, i.e. inactive period of 15.4-2006
5. Two-stage resource allocation

# Network topology

-- Mesh + Star

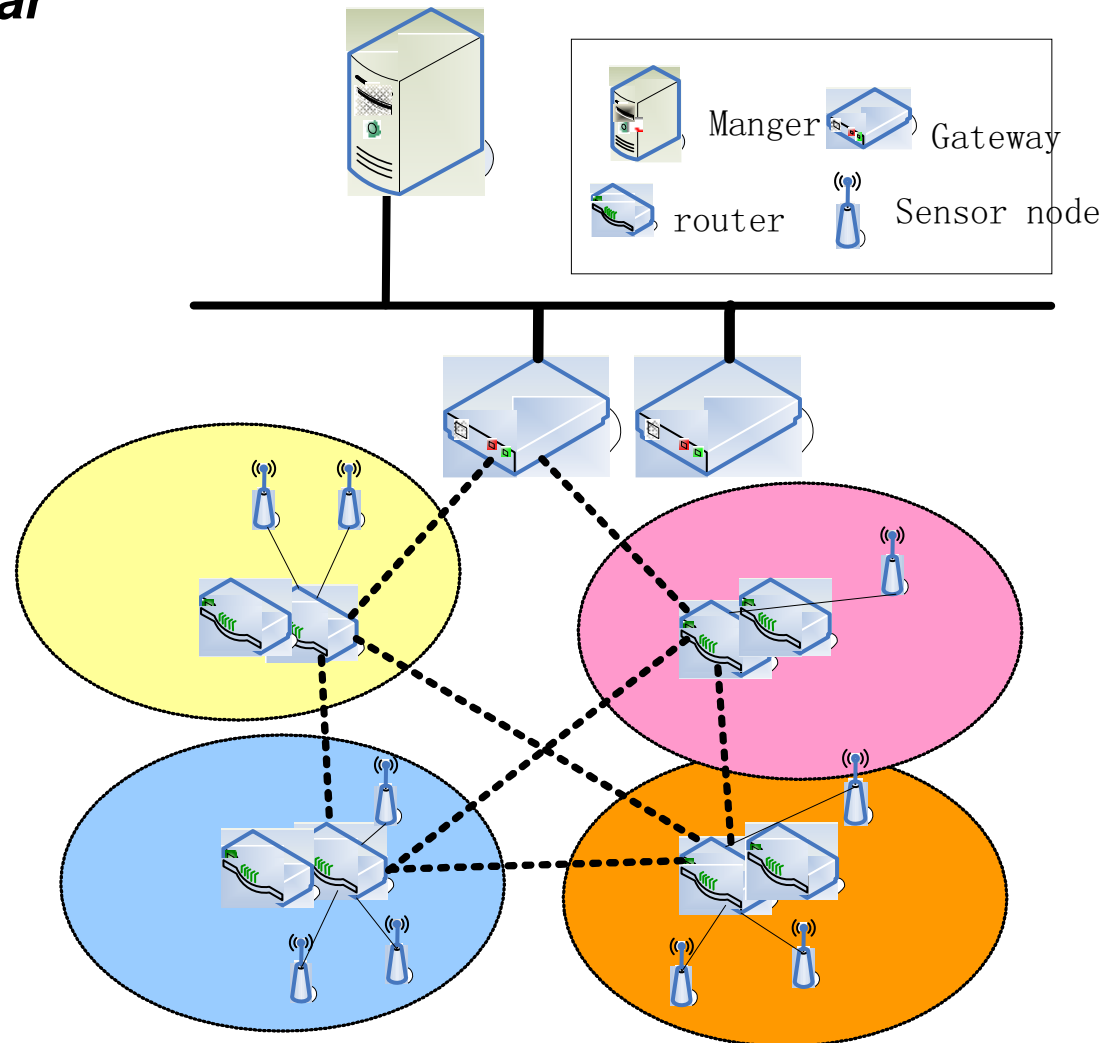

# E-Superframe

## IEEE802.15.4 Superframe

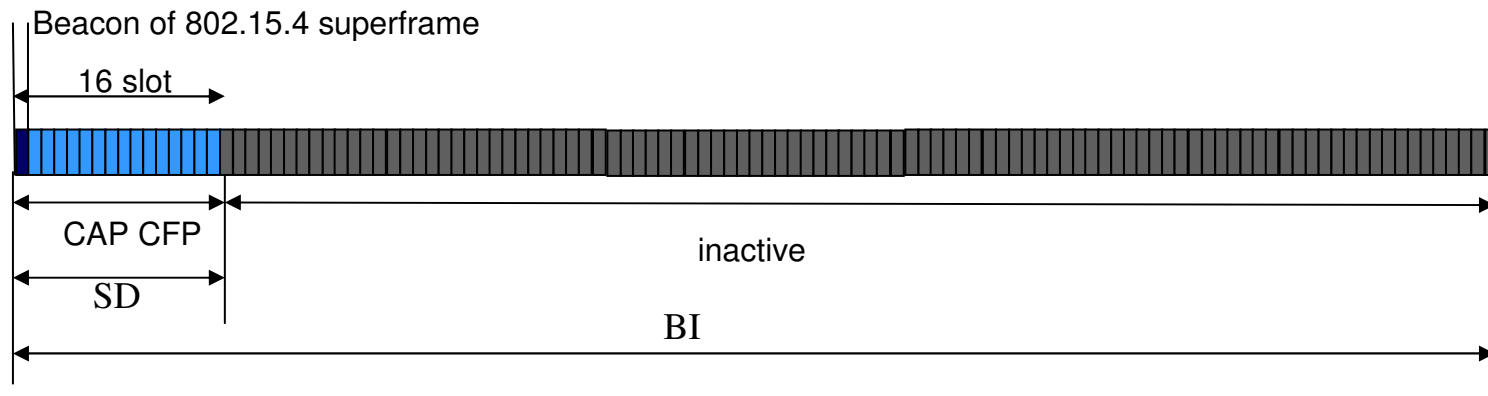

## E-Superframe

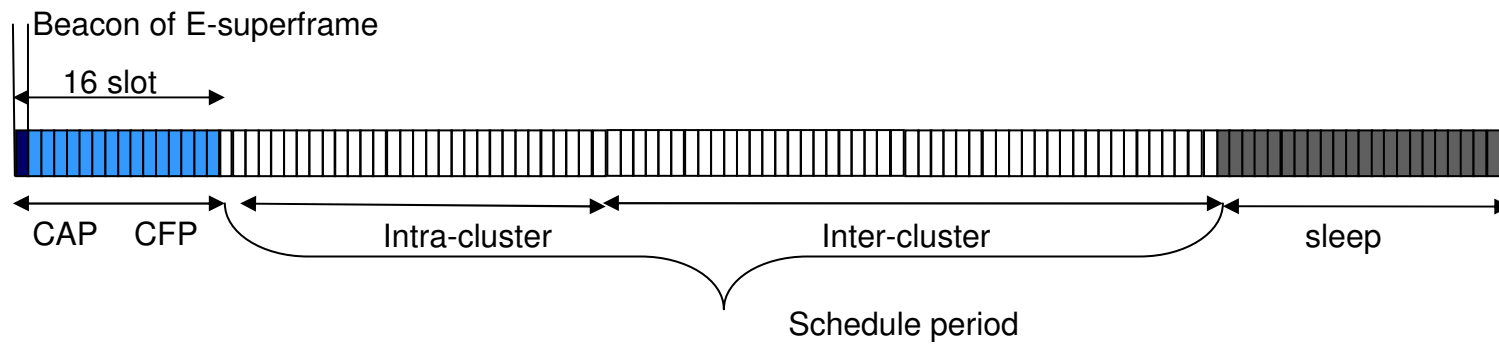



---

## *E-Superframe(cont)*

- CAP is used for device joining, intra-cluster management and retry.
- CFP is used for emergency data and communication between router and intra-cluster mobile devices.
- Intra-cluster is used by intra-cluster fixed devices.
- Inter-cluster is used for communication between routers or router and gateway.

---

# CAP+CFP: CSMA/TDMA+FDMA

- In CAP+CFP period of one superframe cycle, all devices in a cluster use the same channel, which can be modified in another cycle by forecast of beacon.
- Neighbor routers are assigned with different working channels.
  - If there is no enough channel, CAP+CFP period of neighbor routers should be scheduled to be staggered.

# Two examples of CAP+CFP

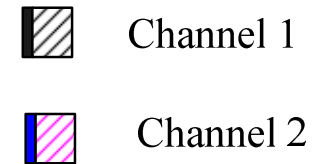

Example 1: R1: 32 slots, R2: 64 slots, R3: 128 slots

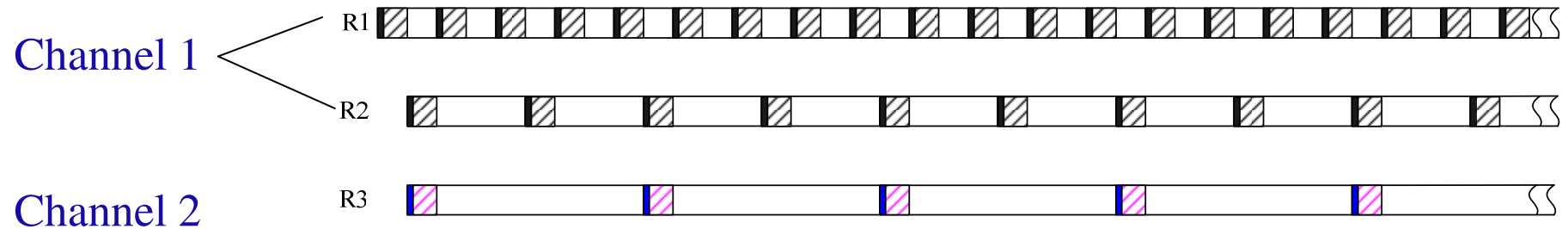

Example 2: R1: 64 slots, R2: 128 slots, R3: 256 slots

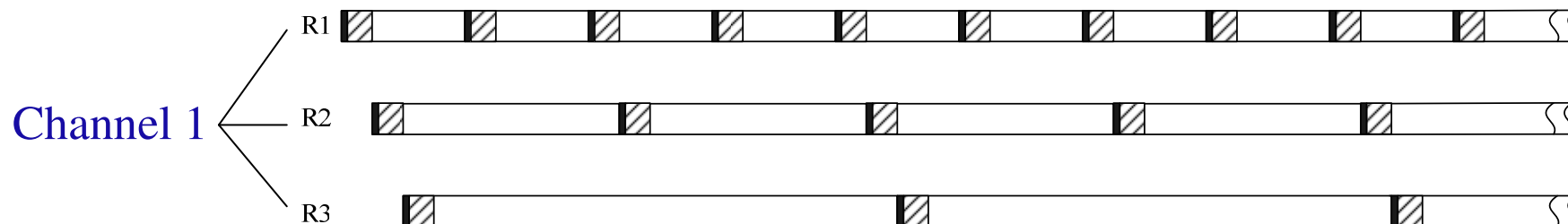

---

# Intra-cluster and Inter-cluster

- Intra-cluster: TDMA + Adaptive Frequency Diversity (AFD)
  - AFD: Change communication channel according to the real channel condition. In another word, bad channel condition, which can be measured with packet drop rate or resend time, triggers the operation of changing channel.
- Inter-cluster :TDMA+FH
  - FH: Change communication channel according to a scheduled frequency hopping pattern, regardless how the real channel condition is.

## *Two-stage Management: timeslot, channel vs. link*

- *Inter-cluster period is scheduled by network manager*
- *CFP and Intra-cluster is scheduled by router.*

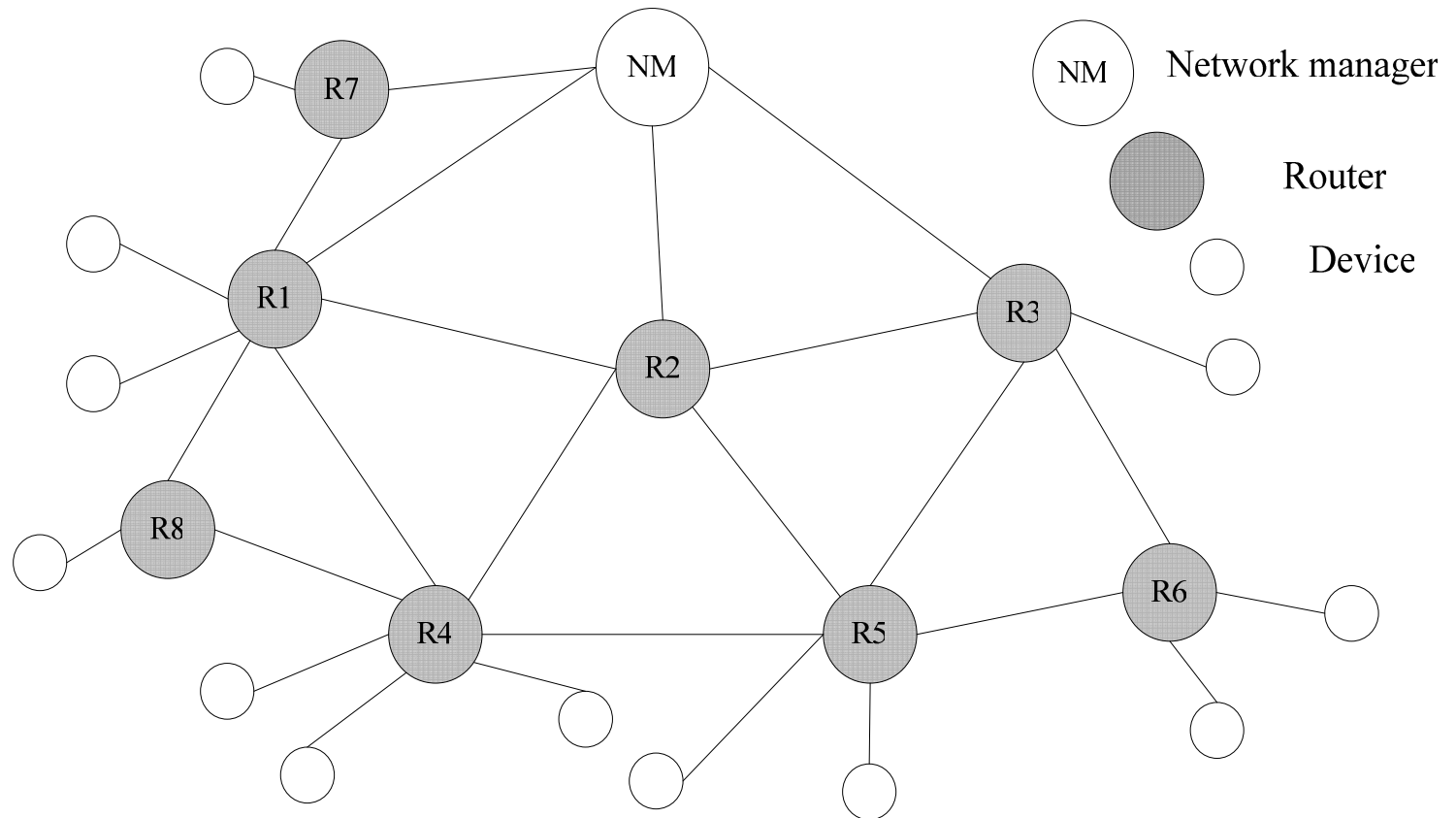

## **Distributed Resource Allocation**

# Two-stage Management: *timeslot, channel vs. link*

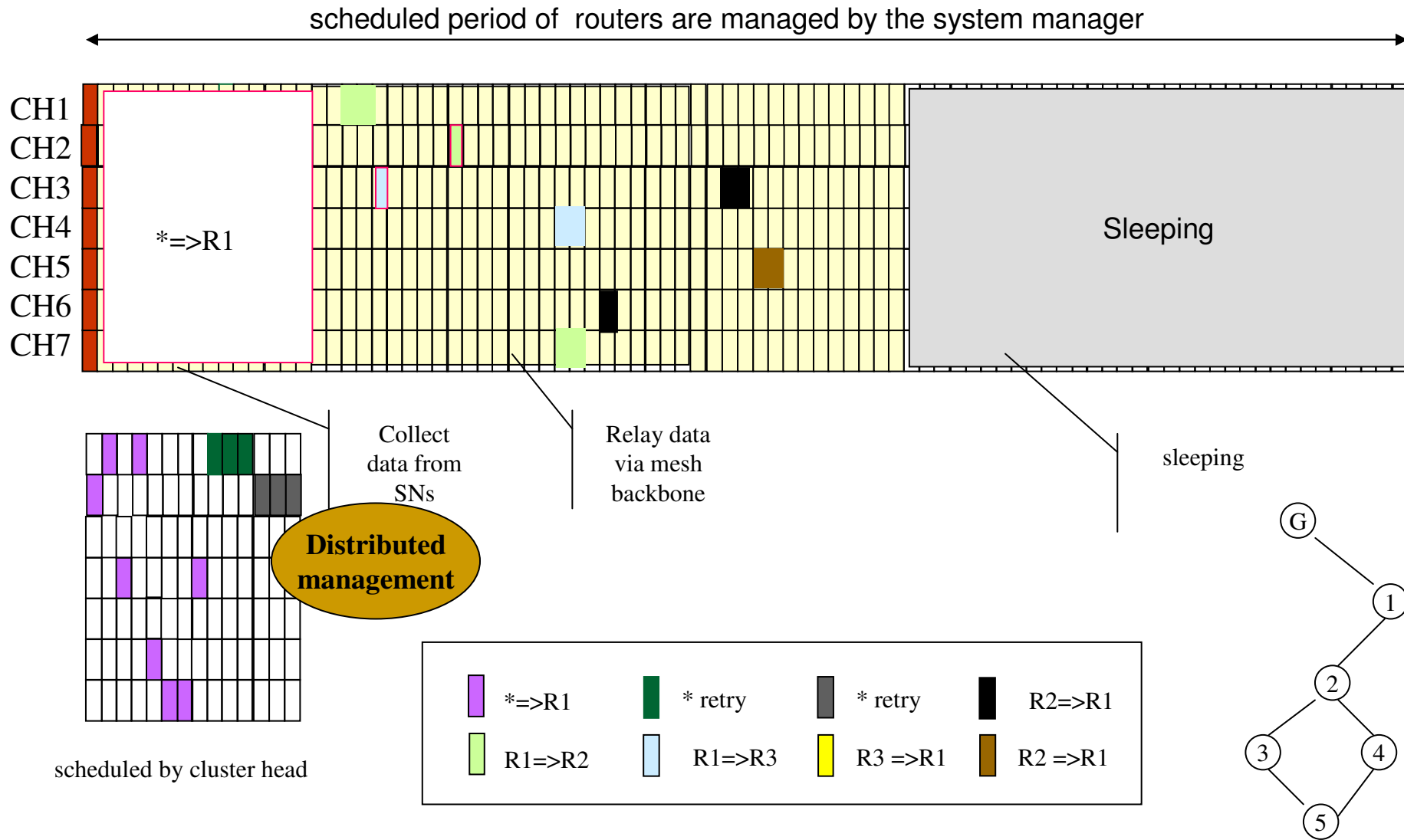

# An example of Device Joining and Resource Allocation

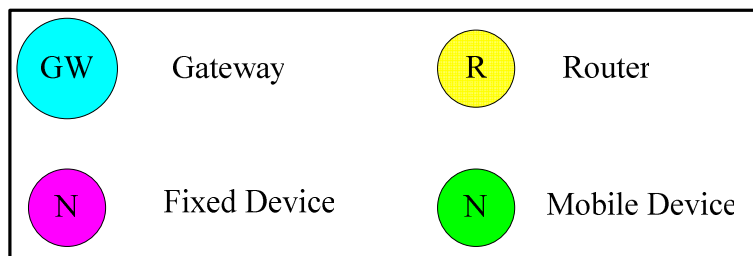
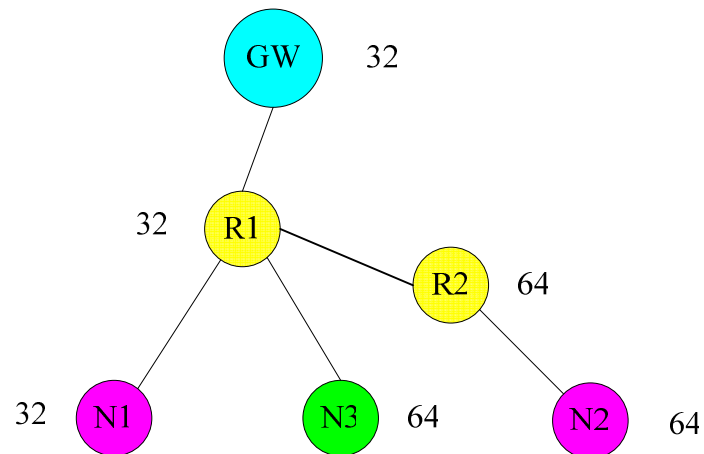

## Join Sequence:

- GW ->R1->N1->R2->N2->N3

## Data communication path:

- N1->R1->GW
- N3->R1->GW
- N2->R2->R1->GW

# Data Rate

- Router data rate =  
 $\min rate(\text{device 1}, \text{device 2}, \dots, \text{device } n);$
- GW data rate is defined as the minimum data rates of network.

Device	Data Rate (slots)
N1	32
N2	64
N3	64
R1	32
R2	64
GW	32



# Default Superframe -64 slots



Period	Length (slots)
Beacon	1
CAP	7
CFP	8
Intra-cluster	16
Inter-cluster	32

# Final Superframe Length and Channel

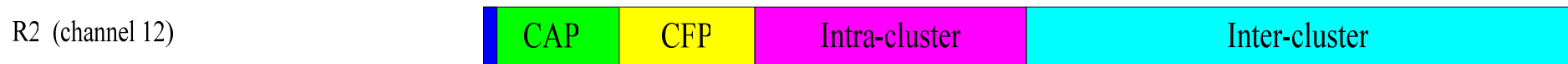

	Superframe length	Channel	Slot Offset
GW	32	11	0
R1	32	12	0
R2	64	12	16

# Final Superframe Structure

	Beacon	CAP	CFP	Intra-cluster	Inter-cluster
GW	1	7	8	8	8
R1	1	7	8	8	8
R2	1	7	8	16	32

# Joining Process of R1

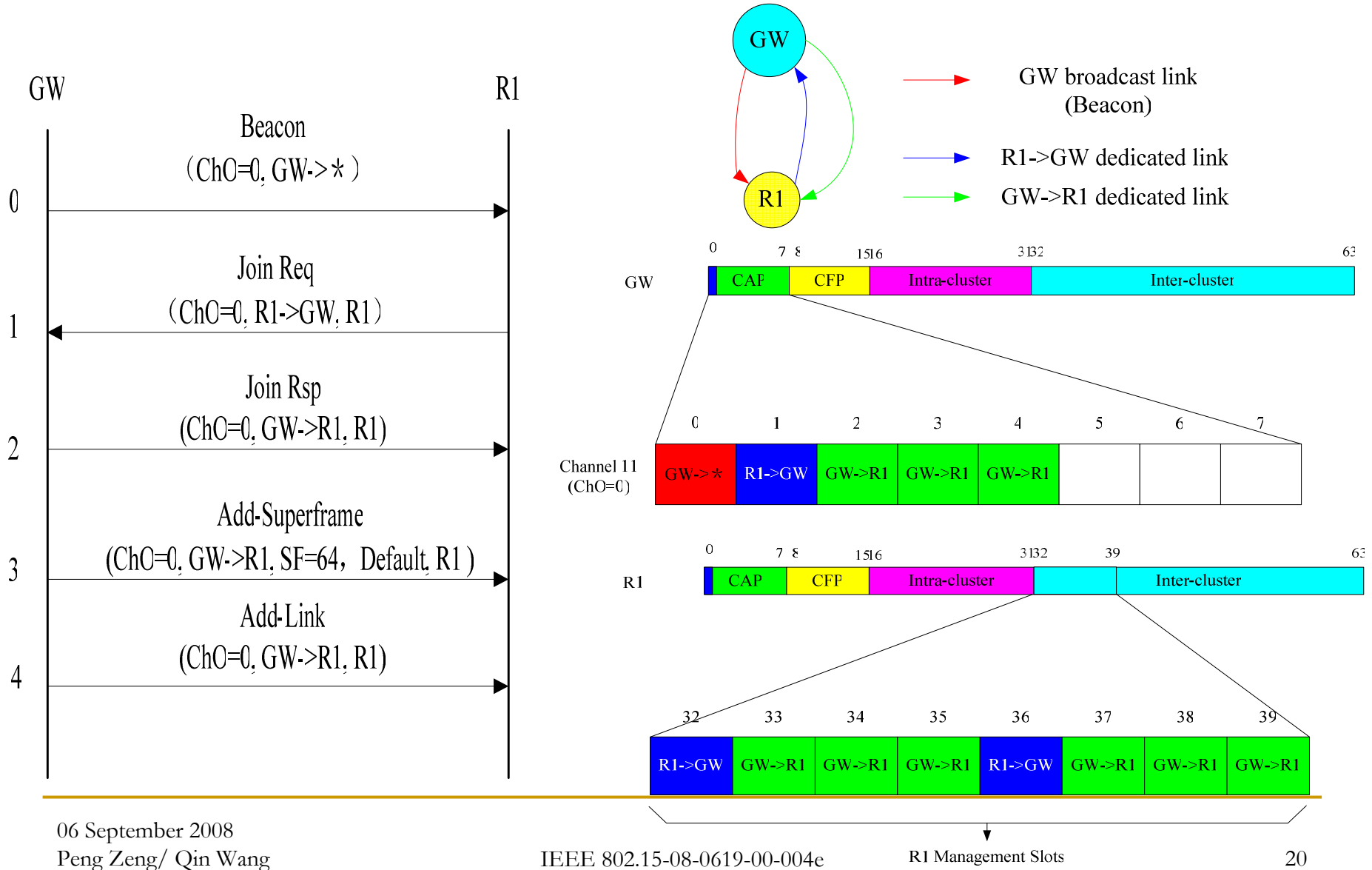

# Joining and resource allocation of N1

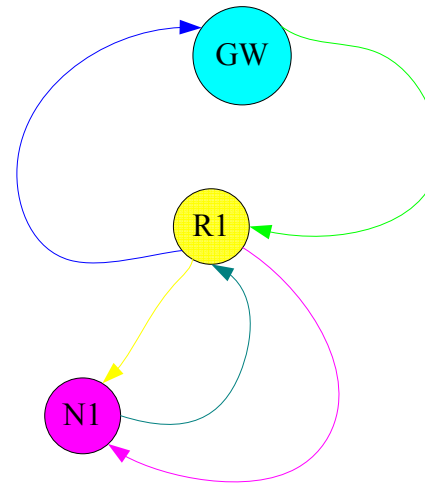
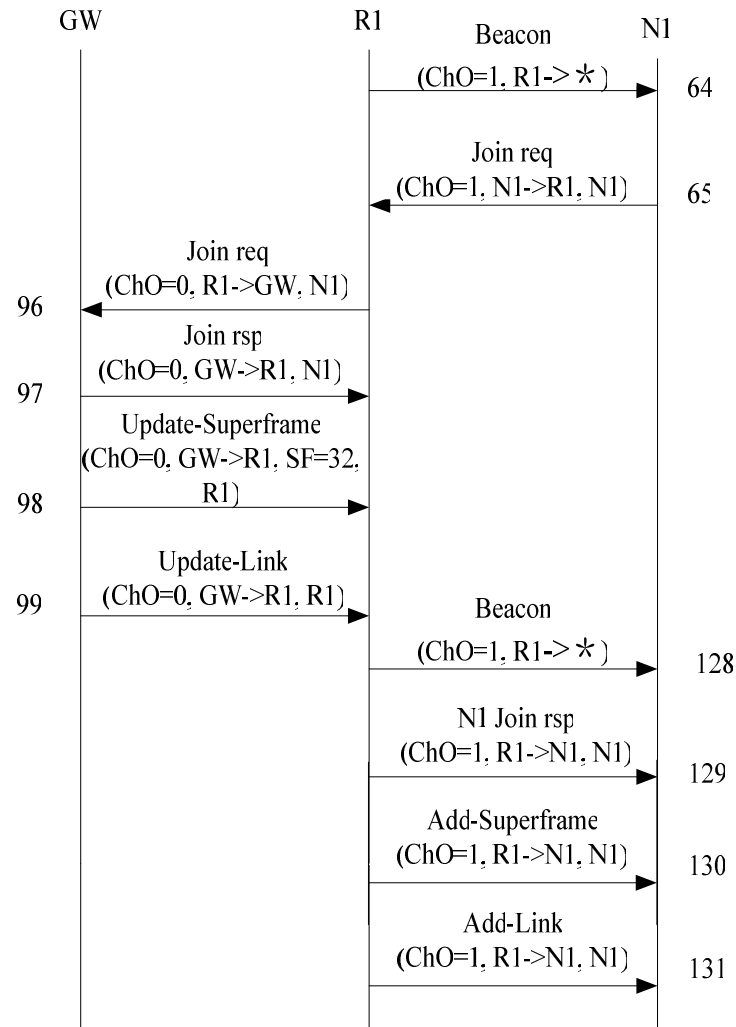

- R1->GW Dedicated Link
- GW->R1 Dedicated Link
- R1 Broadcast Link (Beacon)
- R1->N1 Dedicated Link
- N1->R1 Dedicated Link

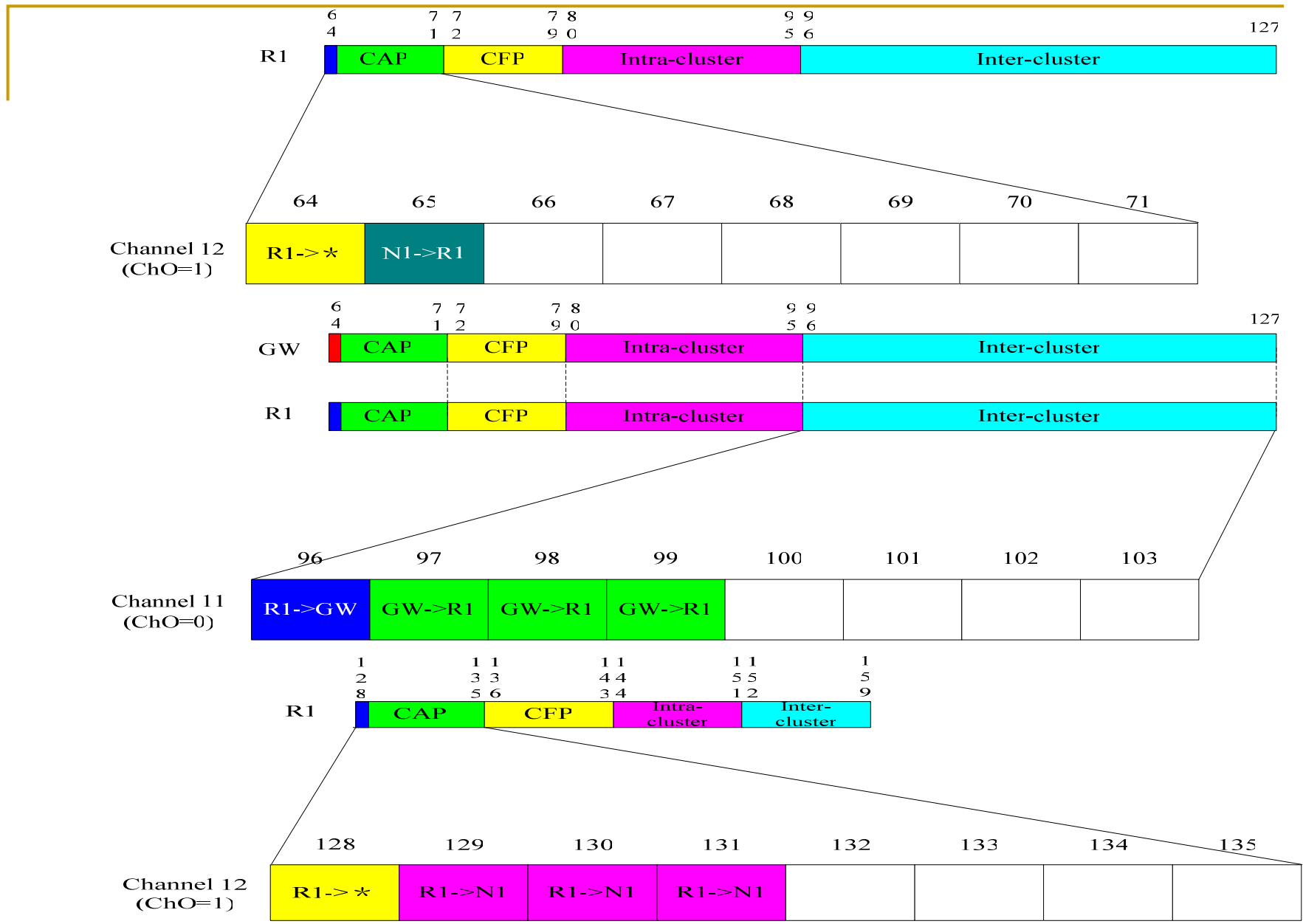

- After GW receiving N1's joining request, GW updates R1's superframe, and allocates data slots to R1.

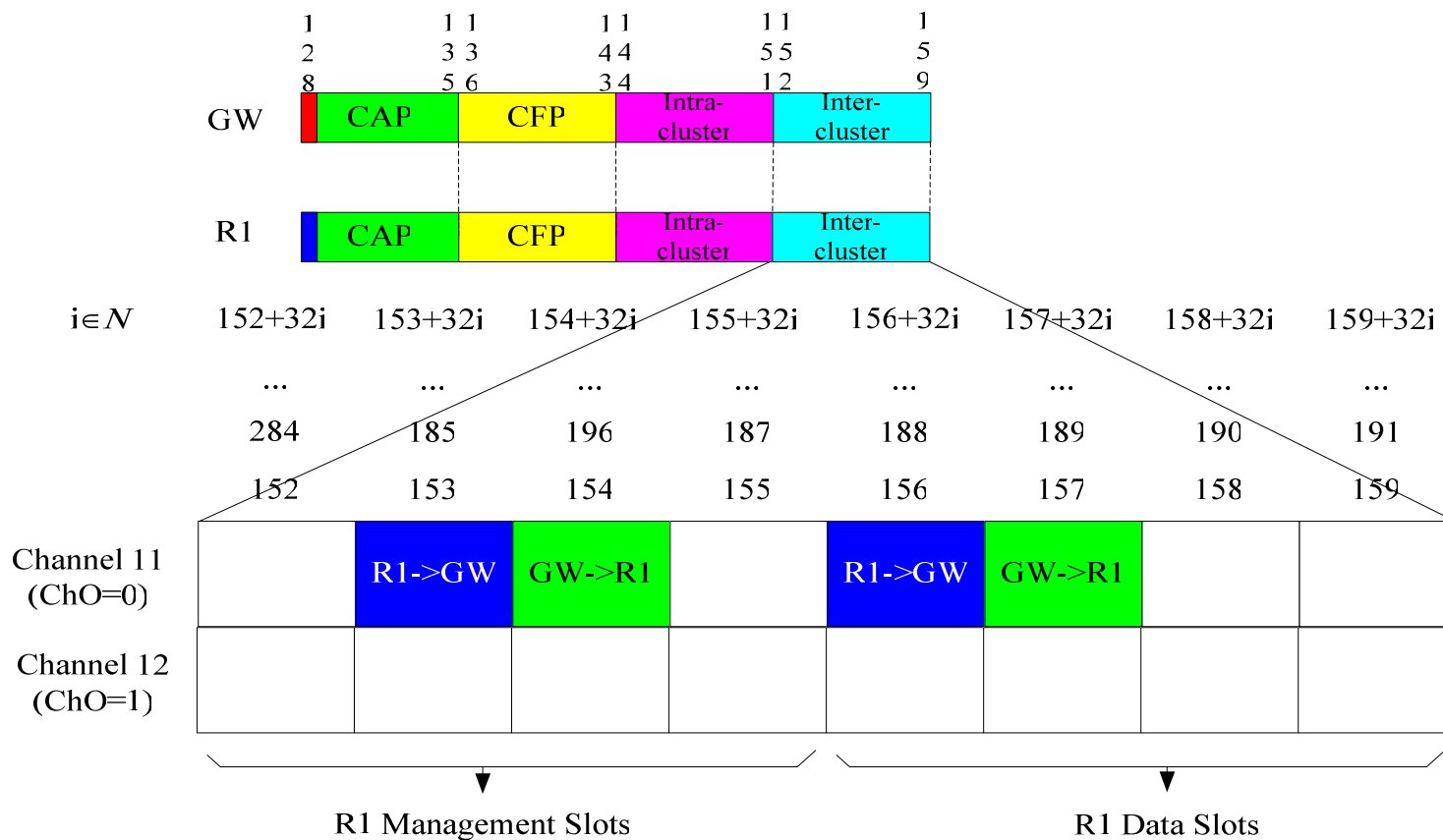

- R1 allocates resources to N1

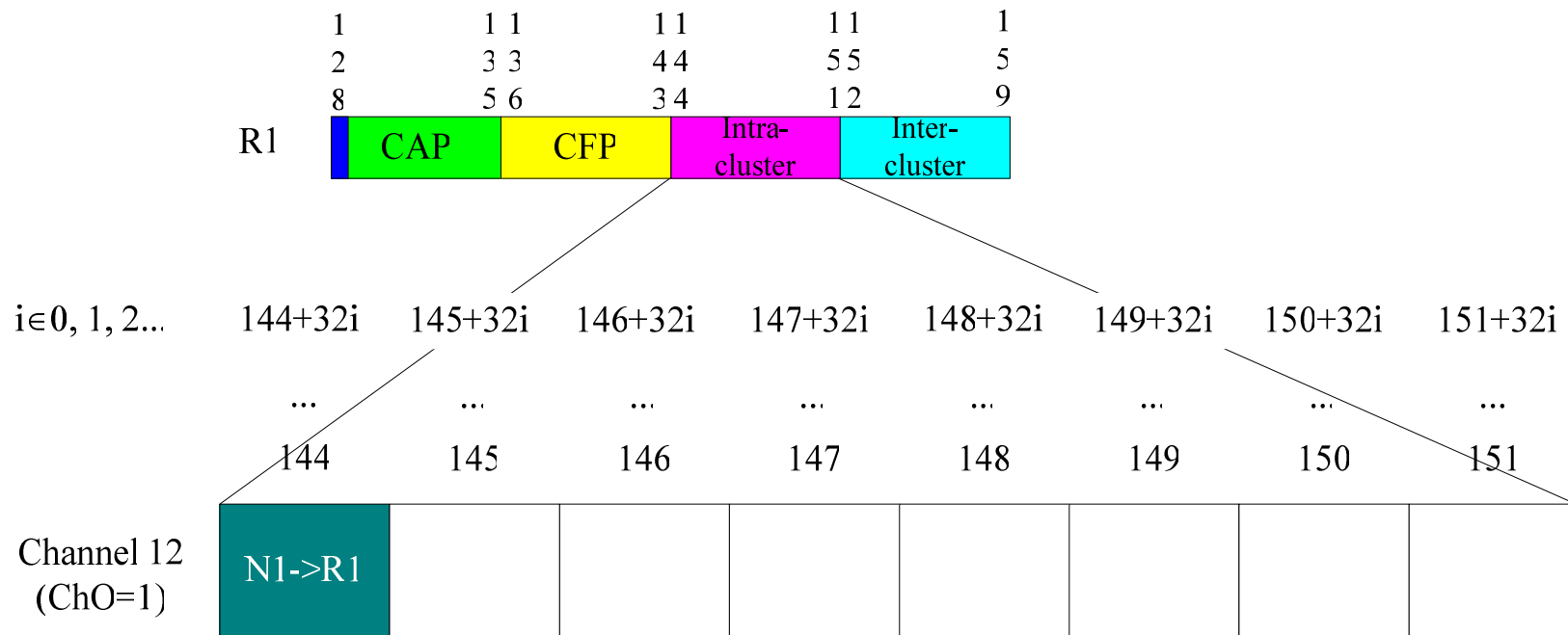



# Joining and resource allocation of R2

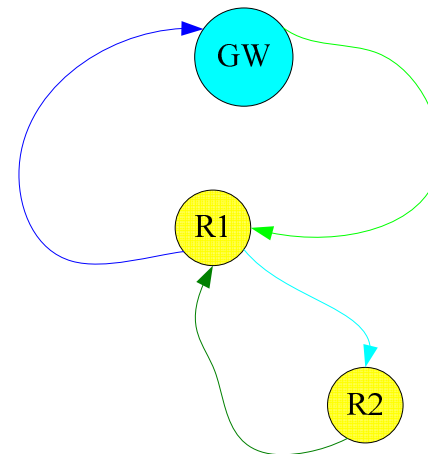
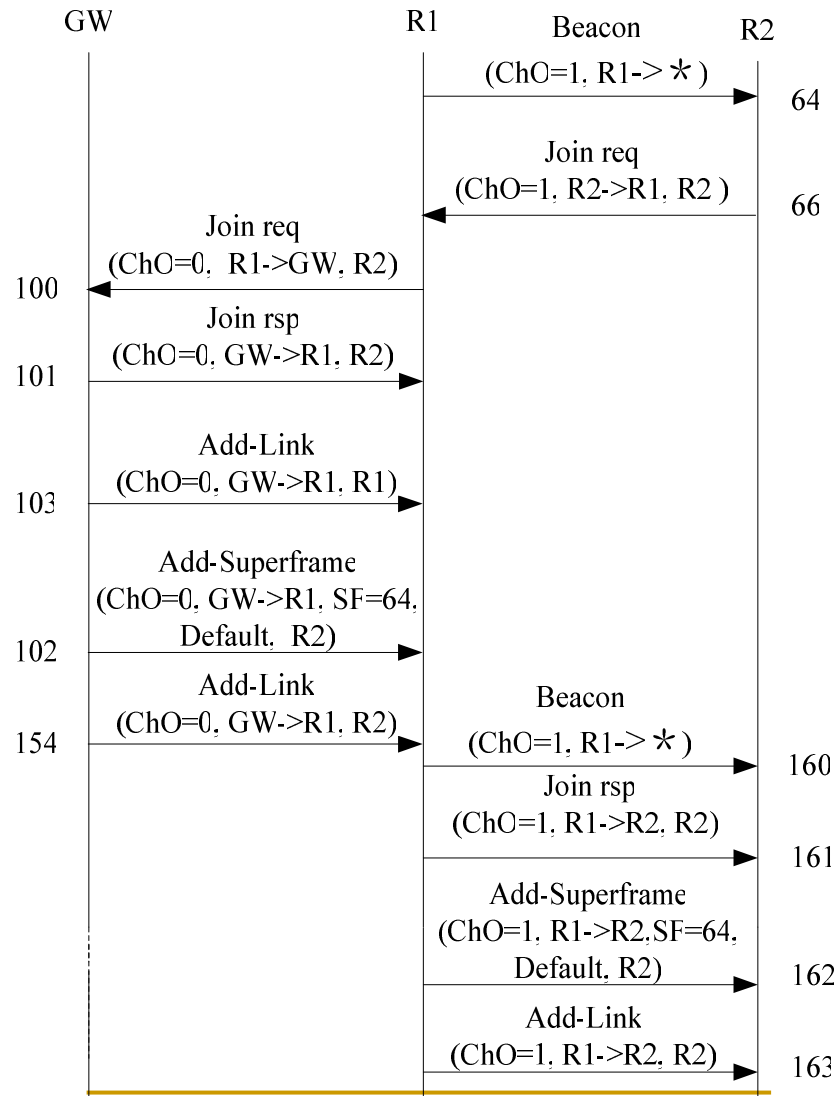

- R1->GW Dedicated Link
- GW->R1 Dedicated Link
- R1->R2 Dedicated Link
- R2->R1 Dedicated Link

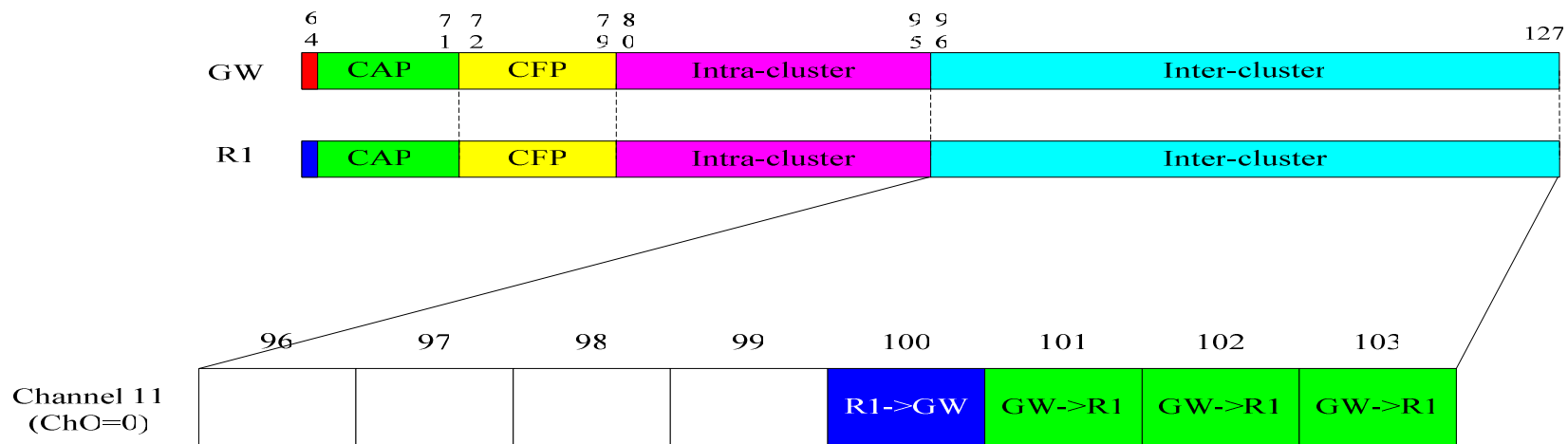
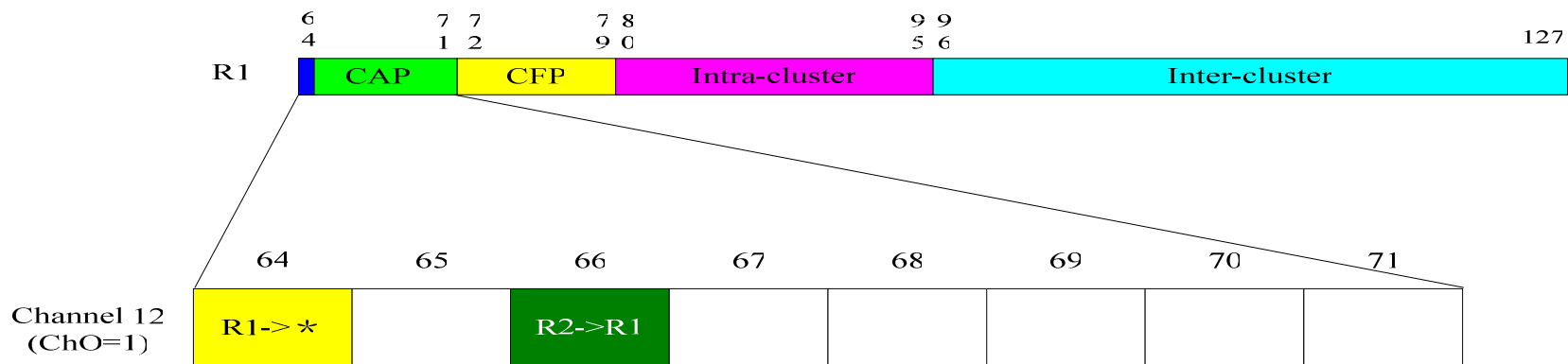

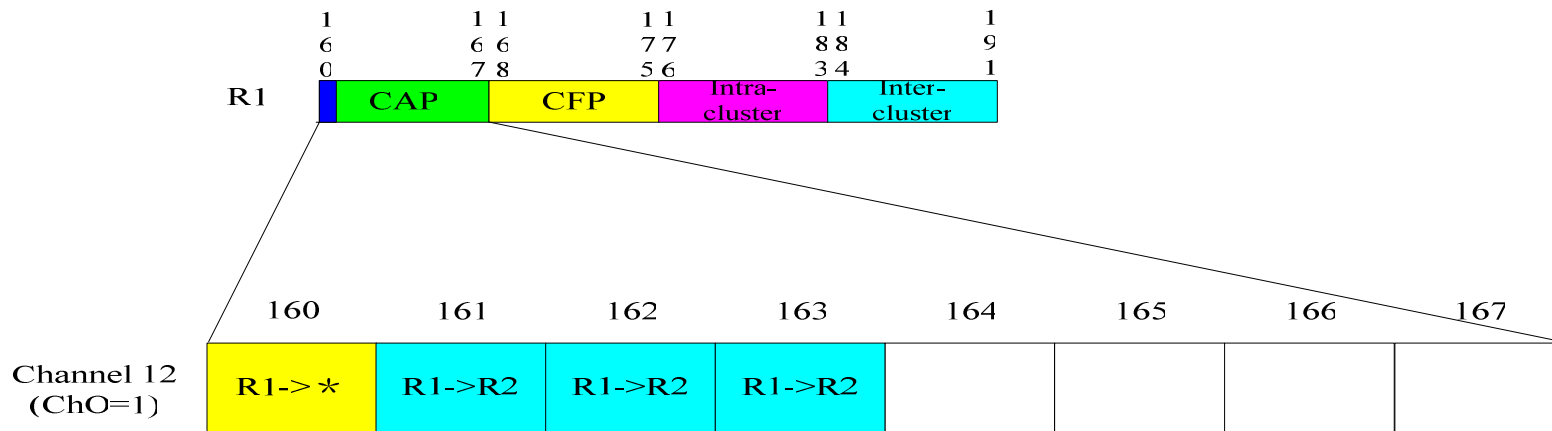
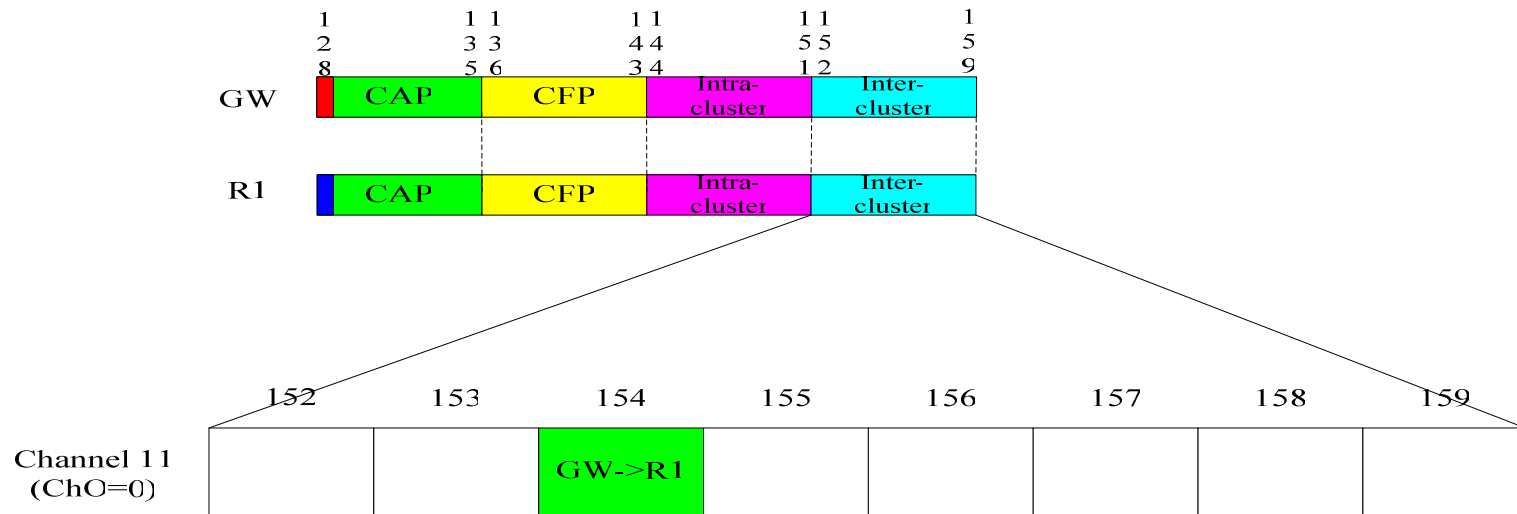

# ■ GW allocates management slots to R2

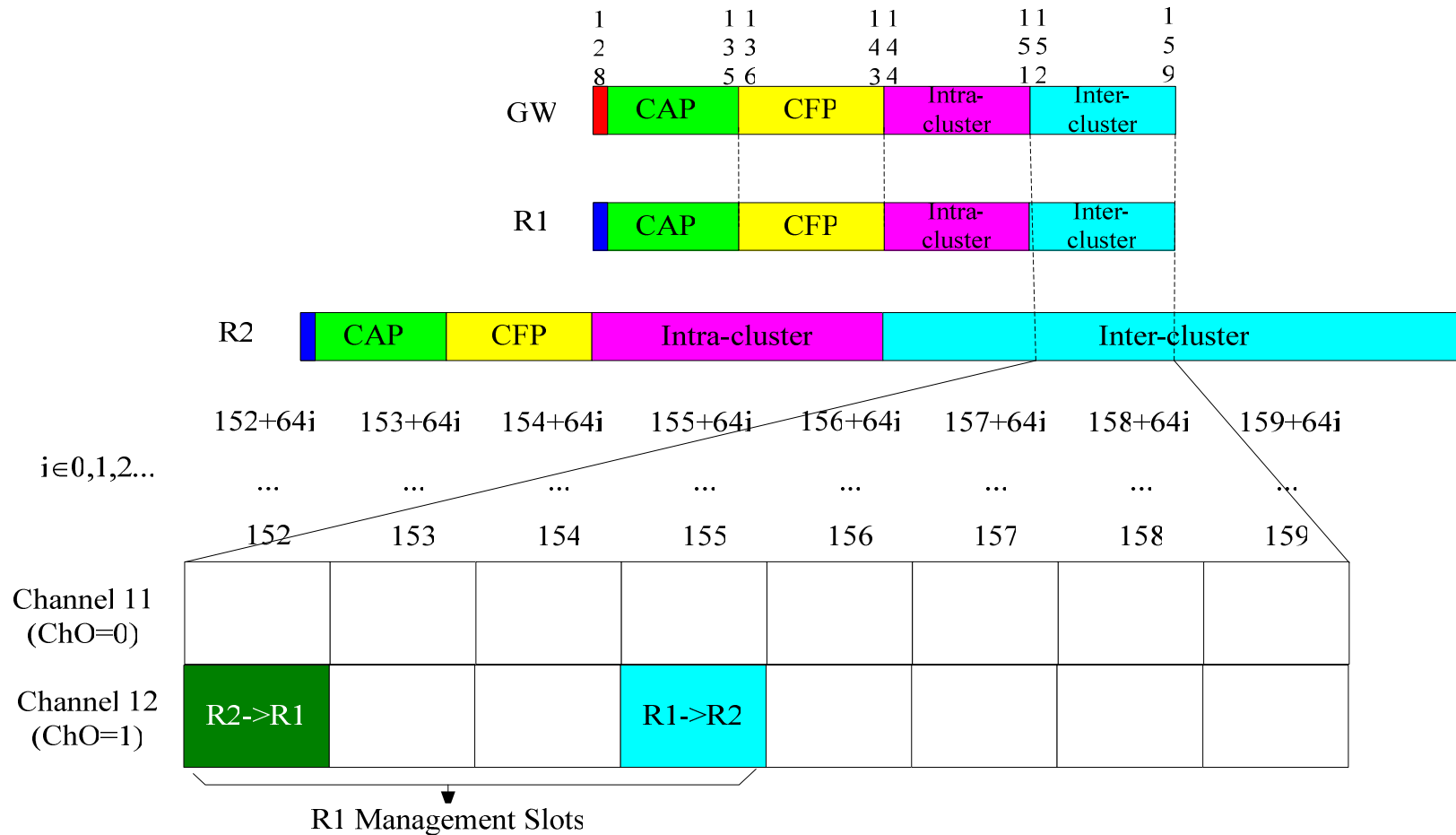

# Joining and resource allocation of N2

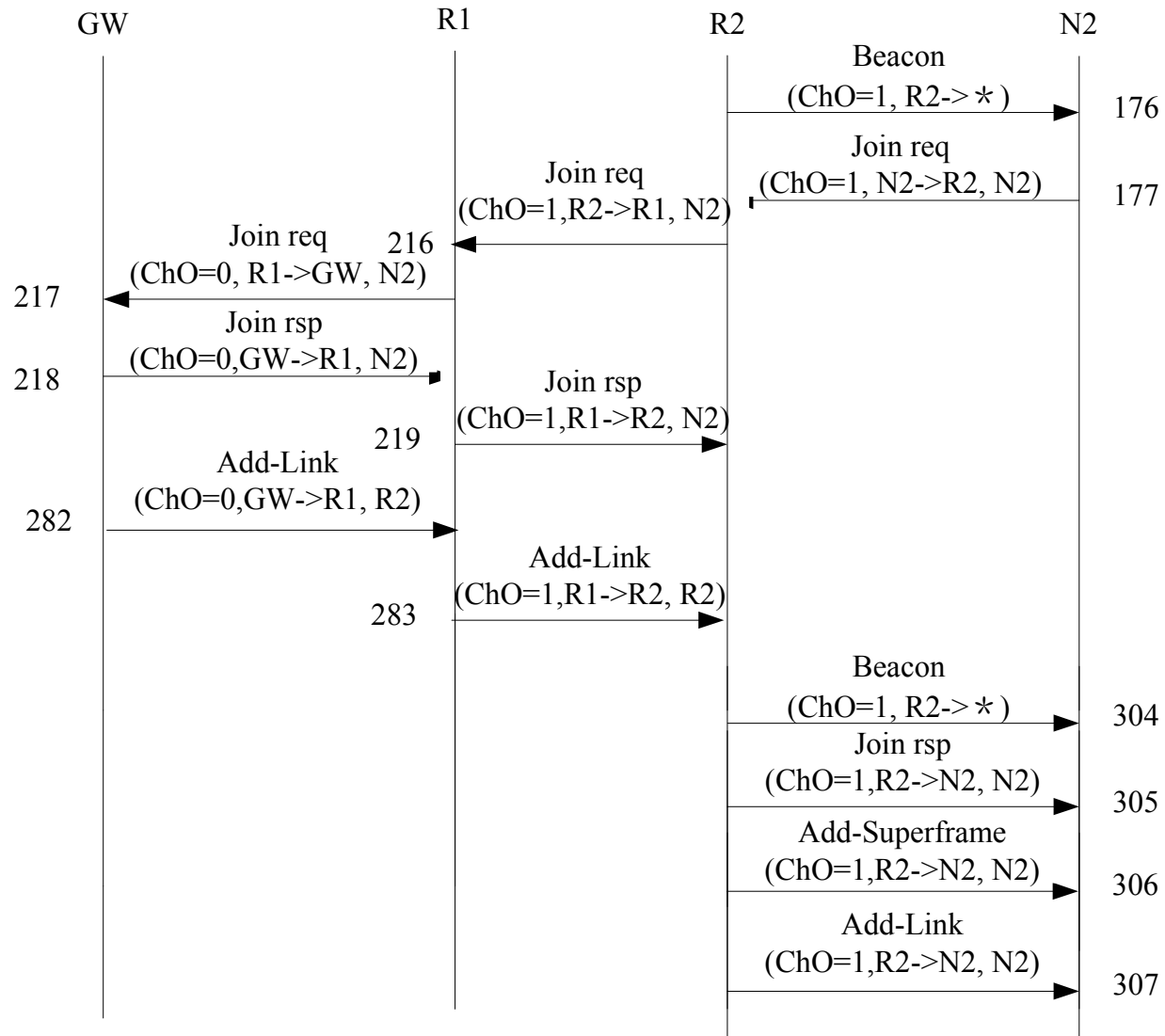

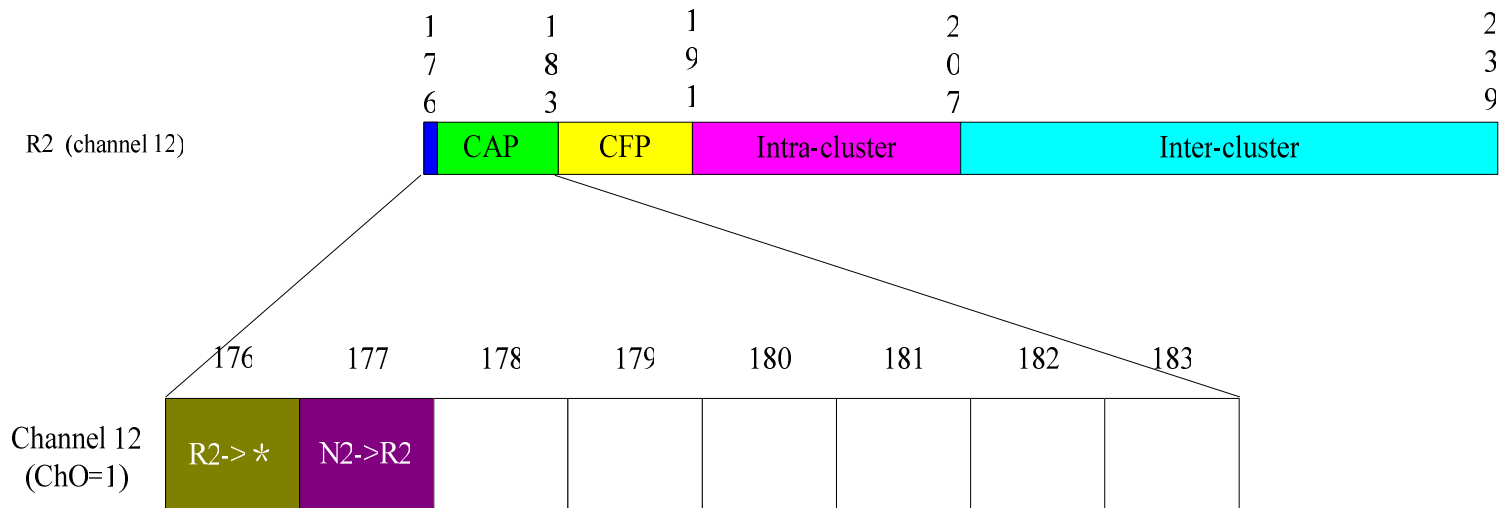
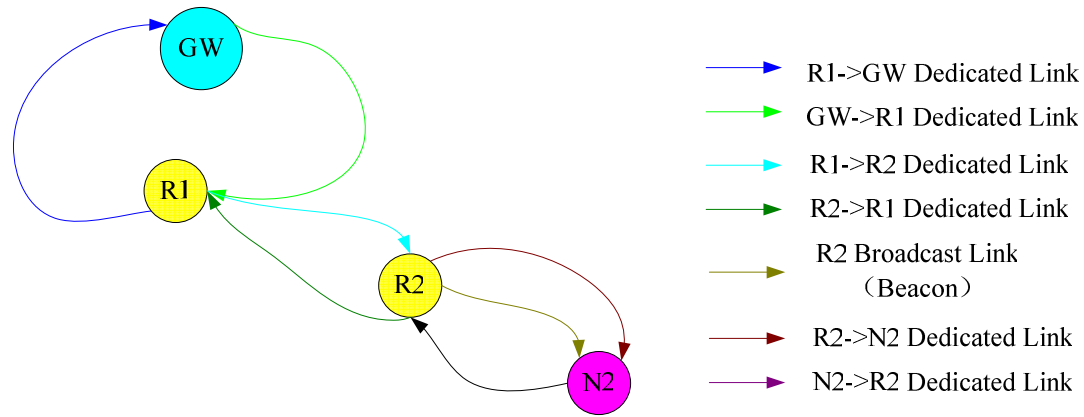

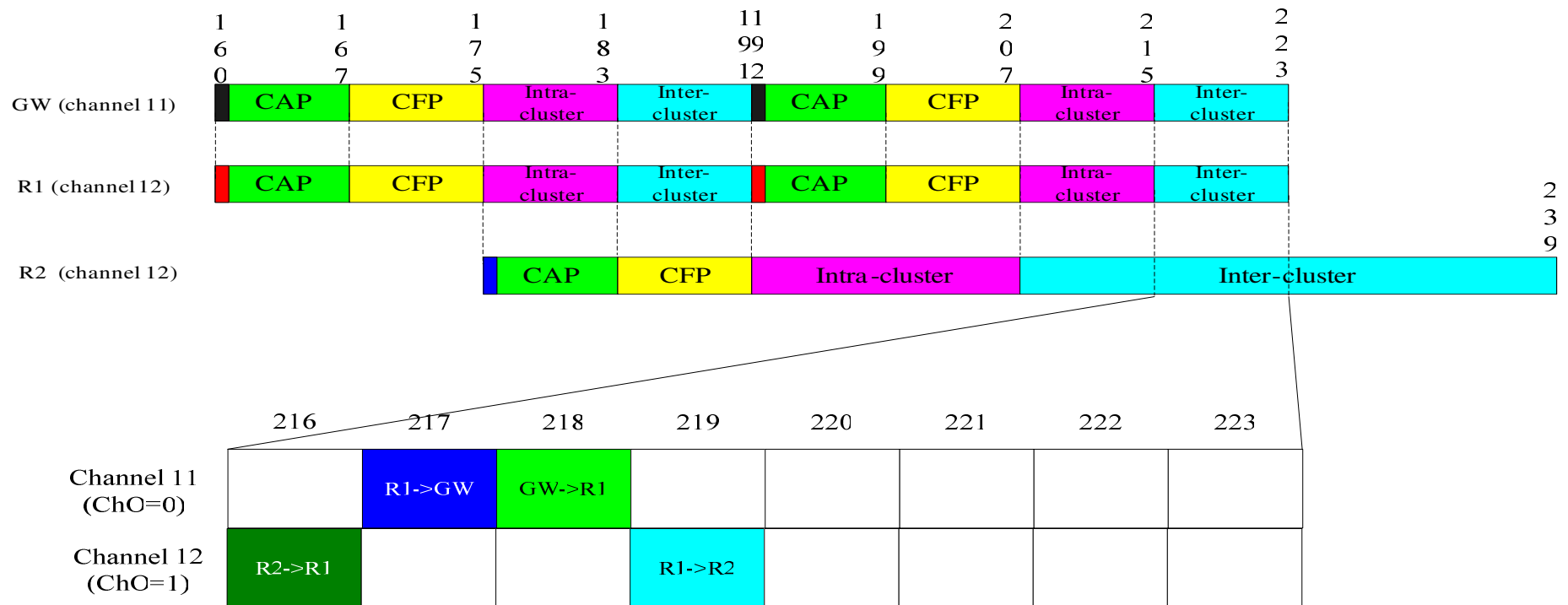

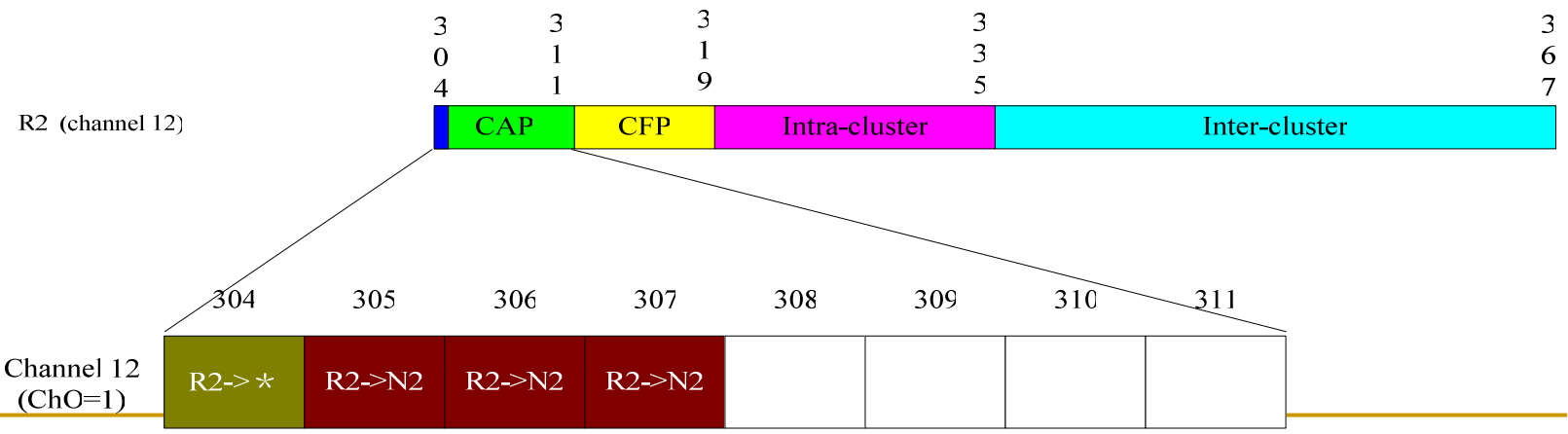
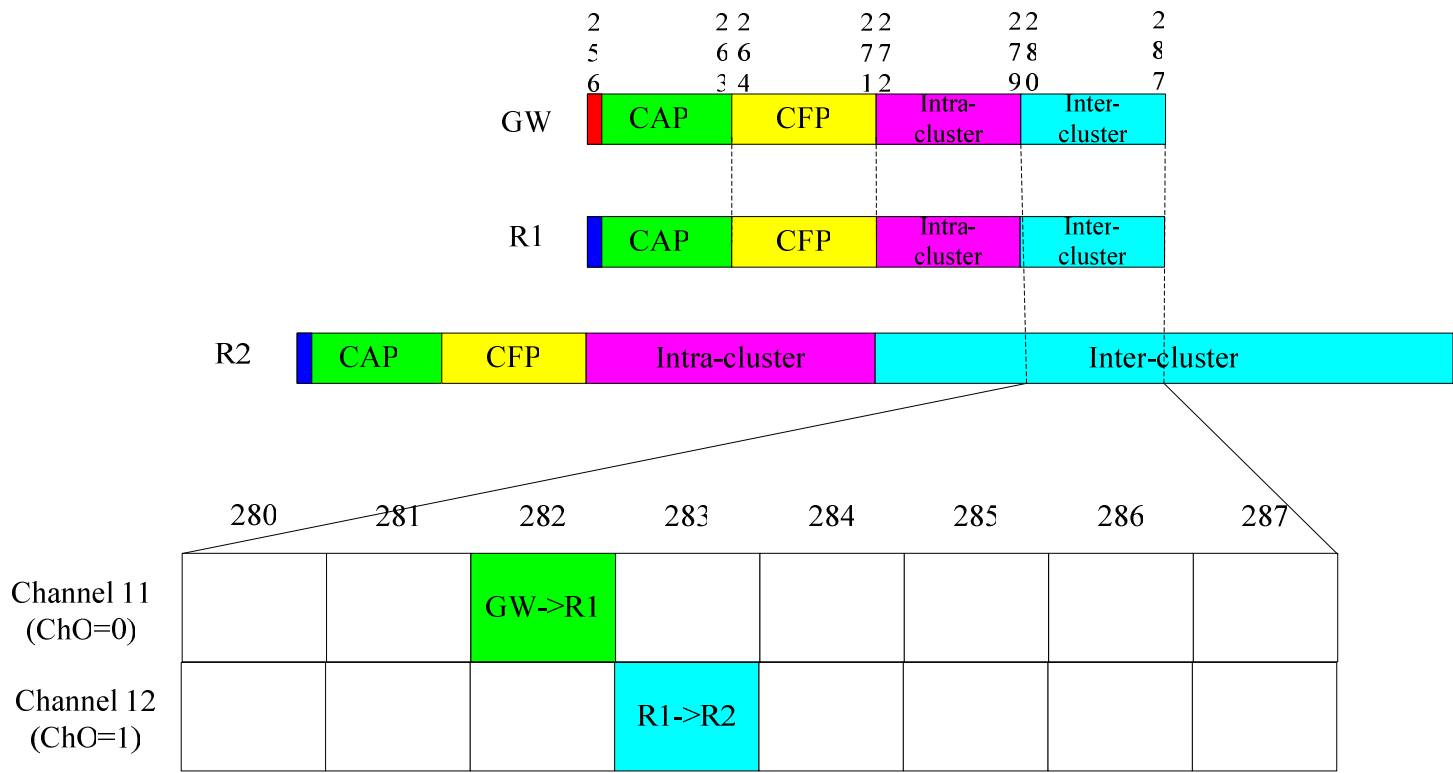



- After GW receiving N2's joining request, GW allocates data slots to R2 (see above figure for detail)

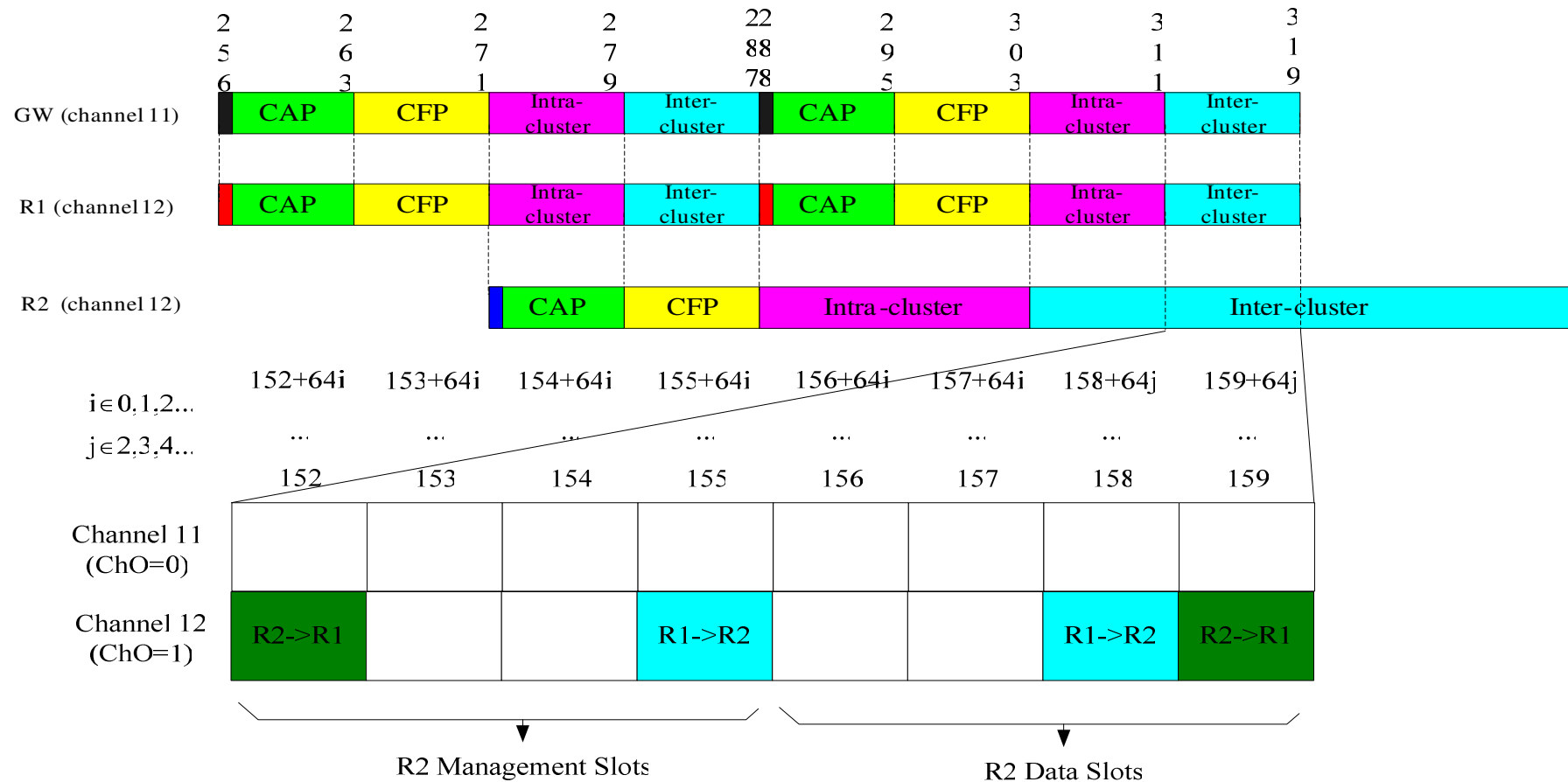

## ■ R2 allocates resources to N2

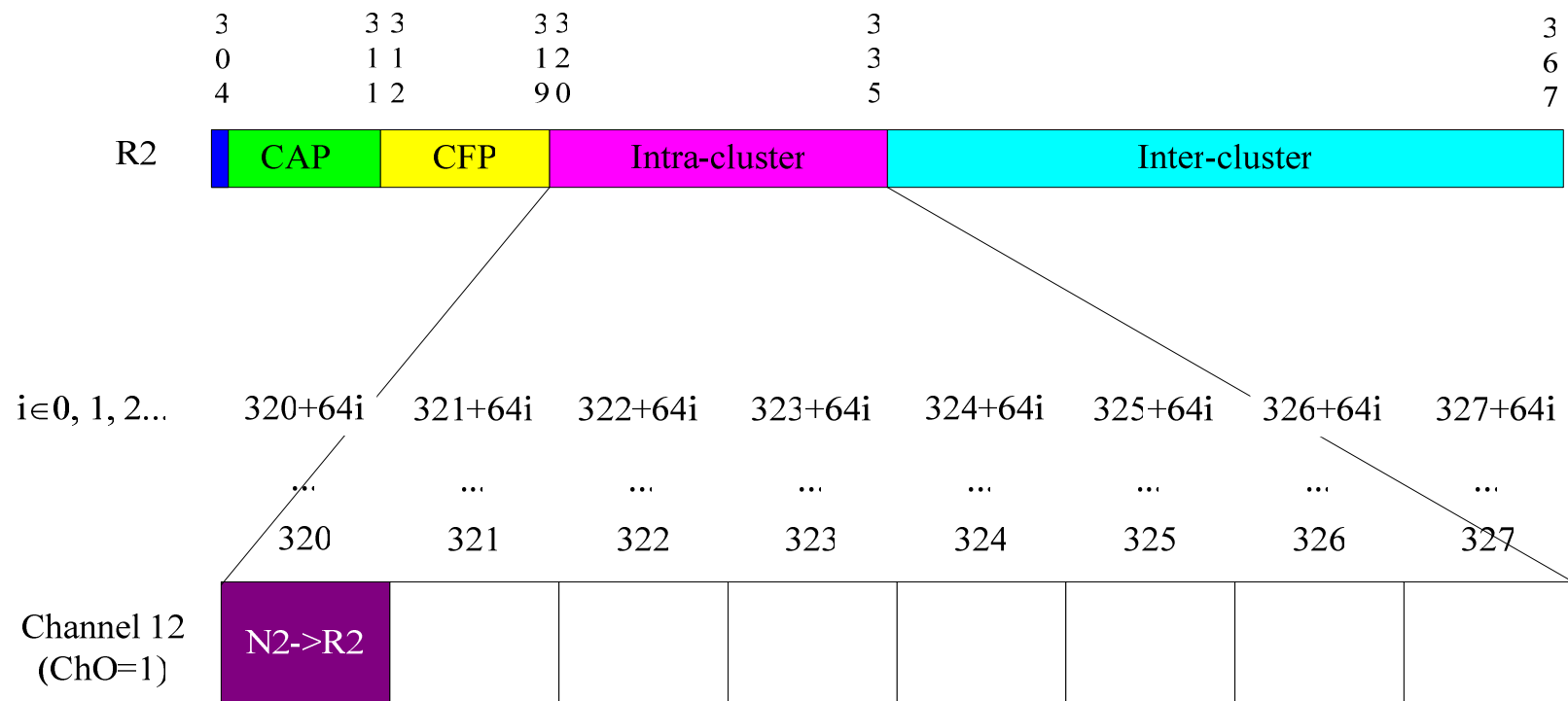

# Joining and resource allocation of N3

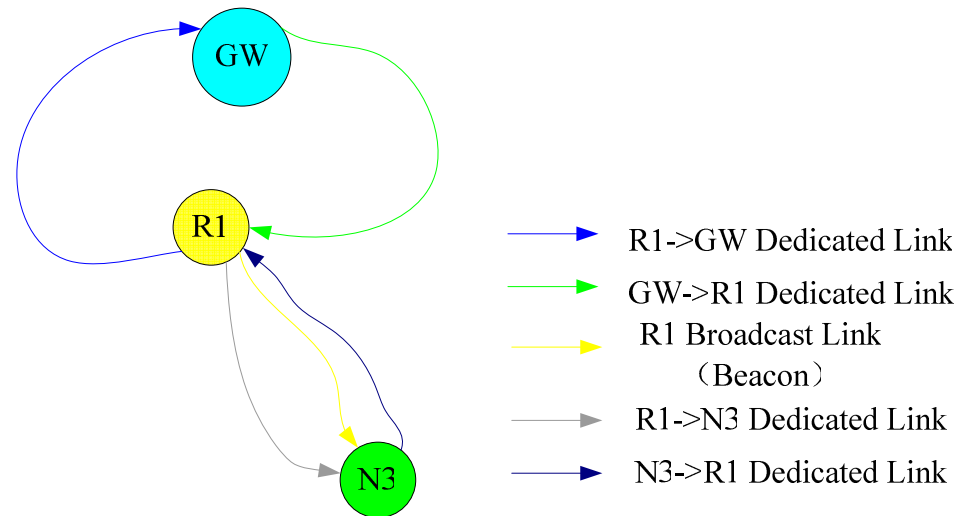
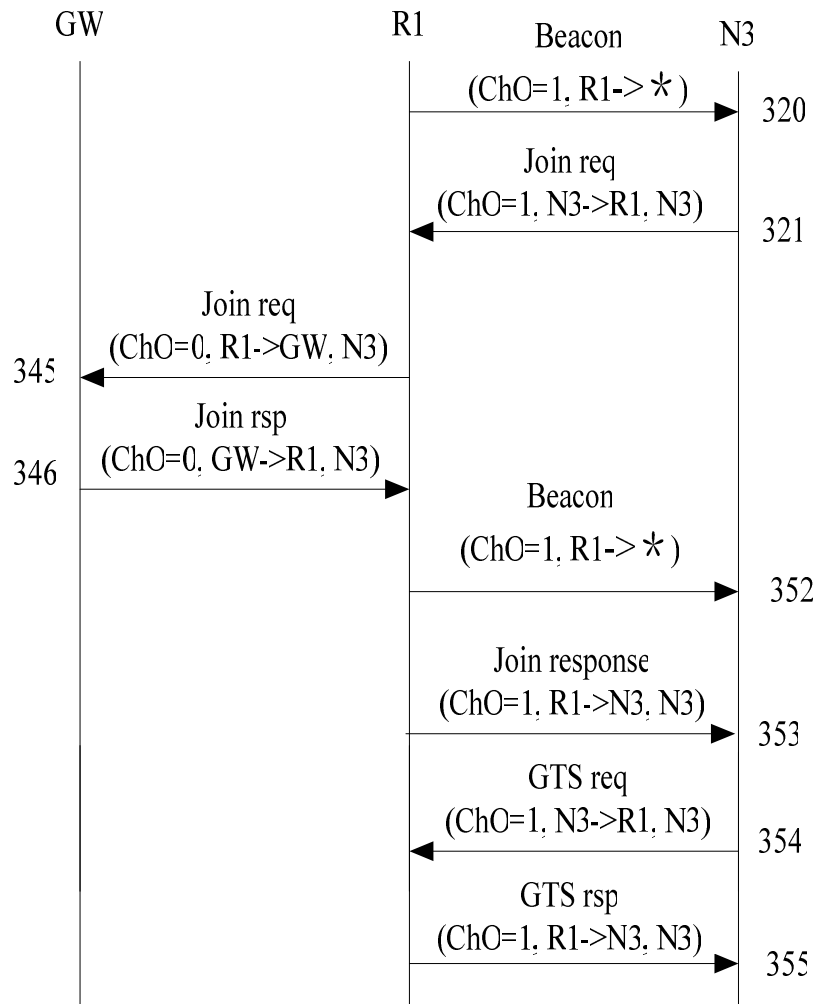

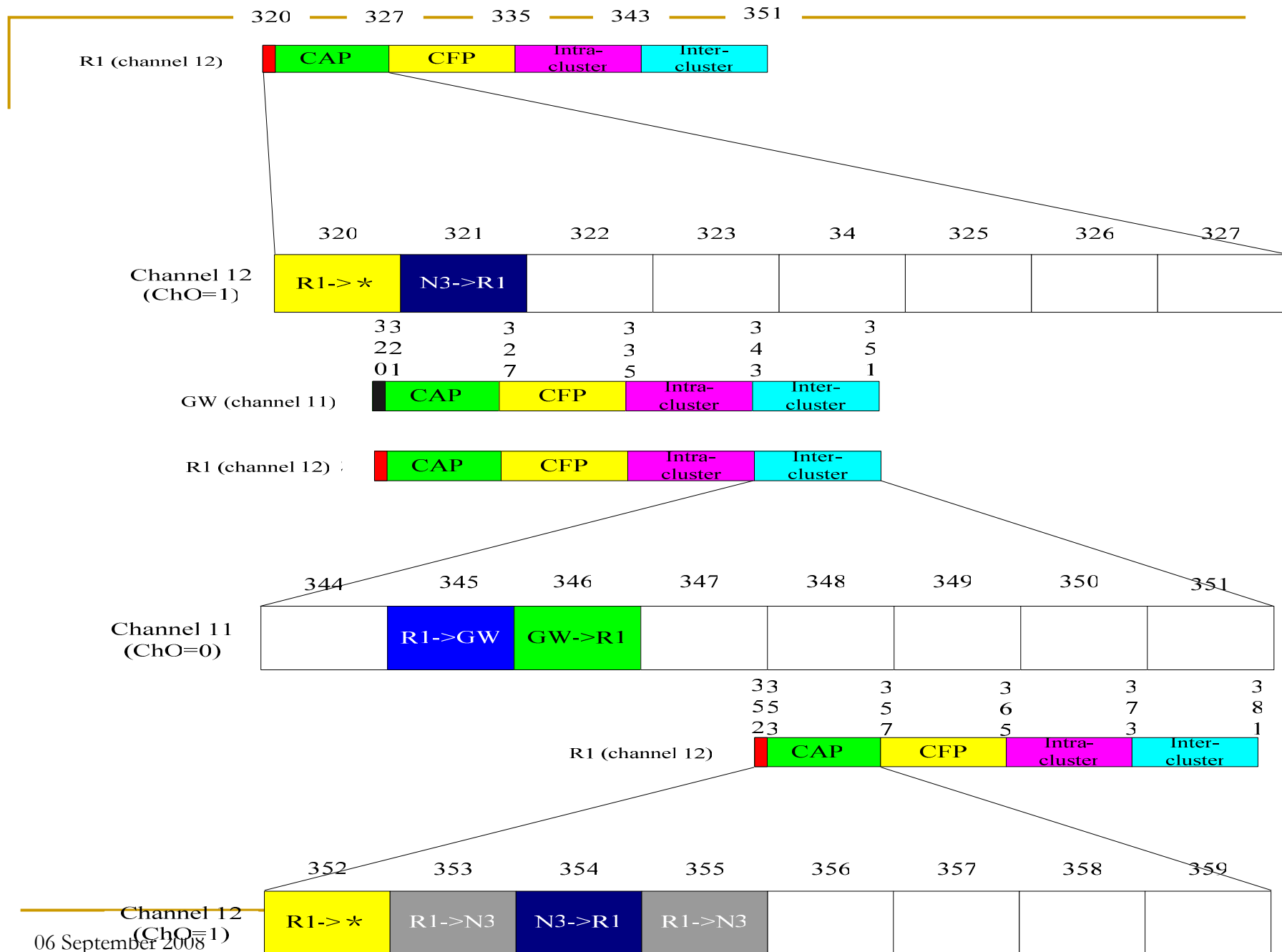

- R1 allocates resources to N3: 3 slots

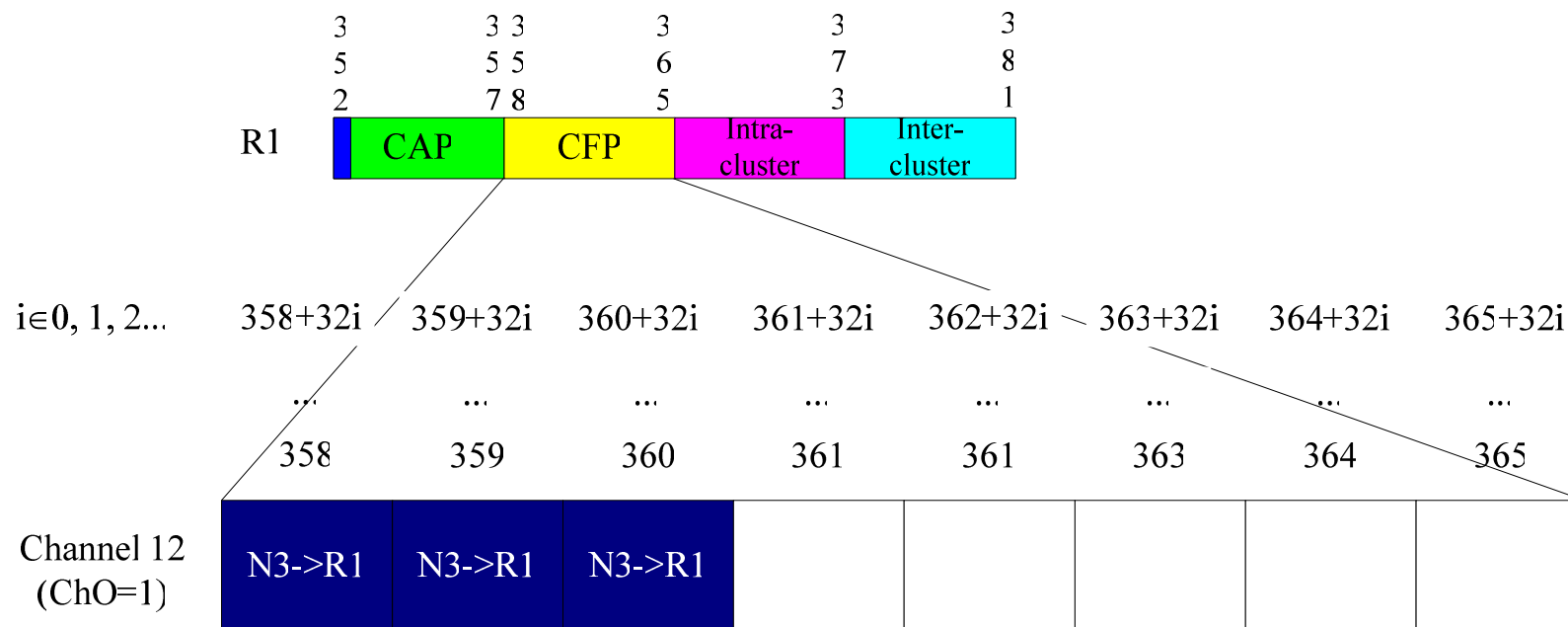

# Overall Resource Allocation Graph

## Inter-cluster:

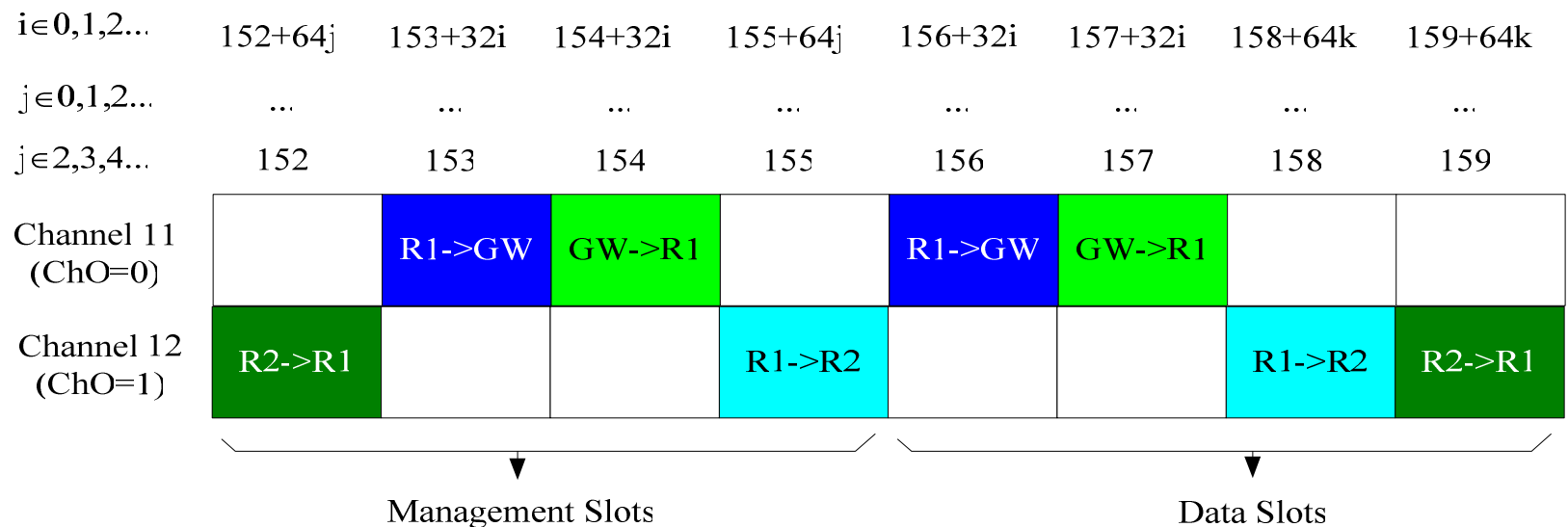

**Intra-cluster  
of R1:**

$i \in 0, 1, 2, \dots$	$144+32i$	$145+32i$	$146+32i$	$147+32i$	$148+32i$	$149+32i$	$150+32i$	$151+32i$
	...	...	...	...	...	...	...	...
	144	145	146	147	148	149	150	151
Channel 12 (ChO=1)	N1->R1							

**Intra-cluster  
of R2:**

$i \in 0, 1, 2, \dots$	$320+64i$	$321+64i$	$322+64i$	$323+64i$	$324+64i$	$325+64i$	$326+64i$	$327+64i$
	...	...	...	...	...	...	...	...
	320	321	322	323	324	325	326	327
Channel 12 (ChO=1)	N2->R2							

**CFP:**

$i \in 0, 1, 2, \dots$	$358+32i$	$359+32i$	$360+32i$	$361+32i$	$362+32i$	$363+32i$	$364+32i$	$365+32i$
	...	...	...	...	...	...	...	...
	358	359	360	361	361	363	364	365
Channel 12 (ChO=1)	N3->R1	N3->R1	N3->R1					

# Overall Link Graph

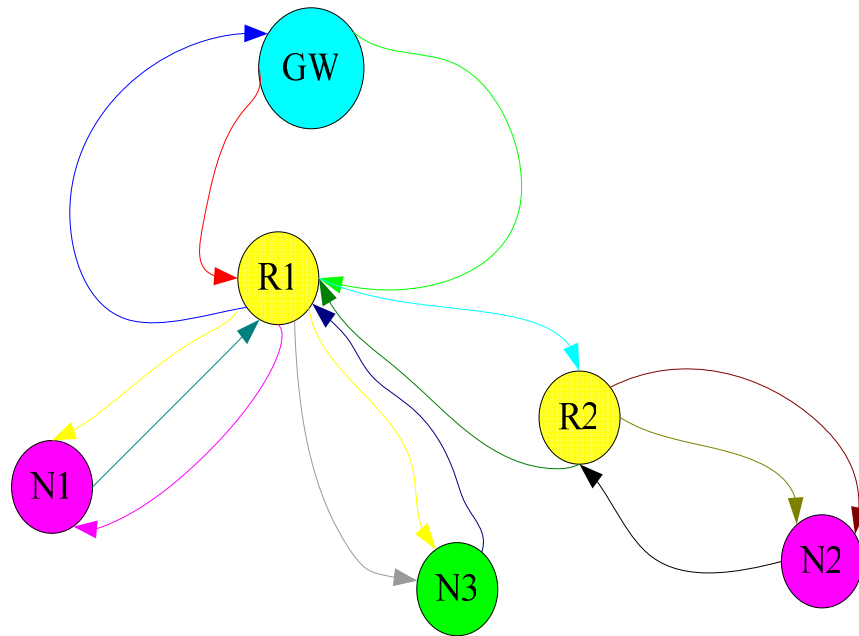

- GW Broadcast Link
- R1->GW Dedicated Link
- GW->R1 Dedicated Link
- R1 Broadcast Link
- R1->R2 Dedicated Link
- R2->R1 Dedicated Link
- R2 Broadcast Link
- R2->N2 Dedicated Link
- N2->R2 Dedicated Link
- R1->N3 Dedicated Link
- N3->R1 Dedicated Link
- R1->N1 Dedicated Link
- N1->R1 Dedicated Link



# Used Resource of Device Joining Process

	0	1	2	3	4	5	6	7
Channel 11 (ChO=0)	GW->*	R1->GW	GW->R1	GW->R1	GW->R1			
Channel 12 (ChO=1)								
	64	65	66	67	68	69	70	71

Channel 11 (ChO=0)	GW->*							
Channel 12 (ChO=1)	R1->*	N1->R1	R2->R1					
	96	97	98	99	100	101	102	103

Channel 11 (ChO=0)	R1->GW	GW->R1	GW->R1	GW->R1	R1->GW	GW->R1	GW->R1	GW->R1
Channel 12 (ChO=1)								
	128	129	130	131	132	133	134	135

Channel 11 (ChO=0)	GW->*							
Channel 12 (ChO=1)	R1->*	R1->N1	R1->N1	R1->N1				

	152	153	154	155	156	157	158	159
Channel 11 (ChO=0)			GW->R1					
Channel 12 (ChO=1)								
	160	161	162	163	164	165	166	167

Channel 11 (ChO=0)								
Channel 12 (ChO=1)	R1->*	R1->R2	R1->R2	R1->R2				
	176	177	178	179	180	181	182	183

Channel 11 (ChO=0)								
Channel 12 (ChO=1)	R2->*	N2->R2						
	216	217	218	219	220	221	222	223

Channel 11 (ChO=0)		R1->GW	GW->R1					
Channel 12 (ChO=1)	R2->R1			R1->R2				

	280	281	282	283	284	285	286	287
Channel 11 (ChO=0)			GW->R1					
Channel 12 (ChO=1)				R1->R2				

	344	345	346	347	348	349	350	351
Channel 11 (ChC=0)		R1->GW	GW->R1					
Channel 12 (ChC=1)								

	304	305	306	307	308	309	310	311
Channel 11 (ChO=0)								
Channel 12 (ChO=1)	R2->*	R2->N2	R2->N2	R2->N2				

	352	353	354	355	356	357	358	359
Channel 11 (ChO=0)	GW->*							
Channel 12 (ChO=1)	R1->*	R1->N3	N3->R1	R1->N3				

	320	321	322	323	324	325	326	327
Channel 11 (ChO=0)	GW->*							
Channel 12 (ChO=1)	R1->*	N3->R1						