

May 2008

doc.: IEEE 802.15-08-0336-00-0thz

Project: IEEE P802.15 Working Group for Wireless Personal Area Networks (WPANs)

Submission Title: THz Communications

Date Submitted: 13 May 2008

Source: Thomas Kürner **Company:** Institut für Nachrichtentechnik

Address

Voice:, FAX:, E-Mail: t.kuerner@tu-bs.de

Re:

Abstract:

Purpose:

Notice: This document has been prepared to assist the IEEE P802.15. It is offered as a basis for discussion and is not binding on the contributing individual(s) or organization(s). The material in this document is subject to change in form and content after further study. The contributor(s) reserve(s) the right to add, amend or withdraw material contained herein.

Release: The contributor acknowledges and accepts that this contribution becomes the property of IEEE and may be made publicly available by P802.15.

IEEE 802 Wireless Interim Meeting, 802.15 THz-IG
Jacksonville/Florida, 13 May 2008

THz Communications –
an overview on research activities
at Terahertz Communications Lab

Thomas Kürner
Institut für Nachrichtentechnik
Terahertz Communications Lab
TU Braunschweig, Germany

Overview

- Introducing the TCL
- Motivation
- Challenges
- Research on the THz Radio Channel
- 300 GHz Demonstrator
- Outlook and Future Activities

Structure Terahertz Communications Lab (TCL)

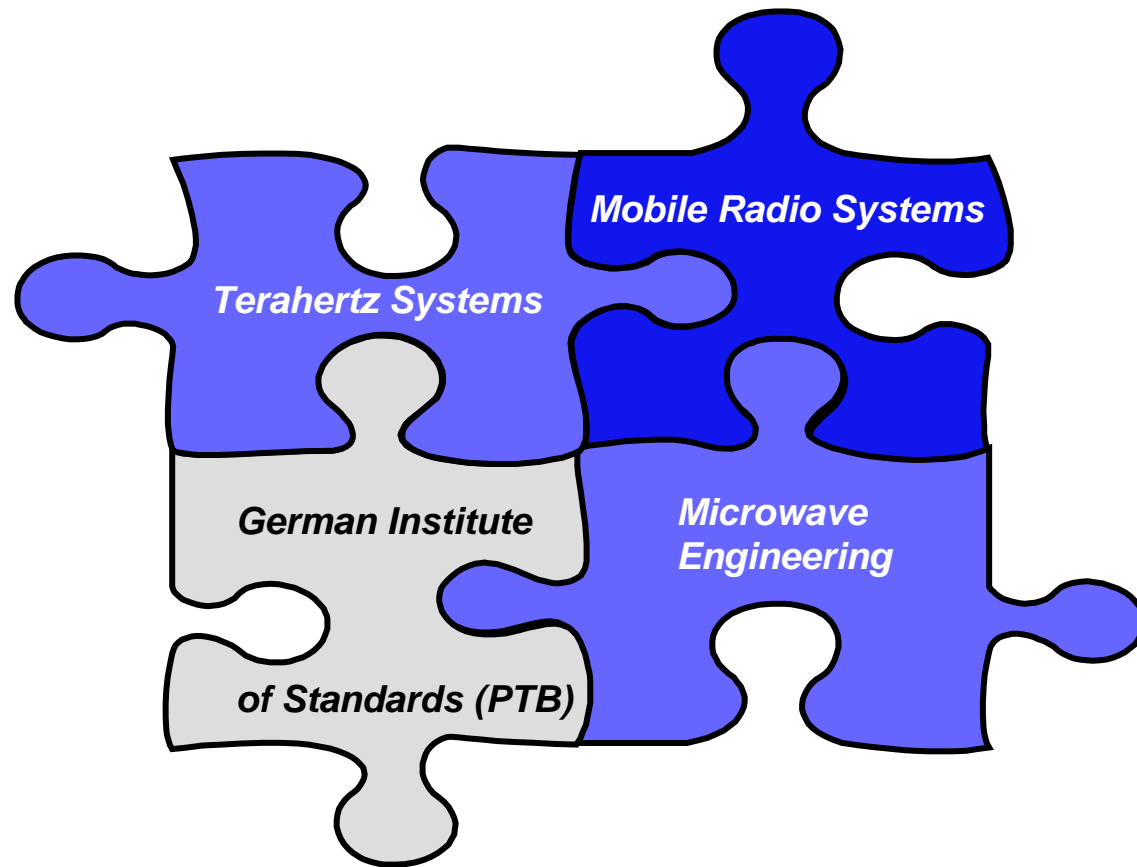

Members of TCL



www.tcl.tu-bs.de

Progress of data rates in communication systems

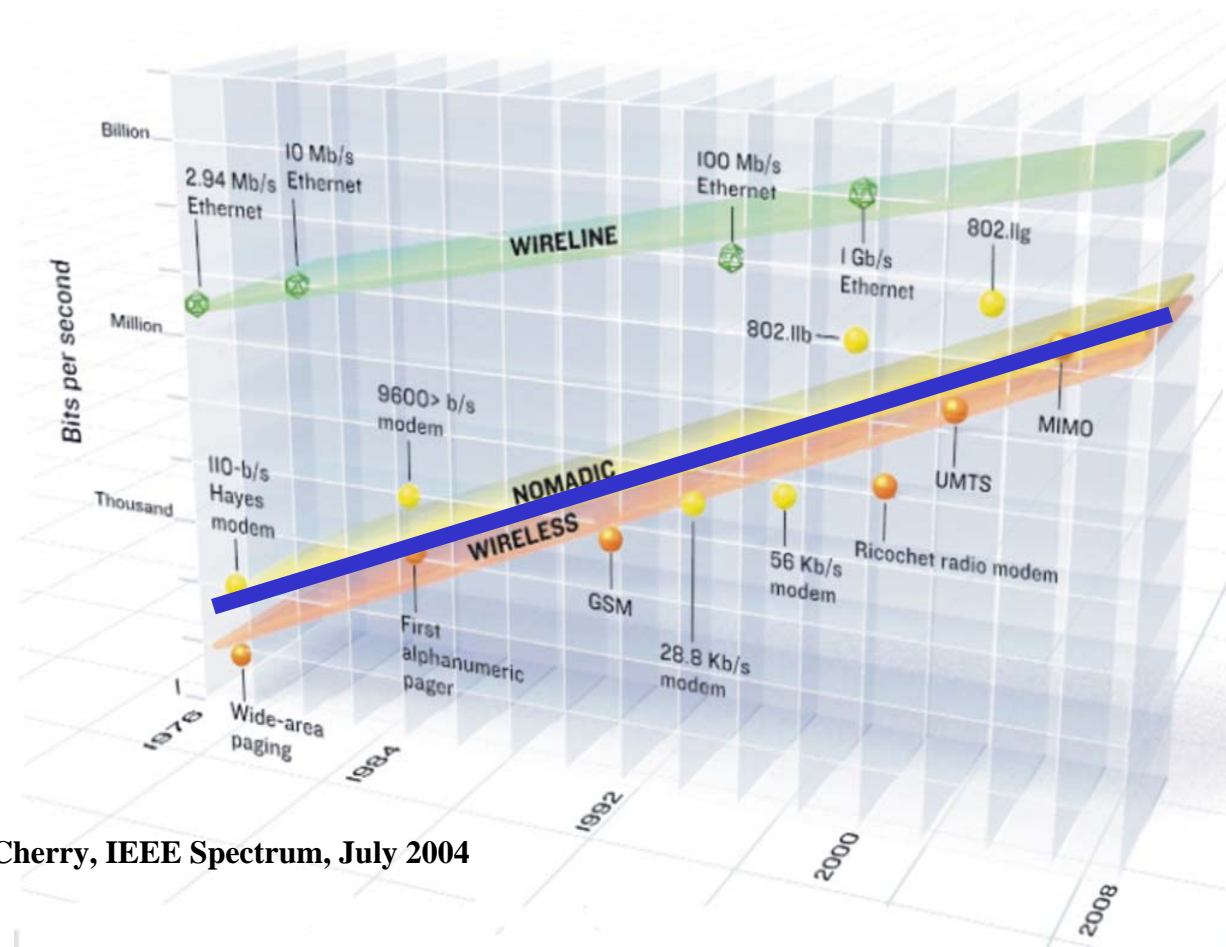

In 10 years data rates of more than 10 Gbps will be needed!

S. Cherry, IEEE Spectrum, July 2004

Application scenarios for radio systems with xxGbps

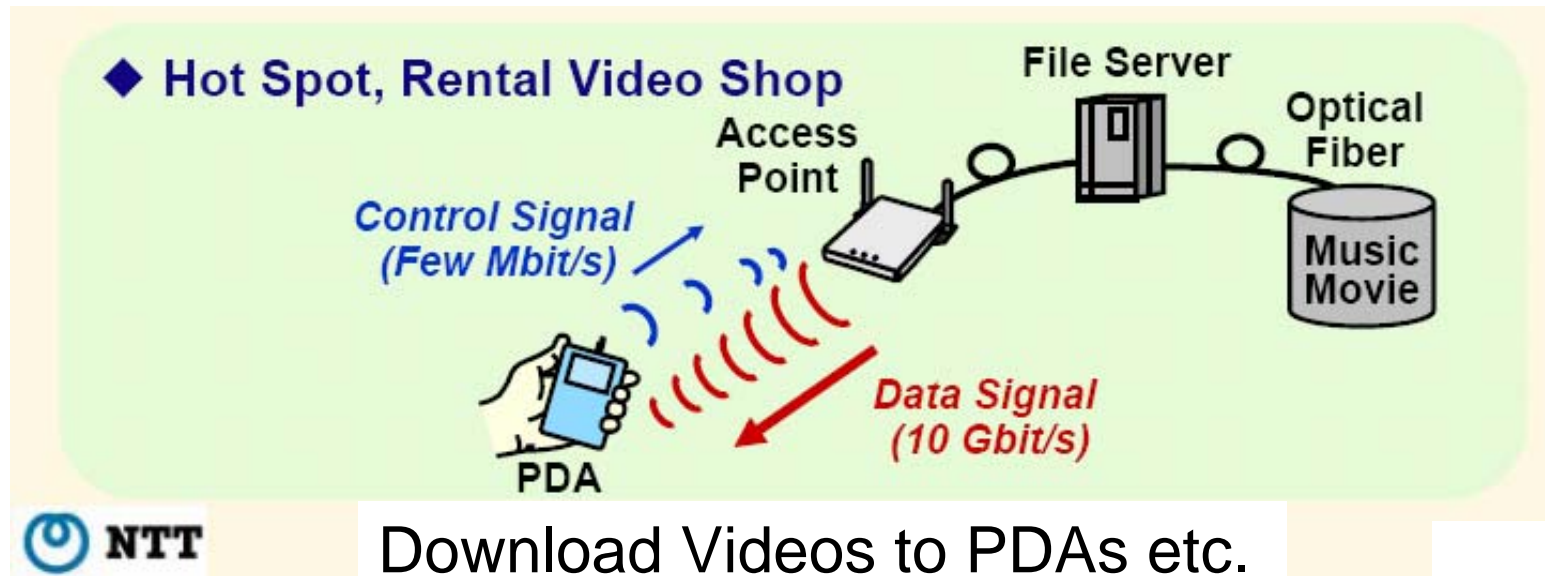

Or:

- Connection between peripheral devices and the PC (Hard Disks ...)
- Wireless extension of EPONs (Ethernet Passive Optical Networks): 1- 10 Gb/s
- Wireless extension of Ethernet and GigabitEthernet LANs: 0.1- 10 Gb/s

Currently and soon available systems

- WLAN (Wireless Local Area Networks)
 - IEEE 802.11b, **11 Mbps**, 2400 - 2483.5 MHz
 - IEEE 802.11g, **54 Mbps**, 2400 - 2483.5 MHz
 - IEEE 802.11a, **54 Mbps**, 5150 - 5350 MHz, 5470 - 5725 MHz, 5725 - 5825 MHz
 - **IEEE 802.11n, 100 Mbps, optional bis zu 600 Mbps**, Freq. like 802.11a
 - **WIGWAM Project, up to 1 Gbps**, 5, 17, 24, 60 GHz, MIMO
- WPAN (Wireless Personal Area Networks)
 - **Bluetooth**, IEEE 802.15.1a, **1 Mbps**, 2400 - 2483.5 MHz
 - High-rate WPANs, **IEEE 802.15.3a**, realized **500 Mbps**, planned **1.3 Gbps @ several meters, UWB based**, 3.1-10.6 GHz,
 - High data rate WPANs, **IEEE 802.15.3c**, planned **2 Gbps @ several meters**, mm-Wave, **60 GHz band (57-64 GHz)**

There is a need for more bandwidth!

Where is enough bandwidth available?

Microwave range?

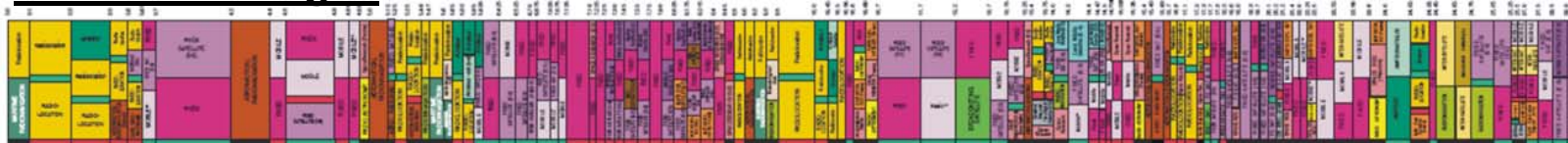

3 GHz mm-wave range?



30 GHz US frequency allocations, Oct 2003

Potential at 300 GHz and above!

- Currently Unregulated Spectrum at THz frequencies (300 GHz- 3 THz) available ...
- ...but this spectrum is on the agenda for WRC 2011 (agenda tem 1.6)!
- 10 GHz bandwidth and 1 bit/s/Hz => 10 Gbps data rate (simple modulation scheme, no coding)



Challenges on the way towards a THz communication system

- Emitter
- Receiver
- Amplifier
- Antennas
- Feeding of the antennas
- Mixer
- Noise
- high free space damping
- high atmospheric damping
- which modulation scheme
- Multi-path propagation



Output power of different THz sources

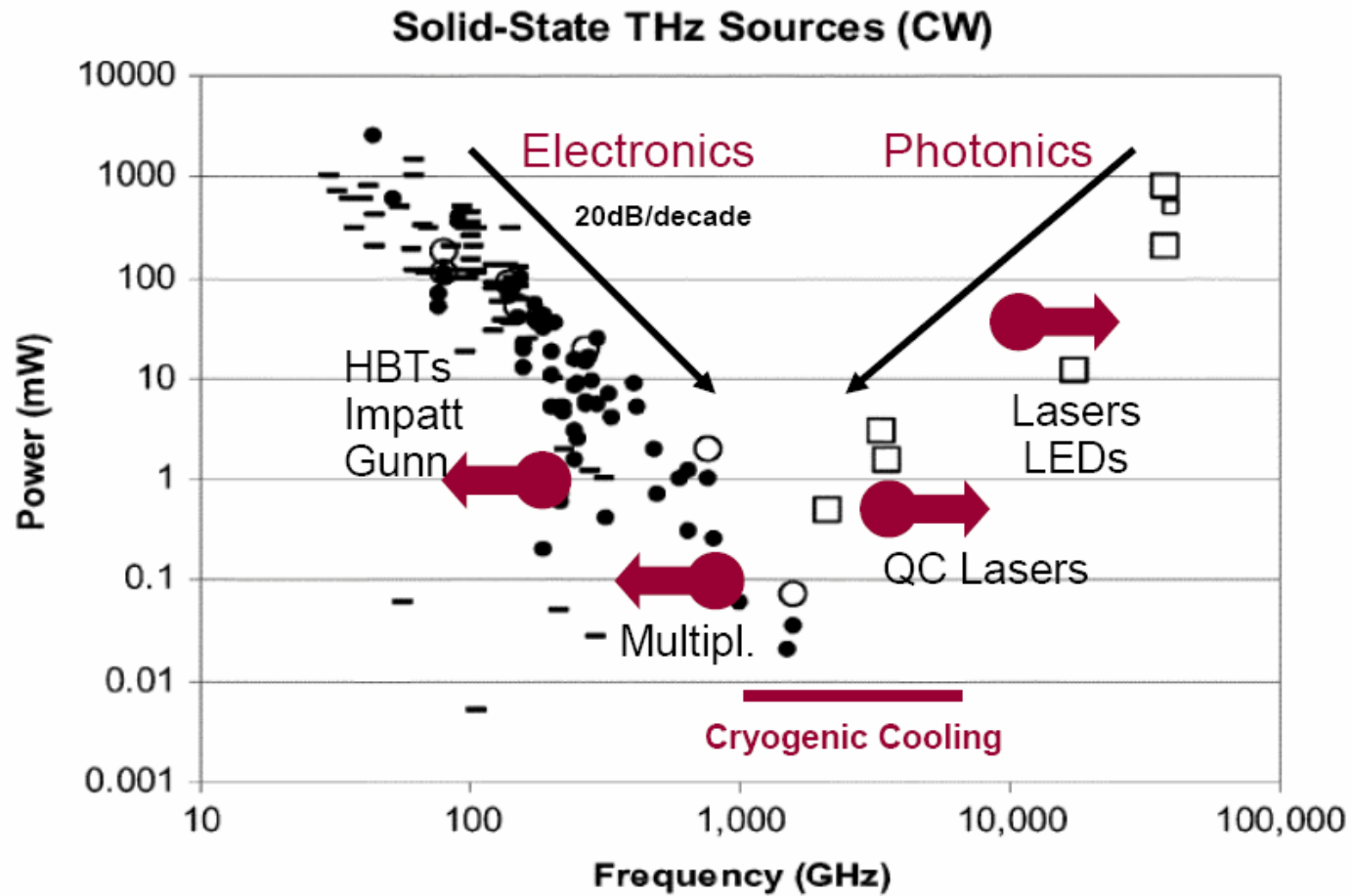

[1] T. Crow et.al., "Opening the Terahertz Window With Integrated Diode Circuits", JSSCC 2005

Projection of technological progress

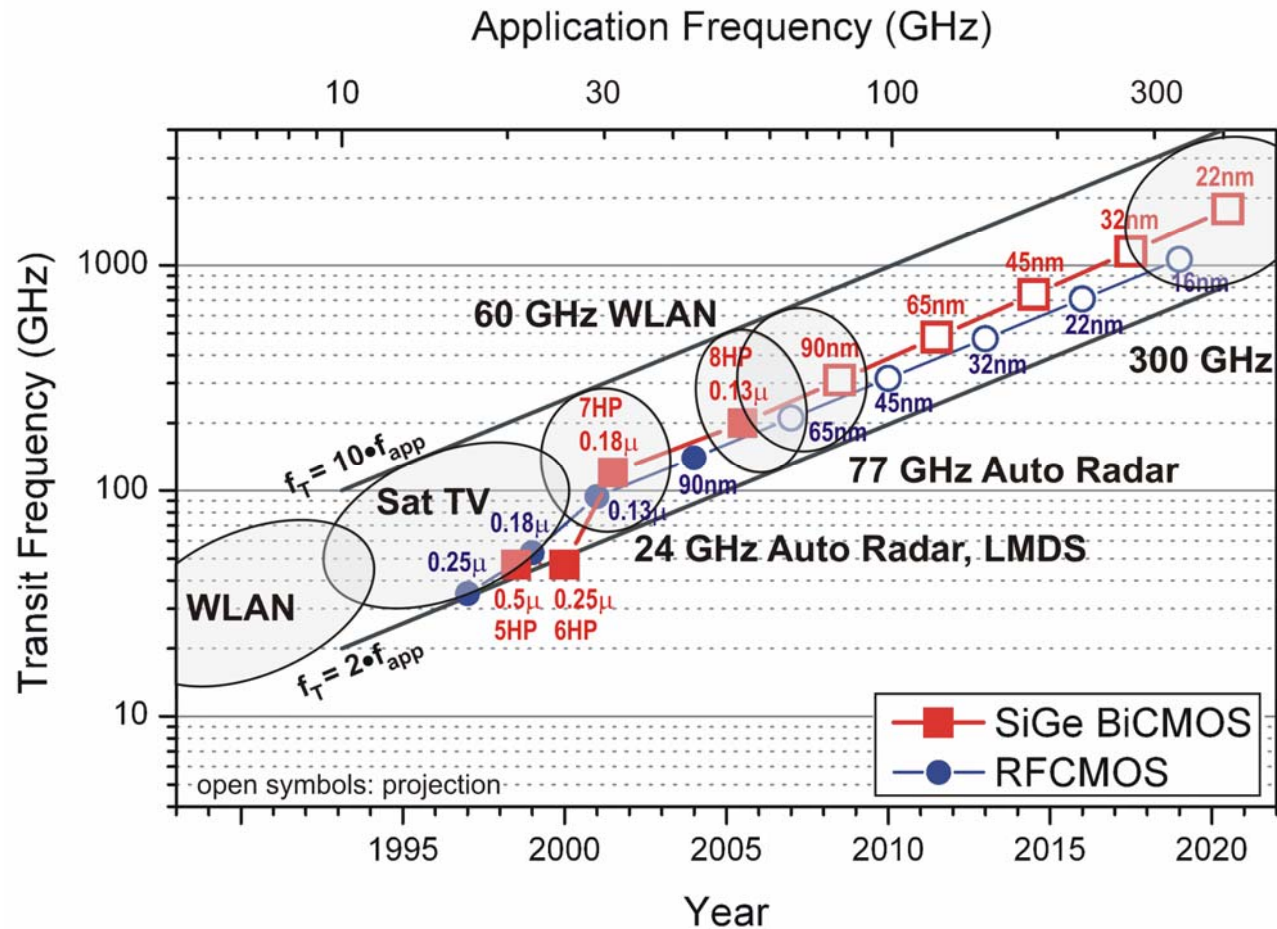

R. Piesiewicz et al., IEEE Ant. and Prop. Magazine, 2007

The THz Radio Channel

- **While characterising the THz channel three effects are important**
 1. Free space losses: high at these frequencies (> 100 dB @ 10 m, 300 GHz)
 - **Indoor communication for short distances**
 2. Atmospheric attenuation
 - Significant only for potential outdoor applications
 3. Interaction with Objects
 - **Reflection and Scattering processes**, especially interesting for indoor applications

Free space and atmospheric damping

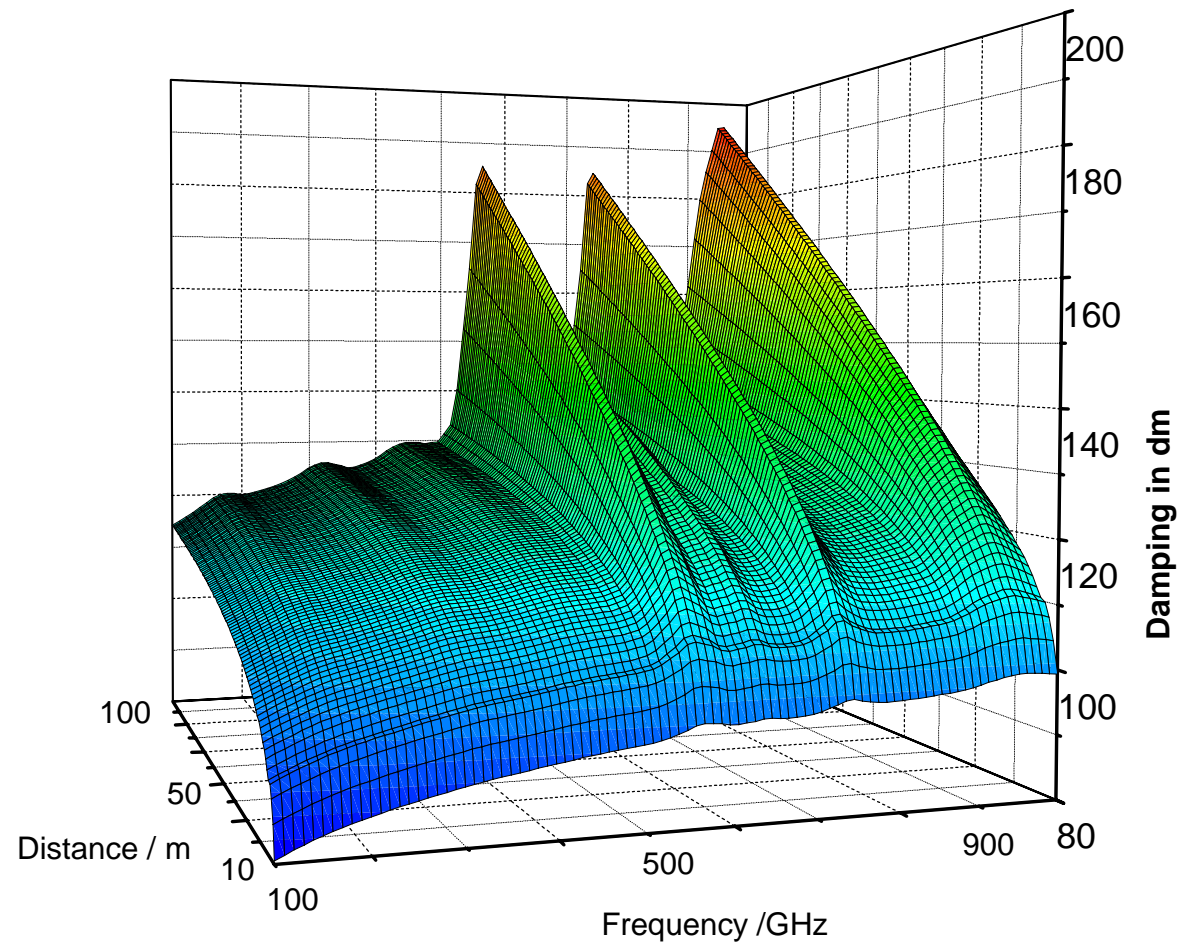

„Line of sight“ - Communication

- Antennas with high gain necessary to compensate high transmission losses
- Directed Transmission
- Possible Concept
 - Antenna arrays

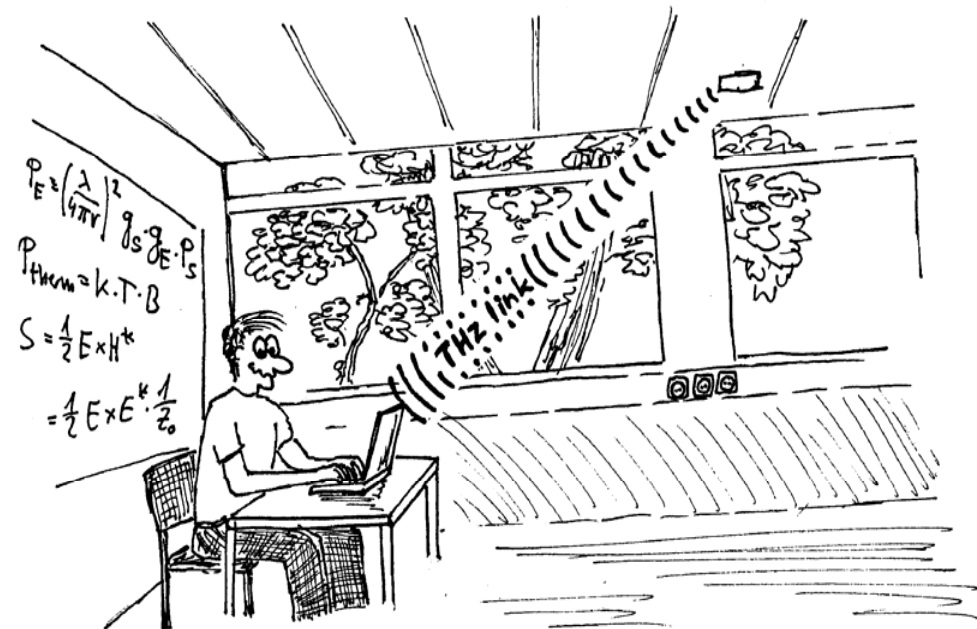

LOS

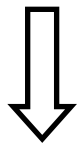

Fundamental difference to current systems

„Non Line of sight“ - Communication

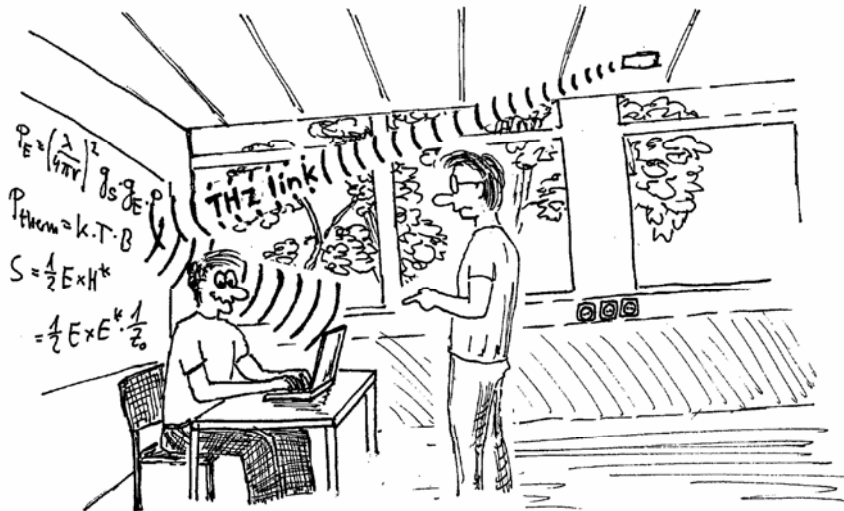

© MK 06

Directed NLOS

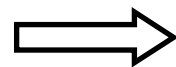

Research necessary

- LOS: Transmission cancelled, if somebody steps between transmitter and receiver
- Solution: Embedding „non-line of sight“ paths as backup
- Therefore reflections on the wall are used
- Smart antennas needed
Beamforming
Beamsteering

Interaction with Objects

- Ray-tracing is well-suited to model the propagation channel beyond 300 GHz in indoor environments
- Proper modelling of reflection and scattering processes for typical building materials required:
 1. Reflection on smooth surface
 2. Scattering on rough surface
 3. Reflection on multi-layer objects

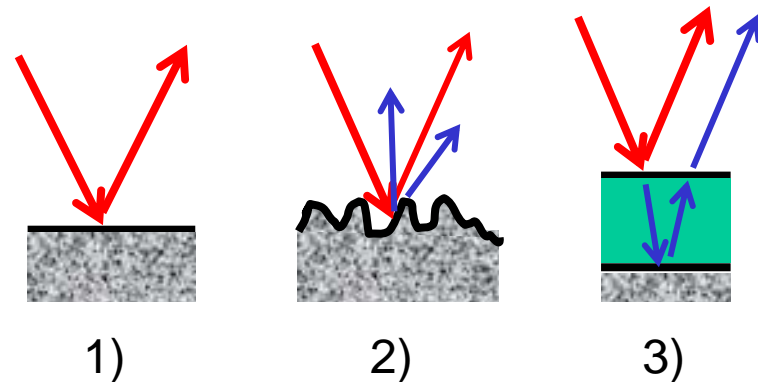
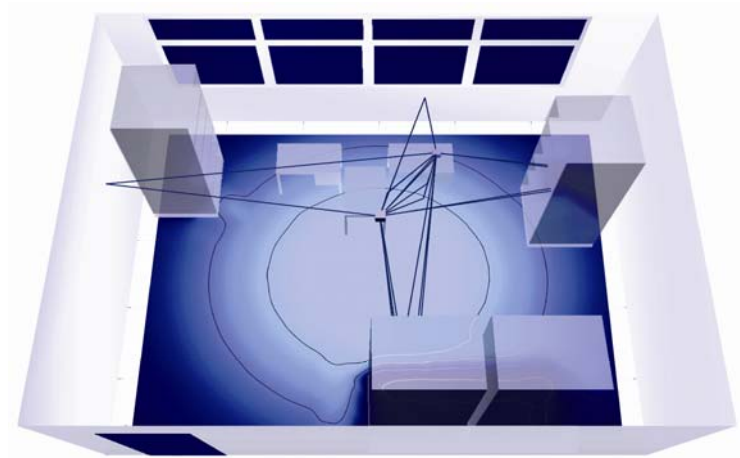

Modelling Reflection on a Smooth Surface

- Calculation by Fresnel's reflection coefficients:
 - Material parameters needed:
 - refractive index $n(f)$
 - absorption coefficient $\alpha(f)$

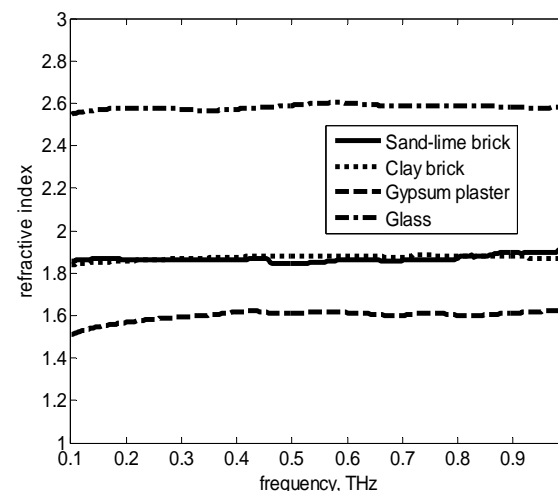
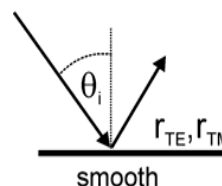

- Measuring material parameters by THz-TDS in

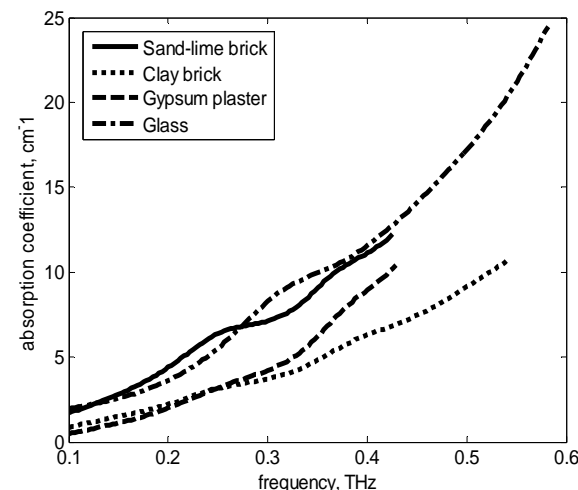
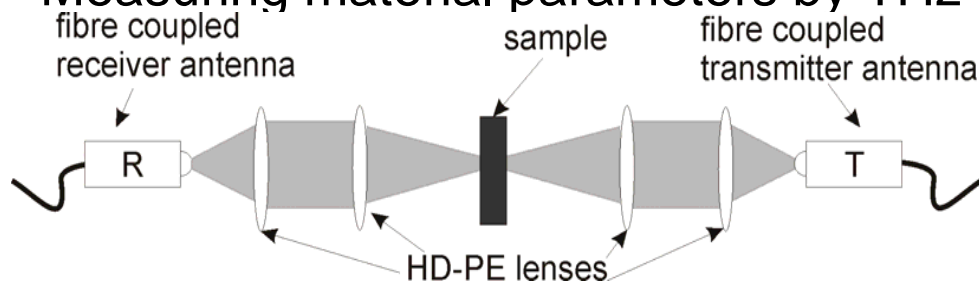

R. Piesewicz, Intern. Journal on Infrared and Millimeter Waves, May 2007

Measurements of building materials

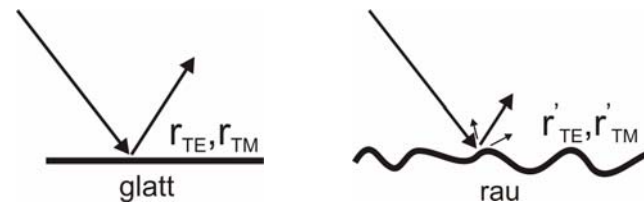
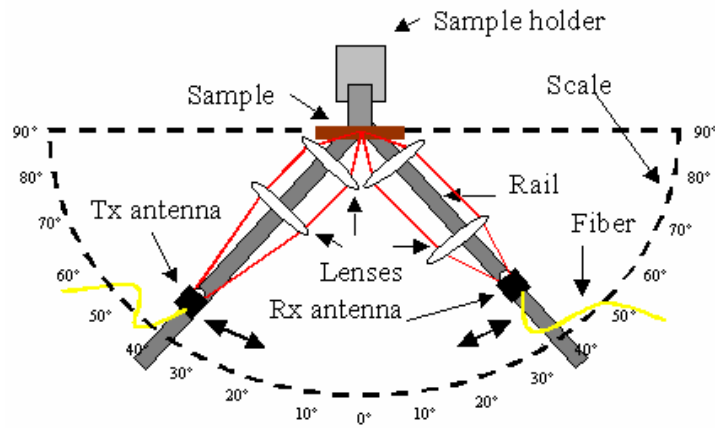

Scattering on rough surfaces

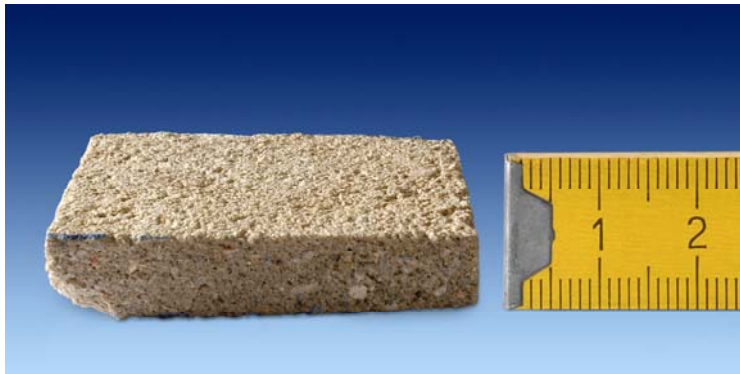

plaster



Ingrain wallpaper

Reflection properties of ingrain wallpaper

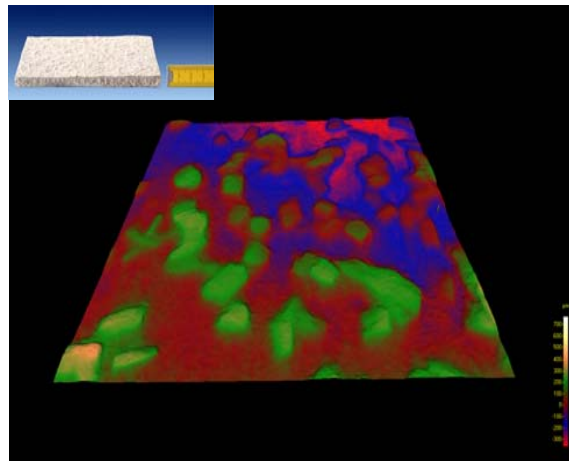

Measured surface roughness

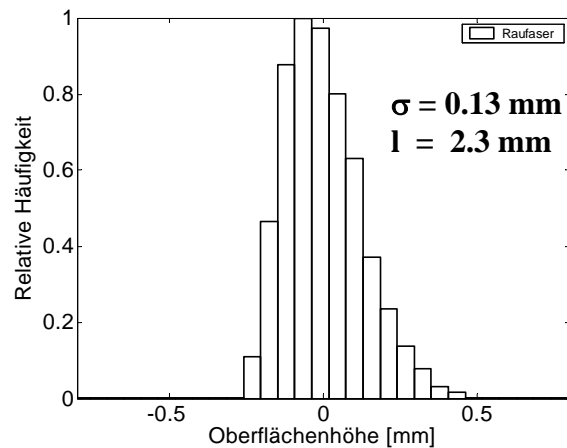

Raufaser, 70 Grad, TE Polarization

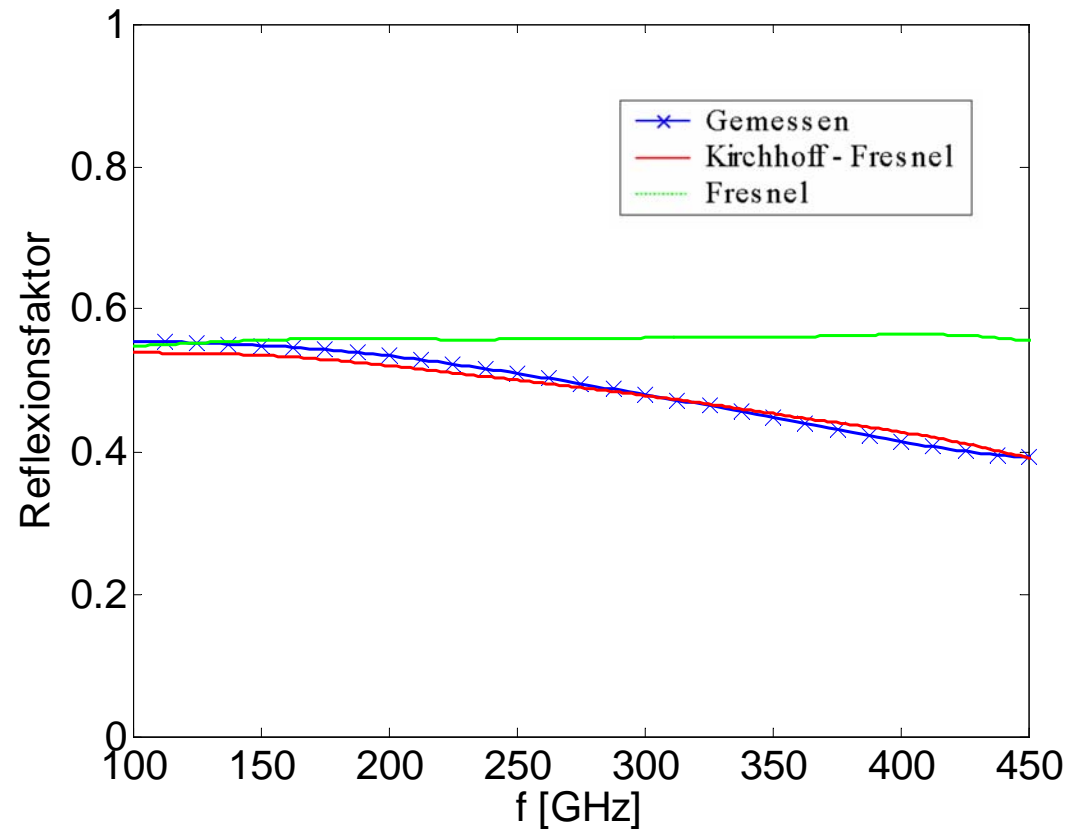

R. Piesiewicz et al., IEEE Trans. AP, November 2007

Multiple Layer Modelling

- Calculation by transfer matrix method

$$\begin{pmatrix} E_{inc} \\ E_{ref} \end{pmatrix} = I_0 \left(\prod_{m=1}^N P_m I_m \right) \begin{pmatrix} E_{trans} \\ 0 \end{pmatrix}$$

$$= \begin{pmatrix} a_{11} & a_{12} \\ a_{21} & a_{22} \end{pmatrix} \begin{pmatrix} E_{trans} \\ 0 \end{pmatrix} = \begin{pmatrix} a_{11} \\ a_{21} \end{pmatrix} E_{trans}$$

$$t_{strat} = \frac{E_{trans}}{E_{inc}} = \frac{1}{a_{11}}$$

$$r_{strat} = \frac{E_{ref}}{E_{inc}} = \frac{a_{21}}{a_{11}}$$

Magnitude of reflection coefficient: white paint on plaster

paint: 0.695 mm
plaster: thick

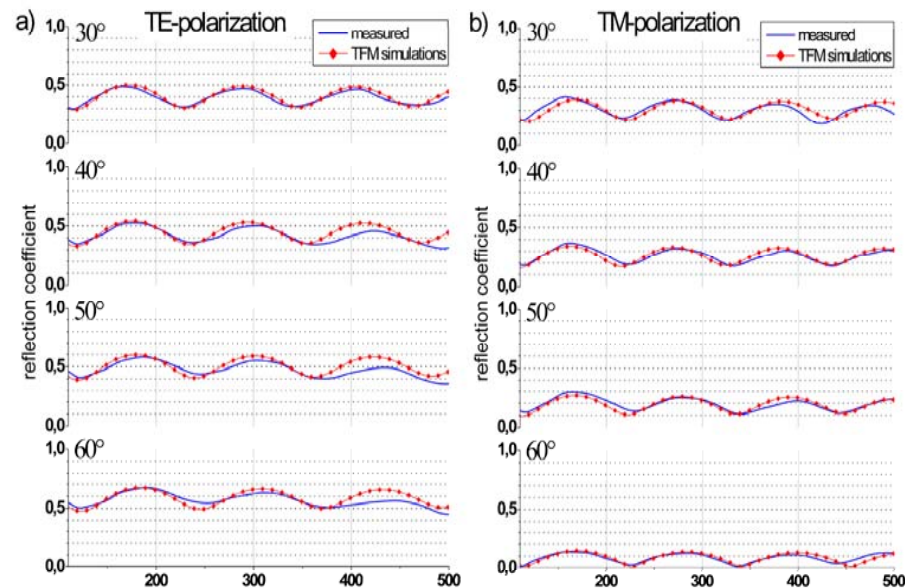

C. Jansen et al., IEEE Trans. AP, to appear in 2008

Flexible THz mirrors

- „dielectric mirror“

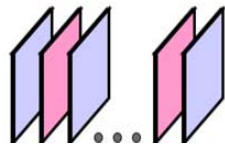

- Polymer layer
- high reflectivity (ca. 95%)
@ 300 - 400 GHz
- Low-cost

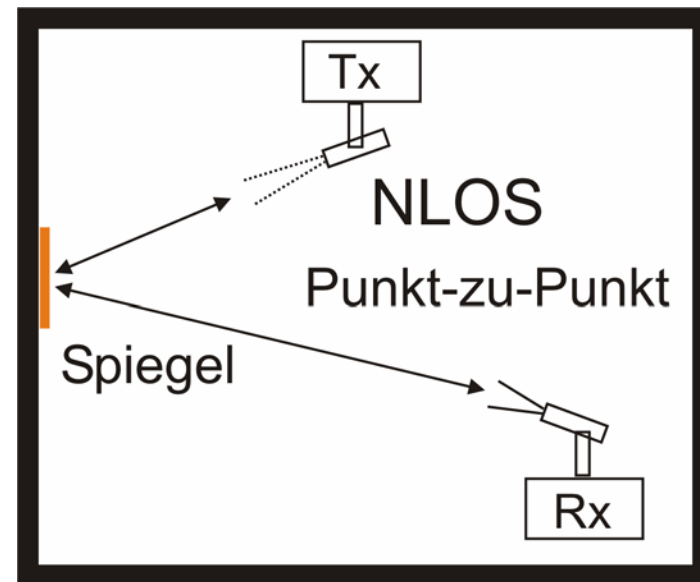

➔ **Wallpaper to support
NLOS-paths in THz Cells**

N. Krumbholz et al,
Appl. Physics Lett. 88,
202905 (2006)

System simulations

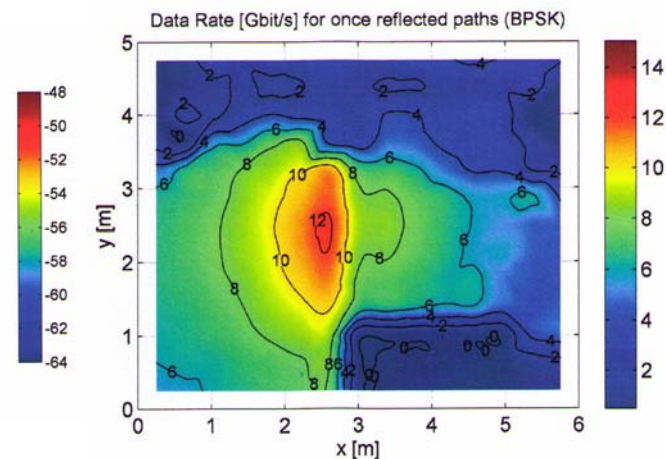
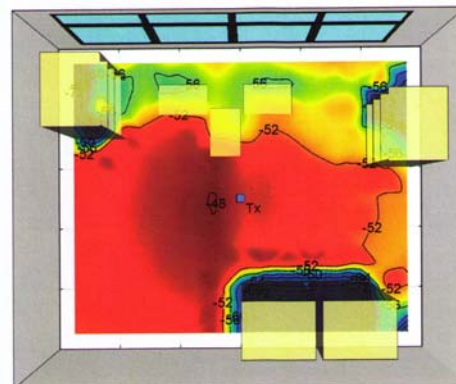
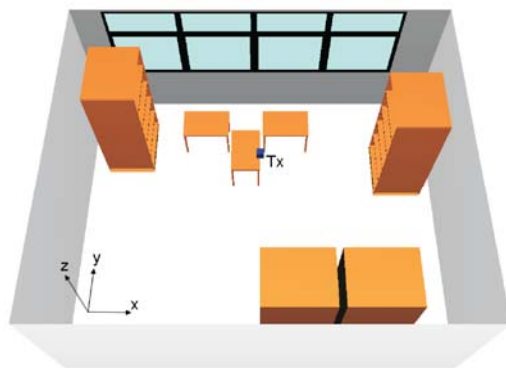
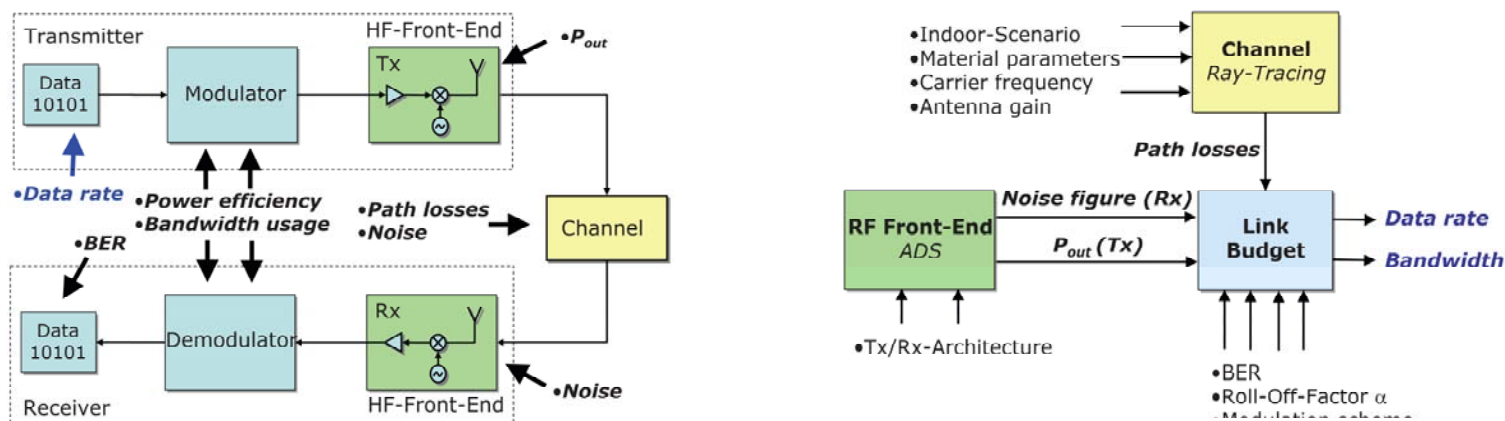

Indoor Scenario → **Ray Tracing** → **Data Rate**

R. Piesiewicz et al., IEEE JSTQE, Vol. 14, No. 2, March/April 2008.

Simulation Scenario

- Definition of an indoor scenario
 - Size 6m x 5m x 2.5 m
 - Scenario variations
 - With furniture / empty room
 - Simulation of different wall properties
 - Tx in the center of the room
 - Rx at a height of 0.95m
 - Tx Power: -13.9 dBm
 - Rx noise figure: 10.6 dB

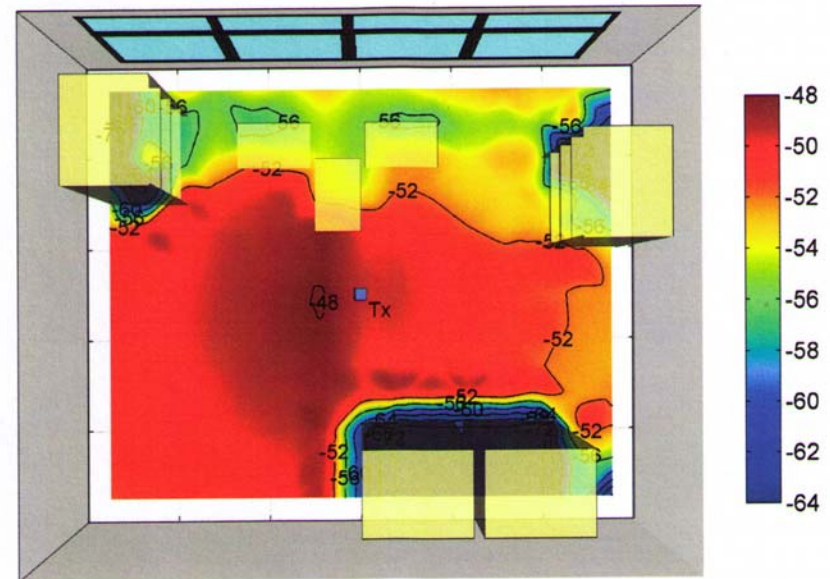

Simulated total received power

Exemplary Results

- Maximum achievable data rate for BPSK with incoherent demodulation for once-reflected rays (all walls covered by plastic mirrors)

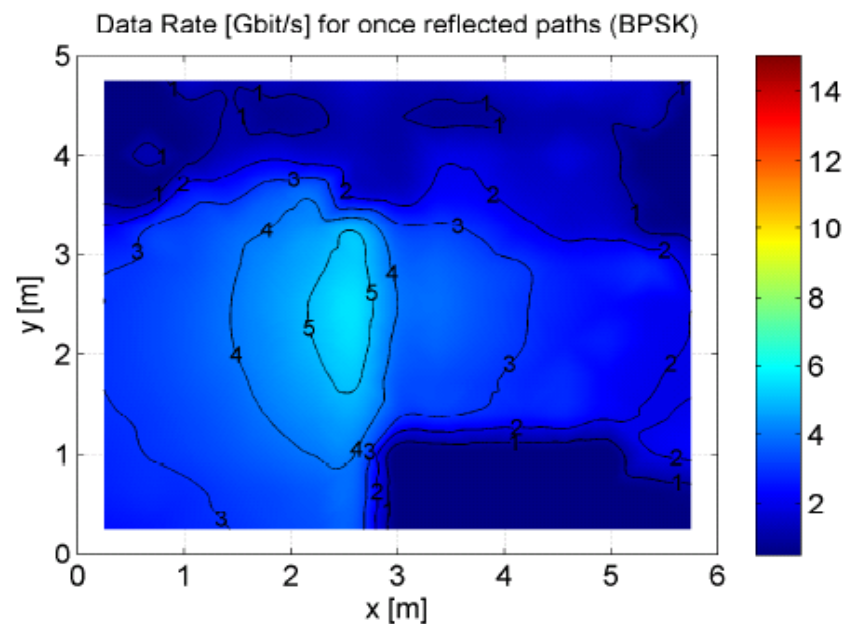
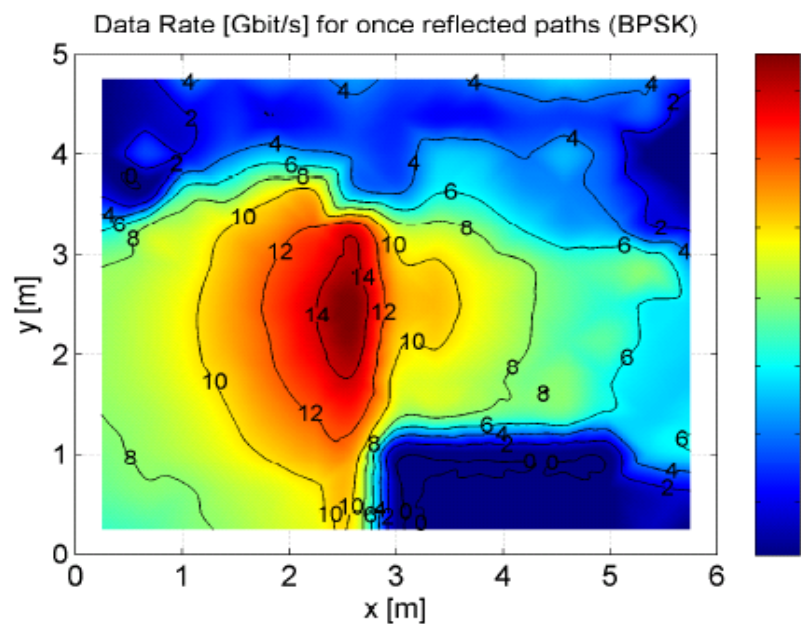

Influence of wall materials

- Maximum achievable data rates for different wall materials
 - empty room scenario
 - Assuming all walls are covered by the same material
 - BPSK modulation
 - once-reflected paths

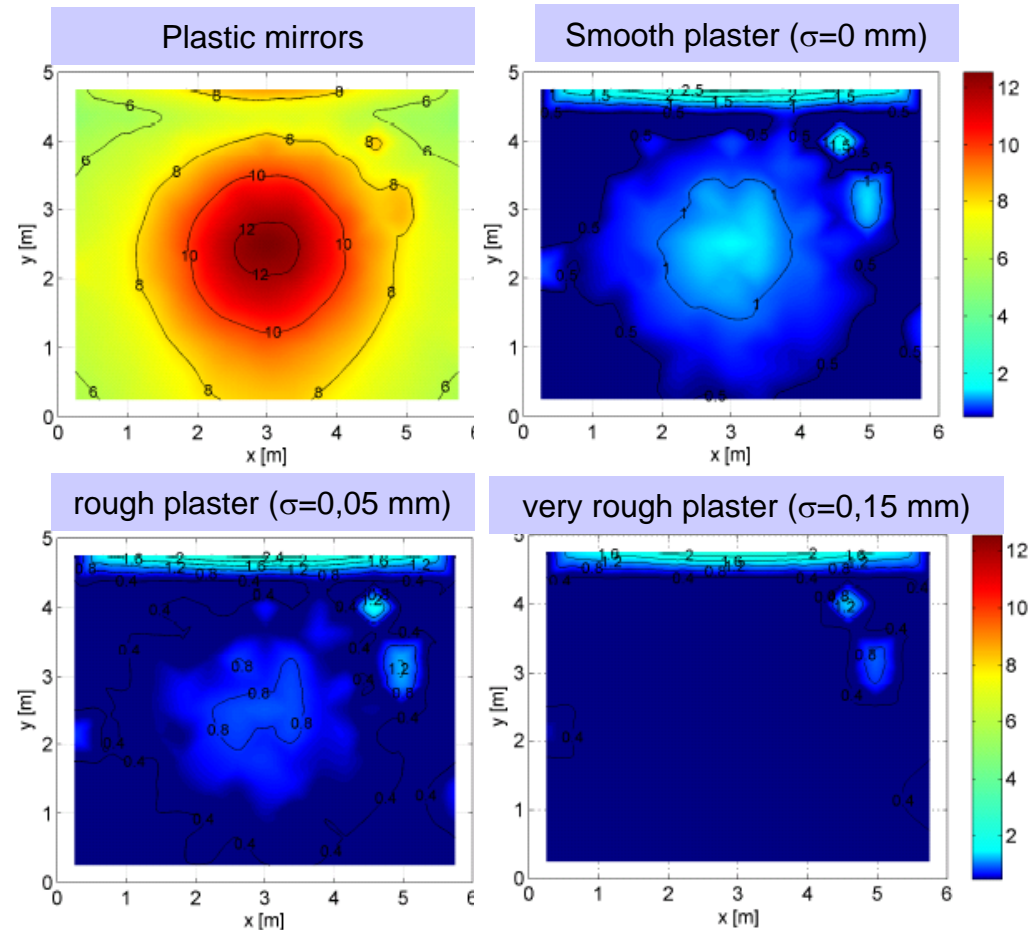

Influence of Antenna Gains

Data Rate [Gbit/s] for once reflected paths (non coherent ASK)

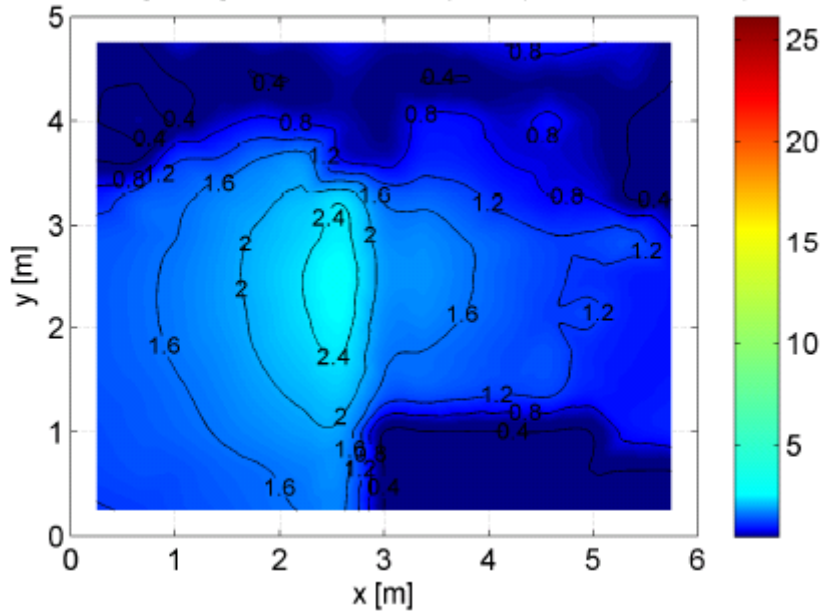

G= 30 dB

Data Rate [Gbit/s] for once reflected paths (non coherent ASK)

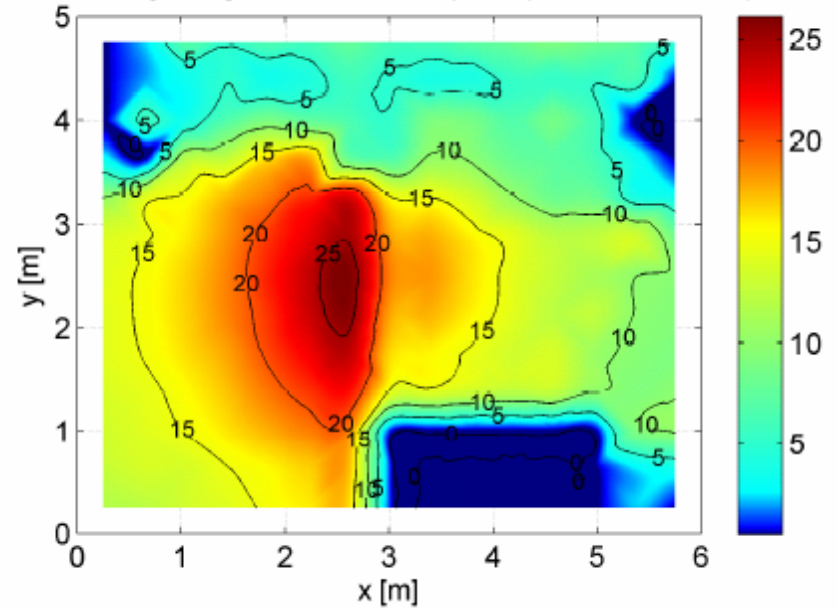

G= 35 dB

300 GHz Transmission at PTB

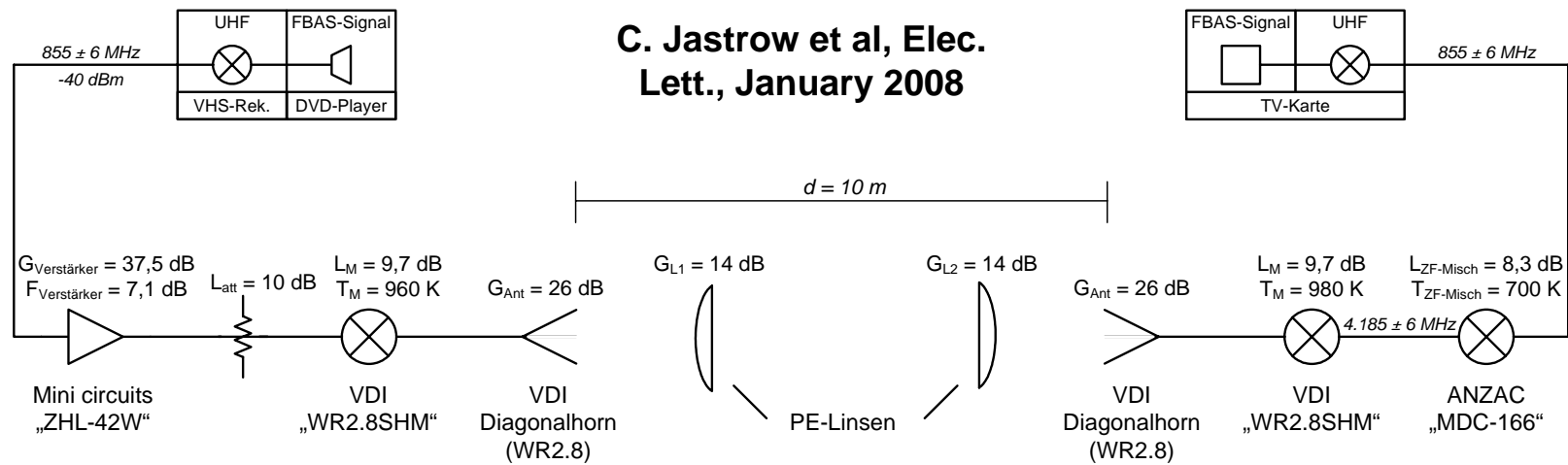

TV signal, transmitted over a distance of 10 m

...more details on the mixer

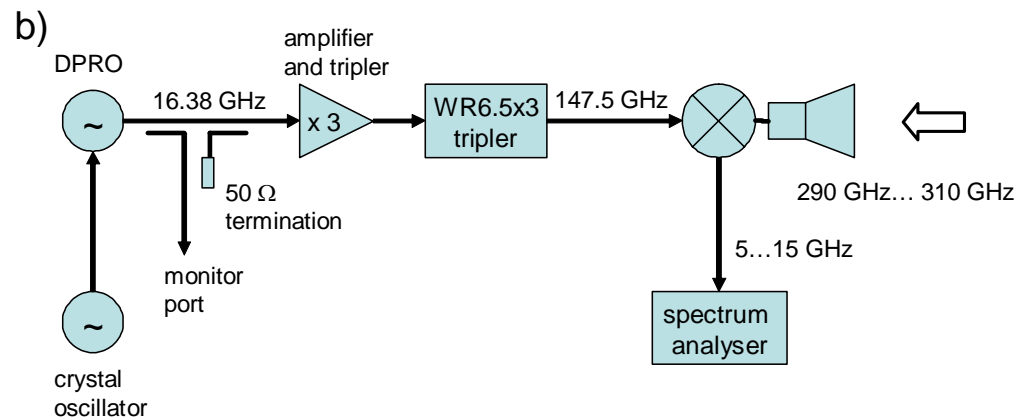
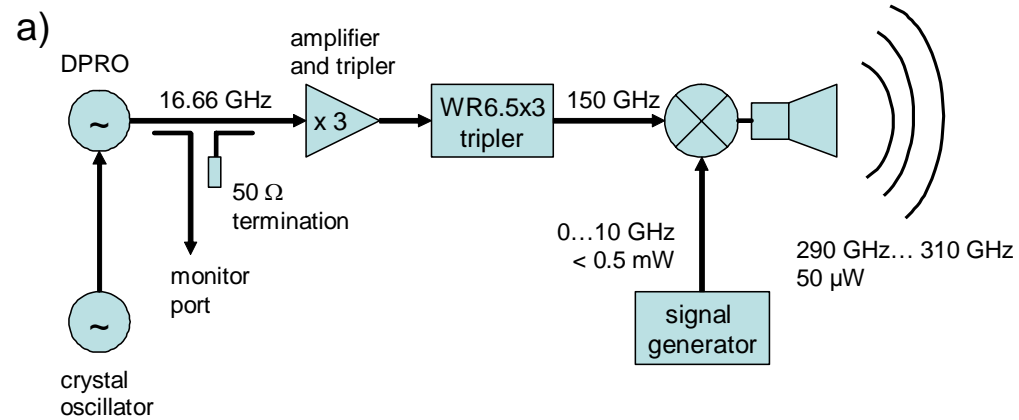

Transmitter

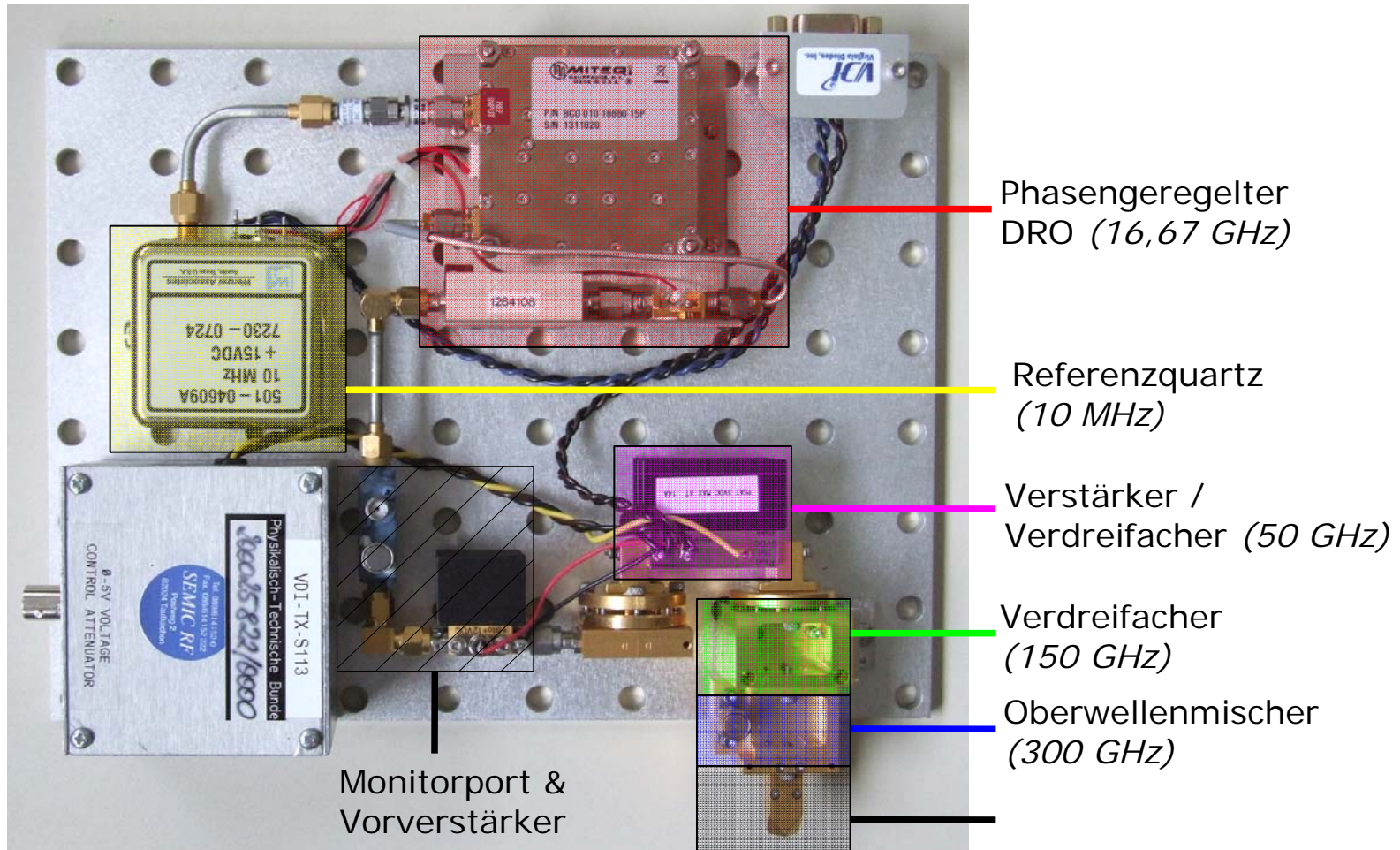

Free-space transmission of video

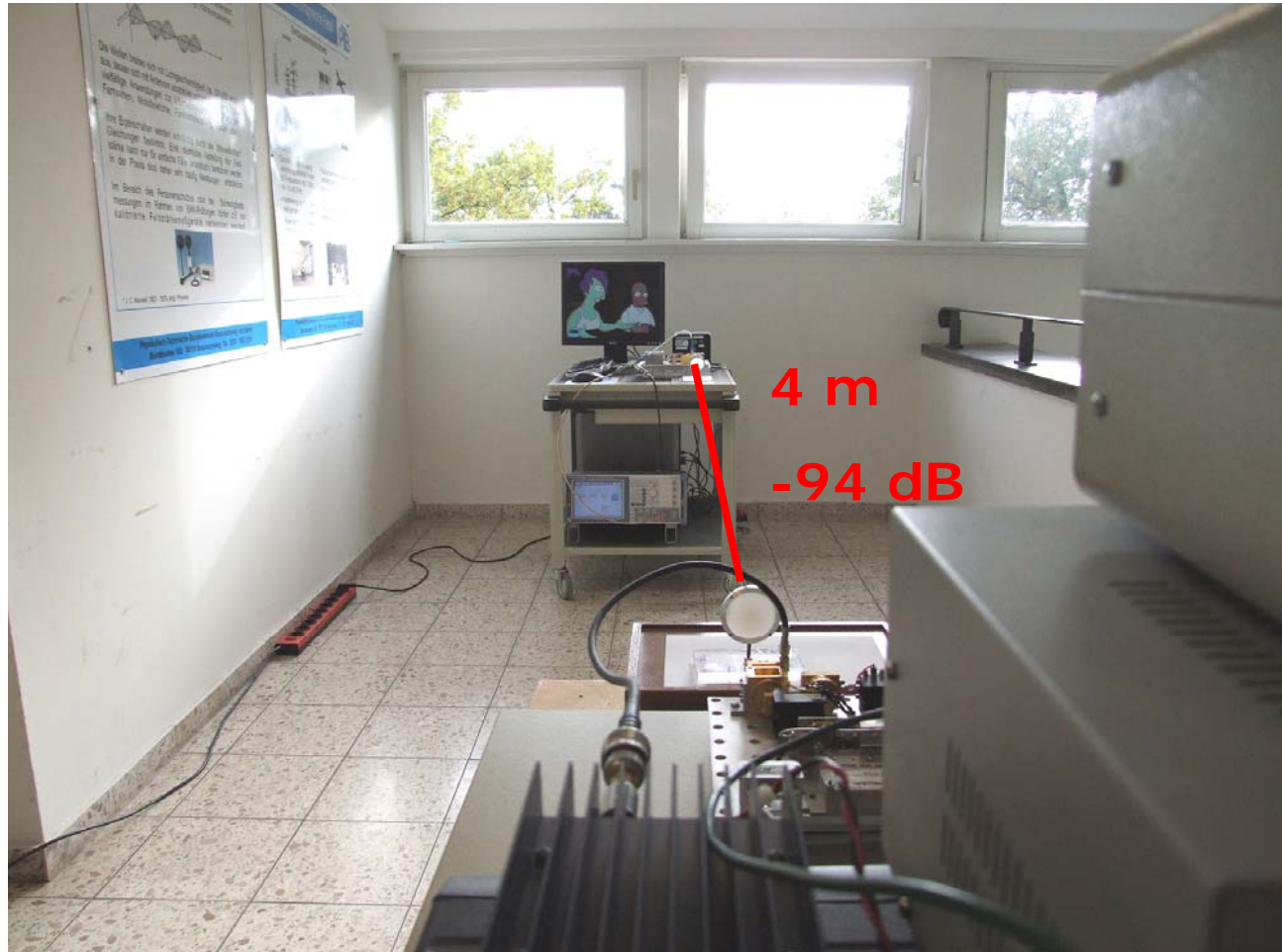

Received signal without lense antennas

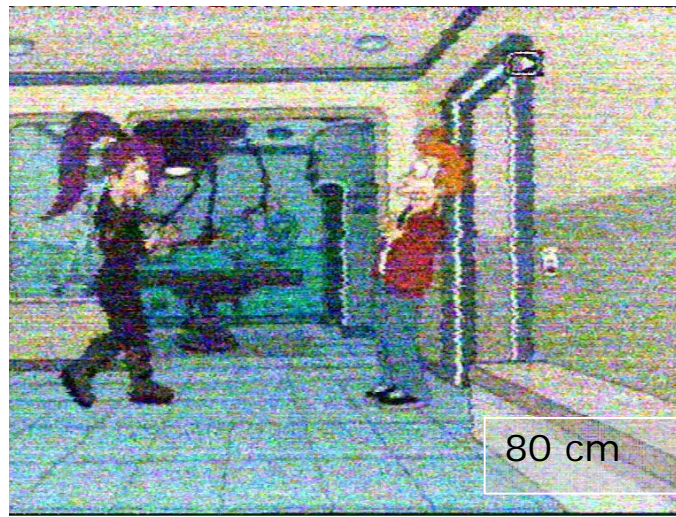
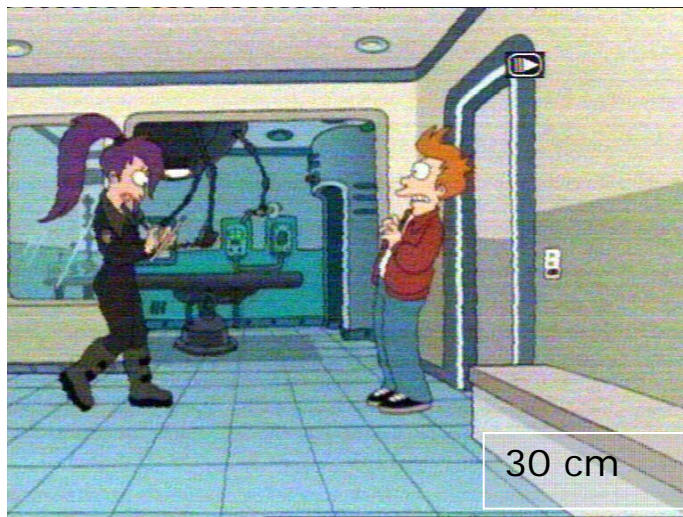

Received signal with lense antennas

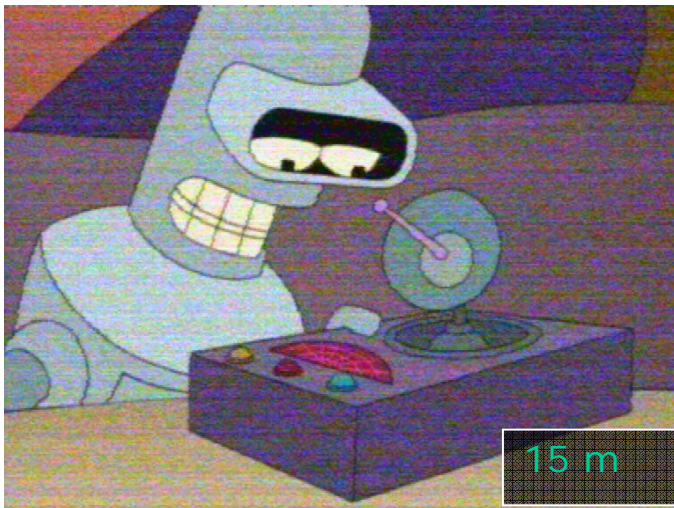
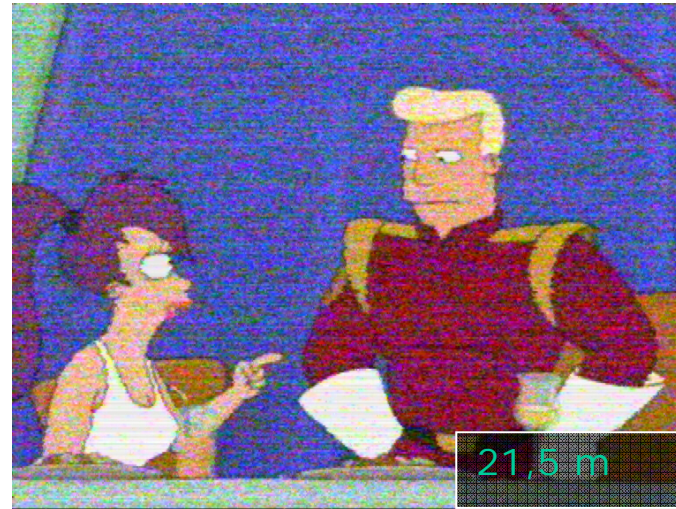

Measurement Equipment at TCL

- Network analyzer/spectrum analyzer
- 300 GHz Tx/Rx-System
- 325 GHz Receiver
- THz Time domain spectrometer



Receiver front end for
325 GHz in waveguide technology

THz Communication – Future Tasks at TCL

- Power measurements
 - Coverage map (power) for indoor scenarios
- Channel measurements for realistic scenarios
 - Full knowledge of channel
- Verification of Ray tracing simulations with these measurements
- FPGA test bed for BER-measurements
 - Goal is HDTV-transmission with 1.5 Gbps
- Contributions to WRC 2011 to make sure spectrum for THz communication will be still available
 - Membership in the national WRC 2011 preparatory group of Germany

„The race is on“

- **First 60 GHz „point-to point“- Systems are appearing**
- **NTT has shown a 120 GHz „ point-to-point“ system**
- **Why should 300 GHz Systems not exist in 12-15 years?!**

Summary

- *Future need for xxGbps radio systems*
- *Frequency range above 300 GHz well suited*
- *Bottom-up approach for hardware*
- *Application: Indoor communications*
- *Investigation of the radio channel at 300 GHz*
- *300 GHz demonstrator*

The THz frequency range has a big potential for wireless communication

Contact Details

Prof. Dr.-Ing. Thomas Kürner
Institut für Nachrichtentechnik
Terahertz Communications Lab
Technische Universität Braunschweig
Schleinitzstr. 22
D-38092 Braunschweig
Tel.: +49 531 391 2416
Fax: +49 531 391 5192
E-Mail: t.kuerner@tu-bs.de
<http://www.ifn.ing.tu-bs.de/en/ms/kuerner/>
<http://www.tcl.tu-bs.de>