

Project: IEEE P802.15 Working Group for Wireless Personal Area Networks (WPANs)

Submission Title: [Unified and flexible millimeter wave WPAN systems supported by common mode]

Date Submitted: [November 12, 2007]

Source: [Hiroshi Harada (representative contributor), other contributors are listed in “Contributors” slides]

Company [National Institute of Information and Communications Technology (NICT), other contributors are listed in “Contributors” slides]

Address¹[3-4 Hikari-no-oka, Yokosuka-shi, Kanagawa 239-0847, Japan]

Voice:[+81-46-847-5074]

FAX: [+81-46-847-5440]

E-Mail:[harada@nict.go.jp (other contributors are listed in “Contributors” slides)]

Re: [In response to TG3c Call for Proposals (IEEE P802.15-07-0586-02-003c)]

Abstract: [Proposal of unified and flexible millimeter wave WPAN systems supported by common mode]

Purpose: [To be considered in TG3C baseline document.]

Notice: This document has been prepared to assist the IEEE P802.15. It is offered as a basis for discussion and is not binding on the contributing individual(s) or organization(s). The material in this document is subject to change in form and content after further study. The contributor(s) reserve(s) the right to add, amend or withdraw material contained herein.

Release: The contributors acknowledge and accept that this contribution becomes the property of IEEE and may be made publicly available by P802.15.

Unified and flexible millimeter wave WPAN systems supported by common mode

Nov 12, 2007

Contributors (1/4)

Name	Affiliation	E-mail
Hiroshi Harada	NICT	harada@nict.go.jp
Yozo Shoji	NICT	shoji@nict.go.jp
Fumihide Kojima	NICT	f-kojima@nict.go.jp
Ryuhei Funada	NICT	funada@nict.go.jp
Ming Lei	NICT	minglei@nict.go.jp
Yoshinori Nishiguchi	NICT	nishiguchi@nict.go.jp
Ryota Kimura	NICT	r.kimura@nict.go.jp
Pyo Chang-Woo	NICT	cwpyo@nict.go.jp
Zhou Lan	NICT	lan@nict.go.jp
Chin-Sean Sum	NICT	sum@nict.go.jp
Tuncer Baykas	NICT	tuncerbaykas@nict.go.jp
Masahiro Umehira	NICT	umehira@mx.ibaraki.ac.jp
Shuzo Kato	NICT	shu.kato@nict.go.jp
Akio Iso	NICT	Akio.Iso@nict.go.jp
Hiroyo Ogawa	NICT	hogawa@nict.go.jp
Kenichi Kawasaki	Sony Corp.	Kenichi.Kawasaki@jp.sony.com
Makoto Noda	Sony Corp.	MakotoB.Noda@jp.sony.com
Hiroyuki Yamagishi	Sony Corp.	Hiroyuki.Yamagishi@jp.sony.com
Masashi Shinagawa	Sony Corp.	Masashi.Shinagawa@jp.sony.com
Keitarou Kondou	Sony Corp.	Keitarou.Kondou@jp.sony.com
Kazuaki Takahashi	Matsushita Electric Ind. Co., Ltd.	takahashi.kazu@jp.panasonic.com
Hiroyuki Nakase	Tohoku University	nakase@riec.tohoku.ac.jp
Ichihiko Toyoda	NTT Corp.	toyoda.ichihiko@lab.ntt.co.jp
Ichirou Ida	Fujitsu Limited	Ida.ichirou@jp.fujitsu.com
Yasuyuki Ooishi	Fujitsu Limited	yasu@labs.fujitsu.com

Contributors (2/4)

Name	Affiliation	E-mail
Tomohiro Seki	NTT Corp.	seki.tomohiro@lab.ntt.co.jp
Kaoru Yokoo	Fujitsu Limited	yokoo@labs.fujitsu.com
Taisuke Matsumoto	Matsushita Electric Ind. Co.,Ltd.	matsumoto.taisuke@jp.panasonic.com
Raymond Yu Zhan	Panasonic Singapore Laboratories	Raymond.Yuz@sg.panasonic.com
Michael Sim	Panasonic Singapore Laboratories	Michael.Simhc@sg.panasonic.com
Huang Lei	Panasonic Singapore Laboratories	Lei.Huang@sg.panasonic.com
Yukimasa Nagai	Mitsubishi Electric Corp.	Nagai.Yukimasa@ds.MitsubishiElectric.co.jp
Takahisa Yamauchi	Mitsubishi Electric Corp.	Yamauchi.Takahisa@cw.MitsubishiElectric.co.jp
Akinori Fujimura	Mitsubishi Electric Corp.	Fujimura.Akinori@dw.MitsubishiElectric.co.jp
Hideto Ikeda	Oki Electric Industry Co., Ltd.	ikeda637@oki.com
Tadahiko Maeda	Oki Electric Industry Co., Ltd.	maeda097@oki.com
Masamune Takeda	MASPRO DENKOH Corp.	takeda3026@maspro.co.jp
Hiroyoshi Konishi	MASPRO DENKOH Corp.	konishi2761@maspro.co.jp
Shoichi Kitazawa	ATR	kitazawa@atr.jp
Masazumi Ueba	ATR	ueba@atr.jp
Amane Miura	ATR	amane@atr.jp
Kenichi Maruhashi	NEC Corp.	k-maruhashi@bl.jp.nec.com
Yoshitsugu Fujita	KYOCERA Corp.	yoshitsugu.fujita.gt@kyocera.jp
Hiroshi Uchimura	KYOCERA Corp.	hiroshi.uchimura.hs@kyocera.jp
Makoto Ando	Tokyo Institute of Technology	mando@antenna.ee.titech.ac.jp
Jiro Hirokawa	Tokyo Institute of Technology	jiro@antenna.ee.titech.ac.jp
Junichi Takada	Tokyo Institute of Technology	takada@ide.titech.ac.jp
Takuichi Hirano	Tokyo Institute of Technology	hira@antenna.ee.titech.ac.jp
Yoshio Aoki	Eudyna Devices Inc	y.aoki@eudyna.com
Kazufumi Igarashi	Japan Radio Co., Ltd.	igarashi.kazufumi@jrc.co.jp
Tsukasa Yoneyama	EMMEX, INC.	yoneyama@tohtech.ac.jp
Yukihiro Shimakata	TAIYO YUDEN Co., LTD.	y-shima@jty.yuden.co.jp
Shoji Kuriki	RICOH COMPANY, LTD.	shoji.kuriki@nts.ricoh.co.jp
Toyoo Tanaka	Toyo System Engineering Co., Ltd.	toyoo_tanaka@u-tse.co.jp

Contributors (3/4)

Name	Affiliation	E-mail
Bruce Bosco	Motorola, Inc.	Bruce.A.Bosco@Motorola.com
Paul Gorday	Motorola, Inc.	Paul.Gorday@Motorola.com
Tian-Wei Huang	National Taiwan University	twhuang@cc.ee.ntu.edu.tw
Ching-Kuang Tzuang	National Taiwan University	cktzuang@cc.ee.ntu.edu.tw
Juinn-Horng Deng	CSIST Co.	jh.deng@nsa.hinet.net
Yu-Min Chuang	CSIST Co.	ymchuang@cml.hinet.net
André Bourdoux	IMEC	bourdoux@imec.be
Jimmy Nsenga	IMEC	nsengaj@imec.be
Wim Van Thillo	IMEC	vthillo@imec.be
Stefaan De Rore	IMEC	derore@imec.be
Pascal Pagani	France Telecom	pascal.pagani@orange-ftgroup.com
Isabelle Siaud	France Telecom	isabelle.siaud@orange-ftgroup.com
Wei Li	France Telecom	wei3.li@orange-ftgroup.com
Anne-Marie Ulmer-Moll	France Telecom	annemarie.ulmermoll@orange-ftgroup.com
Marie-Hélène Hamon	France Telecom	mhelene.hamon@orange-ftgroup.com
Maxim Piz	IHP	piz@ihp-microelectronics.com
Eckhard Grass	IHP	grass@ihp-microelectronics.com
Klaus Tittelbach	IHP	tittelbach@ihp-microelectronics.com
Frank Herzel	IHP	herzel@ihp-microelectronics.com
Alberto Valdes Garcia	IBM	avaldes@us.ibm.com
Troy Beukema	IBM	troyb@us.ibm.com
Yasunamo Katayama	IBM	yasunaok@jp.ibm.com
Brian Floyd	IBM	brianfl@us.ibm.com
Scott Reynolds	IBM	skreyn@us.ibm.com
Daiju Nakano	IBM	dnakano@jp.ibm.com
AbbieMathew	New LANs	amathew@newlans.com

Contributors (4/4)

Name	Affiliation	E-mail
Seongsoo Kim	Samsung Electronics Co., Ltd.	seongsoo1.kim@samsung.com
Edwin Kwon	Samsung Electronics Co., Ltd.	cy.kwon@samsung.com
Chiu Ngo	Samsung Electronics Co., Ltd.	chiu.ngo@samsung.com
Huaning Niu	Samsung Electronics Co., Ltd.	huaning.niu@samsung.com
Jisung Oh	Samsung Electronics Co., Ltd.	jisung0714.oh@samsung.com
Sandra Qin	Samsung Electronics Co., Ltd.	x.qin@samsung.com
Huai-Rong Shao	Samsung Electronics Co., Ltd.	hr.shao@samsung.com
Harkirat Singh	Samsung Electronics Co., Ltd.	har.singh@samsung.com
Pengfei Xia	Samsung Electronics Co., Ltd.	pengfei.xia@samsung.com
Su-Khiong Yong	Samsung Electronics Co., Ltd.	ysk@ieee.org
Dagnachew Birru	Philips	dagnachew.birru@philips.com
Richard Chen	Philips	richard.chen@philips.com
Chun-Ting Chou	Philips	chun-ting.chou@philips.com
Ciaran Connell	Decawave	ciaran.connell@decawave.com
Seungsik Eom	Korea University	drdja@korea.ac.kr
Brian Gaffney	Decawave	brian.gaffney@decawave.com
Jinkyong Kim	ETRI	jdkim@etri.re.kr
Yongsun Kim	ETRI	doori@etri.re.kr
Kyeongpyo Kim	ETRI	kpkim@etri.re.kr
Hyoungjin Kwon	ETRI	kwonjin@etri.re.kr
Young-Chai Ko	Korea University	koyc@korea.ac.kr
Joy Laskar	GEDC	joy.laskar@ece.gatech.edu
Wooyong Lee	ETRI	wylee@etri.re.kr
Michael Mc Laughlin	Decawave	michael@decawave.com
Stephane Pinel	GEDC	pinel@ece.gatech.edu
Alireza Seyedi	Philips	alireza.seyedi@philips.com
Hong Zhai	Philips	hong.zhai@philips.com
Arthur W. Astrin	Astrin Radio Artisty	art@astrinradio.com

What have changed from Hawaii meeting

- Tensorcom proposal (07/760r2) has merged with CoMPA and partners proposal (07/761r10)

What have been updated from Hawaii meeting (1/3)

1. Channel plan (refer Appendix 1)

- Full rate channel plan
 - Nyquist bandwidth: **1728** MHz (1632 MHz previously)
 - Supporting common mode with data rate of **50.2**Mbps, as well as LRs, MRs, and HRs with data rates of up to **6026** Mbps in SC mode
- Half rate channel plan
 - Nyquist bandwidth: **864** MHz (from 806MHz previously)
 - Supporting LRTs with several data rates of up to **1506** Mbps using $\pi/2$ BPSK (RS(255,239)) in SC mode

2. Modulation and coding scheme (refer Appendix 2)

- 4 categories for SC mmWavePHY
 - **Common Rate (CR)**: Mandatory rate for all devices in SC mode and PNC-capable OOK and OFDM devices.
 - **Mandatory Low Rate (MLR)**: Mandatory data transmission rate for all devices in SC mode and PNC-capable OOK and OFDM devices
 - **Low Rate (LR)**: Data rate at PHY-SAP < 2 Gbps (**18 classes in total**)
 - **Medium Rate (MR)**: 2Gbps < Data rate at PHY-SAP < 3 Gbps Gbps (**4 classes in total**)
 - **High Rate (HR)**: Data rate at PHY-SAP > 3 Gbps (**15 classes in total**)
 - **SC OOK (SCOOK)**: Supporting OOK-capable devices (**4 classes in total**)

What have been updated from Hawaii meeting (2/3)

3. PHY header (refer Appendix 3)

- **10** octets (5 octets previously)
- Added bits
 - Time stamp– **24** bits
 - Burst type – **1** bit
 - PWCP mode – **2** bits
 - PCES mode – **2** bits
 - Preamble type – **2** bits
 - To indicate long , middle or short preamble for the next frame
 - IFS mode – **2** bits
 - Burst mode– **1** bit
 - Subblock size: 256 symbols (mandatory), 512 symbols (option)
 - Reserved bits **10** bits added (**16 bits in total**)
- Removed bits
 - UEP information – **2** bits
 - Aggregation bit – **1** bit
 - Number of subframes – **1** bit removed (4 bits remain in total, previously 5 bits)
- PLCP header
 - **22** octets (17 octets previously)

What have been updated from Hawaii meeting (3/3)

4. Configuration of preamble (refer Appendix 4)

- SYNC in long preamble
 - 36 'repetition' (32 previously) of Golay code of 128 chips
- SYNC in midium preamble (original short preamble)
 - 20 'repetition' (8 previously) of Golay code of 128 chips
- SYNC in short preamble (added)
 - 12 'repetition' of Golay code of 128 chips:

5. Frame format (refer Appendix 5)

- SubBlock size: 256 symbols as mandatory, or 512 symbols as option (including data symbols and pilot symbols)
- Cyclic prefix pilot symbol (CPPS) length
 - : 16, 0, 32, or 64 symbols with subBlock of 256 symbols
 - : 32, 64, 96, or 128 symbols with subBlock of 512 symbols (option)
- Sequence for CPPS
 - Golay code a in all of the lengths (96 symbols is the combination of a_{32} and a_{64})
- Pilot channel estimation sequence (PCES) added
 - Role of PCES
 - (a) Timing tracking, (b) Compensation for clock drift, and (c) Compensation for frequency offset error that resides after fine AFC and that caused by phase noise in LOS environment
 - PCES length : 768 , 1536 (symbol)
 - PCES period : 8192, 16384, or 32768 or 131072 (symbol)

Common mode and mandatory mode

- Common mode is a base rate single carrier (SC) transmission mode which is mandatory for all devices except non-PNC capable OOK devices
- The Common mode serves as a bridge for coexistence of SC and OFDM, and simultaneously plays the role as the fallback mode with the most robust performance and transmission range of **10m** with minimum link margin of **9.42dB in LOS channel** and **0.25dB in NLOS channel**
- PHY parameters for Common mode
 - Payload - $\pi/2$ BPSK and Reed Solomon (RS) (255, 239) and Golay code of **64 chips** (its spreading factor (SF) is equivalent to 32)
 - Header - **$\pi/2$ BPSK and RS (38, 22)** and Golay code of **64 chips** (equivalent spreading factor (SF) of 32)
 - Preamble: long preamble
 - SYNC
 - **36 'repetition'** of Golay code of 128 chips
 - Channel estimation (CE)
 - 4 'repetition' of Golay code of 256 chips
- **Based on the requirement in PAR that mandates the data rate of 1Gbps, LR 13 with $\pi/2$ BPSK and RS(255, 239) is set as the mandatory mode for all SC and OFDM devices**

Appendix

Appendix 1(1/2):Full-rate (2GHz) Channel Plan

Channel Number	Low Freq. (GHz)	Center Freq. (GHz)	High Freq. (GHz)	Nyquist BW (MHz)	Roll-Off Factor
A1	57.240	58.320	59.400	1728	0.25
A2	59.400	60.480	61.560	1728	0.25
A3	61.560	62.640	63.720	1728	0.25
A4	63.720	64.800	65.880	1728	0.25

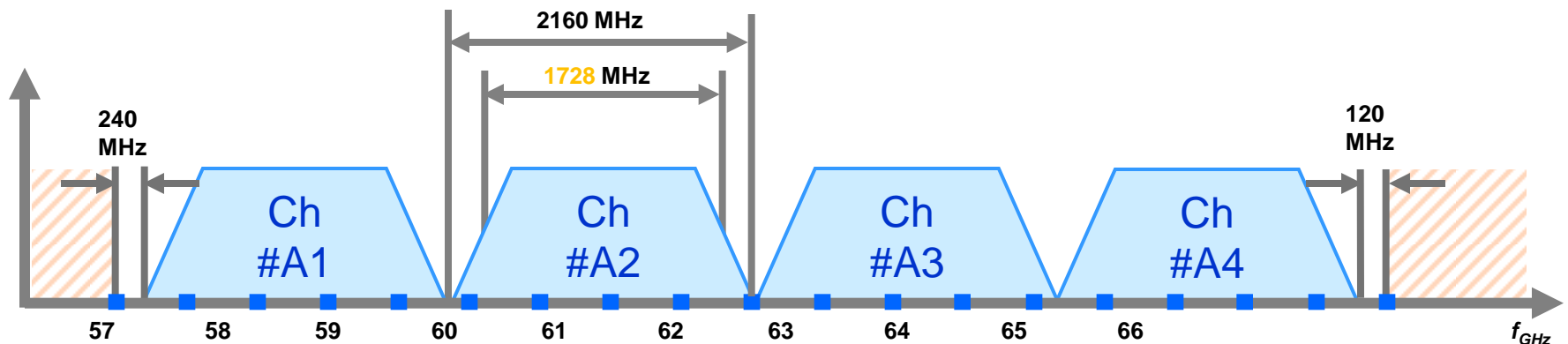

Appendix 1(2/2):Half-rate (1GHz) Channel Plan

Channel Number	Low Freq. (GHz)	Center Freq. (GHz)	High Freq. (GHz)	Nyquist BW (MHz)	Roll-Off Factor
B1	57.78	58.32	58.86	864	0.25
B2	59.94	60.48	61.02	864	0.25
B3	62.10	62.64	63.18	864	0.25
B4	64.26	64.80	65.34	864	0.25

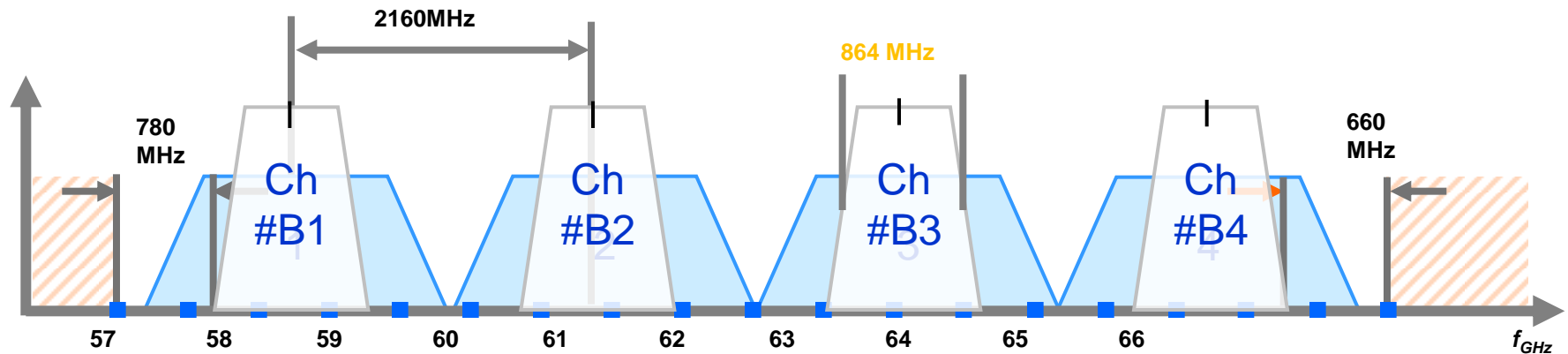

Appendix 2(1/2): SC mode (CR, MLR,MR)

MCS Class	MCS Identifier	Data Rate (Mbps)	Synbol/Chip Rate (Msps/cps)	Modulation Scheme	Spreading Code Length	FEC Type	FEC Rate	Pilot Word Length (symbols/chips)	Burst Length (symbols/chips)
CR	CR (LR1)	50.2	1728	$\pi/2$ -BPSK/(G)MSK*	32	RS(255,239)	0.937	0	256
MLR	MLR(LR13)	1506.6	1728	$\pi/2$ -BPSK/(G)MSK	1	RS(255,239)	0.937	16	256
LR	LR1 (CR)	50.2	1728	$\pi/2$ -BPSK/(G)MSK	32	RS(255,239)	0.937	0	256
	LR2	188.3	1728	$\pi/2$ -BPSK/(G)MSK	8	RS(255,239)	0.937	16	256
	LR3	376.6	1728	$\pi/2$ -BPSK/(G)MSK	4	RS(255,239)	0.937	16	256
	LR4	401.9	1728	$\pi/2$ -BPSK/(G)MSK	2	LDPC(576,288)	0.500	16	256
	LR5	401.9	1728	$\pi/2$ -BPSK/(G)MSK	2	CC(R=1/2,K=5)	0.500	16	256
	LR6	602.8	1728	$\pi/2$ -BPSK/(G)MSK	2	LDPC(576,432)	0.750	16	256
	LR7	703.3	1728	$\pi/2$ -BPSK/(G)MSK	2	LDPC(576,504)	0.875	16	256
	LR8	753.3	1728	$\pi/2$ -BPSK/(G)MSK	2	RS(255,239)	0.937	16	256
	LR9	803.7	1728	$\pi/2$ -BPSK/(G)MSK	1	LDPC(576,288)	0.500	16	256
	LR10	1071.6	1728	$\pi/2$ -BPSK/(G)MSK	1	CC(R=2/3,K=5)	0.667	16	256
	LR11	1205.6	1728	$\pi/2$ -BPSK/(G)MSK	1	LDPC(576,432)	0.750	16	256
	LR12	1406.5	1728	$\pi/2$ -BPSK/(G)MSK	1	LDPC(576,504)	0.875	16	256
	LR13 (MLR)	1506.6	1728	$\pi/2$ -BPSK/(G)MSK	1	RS(255,239)	0.937	16	256
	LR14	1506.6	1728	Dual Rail Bipolar	2	RS(255,239)	0.937	16	256
	LR15	1607.4	1728	$\pi/2$ -QPSK	1	LDPC(576,288)	0.500	16	256
	LR16	1607.4	1728	$\pi/2$ -QPSK	1	LPDC(576,288)	0.500	16	256
	LR17	376.6	864	$\pi/2$ -BPSK/(G)MSK	2	RS(255,239)	0.937	16	256
	LR18	1506.6	864	$\pi/2$ -QPSK	1	RS(255,239)	0.937	16	256
MR	MR1	2143.3	1728	$\pi/2$ -QPSK	1	CC(R=2/3,K=5)	0.667	16	256
	MR2	2411.2	1728	$\pi/2$ -QPSK	1	LDPC(576,432)	0.750	16	256
	MR3	2806.6	1728	$\pi/2$ -Star 8QAM	1	CC(R=2/3,K=4) & RS(63,55)	0.582	16	256
	MR4	2813.0	1728	$\pi/2$ -QPSK	1	LDPC(576,504)	0.875	16	256

Appendix 2(2/2): SC mode (HR,SCOOK)

MCS Class	MCS Identifier	Data Rate (Mbps)	Symbol/Chip Rate (Mpsps/Mcps)	Modulation Scheme	Spreading Code Length	FEC Type	FEC Rate	Pilot Word Length (symbols/chips)	Burst Length (symbols/chips)
HR	HR1	3000.6	1728	$\pi/2$ -QPSK	1	LDPC(1440,1344)	0.933	16	256
	HR2	3013.2	1728	$\pi/2$ -QPSK	1	RS(255,239)	0.937	16	256
	HR3	3013.2	1728	Dual Rail Bipolar	1	RS(255,239)	0.937	16	256
	HR4	3214.9	1728	$\pi/2$ -NS8QAM	1	TCM(R=1/2,K=5)	0.667	16	256
	HR5	3214.9	1728	Dual Rail Bipolar	1	Uncoded	1.000	16	256
	HR6	3616.7	1728	$\pi/2$ -8PSK	1	LDPC(576,432)	0.750	16	256
	HR7	4210.0	1728	$\pi/2$ -Star 8QAM	1	RS(63,55)	0.873	16	256
	HR8	4219.5	1728	$\pi/2$ -8PSK	1	LDPC(576,504)	0.875	16	256
	HR9	4500.8	1728	$\pi/2$ -8PSK	1	LDPC(1440,1344)	0.933	16	256
	HR10	4519.7	1728	$\pi/2$ -8PSK	1	RS(255,239)	0.937	16	256
	HR11	4519.7	1728	$\pi/2$ -NS8QAM	1	RS(255,239)	0.937	16	256
	HR12	4822.3	1728	$\pi/2$ -16QAM	1	TCM(R=2/3,K=5)	0.750	16	256
	HR13	4822.3	1728	$\pi/2$ -16QAM	1	LDPC(576,432)	0.750	16	256
	HR14	5626.0	1728	$\pi/2$ -16QAM	1	LDPC(576,504)	0.875	16	256
	HR15	6026.3	1728	$\pi/2$ -16QAM	1	RS(255,239)	0.937	16	256
SC OOK	SCOOK1	50.2	1728	OOK	32	RS(255,239)	0.937	0	256
	SCOOK2	376.6	1728	OOK	4	RS(255,239)	0.937	16	256
	SCOOK3	753.3	1728	OOK	2	RS(255,239)	0.937	16	256
	SCOOK4	1506.6	1728	OOK	1	RS(255,239)	0.937	16	256

Appendix 3: PHY header (1/2)

- PHY header (**10 octets**) contains

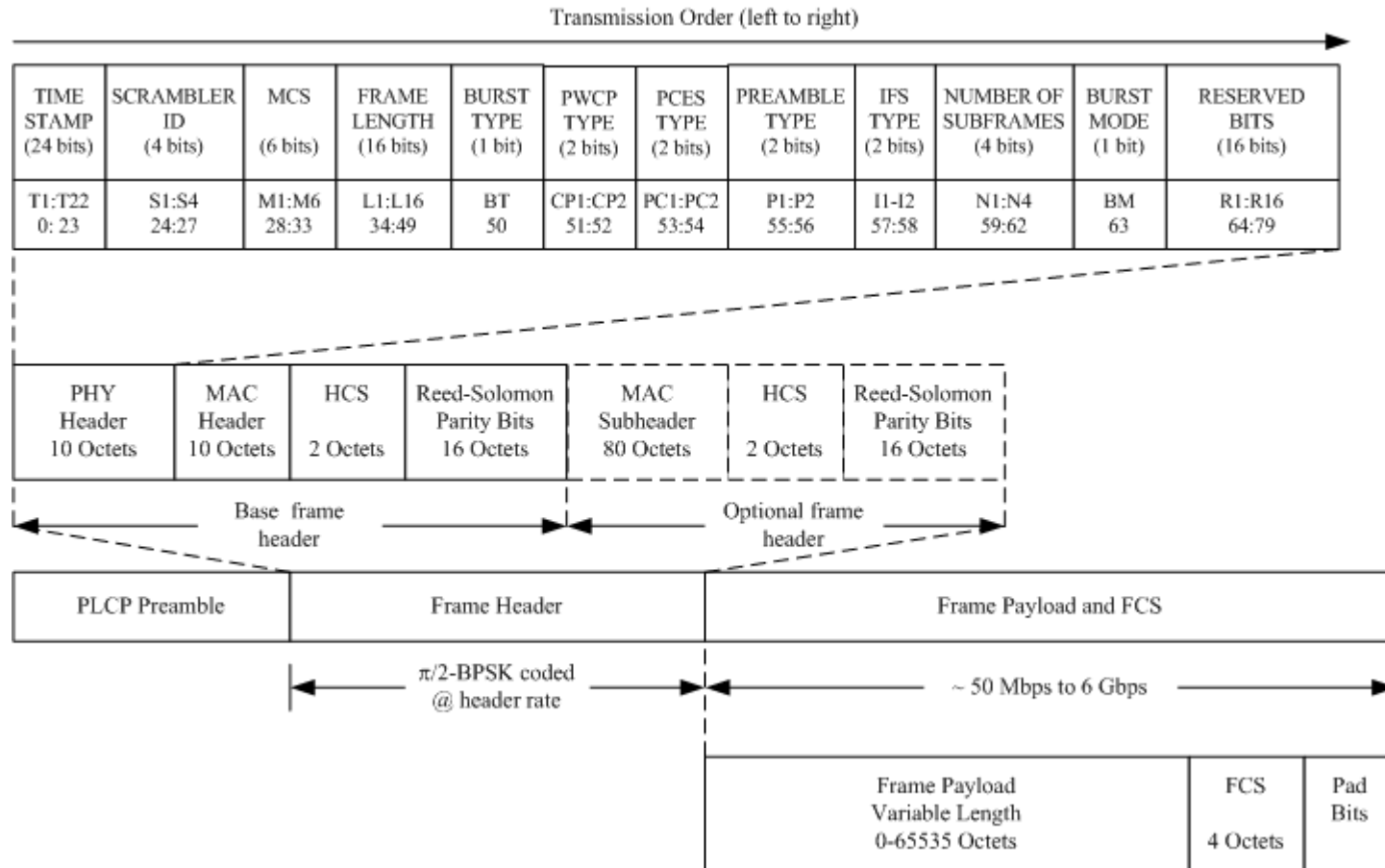

Appendix 3: PHY header (2/2)

- An encoding process-

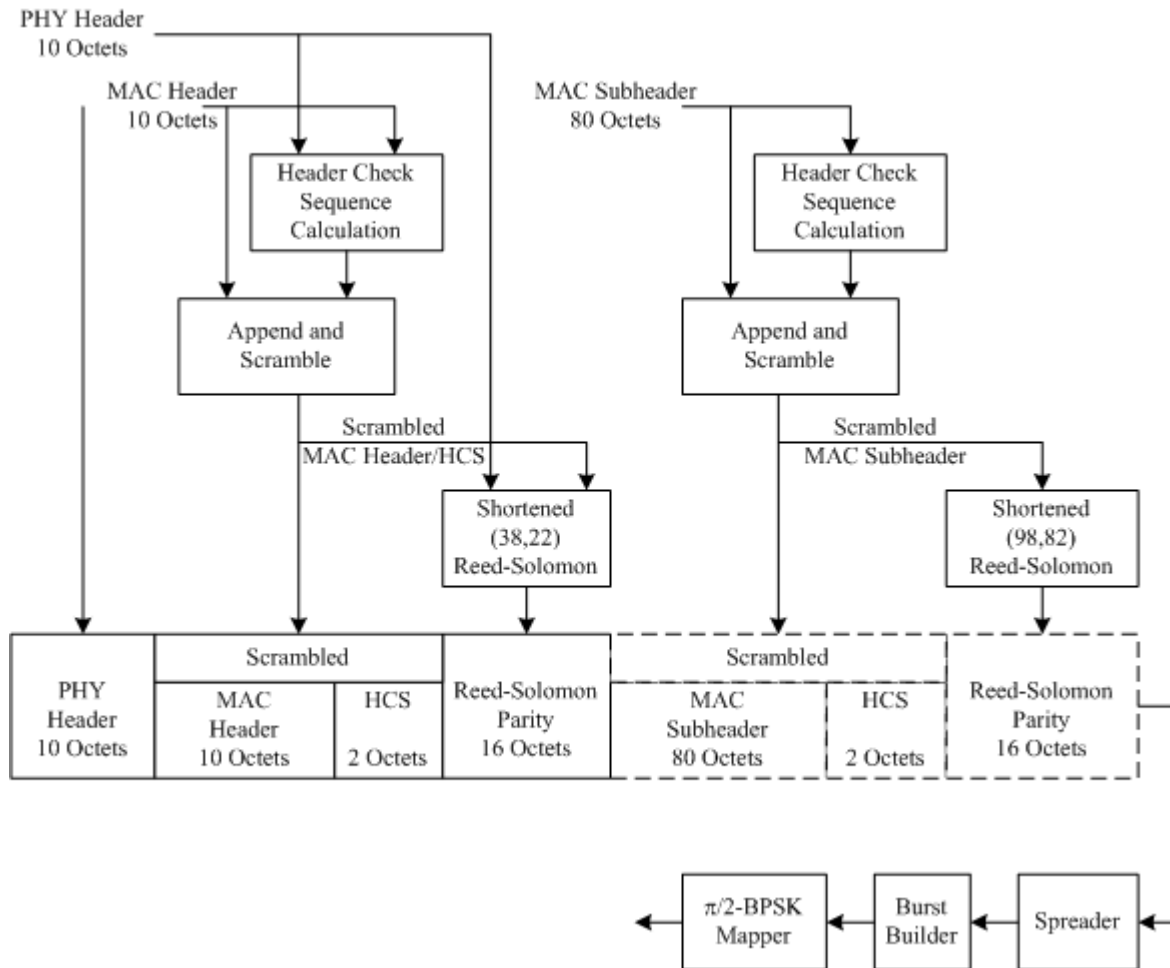

Appendix 4: Preamble structure

- Three types of preamble, i.e., **long**, **middle**, and **short** preambles, can be used for each transmission mode
- The preambles can be selected according to the information included in PHY header
- The preambles consist of sequences for synchronization (SYNC) and channel estimation (CE)
 - SYNC in long preamble
 - **36** 'repetition' of Golay code of 128 chips
 - SYNC in middle preamble (original short preamble)
 - **20** 'repetition' of Golay code of 128 chips
 - SYNC in short preamble (added)
 - **12** 'repetition' of Golay code of 128 chips
 - CE in both preamble
 - **4** repetition of Golay code of 256 chips: used for CE and fine AFC
 - [a] and [b] are Golay codes and complimentary pairs of each other
 - [a₂₅₆] and [b₂₅₆] : Golay codes of 256@ 1.728 Gcps
 - [a'] is a copy of last half part of [a₂₅₆], and [a''] is a copy of first half part of [a₂₅₆]
 - [b₂₅₆][b'] [b''] is set to the same manners as [a₂₅₆][a][a'']

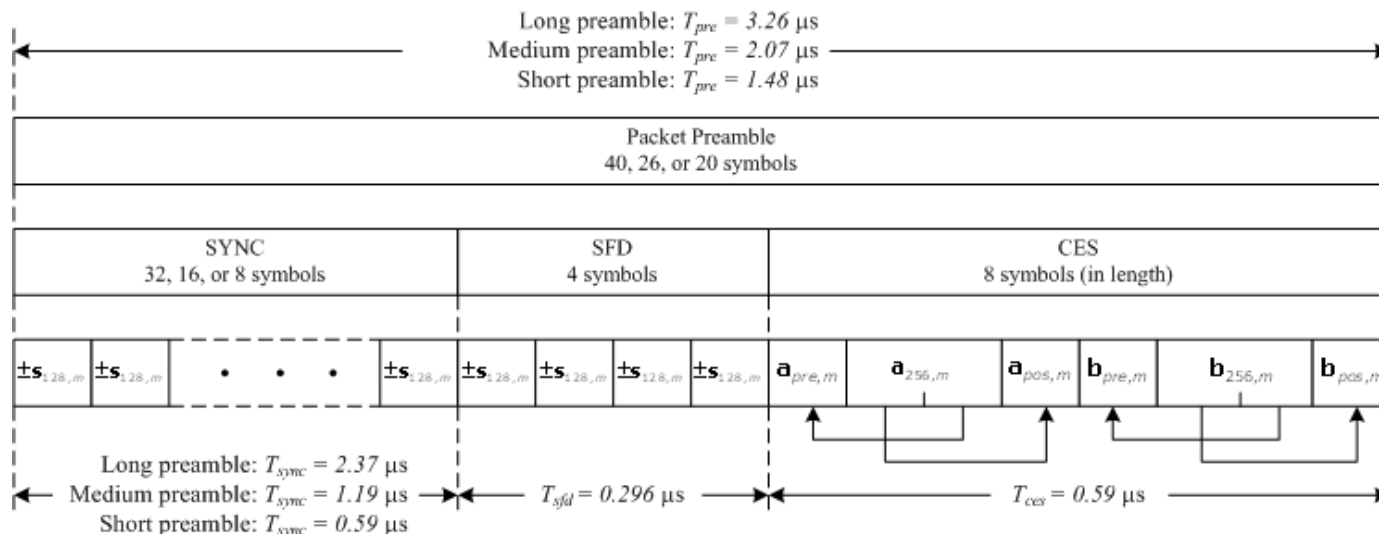

Appendix 5: PLCP and Payload format (1/3)

- PLCP and frame payload are independently segmented into subBlocks, with Golay code-based **cyclic prefix pilot symbols (CPPS)** and/or **pilot channel estimation sequence (PCES)** inserted in between subBlocks
 - SubBlock size: **256 symbols as mandatory, or 512 symbols as option** (including data symbols and pilot symbols)
 - CPPS length: 0, 16, 32, or 64 symbols with SC Data Burst of 256 symbols
: 32, 64, 96, or 128 symbols with SC Data Burst of 512 symbols (option)
 - Sequence for CPPS
 - Golay code **a** in all of the lengths (96 symbols is the combination of a32 and a64)
 - Role of CPPS
 - (a) Timing tracking, (b) Compensation for clock drift, and (c) Compensation for frequency offset error that resides after fine AFC and that caused by phase noise in LOS environment
 - Cyclic prefix (CP) for frequency domain equalizer (FDE) (Optional CP design is available as option)
 - PCES length : **768, 1024, 1536 (symbol)**
 - PCES period : **8192, 16384, 32768 or 131072 (symbol)**
 - Role of PCES
 - (a) Timing tracking, (b) Compensation for clock drift, and (c) Compensation for frequency offset error that resides after fine AFC and that caused by phase noise in LOS environment

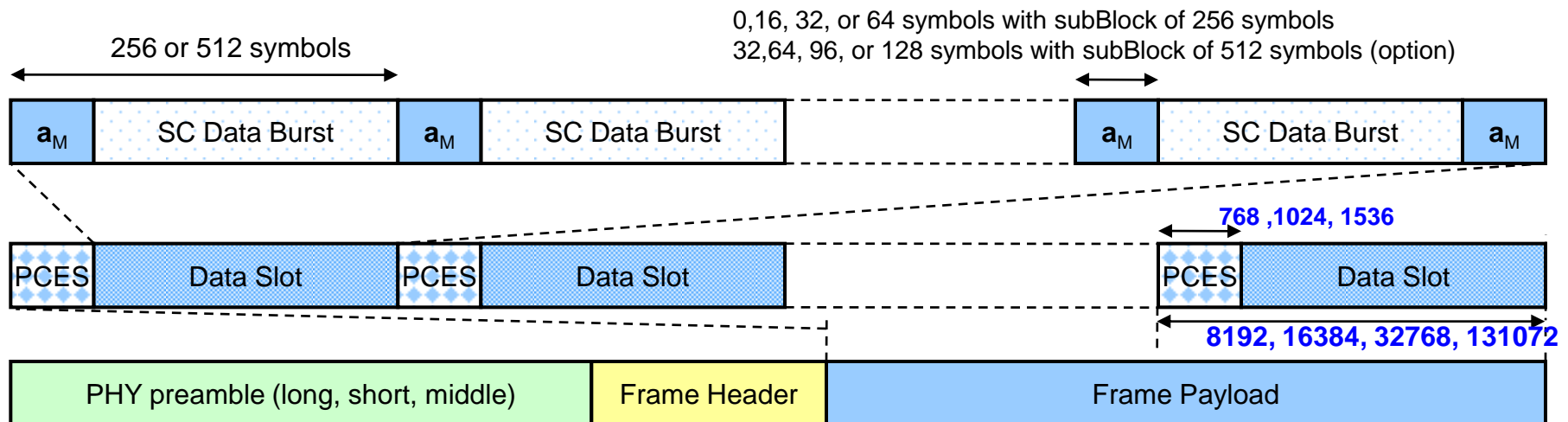

Appendix 5: Mandatory cyclic prefix design (2/3)

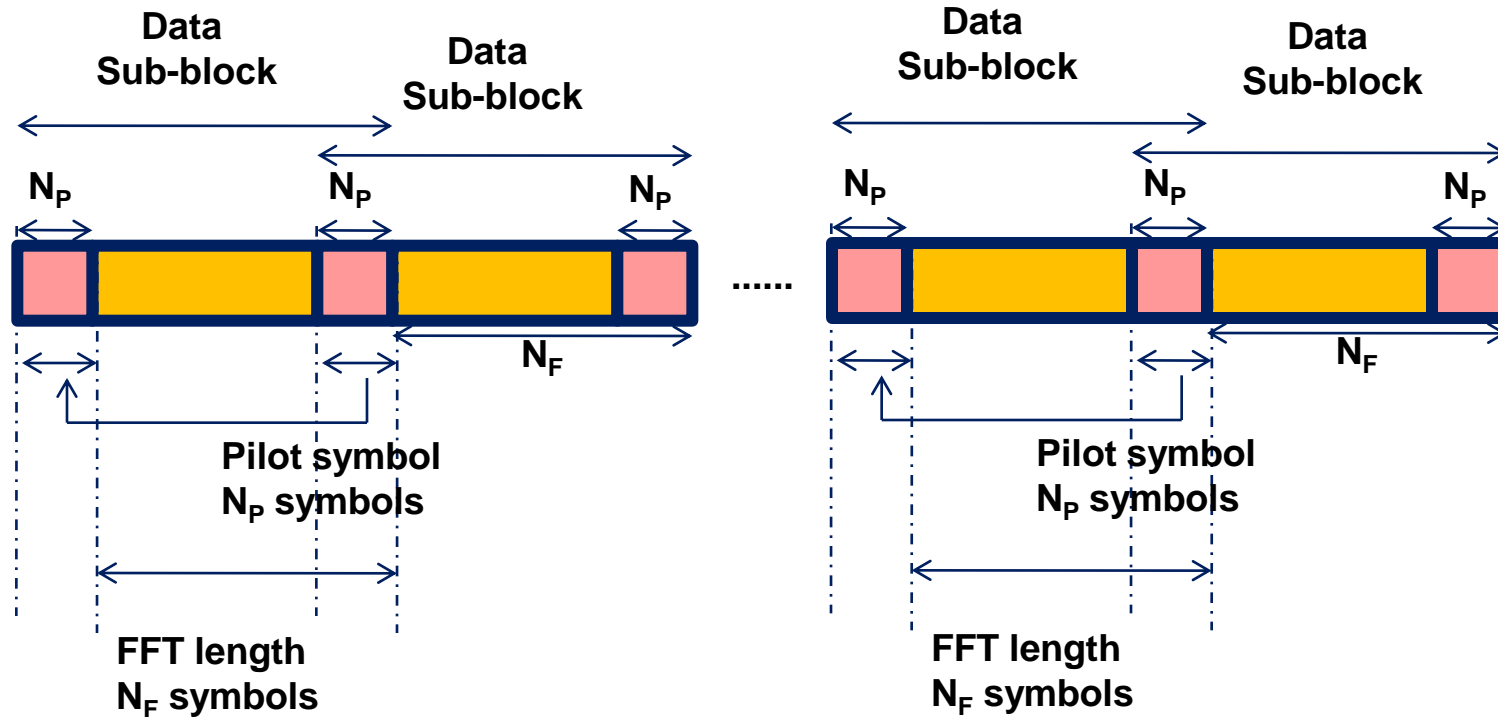

- Golay pilot symbols that can reuse the acquisition hardware
- Can be used for timing control, automatic frequency control, and channel tracking

$N_F = 256$ or 512

$N_p = 0, 16, 32,$ or 64 ($N_F = 256$)

$32, 64, 96,$ or 128 ($N_F = 512$)

Appendix 5: Optional cyclic prefix design (3/3)

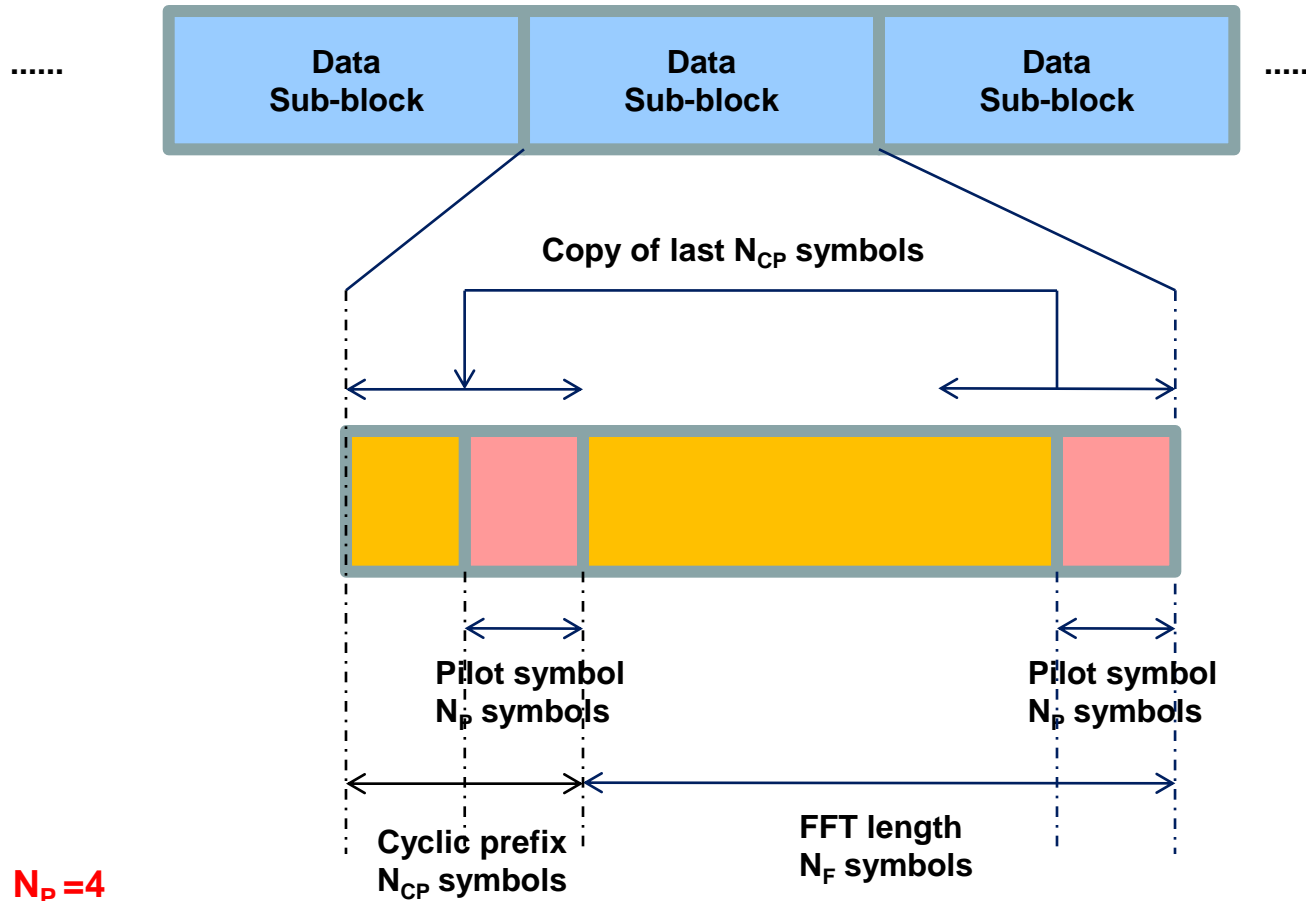

$N_p = 4$

$N_F = 256$ or 512

$N_p = 0, 16, 32,$ or 64

Document proposed in Hawaii meeting

What have changed from San Francisco meeting

- CoMPA and Tohoku univ. proposals have merged
- CoMPA and National Taiwan univ. proposals have merged
- CoMPA and Panasonic proposals have merged
- CoMPA and Samsung proposals have merged
- CoMPA, Philips, Korea University, ETRI, GEDC, and Decawave proposals have merged
- CoMPA and Astrin Radio Artisty have merged

Collaboration under study

- Tensorcom Inc.
- LG Electronics Inc., NEC Corporation, Samsung Electronics, Co., Ltd, SiBEAM, Inc., Sony Corporation, and Toshiba Corporation

What was updated from San Francisco meeting

- Available **PHY transmission modes** are updated
 - **2** mandatory modes (Common mode, HRT)
 - **20** optional LRT modes
 - **4** optional MRT modes
 - **9** optional HRT modes
- **Superframe format for ADD** has been updated

Option:

- **UEP (Unequal Error Protection)** has been updated
- **Beam forming procedure** has been introduced
- **DEV-DEV communications procedure** has been introduced

Summary of COMPA Channel Plan

– Full-rate channel plan

- Four full-rate channels in 9 GHz BW
- Channel separation: **2160** MHz
- Nyquist bandwidth: 1632 MHz
- Supporting common mode with data rate of 47.8 Mbps, as well as LRTs, MRTs, and HRTs with data rates of up to **6.118 Gbps** (to be changed after merger) in SC mode or up to 6.0 Gbps in OFDM mode

– Half-rate channel plan

- **Four half-rate channels with the same center frequencies as the full-rate channels**
- Channel separation: 2160 MHz
- Nyquist bandwidth: 816 MHz (half symbol and sampling rates)
- Supporting common mode with data rate of 47.8 Mbps **using 1 GHz Tx and Rx filters and the same modulation format as common mode for full-rate channels**
- Supporting LRTs with several data rates of up to 1530 Mbps using $\pi/2$ BPSK (RS(255,239)) in SC mode

CoMPA Full-rate (2GHz) Channel Plan

Channel Number	Low Freq. (GHz)	Center Freq. (GHz)	High Freq. (GHz)	Nyquist BW (MHz)	Roll-Off Factor
A1	57.240	58.320	59.400	1632	0.3235
A2	59.400	60.480	61.560	1632	0.3235
A3	61.560	62.640	63.720	1632	0.3235
A4	63.720	64.800	65.880	1632	0.3235

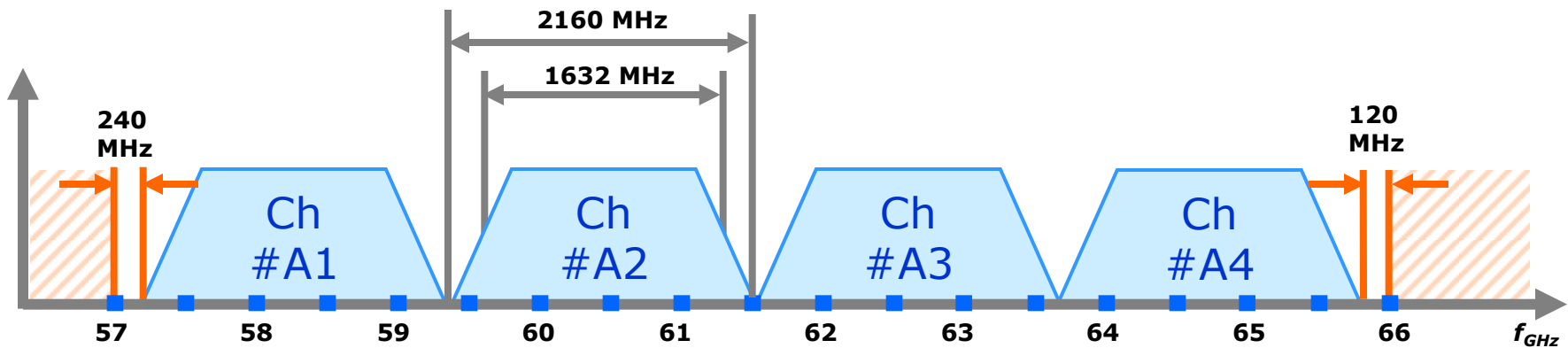

- Support cell phone XTALs: **19.2 MHz**, 24 MHz & other high frequency XTALs: **54 MHz, 60 MHz, 108 MHz, ...**
- Balanced margins to 57/66 GHz & good roll-off factor
- Supports multiple PLL architectures with the cell phone XTAL
- Dual PLL: High frequency PLL that generates carrier frequencies
Low frequency PLL that generates ADC/DAC & ASIC frequencies

CoMPA Half-rate (1GHz) Channel Plan

Channel Number	Low Freq. (GHz)	Center Freq. (GHz)	High Freq. (GHz)	Nyquist BW (MHz)	Roll-Off Factor
B1	57.78	58.32	58.86	816	0.3235
B2	59.94	60.48	61.02	816	0.3235
B3	62.10	62.64	63.18	816	0.3235
B4	64.26	64.80	65.34	816	0.3235

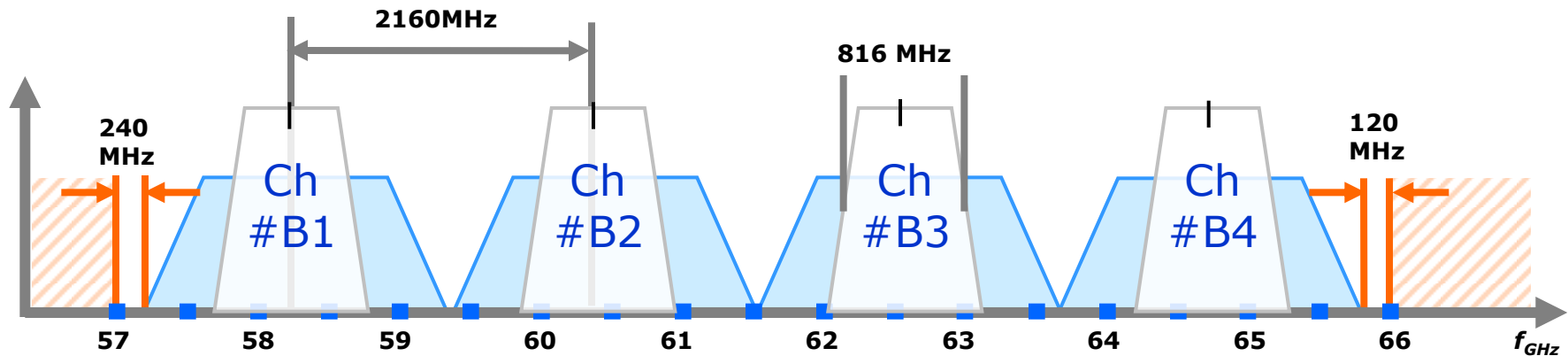

- Channel separation: 2160 MHz
- Same XTAL support and PLL architecture as full-rate channelization
- Chs B1, B2, B3, and B4 have the same center frequencies as Chs A1, A2, A3, and A4, respectively

PHY Mode

- 4 types of multi-rate transmission based on PHY-SAP data rate
 - Common mode transmission (CMT) : 47.8 Mbps
 - Low rate transmission (LRT) : up to 2 Gbps
 - Medium rate transmission (MRT) : from 2 Gbps to 3 Gbps
 - High rate transmission (HRT) : over 3 Gbps

- Common mode -

PHY Mode	Transmission Mode	PHY-SAP data rate	Nyquist BW	Modulation	Coding	Spreading factor	MAC-SAP data rate
Common mode	Common mode transmission (CMT)	47.8 Mbps	1.632 GHz	$\pi/2$ BPSK	RS(255,239)	32	36.8 Mbps

- Optional Polling Signal mode-

PHY Mode	Transmission Mode	PHY-SAP data rate	Nyquist BW	Modulation	Coding	Spreading factor	MAC-SAP data rate
Polling mode	Polling transmission (PT)	47.8 Mbps	1.632 GHz	OOK	RS(255,239)	32	36.8 Mbps

PHY Mode

- SC LRT(up to 2 Gbps) -

Modified

Mandatory

PHY Mode	Transmission Mode	PHY-SAP data rate	Nyquist BW	Modulation	Coding	Spreading factor	MAC-SAP data rate
Mandatory	LRT 1	47.8 Mbps	0.816GHz	$\pi/2$ BPSK (GMSK)	RS(255,239)	16	36.8 Mbps
	LRT 2	383 Mbps				2	294 Mbps
	LRT 3	1530 Mbps		$\pi/2$ QPSK		-	1136 Mbps
SC mode	LRT 4	47.8 Mbps	1.632GHz	GMSK/ $\pi/2$ BPSK	RS(255,239)	32	36.8 Mbps
	LRT 5	191.2 Mbps				8	147.2 Mbps
	LRT 6	382.4 Mbps				4	294 Mbps
	LRT 7	764.8 Mbps		2	581 Mbps		
	LRT 8	1530 Mbps		GMSK/ MSK/ $\pi/2$ BPSK	RS(255,239)	-	1136 Mbps
	LRT 9	408 Mbps		GMSK/ $\pi/2$ BPSK	LDPC(576,288)	2	
	LRT 10	612 Mbps			LDPC(576,432)	2	
	LRT 11	714 Mbps			LDPC(576,508)	2	
	LRT 12	816 Mbps		GMSK/ $\pi/2$ BPSK	LDPC(576,288)	-	
	LRT 13	1224 Mbps			LDPC(576,432)	-	
	LRT 14	1632 Mbps			LDPC(576,508)	-	
	LRT 15	1632 Mbps		$\pi/2$ QPSK	LDPC(576, 288)	-	1267 Mbps
	LRT 16	383 Mbps		OOK	RS(255,239)	4 (4 repetitions)	294 Mbps
	LRT 17	765 Mbps				2 (2 repetitions)	581 Mbps
	LRT 18	1530 Mbps				-	1186 Mbps
	LRT 19	408 Mbps		$\pi/2$ BPSK	CC R=1/2	2 (2 repetitions)	
	LRT 20	1088 Mbps		$\pi/2$ BPSK	CC R=2/3	-	
	LRT 21	1632 Mbps		$\pi/2$ QPSK	CC R=1/2	-	

- PHY-SAP data rate is shown in case of cyclic prefix (CP =0)
- PHY-SAP data rate (CP=8) has PHY-SAP data rate (CP=0) of 97%
- PHY-SAP data rate (CP=64) has PHY-SAP data rate (CP=0) of 75%

LRT19-21 based on doc# 802.15-0681-02-003c

- MAC-SAP data rate (CP=8) has PHY-SAP data rate (CP=8) of 77%
- MAC-SAP data rate (CP=64) has PHY-SAP data rate (CP=64) of 77%

PHY Mode

- SC MRT(from 2 Gbps to 3 Gbps) -

PHY Mode	Transmission Mode	PHY-SAP data rate	Nyquist BW	Modulation	Coding	MAC-SAP data rate
SC mode	MRT 1	2448 Mbps	1.632 GHz	$\pi/2$ QPSK	LDPC(576, 432)	1872 Mbps
	MRT 2	2856 Mbps			LDPC(576, 504)	2175 Mbps
	MRT 3	2176 Mbps		$\pi/2$ QPSK	CC $R_{CC}=2/3$	
	MRT 4	2844 Mbps		8QAM	CC $R_{CC}=2/3$ RS(63,55)	

MRT 3: Based on doc# 802.15-0681-02-003c

MRT 4: Based on doc# 802.15-0683-07-003c

- PHY-SAP data rate is shown in case of cyclic prefix (CP =0)
- PHY-SAP data rate (CP=8) has PHY-SAP data rate (CP=0) of 97%
- PHY-SAP data rate (CP=64) has PHY-SAP data rate (CP=0) of 75%
- MAC-SAP data rate (CP=8) has PHY-SAP data rate (CP=8) of 77%
- MAC-SAP data rate (CP=64) has PHY-SAP data rate (CP=64) of 77%

Modified

PHY Mode

- SC HRT(over 3 Gbps) -

PHY Mode	Transmission Mode	PHY-SAP data rate	Nyquist BW	Modulation	Coding	MAC-SAP data rate
Mandatory	HRT 1	3046 Mbps	1.632 GHz	$\pi/2$ QPSK	LDPC(1440,1344)	2322 Mbps
	HRT 2	3059 Mbps			RS(255,239)	2331 Mbps
SC mode	HRT 3	4284 Mbps		$\pi/2$ 8PSK	LDPC(576,504)	3197 Mbps
	HRT 4	4570 Mbps			LDPC(1440,1344)	3401 Mbps
	HRT 5	4589 Mbps		RS(255,239)	3401 Mbps	
	HRT 6	3264 Mbps		NS8QAM	TCM $R_{CC} = 1/2$	
	HRT 7	4266 Mbps		8QAM	RS(63,55)	
	HRT 8	4589 Mbps		NS8QAM	RS(255,239)	
	HRT 9	4896 Mbps		16QAM	TCM $R_{CC} = 2/3$	
	HRT 10	6118 Mbps		16QAM	RS(255,239)	

HRT 6 to 10 : Based on doc# 802.15-0681-02-003c & 802.15-0683-07-003c

- PHY-SAP data rate is shown in case of cyclic prefix (CP =0)
- PHY-SAP data rate (CP=8) has PHY-SAP data rate (CP=0) of 97%
- PHY-SAP data rate (CP=64) has PHY-SAP data rate (CP=0) of 75%
- MAC-SAP data rate (CP=8) has PHY-SAP data rate (CP=8) of 77%
- MAC-SAP data rate (CP=64) has PHY-SAP data rate (CP=64) of 77%

Modified

PHY Mode

- OFDM LRT(up to 2 Gbps) -

PHY Mode	Transmission Mode	PHY-SAP data rate	Bandwidth	Modulation	Coding	Code Rate	Spreading factor
OFDM mode	LRT1	375 Mbps	1 GHz (incl. guard band)	BPSK	Convolutional Code + RS, LDPC, Turbo Codes [TBD]	1/2	
	LRT2	500 Mbps		BPSK		2/3	
	LRT3	750 Mbps		QPSK		1/2	
	LRT4	1000 Mbps		QPSK		2/3	
	LRT5	1500 Mbps		16-QAM		1/2	
	LRT6	750 Mbps	2 GHz (incl. guard band)	BPSK		1/2	
	LRT7	1000 Mbps		BPSK		2/3	
	LRT8	1500 Mbps		QPSK		1/2	
	LRT9	680 Mbps	1632 MHz	QPSK	LDPC	1/2	2
	LRT10	1360 Mbps			1/2		
	LRT11	868 Mbps			Convolutional code +RS	1/3	
	LRT12	1735 Mbps				2/3	
	LRT13	1735 Mbps		1/3			
			16-QAM				

PHY Mode

- OFDM MRT (from 2 Gbps to 3 Gbps) -

PHY Mode	Transmission Mode	PHY-SAP data rate	Bandwidth	Modulation	Coding	Code Rate
OFDM mode	MRT1	2000 Mbps	1 GHz (incl. guard band)	16-QAM	Convolutional Code + RS, LDPC, Turbo Codes [TBD]	2/3
	MRT2	2500 Mbps		16-QAM		5/6
	MRT3	3000 Mbps		64-QAM		2/3
	MRT4	2000 Mbps	2 GHz (incl. guard band)	QPSK		2/3
	MRT5	3000 Mbps		16-QAM		1/2
	MRT6	2040 Mbps	1632 MHz	QPSK	LDPC	3/4
	MRT7	2380 Mbps				7/8
	MRT8	2720 Mbps		16-QAM		3/4
	MRT9	2082 Mbps		QPSK	Convolutional code +RS	4/5

PHY Mode

- OFDM HRT (over 3 Gbps) -

PHY Mode	Transmission Mode	PHY-SAP data rate	Bandwidth	Modulation	Coding	Code Rate
OFDM mode	HRT1	4000 Mbps	2 GHz (incl. guard band)	16-QAM	Convolutional Code + RS, LDPC, Turbo Codes [TBD]	2/3
	HRT2	5000 Mbps		16-QAM		5/6
	HRT3	6000 Mbps		64-QAM		2/3
	HRT4	4080 Mbps	1632 MHz	16-QAM	LDPC	3/4
	HRT5	4760 Mbps				7/8
	HRT6	3470 Mbps			Convolutional code +RS	2/3
	HRT7	4160 Mbps				4/5

802.15.3c Major MAC Attributes for PHY Design

1. **Channel Scan**
 - Common mode beacon
2. **Automatic Device Discovery (ADD)**
 - ADD for directional antenna with “omni”*
3. **Channel Probing**
 - Channel estimation in CAP
4. **Data Communication**
 - 4 communication types
5. **Superframe**
 - Superframe
 - Beacon period
 - Multiple beacons
 - CAP
 - CTAP
6. **Frame format**
 - Frame types
 - Preamble
 - PLCP header
 - Payload
7. **Optional unequal error protection (UEP)**
8. **Optional beam forming**
9. **Optional DEV-DEV directional communications**

* ; “omni” means to cover all directions by omni antenna or part of omni antenna coverage which is planned to be covered by the directional antenna (beam forming or sector antenna)

Summary

- **Common mode supports**
 - Channel scan by beacons in common mode
 - Automatic device discovery
- **Automatic device discovery (ADD)** for directional antenna devices with “omni”
- **Channel probing (option)** by using SC/OFDM frame with preceding common preamble and PLCP Header (for best fitting air interface)
- **Four communication types support depending on SC and/or OFDM**
- **Superframe**
 1. Superframe length: 2ms
 2. Beacon period : up to 0.2ms
 3. Multiple beacons for SC, OFDM and OOK DEVs
 4. Transmission in beacon period is CMT of 47.8 Mbps ($\pi/2$ BPSK, RS)
 5. Transmission in CAP is CMT (optionally allows channel probing mode)
 6. Transmission in CTAP are variable from LRT to HRT, and Common/SC/OFDM data transmission is simultaneously supported in CTAP
- **Frame format**
 1. Frame types are CMT, SC LRT, channel probing, SC MRT/HRT SC, and OFDM mode frames
 2. Preamble
 - Long preamble for CMT, SC LRT and channel probing frames
 - SYNC of 32 repetitions of Golay code of 64 chips and CE of 4 repetitions of Golay code of 128 chips for half-rate frames
 - SYNC of 32 repetitions of Golay code of 128 chips and CE of 4 repetitions of Golay code of 256 chips for full-rate frames
 - Short preamble for SC MRT/HRT frames
 - SYNC of 8 repetitions of Golay code of 128 chips and CE of 4 repetitions of Golay code of 256 chips for full-rate frames
 3. PLCP header
 - (a) **Common mode and channel probing frames:** protected with RS code ($R=1/2$) and with code spreading by Golay code of 32 chips@1.632Gcps
 - (b) **SC LRT frames with spreading payload:** protected with RS code ($R=1/2$) and with code spreading by Golay code of 16 chips@0.816Gcps or 32 chips@1.632Gcps
 - (c) **SC LRT frames without spreading payload, MRT, and HRT frames** Protected with only RS ($R=1/2$) (i.e., without code spreading)
 4. Payload
 - (a) **Common mode frames:** $\pi/2$ BPSK and RS (255,239) and code spreading by Golay code of 32 chips@1.632 Gcps
 - (b) **SC LRT frames with spreading payload :** $\pi/2$ BPSK and RS (255,239) and **code spreading by Golay code of 2,4,8,16** chips@0.816Gcps or 2,4,8,16, 32chips@1.632Gcps
 - (c) **SC LRT frames without spreading payload, and SC MRT/HRT frames:** no spreading
- **UEP by modulation and coding scheme (MCS) change**
- **Beam forming**
- **DEV-DEV directional communications**

802.15.3c Piconet

- 802.15.3c piconet consists of a piconet coordinator (PNC) and devices (DEVs) with **directional antenna with “omni”**
- PNC and DEVs are capable of **Single Carrier (SC)** and/or **OFDM air interfaces**
- 802.15.3c piconet supports
 - **Four communication types**
 1. Type 1: Common mode/LRT mode
 2. Type 2: Common/LRT and SC MRT/HRT modes
 3. Type 3: Common/LRT and OFDM modes
 4. Type 4: Common/LRT, SC MRT/HRT and OFDM modes

Basic operations in Piconet

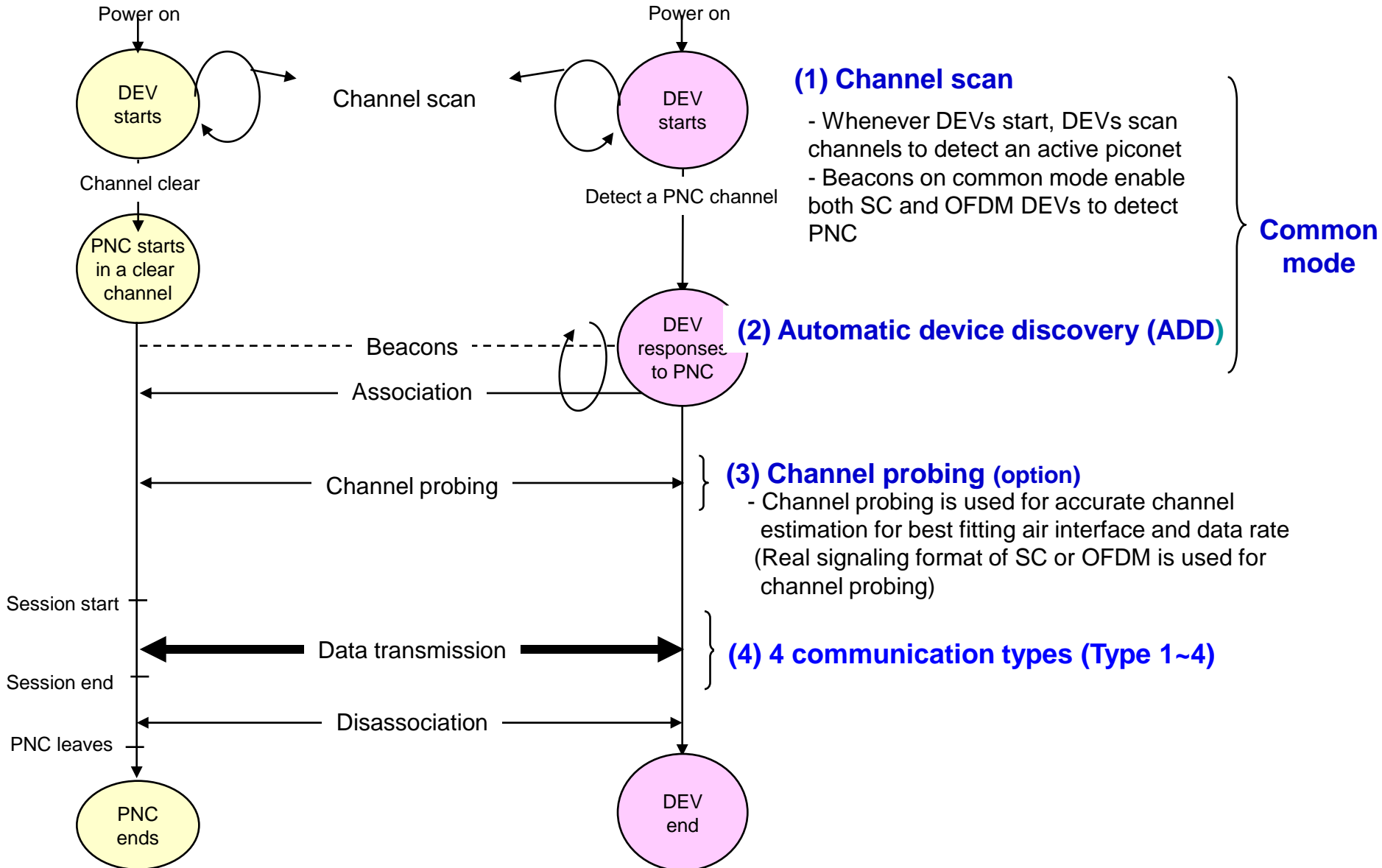

Common Mode

(Simple Single Carrier bridging different air interfaces)

- **Both SC and OFDM air interfaces** are **simultaneously** supported on top of common mode frame
- **Common mode: simple single carrier ($\pi/2$ BPSK with Reed Solomon as FEC)** for robust and longer transmission range
- **Common mode** is to **bridge an air interface to different air interfaces** best fitting to the applications
- **Common mode** is used for **beacon and association** (automatic device discovery)

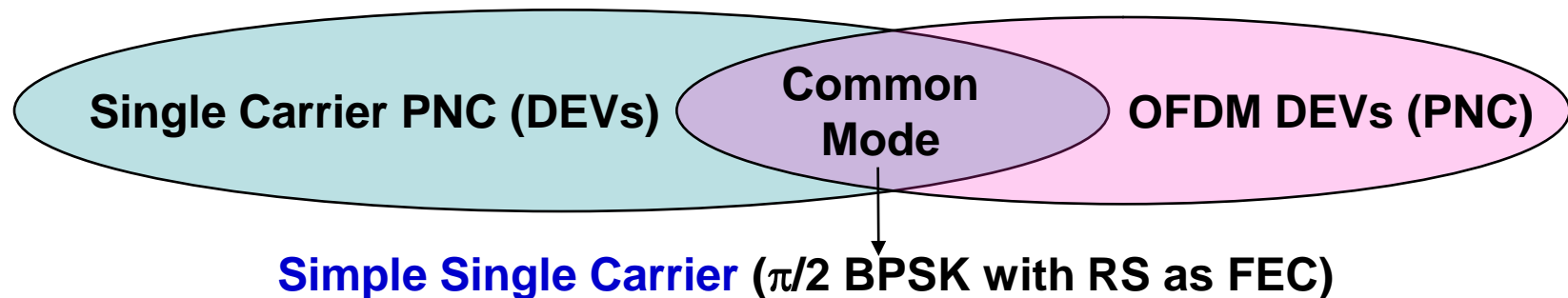

Channel Scan

(To detect piconet on common mode)

1. To initiate channel scan, PNC shall broadcast **beacons in common mode with “omni”**
 - **Beacons on common mode** enable both SC and OFDM DEVs to detect PNC
 - **Transmission rate of beacons is 47.8 Mbps ($\pi/2$ BPSK with RS)**
2. To detect an active piconet, DEVs scan **beacons on common mode** broadcasted from PNC

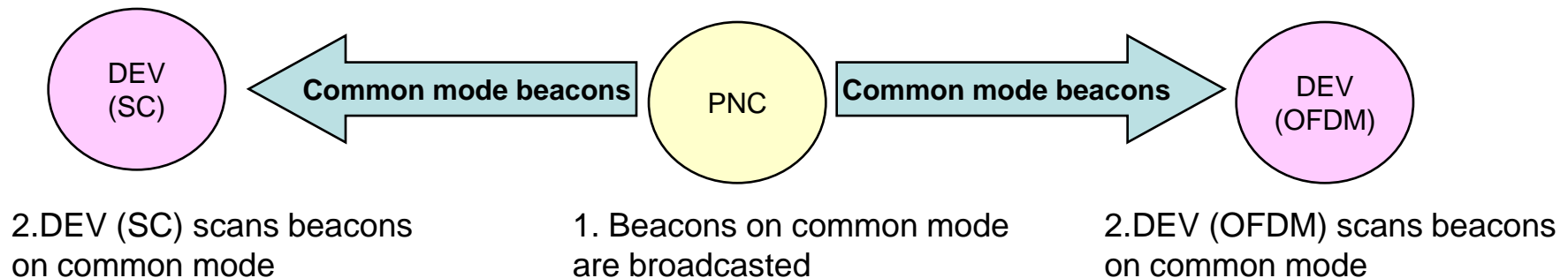

Automatic device discovery (ADD)

(Fast ADD and shorten beacon period based on “directional antenna with omni”)

- Assumed **directional antenna devices with “omni”** : Two types
 - Beam forming antenna
 - Sector switching antenna
- ADD **procedure** for **directional antenna with “omni”**
 - Omni antenna is used for automatic device discovery when devices start up for both beam forming and sector switching
 - Then, beam forming procedure supporting both beam forming antenna and sector switching antenna is carried out for directional communication

Channel probing

(Accurate channel estimation for best fitting air interface and data transmission rate)

- **Channel probing (option)** is used for **accurate channel estimation** for best fitting air interface and data transmission
- **Real signaling format of SC or OFDM following common mode preamble and header** is used to estimate both forwarding and backwarding channel conditions
- **Channel probing** can be done in either **CAP** or **CTAP**

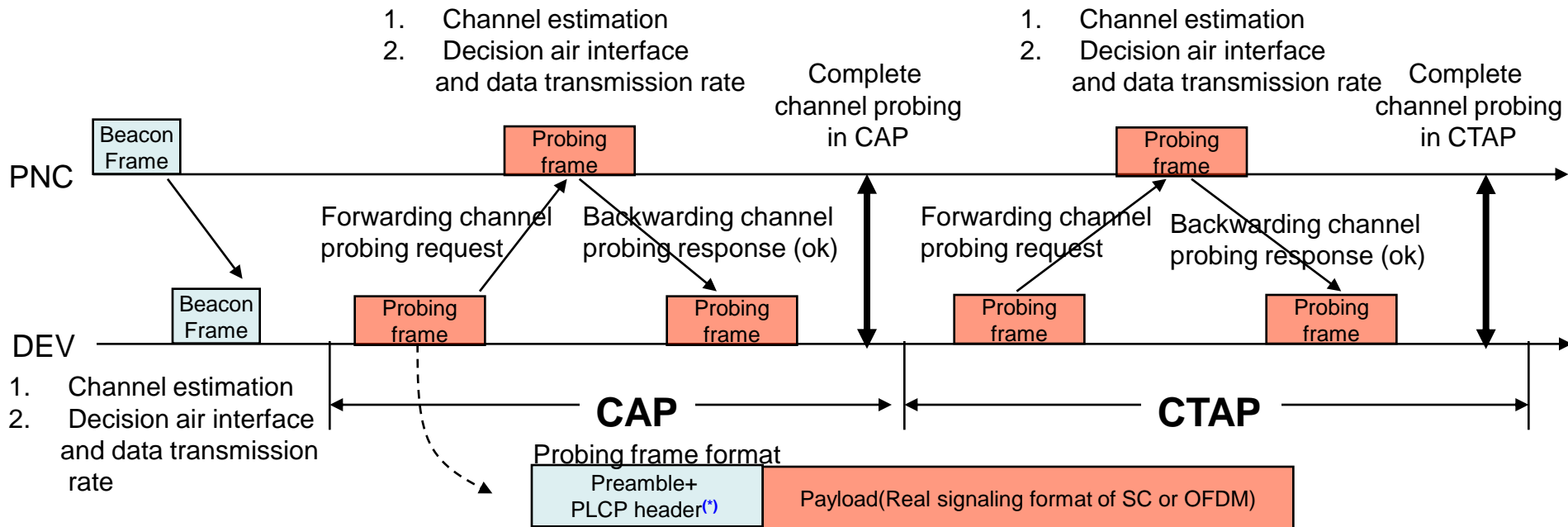

(*) same as those of common mode frame

Data communication

(Four communication types of Common/LRT only, Common/LRT+MRT/HRT SC, Common/LRT+OFDM and Common/LRT+MRT/HRT SC+OFDM)

- **Four types of communications between PNC and DEV**
 1. Type1: **Common/LRT** mode for both Single Carrier and OFDM Devices
 2. Type2: **Common/LRT** and **Single Carrier MRT/HRT** modes
 3. Type3: **Common/LRT** and **OFDM** modes
 4. Type4: **Common/LRT, Single Carrier MRT/HRT** and **OFDM** modes

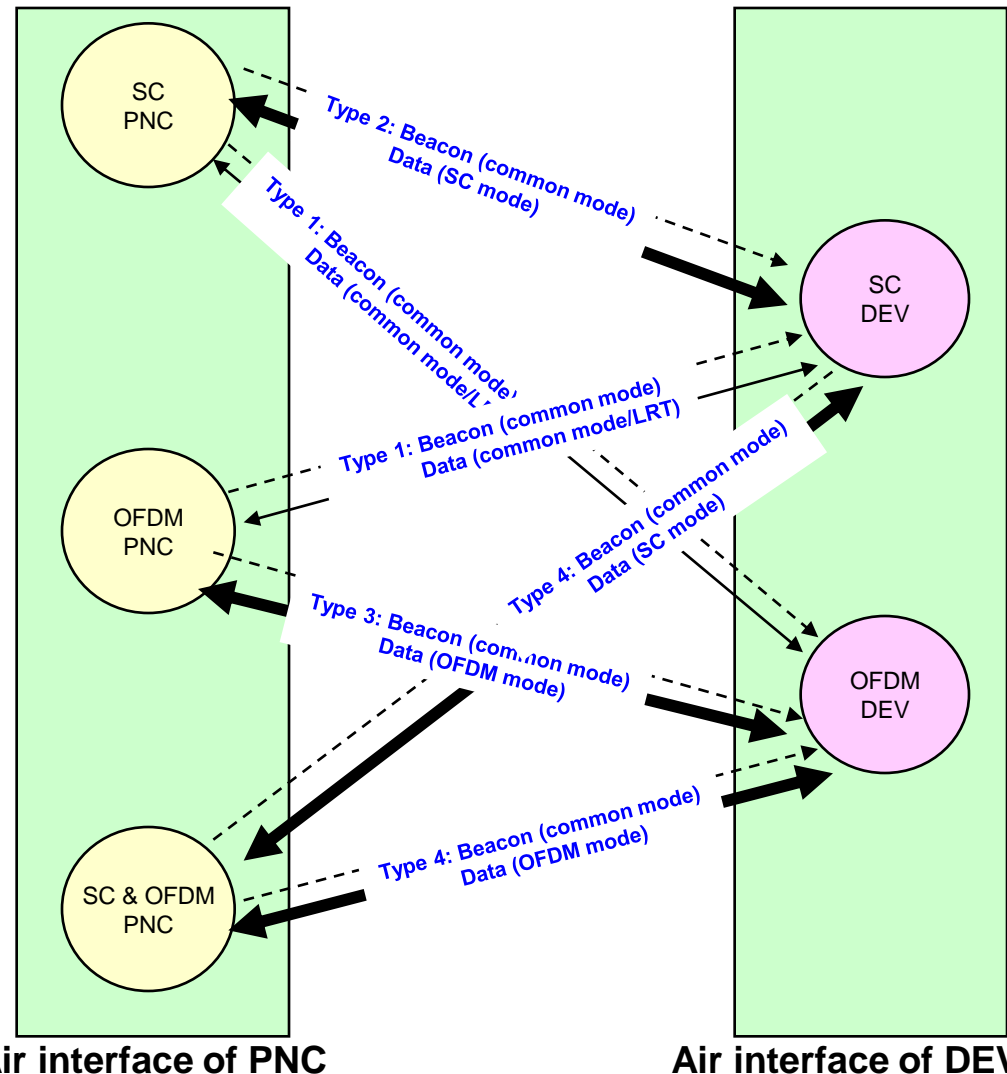
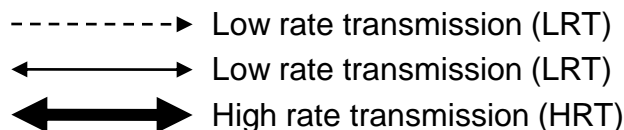

Air interface of PNC

Air interface of DEV

Superframe

(BP in CMT, CAP in CMT (MRT/HRT SC or OFDM for channel probing as option) and CTAP in CMT/LRT/MRT/HRT)

- **Superframe length** is **2ms** upon considering memory size, delay and data transmission efficiency
- **Beacon Period (BP)** can be adaptively changed up to **0.2ms** in common mode transmission with a rate of **47.8 Mbps**
- **Contention Access Period (CAP)** based on CSMA/CA is used for association, channel estimation, communication mode decision (SC or OFDM), and channel time allocation
 - CAP is used for common mode transmission (CMT), and optionally allows channel probing mode
 - Channel probing frame optionally used in CAP contains common preamble & PLCP header and SC/OFDM payload (see Appendix 1)
- **Channel Time Allocation Period (CTAP)** based on TDMA is used for data transmission in **CMT/LRT, MRT/HRT SC and OFDM modes simultaneously**

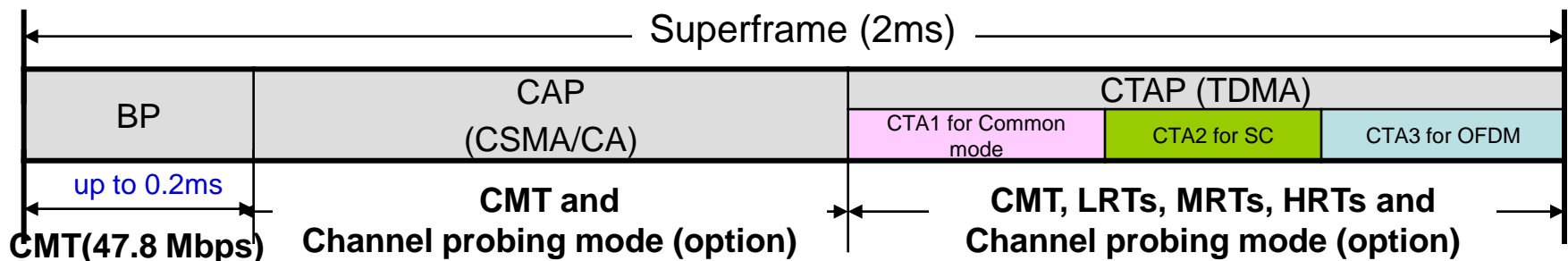

Beacon Period

(up to 0.2ms for omni and SYNC beacons)

- Beacon period can be adaptively changed up to 0.2ms
- Beacon period contains one “omni” beacon and up to 16 synchronization (SYNC) beacons
 - Omni beacon is used for automatic device discovery among devices
 - SYNC beacons are used for superframe synchronization for directionally communicating devices
- **Beacon period of 0.2ms** keeps high enough **superframe efficiency (~90 %)** to transmit over **2.25 Gbps MAC-SAP throughput by QPSK with RS (UM5)**
 - **UM5** requires **2.25 Gbps MAC-SAP throughput** and it is preferable that it's rate is supported by **simple QPSK with RS**.
 - MAC-SAP of 3.56 Gbps in UM1 is supported by 8PSK
 - MAC-SAP of 1.78 Gbps in UM1 and MAC-SAP of 1.5 Gbps in UM5 are easier targets

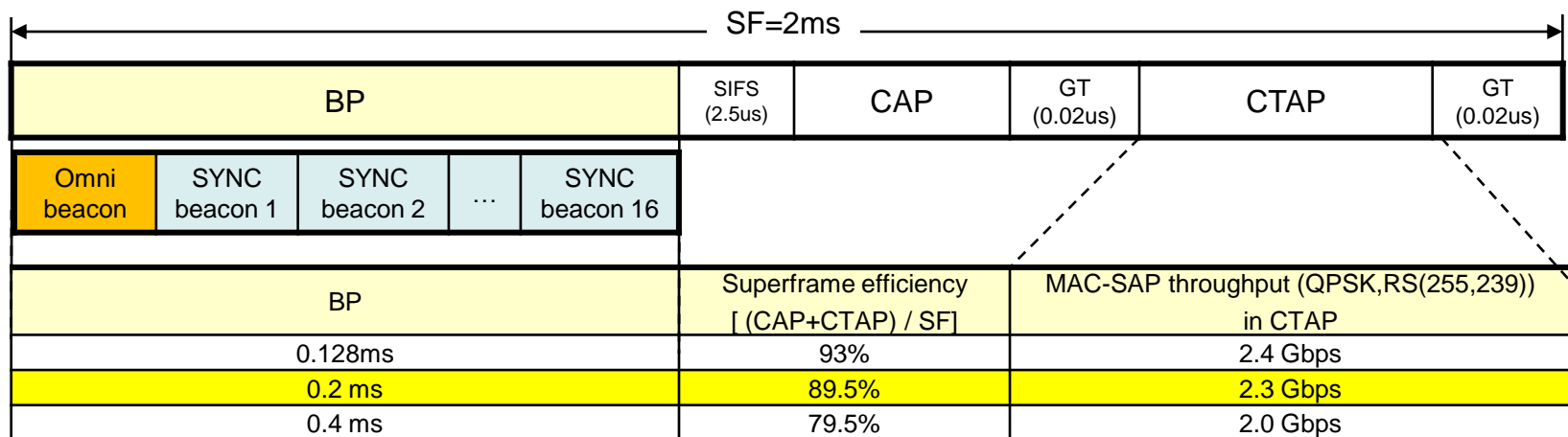

- 11.6us beacon frame (upon 21 octets payload) is assumed
- 200us CAP for association is assumed to calculate MAC-SAP throughput

Multiple beaconing for SC, OFDM and OOK DEVs (Common mode and polling mode beacons)

- **Multiple beacons** of **common mode (BPSK)** and **optional polling mode (OOK)** can support **SC, OFDM** and **OOK DEVs** in a piconet, simultaneously
- **Beacon period** can accommodate **multiple beacons**:
 - **Common mode beacons of omni and SYNC** are used for SC/OFDM DEVs
 - **Optional polling mode beacons of omni and SYNC** are used for OOK DEVs

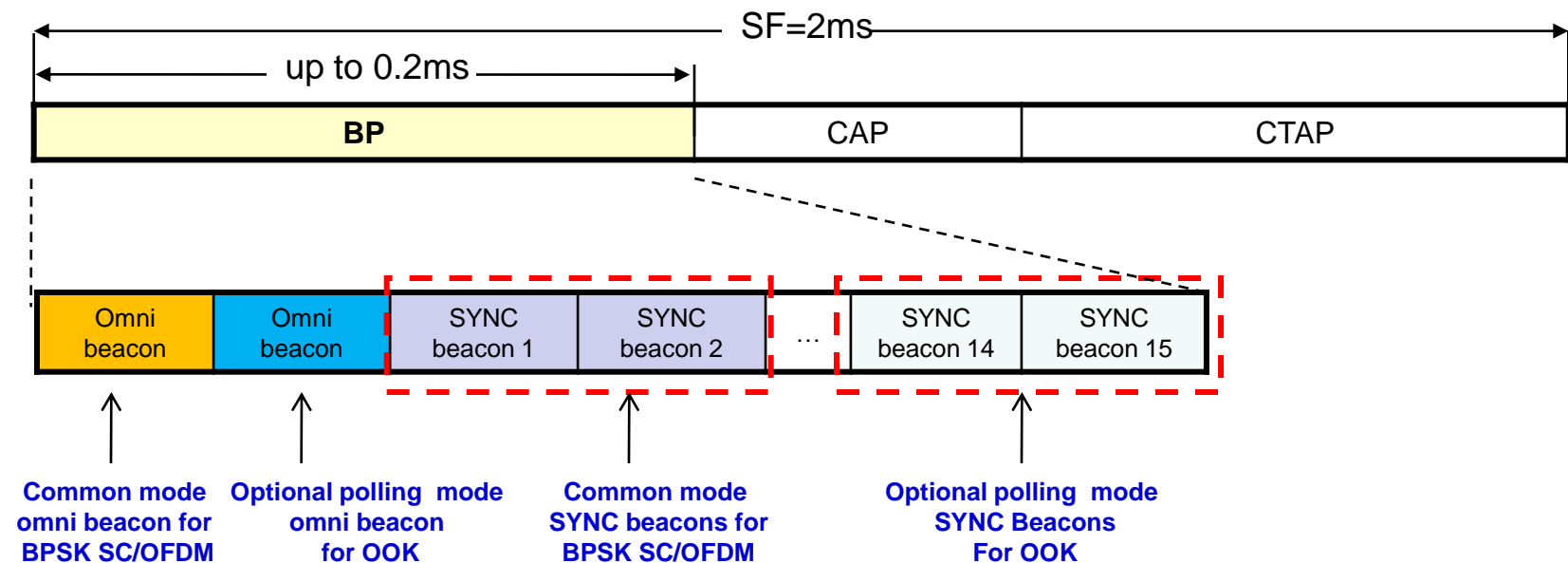

Frame format of half-rate transmission modes (Example: half-rate SC LRT of 47.8 Mbps)

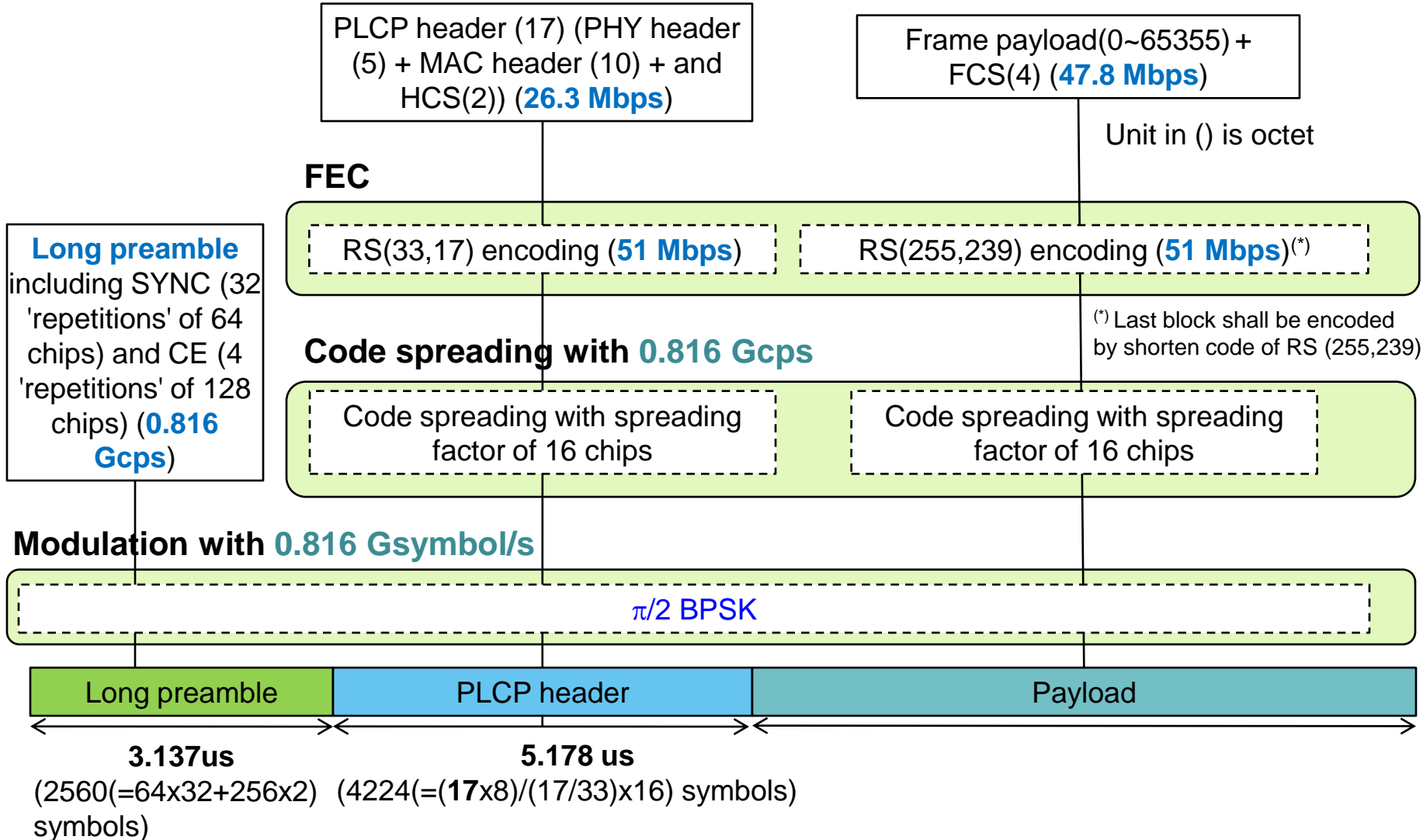

^(*)'repetitions': codes may be different (i.e., $a, -a, b, -b$), but can be decoded with the same decoder

Frame format of half-rate transmission modes

- SC LRT and Probing modes -

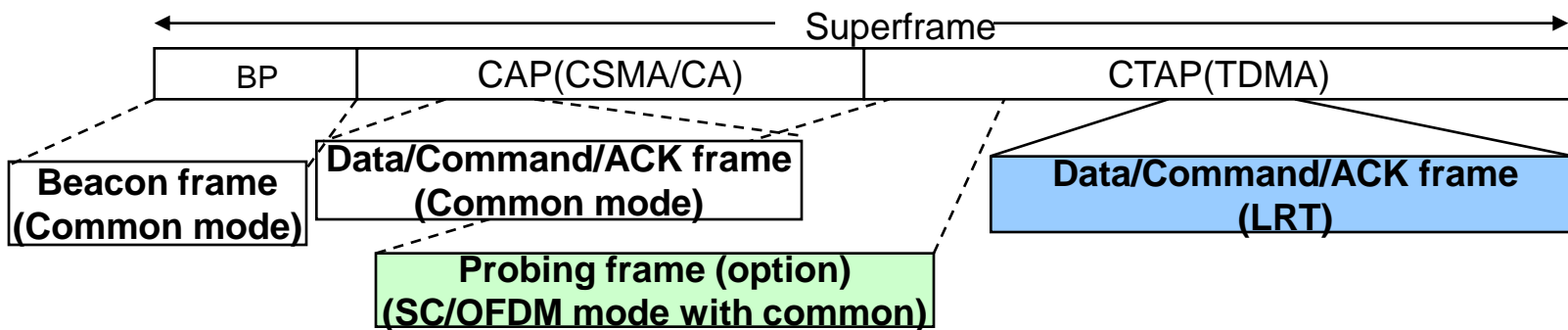

SC LRT frame (Half-rate channel)

0.816 Gsymbol/s

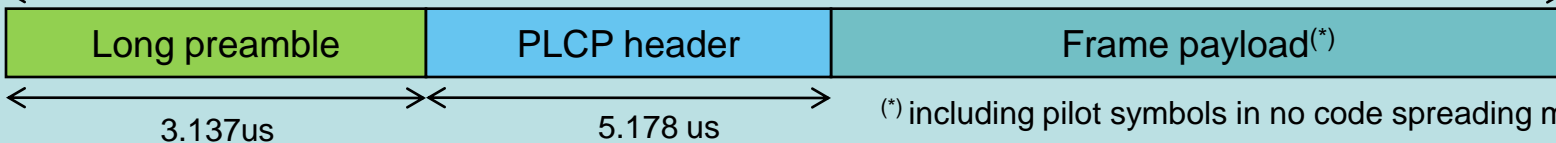

(*) including pilot symbols in no code spreading mode

	Preamble	PLCP header	Payload
Modulation	$\pi/2$ BPSK//GMSK	$\pi/2$ BPSK/GMSK	$\pi/2$ BPSK/GMSK / $\pi/2$ QPSK
FEC	N/A	RS(33,17)	RS (255,239)
Spreading factor	N/A	16 with 0.816 Gcps	1,2,16 with 0.816 Gcps (half-rate LRT)

Probing frame (Half-rate channel)

0.816 Gsymbol/s

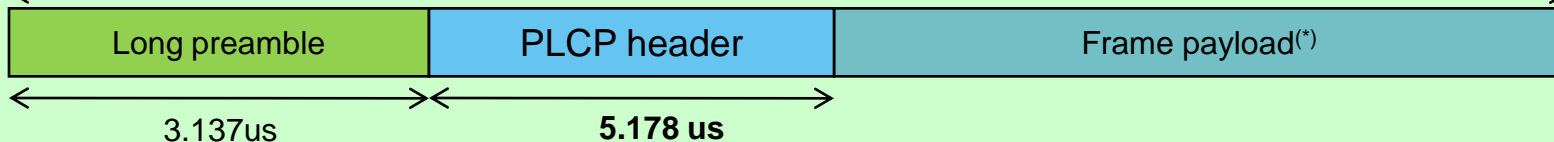

	Preamble	PLCP header	Payload
Modulation	$\pi/2$ BPSK	$\pi/2$ BPSK	According to available transmission modes
FEC	N/A	RS(33,17)	
Spreading factor	N/A	16 with 0.816 Gcps	

Frame format of full-rate transmission modes (Example: SC MRT/HRT)

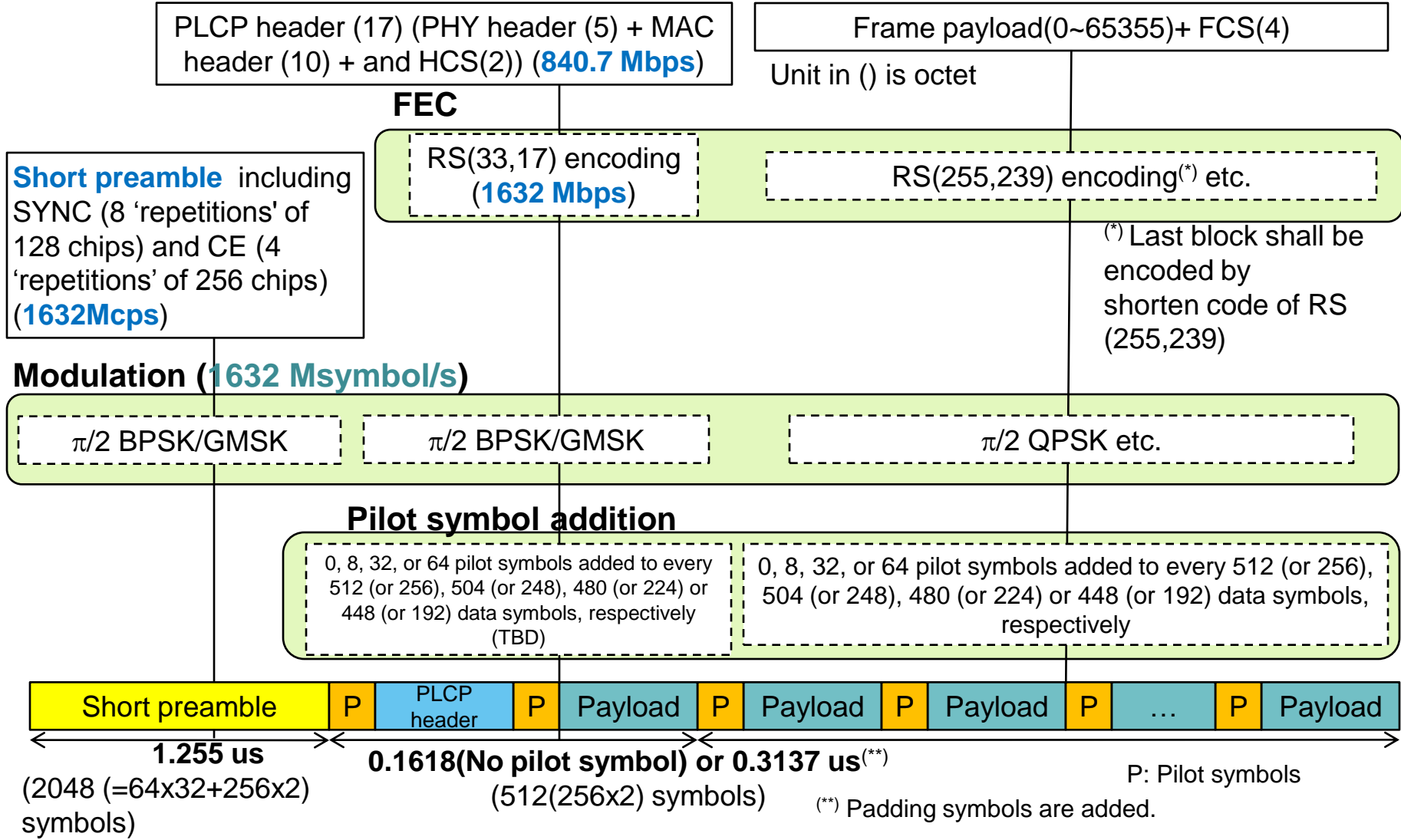

Frame format of full-rate transmission modes

- Common, Probing and SC LRT modes -

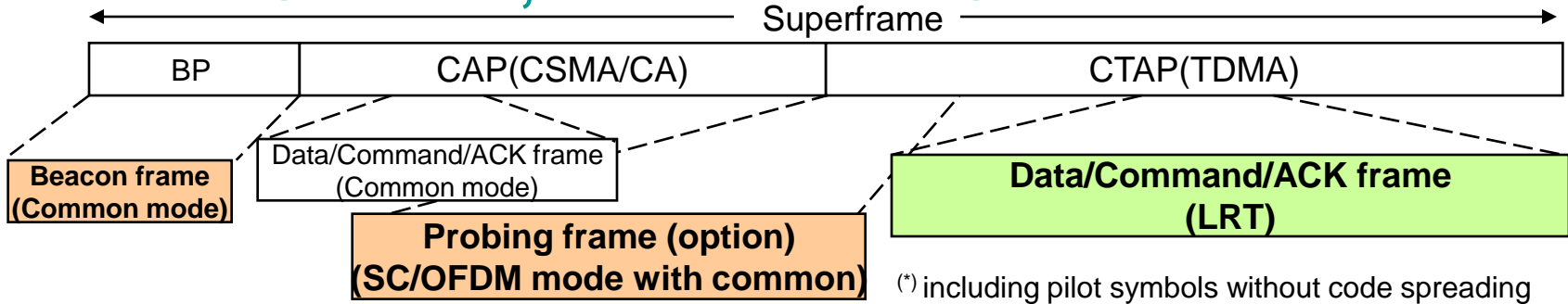

Common mode/ Probing frame (Full-rate channel) 1.632Gsymbol/s

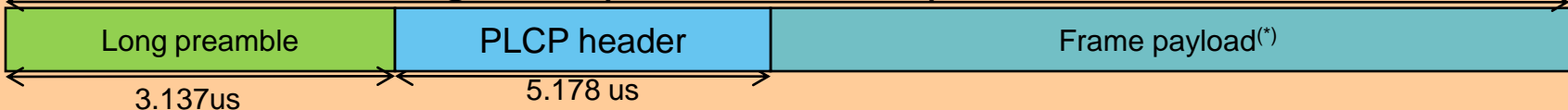

	Preamble	PLCP header	Payload	
Frame type			Common mode frame	Probing frame
Modulation	$\pi/2$ BPSK/GMSK	$\pi/2$ BPSK/GMSK	$\pi/2$ BPSK/GMSK	According to available transmission modes
FEC	N/A	RS(33,17)	RS(255,239)	
Spreading factor	N/A	32 with 1.632 Gcps	32 with 1.632 Gcps	

SC LRT frame (Full-rate channel) 1.632Gsymbol/s

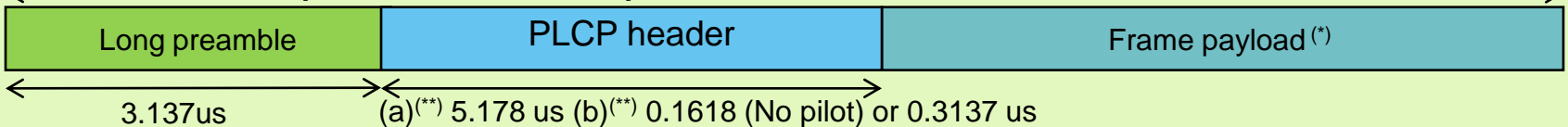

	Preamble	PLCP header	Payload
Modulation	$\pi/2$ BPSK /GMSK	$\pi/2$ BPSK/GMSK	(a) $\pi/2$ BPSK/GMSK (b) $\pi/2$ BPSK/GMSK/MSK/ $\pi/2$ QPSK
FEC	N/A	RS(33,17)	(a) RS(255,239), (b) RS(255,239), LDPC(576,504), LDPC(576,432), LDPC(576,288)
Spreading factor	N/A	(a) 32 chips with 1.632 Gcps or (b) 1 (No spreading) or 2	(a) 2,4,8, or 32 chips with 1.632Gcps (b) 1 (No spreading) or 2

(**)(a) for all cases of spreading payload with spreading factor (of 2,4,8,16, or 32) (b) for all cases of no spreading payload

Frame format of full-rate transmission modes - SC MRT/HRT modes and OFDM modes -

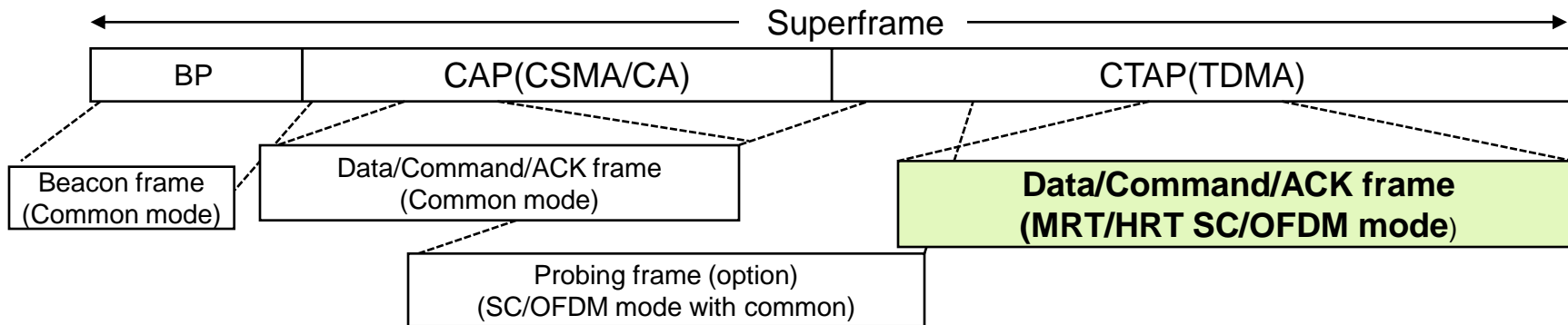

SC MRT/HRT frame (Full-rate channel) 1.632Gsymb/s

The frame structure consists of a Short preamble (1.225 us), a PLCP header (0.1618 us with No pilot or 0.3137 us), and a Frame payload (SC mode) which includes pilot symbols without code spreading mode.

	Preamble	PLCP header	Payload
Modulation	$\pi/2$ BPSK/ GMSK	$\pi/2$ BPSK/GMSK	$\pi/2$ QPSK/ 8PSK
FEC	N/A	RS(33,17)	RS(255,239)/ LDPC(576,504), LDPC(576,432), LDPC(576,288), LDPC(1440, 1344)
Spreading factor	N/A	1	1

OFDM mode frame

OFDM frame format including preamble, PLCP header, and payload

Preamble format

- **Two preamble types**
 - Long preamble is used for CMT, SC LRT and channel probing frames in both half-rate and full-rate
 - Short preamble is used for SC MRT/HRT frames in full-rate
- **Preamble consists of Synchronization (SYNC) sequences and Channel Estimation (CE) sequences**
 - SYNC sequences are used for AGC, antenna diversity, timing detection, coarse AFC, and SFD (start frame delimiter)
 - Long preamble
 - SYNC of 32 'repetitions' (*) of Golay code of 64 chips for half-rate frames
 - SYNC of 32 'repetitions' of Golay code of 128 chips for full-rate frames
 - Short preamble
 - SYNC of 8 'repetitions' of Golay code of 128 chips for full-rate frames
 - SFD is used for the identification of the last SYNC sequence with “-a”
 - 2 sequences are used in CE and fine AFC with cyclic prefix and postfix.
 - Long preamble
 - CE of 4 'repetitions' of Golay code of 128 chips for half-rate frames
 - CE of 4 'repetitions' of Golay code of 256 chips for full-rate frames
 - Short preamble
 - CE of 4 'repetitions' of Golay code of 256 chips for full-rate frames
 - Accompanying cyclic prefix and cyclic postfix are composed of the copy of the last half of the sequence and the first half of the sequence, respectively.

(*)'repetitions': codes may be different (i.e., a , $-a$, b , $-b$), but can be decoded with the same decoder

Preamble format (cont.)

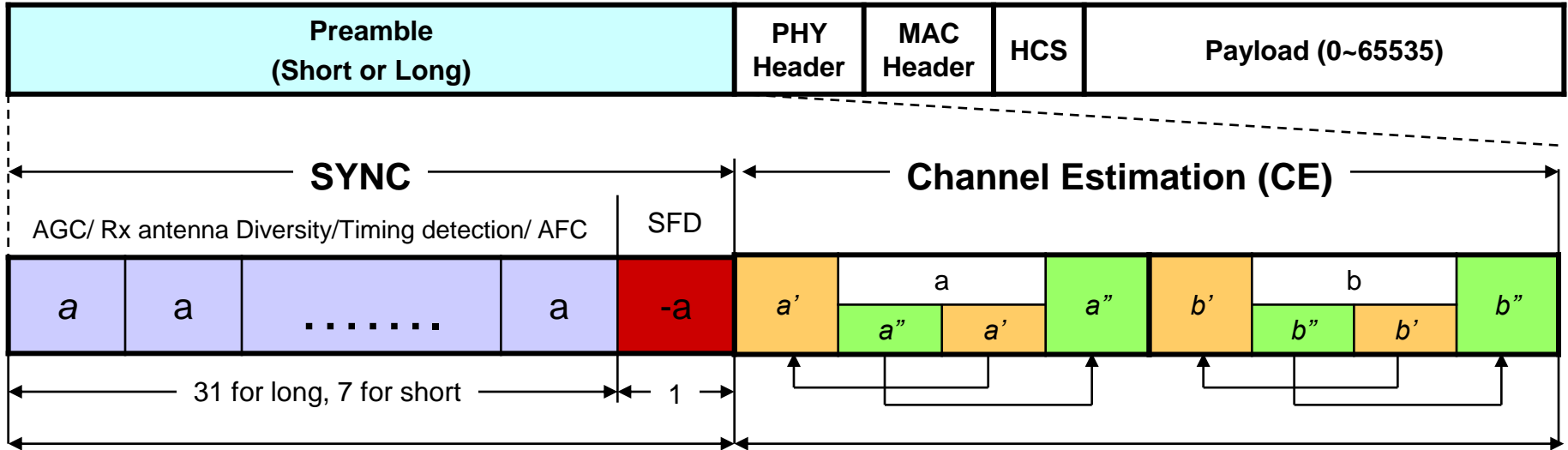

- Long preamble
 - 32 'repetitions' of Golay code of 64@ 0.816Gcps
 - 32 'repetitions' of Golay code of 128@1.632Gcps
- Short preamble
 - 8 'repetitions' of Golay code of 128@1.632Gcps
- [-a] is SFD used for the identification of the last SYNC sequences
- [a], [-a], [b] are Golay code set
- [a] and [b] are complimentary pair of each other
- [a]'s postfix [a''] is a copy of [a]'s last half part, and [a]'s prefix [a'] is a copy of [a]'s first half part
- Same conditions are match with [b][b'][b''] case
- [a] and [b]
 - Golay codes of 128@0.816Gcps in long preamble
 - Golay codes of 256@1.632Gcps in long preamble
 - Golay codes of 256@1.632Gcps in short preamble

Preamble type in each frame		Symbol rate [Gcps]	SYNC	CE	Spreading factor	Total length	
			Code 'repetitions'	Code 'repetitions'	Golay code length	chips	ns
Common mode/ Probing/ LRT SC frames	Long Preamble	0.816	32	4	64 for SYNC 128 for CE	2560	3137
		1.632	32	4	128 for SYNC 256 for CE	5120	3137
MRT/HRT SC frame	Short Preamble	1.632	8	4	128 for SYNC 256 for CE	2048	1255

PLCP and Payload format

- **PLCP and frame payload** are independently segmented into **subBlocks**, accompanying **Golay code-based pilot symbols**, which are between each subBlock
 - SubBlock size: 512 or 256 (TBD) symbols (including data symbols and pilot symbols)
 - Pilot symbol length: 0, 8, 32, or 64 symbols
 - Roll of Pilot symbol
 - **(a) Timing tracking, (b) Compensation for clock drift, and (c) Compensation for frequency offset error that resides after fine AFC and that caused by phase noise in LOS environment**
 - **Cyclic prefix (CP) for frequency domain equalizer (FDE)**
 - Types of pilot symbol insertion
 - Length of 8 symbol: Insertion of Golay codes **a** and **b** by turns
 - Length of 32, or 64 symbol: Insertion of Golay code **a** with length of 32, or 64

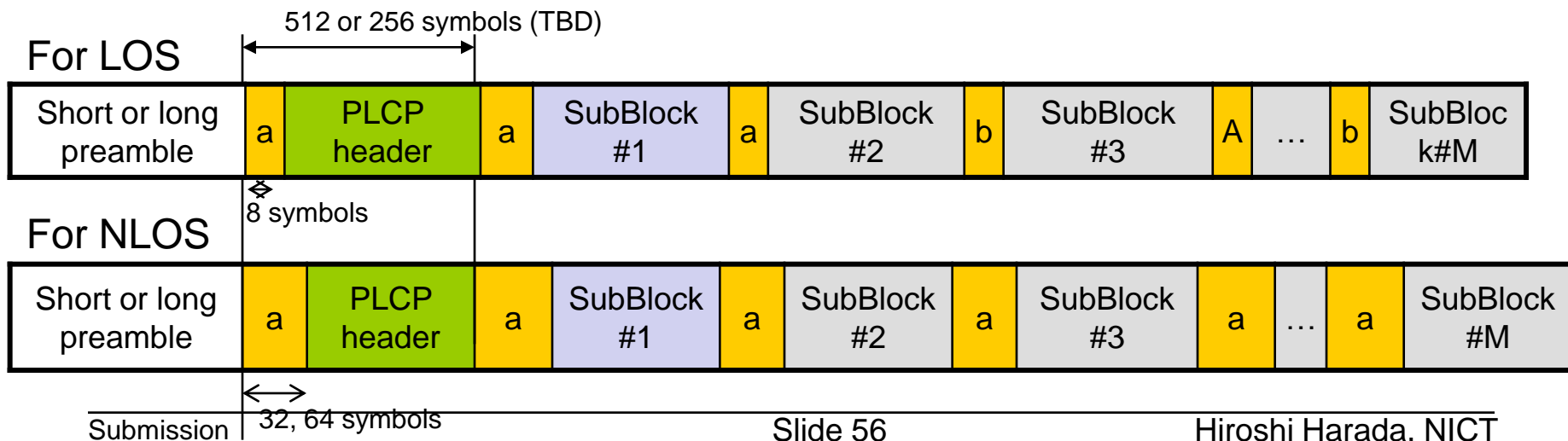

PHY header

- PHY header (5octets) contains
 - **Modulation and Coding (6bits)**
 - indicates modulation and coding information of data frame
 - **UEP information (2bits)**
 - indicates which UEP approach to use
 - **Aggregation information (1bit)**
 - indicates using aggregation or not
 - **Frame length (16bits)**
 - allows maximum 65Kbyte frame
 - **Number of subframes (5bits)**
 - allows up to 32 subframes be aggregated into a single frame
 - **Length of Pilot symbols (3bits) to support mandatory and optional CPs**
 - **Scramble information (2bits)**
 - **Reserved bits (5bits)**

6bits	2bits	1bit	16bits	5bits	3bits	2bits	5bits
Modulation and Coding	UEP information	Aggregation Information	Frame length	Number of subframes	Length of pilot symbols	Scramble information	Reserved bits

Mandatory cyclic prefix design

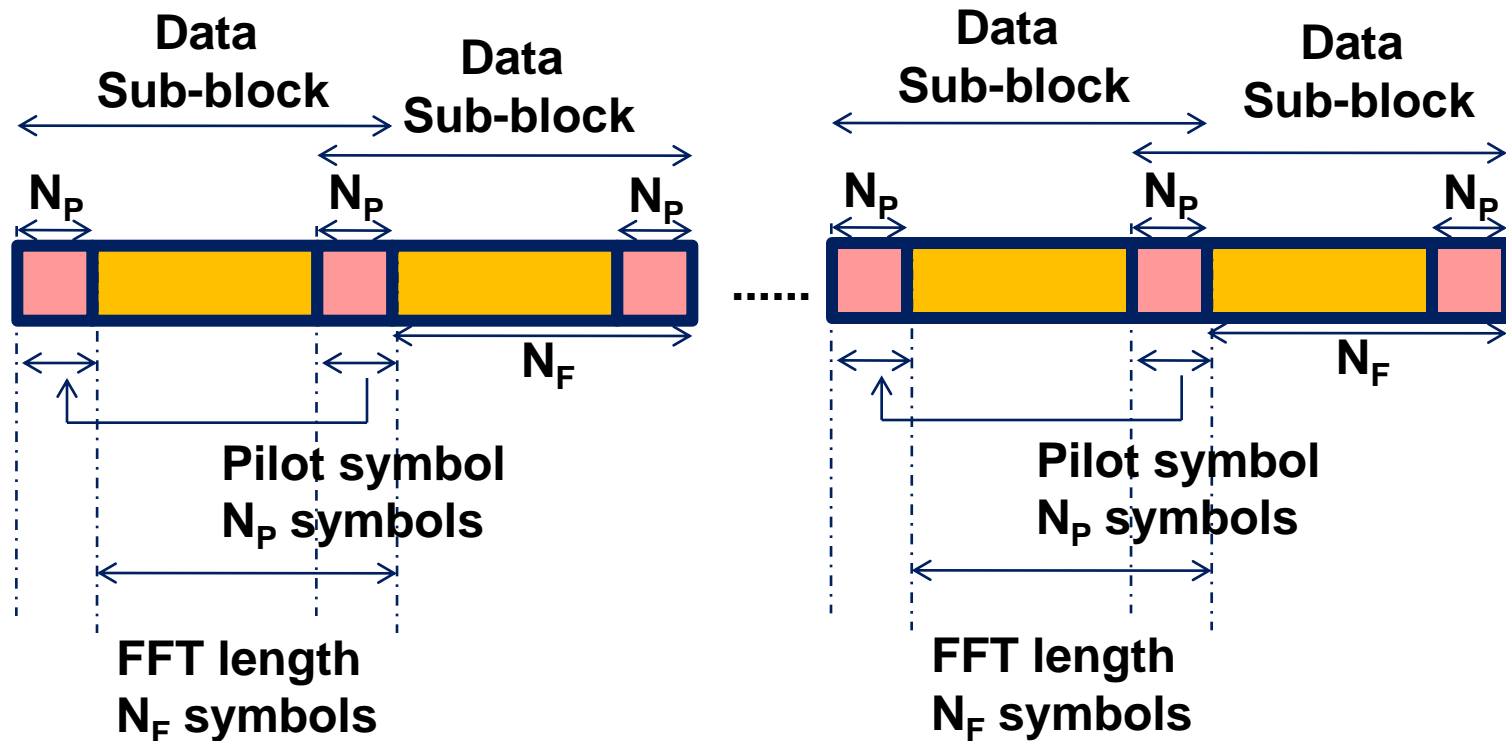

- Golay pilot symbols that can reuse the acquisition hardware
- Can be used for timing control, automatic frequency control, and channel tracking

$N_F=512$ or 256 (TBD)

$N_P=1, 8, 32,$ or 64

Optional cyclic prefix design

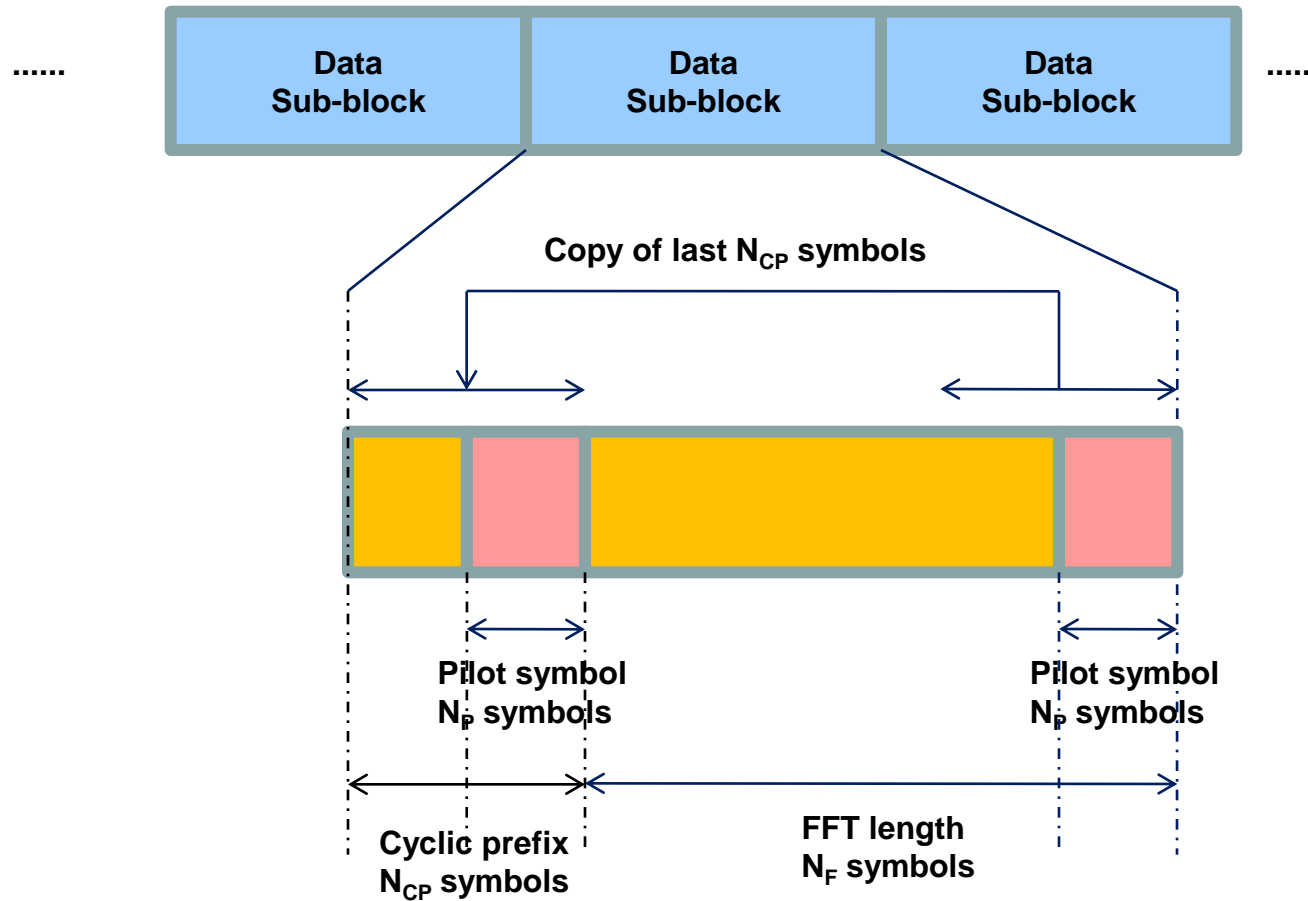

Optional UEP1 (1/3)

- To support **robust and trustworthy frame transmission** for video, audio, encryption keys, and so on, **Unequal Error Protection (UEP)** can be used
- **UEP in MAC and PHY**
 - **MAC operations (Fragmentation and ARQ)**
 - MSDUs are fragmented into subframes with the same length
 - Information of MSB (such as video, audio and encryption keys) is informed to PHY from MAC
 - ARQ for retransmission will be performed
 - **PHY operations (UEP, Aggregation and Frame check)**
 - Subframes of MSB can be protected by MCS with FCS
 - Subframes of MSB and others are aggregated
 - Preamble, header and subheader are added in the aggregated frame
 - Information of subframe check is informed to MAC
- **PHY aggregation**
 - **5-bits Subframe number field** in PHY header allows up to **32 subframes** to be aggregated into a single frame
 - **16-bits Frame length field** in PHY header allows maximum **65 Kbytes frame** be aggregated
- **UEP conditions**
 - MSDUs are fragmented into subframes with the same length in MAC
 - MSDUs shall be exactly divided by the subframe
 - Each subframe shall not contain multiple MSDUs
 - MSB subframes are only protected by MCS

Optional UEP1 (2/3)

- **Subheader** indicates UEP information of subframe
- Subframes of MSB and others are aggregated

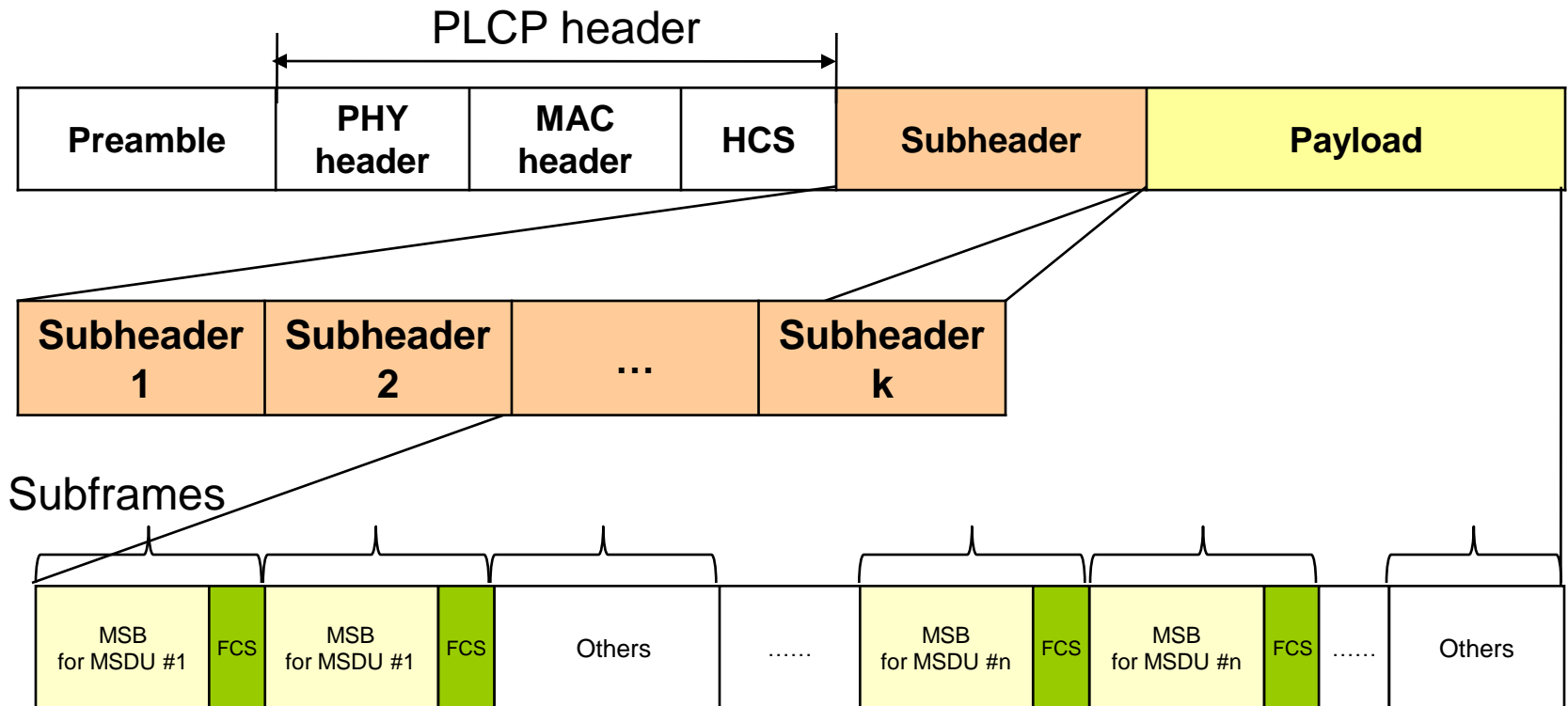

Optional UEP1 (3/3) - Subheader

- **Subheader (32bits per subframe)** includes
 - **MCS (6bits)**
 - Indicates modulation and coding scheme (MCS) of each subframe
 - Supports 64 types of MCS combinations
 - **FCS information (1bit)**
 - Indicates whether to use the frame check sequence (FCS)
 - **MSDU number (9bits)**
 - **Fragment information (2bits)**
 - Indicates the subframe is the first subframe of current MSDU, last subframe of current MSDU, or none of both
 - **Subframe length (12bits)**
 - Indicate the after-coding length of each subframe
 - **Reserved bits (2bits)**

Subheader													
For Subframe 1 (32bits)							For Subframe k (32bits)						
6bits	1bit	9bits	2bits	12bits	2bits		6bits	1bit	9bits	2bits	12bits	2bits	
MCS	FCS information	MSDU number	Fragment information	Subframe length (after coding)	Reserved		MCS	FCS information	MSDU number	Fragment information	Subframe length (after coding)	Reserved	



b5-b0	MCS
000000	No FEC
000001	TBD
...	...
111111	TBD

(*) number of k is up to 32

Optional UEP2 (1/4)

- **UEP coding :**
 - Applying different FEC schemes to MSB and LSB blocks in a subframe.
 - More coding gain is given to MSB's.
 - UEP coding generates new transmission modes (MCS)
- **UEP mapping :**
 - MSB's and LSB's are mapped to I axis and Q axis, respectively in a skewed constellation.
 - More energy is given to MSB's.
 - 1-bit in the PHY header determines the use of UEP mapping
- **Different UEP schemes will be indicated by capability field and some UEP may require an optimized bit-interleaver and multiplexer**

Optional UEP2 (2/4)

PHY Mode	PHY-SAP data rate	Modulation	MSB coding	LSB coding
SC Mode	2040 Mbps	QPSK	LDPC (576,288)	LDPC (576,432)
SC Mode	2562 Mbps	QPSK	LDPC (576,432)	LDPC (576, 504)
SC Mode	3161 Mbps	QPSK	RS (255, 239)	Uncoded
SC Mode	4742 Mbps	8PSK	RS (255, 239)	Uncoded
OFDM mode	1904 Mbps	QPSK	RS + CC 4/7	RS + CC 4/5
OFDM mode	3807 Mbps	16QAM	RS + CC 4/7	RS + CC 4/5

Optional UEP2 (3/4) - Frame format

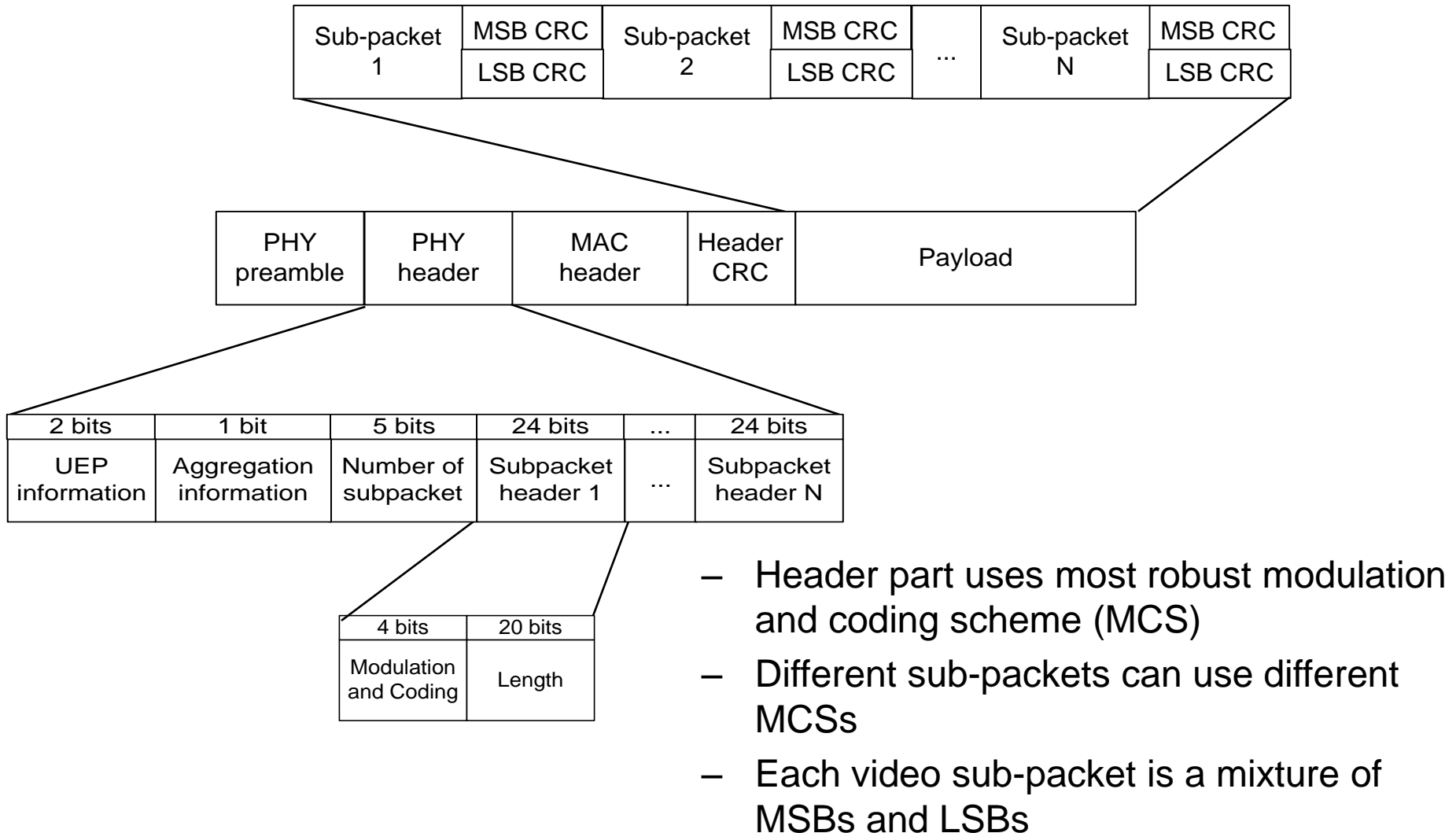

Optional UEP2 (4/4) - ACK Frame

- Selective-ACK for UEP
 - Selective ACKs indicating Separate CRCs for MSB's and LSB's
 - Used for both single MPDU and Aggregated MPDU
- Transmitter can choose appropriate retransmission mechanism depending on the Acknowledgement and available bandwidth
 - MSB/LSB retransmission
 - MSB only
 - LSB only

Optional UEP3

Sequential Packet Based UEP

- Transmit MAC Video Frame Type A and B with different MCSs and different time respectively.
- And they could also be transmitted with different path respectively.
 - e.g. **MAC Video Frame Type A** : Mode A (more robust mode)
 - MAC Video Frame Type B** : Mode B (less robust mode)

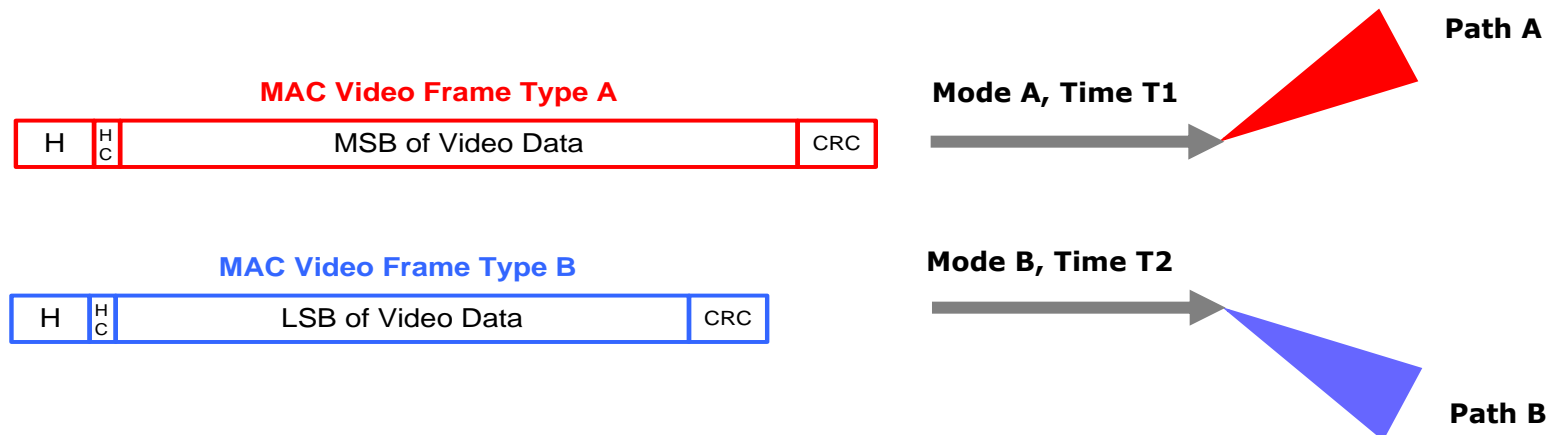

Added

Optional beam forming support 1 (1/2)

- Purposes to include beam forming:
 - to support both omni and directional communications
 - to increase range and/or data rate
- The proposed beam forming method supports both PNC-DEV and DEV-DEV communications
- Beam forming procedure:
 - Beam forming request
 - Step 1*: Beam forming request by DEV and response by PNC, taking place in CAP
 - Beam searching process
 - Step 2 : Beam forming training sequence exchange between PNC-DEV or DEV-DEV, taking place in CTAP
 - Step 3 : Antenna beam forming takes place. Iterations to be performed to form beams with higher directivity, if necessary
 - Beam tracking process
 - Step 4 : Shorter beam training sequence is periodically exchanged to maintain beam forming
 - * In the case of beam forming request coming from the PNC, step 1 does not exist
- The beam training sequence is sent by using the beam forming command frame

Optional beam forming support 1 (2/2) (Example)

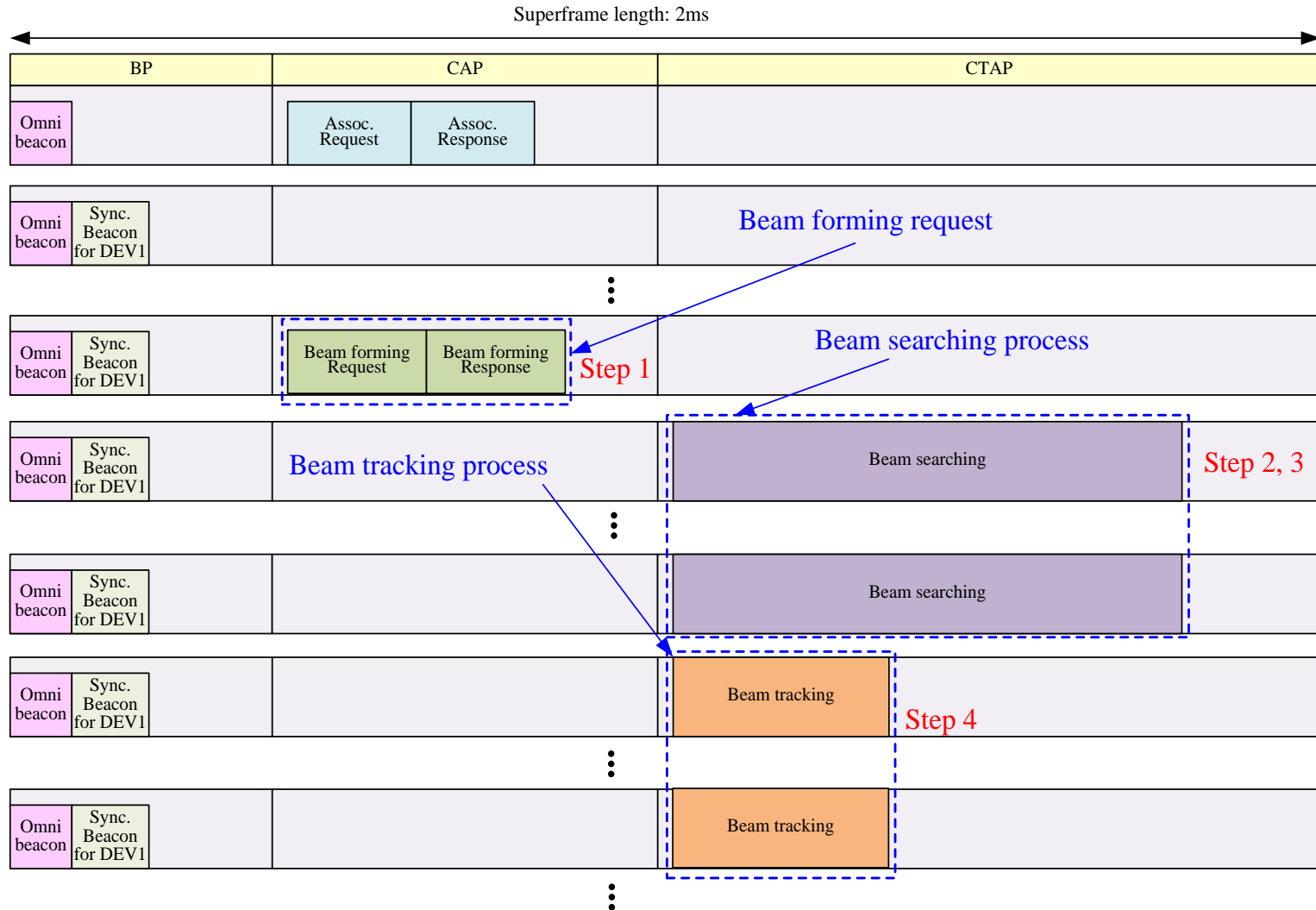

Optional beam forming support 2 (1/2)

- In SYNC beacon, phased array antenna adjusts its phase shifter to mimic the sectored transmission
- Beam search is done using reserved time in CTAP
- Beam tracking is done taking advantage of SYNC beacon
 - SYNC beacon uses the phase shifter calculated from previous beam search or tracking process
 - One time slot in early CTAP is also reserved to complete beam tracking

Optional beam forming support 2 (2/2) (Example)

	Beacon		CAP		CTAP	
SF #65	Omni beacon		DEV1 association			
SF #66	...	Sync BCN for dev1 (using coarse direction 1)				
...	...	Sync BCN for dev1 (using coarse direction)	Dev1 beamforming request			
...	...	Sync BCN for dev1 (using coarse direction 1)			Beamforming training protocol	
SF #128	...	Sync BCN for dev1 (using fine direction 1)			Beam tracking	
SF #129	...	Sync BCN for dev1 (using fine direction 1)			Beam tracking	
SF #130	...	Sync BCN for dev1 (using fine direction 1)			Beam tracking	
...	...	Sync BCN for dev1 (using fine direction 1)			Beam tracking	
SF #192	...	Sync BCN for dev1 (using fine direction 1)	DEV1 disassociation			
SF #193	...					
SF #194	...					
...	...					

- (1) Coarse direction: same direction as ADD.
- (2) Fine direction: steering using the phase shifter acquired during the tracking stage
- (3) Beam search can be triggered by both PNC or DEV. When triggered by DEV, a beamforming request is sent in CAP. When triggered by PNC, no request is needed.

Optional DEV-DEV communication

Antenna direction switching required for DEV-DEV communications while keeping PNC-DEV synchronization

- A) ADD between DEVs after PNC-DEV synchronization
- DEV detection by each other via 'omni' directional antenna
- B) DEV-DEV directional communication
- Directional link between DEVs is maintained

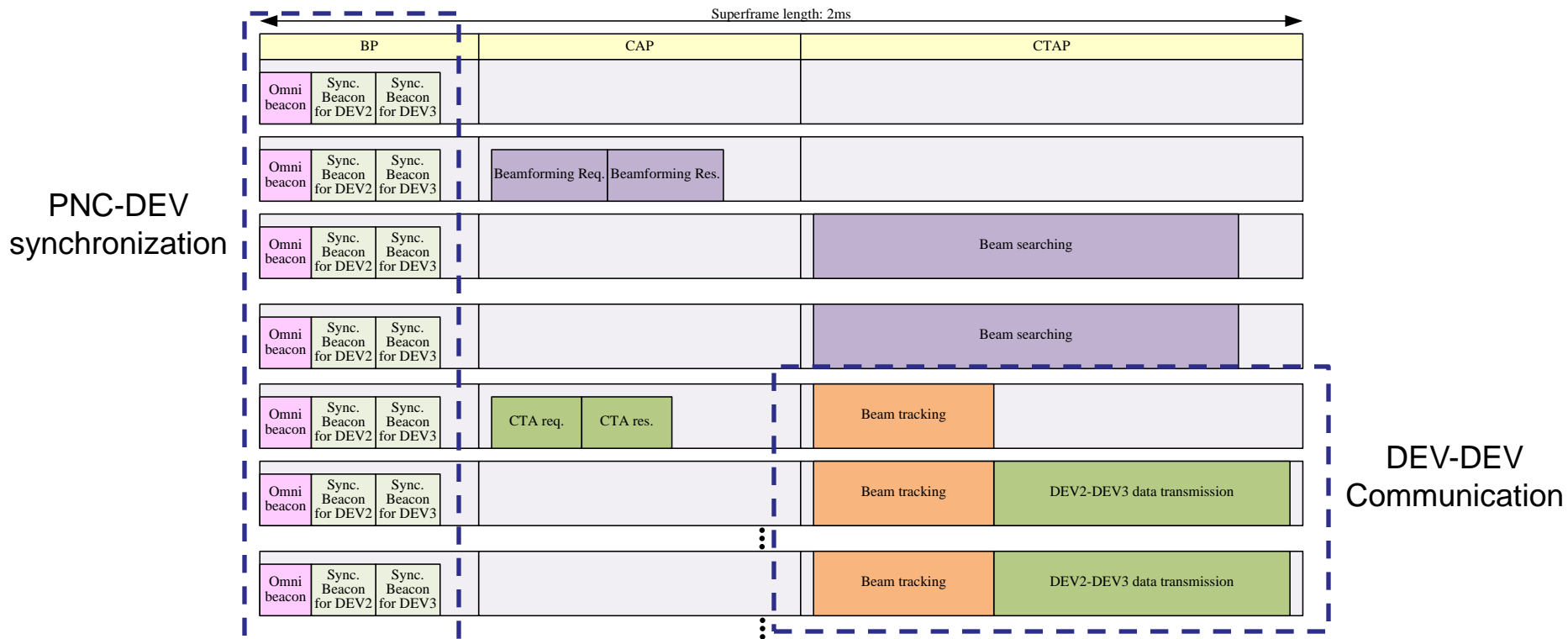

Options under further study (1/3)

- Beacon process overhead
 - The free channel time bit shall be used to indicate whether there is still channel time available to accept new bandwidth reservation request.
 - The Static IE included bit indicates whether static schedule IEs for persistent A/V streams are included in the current beacon or not.
 - The bit of Coordinator Busy or not is used to indicate whether the PNC is available to accept new commands from devices
- Channel bonding for high data rate transmission
- Compressed mode with FUCA(Fast Uplink Channel Allocation)
- Transmit antenna diversity
- 8QAM with a coding rate of 1/3 based on doc# 802.15-0683-07-003c
- Optimum Superframe size for video transmission

Under study

Compressed mode with FUCA

- Compressed Mode*:
 - *Different PHY modes (e.g. constellations) may be used to achieve “compressed mode”.*

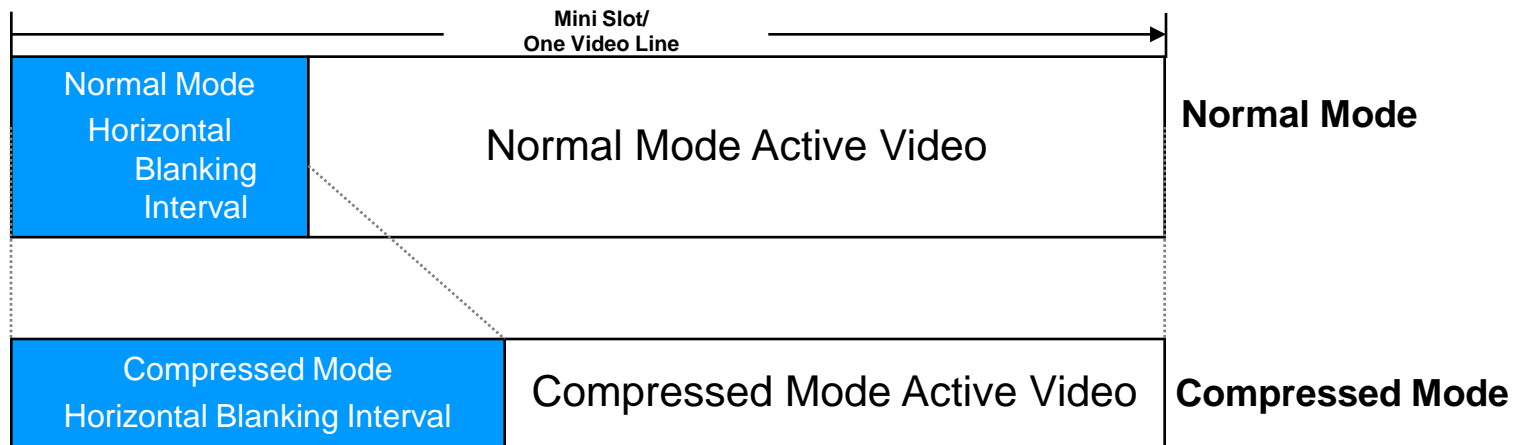

- * **“Compressed” mode refers to the shortening of the video packet length by choosing a higher rate transmission mode (e.g. QPSK as opposed to BPSK). It does not suggest that the video data is compressed.**

Added

Under study

TX Antenna Switch Diversity

- Transmit antenna switch diversity is used to achieve diversity gain from shadowing or blockage.

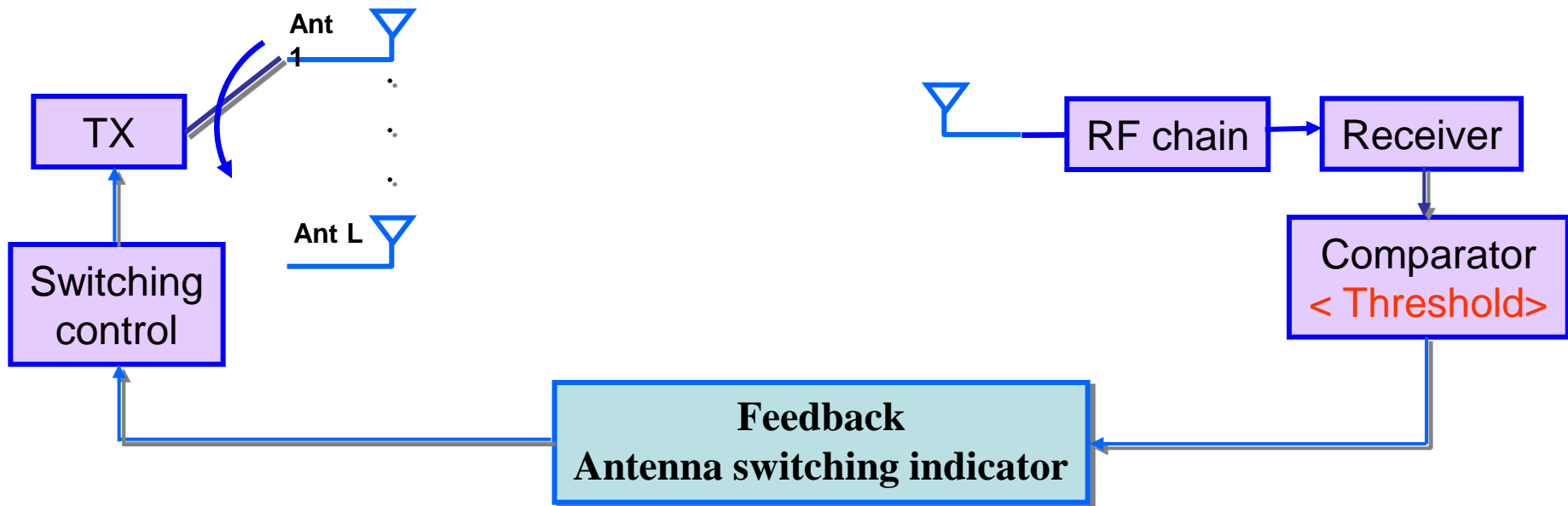

Added

Appendix 1: Summary of half-rate frame format in each mode

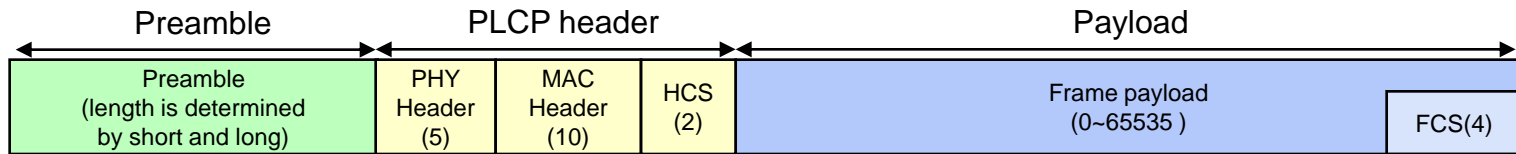

Frame types	PHY-SAP rate	Nyquist BW	Preamble	PLCP header	Payload	Ex. frame
Probing frame (Option)	Variable by SC/OFDM	0.816 GHz	Long preamble	17 octets (Before RS encoding)	0-65535 octets	Channel Probing frame
			0.816 Gbps $\pi/2$ BPSK SYNC (32 repetitions of 64 chips) + CE (4 repetitions of 128 chips)	0.816 Gbps $\pi/2$ BPSK RS(33,17) coding rate (Spreading factor of 16 chips)	SC / OFDM mode	
			3.137 us	5.18 us	-	
LRT SC frame	765 Mbps 383 Mbps 192 Mbps 95.6 Mbps 47.8 Mbps	0.816 GHz	Long preamble	17 octets (Before RS encoding)	0-65535 octets	Data frame
			0.816 Gbps $\pi/2$ BPSK SYNC (32 repetitions of 64 chips) + CE (4 repetitions of 128 chips)	0.816 Gbps $\pi/2$ BPSK RS(33,17) coding rate (Spreading factor of 16 chips)	0.816 Gbps $\pi/2$ BPSK RS(255,239) encoding (Spreading factor of 1, 2, 4, 8 and 16 chips) QPSK without spreading	
			3.137 us	5.18 us	Spreading factor of 1 chips	
					Spreading factor of 2 chips	
					Spreading factor of 4 chips	
					Spreading factor of 8chips	
					Spreading factor of 16chips	

Appendix 2: Summary of full-rate frame format in each mode

Frame types	PHY-SAP rate	Nyquist BW	Preamble	PLCP header	Payload	Ex. frame
Common mode frame	47.8 Mbps	1.632 GHz	Long preamble	17 octets (Before RS encoding)	0~65535 octets	Beacon frame
			1.632 Gbps $\pi/2$ BPSK SYNC (32 repetitions of 128 chips) + CE (4 repetitions of 256 chips)	1.632 Gbps $\pi/2$ BPSK RS(33,17) coding rate (Spreading factor of 32 chips)	1.632 Gbps $\pi/2$ BPSK RS(255,239) encoding (Spreading factor of 32 chips)	
			3.137us	5.18us	-	
Probing frame (Option)	Variable by SC/OFDM	1.632 GHz	Long preamble	17 octets (Before RS encoding)	0~65535 octets	Channel Probing frame
			1.632 Gbps $\pi/2$ BPSK SYNC (32 repetitions of 128 chips) + CE (4 repetitions of 256 chips)	1.632 Gbps $\pi/2$ BPSK RS(33,17) coding rate (Spreading factor of 32 chips)	SC / OFDM mode	
			3.137us	5.18us	-	
LRT SC frame	1530 Mbps 765 Mbps 383 Mbps 192 Mbps 95.6 Mbps 47.8 Mbps	1.632 GHz	Long preamble	17 octets (Before RS encoding)	0~65535 octets	Data frame
			1.632 Gbps $\pi/2$ BPSK SYNC (32 repetitions of 128 chips) + CE (4 repetitions of 256 chips)	1.632 Gbps $\pi/2$ BPSK RS(33,17) coding rate (Spreading factor of 32 chips)	1.632 Gbps $\pi/2$ BPSK RS(255,239) coding rate, LDPC with spreading factor of 1, 2, 4, 8,16, 32 or GMSK/MSK/QPSK without spreading	
			3.137us	5.18us	Spreading factor 1	
					Spreading factor 2	
					Spreading factor 4	
					Spreading factor 8	
					Spreading factor 16	
Spreading factor 32						
MRT/HRT SC frame		1.632 GHz	Short preamble	17 octets (Before RS encoding)	0~65535 octets	Data frame
			1.632 Gbps $\pi/2$ BPSK SYNC (8 repetitions of 128 chips) + CE (4 repetitions of 256 chips)	1.632 Gbps $\pi/2$ BPSK RS(33,17) coding rate without spreading	1.632 Gbps QPSK/8PSK RS(255,239) coding rate, LDPC without spreading	
			1.255us	0.162us	-	

Appendix 3: Automatic frequency control

- Functions of coarse and fine automatic frequency control (AFC) are provided by SYNC and CE sequences, respectively
- A range of estimable frequency offset f_{off} depends on a period between successive two sequences T_{sq} , that is, $|f_{off}| < 1/(2T_{sq})$
 - Coarse AFC: up to 108 ppm @ 60 GHz
 - Fine AFC: up to 27 ppm @ 60 GHz
- Residual frequency offset is reduced to **less than 1 ppm @ 60 GHz** by the joint use of the coarse and fine AFC

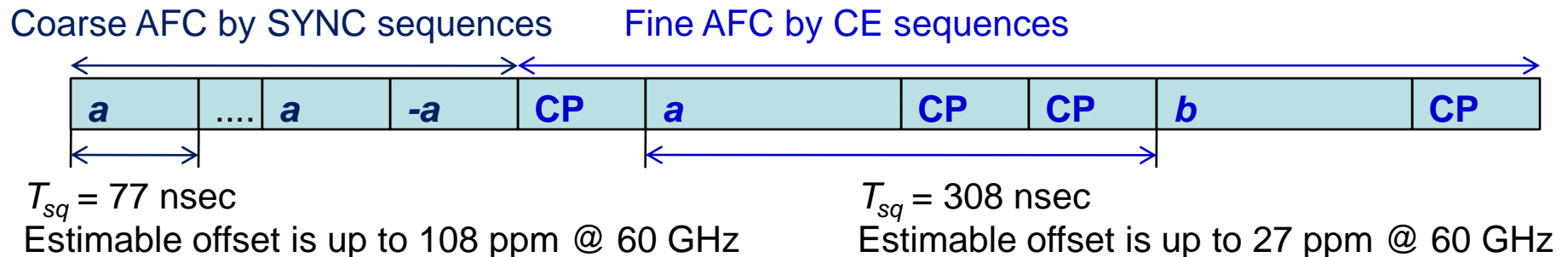

Appendix 4: Throughput and efficiency analysis

- MAC-SAP throughput
= (sum of data payload) / superframe
- Superframe efficiency
= (CAP+CTAP) / superframe
- MAC-SAP efficiency
= (MAC-SAP throughput / PHY-SAP throughput)

