

Project: IEEE P802.15 Working Group for Wireless Personal Area Networks (WPANs)

Submission Title: [Unified and flexible millimeter wave WPAN systems supported by common mode]

Date Submitted: [July 9, 2007]

Source: [Hiroshi Harada (representative contributor), other contributors are listed in “Contributors” slides]

Company [National Institute of Information and Communications Technology (NICT), other contributors are listed in “Contributors” slides]

Address¹[3-4 Hikari-no-oka, Yokosuka-shi, Kanagawa 239-0847, Japan]

Voice:[+81-46-847-5074]

FAX: [+81-46-847-5440]

E-Mail:[harada@nict.go.jp (other contributors are listed in “Contributors” slides)]

Re: [In response to TG3c Call for Proposals (IEEE P802.15-07-0586-02-003c)]

Abstract: [Proposal of unified and flexible millimeter wave WPAN systems supported by common mode]

Purpose: [To be considered in TG3C baseline document.]

Notice: This document has been prepared to assist the IEEE P802.15. It is offered as a basis for discussion and is not binding on the contributing individual(s) or organization(s). The material in this document is subject to change in form and content after further study. The contributor(s) reserve(s) the right to add, amend or withdraw material contained herein.

Release: The contributors acknowledge and accept that this contribution becomes the property of IEEE and may be made publicly available by P802.15.

Unified and flexible millimeter wave WPAN systems supported by common mode

July 9, 2007

Contributors (1/3)

Name	Affiliation	E-mail
Hiroshi Harada	NICT	harada@nict.go.jp
Yozo Shoji	NICT	shoji@nict.go.jp
Fumihide Kojima	NICT	f-kojima@nict.go.jp
Ryuhei Funada	NICT	funada@nict.go.jp
Ming Lei	NICT	minglei@nict.go.jp
Yoshinori Nishiguchi	NICT	nishiguchi@nict.go.jp
Ryota Kimura	NICT	r.kimura@nict.go.jp
Pyo Chang-Woo	NICT	cwpyo@nict.go.jp
Zhou Lan	NICT	lan@nict.go.jp
Sum Chin Sean	NICT	sum@nict.go.jp
Masahiro Umehira	NICT	umehira@mx.ibaraki.ac.jp
Shuzo Kato	NICT	shu.kato@nict.go.jp
Akio Iso	NICT	Akio.Iso@nict.go.jp
Hiroyo Ogawa	NICT	hogawa@nict.go.jp
Kenichi Kawasaki	Sony Corp.	Kenichi.Kawasaki@jp.sony.com
Makoto Noda	Sony Corp.	MakotoB.Noda@jp.sony.com
Hiroyuki Yamagishi	Sony Corp.	Hiroyuki.Yamagishi@jp.sony.com
Masashi Shinagawa	Sony Corp.	Masashi.Shinagawa@jp.sony.com
Keitarou Kondou	Sony Corp.	Keitarou.Kondou@jp.sony.com
Kazuaki Takahashi	Matsushita Electric Co., Ltd.	takahashi.kazu@jp.panasonic.com

Contributors (2/3)

Name	Affiliation	E-mail
Ichihiko Toyoda	NTT Corp.	toyoda.ichihiko@lab.ntt.co.jp
Tomohiro Seki	NTT Corp.	seki.tomohiro@lab.ntt.co.jp
Yasuyuki Ooishi	Fujitsu Limited	yasu@labs.fujitsu.com
Kaoru Yokoo	Fujitsu Limited	yokoo@labs.fujitsu.com
Ichirou Ida	Fujitsu Limited	Ida.ichirou@jp.fujitsu.com
Yukimasa Nagai	Mitsubishi Electric Corp.	Nagai.Yukimasa@ds.MitsubishiElectric.co.jp
Takahisa Yamauchi	Mitsubishi Electric Corp.	Yamauchi.Takahisa@cw.MitsubishiElectric.co.jp
Hideto Ikeda	Oki Electric Industry Co., Ltd.	ikeda637@oki.com
Tadahiko Maeda	Oki Electric Industry Co., Ltd.	maeda097@oki.com
Masamune Takeda	MASPRO DENKOH Corp.	takeda3026@maspro.co.jp
Hiroyoshi Konishi	MASPRO DENKOH Corp.	konishi2761@maspro.co.jp
Shoichi Kitazawa	ATR	kitazawa@atr.jp
Kenichi Maruhashi	NEC Corp.	k-marhashi@bl.jp.nec.com
Yoshitsugu Fujita	KYOCERA Corp.	yoshitsugu.fujita.gt@kyocera.jp
Hiroshi Uchimura	KYOCERA Corp.	hiroshi.uchimura.hs@kyocera.jp
Makoto Ando	Tokyo Institute of Technology	mando@antenna.ee.titech.ac.jp
Yoshio Aoki	Eudyna Devices Inc	y.aoki@eudyna.com
Kazufumi Igarashi	Japan Radio Co., Ltd.	igarashi.kazufumi@jrc.co.jp
Tsukasa Yoneyama	EMMEX, INC.	yoneyama@tohtech.ac.jp
Yukihiro Shimakata	TAIYO YUDEN Co., LTD.	y-shima@jty.yuden.co.jp
Shoji Kuriki	RICOH COMPANY, LTD.	shoji.kuriki@nts.ricoh.co.jp
Toyoo Tanaka	Toyo System Engineering Co., Ltd.	toyoo_tanaka@u-tse.co.jp

Contributors (3/3)

Name	Affiliation	E-mail
André Bourdoux	IMEC	bourdoux@imec.be
Jimmy Nsenga	IMEC	nsengaj@imec.be
Wim Van Thillo	IMEC	vthillo@imec.be
Stefaan De Rore	IMEC	derore@imec.be
Pascal Pagani	France Telecom	pascal.pagani@orange-ftgroup.com
Isabelle Siaud	France Telecom	isabelle.siaud@orange-ftgroup.com
Wei Li	France Telecom	wei3.li@orange-ftgroup.com
Anne-Marie Ulmer-Moll	France Telecom	annemarie.ulmermoll@orange-ftgroup.com
Marie-Hélène Hamon	France Telecom	mhelene.hamon@orange-ftgroup.com
Maxim Piz	IHP	piz@ihp-microelectronics.com
Eckhard Grass	IHP	grass@ihp-microelectronics.com
Klaus Tittelbach	IHP	tittelbach@ihp-microelectronics.com
Frank Herzel	IHP	herzel@ihp-microelectronics.com
Alberto Valdes Garcia	IBM	avaldes@us.ibm.com
Troy Beukema	IBM	troyb@us.ibm.com
Yasunamo Katayama	IBM	yasunaok@jp.ibm.com
Brian Floyd	IBM	brianfl@us.ibm.com
Scott Reynolds	IBM	skreyn@us.ibm.com
Daiju Nakano	IBM	dnakano@jp.ibm.com
Bruce Bosco	Motorola, Inc.	Bruce.A.Bosco@Motorola.com
Paul Gorday	Motorola, Inc.	Paul.Gorday@Motorola.com

Collaboration under study

- New LANs
- National Taiwan University
- Panasonic
- Philips
- Tensorcom Inc.
- Tohoku Univ.

Summary of COMPA Channel Plan

– Full-rate channel plan

- Four full-rate channels in 9 GHz BW
- Channel separation: 2160 MHz
- Nyquist bandwidth: 1632 MHz
- Supporting common mode with data rate of 47.8 Mbps, as well as LRTs, MRTs, and HRTs with data rates of up to 4.59 Gbps in SC mode or up to 6.0 Gbps in OFDM mode

– Half-rate channel plan

- Four half-rate channels with the same center frequencies as the full-rate channels
- Channel separation: 2160 MHz
- Nyquist bandwidth: 816 MHz (half symbol and sampling rates)
- Supporting common mode with data rate of 47.8 Mbps **using 1 GHz Tx and Rx filters and the same modulation format as common mode for full-rate channels**
- Supporting LRTs with several data rates of up to 1530 Mbps using $\pi/2$ DBPSK (RS(255,239)) in SC mode

CoMPA Full-rate (2GHz) Channel Plan

Channel Number	Low Freq. (GHz)	Center Freq. (GHz)	High Freq. (GHz)	Nyquist BW (MHz)	Roll-Off Factor
A1	57.240	58.320	59.400	1632	0.3235
A2	59.400	60.480	61.560	1632	0.3235
A3	61.560	62.640	63.720	1632	0.3235
A4	63.720	64.800	65.880	1632	0.3235

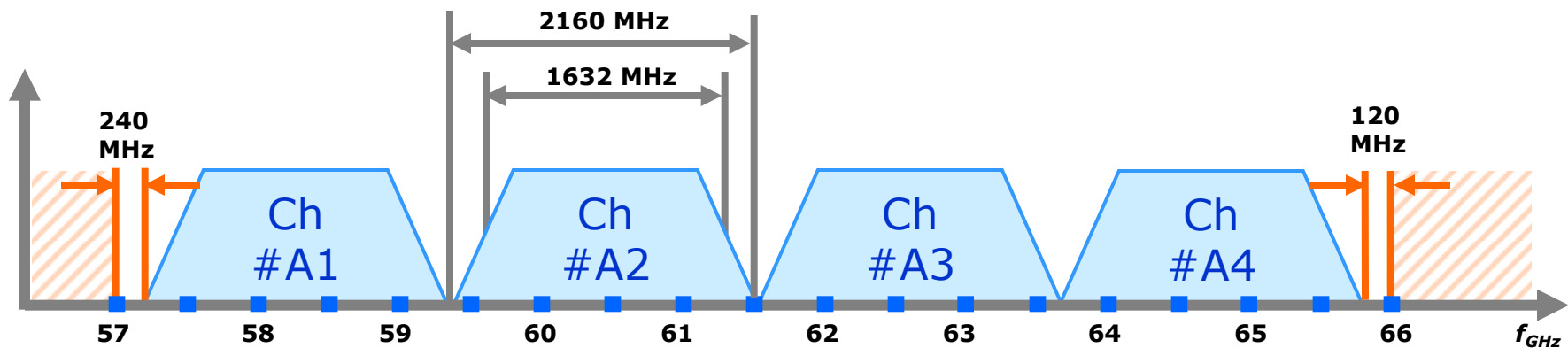

- Support cell phone XTALs: **19.2 MHz**, 24 MHz & other high frequency XTALs: **54 MHz, 60 MHz, 108 MHz, ...**
- Balanced margins to 57/66 GHz & good roll-off factor
- Supports multiple PLL architectures with the cell phone XTAL
- Dual PLL: High frequency PLL that generates carrier frequencies
Low frequency PLL that generates ADC/DAC & ASIC frequencies

CoMPA Half-rate (1GHz) Channel Plan

Channel Number	Low Freq. (GHz)	Center Freq. (GHz)	High Freq. (GHz)	Nyquist BW (MHz)	Roll-Off Factor
B1	57.78	58.32	58.86	816	0.3235
B2	59.94	60.48	61.02	816	0.3235
B3	62.10	62.64	63.18	816	0.3235
B4	64.26	64.80	65.34	816	0.3235

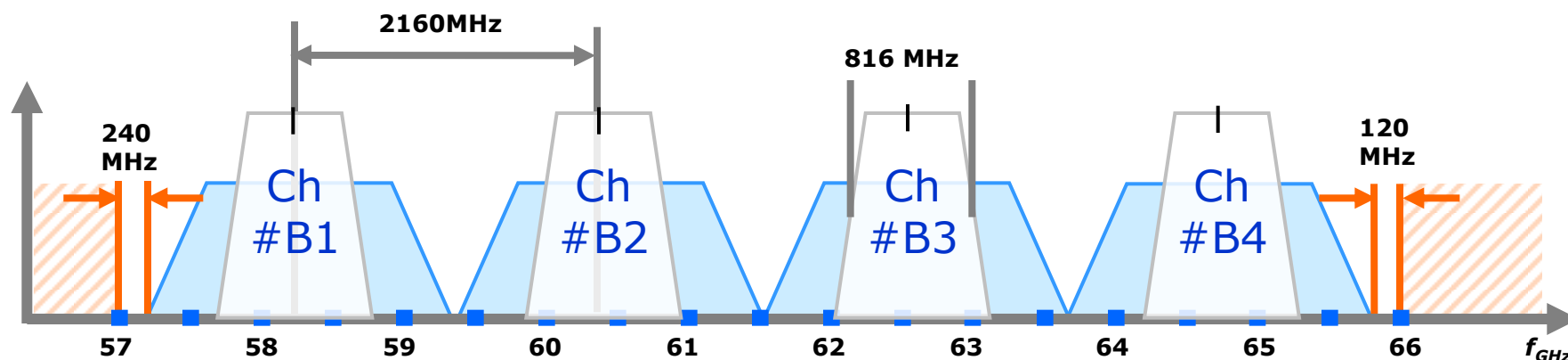

- Channel separation: 2160 MHz
- Same XTAL support and PLL architecture as full-rate channelization
- Chs B1, B2, B3, and B4 have the same center frequencies as Chs A1, A2, A3, and A4, respectively

PHY Mode

- 4 types of multi-rate transmission based on PHY-SAP data rate
 - Common mode transmission (CMT) : 47.8 Mbps
 - Low rate transmission (LRT) : up to 2 Gbps
 - Medium rate transmission (MRT) : from 2 Gbps to 3 Gbps
 - High rate transmission (HRT) : over 3 Gbps

- Common mode -

PHY Mode	Transmission Mode	PHY-SAP data rate	Nyquist BW	Modulation	Coding	Spreading factor	MAC-SAP data rate
Common mode	Common mode transmission (CMT)	47.8 Mbps	1.632 GHz	$\pi/2$ DBPSK	RS(255,239)	32	36.8 Mbps

- Optional Polling Signal mode-

PHY Mode	Transmission Mode	PHY-SAP data rate	Nyquist BW	Modulation	Coding	Spreading factor	MAC-SAP data rate
Polling mode	Polling transmission (PT)	47.8 Mbps	1.632 GHz	OOK	RS(255,239)	32	36.8 Mbps

PHY Mode

- SC LRT(up to 2 Gbps) -

PHY Mode	Transmission Mode	PHY-SAP data rate	Nyquist BW	Modulation	Coding	Spreading factor	MAC-SAP data rate
SC mode	LRT 1	47.8 Mbps	0.816GHz	$\pi/2$ DBPSK	RS(255,239)	16	36.8 Mbps
	LRT 2	95.6 Mbps				8	73.6 Mbps
	LRT 3	192 Mbps				4	147.2 Mbps
	LRT 4	383 Mbps				2	294 Mbps
	LRT 5	765 Mbps				-	581 Mbps
	LRT 6	1530 Mbps				-	1136 Mbps
	LRT 7	47.8 Mbps	1.632GHz	$\pi/2$ DBPSK	RS(255,239)	32	36.8 Mbps
	LRT 8	95.6 Mbps				16	73.6 Mbps
	LRT 9	192 Mbps				8	147.2 Mbps
	LRT 10	383 Mbps				4	294 Mbps
	LRT 11	765 Mbps				2	581 Mbps
	LRT 12	1530 Mbps				-	1136 Mbps
	LRT 13	816 Mbps		$\pi/2$ DBPSK	LDPC(576,288)	-	638 Mbps
	LRT 14	1224 Mbps			LDPC(576,432)	-	957 Mbps
	LRT 15	816 Mbps		GMSK	LDPC(576,288)	-	638 Mbps
	LRT 16	1224 Mbps			LDPC(576,432)	-	957 Mbps
	LRT 17	1530 Mbps			RS(255,239)	-	1186 Mbps
	LRT 18	1530 Mbps		MSK	RS(255,239)	-	1186 Mbps
	LRT 19	1632 Mbps		QPSK	LDPC(576, 288)	-	1267 Mbps
	LRT 20	383 Mbps		OOK	RS(255,239)	4 (4 repetitions)	294 Mbps
	LRT 21	765 Mbps				2 (2 repetitions)	581 Mbps
	LRT 22	1530 Mbps				-	1186 Mbps

- PHY-SAP data rate is shown in case of cyclic prefix (CP =0)
- PHY-SAP data rate (CP=8) has PHY-SAP data rate (CP=0) of 97%
- PHY-SAP data rate (CP=64) has PHY-SAP data rate (CP=0) of 75%
- MAC-SAP data rate (CP=8) has PHY-SAP data rate (CP=8) of 77%
- MAC-SAP data rate (CP=64) has PHY-SAP data rate (CP=64) of 77%

PHY Mode

- SC MRT(from 2 Gbps to 3 Gbps) -

PHY Mode	Transmission Mode	PHY-SAP data rate	Nyquist BW	Modulation	Coding	MAC-SAP data rate
SC mode	MRT 1	2448 Mbps	1.632 GHz	QPSK	LDPC(576, 432)	1872 Mbps
	MRT 2	2856 Mbps			LDPC(576, 504)	2175 Mbps

- PHY-SAP data rate is shown in case of cyclic prefix (CP =0)
- PHY-SAP data rate (CP=8) has PHY-SAP data rate (CP=0) of 97%
- PHY-SAP data rate (CP=64) has PHY-SAP data rate (CP=0) of 75%
- MAC-SAP data rate (CP=8) has PHY-SAP data rate (CP=8) of 77%
- MAC-SAP data rate (CP=64) has PHY-SAP data rate (CP=64) of 77%

PHY Mode

- SC HRT(over 3 Gbps) -

PHY Mode	Transmission Mode	PHY-SAP data rate	Nyquist BW	Modulation	Coding	MAC-SAP data rate
SC mode	HRT 1	3046 Mbps	1.632 GHz	QPSK	LDPC(1440,1344)	2322 Mbps
	HRT 2	3059 Mbps			RS(255,239)	2331 Mbps
	HRT 3	3049 Mbps		TC8PSK	LDPC(1440,1344)	2322 Mbps
	HRT 4	3059 Mbps			RS(255,239)	2331 Mbps
	HRT 5	4284 Mbps		8PSK	LDPC(576,504)	3197 Mbps
	HRT 6	4570 Mbps			LDPC(1440,1344)	3401 Mbps
	HRT 7	4589 Mbps			RS(255,239)	3401 Mbps

- PHY-SAP data rate is shown in case of cyclic prefix (CP =0)
- PHY-SAP data rate (CP=8) has PHY-SAP data rate (CP=0) of 97%
- PHY-SAP data rate (CP=64) has PHY-SAP data rate (CP=0) of 75%
- MAC-SAP data rate (CP=8) has PHY-SAP data rate (CP=8) of 77%
- MAC-SAP data rate (CP=64) has PHY-SAP data rate (CP=64) of 77%

PHY Mode

- OFDM LRT(up to 2 Gbps) -

PHY Mode	Transmission Mode	PHY-SAP data rate	Bandwidth	Modulation	Coding	Code Rate	Spreading factor
OFDM mode	LRT1	375 Mbps	1 GHz (incl. guard band)	BPSK	Convolutional Code + RS, LDPC, Turbo Codes [TBD]	1/2	
	LRT2	500 Mbps		BPSK		2/3	
	LRT3	750 Mbps		QPSK		1/2	
	LRT4	1000 Mbps		QPSK		2/3	
	LRT5	1500 Mbps		16-QAM		1/2	
	LRT6	750 Mbps	2 GHz (incl. guard band)	BPSK		1/2	
	LRT7	1000 Mbps		BPSK		2/3	
	LRT8	1500 Mbps		QPSK		1/2	
	LRT9	680 Mbps	1632 MHz	QPSK	LDPC	1/2	2
	LRT10	1360 Mbps			1/2		
	LRT11	868 Mbps			1/3		
	LRT12	1735 Mbps			2/3		
	LRT13	1735 Mbps			1/3		

PHY Mode

- OFDM MRT (from 2 Gbps to 3 Gbps) -

PHY Mode	Transmission Mode	PHY-SAP data rate	Bandwidth	Modulation	Coding	Code Rate
OFDM mode	MRT1	2000 Mbps	1 GHz (incl. guard band)	16-QAM	Convolutional Code + RS, LDPC, Turbo Codes [TBD]	2/3
	MRT2	2500 Mbps		16-QAM		5/6
	MRT3	3000 Mbps		64-QAM		2/3
	MRT4	2000 Mbps	2 GHz (incl. guard band)	QPSK		2/3
	MRT5	3000 Mbps		16-QAM		1/2
	MRT6	2040 Mbps	1632 MHz	QPSK	LDPC	3/4
	MRT7	2380 Mbps				7/8
	MRT8	2720 Mbps		16-QAM		3/4
	MRT9	2082 Mbps		QPSK	Convolutional code +RS	4/5

PHY Mode

- OFDM HRT (over 3 Gbps) -

PHY Mode	Transmission Mode	PHY-SAP data rate	Bandwidth	Modulation	Coding	Code Rate
OFDM mode	HRT1	4000 Mbps	2 GHz (incl. guard band)	16-QAM	Convolutional Code + RS, LDPC, Turbo Codes [TBD]	2/3
	HRT2	5000 Mbps		16-QAM		5/6
	HRT3	6000 Mbps		64-QAM		2/3
	HRT4	4080 Mbps	1632 MHz	16-QAM	LDPC	3/4
	HRT5	4760 Mbps				7/8
	HRT6	3470 Mbps			Convolutional code +RS	2/3
	HRT7	4160 Mbps				4/5

802.15.3c Major MAC Attributes for PHY Design

1. Channel Scan

- Common mode beacon

2. Automatic Device Discovery

- ADD for directional ant. only
- ADD for directional ant. with omni
- Multi-superframe distributed process

3. Channel Probing

- Channel estimation in CAP

4. Data Communication

- 4 communication types

5. Superframe

- Superframe
- Beacon period
- ADD superframe
- Multiple beacons
- CAP
- CTAP

6. Frame format

- Frame types
- Preamble
- PLCP header
- Payload

7. Frame aggregation with UEP

Summary

- **Common mode supports**
 - Channel scan by beacons in common mode
 - Automatic device discovery
- **Automatic device discovery (ADD)** is designed for device discovery in two antenna cases of directional antenna only or directional antenna with omni
- **Channel probing (option)** by using SC/OFDM frame with preceding common preamble and PLCP Header (for best fitting air interface)
- **Four communication types support depending on SC and/or OFDM**
- **Superframe**
 1. Superframe length: 2ms
 2. Beacon period : 0.2ms
 3. ADD superframe length: 64 superframes (=128ms)
 4. Multiple beacons for SC, OFDM and OOK DEVs
 5. Transmission in beacon period is CMT of 47.8 Mbps ($\pi/2$ DBPSK, RS)
 6. Transmission in CAP is CMT (optionally allows channel probing mode)
 7. Transmission in CTAP are variable from LRT to HRT, and Common/SC/OFDM data transmission is simultaneously supported in CTAP
- **Frame format**
 1. Frame types are CMT, SC LRT, channel probing, SC MRT/HRT SC, and OFDM mode frames
 2. Preamble
 - Long preamble for CMT, SC LRT and channel probing frames
 - SYNC of 32 repetitions of Golay code of 64 chips and CE of 4 repetitions of Golay code of 128 chips for half-rate frames
 - SYNC of 32 repetitions of Golay code of 128 chips and CE of 4 repetitions of Golay code of 256 chips for full-rate frames
 - Short preamble for SC MRT/HRT frames
 - SYNC of 8 repetitions of Golay code of 128 chips and CE of 4 repetitions of Golay code of 256 chips for full-rate frames
 3. PLCP header
 - (a) **Common mode and channel probing frames:** protected with RS code ($R=1/2$) and with code spreading by Golay code of 32 chips@1.632Gcps
 - (b) **SC LRT frames with spreading payload:** protected with RS code ($R=1/2$) and with code spreading by Golay code of 16 chips@0.816Gcps or 32 chips@1.632Gcps
 - (c) **SC LRT frames without spreading payload, MRT, and HRT frames** Protected with only RS ($R=1/2$) (i.e., without code spreading)
 4. Payload
 - (a) **Common mode frames:** $\pi/2$ DBPSK and RS (255,239) and code spreading by Golay code of 32 chips@1.632 Gcps
 - (b) **SC LRT frames with spreading payload :** $\pi/2$ DBPSK and RS (255,239) and **code spreading by Golay code of 2,4,8,16** chips@0.816Gcps or 2,4,8,16, 32chips@1.632Gcps
 - (c) **SC LRT frames without spreading payload, and SC MRT/HRT frames:** no spreading
- **Frame aggregation with UEP** (maximum aggregated size of 64Kbytes) are supported

802.15.3c Piconet

- 802.15.3c piconet consists of a piconet coordinator (PNC) and devices (DEVs)
- PNC and DEVs are capable of **Single Carrier (SC), and/or OFDM air interfaces, and directional antenna or directional antenna with omni**
- 802.15.3c piconet supports
 - **Four communication types**
 1. Type 1: Common mode/LRT mode
 2. Type 2: Common/LRT and SC MRT/HRT modes
 3. Type 3: Common/LRT and OFDM modes
 4. Type 4: Common/LRT, SC MRT/HRT and OFDM modes
 - Automatic device discovery (ADD)
 - **ADD is designed for device discovery** in two antenna cases of **directional antenna only** and **directional antenna with omni**

Basic operations in Piconet

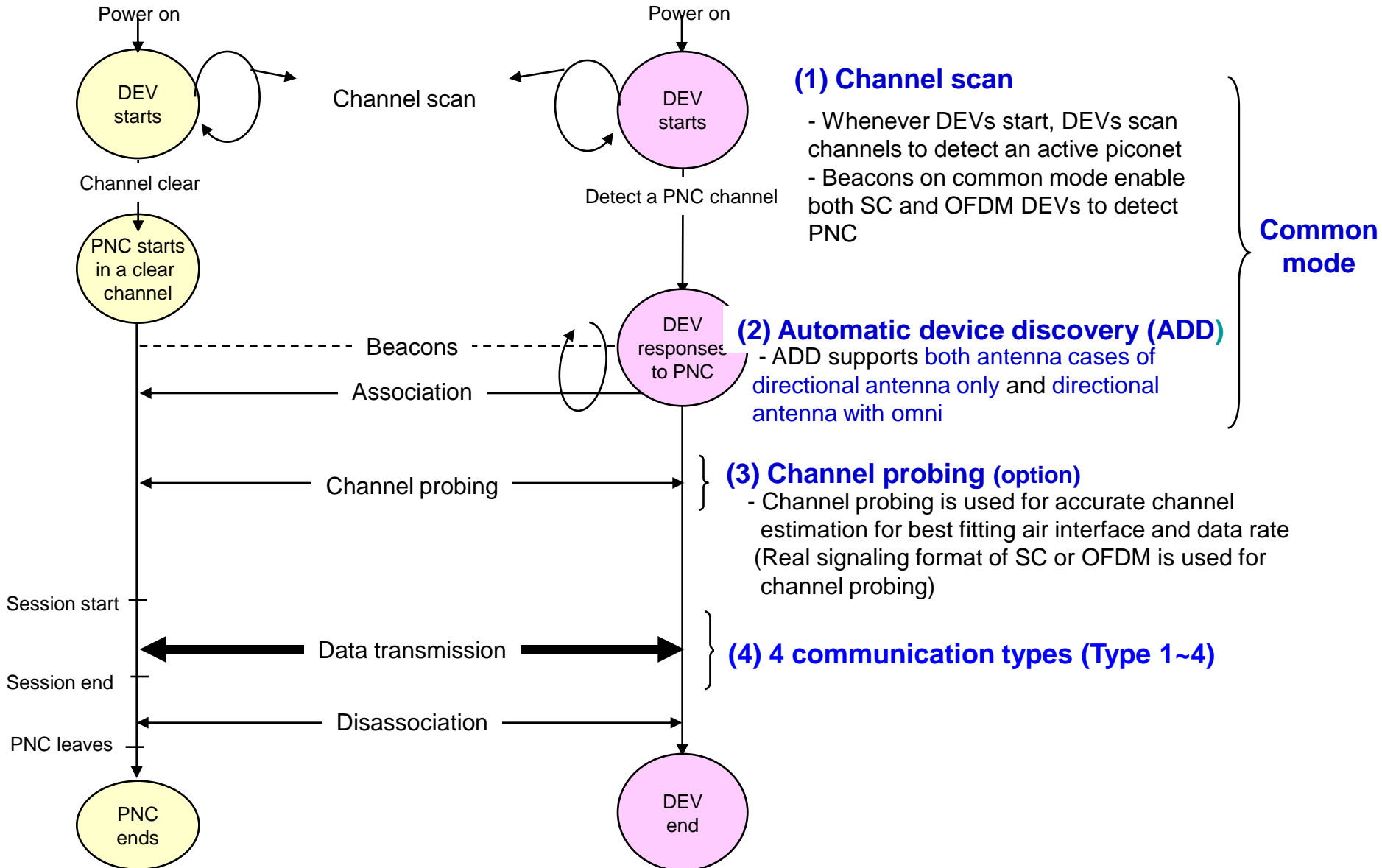

Common Mode

(Simple Single Carrier bridging different air interfaces)

- **Both SC and OFDM air interfaces** are **simultaneously** supported on top of common mode frame
- **Common mode: simple single carrier ($\pi/2$ DBPSK with Reed Solomon as FEC)** for robust and longer transmission range
- **Common mode** is to **bridge an air interface to different air interfaces** best fitting to the applications
- **Common mode** is used for **beacon and association** (automatic device discovery)

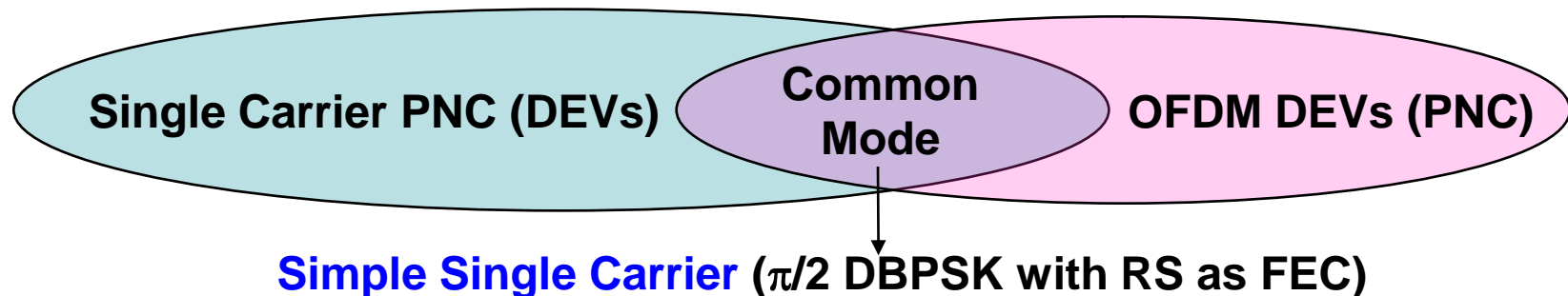

Channel Scan

(To detect piconet on common mode)

1. To initiate channel scan, PNC shall broadcast **beacons in common mode** omni or directionally according to antenna capability
 - **Beacons on common mode** enable both SC and OFDM DEVs to detect PNC
 - **Transmission rate of beacons is 47.8 Mbps ($\pi/2$ DBPSK with RS)**
2. To detect an active piconet, DEVs scan **beacons on common mode** broadcasted from PNC

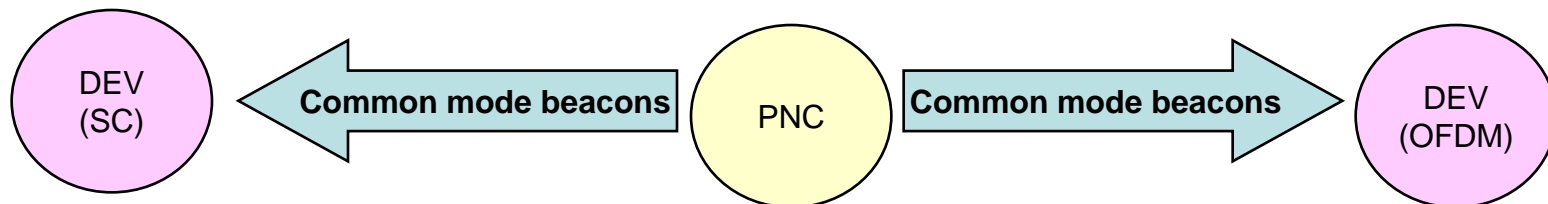

2.DEV (SC) scans beacons on common mode omni or directionally

1. Beacons on common mode are broadcasted omni or directionally

2.DEV (OFDM) scans beacons on common mode omni or directionally

Automatic device discovery (ADD)

(For devices with “directional antenna only” or “directional antenna with omni”)

- In both UM1 and UM5, devices will use directional antenna only or directional antenna with omni for high data rate transmission
- **Directional antenna with n Tx/Rx directions**
 - n is the number of available Tx/Rx directions
 - **Omni antenna** is a special case of directional antenna ($n = 1$)
- ADD processes are categorized into **2 ADDs** from MAC functionality viewpoint
 - **ADD 1 : PNC is capable of a directional antenna only with n Tx/Rx directions**
 - n number of beacons are broadcasted directionally in n different Tx/Rx directions
 - **ADD 2 : PNC is capable of a directional antenna with n Tx/Rx directions and with omni**
 - Omni antenna is used for detection and association between PNC and DEV to start with
 - For high rate transmission where **directional antenna is demanded**, n number of beacons are broadcasted directionally in n different Tx/Rx directions

Channel probing

(Accurate channel estimation for best fitting air interface and data transmission rate)

- **Channel probing (option)** is used for **accurate channel estimation** for best fitting air interface and data transmission
- **Real signaling format of SC or OFDM following common mode preamble and header** is used to estimate both forwarding and backwarding channel conditions
- **Channel probing** can be done in either **CAP** or **CTAP**

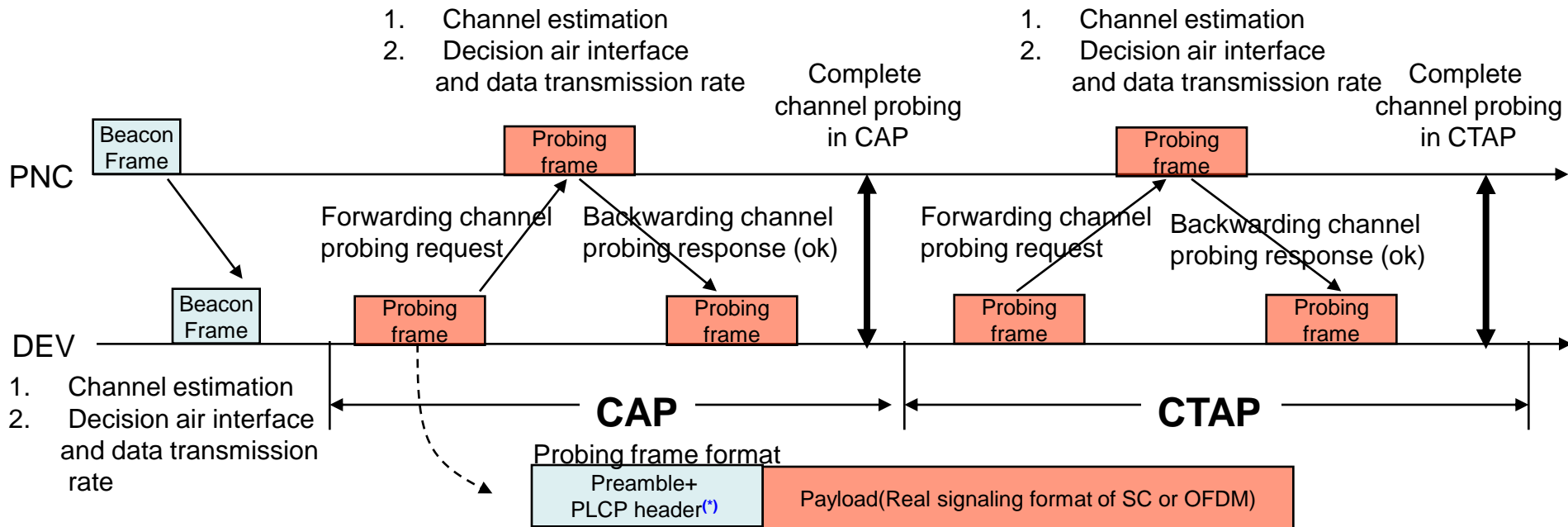

(*) same as those of common mode frame

Data communication

(Four communication types of Common/LRT only, Common/LRT+MRT/HRT SC, Common/LRT+OFDM and Common/LRT+MRT/HRT SC+OFDM)

- **Four types of communications between PNC and DEV**
 1. Type1: **Common/LRT** mode for both Single Carrier and OFDM Devices
 2. Type2: **Common/LRT** and **Single Carrier MRT/HRT** modes
 3. Type3: **Common/LRT** and **OFDM** modes
 4. Type4: **Common/LRT, Single Carrier MRT/HRT** and **OFDM** modes

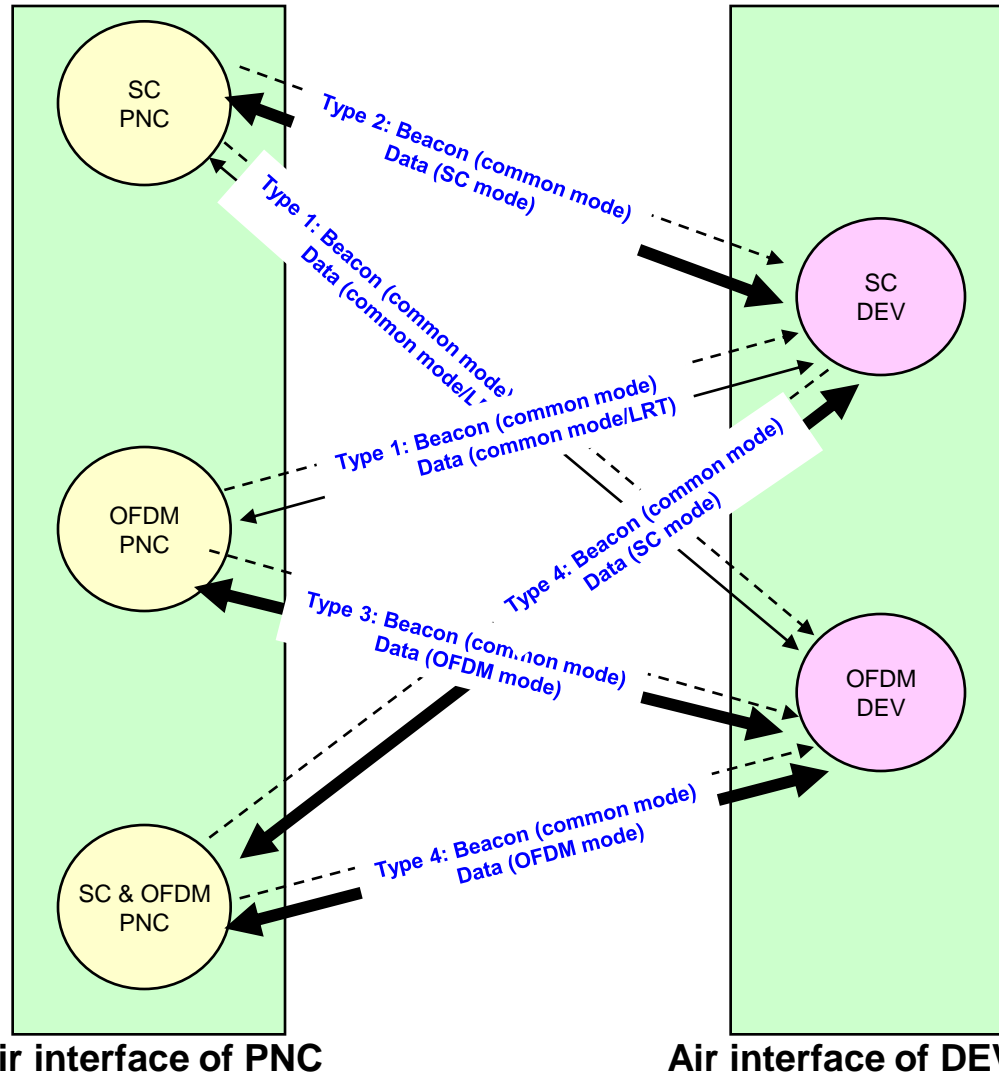
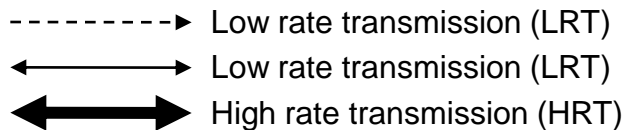

Superframe

(BP in CMT, CAP in CMT (MRT/HRT SC or OFDM for channel probing in option) and CTAP in CMT/LRT/MRT/HRT)

- **Superframe length** is **2ms** upon considering memory size, delay and data transmission efficiency
- **Beacon Period (BP)** of **0.2ms** is set for beacons of ADD and superframe synchronization in common mode transmission with rate of **47.8 Mbps**
- **Contention Access Period (CAP)** based on CSMA/CA is used for association, channel estimation, communication mode decision (SC or OFDM), and channel time allocation
 - CAP is used for common mode transmission (CMT), and optionally allows channel probing mode
 - Channel probing frame optionally used in CAP contains common preamble & PLCP header and SC/OFDM payload (see Appendix 1)
- **Channel Time Allocation Period (CTAP)** based on TDMA is used for data transmission in CMT/LRT, MRT/HRT SC and OFDM modes simultaneously

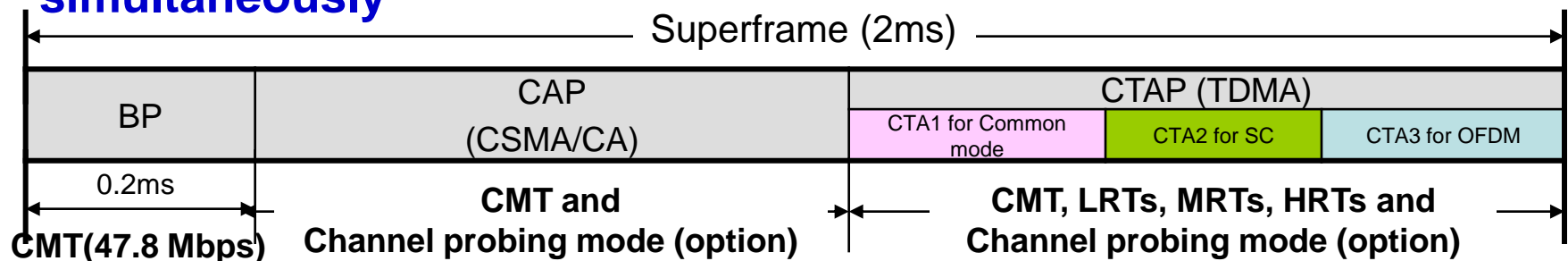

Beacon Period (200us for ADD and SYNC beacons)

- From viewpoint of DEV association, it is better to accommodate larger number of DEVs, while frame efficiency decreases
- **UM5** requires **2.25 Gbps MAC-SAP throughput** and it is preferable that it's rate is supported by **simple QPSK with RS**.
 - MAC-SAP of 3.56 Gbps in UM1 is supported by 8PSK
 - MAC-SAP of 1.78 Gbps in UM1 and MAC-SAP of 1.5 Gbps in UM5 are easier targets
- **200us beacon period** accommodates **up to 16 DEVs per PNC** while to keep high enough **superframe efficiency (~90 %)** to transmit over **2.25 Gbps MAC-SAP throughput by QPSK with RS (UM5)**
- **Up to 16 DEVs** associated with PNC is reasonable in practical applications

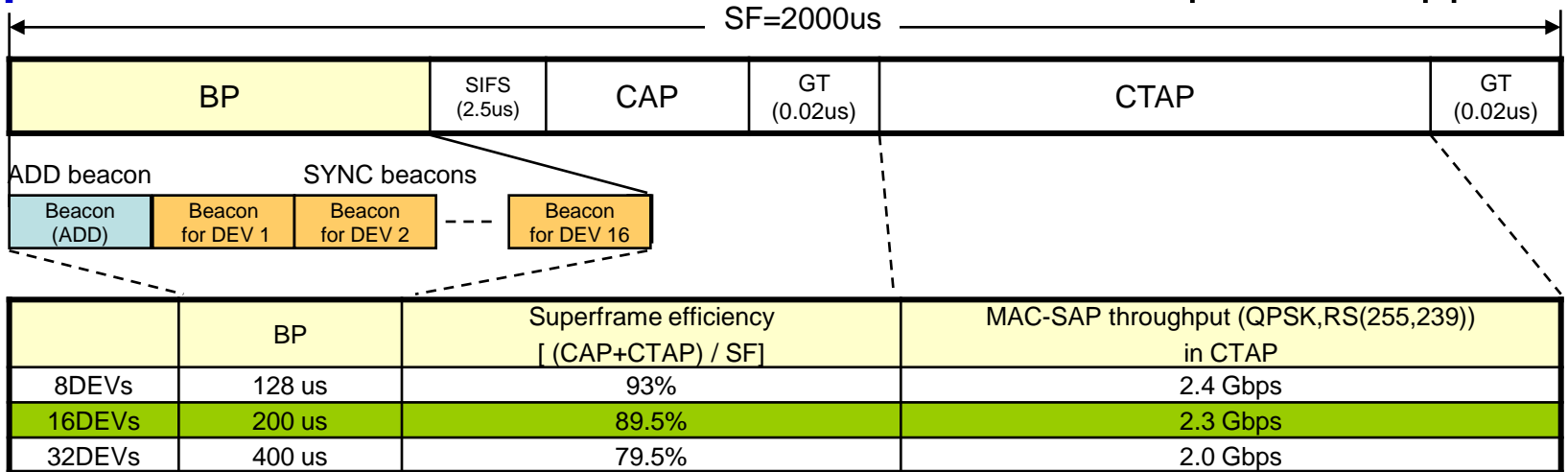

- 11.6us beacon frame (upon 21 octets payload) is assumed
- 200us CAP for association is assumed to calculate MAC-SAP throughput

ADD Superframe

- **ADD superframe (ADD SF) consists of 64 superframes (SFs)**
 - SF length is **2ms**
 - ADD superframe length is **SF length (2ms) x 64 (=128ms)**
 - Beacon periods in SF #1~#64 will contain a beacon for ADD (ADD beacon) and beacons for SF synchronization of associated DEVs (SYNC beacons)
 - SF #1 is used for omni ADD beacon and directional SYNC beacons
 - SF #2~#64 are used for directional ADD and SYNC beacons
- **ADD superframe for ADD 1 (directional antenna only) and ADD 2 (directional antenna with omni)**
 - ADD 1 (directional antenna only) uses from **SF #2 to SF #64**
 - SF #1 is used for not ADD but directional communication
 - ADD superframe consists of SF #1 only in omni antenna case
 - ADD 2 (directional antenna with omni) uses from **SF #1 to SF #64**

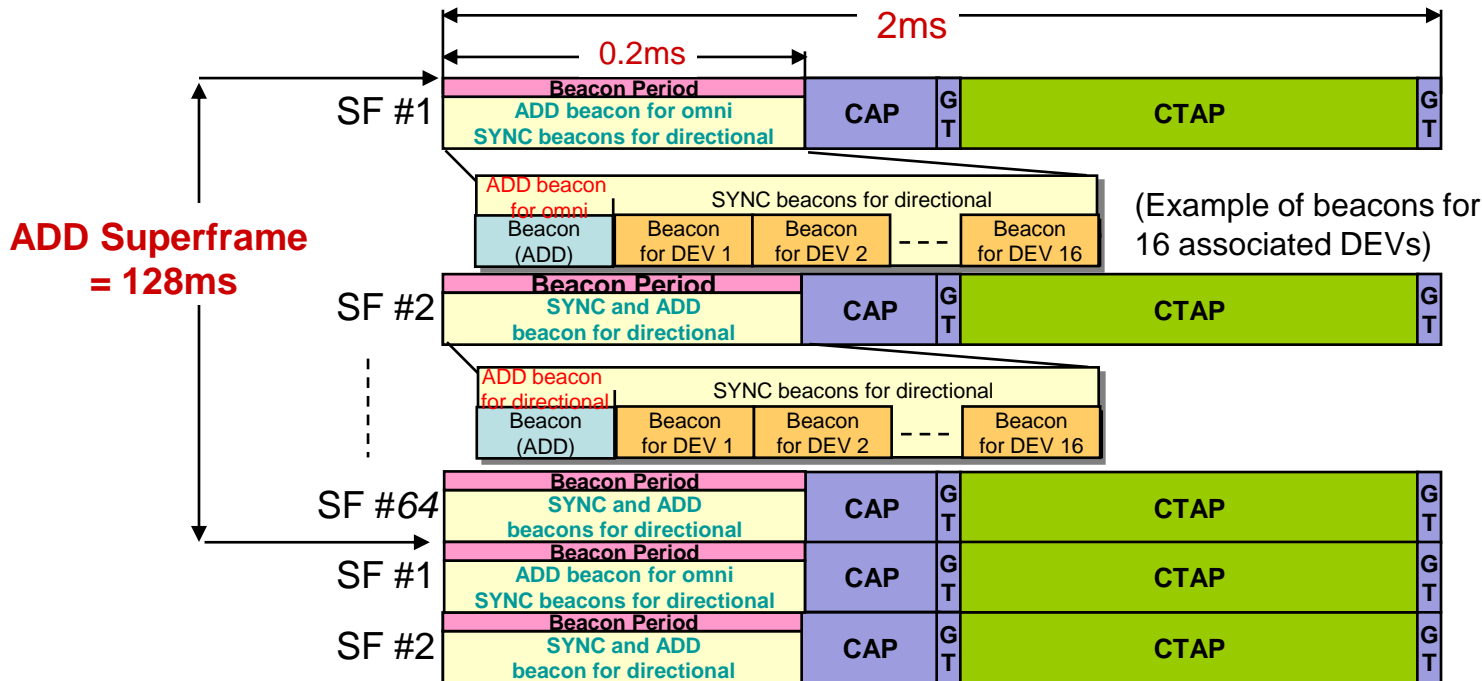

ADD Superframe (example)

- In ADD superframe, three types of beacons will be used
 - ADD beacons** are used for ADD in directional antenna devices only and directional antenna devices with omni as well
 - SYNC beacons** are used for SF synchronization of associated DEVs

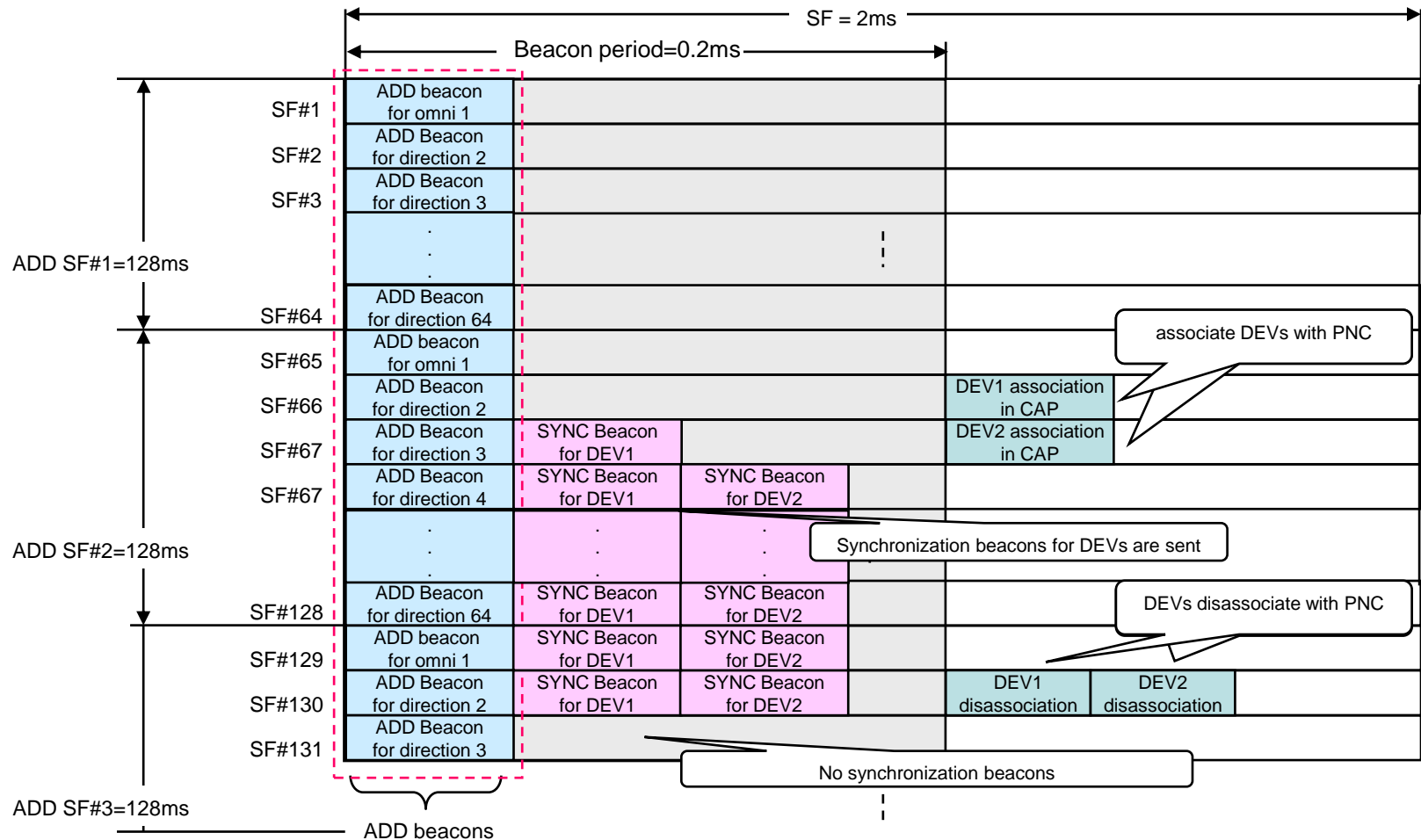

Multiple beaconing for SC, OFDM and OOK DEVs (Common mode and polling mode beacons)

- **Multiple beacons** of **common mode (BPSK)** and **optional polling mode (OOK)** can support **SC, OFDM** and **OOK DEVs** in a piconet, simultaneously
- **Beacon period** can accommodate **multiple beacons**:
 - **Common mode beacons** are used for ADD and SYNC of SC/OFDM DEVs
 - **Optional polling mode beacons** are used for ADD and SYNC of OOK DEVs

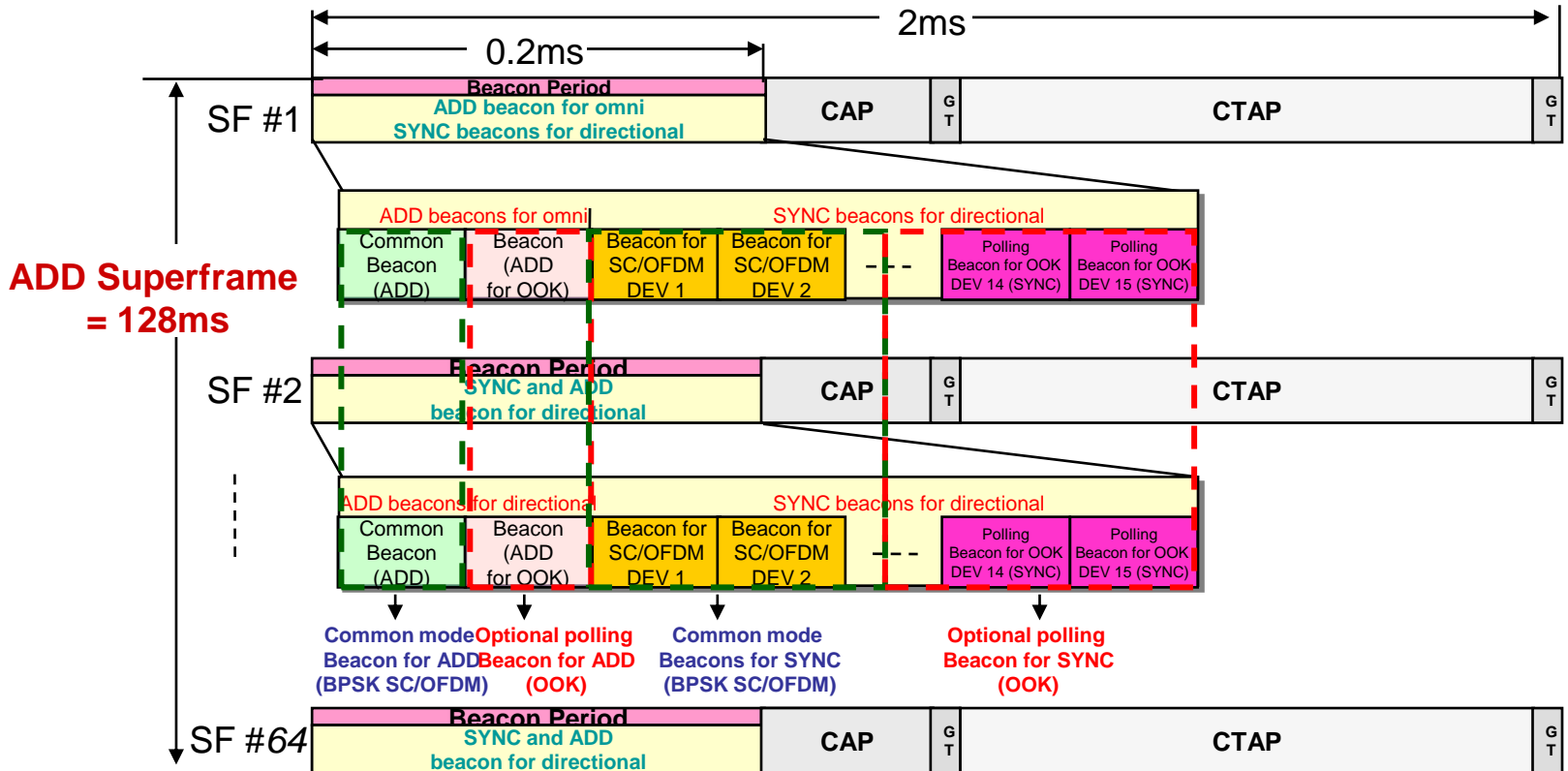

Frame format of half-rate transmission modes (Example: half-rate SC LRT of 47.8 Mbps)

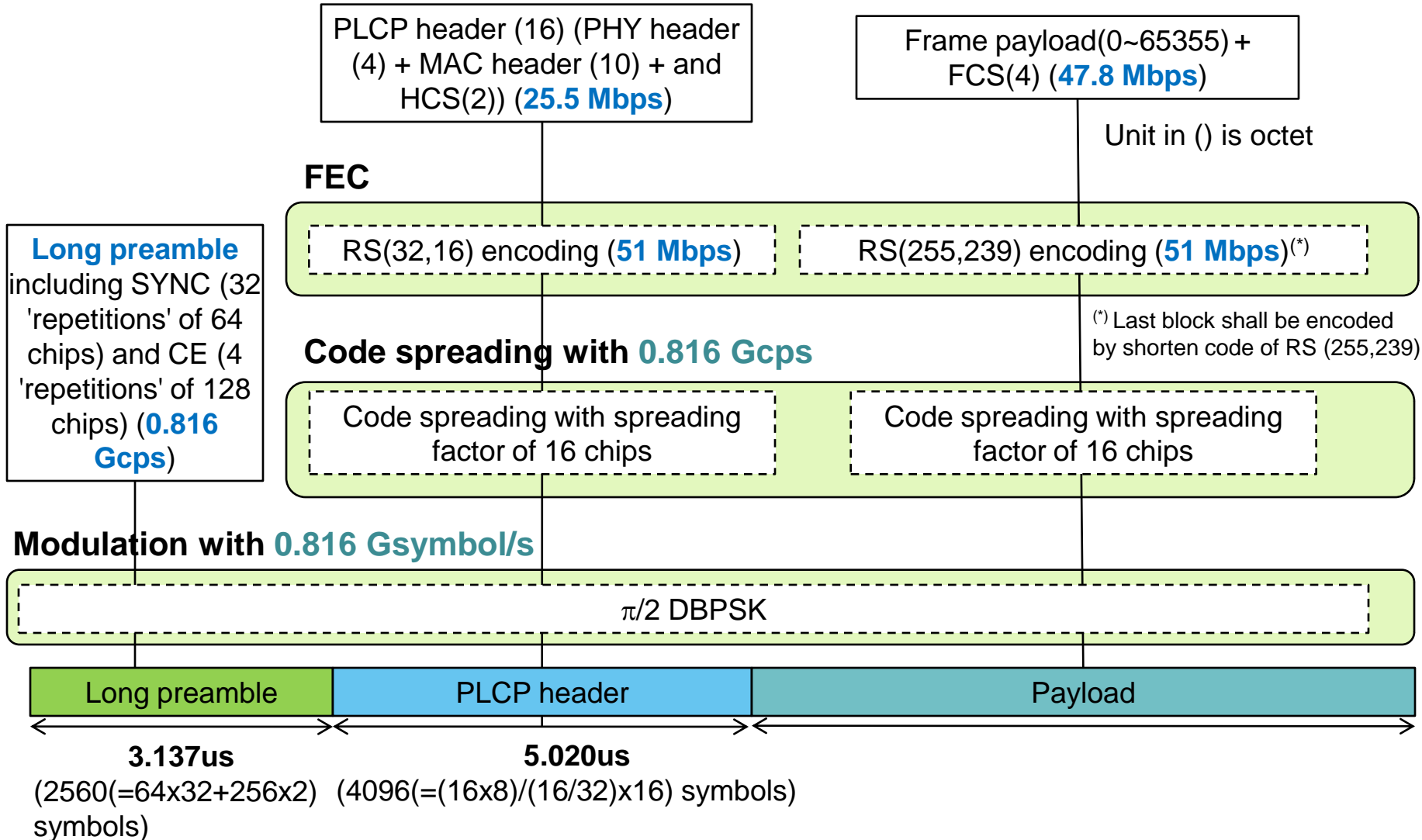

Frame format of half-rate transmission modes

- SC LRT and Probing modes -

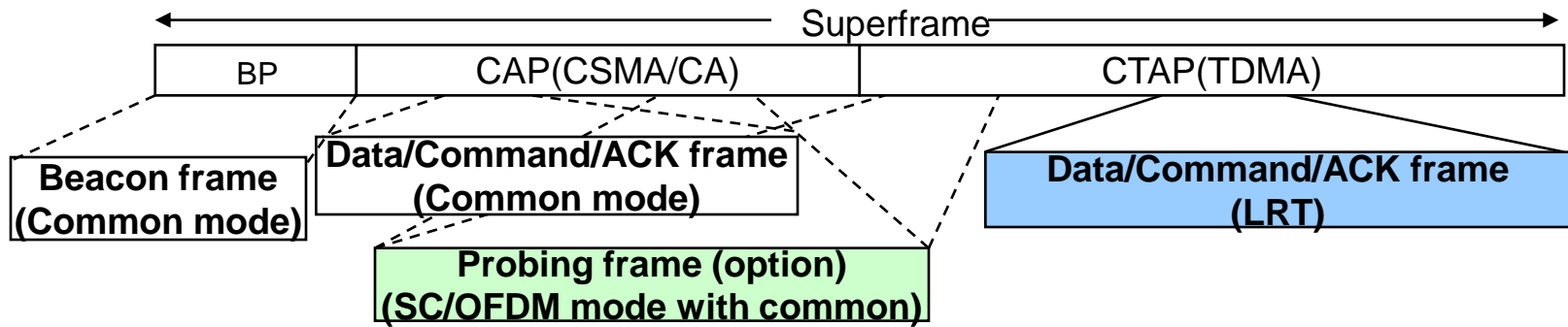

SC LRT frame (Half-rate channel)

0.816 Gsymbol/s

(*) including pilot symbols in no code spreading mode

	Preamble	PLCP header	Payload
Modulation	$\pi/2$ DBPSK	$\pi/2$ DBPSK	$\pi/2$ DBPSK/QPSK
FEC	N/A	RS(32,16)	RS (255,239)
Spreading factor	N/A	16 with 0.816 Gcps	1,2,4,8,16 with 0.816 Gcps (half-rate LRT)

Probing frame (Half-rate channel)

0.816 Gsymbol/s

	Preamble	PLCP header	Payload
Modulation	$\pi/2$ DBPSK	$\pi/2$ DBPSK	According to available transmission modes
FEC	N/A	RS(32,16)	
Spreading factor	N/A	16 with 0.816 Gcps	

Frame format of full-rate transmission modes (Example: SC MRT/HRT)

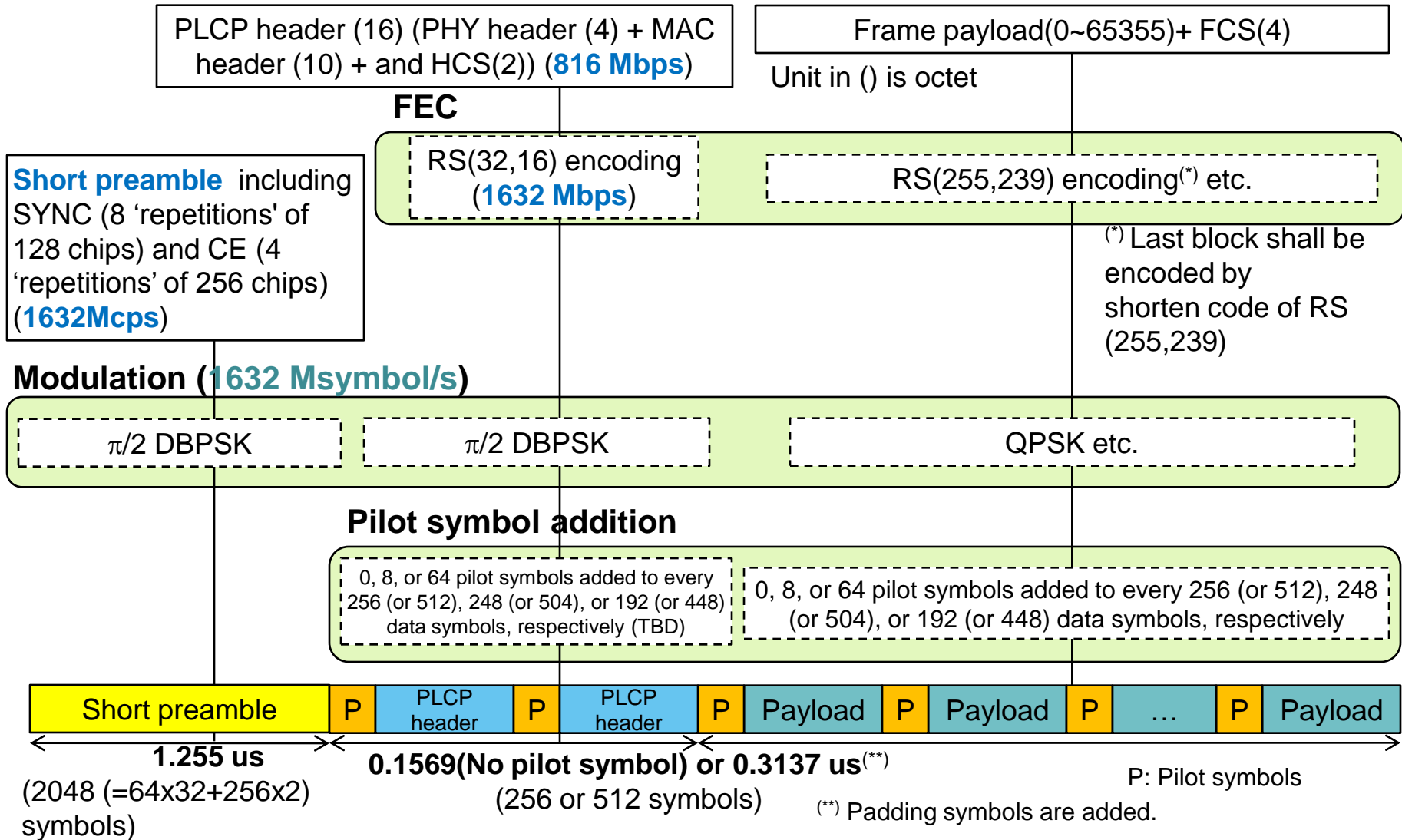

Frame format of full-rate transmission modes

- Common, Probing and SC LRT modes -

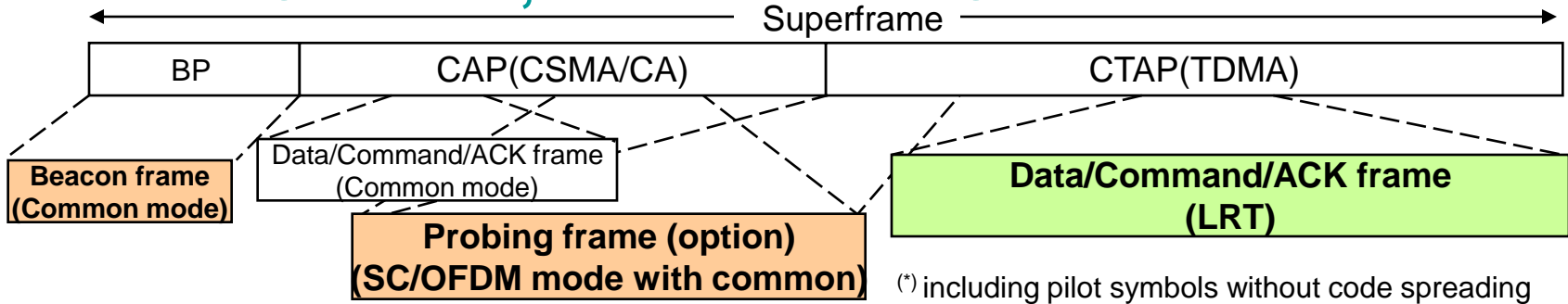

Common mode/ Probing frame (Full-rate channel)

1.632Gsymbol/s

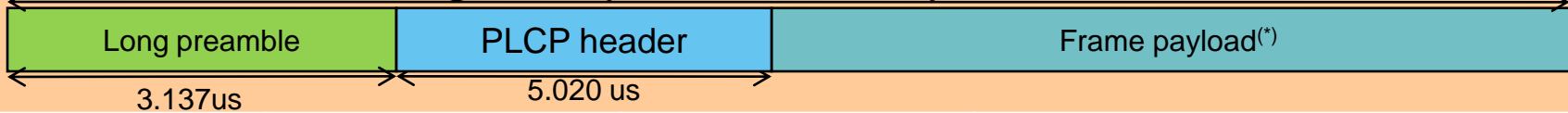

	Preamble	PLCP header	Payload	
Frame type			Common mode frame	Probing frame
Modulation	$\pi/2$ DBPSK	$\pi/2$ DBPSK	$\pi/2$ DBPSK	According to available transmission modes
FEC	N/A	RS(32,16)	RS(255,239)	
Spreading factor	N/A	32 with 1.632 Gcps	32 with 1.632 Gcps	

SC LRT frame (Full-rate channel)

1.632Gsymbol/s

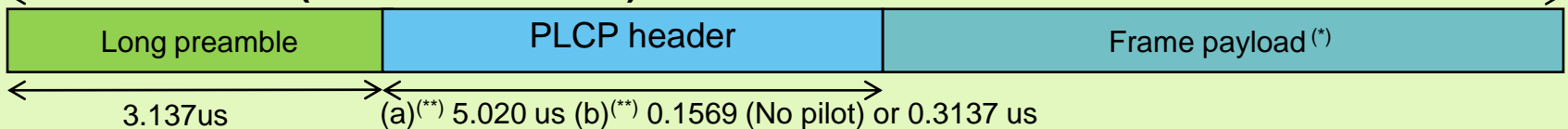

	Preamble	PLCP header	Payload
Modulation	$\pi/2$ DBPSK	$\pi/2$ DBPSK	(a) $\pi/2$ DBPSK (b) $\pi/2$ DBPSK/GMSK/MSK/QPSK
FEC	N/A	RS(32,16)	(a) RS(255,239), (b) RS(255,239), LDPC(576,504), LDPC(576,432), LDPC(576,288)
Spreading factor	N/A	(a) 32 chips with 1.632 Gcps or (b) 1 (No spreading)	(a) 2,4,8,16,32 chips with 1.632Gcps (b) 1 (No spreading)

(**)(a) for all cases of spreading payload with spreading factor (of 2,4,8,16, or 32) (b) for all cases of no spreading payload

Frame format of full-rate transmission modes - SC MRT/HRT modes and OFDM modes -

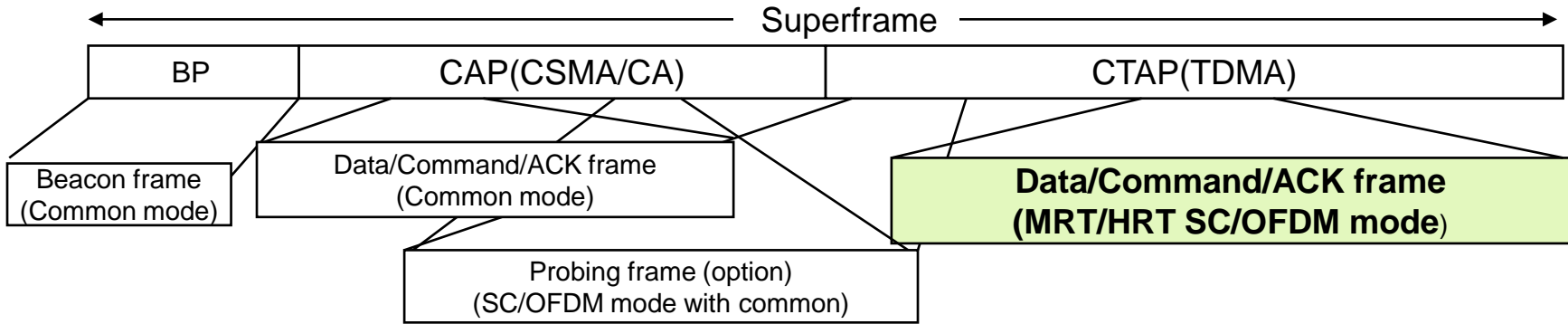

SC MRT/HRT frame (Full-rate channel)

1.632Gsymbol/s



1.225 us

0.1569 (No pilot) or 0.3137 us

(*) including pilot symbols without code spreading mode

	Preamble	PLCP header	Payload
Modulation	$\pi/2$ DBPSK	$\pi/2$ DBPSK	QPSK/ TC8PSK/ 8PSK
FEC	N/A	RS(32,16)	RS(255,239)/ LDPC(576,504), LDPC(576,432), LDPC(576,288), LDPC(1440, 1344)
Spreading factor	N/A	1	1

OFDM mode frame

OFDM frame format including preamble, PLCP header, and payload

Preamble format

- **Two preamble types**
 - Long preamble is used for CMT, SC LRT and channel probing frames in both half-rate and full-rate
 - Short preamble is used for SC MRT/HRT frames in full-rate
- **Preamble consists of Synchronization (SYNC) sequences and Channel Estimation (CE) sequences**
 - SYNC sequences are used for AGC, antenna diversity, timing detection, coarse AFC, and SFD (start frame delimiter)
 - Long preamble
 - SYNC of 32 'repetitions' (*) of Golay code of 64 chips for half-rate frames
 - SYNC of 32 'repetitions' of Golay code of 128 chips for full-rate frames
 - Short preamble
 - SYNC of 8 'repetitions' of Golay code of 128 chips for full-rate frames
 - SFD is used for the identification of the last SYNC sequence with “-a”
 - 2 sequences are used in CE and fine AFC with cyclic prefix and postfix.
 - Long preamble
 - CE of 4 'repetitions' of Golay code of 128 chips for half-rate frames
 - CE of 4 'repetitions' of Golay code of 256 chips for full-rate frames
 - Short preamble
 - CE of 4 'repetitions' of Golay code of 256 chips for full-rate frames
 - Accompanying cyclic prefix and cyclic postfix are composed of the copy of the last half of the sequence and the first half of the sequence, respectively.

(*)'repetitions': codes may be different (i.e., a , $-a$, b , $-b$), but can be decoded with the same decoder

Preamble format (cont.)

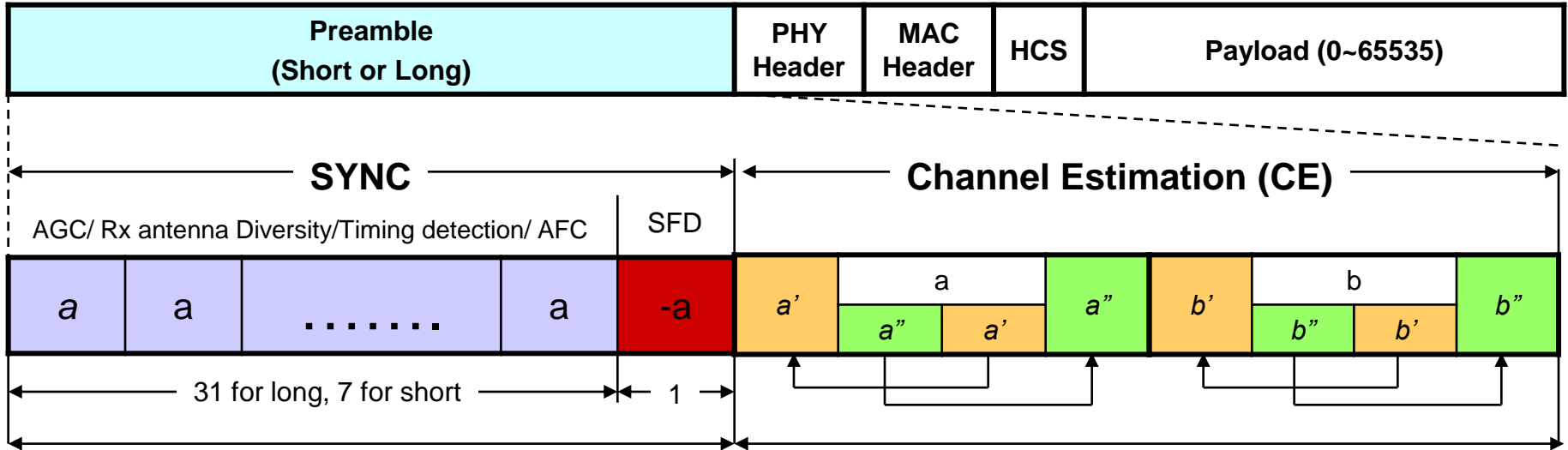

- Long preamble
 - 32 'repetitions' of Golay code of 64@ 0.816Gcps
 - 32 'repetitions' of Golay code of 128@1.632Gcps
- Short preamble
 - 8 'repetitions' of Golay code of 128@1.632Gcps
- [-a] is SFD used for the identification of the last SYNC sequences
- [a], [-a], [b] are Golay code set
- [a] and [b] are complimentary pair of each other
- [a]'s postfix [a''] is a copy of [a]'s last half part, and [a]'s prefix [a'] is a copy of [a]'s first half part
- Same conditions are match with [b][b][b''] case
- [a] and [b]
 - Golay codes of 128@0.816Gcps in long preamble
 - Golay codes of 256@1.632Gcps in long preamble
 - Golay codes of 256@1.632Gcps in short preamble

Preamble type in each frame		Symbol rate [Gcps]	SYNC	CE	Spreading factor	Total length	
			Code 'repetitions'	Code 'repetitions'	Golay code length	chips	ns
Common mode/ Probing/ LRT SC frames	Long Preamble	0.816	32	4	64 for SYNC 128 for CE	2560	3137
		1.632	32	4	128 for SYNC 256 for CE	5120	3137
MRT/HRT SC frame	Short Preamble	1.632	8	4	128 for SYNC 256 for CE	2048	1255

PLCP and Payload format

- **PLCP and frame payload** are independently segmented into **subBlocks**, accompanying **Golay code-based pilot symbols**, which are between each subBlock
 - SubBlock size: 256 or 512 (TBD) symbols (including data symbols and pilot symbols)
 - Pilot symbol length: 0, 8, or 64 symbols
 - Roll of Pilot symbol
 - **(a) Timing tracking, (b) Compensation for clock drift, and (c) Compensation for frequency offset error that resides after fine AFC and that caused by phase noise in LOS environment**
 - **Cyclic prefix (CP) for frequency domain equalizer (FDE) as well in NLOS environment**
 - Types of pilot symbol insertion
 - Length of 8 symbol: Insertion of Golay codes **a** and **b** by turns
 - Length of 64 symbol: Insertion of Golay code **a** with length of 64

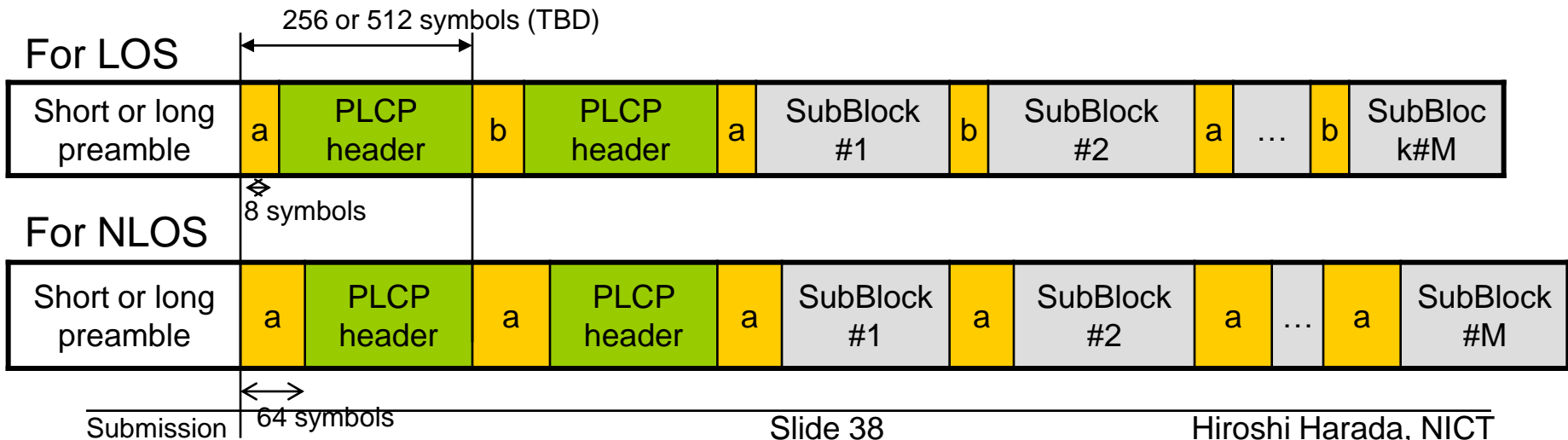

PHY header

- PHY header (4octets) contains
 - **Modulation and Coding (6bits)**
 - indicates modulation and coding information of data frame
 - **UEP information (1bit)**
 - indicates using UEP or not
 - **Aggregation information (1bit)**
 - indicates using aggregation or not
 - **Frame / Subframe length (16bits)**
 - The data block used as minimum element of aggregation is defined as subframe
 - allows maximum 65Kbyte frame
 - **Number of subframes (5bits)**
 - allows up to 32 subframes be aggregated into a single frame
 - **Length of Pilot symbols (2bits)**
 - **Reserved (1bit)**

6bits	1bit	1bit	16bits	5bits	2bits	1bit
Modulation and Coding	UEP information	Aggregation Information	Frame / Subframe length	Number of subframes	Length of pilot symbols	Reserved

Aggregation with Unequal Error Protection (UEP)

- To support **robust and trustworthy frame transmission** for video, audio and encryption keys, **Unequal Error Protection (UEP)** is used
- From viewpoint of hardware implementation, **adaptive FEC only** is used for UEP
- **UEP in MAC and PHY**
 - **MAC operations (Fragmentation and ARQ)**
 - MSDUs are fragmented into subframes with the same length
 - Information of MSB (such as video, audio and encryption keys) and length of subframes is informed to PHY from MAC
 - ARQ for retransmission will be performed
 - **PHY operations (UEP, Aggregation and Frame check)**
 - Subframes of MSB are protected by **FEC only** with FCS
 - Subframes of MSB and others are aggregated
 - Preamble, header and subheader are added in the aggregated frame
 - Information of subframe check and length of subframes is informed to MAC
- **PHY aggregation**
 - **5-bits Subframe number field** in PHY header allows up to **32 subframes** to be aggregated into a single frame
 - **16-bits Frame/subframe length field** in PHY header allows maximum **65Kbytes frame** be aggregated
- **UEP conditions**
 - MSDUs are fragmented into subframes with the same length in MAC
 - MSDUs shall be exactly divided by the subframe
 - Each subframe shall not contain multiple MSDUs
 - MSB subframes are only protected by adaptive FEC
 - FEC shall not change in a session

UEP by adaptive FEC (in detail)

- MSDUs are fragmented into subframes with the same length
 - MSDU shall be exactly divided by the subframe

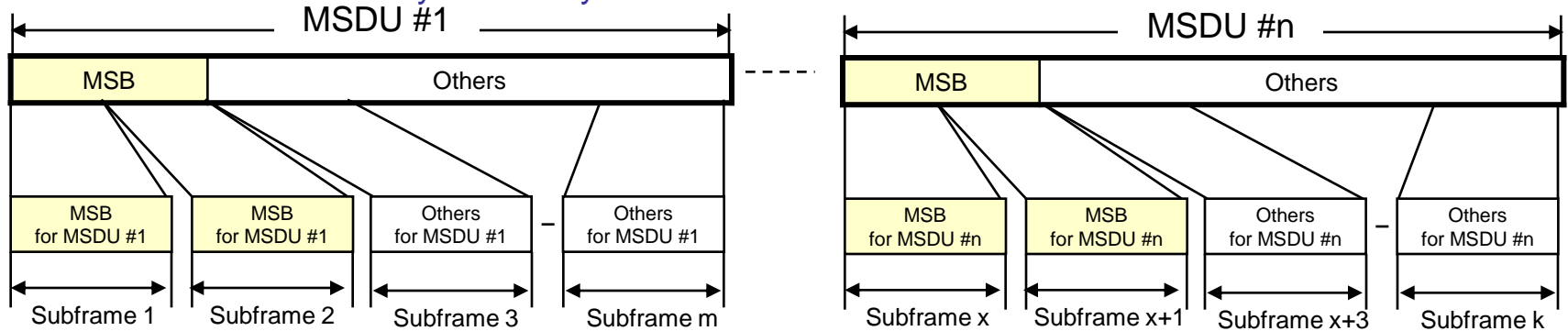

MAC
↓
PHY

- MSB subframes are protected by FEC only with FCS

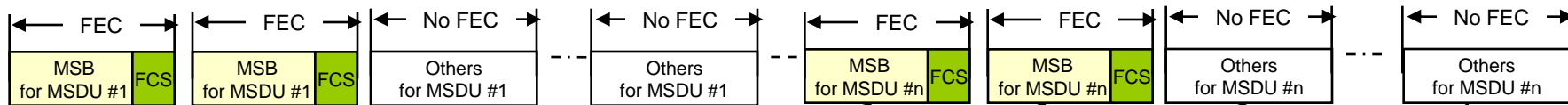

- Subframes of MSB (such as video, audio and encryption keys) and others are aggregated

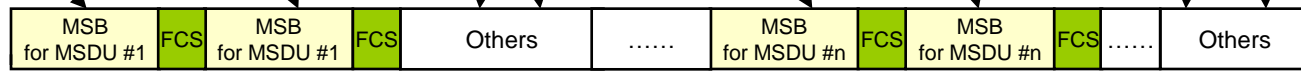

- Preamble, header and subheader are added in the aggregated frame



• Subheader indicates subframe information of FEC, FCS and MSDU#

- Header including PHY and MAC headers
- PHY header indicates frame information of modulation and coding, UEP, Aggregation, and CP

Subheader

- **Subheader** is used for **aggregation** and **unequal error protection (UEP)** including up to **32 subframes information**
- **Subheader (10bits per subframe)** includes
 - **FEC information** for each subframe (**2bits**)
 - Indicates FEC types of subframes
 - Supports 4 types of FECs
 - **FCS information** for each subframe (**1bit**)
 - Indicates the usage of frame check sequence (FCS)
 - **MSDU number** for each subframe (**5bits**)
 - Indicates 0-31 increment from the first MSDU number
 - The first MSDU number will be indicated in MSDU number field of fragment control of the MAC header
 - **Fragment information** for each subframe (**2bits**)
 - Indicates the subframe is one of three status; first subframe of MSDU, last subframe of MSDU, None of the two

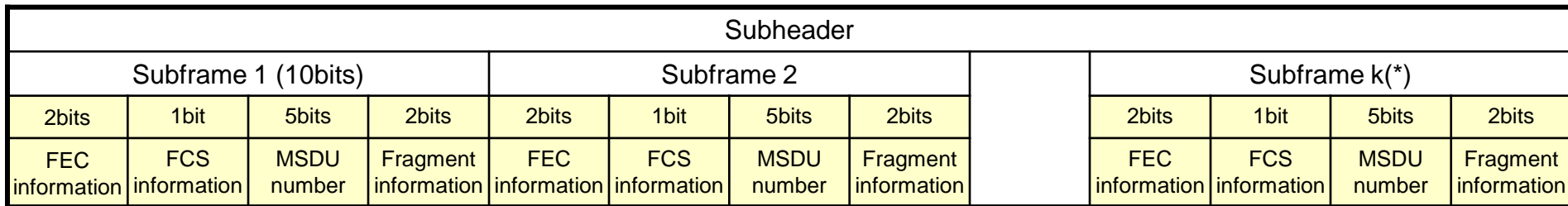

0~31 increment of MSDU number

(*) number of k is up to 32

b0-b1	FEC information
00	No FEC
01	TBD
10	TBD
11	TBD

Appendix 1: Summary of half-rate frame format in each mode

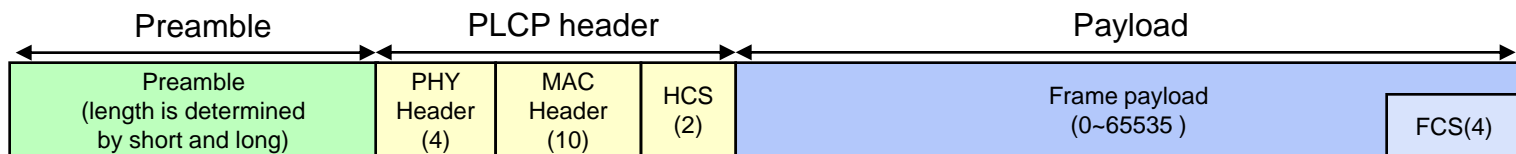

Frame types	PHY-SAP rate	Nyquist BW	Preamble	PLCP header	Payload	Ex. frame
Probing frame (Option)	Variable by SC/OFDM	0.816 GHz	Long preamble	16 octets (Before RS encoding)	0~65535 octets	Channel Probing frame
			0.816 Gsps $\pi/2$ DBPSK SYNC (32 repetitions of 64 chips) + CE (4 repetitions of 128 chips)	0.816 Gsps $\pi/2$ DBPSK RS(32,16) coding rate (Spreading factor of 16 chips)	SC / OFDM mode	
			3.137 us	5.02 us	-	
LRT SC frame	765 Mbps 383 Mbps 192 Mbps 95.6 Mbps 47.8 Mbps	0.816 GHz	Long preamble	16 octets (Before RS encoding)	0~65535 octets	Data frame
			0.816 Gsps $\pi/2$ DBPSK SYNC (32 repetitions of 64 chips) + CE (4 repetitions of 128 chips)	0.816 Gsps $\pi/2$ DBPSK RS(32,16) coding rate (Spreading factor of 16 chips)	0.816 Gsps $\pi/2$ BPSK RS(255,239) encoding (Spreading factor of 1, 2, 4, 8 and 16 chips) QPSK without spreading	
			3.137 us	5.02 us	Spreading factor of 1 chips	
					Spreading factor of 2 chips	
					Spreading factor of 4 chips	
					Spreading factor of 8chips	
					Spreading factor of 16chips	

Appendix 2: Summary of full-rate frame format in each mode

Frame types	PHY-SAP rate	Nyquist BW	Preamble	PLCP header	Payload	Ex. frame
Common mode frame	47.8 Mbps	1.632 GHz	Long preamble	16 octets(Before RS encoding)	0~65535 octets	Beacon frame
			1.632 Gsps $\pi/2$ DBPSK SYNC (32 repetitions of 128 chips) + CE (4 repetitions of 256 chips)	1.632 Gsps $\pi/2$ DBPSK RS(32,16) coding rate (Spreading factor of 32 chips)	1.632 Gsps $\pi/2$ DBPSK RS(255,239) encoding (Spreading factor of 32 chips)	
			3.137us	5.02us	-	
Probing frame (Option)	Variable by SC/OFDM	1.632 GHz	Long preamble	16 octets (Before RS encoding)	0~65535 octets	Channel Probing frame
			1.632 Gsps $\pi/2$ DBPSK SYNC (32 repetitions of 128 chips) + CE (4 repetitions of 256 chips)	1.632 Gsps $\pi/2$ DBPSK RS(32,16) coding rate (Spreading factor of 32 chips)	SC / OFDM mode	
			3.137us	5.02us	-	
LRT SC frame	1530 Mbps 765 Mbps 383 Mbps 192 Mbps 95.6 Mbps 47.8 Mbps	1.632 GHz	Long preamble	16 octets(Before RS encoding)	0~65535 octets	Data frame
			1.632 Gsps $\pi/2$ DBPSK SYNC (32 repetitions of 128 chips) + CE (4 repetitions of 256 chips)	1.632 Gsps $\pi/2$ DBPSK RS(32,16) coding rate (Spreading factor of 32 chips)	1.632 Gsps $\pi/2$ DBPSK RS(32,16) coding rate, LDPC with spreading factor of 1, 2, 4, 8,16, 32 or GMSK/MSK/QPSK without spreading	
			3.137us	5.02us	Spreading factor 1	
					Spreading factor 2	
					Spreading factor 4	
					Spreading factor 8	
					Spreading factor 16	
Spreading factor 32						
MRT/HRT SC frame		1.632 GHz	Short preamble	16 octets (Before RS encoding)	0~65535 octets	Data frame
			1.632 Gsps $\pi/2$ DBPSK SYNC (8 repetitions of 128 chips) + CE (4 repetitions of 256 chips)	1.632 Gsps $\pi/2$ DBPSK RS(32,16) coding rate without spreading	1.632 Gsps QPSK/TC8PSK/8PSK RS(32,16) coding rate, LDPC without spreading	
			1.255us	0.157us	-	

Appendix 3: Automatic frequency control

- Functions of coarse and fine automatic frequency control (AFC) are provided by SYNC and CE sequences, respectively
- A range of estimable frequency offset f_{off} depends on a period between successive two sequences T_{sq} , that is, $|f_{off}| < 1/(2T_{sq})$
 - Coarse AFC: up to 108 ppm @ 60 GHz
 - Fine AFC: up to 27 ppm @ 60 GHz
- Residual frequency offset is reduced to **less than 1 ppm @ 60 GHz** by the joint use of the coarse and fine AFC

Coarse AFC by SYNC sequences

Fine AFC by CE sequences

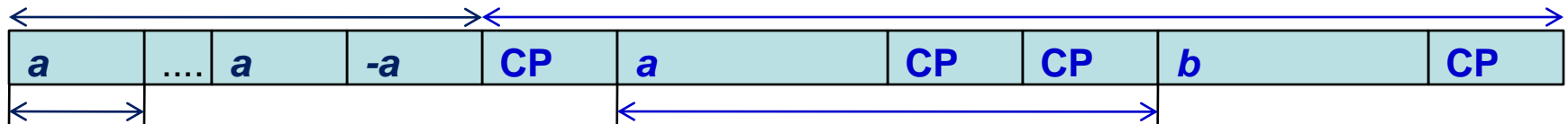

$T_{sq} = 77$ nsec

Estimable offset is up to 108 ppm @ 60 GHz

$T_{sq} = 308$ nsec

Estimable offset is up to 27 ppm @ 60 GHz

Appendix 4: Throughput and efficiency analysis

- MAC-SAP throughput
= (sum of data payload) / superframe
- Superframe efficiency
= (CAP+CTAP) / superframe
- MAC-SAP efficiency
= (MAC-SAP throughput / PHY-SAP throughput)

