

**Project: IEEE P802.15 Working Group for Wireless Personal Area Networks (WPANs)**

**Submission Title:** [Low Cost, Low Complexity ASK-Based PHY for 802.15.3c ]

**Date Submitted:** [May 7, 2007]

**Source:** [Bruce Bosco(1), Paul Gorday(2), Steve Rockwell(3), Adam Rentschler(4), Robert Pauley(5)]

Company [(1),(2),(3) Motorola, Inc., (4),(5) Phiar]

Address [(1),(3) 2100 East Elliot Road, Tempe, AZ, 85044, (2) 8000 West Sunrise Boulevard, Plantation, FL, 33322 , (4),(5) 2555 55<sup>th</sup> Street, Bldg. D-104, Boulder, CO, 80301]

Voice:[(1) 480-413-5241,(2) 954-723-4047,(3) 480-413-5235],(4),(5) 303-443-0373. E-mail[(1) bruce.a.bosco@motorola.com,(2) Paul.Gorday@motorola.com,(3) S.Rockwell@ motorola.com,(4) adam@phiar.com,(5) Pauley@phiar.com]

**Re:** [15-07-0586-01-003c-tg3c-call-proposals.doc]

**Abstract:** [This document describes a proposal for the IEEE 802.15.3c PHY]

**Purpose:** [Proposal for the IEEE802.15.3c standard]

**Notice:** This document has been prepared to assist the IEEE P802.15. It is offered as a basis for discussion and is not binding on the contributing individual(s) or organization(s). The material in this document is subject to change in form and content after further study. The contributor(s) reserve(s) the right to add, amend or withdraw material contained herein.

**Release:** The contributor acknowledges and accepts that this contribution becomes the property of IEEE and may be made publicly available by P802.15.

# Low Cost, Low Complexity ASK- Based PHY for 802.15.3c

# Contents

- Overview
- Why ASK...
- Channelization Plan
- PHY Simulation and Evaluation
- Manufacturability and Time to Market
- Power Requirements
- Scalability and Interoperability
- Early Hardware Implementation: Measured Data and Photos
- Conclusion
- References

# Overview

## Motivation:

- To address IEEE 802.15.3c technical requirements, and maximize early adopters, it is essential that low complexity system level hardware be implemented.
  - Conventional coherent phase and frequency modulated schemes can provide reasonable SNR performance over varied channels.
  - Multi-level modulation schemes also have some desirable features but require high linearity amplifiers, good phase noise sources, and expensive and power hungry ADC's and other DSP blocks.
- **To meet low power and low cost requirements with adequate performance for early adoption, we propose a PHY with ASK modulation and non-coherent envelope detection.**

# Why ASK...

- **Simplicity, Simplicity, Simplicity...**
- Ease of implementation, hardware robustness, low power consumption and compact
- Functional systems could be available very quickly, at an acceptable cost, power consumption and ease of use points for consumer acceptance.
  
- **Advantages of ASK:**
  - No local oscillators are required for receiver
    - Potentially, ultra low cost, power efficient and compact receivers
  - Digital baseband
    - A to D conversion overhead is substantially reduced
  - Low power consumption - radios can be incorporated into portable devices.

# Why ASK...

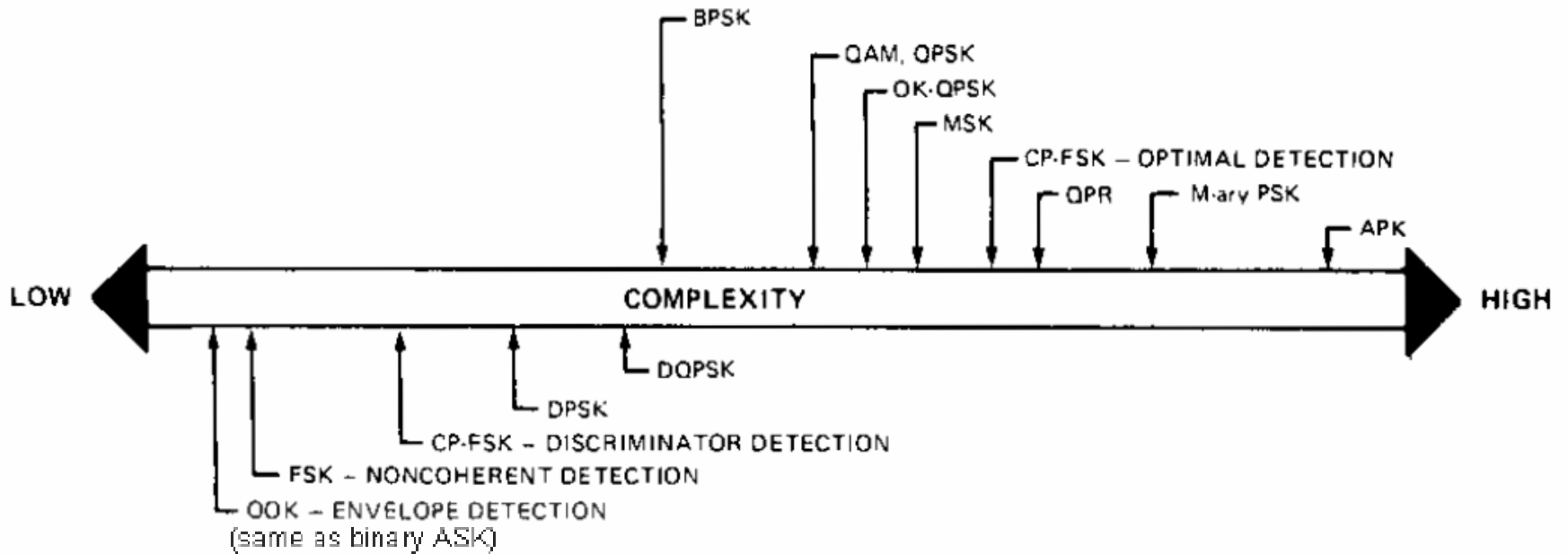

Figure 3: Relative Complexity of Representative Modulation Schemes

Ref. [4]

# Why ASK...

## ➤ Advantages of ASK (continued):

- Phase Noise concerns are effectively eliminated
- Easing of Power Amplifier requirements: the lower peak to average ratio of ASK requires less linearity from the amplifiers.
- One type of base radio chip-set could be reconfigured to address multiple applications – scalability.
- Data rates of over 3 Gbps with BERs of better than  $10^{-9}$  at distances of 10m have been demonstrated with low cost, low complexity, low power consumption hardware. [1]
- Meets base data rate requirements as specified in Selection Criteria and System Requirements documents. [2], [3]

# Why ASK...

- Advantages of ASK (continued):

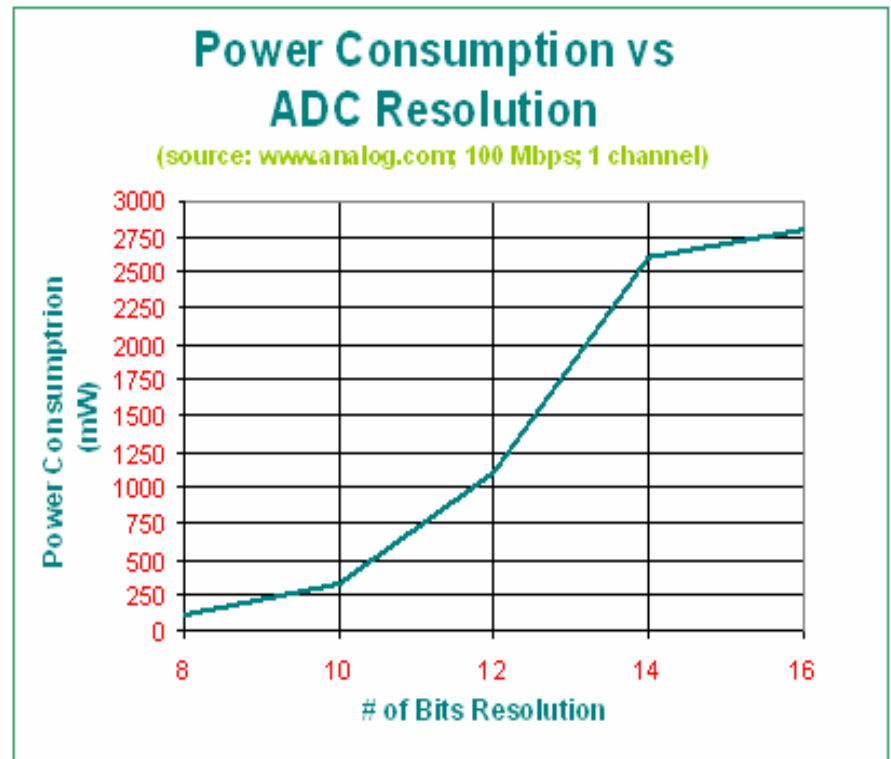
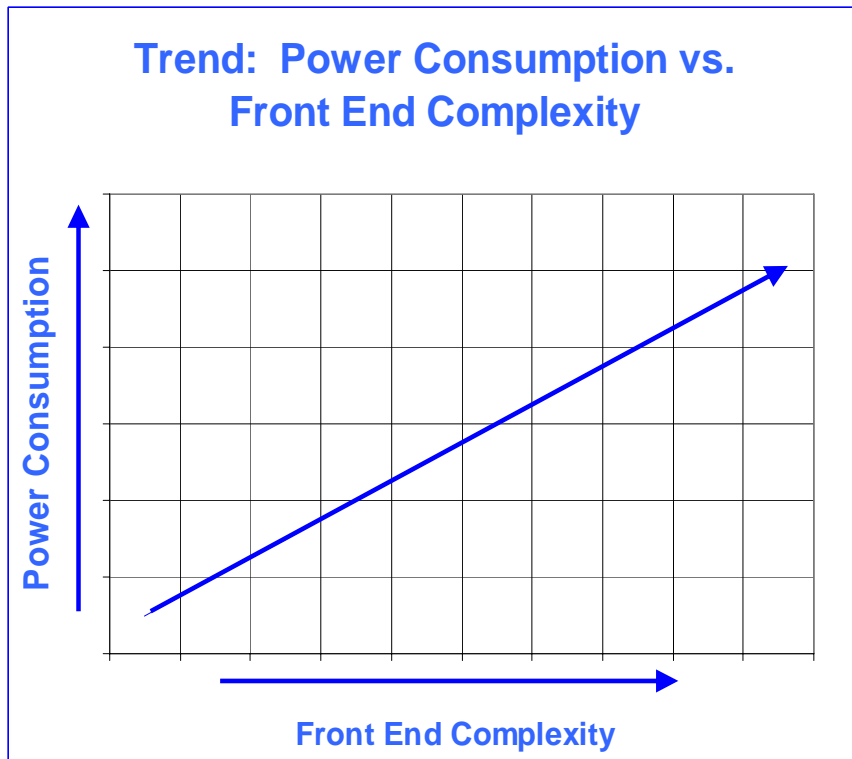



➤ Disadvantages of ASK:

- Spectral efficiency:
  - Base transmitted rate is 0.5 bit/Hz unfiltered.
  - With realistic pulse shaping techniques, efficiency can reach at least 0.8 bit/Hz. [4]
- Performance in noisy channels:
  - Other schemes may provide somewhat better performance particularly for NLOS applications.
  - Narrow beam-width antenna arrays ( inherent for reasonable gains such as 10 to 15 dBi) help reduce this effect.
- NLOS environments:
  - Some, much more complex schemes can provide better performance.
  - Simple mitigation techniques such as antenna diversity will be employed to address this issue.

# Channel Plan

## ➤ **Motivation**

- To address possible alternate channel plans that will:
  1. Conform with regional and national regulations
  2. Allow transmission of frequency bandwidth adequate for specified use case
  3. Permit at least two users in the total allotted frequency space -Japan, North America and Europe
  4. One reasonable contribution suggested 2 common channels at 2.225 GHz [5]. Our proposal leverages the idea presented in the referenced contribution but utilizing full bandwidth availability

## 3 CHANNELS

- 2 Channels @ 2.50 GHz: 59 – 61.5 GHz & 61.5 – 64 GHz common to USA, Europe and Japan.
- 1 Channel @ ~ 1.95 GHz: 57.05 – 59 GHz (USA), 64 – 65.0 GHz (Japan)

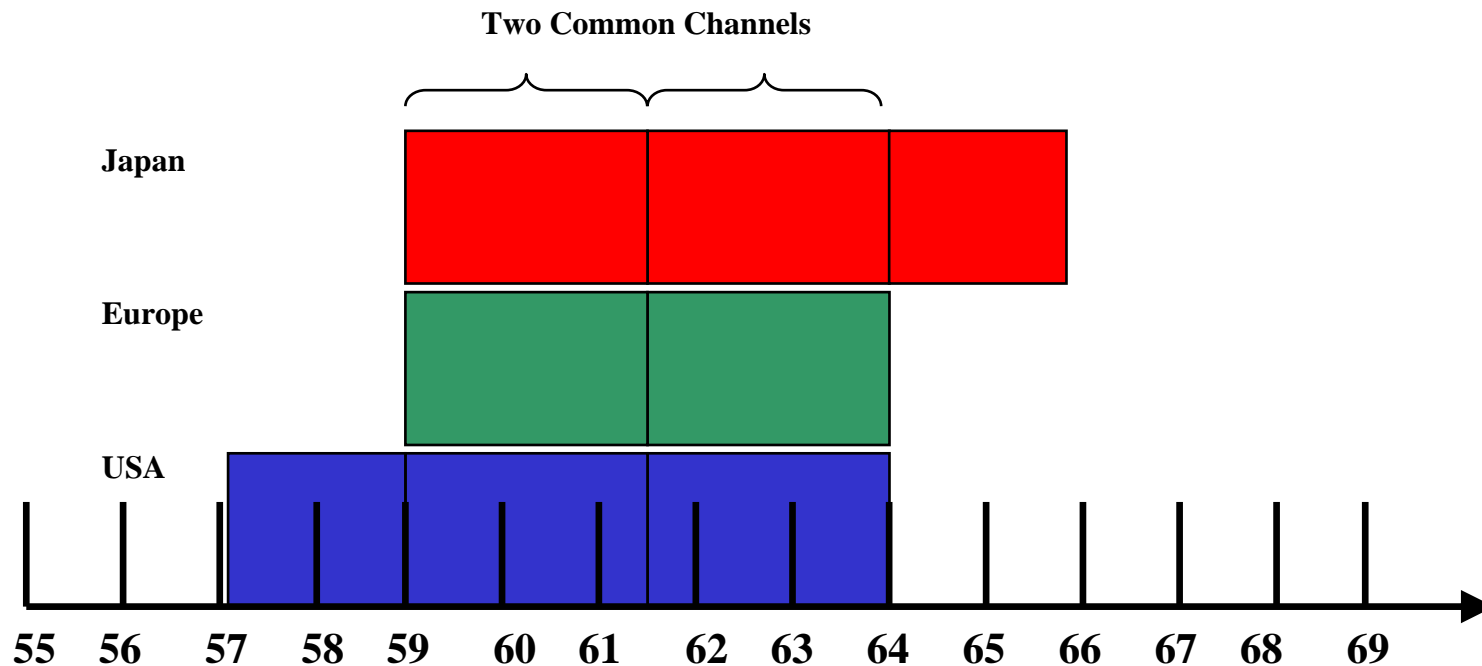

# High Rate Channels

- > 2.025 Gbps at MAC-SAP
- BW 2.5 GHz

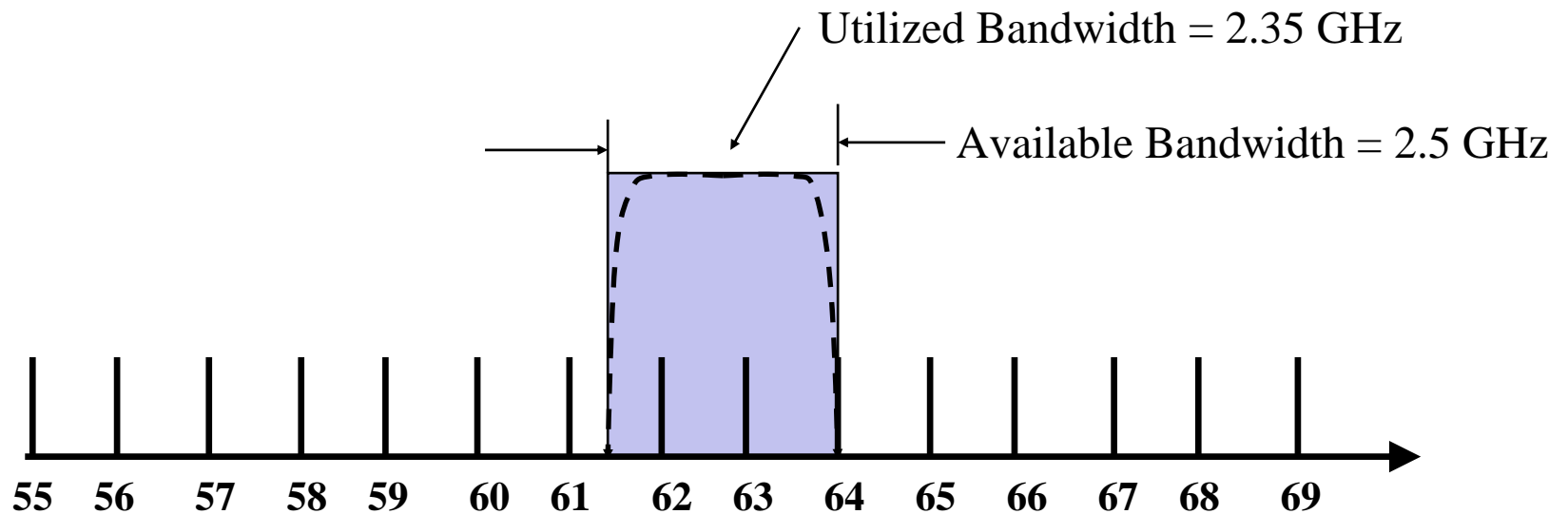

# Low Rate Channel

- $> 1.515$  Gbps at MAC-SAP
- Optional back-off modes [6]
- BW 1.950 GHz
- Spectrum shown for USA, same concept for Japan

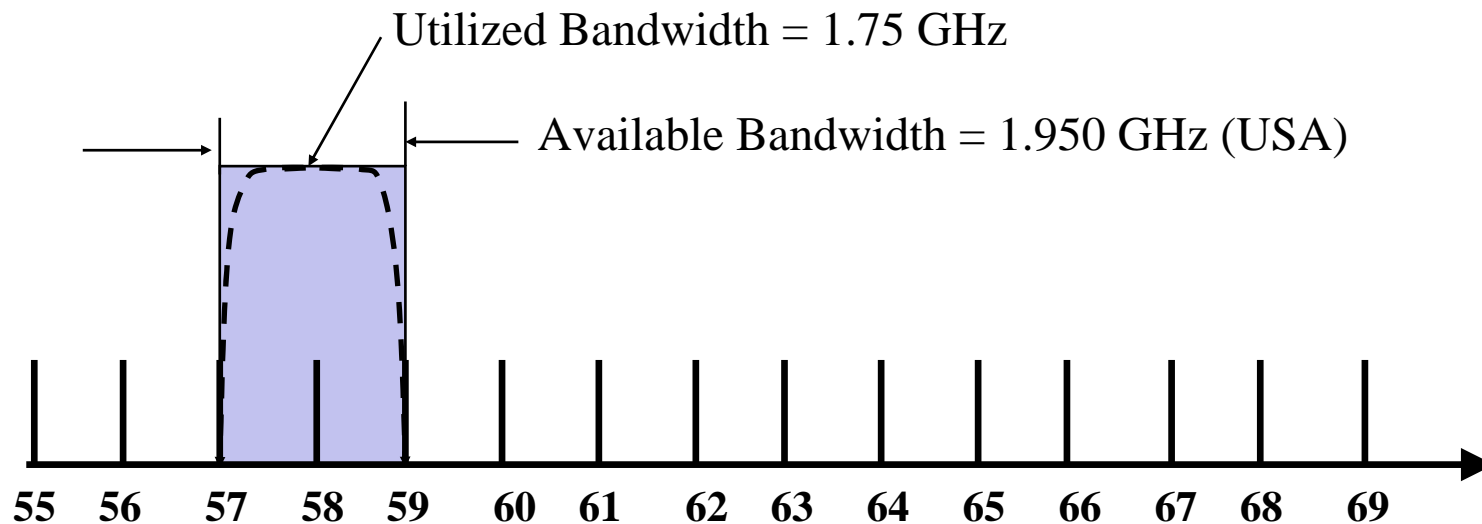

# PHY Evaluation

# Simulation - AWGN

- AWGN results with ideal bit timing
- 1 dB loss relative to theory due to group delay variation in RF filtering
- Loss can be improved with equalization and coding

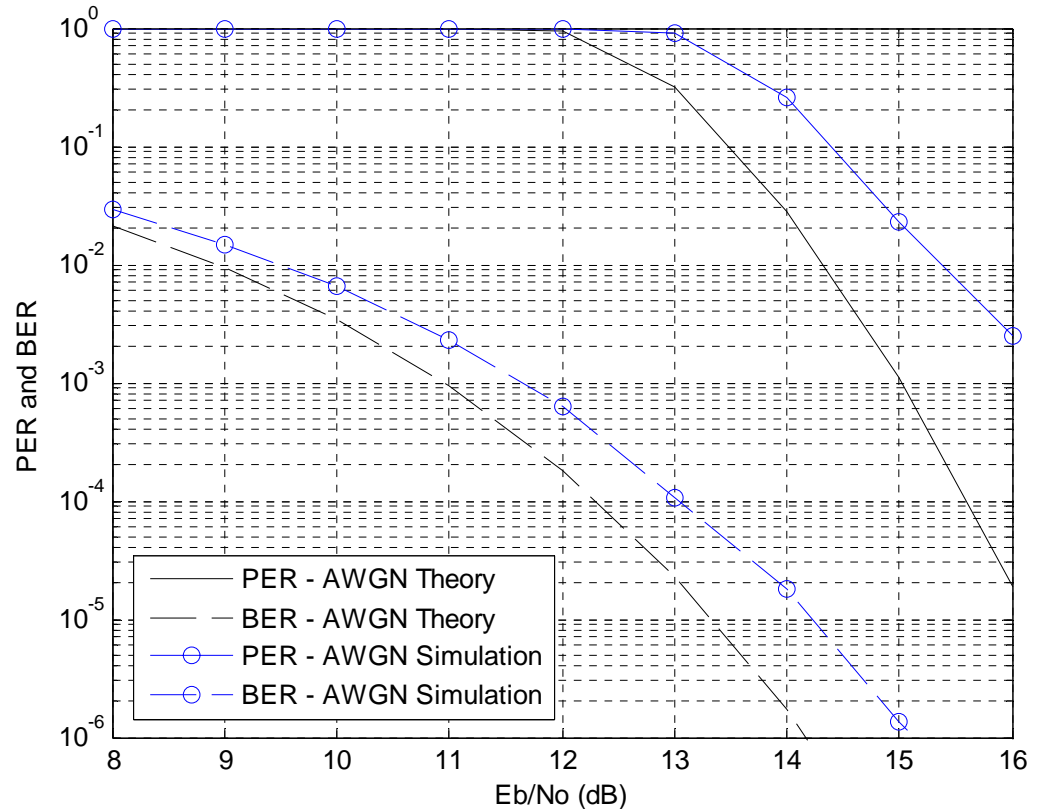

# Simulation – Phase Noise

- Non-coherent envelope detection is phase noise tolerant
- Use two-pole model with varying levels of PSD(0)

$$PSD(f) = PSD(0) \frac{[1 + (f / f_z)^2]}{[1 + (f / f_p)^2]}$$

$$f_p = 1MHz$$

$$f_z = 100MHz$$

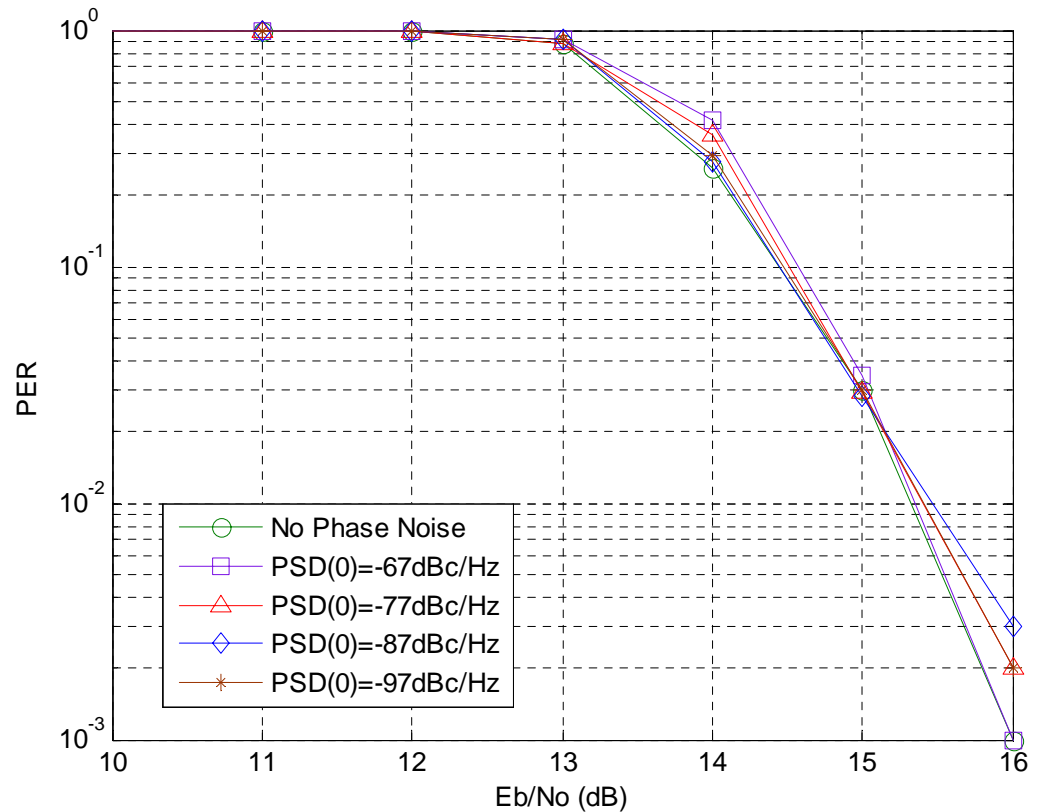



# Simulation –PA Nonlinearity

- Use Rapp model for AM-AM effects\*

$$F_{AM-AM}(V_{out}) = \frac{V_{in}}{\left(1 + \left(\frac{V_{in}}{V_{sat}}\right)^{2p}\right)^{\frac{1}{2p}}}$$

- Use GaAs pHEMT PA from NEC with  $V_{sat}=0.4$  and  $p=0.8$  [8]

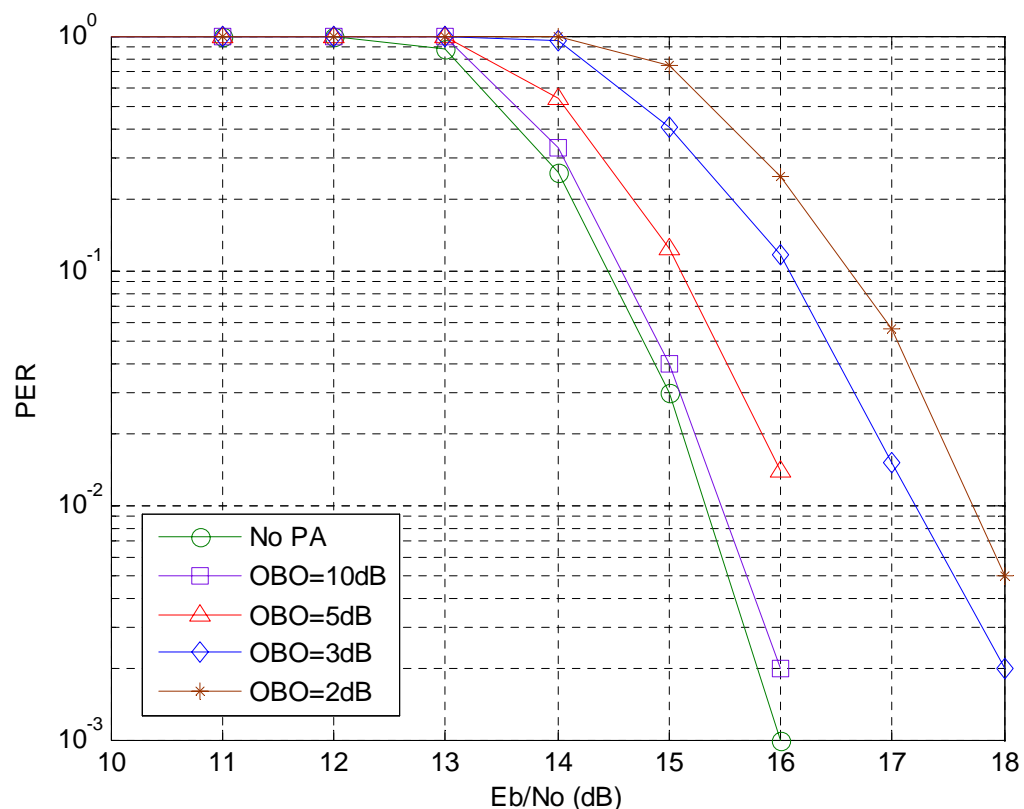

\*AM-PM effects neglected due to non-coherent envelope detection.

# Simulation – LOS Channels

- Phase noise -87 dBc/Hz, PA w/ 3 dB OBO
- 30 degree beamwidth Rx antenna
- LOS cases (CM1.3, CM9.1), multipath acts like minor increase in noise

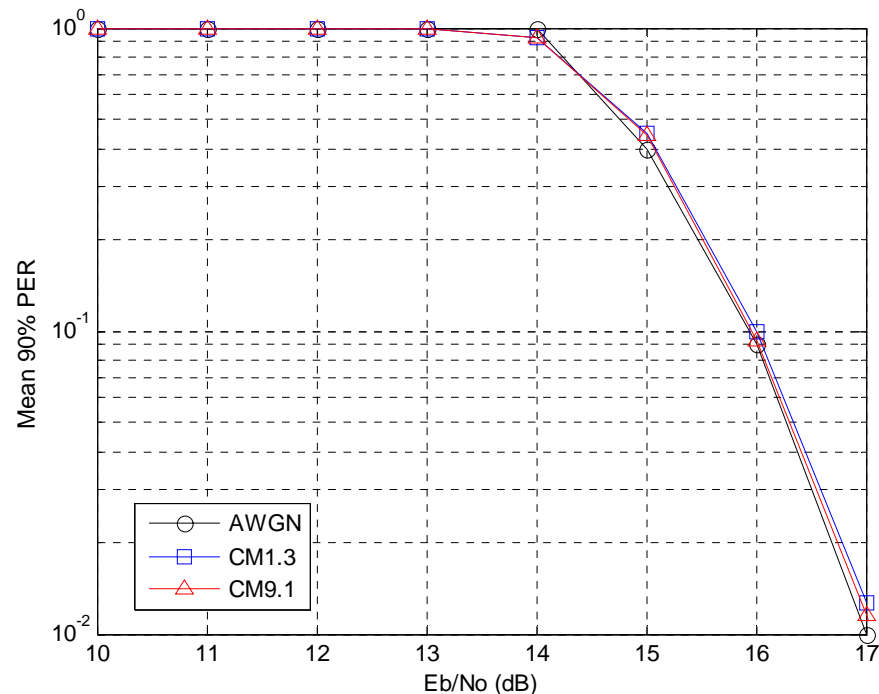
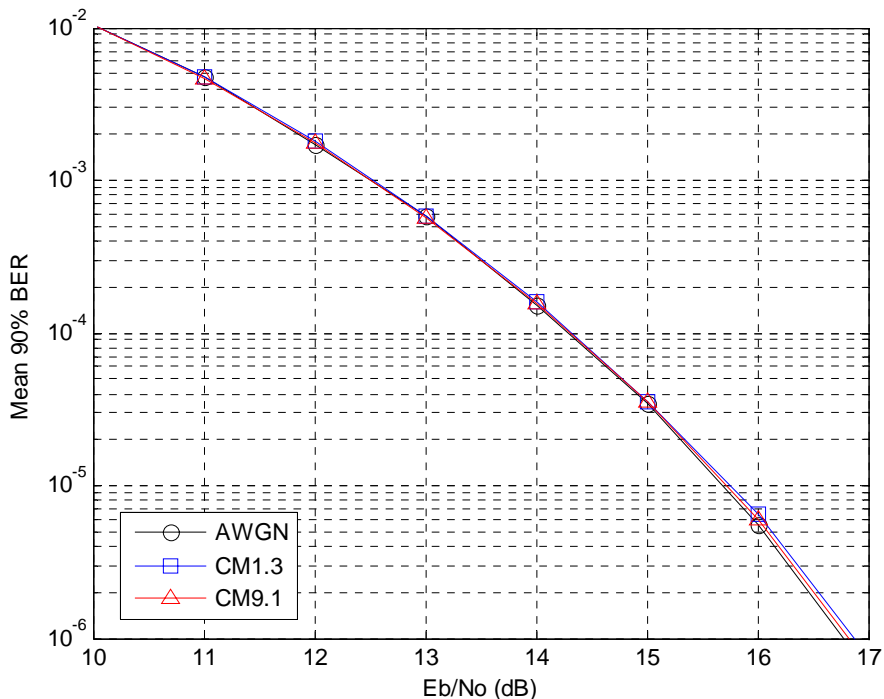

# Simulation – Co-channel Interference

- Similar signal interference
- Desired signal at 6 dB above sensitivity
- No frequency offset, random time/phase offsets

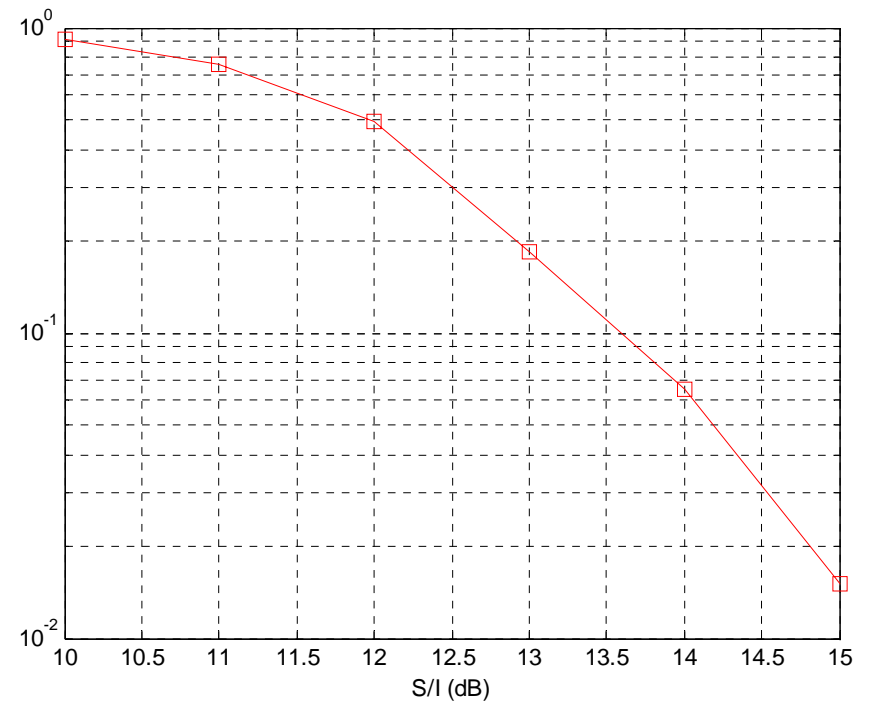
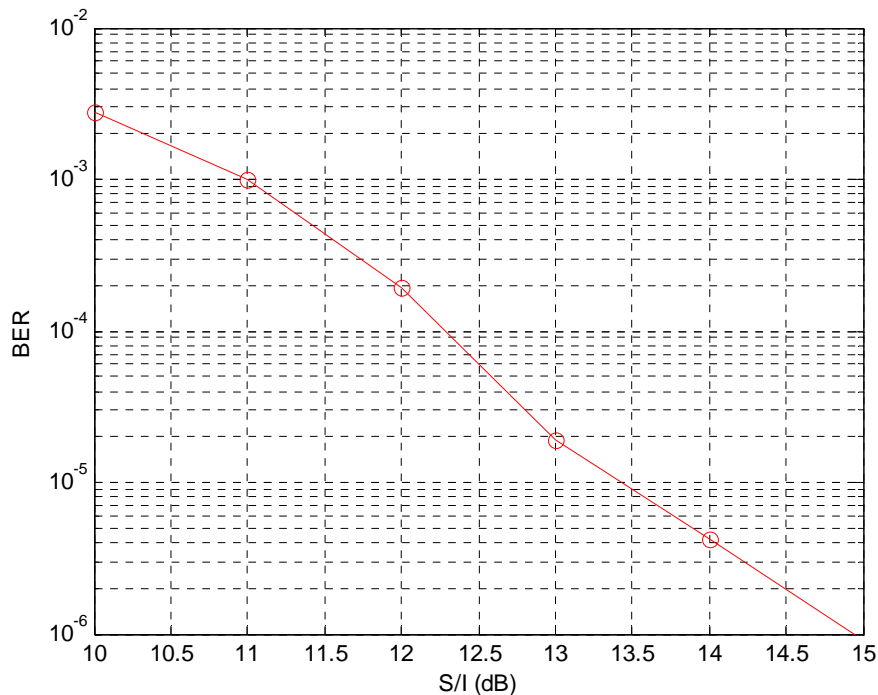

# Simulation – Implementation Losses

- Main sources of implementation loss included so far are
  - RF filter group delay (1 dB)
  - Phase noise (< 0.1 dB)
  - PA nonlinearity (1.5 dB @ 3 dB OBO)
- Other sources of loss to be considered
  - Symbol sync algorithm
  - Data thresholding algorithm
  - NLOS performance
- Potential improvements
  - Equalization
  - Coding

# Link Budget Analysis

1m, LOS

(Reference UM#5) [7]

Parameter	Value	Unit
PHY-SAP payload bit rate	2.025	Gbps
Range	1.006	m
AVG TX power	10	dBm
TX antenna gain	12	dBi
Center Freq	60	GHz
path loss at distance	-68.08	dB
RX antenna gain	12	dBi
Effective RX Power	-34.08	dBm
RX NF	5.25	dB
Noise Power (antenna)	-76.47	dBm
Shadowing link margin	1	dB
Implementation Loss	2.5	dB
Calculated Eb/No	34.26	dB
Required Eb/No (PER = 0.08%)	16.10	dB
Link Budget	18.16	dB

- No FEC
- No equalization

# Link Budget Analysis

5m, LOS

(Reference UM#1)

Parameter	Value	Unit
PHY-SAP payload bit rate	2.025	Gbps
Range	4.999	m
AVG TX power	10	dBm
TX antenna gain	15	dBi
Center Freq	60	GHz
path loss at distance	-82.07	dB
RX antenna gain	15	dBi
Effective RX Power	-42.07	dBm
RX NF	5.25	dB
Noise Power (antenna)	-76.49	dBm
Shadowing link margin	1	dB
Implementation Loss	2.5	dB
Calculated Eb/No	26.28	dB
Required Eb/No (PER = 0.08%)	16.10	dB
Link Budget	10.18	dB

- No FEC
- No equalization

# PHY Frame Structure - Preamble



- Sync Pattern – 64 bits
  - AGC settling
  - Timing acquisition
  - Equalizer training
- End-of-Preamble Marker – 16 bits
  - Unique word with good autocorrelation properties

# Frame Design – High Rate Channels

Requirement	Value	Unit	Notes
System BW	7.000	GHz	
Num channels	2		High rate channels
Max BW	2.500	GHz	
Number channels utilized	1		
M-ary modulation level	1		ASK = 1 symbol/bit
Symbol rate	2.035	Gbps	
Roll-off rate ( $\alpha$ )	0.150		Pulse shaping filter
BW	2.340	GHz	
PSDU in one packet	2048.000	byte	
PSDU coding rate	1.000		no coding
Number of Packets	1		
PSDU transmission time	8051.106	nS	
PSDU transmission rate	2.035	Gbps	
PLCP Preamble duration	39.312	nS	10 bytes
PSDU (PHY-SAP) rate	2.025	Gbps	



# Frame Design – Low Rate Channel

Requirement	Value	Unit	Notes
System BW	7.000	GHz	
Num channels	1	1	Low rate channel
Max BW	1.950	GHz	
Number channels utilized	1		
M-ary modulation level	1		ASK = 1 symbol/bit
Symbol rate	1.522	Gbps	
Roll-off rate ( $\alpha$ )	0.150		Pulse shaping filter
BW	1.750	GHz	
PSDU in one packet	2048.000	byte	
PSDU coding rate	1.000		no coding
Number of Packets	1		
PSDU transmission time	10764.783	nS	
PSDU transmission rate	1.522	Gbps	
PLCP Preamble duration	52.562	nS	10 bytes
<b>PSDU (PHY-SAP) rate</b>	<b>1.515</b>	<b>Gbps</b>	

# Manufacturability and Time to Market

- **Depends on application/market**
- 1<sup>st</sup> Generation:
  - All off the shelf components today! No chipset development
  - Chip and wire assembly, no tuning required
  - Mix of GaAs and Silicon for RF
  - Planar antennas and filters on low cost RF board materials.
  - Antenna is part of package ... no RF I/O out of package.
- 2<sup>nd</sup> Generation
  - More Highly integrated RF and baseband silicon
    - CMOS/SiGe can do all RF functions with possible exception of detector/demod.
  - More highly integrated packaging
  - Additional cost, size, and power consumption reduction while increasing performance and functionality

# Manufacturability and Time to Market

- Reduced complexity leads to lower 1<sup>st</sup> generation cost and faster time to market as well as faster market growth.
- Great opportunity to fill gap left behind by over hyped, underperforming technologies like UWB and 802.11n.

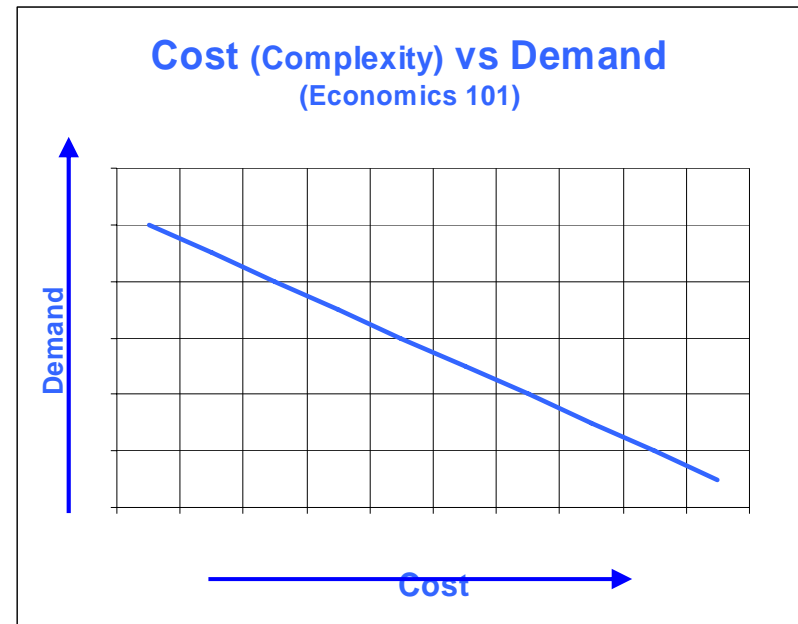

# Manufacturability and Time to Market

## Early Hardware Implementation

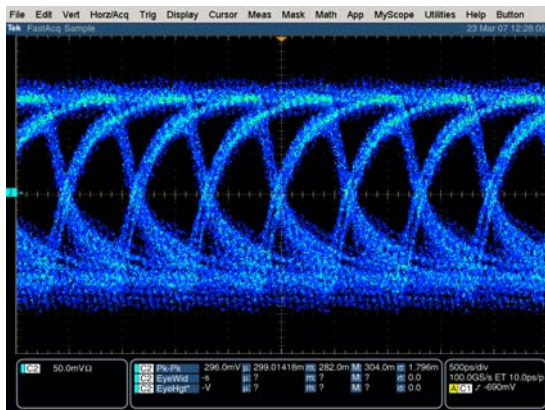

Compact Hardware Implementation

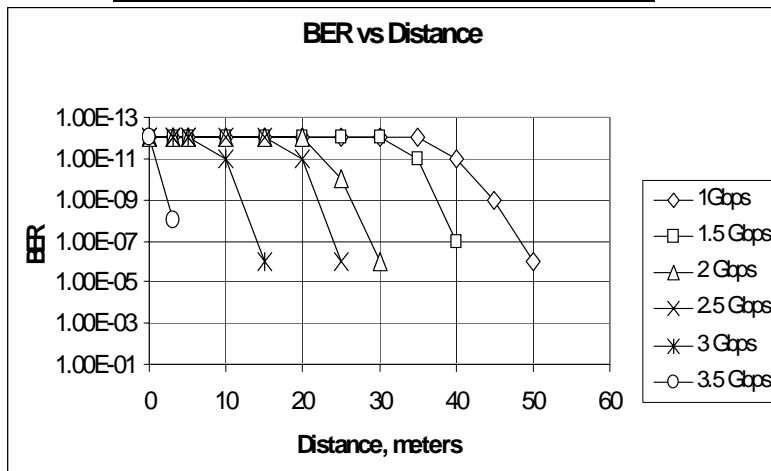
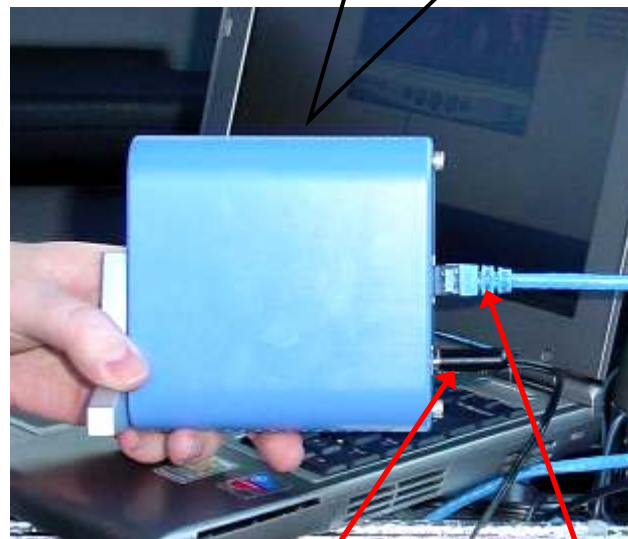

# Block Diagram

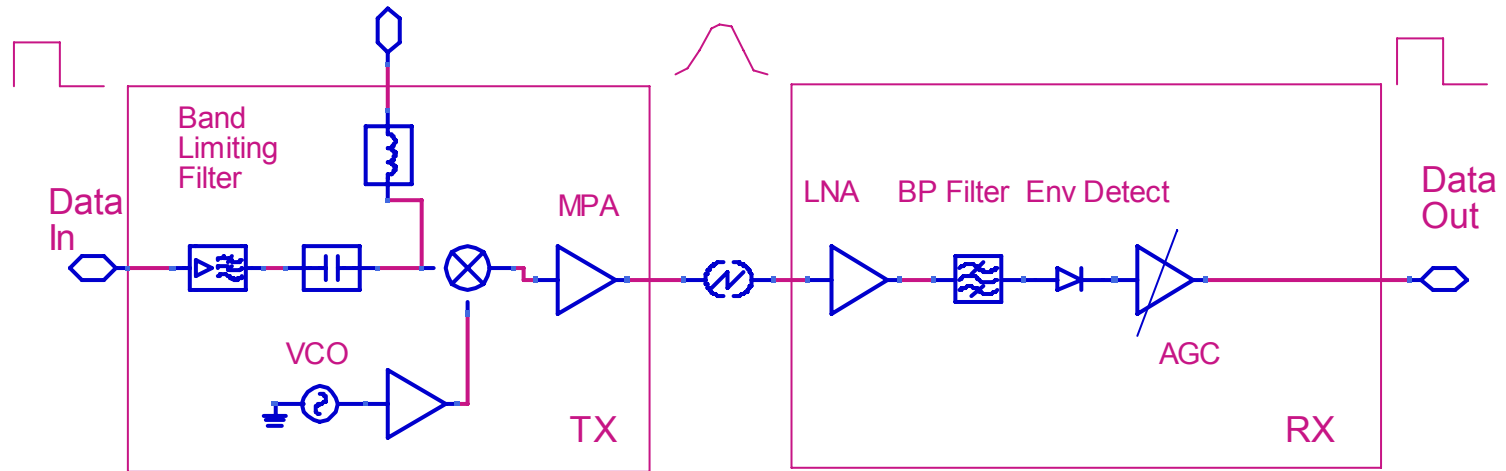

# Power requirements

- **Motivation**
- To demonstrate exemplary power consumption requirements for proposal.
  - Assumptions are based on commercially available parts, actual measurements of custom parts, reputable published literature, or reasonable and conservative technology inferences.
- **For any portable device and preferably for a dongle solution for fixed devices, a low power consumption is needed.**

# Representative Power Consumption

## Power Consumption Analysis for 802.15.3C ASK RF Front End

TRANSMIT					High Data Rate	Low Data Rate	High Data Rate	Low Data Rate
Component/Circuit	Gain (dB)	Other Specs	Note	Vcc (V)	Icc (mA)	Icc (mA)	Power (mW)	Power (mW)
VCO and Buffer	n/a	-3 dBm output	1	3	30	30	90	90
SubHarmonic Mixer	-10		2	0	0	0	0	0
Medium Power Amplifier	10	5 dBm output, 10% efficiency	3	3	12	12	36	36
Passive Multiplier	-10		4	0	0	0	0	0
PA (High data rate)	15	10 dBm output, 10% efficiency	3	3	34		102	
PA (Low data rate)	8	3 dBm output, 10% efficiency	3	3		7		21
TOTAL					76	49	228	147

RECEIVE					Icc (mA)	Icc (mA)	Power (mW)	Power (mW)
Component/Circuit	Gain (dB)	Other	Note	Vcc (V)	Icc (mA)	Icc (mA)	Power (mW)	Power (mW)
LNA	20 to 30	NF=4 to 5 dB	5	2	12	12	24	24
Detector/AM Demodulator	3000 V/W		6	0	0	0	0	0
AGC (High speed)	20-50		7	3	30		90	0
AGC (Low speed)	20-50		8	3		18	0	54
TOTAL					42	30	114	78

Total Power Consumption: 118    79    342    225    mW

**Assumptions:**

- Components represented in generic block diagram
- Components and functional blocks are exemplary only
- High data rate is > 2 Gbps
- Low data rate is < 250 Mbps

**Notes (examples of real components):**

- 1 Based upon custom SiGe performance
- 2 "Si-based 60GHz 2X Subharmonic Mixer for Multi-Gigabit Wireless Personal Area Network Application", Sarkar et al, 2006. IEEE MTT-S International
- 3 Estimate based upon assumed conservative achievable efficiency
- 4 Estimate based upon conservative 2X passive multiplier efficiency
- 5 "60GHz transceiver circuits in SiGe bipolar technology", Reynolds et al, Solid-State Circuits Conference, 2004
- 6 Avago/Agilent HSCH-9161
- 7 Maxim MAX3746
- 8 Maxim MAX3645

# Scalability

- **Motivation**
  - To introduce a means of addressing near term, early to market opportunities.
- **Premise**
  - A common architecture can be used to meet the minimum 2 Gbps standard requirement, while at the same time allowing lower data rate implementations that are more suitable for early adoption in certain markets
    - Cost sensitive markets
    - Mobile product (low power consumption) markets
    - Products lagging in complementary host interface technology
- **Entry of products into these markets based upon this standard may be critical to the success of the standard.**



# Scalability

- **Approach**

- Device recognition
    - Tier I devices seen as primarily operating at common rate or above.
    - Tier II devices seen as primarily operating at common rate or below.
  - Tier II devices seen as near-term, entry-level devices. Could reach high volumes relatively quickly.
    - Eventually, would evolve into Tier I devices, most likely in the 3 – 5+ year time frame.
    - Could use QPSK or other back-compatible scheme
  - To guarantee interoperability, establish common data rates.
- [6]

# Scalability

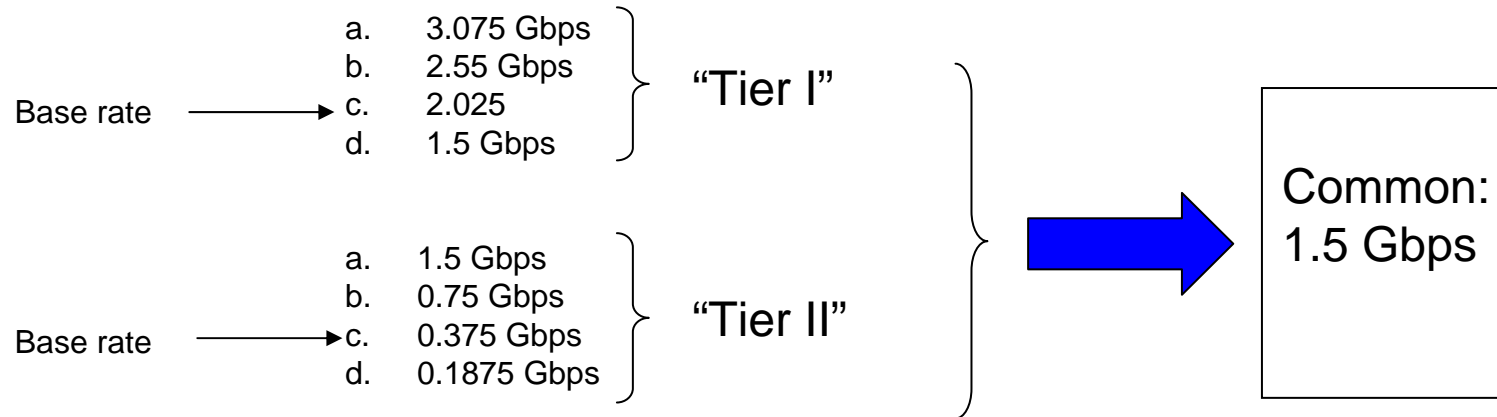

**Note:** *Data rates shown are exemplary. Other rate plans are certainly possible.*

**Advantage:** Optimal for industry-wide projected portable device roadmaps. “Tier II” devices compatible with USB2 and other data transfer protocols. One common data rates provide compatibility. Tier II devices meet requirements of UM5 and requirements of 802.15.3c PAR. [9]

**Disadvantage:** “Tier II” devices have no mode of operation that meets requirement of “mandatory 2.0 Gbps”.

# Scalability

- Cost and power consumption goes up with data rate.
- Demand seen for throughput in the 100 to 1000 Mbps range that other standards are not going to be able to meet.
- Forcing all compliant devices to be capable of 2 Gbps forces cost and power consumption to be higher than needed for early market opportunities.

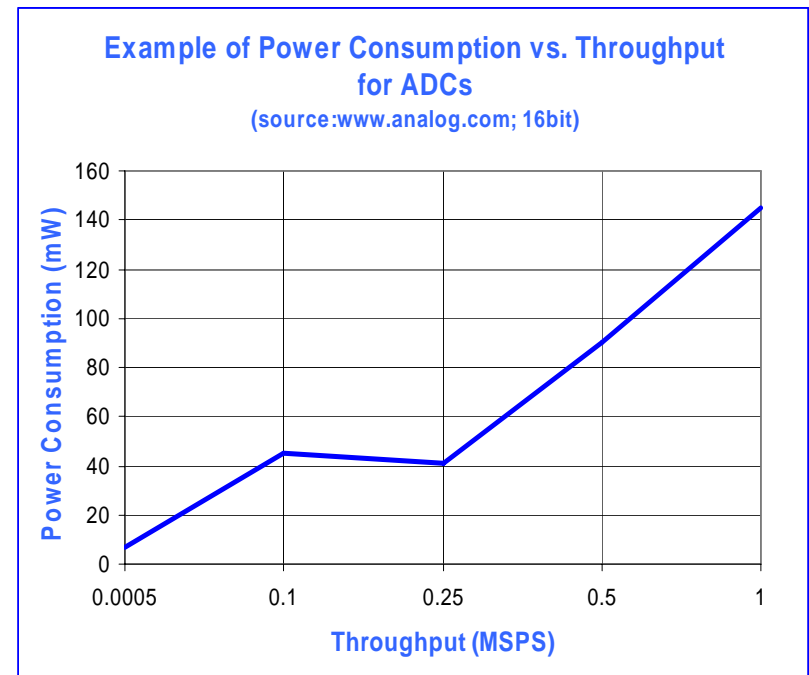

# Path to higher data rates

- **Multi-level ASK**
  - Ternary ASK possibility – gigabit prototype demonstrated by Motorola Labs ca. 2005.
  - Other similar M-ary ASK modulation techniques could provide greater data rates [9], [10] in the same bandwidth.
- **QPSK, other**
  - Future generations could employ QPSK.
  - Compatible with ASK.
  - Evolutionary cost versus performance for silicon should enable more complex architectures.
- **Key: Backward compatibility**
  - Maintained by using at least one common data rate and compatible modulation scheme

# Video Streaming, Data Synching

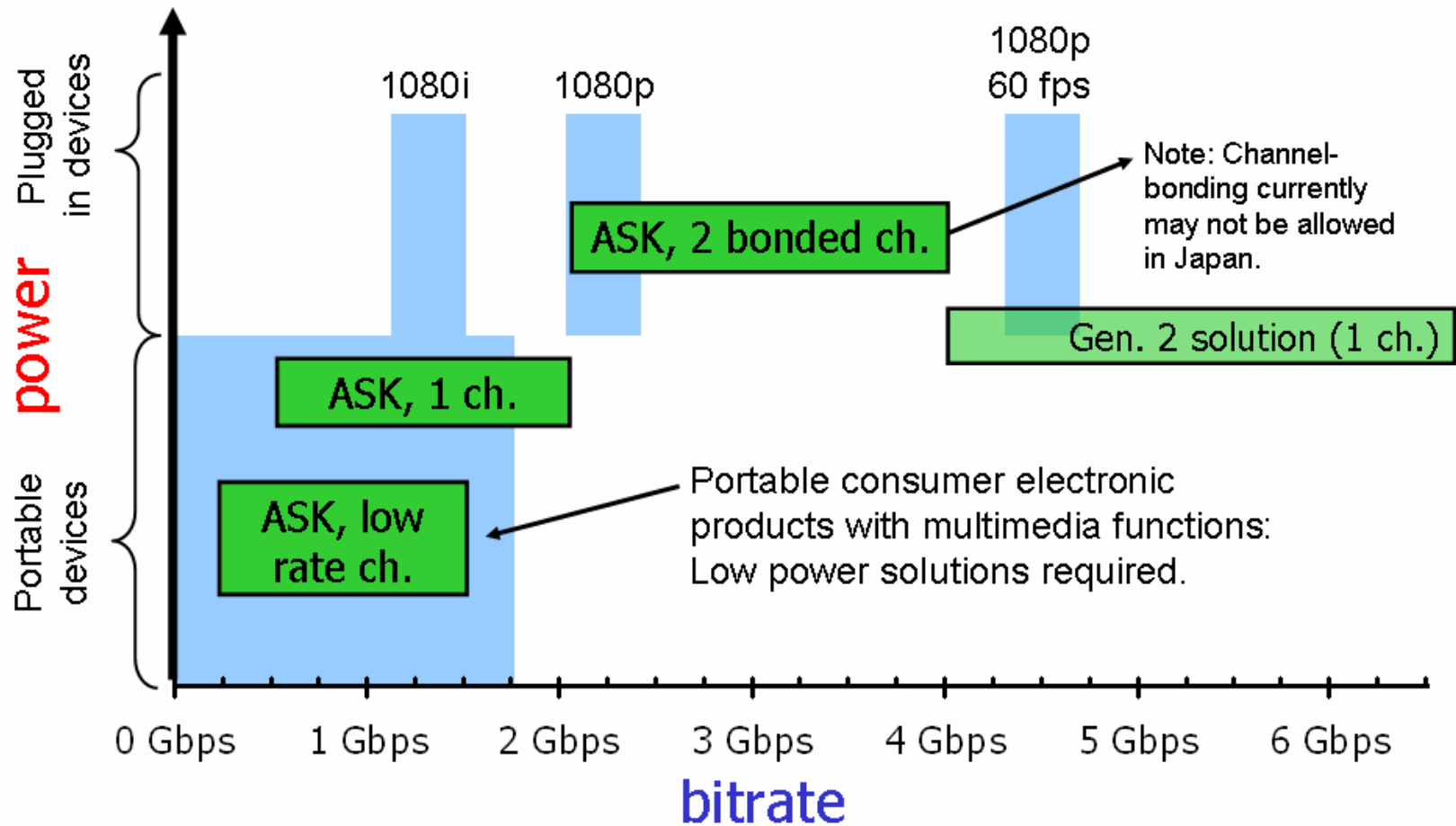

# Conclusion

- Exceeds mandatory data rate requirements while adhering to regulatory restrictions.
- Successful demonstration of mandatory Use Cases.
- Roadmap to higher data rates for future systems while maintaining backward compatibility.
- Viable approach for a low cost, low power consumption, small form-factor, commercially viable solution.

# References

- [1] B. Bosco, “Multi-gigabit wireless demonstration using 60 GHz band”, IEEE 802.15-05/0177r0, Atlanta, Ga., USA, March 2005.
- [2] A. Seyedi, “TG3 Selection Criteria”, IEEE 802.15-05-0493-27-003c, London, UK, January 2007.
- [3] A. Seyedi, “TG3c System Requirements”, IEEE 802.15-07-0583-01-003c, Orlando Fl. USA, March 2007.
- [4] J. Oetting, “A Comparison of Modulation Techniques for Digital Radio”, *IEEE Transactions on Communications*, Dec. 1979.
- [5] A. Seyedi, “On Channelization Requirements for 802.15.3c”, IEEE 802.15-06-0325-00-003c, San Diego, Ca., USA, July 2006.
- [6] B. Bosco, “Data Rate Back Off Modes for 802.15.3c Alternate PHY”, IEEE 802.15-07-0651-00-003c, Orlando, Fl., USA, March 2007.
- [7] A. Sadri, “802.15.3c Usage Model Document (UMD), Draft”, IEEE 802.15-06-055-22-003c, Orlando Fl. USA, March 2007.

# References

- [8] C.S. Choi et al., “Behavior model of 60GHz-band power amplifier for SYS/PHY evaluation”, IEEE 802.15-06-0396-01-003c, Melbourne Australia, September 2006
- [9] IEEE 802.15.3c PAR, approved March 03, 2005.
- [10] C. A. Rypinski, “3-level AM DSBSC High-rate Data Modulation”, IEEE 802.15-0367-00-003c, Portland, Oregon USA, July 2004.
- [11] T. Itoh, “RF Front-Ends for 60 GHz Multimedia Wireless Systems”, Final Report 2000-2001 for MICRO Project 01-040, UCLA, Las Angeles, CA. USA