

Project: IEEE P802.15 Working Group for Wireless Personal Area Networks (WPANs)

Submission Title: [MSK-based 60GHz PHY Proposal]

Date Submitted: [7 May, 2007]

Source: [Troy Beukema, Brian Floyd, Brian Gaucher, Yasunao Katayama, Scott Reynolds, Alberto Valdes-Garcia] Company [IBM Research]

Address [1101 Kitchawan Rd. Rte. 134, MS:30-116]

Voice:[+914-945-2598], E-Mail:[avaldes@us.ibm.com]

Re: [In response to TG3c Call for Proposals (IEEE P802.15-07-0586-02-003c)]

Abstract: [Description of an MSK-based 60 GHz PHY proposal].

Purpose: [For discussion only]

Notice: This document has been prepared to assist the IEEE P802.15. It is offered as a basis for discussion and is not binding on the contributing individual(s) or organization(s). The material in this document is subject to change in form and content after further study. The contributor(s) reserve(s) the right to add, amend or withdraw material contained herein.

Release: The contributor acknowledges and accepts that this contribution becomes the property of IEEE and may be made publicly available by P802.15.

Introduction

- Due to the unique propagation characteristics at 60 GHz, different modulation formats should be employed to implement efficient devices for different applications
- UM5 (short distance, LOS, light multi-path operation) requires a system implementation that assures small form factor, low complexity and low power consumption for portable devices
- We present an MSK-based PHY proposal for UM5
- UM1 and others will require modulations and system architectures suitable for NLOS, multi-path operation; these applications will be less sensitive to cost / power
- We are open to merge with / support other proposals to effectively address all usage models in a complete solution
- Our transceiver chipset is flexible and supports virtually all modulations

Mandatory 60-GHz Usage Model 5: Wireless Kiosk

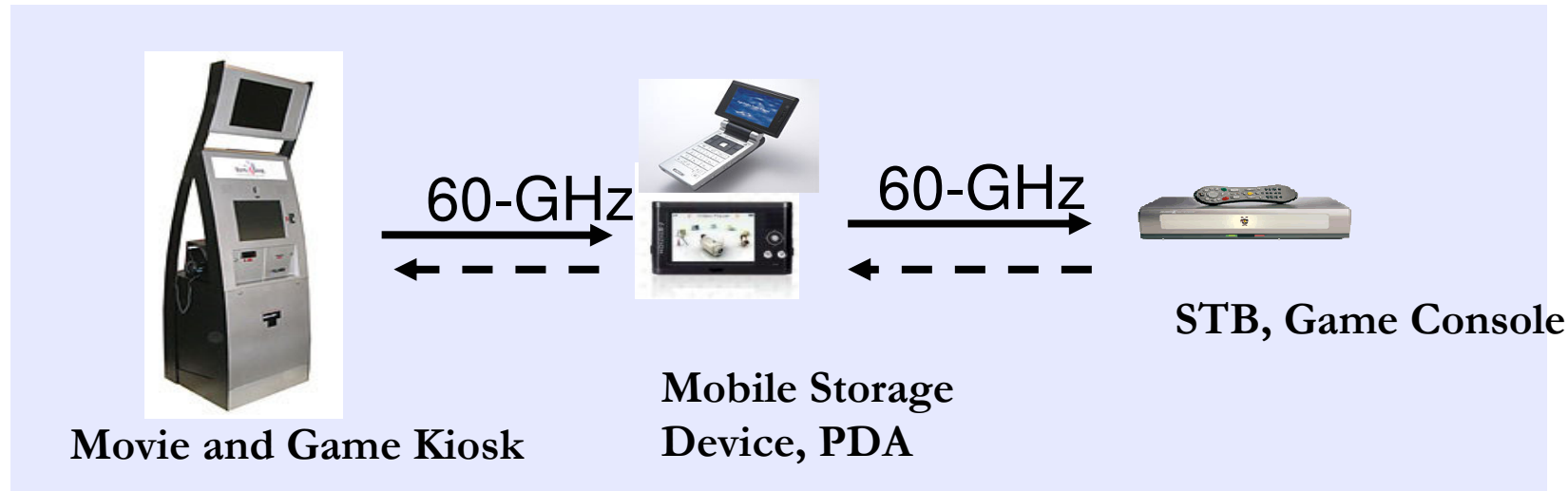

Ref: IEEE Doc 15-06-0369-09-003c

- Rate ~ 1-3 Gb/s burst data; Range ~ 1m
- Directional antennas assure light multi-path condition in LOS over short distances
- Low complexity and low power and +Gb/s data rate can promote early market deployment
- A power outlet operated receiver (kiosk, media player) can incorporate an equalizer for improved multi-path reception if required

MSK Modulation Overview

MSK can be described as phase-continuous 2-level FM with deviation = $R/4$ where R = data rate.

The frequency is allowed to change polarity on quadrant boundaries only.

MSK data encoding :

1 bit : freq = $+R/4$

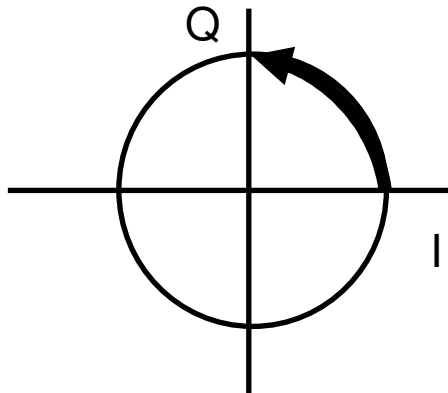

0 bit : freq = $-R/4$

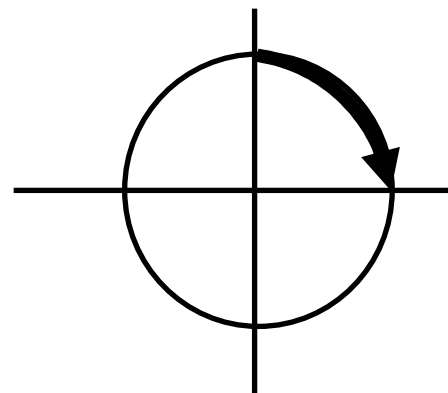

Frequency changes at phase= $0, \pi/2, \pi,$ and $3\pi/2$ radians only

MSK Generation

MSK can be generated by modulating the signs of half-sine pulses separated by 90 degrees on I and Q axes.

A sine pulse sign is encoded with a data bit corresponding to the first half of the pulse in time duration.

To encode + Frequency (1) data bit value :

- on Q pulse : Q pulse sign = I pulse sign over bit interval
- on I pulse : I pulse sign = opposite of Q pulse sign over bit interval

To encode - Frequency (0) data bit value :

- on Q pulse : Q pulse sign = opposite of I pulse sign
- on I pulse : I pulse sign = Q pulse sign

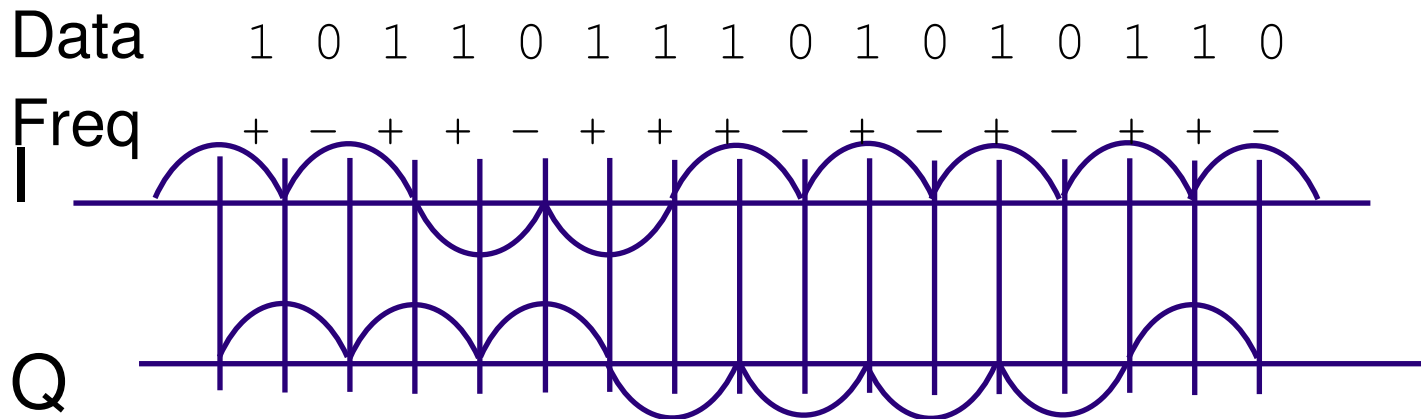
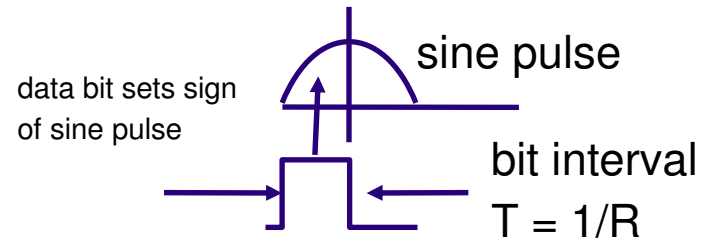

Performance in AWGN Channel, Non-coherent Detection

MSK FM Discriminator AWGN BER Sensitivity

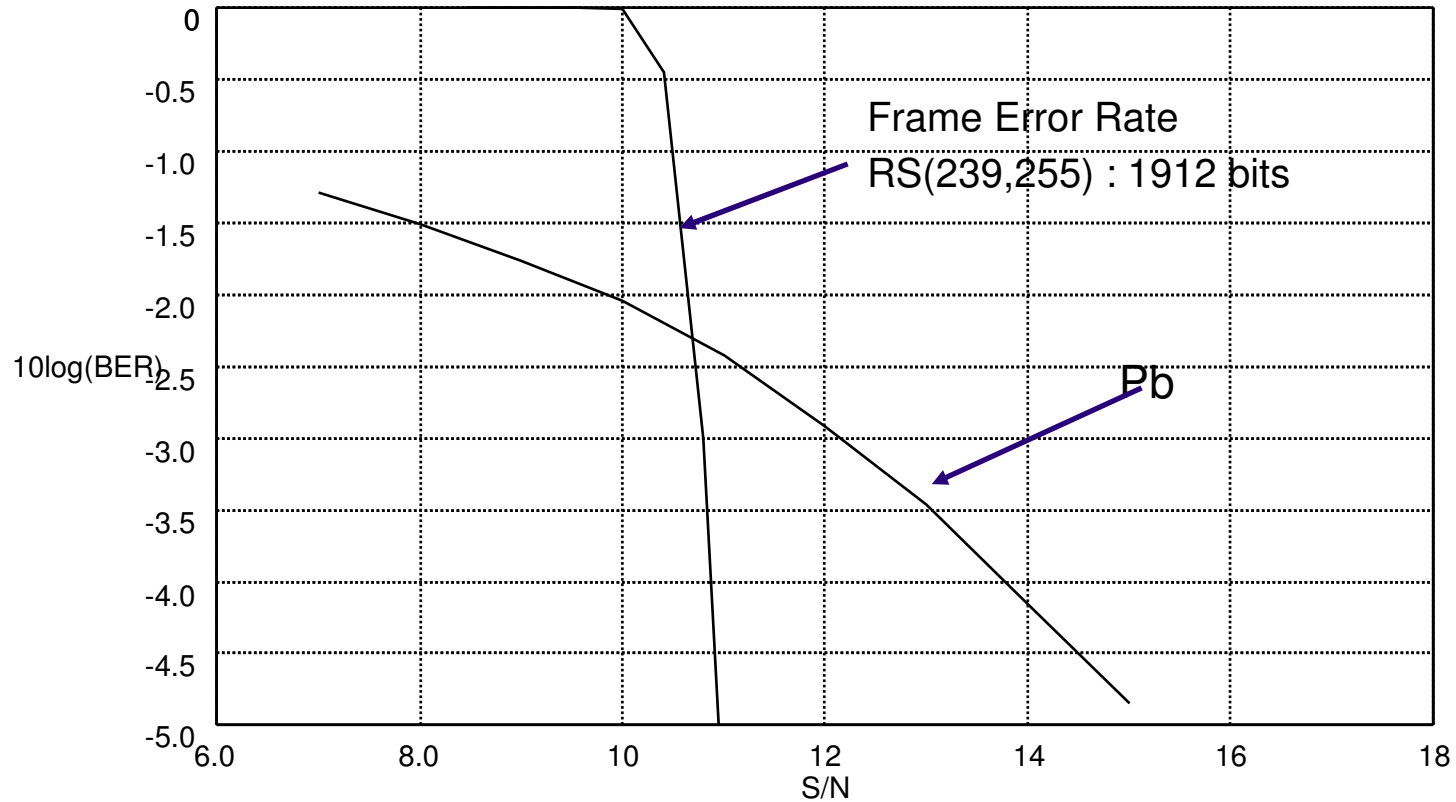

15 SNR is needed for low error rate ($1e-5$) operation. Addition of a RS(255,239) code improves sensitivity to ~ 11 dB SNR for length 1912 bit packets

Es/No Performance in AWGN Channel: Comparison

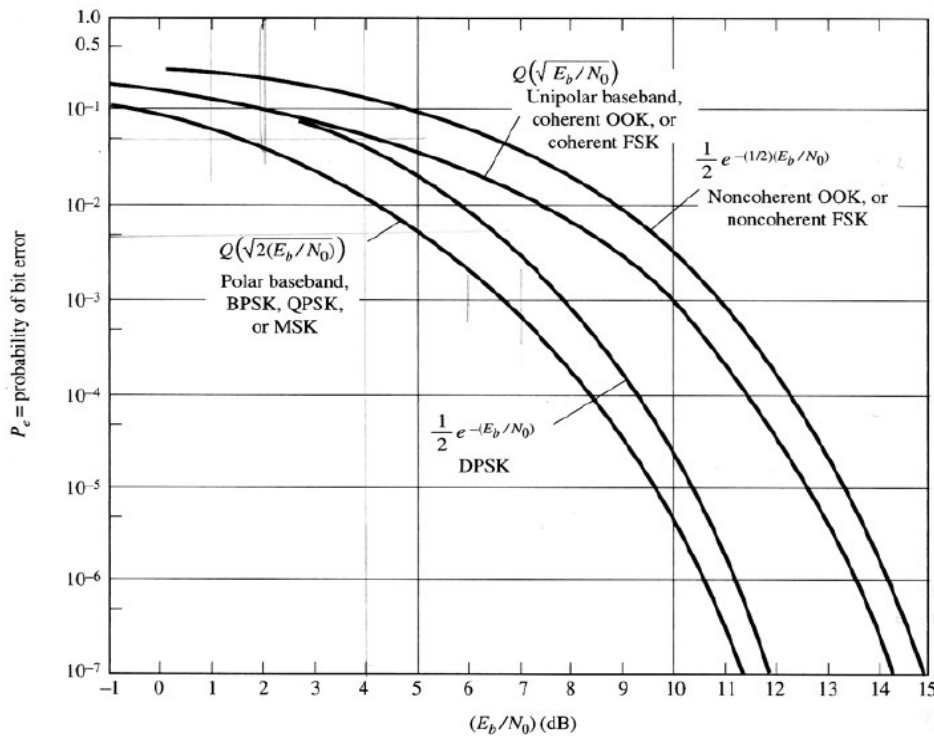

Figure 7-14 Comparison of the probability of bit error for several digital signaling schemes.

- Coherent optimum detection of MSK has the same performance as BPSK and QPSK
- This is the type of detection could be employed in a stationary media player
- Performance loss due to sub-optimal detection of MSK is not critical for short-range applications and it can be compensated with antenna gain

[1] Leon W. Couch, *Digital and Analog Communication Systems*, 6th edition, pp. 500.

MSK Spectral Efficiency

Modulation	Spectral efficiency in ((bits/sec)/Hz) for different Bandwidth definitions			
	Zero-to-null (BB)	Null-to-null (RF)	90% Energy	-30dB
BPSK	1	0.5	0.625	0.052
MSK	1.334	0.667	1.282	0.438
QPSK	2	1	1.25	0.104

- For null-to-null BW, MSK is about 33% more efficient than BPSK
- MSK side lobes decrease much faster than BPSK and even QPSK
- For this reason, on 90% energy BW and -30dB BW, MSK is >100% more efficient than BPSK, and even better than QPSK

[1] Leon W. Couch, *Digital and Analog Communication Systems*, 6th edition, pp. 364-367.

[2] Theodore S. Rappaport, *Wireless Communications*, 1st edition, pp. 240, 260-63.

MSK Spectral Efficiency - II

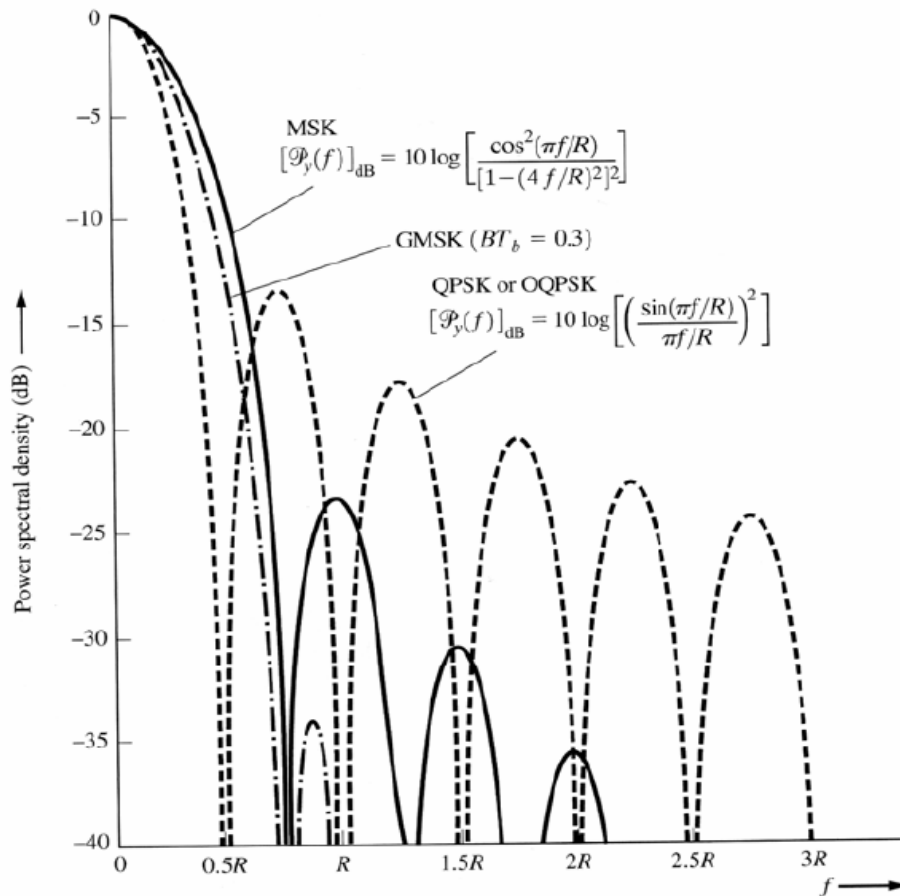

Figure 5-35 PSD for complex envelope of MSK, GMSK, QPSK, and OQPSK, where R is the bit rate (positive frequencies shown).

- BPSK (not shown) has a much wider main lobe and has its first null at R
- MSK has most of its energy in the main lobe and its side-lobes drop faster than the ones from other modulations
- Second MSK side-lobe is 10dB smaller than the one for QPSK

[1] Leon W. Couch, *Digital and Analog Communication Systems*, 6th edition, pp. 364.

MSK Spectral Efficiency - III

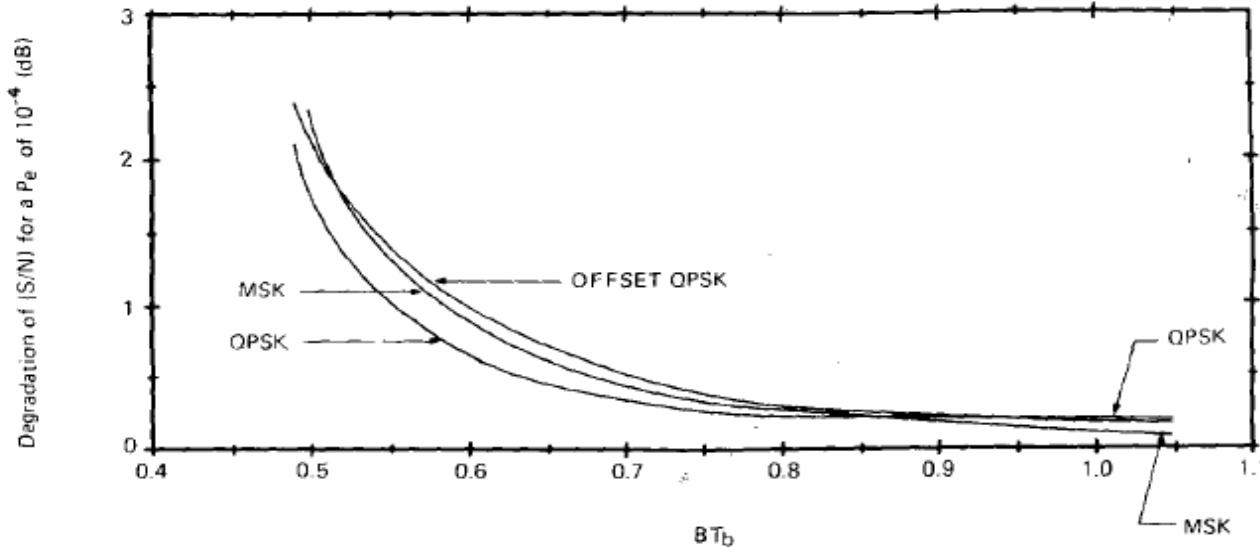

Fig. 9. Degradation, due to filtering, then limiting, of $(S/N_b)_{rcvr.}$ input versus normalized prelimited filter bandwidth.

- Both Filtered MSK and Filtered QPSK have comparable performance
- Both have a negligible performance penalty with a filter BW equal to the bit rate (e.g. 2GHz RF BW for 2Gbps) and 2dB degradation for BW equal to half the bit rate (e. g. 1GHz BW for 2Gbps or 2GHz BW for 4Gbps)

[4] D. H. Morais and K. Feher, "The effects o Filtering and Limiting on the Performance of QPSK, Offset QPSK and MSK Systems", IEEE Transactions on Communications, Vol. COM-28, No. 12, December 1980, pp. 1999-2009

MSK Spectral Efficiency - IV

- Unfiltered MSK is always more efficient than BPSK and OOK regardless of BW definitions
- When considering the main lobe's energy, MSK efficiency is comparable to QPSK
- For a given filter BW and data rate, MSK will always show smaller side-lobes than OOK, BPSK and QPSK
- Filtered MSK and filtered QPSK show comparable performance degradation for a given filter BW and data rate
- Our proposal focuses on exploiting the spectral efficiency advantages of MSK to achieve 2Gb/s using 2GHz of BW with simple RF filtering

Simulation Results for a 2Gb/s 60GHz Band-limited MSK System

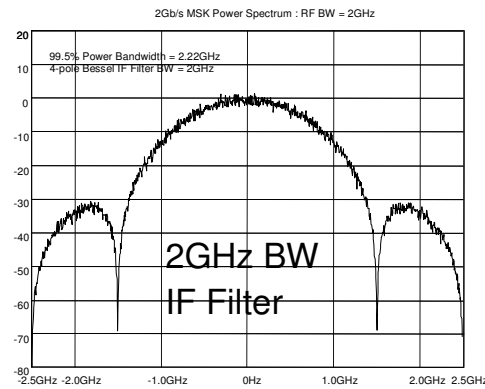
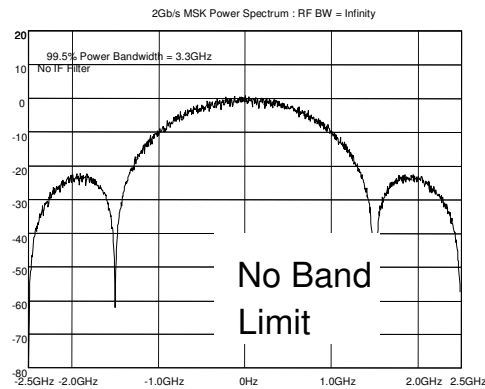
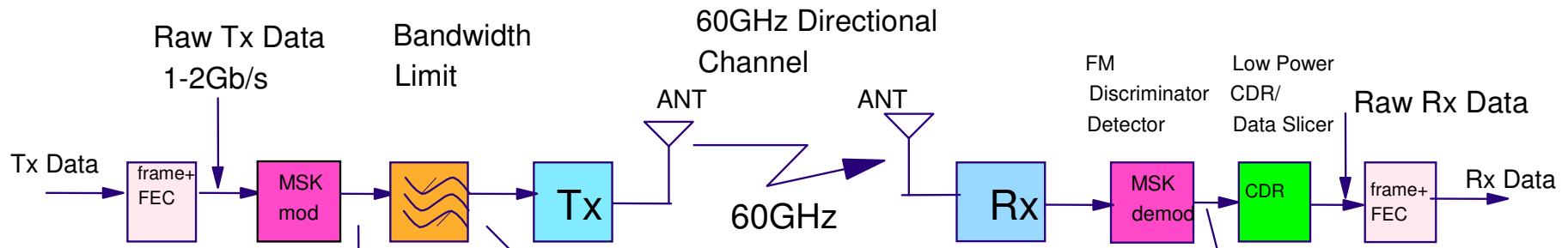

NRZ Signal
2Gb/s Detected Eye Diagram
:Tx IF BW = 2GHz

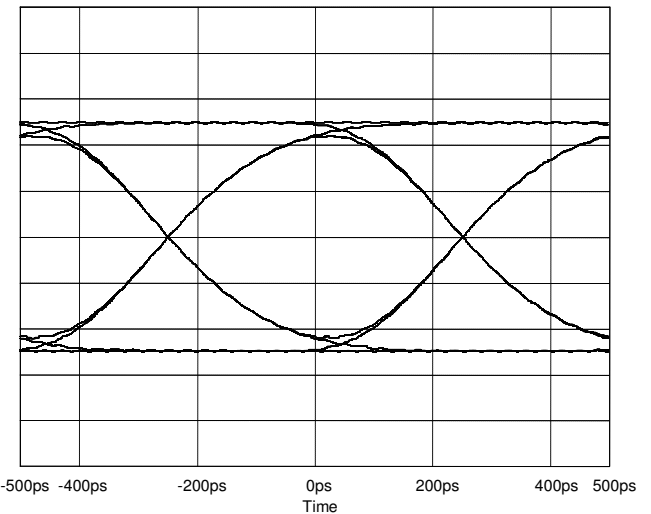

Data Rate	3dB IF BW ₁	1st Sidelobe	99.5% BW
1Gb/s	infinity	-23dB	1.6 GHz
1Gb/s	1GHz ₂	-30dB	1.1 GHz
2Gb/s	infinity	-23dB	3.3 GHz
2Gb/s	2GHz	-30dB	2.2 GHz

MSK Link Budget, FM Detection, AWGN

Parameter	Value
PA output power [dBm]	11
antenna interconnect loss [dB]	2
Rx/Tx antenna gain [dB]	7
EIRP [dBm]	16
Path-loss exponent	2
Rx NF [dB]	6.5
Rx NF at antenna [dB]	8.5
Required Es/No	11
Rx impl. Loss [dB]	1
Path loss at 1m [dB]	68
Power at 1m after antenna [dBm]	-45
Noise BW for FM detector [Hz]	2.00E+09
RX Sensitivity @ 2Gb/s [dBm]	-60.5
Link Margin @ 1m	15.5
Range @ 2Gb/s [m]	5.9
Range with 6dB margin [m]	3.0

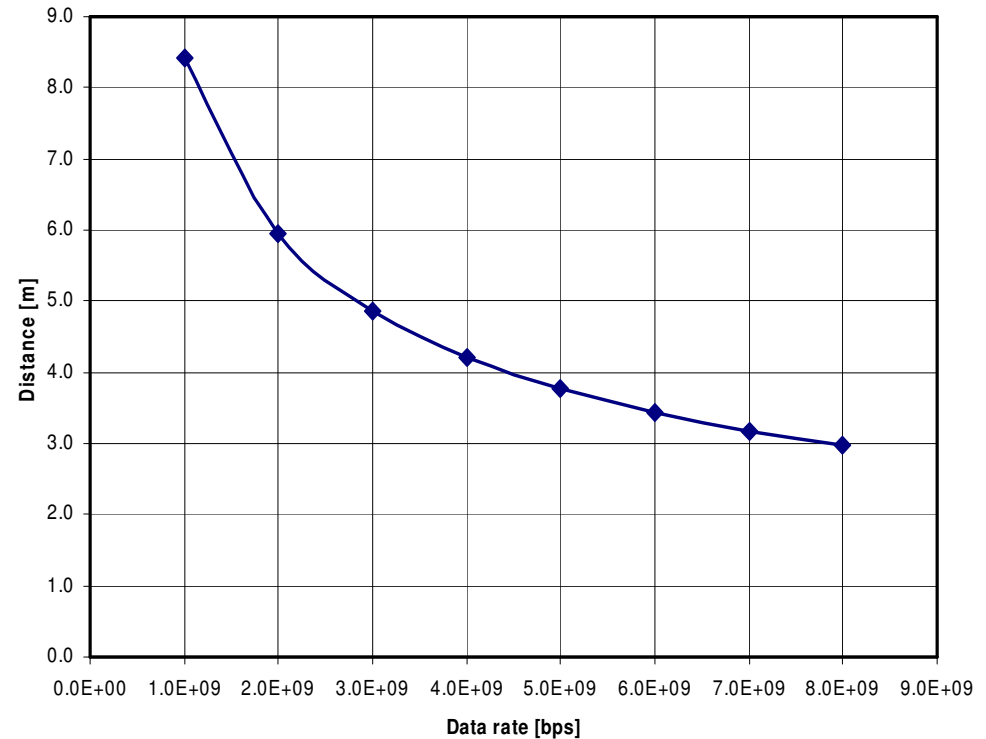

- The physical layer characteristics correspond to the measured performance of our chipset
- Data range can be further extended with higher gain antennas currently under development

Tolerance to Multi-path in an LOS Environment

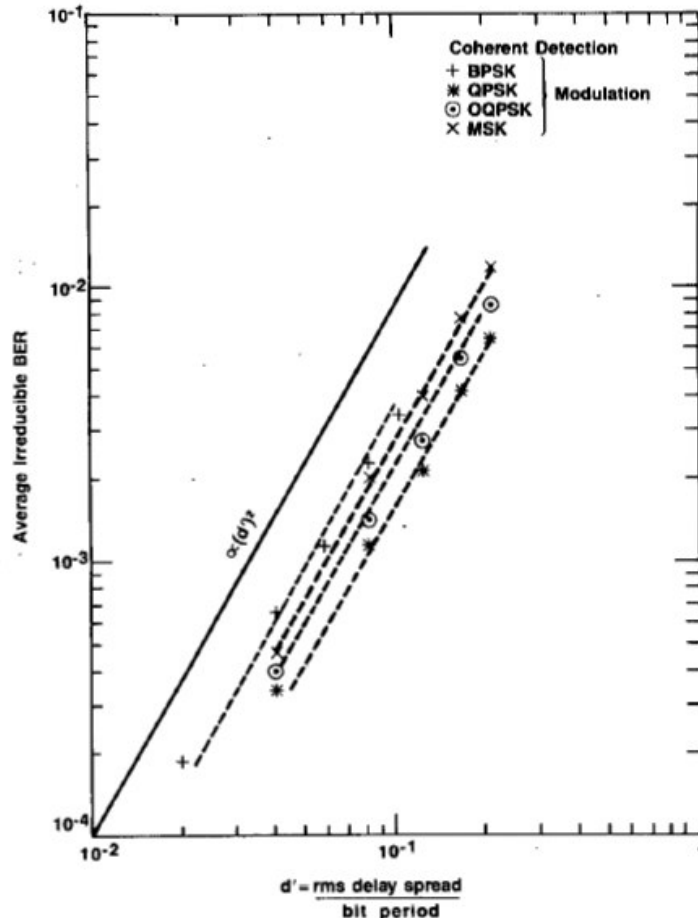

- Average irreducible BER as a function of rms delay spread normalized by bit period
- No significant difference between BPSK, MSK and QPSK
- MPSK performs better than BPSK
- Sensitivity of MSK to multi-path does not increase with filtering [6]
- For envisioned SD point-and-shoot applications with directive antennas multi-path won't be a limitation

[5] J. C.-I. Chuang, "The Effects of Time Delay Spread on Portable Radio Communication Channels with Digital Modulation", IEEE Journal on Selected Areas in Communications, Vol. SAC-5, No. 5, June 1987, pp. 879-889

[6] V. V. Lipovac, "On the Error Floor of MSK Signal Transmission over a Multipath Channel with Small Time Dispersion", IEEE Transactions on Vehicular Technology, Vol. 49, No. 1., January 2000, pp. 117-129

Implementation Complexity - I

Receiver Architecture

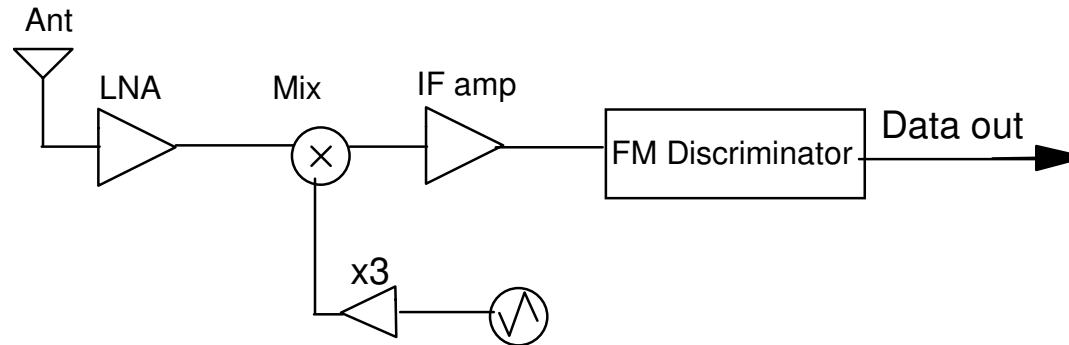

Transmitter Architecture

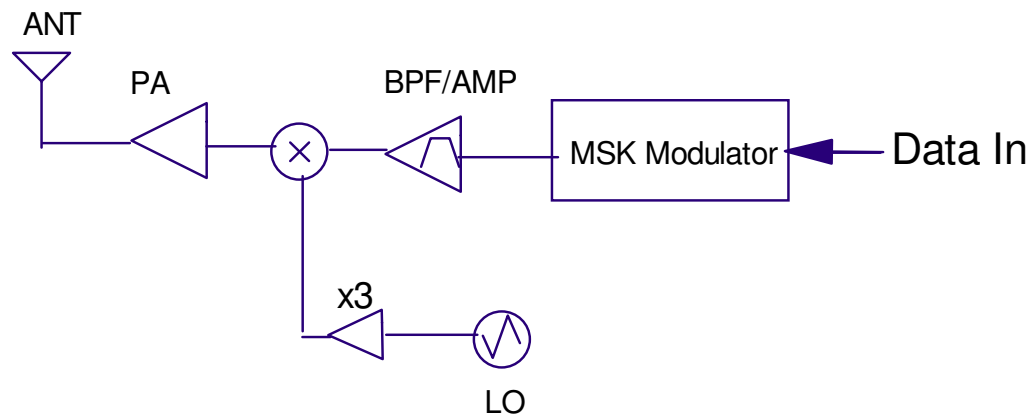

Implementation Complexity - II

▪ Receiver

- FM demodulator occupies only 0.02mm²
- No AGC is required, which simplifies the preamble
- RX chain can be operated at compression relaxing linearity requirements

▪ Transmitter

- Modulator is embedded in the IF up-mixer, occupies only 0.06mm², and presents no additional power overhead
- The same circuit is employed to receive I&Q inputs with other modulations (e.g. QPSK), so there is no duplicated investment to support MSK
- Entire TX chain can be operated at compression

▪ **From our perspective, the area and complexity required to implement MSK is insignificant in comparison to the complexity of the entire transceiver**

MSK Link Experiment Architecture

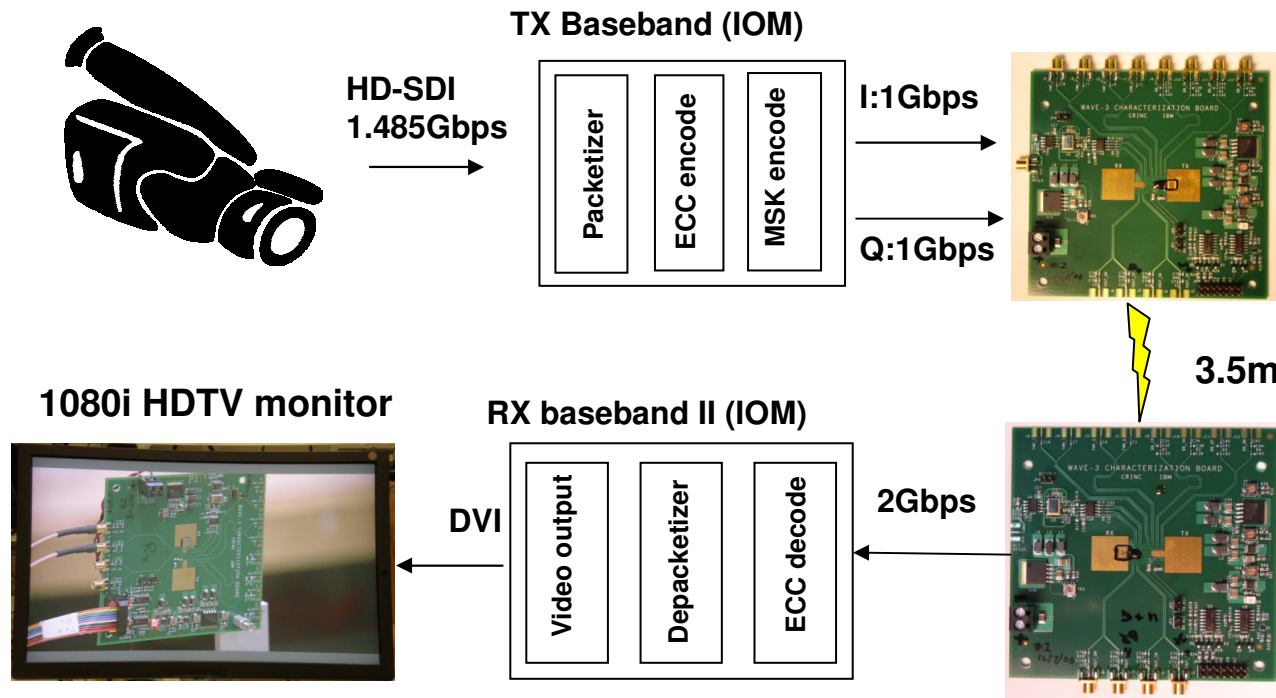

- MSK modulation and FM detection are performed on-chip
- Current achieved 3.5m distance is limited by lab space
- Measured TX spectrum shows sidelobes at -30dB

Properties of MSK for 60GHz LOS Operation: Summary

- Well understood signaling scheme, discussed in open literature for more than 20 years
- Better spectral efficiency than OOK and BPSK, and comparable to QPSK
- Performance of filtered MSK is comparable to filtered QPSK
- Obviates the need for receiver AGC and ADC
- Lower TX complexity and possibility of using more efficient non-linear PA
- Very compact ($<0.1 \text{ mm}^2$) silicon modulator/demodulator implementation
- 2Gb/s raw data transmission is achieved with 2GHz bandwidth using simple analog band pass filtering
- Experimentally demonstrated 3.5m range for uncompressed video at 60GHz using a silicon transceiver chipset
- Overall best choice for UM5

Back up slides

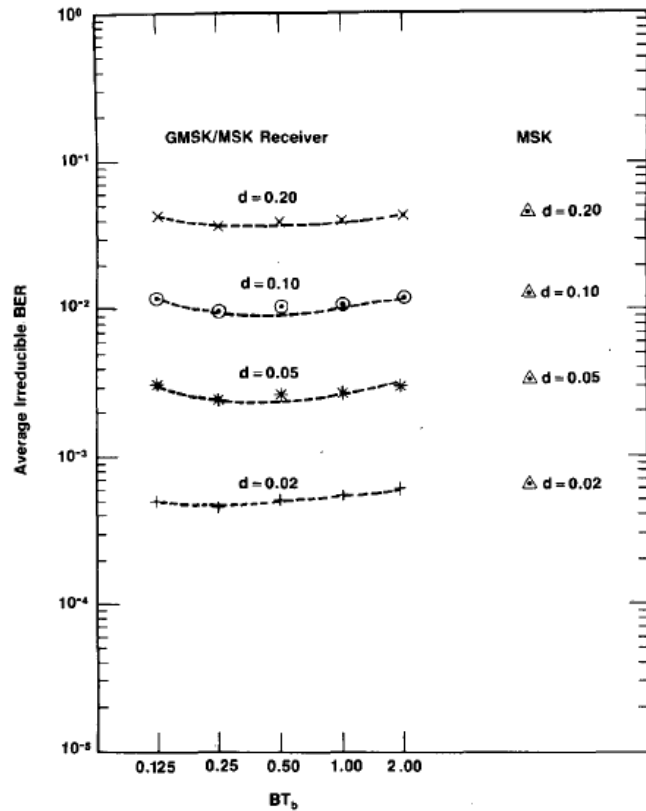

Fig. 14. The irreducible BER performance for GMSK with coherent detection for a channel with a delay profile as shown in Fig. 3. Results for the unfiltered MSK are also shown for comparison. The parameter BT_b is the 3-dB bandwidth of the premodulation Gaussian filter normalized by bit rate. The parameter d is the rms delay spread normalized by symbol period.

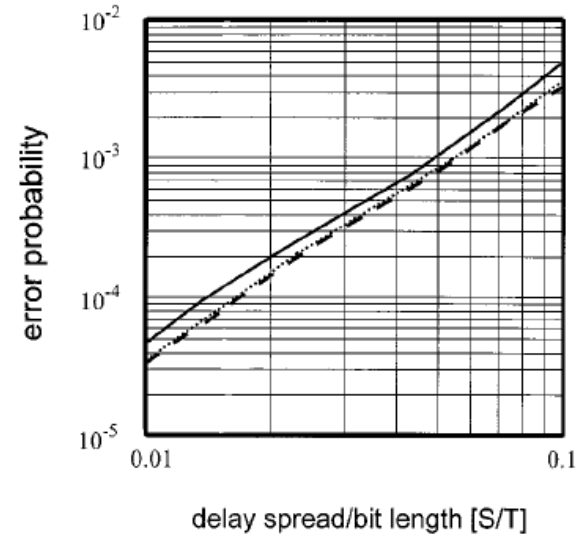

Fig. 11. Error probability for a two-delay power profile with the receiver filtering as a function of sampling time: MSK with no filtering: dashed, GMSK with $BT = 1.25 \cdot 2\pi$: dotted; GMSK with $BT = 0.625 \cdot 2\pi$: solid.

- The sensitivity of MSK modulation to multi-path propagation does not increase significantly with filtering. Results from [5] (left) and [6] (right).

Table 5-7 SPECTRAL EFFICIENCY OF DIGITAL SIGNALS

Type of Signal	Spectral Efficiency, $\eta = \frac{R}{B_T} \left(\frac{\text{bits/s}}{\text{Hz}} \right)$	
	Null-to-Null Bandwidth	30-dB Bandwidth
OOK and BPSK	0.500	0.052
QPSK, OQPSK, and $\pi/4$ QPSK	1.00	0.104
MSK	0.667	0.438
16 QAM	2.00	0.208
64 QAM	3.00	0.313

List of References

- [1] Leon W. Couch, *Digital and Analog Communication Systems*, 6th edition, pp. 364-367
- [2] Theodore S. Rappaport, *Wireless Communications*, 1st edition, pp. 240, 260-63
- [3] S. A. Gronemeyer and A. L. McBride, "MSK and Offset QPSK Modulation", *IEEE Transactions on Communications*, Vol. COM-24, No. 8, August 1976, pp. 809-820
- [4] D. H. Morais and K. Feher, "The effects o Filtering and Limiting on the Performance of QPSK, Offset QPSK and MSK Systems", *IEEE Transactions on Communications*, Vol. COM-28, No. 12, December 1980, pp. 1999-2009
- [5] J. C.-I. Chuang, "The Effects of Time Delay Spread on Portable Radio Communication Channels with Digital Modulation", *IEEE Journal on Selected Areas in Communications*, Vol. SAC-5, No. 5, June 1987, pp. 879-889
- [6] V. V. Lipovac, "On the Error Floor of MSK Signal Transmission over a Multipath Channel with Small Time Dispersion", *IEEE Transactions on Vehicular Technology*, Vol. 49, No. 1., January 2000, pp. 117-129