

Project: IEEE P802.15 Working Group for Wireless Personal Area Networks  
(WPANs)

Submission Title: [CoMPA PHY proposal]

Date Submitted: [May 7, 2007]

Source: [Hiroshi Harada (corresponding author), other authors are listed in “Contributors” slides]

Company [National institute of Information and Communications Institute (NICT), other authors are listed in “Contributors” slides ]

Address<sup>1</sup>[3-4 Hikari-no-oka, Yokosuka-shi, Kanagawa 239-0847, Japan]

Voice:[+81-46-847-5074]

FAX: [+81-46-847-5440]

E-Mail:[harada@nict.go.jp (other authors are listed in “Contributors” slides)]

Re: []

Abstract: [Proposal for IEEE 802.15 WPAN Millimeter Wave Alternative PHY]

Purpose: [To be considered in IEEE 802.15.3c standard]

Notice: This document has been prepared to assist the IEEE P802.15. It is offered as a basis for discussion and is not binding on the contributing individual(s) or organization(s). The material in this document is subject to change in form and content after further study. The contributor(s) reserve(s) the right to add, amend or withdraw material contained herein.

Release: The contributors acknowledge and accept that this contribution becomes the property of IEEE and may be made publicly available by P802.15.

# CoMPA PHY proposal

(CoMPA: Consortium of millimeter wave practical applications)

May 7, 2007

## Contributors (1/2)

Name	Affiliation	E-mail
Hiroshi Harada	NICT	harada@nict.go.jp
Yozo Shoji	NICT	shoji@nict.go.jp
Fumihide Kojima	NICT	f-kojima@nict.go.jp
Ryuhei Funada	NICT	funada@nict.go.jp
Ming Lei	NICT	minglei@nict.go.jp
Yoshinori Nishiguchi	NICT	nishiguchi@nict.go.jp
Ryota Kimura	NICT	r.kimura@nict.go.jp
Pyo Chang-Woo	NICT	cwpyo@nict.go.jp
Lan Zhou	NICT	lan@nict.go.jp
Masahiro Umehira	NICT	umehira@mx.ibaraki.ac.jp
Shuzo Kato	NICT	shu.kato@nict.go.jp
Akio Iso	NICT	Akio.Iso@nict.go.jp
Kenichi Kawasaki	Sony Corp.	Kenichi.Kawasaki@jp.sony.com
Makoto Noda	Sony Corp.	MakotoB.Noda@jp.sony.com
Hiroyuki Yamagishi	Sony Corp.	Hiroyuki.Yamagishi@jp.sony.com
Masashi Shinagawa	Sony Corp.	Masashi.Shinagawa@jp.sony.com
Keitarou Kondou	Sony Corp.	Keitarou.Kondou@jp.sony.com
Kazuaki Takahashi	Matsushita Electric Co., Ltd.	takahashi.kazu@jp.panasonic.com
Ismail Lakkis	Tensorcom, Inc.	ilakkis@tensorcom.com

## Contributors (2/2)

Name	Affiliation	E-mail
Ichihiko Toyoda	NTT Corp.	toyoda.ichihiko@lab.ntt.co.jp
Tomohiro Seki	NTT Corp.	seki.tomohiro@lab.ntt.co.jp
Hiroyuki Nakase	Tohoku University	nakase@riec.tohoku.ac.jp
Yasuyuki Ooishi	Fujitsu Limited.	yasu@labs.fujitsu.com
Kaoru Yokoo	Fujitsu Corp.	yokoo@labs.fujitsu.com
Yukimasa Nagai	Mitsubishi Electric Corp.	Nagai.Yukimasa@ds.MitsubishiElectric.co.jp
Takahisa Yamauchi	Mitsubishi Electric Corp.	Yamauchi.Takahisa@cw.MitsubishiElectric.co.jp
Hideto Ikeda	Oki Electric Industry Co., Ltd.	ikeda637@oki.com
Tadahiko Maeda	Oki Electric Industry Co., Ltd.	maeda097@oki.com
Masamune Takeda	Maspro Denkoh Corp.	takeda3026@maspro.co.jp
Hiroyoshi Konishi	Maspro Denkoh Corp.	konishi2761@maspro.co.jp
Shoichi Kitazawa	ATR	kitazawa@atr.jp
Kenichi Maruhashi	NEC Corp.	k-maruhashi@bl.jp.nec.com
Yoshitsugu Fujita	KYOCERA Corp.	yoshitugu.fujita.gt@kyocera.jp
Hiroshi Uchimura	KYOCERA Corp.	hiroshi.uchimura.hs@kyocera.com
Makoto Ando	Tokyo Institute of Technology	mando@antenna.ee.titech.ac.jp
Yoshio Aoki	Eudyna Devices Inc	y.aoki@eudyna.com
Kazufumi Igarashi	Japan Radio Co., Ltd.	igarashi.kazufumi@jrc.co.jp
Tsukasa Yoneyama	EMMEX, INC.	yoneyama@tohtech.ac.jp
Yukihiro Shimakata	TAIYO YUDEN Co., LTD.	y-shima@jty.yuden.co.jp
Shoji Kuriki	RICOH COMPANY, LTD.	shoji.kuriki@nts.ricoh.co.jp
Toyoo Tanaka	Toyo System Engineering Co., Ltd.	toyoo_tanaka@u-tse.co.jp

## Goal of CoMPA PHY

- Promote millimeter-wave systems commercialization and the standard which supports various applications and can be deployed immediately
- Promote a simple air-interface with low power-consumption for portable devices
- Promote a flexible standard to support multiple PHYs, each suitable for various applications

# Contents

1. [Channelization](#)
2. [Modulation & coding](#)
3. [PHY Frame format](#)
  - [Preamble format](#)
  - [Basic configuration to generate FEC encoded PLCP header](#)
4. [MAC Protocol](#)
5. [Common mode](#)
6. [Items to be reported for PHY](#)
  - [6.1: Mean 90% PER and BER link success probability versus  \$E\_p/N\_0\$  for each data rate mode](#)
  - [6.2: Mean 90% PER and BER link success distance for each data rate mode](#)
  - [6.3: Miss detection and false alarm performance of the synchronization versus SNR](#)
  - [6.4: Packet structure parameters](#)
7. [Items to be reported for MAC](#)
  - [7.1: Throughput analysis for the UM1 scenario, including Character Error Rate \(CER\) analysis](#)
  - [7.2: Throughput analysis for the UM5 scenario](#)
  - [7.3: The ARQ method and packet aggregation parameters](#)
  - [7.4: Assumed durations of Inter-frame spaces](#)
  - [7.5: PHY mode assumed](#)
  - [7.6: Frame size](#)
  - [7.7: CAP duration](#)
  - [7.8: Preamble types used \(if different\)](#)
  - [7.9: Super frame size and guard interval duration](#)
8. [Other items to be reported for “System requirements” and “Selection criteria” documents](#)
9. [Summary of CoMPA PHY proposal](#)

# Summary of CoMPA PHY proposal

- **Channelization**
  - 2080MHz bandwidth/ch, 4ch/9GHz bandwidth
- **Mandatory Features: 2Gbps@PHY-SAP**
  - Single Carrier (SC) modulation (QPSK) with Reed Solomon (RS) coding (with frequency domain equalizer (FDE) for NLOS environments)
- **Optional Features: 3Gbps@PHY-SAP**
  - SC modulation (8PSK or TC8PSK) with RS coding or LDPC (with FDE for NLOS environments)
- **Three transmission modes are supported**
  - High rate transmission mode (HRT)
  - Medium rate transmission mode (MRT)
  - Low rate transmission mode (LRT)
- **Flexible standard to support multiple PHY**
  - Support co-existence of multiple PHYs and interference avoidance among the PHY networks with different channel plans
- **CoMPA PHY proposal meets all system requirements**

# Overview of CoMPA PHY architecture

## - High rate transmission mode (HRT) -

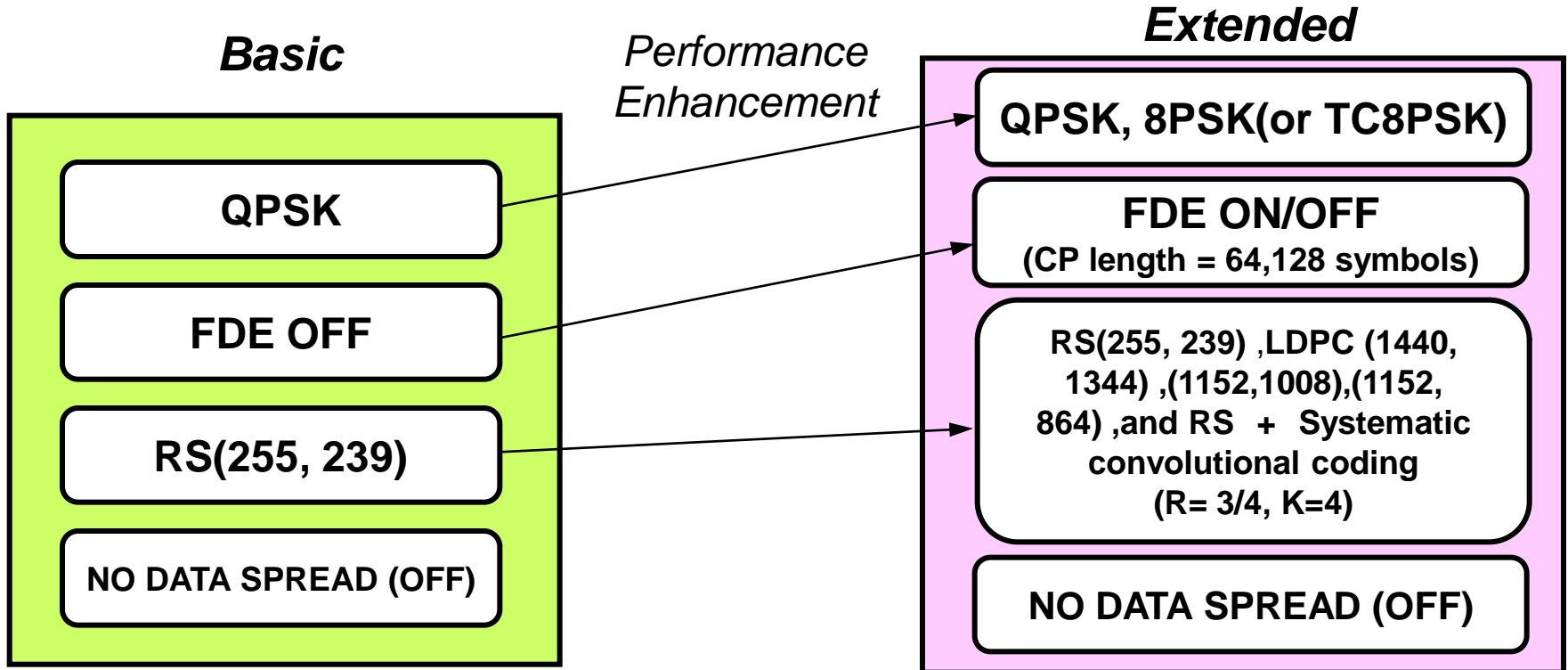

FDE: Frequency domain equalizer

Support over 2 Gbps PHY-SAP payload bit rate

Support over 2 Gbps PHY-SAP payload bit rate up to 4.679 Gbps and robustness against NLOS environment

[to "Contents"](#)

CP: Cyclic Prefix



# Overview of CoMPA PHY architecture

## - Medium rate transmission mode (MRT) -

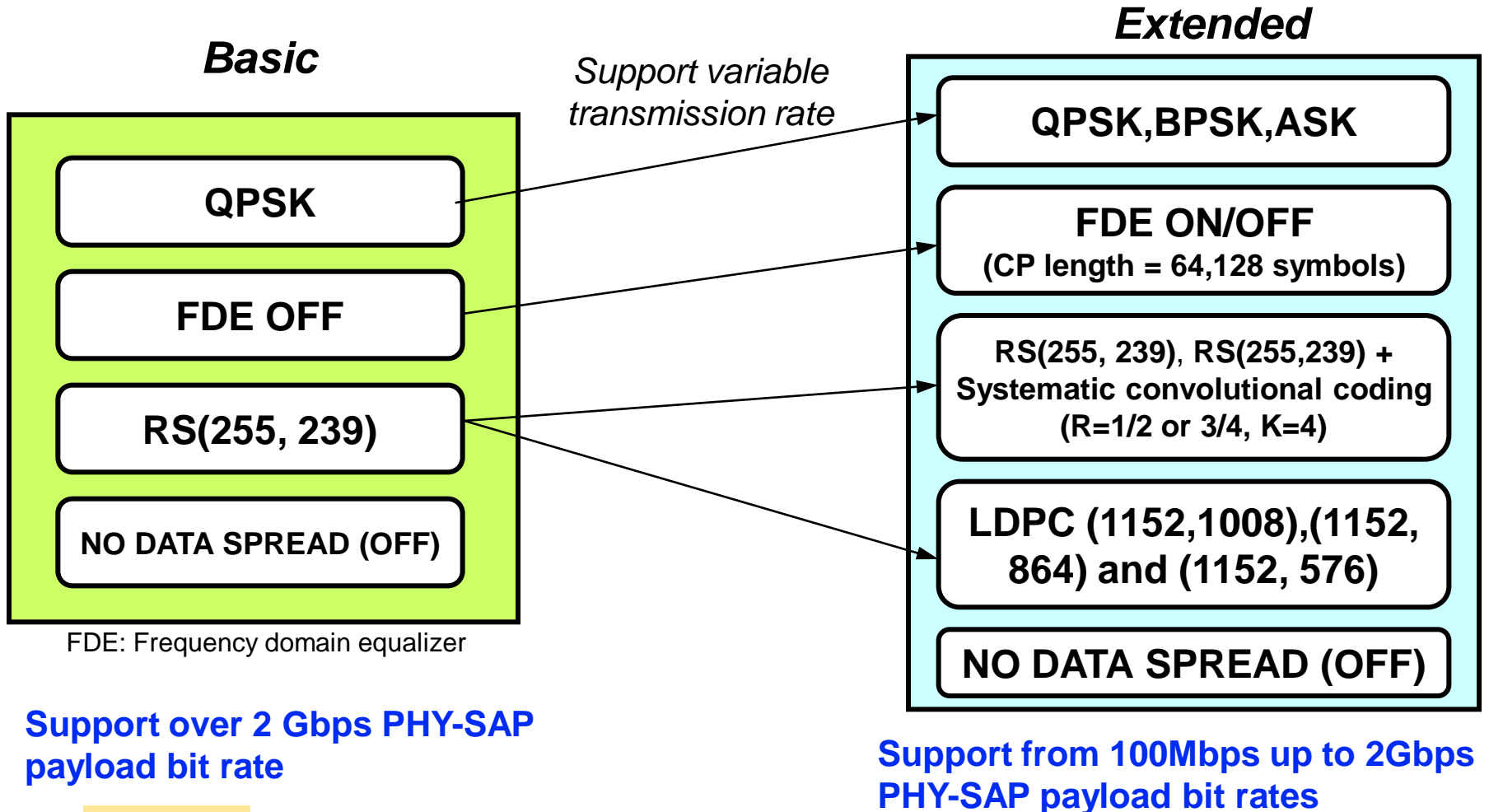

FDE: Frequency domain equalizer

[to "Contents"](#)

# Overview of CoMPA PHY architecture

## - Low rate transmission mode (LRT) -

**Basic**

*Terminal simplification  
and longer transmission range*

**Extended**

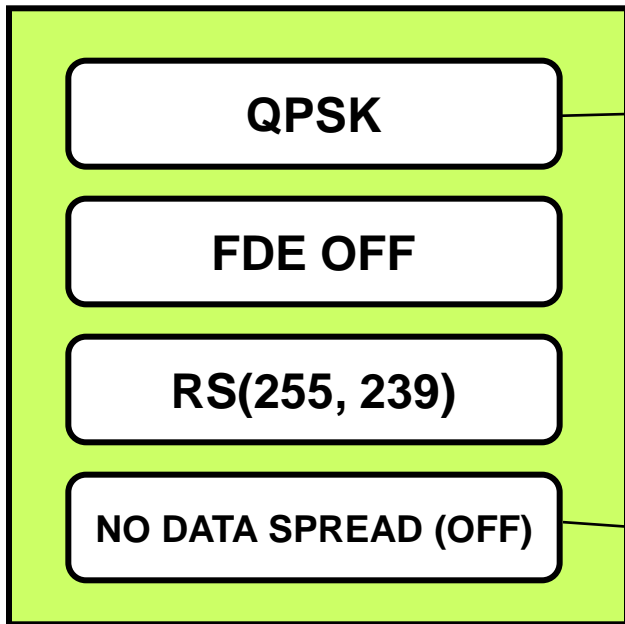

FDE: Frequency domain equalizer

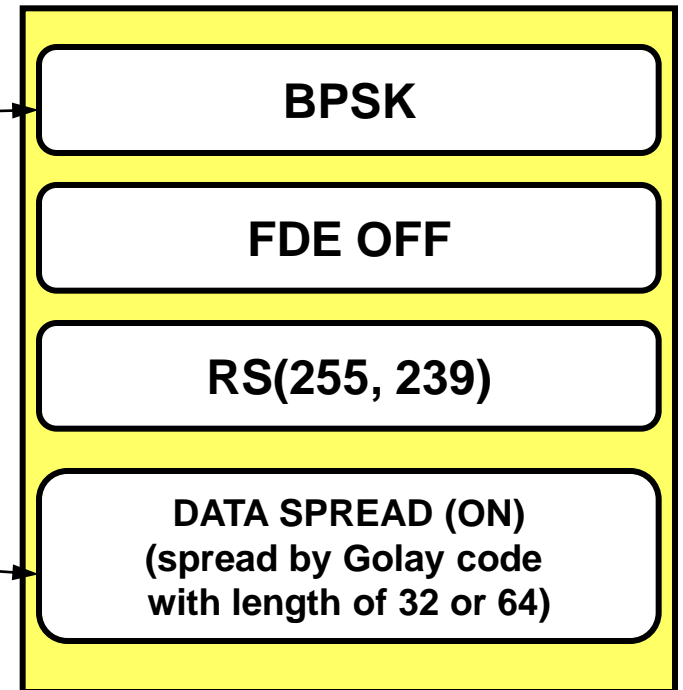

**Support over 2 Gbps PHY-SAP  
payload bit rate**

**Support less than 100 Mbps PHY-SAP  
payload bit rates and extended  
transmission range**

[to "Contents"](#)

# 1. Channelization

# Channelization

Channel Number	Low Freq. (GHz)	Center Freq. (GHz)	High Freq. (GHz)	Nyquist BW (MHz)	Roll-Off Factor
1	57.200	58.240	59.280	1664	0.25
2	59.280	60.320	61.360	1664	0.25
3	61.360	62.400	63.440	1664	0.25
4	63.440	64.480	65.520	1664	0.25

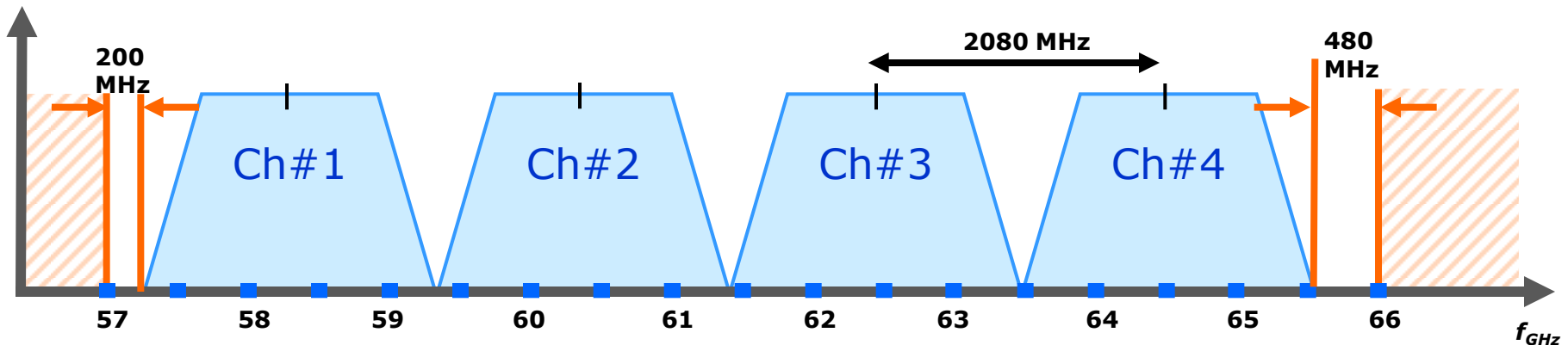

- Balance upper and lower guard bands
- Support cell phone XTAL: 26 MHz
- Support higher frequency XTALs: 40 , 43.333, & 65 MHz
- Dual PLL
  - High frequency PLL that generates carrier frequencies
  - Low frequency PLL that generates the ADC/DAC & ASIC frequencies

[to "Contents"](#)

## 2. Modulation & coding

# Summary of modulation and coding

## Basic Features :

- SC-PHY with QPSK and RS(255, 239) code for mandatory data-rate mode to support UM1 and UM5 scenarios with minimum hardware complexity

## Extended Features:

- 8PSK modulation with RS(255,239) or LDPC(1440, 1344) coding mode is available to achieve over 3 Gbps PHY-SAP payload bit rates
- FDE with 64 or 128 CP length is available to keep robustness against NLOS environments
- Other two modes
  - Medium rate transmission (MRT) mode
    - Additional modulation scheme: BPSK,ASK
    - Additional coding scheme:
      - ✓ Concatenation modes of systematic convolutional coding ( $R=1/2$  or  $3/4$ ,  $K=4$ ) and RS(255, 239)
      - ✓ LDPC(1152, 1008), (1152, 864) and (1152, 576)
  - Low rate transmission (LRT) mode
    - Based on BPSK with RS (255,239)
    - Spreading of data payload by Golay code

# CoMPA PHY major parameters

Parameters	Specification
Channel separation	2080 MHz
Basic transmission scheme	Single Carrier (SC) transmission
Multiple access scheme	TDMA/CSMA
Symbol rate (Nyquist bandwidth)	1664 MHz
Root raised cosine filter	Roll-off factor =0.25
Modulation	Basic: QPSK (Gray-coded mapping) Extended: 8PSK (or TC8PSK), BPSK (Gray-coded mapping), ASK
Channel coding scheme	Basic: RS(255,239) over GF(2 <sup>8</sup> ) Extended: -LDPC(1440, 1344), (1152,1008), (1152, 864) and (1152,576) -RS(255,239) + Systematic convolutional coding (R=1/2 or 3/4, K=4)
CP (Cyclic prefix) length	Basic: 0 symbol, Extended: 64, 128 symbols
Number of symbols per block for FDE	512

[to "Contents"](#)

# List of available data-rate mode

- High rate transmission (HRT) and Medium rate transmission (MRT) mode -

Mode	Modulation	FEC scheme	PHY-SAP payload bit rate [Gbps]		
			CP length = 0	CP length = 64	CP length = 128
1.1	BPSK	RS(255,239)	1.560	1.386	1.248
1.2.1		LDPC (1152, 864)	1.248	1.1093	0.9984
1.2.2		LDPC (1152, 576)	0.832	0.740	0.666
1.3		Outer: RS(255,239) Inner: Systematic Convolutional (R=3/4, K=4)	1.170	1.040	0.936
1.4		Outer: RS(255,239) Inner: Systematic Convolutional (R=1/2, K=4)	0.780	0.693	0.624
2.1	QPSK	RS(255,239)	3.119	2.773	2.495
2.2.1		LDPC (1440, 1344)(*LDPC(1152,1008))	3.106(*2.912)	2.761(*2.588)	2.485(*2.330)
2.2.2		LDPC (1152, 864)	2.496	2.219	1.997
2.2.3		LDPC (1152, 576)	1.664	1.479	1.331
2.3		Outer: RS(255,239) Inner: Systematic Convolutional (R=3/4, K=4)	2.339	2.080	1.872
2.4		Outer: RS(255,239) Inner: Systematic Convolutional (R=1/2, K=4)	1.560	1.386	1.248
3.1	8 PSK	RS(255,239)	4.679	4.159	3.743
3.2		LDPC (1440, 1344)	4.659	4.142	3.727

 HRT

[to "Contents"](#)



## List of available data-rate mode

### - Low rate transmission (LRT) mode -

- Low data-rate mode is available to increase scalability in data-rate and transmission range
- Low data-rate mode frame is spread by Golay code of length 64 or 32

Mode	Modulation	FEC scheme	PHY-SAP payload bit rate [Gbps]
4.1	BPSK	RS(255,239) spread by Golay code of length 64	0.0487
4.2		RS(255,239) spread by Golay code of length 32	0.0975

# Mandatory usage models and PHY candidate

Items	UM1				UM5			
Required MAC-SAP	1.78		3.65		1.5		2.25	
Channel model	1.3	2.3	1.3	2.3	3.1	9.1	3.1	9.1
Target BER and PER	BER = $10^{-6}$				PER=0.08			
Transmission mode	Mode2.1		Mode3.1		Mode2.1			
Modulation	QPSK		8PSK		QPSK			
Channel coding	RS(255,239)							
CP length used with FFT 512	0	128	0	128	128	0	128	0
PHY-SAP payload bit rate	3.119	2.495	4.679	3.743	2.495	3.119	2.495	3.119

[to "Contents"](#)

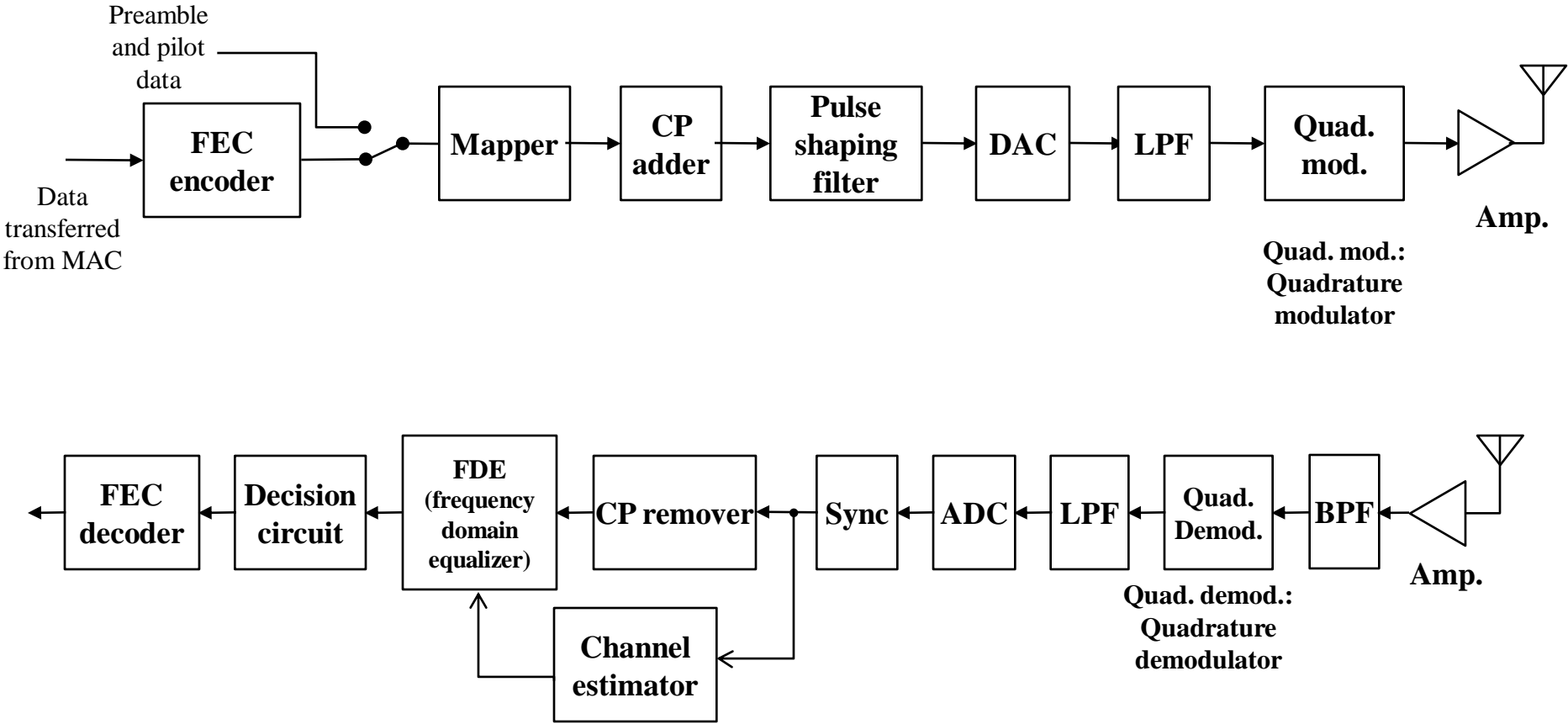

[to "Contents"](#)

# Architecture of RS (255,239) encoder

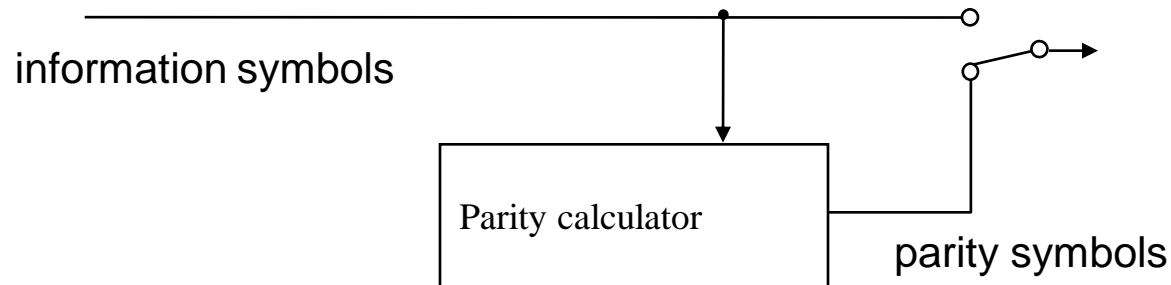

Generator polynomial of the RS code is defined as,

$$g(x) = \prod_{i=0}^{15} (x - \alpha^i),$$

where  $\alpha$  is a root of the primitive polynomial,

$$p(x) = x^8 + x^4 + x^3 + x^2 + 1.$$

# Architecture of LDPC(1440, 1344) encoder

The systematic quasi-cyclic (1440, 1344) LDPC code can be generated by using 15 generator polynomials and a  $(96+15-1=)$  110-stage shift register.

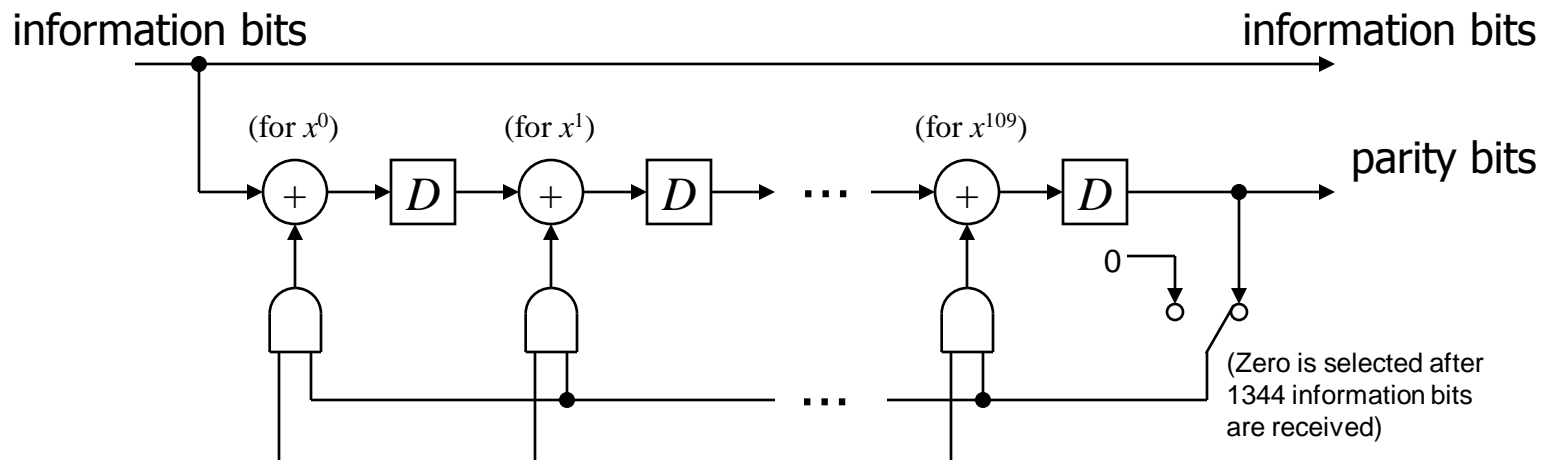

Select  $g_{(1439 - k) \bmod 15} \cdot x^{14 - \{(1439 - k) \bmod 15\}}$  at time  $k$ , where  $k = 0$  is defined as the time that the first 110 information bits are stored in the 110 shift registers.

15 generator polynomials in hexadecimal with the maximum order of 110<sup>th</sup>

$g_0 = 0001A601408BE139000868098208$	$g_1 = 0002A321608AE1983929C60E2005$
$g_2 = 00042004040241D94233A609098D$	$g_3 = 000830445C08119A1013279C00F6$
$g_4 = 0010504120009C10602A07D404E4$	$g_5 = 002022013082889D22C32038C121$
$g_6 = 00400120780460145B1260867190$	$g_7 = 0080DA04708A3195232130D24420$
$g_8 = 0100096054C2491188304054E0B0$	$g_9 = 02009C0560C29891A52BA8C68341$
$g_{10} = 0400B940244A3099EB59071AE174$	$g_{11} = 080010457C0091842039078401D4$
$g_{12} = 10008C0504CC8104C31C8E528394$	$g_{13} = 2000B3601088790C193A459EA1F5$
$g_{14} = 4000A4050082A811421208104311$	

[to "Contents"](#)

# Architecture of concatenation of RS(255, 239) and systematic convolutional (R=1/2,3/4, K=4) encoder

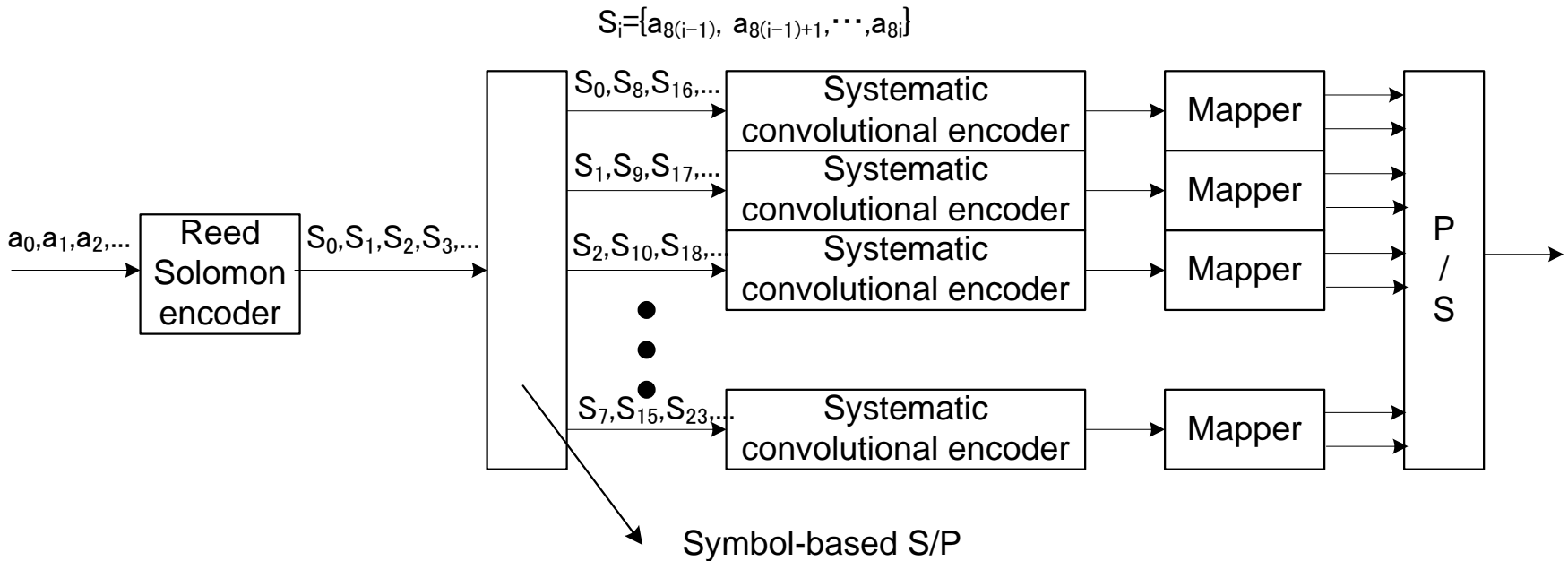

# Architecture of systematic convolutional encoder ( $R=1/2$ or $3/4$ , $K=4$ )

- Generator polynomials:  $g_0 = 17_{\text{oct}}$  and  $g_1 = 15_{\text{oct}}$

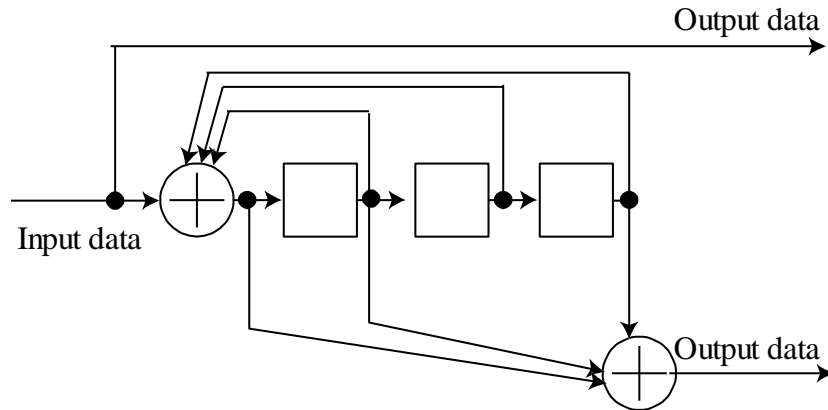

- Puncturing to generate coding rate  $R=3/4$

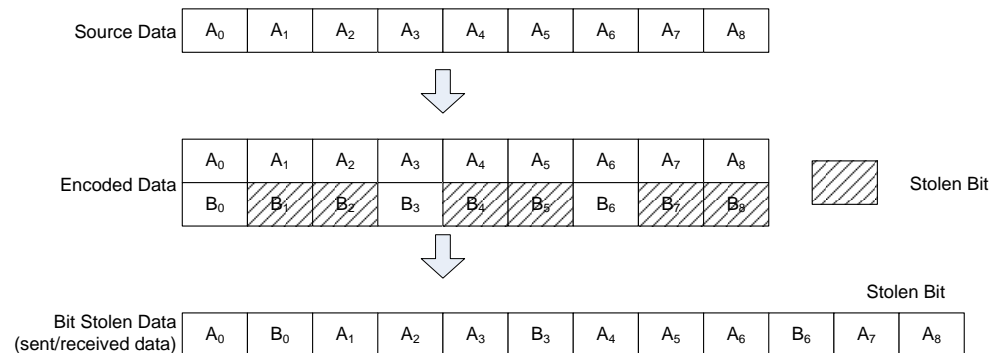

## 3. PHY frame format



# Summary of frame format

- Two types of beacon
  - Beacon for HRT (High Rate Transmission) and MRT (Medium Rate Transmission) mode
    - Only preamble is spread by Golay code of length 128 bits
  - Beacon for LRT (Low Rate Transmission) mode: Longer transmission range
    - Preamble is spread by Golay code of length 128
    - Header and payload are spread by Golay code of length 64
- Start frame delimiter (SFD) is included in the preamble
  - Used for common mode identification
  - Consist of information data spread by Golay code
- A new cyclic-redundancy-check code of  $1A12B_{\text{hex}}$  for Header Check Sequence (HCS) is proposed

# PHY frame formatting

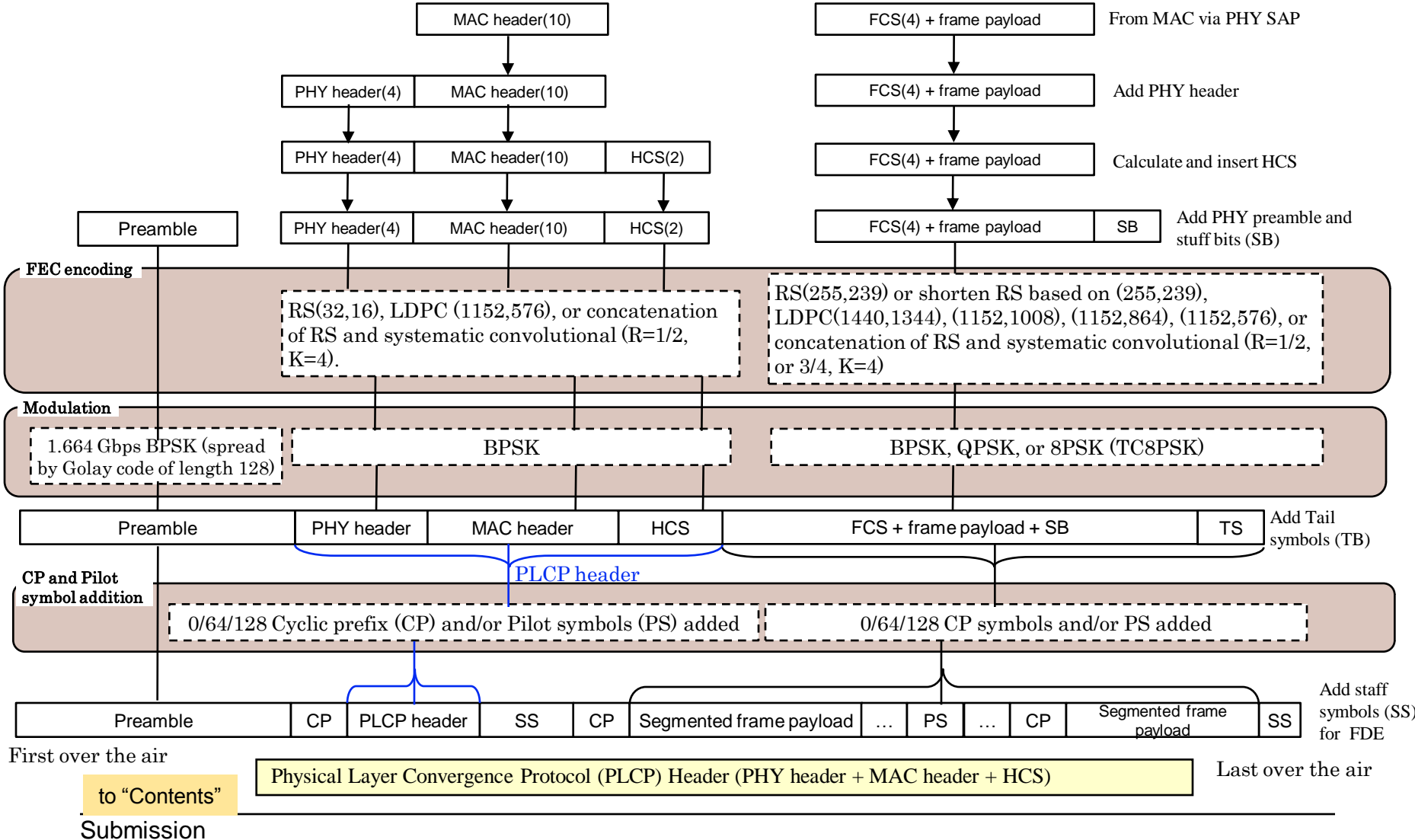

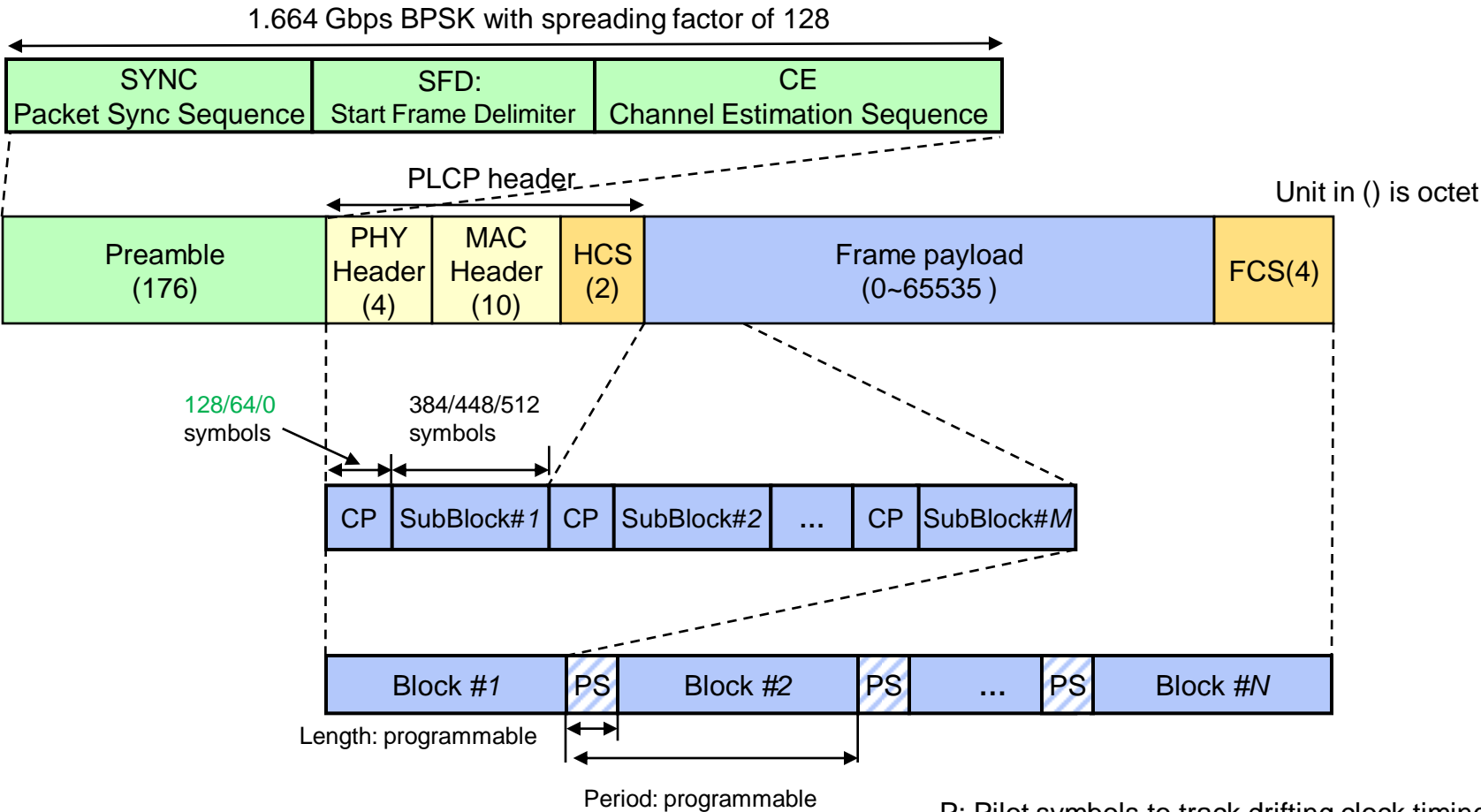

[to "Contents"](#)

# Preamble format

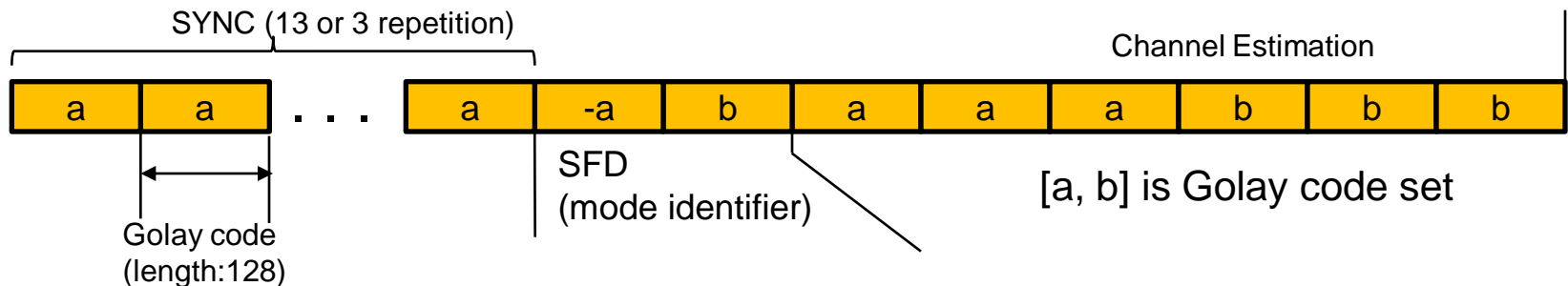

mode	Symbol rate [Gbps]	SYNC	SFD	CE	Total length	
		Length of Sequence $L_{sfd}$ [symbols]	Length of Sequence $L_{sfd}$ [symbols]	Length of Sequence $L_{sfd}$ [symbols]	symbols	nsec
HRT/MRT mode	1.664	3	2	6	1408	846.2
LRT mode	1.664	13	2	6	2688	1615.4

- Golay code of length 128 is used in every data-rate transmission frame
- For low-rate packet mode, PLCP header and payload are spread by Golay code of length 64 or 32
  - 48.7 Mbps data rate and 18 dB processing gain with code length of 64 bits
  - 97.5 Mbps data rate and 15 dB processing gain with code length of 32 bits

[to "Contents"](#)

## Preamble format example

SFD field is used to notify the PHY mode in Beacon frame as well as to set the start point of frame

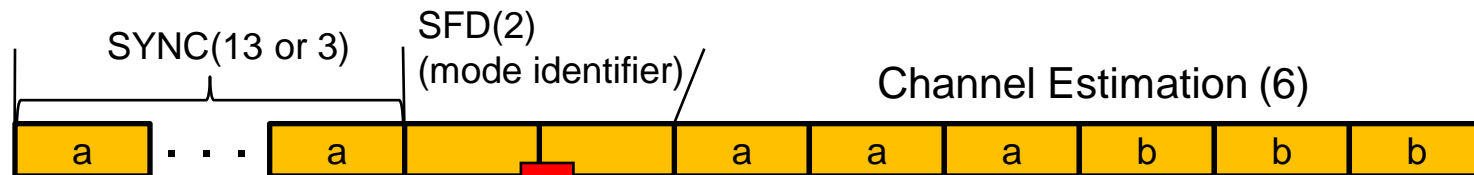

[a, b] is Golay code set

-a	a	SFD #1: High-rate, SC-PHY, RS only
-a	-a	SFD #2: Low-rate, SC-PHY, RS only
-a	b	SFD #3: High-rate, SC-PHY, RS+Convolutional
-a	-b	SFD #4: Low-rate, SC-PHY, RS+Convolutional
b	a	SFD #5: High-rate, SC-PHY, LDPC
b	-a	SFD #6: Low-rate, SC-PHY, LDPC
b	b	SFD #7: Reserved
b	-b	SFD #8: Reserved
-b	a	SFD #9: Reserved
-b	-a	SFD #10: Reserved
-b	b	SFD #11: Reserved
-b	-b	SFD #12: Reserved

[to "Contents"](#)

# Features of Golay codes

- Golay codes consist of a pair of binary sequences  $\mathbf{a}$  and  $\mathbf{b}$  with length of  $2^N$  chips, where  $N$  is a positive integer
- Autocorrelation of  $\mathbf{a}$  and that of  $\mathbf{b}$  can be calculated by a very simple matched filter with  $N$  delay elements,  $N$  inverters and  $2N$  adders
- Sum of the autocorrelations results in unique main peak without side-lobe
- Golay codes can carry 2-bit (4-state) information by using  $+\mathbf{a}$ ,  $-\mathbf{a}$ ,  $+\mathbf{b}$  and  $-\mathbf{b}$

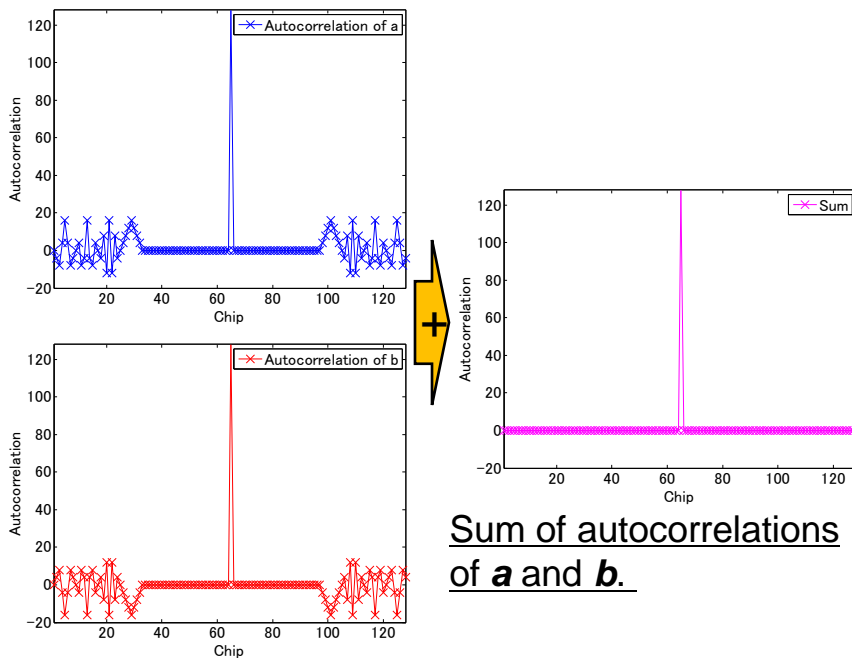

Sum of autocorrelations of  $\mathbf{a}$  and  $\mathbf{b}$ .

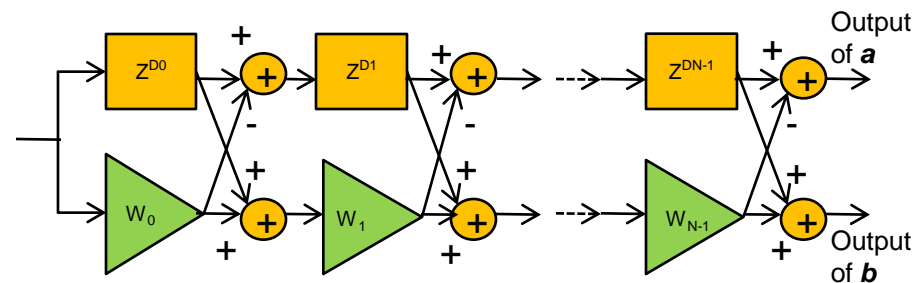

Configuration of matched filter for Golay codes.

128 length Golay code:

$$- D = [64 \ 32 \ 8 \ 2 \ 16 \ 1 \ 4]$$

$$- W = [1 \ 1 \ 1 \ 1 \ 1 \ 1 \ 1]$$

[to "Contents"](#)

# Golay code of length 128

**a**

**b**

$a_0 a_1 a_2 a_3 a_4 a_5 a_6 a_7 \dots a_{124} a_{125} a_{126} a_{127}$

$b_0 b_1 b_2 b_3 b_4 b_5 b_6 b_7 \dots b_{124} b_{125} b_{126} b_{127}$

Element of Golay code <i>a</i>	Value	Element of Golay code <i>a</i>	Value	Element of Golay code <i>a</i>	Value	Element of Golay code <i>a</i>	Value
a <sub>0</sub>	1	a <sub>32</sub>	1	a <sub>64</sub>	1	a <sub>96</sub>	-1
a <sub>1</sub>	1	a <sub>33</sub>	1	a <sub>65</sub>	1	a <sub>97</sub>	-1
a <sub>2</sub>	1	a <sub>34</sub>	1	a <sub>66</sub>	1	a <sub>98</sub>	-1
a <sub>3</sub>	1	a <sub>35</sub>	1	a <sub>67</sub>	1	a <sub>99</sub>	-1
a <sub>4</sub>	1	a <sub>36</sub>	1	a <sub>68</sub>	1	a <sub>100</sub>	-1
a <sub>5</sub>	-1	a <sub>37</sub>	-1	a <sub>69</sub>	-1	a <sub>101</sub>	1
a <sub>6</sub>	1	a <sub>38</sub>	1	a <sub>70</sub>	1	a <sub>102</sub>	-1
a <sub>7</sub>	-1	a <sub>39</sub>	-1	a <sub>71</sub>	-1	a <sub>103</sub>	1
a <sub>8</sub>	1	a <sub>40</sub>	-1	a <sub>72</sub>	1	a <sub>104</sub>	1
a <sub>9</sub>	1	a <sub>41</sub>	-1	a <sub>73</sub>	1	a <sub>105</sub>	1
a <sub>10</sub>	-1	a <sub>42</sub>	1	a <sub>74</sub>	-1	a <sub>106</sub>	-1
a <sub>11</sub>	-1	a <sub>43</sub>	1	a <sub>75</sub>	-1	a <sub>107</sub>	-1
a <sub>12</sub>	1	a <sub>44</sub>	-1	a <sub>76</sub>	1	a <sub>108</sub>	1
a <sub>13</sub>	-1	a <sub>45</sub>	1	a <sub>77</sub>	-1	a <sub>109</sub>	-1
a <sub>14</sub>	-1	a <sub>46</sub>	1	a <sub>78</sub>	-1	a <sub>110</sub>	-1
a <sub>15</sub>	1	a <sub>47</sub>	-1	a <sub>79</sub>	1	a <sub>111</sub>	1
a <sub>16</sub>	1	a <sub>48</sub>	1	a <sub>80</sub>	1	a <sub>112</sub>	-1
a <sub>17</sub>	-1	a <sub>49</sub>	-1	a <sub>81</sub>	-1	a <sub>113</sub>	1
a <sub>18</sub>	-1	a <sub>50</sub>	-1	a <sub>82</sub>	-1	a <sub>114</sub>	1
a <sub>19</sub>	1	a <sub>51</sub>	1	a <sub>83</sub>	1	a <sub>115</sub>	-1
a <sub>20</sub>	1	a <sub>52</sub>	1	a <sub>84</sub>	1	a <sub>116</sub>	-1
a <sub>21</sub>	1	a <sub>53</sub>	1	a <sub>85</sub>	1	a <sub>117</sub>	-1
a <sub>22</sub>	-1	a <sub>54</sub>	-1	a <sub>86</sub>	-1	a <sub>118</sub>	1
a <sub>23</sub>	-1	a <sub>55</sub>	-1	a <sub>87</sub>	-1	a <sub>119</sub>	1
a <sub>24</sub>	1	a <sub>56</sub>	-1	a <sub>88</sub>	1	a <sub>120</sub>	1
a <sub>25</sub>	-1	a <sub>57</sub>	1	a <sub>89</sub>	-1	a <sub>121</sub>	-1
a <sub>26</sub>	1	a <sub>58</sub>	-1	a <sub>90</sub>	1	a <sub>122</sub>	1
a <sub>27</sub>	-1	a <sub>59</sub>	1	a <sub>91</sub>	-1	a <sub>123</sub>	-1
a <sub>28</sub>	1	a <sub>60</sub>	-1	a <sub>92</sub>	1	a <sub>124</sub>	1
a <sub>29</sub>	1	a <sub>61</sub>	-1	a <sub>93</sub>	1	a <sub>125</sub>	1
a <sub>30</sub>	1	a <sub>62</sub>	-1	a <sub>94</sub>	1	a <sub>126</sub>	1
a <sub>31</sub>	1	a <sub>63</sub>	-1	a <sub>95</sub>	1	a <sub>127</sub>	1

Element of Golay code <i>b</i>	Value	Element of Golay code <i>b</i>	Value	Element of Golay code <i>b</i>	Value	Element of Golay code <i>b</i>	Value
b <sub>0</sub>	1	b <sub>32</sub>	1	b <sub>64</sub>	1	b <sub>96</sub>	-1
b <sub>1</sub>	1	b <sub>33</sub>	1	b <sub>65</sub>	1	b <sub>97</sub>	-1
b <sub>2</sub>	1	b <sub>34</sub>	1	b <sub>66</sub>	1	b <sub>98</sub>	-1
b <sub>3</sub>	1	b <sub>35</sub>	1	b <sub>67</sub>	1	b <sub>99</sub>	-1
b <sub>4</sub>	-1	b <sub>36</sub>	-1	b <sub>68</sub>	-1	b <sub>100</sub>	1
b <sub>5</sub>	1	b <sub>37</sub>	1	b <sub>69</sub>	1	b <sub>101</sub>	-1
b <sub>6</sub>	-1	b <sub>38</sub>	-1	b <sub>70</sub>	-1	b <sub>102</sub>	1
b <sub>7</sub>	1	b <sub>39</sub>	1	b <sub>71</sub>	1	b <sub>103</sub>	-1
b <sub>8</sub>	1	b <sub>40</sub>	-1	b <sub>72</sub>	1	b <sub>104</sub>	1
b <sub>9</sub>	1	b <sub>41</sub>	-1	b <sub>73</sub>	1	b <sub>105</sub>	1
b <sub>10</sub>	-1	b <sub>42</sub>	1	b <sub>74</sub>	-1	b <sub>106</sub>	-1
b <sub>11</sub>	-1	b <sub>43</sub>	1	b <sub>75</sub>	-1	b <sub>107</sub>	-1
b <sub>12</sub>	-1	b <sub>44</sub>	1	b <sub>76</sub>	-1	b <sub>108</sub>	-1
b <sub>13</sub>	1	b <sub>45</sub>	-1	b <sub>77</sub>	1	b <sub>109</sub>	1
b <sub>14</sub>	1	b <sub>46</sub>	-1	b <sub>78</sub>	1	b <sub>110</sub>	1
b <sub>15</sub>	-1	b <sub>47</sub>	1	b <sub>79</sub>	-1	b <sub>111</sub>	-1
b <sub>16</sub>	1	b <sub>48</sub>	1	b <sub>80</sub>	1	b <sub>112</sub>	-1
b <sub>17</sub>	-1	b <sub>49</sub>	-1	b <sub>81</sub>	-1	b <sub>113</sub>	1
b <sub>18</sub>	-1	b <sub>50</sub>	-1	b <sub>82</sub>	-1	b <sub>114</sub>	1
b <sub>19</sub>	1	b <sub>51</sub>	1	b <sub>83</sub>	1	b <sub>115</sub>	-1
b <sub>20</sub>	-1	b <sub>52</sub>	-1	b <sub>84</sub>	-1	b <sub>116</sub>	1
b <sub>21</sub>	-1	b <sub>53</sub>	-1	b <sub>85</sub>	-1	b <sub>117</sub>	1
b <sub>22</sub>	1	b <sub>54</sub>	1	b <sub>86</sub>	1	b <sub>118</sub>	-1
b <sub>23</sub>	1	b <sub>55</sub>	1	b <sub>87</sub>	1	b <sub>119</sub>	-1
b <sub>24</sub>	1	b <sub>56</sub>	-1	b <sub>88</sub>	1	b <sub>120</sub>	1
b <sub>25</sub>	-1	b <sub>57</sub>	1	b <sub>89</sub>	-1	b <sub>121</sub>	-1
b <sub>26</sub>	1	b <sub>58</sub>	-1	b <sub>90</sub>	1	b <sub>122</sub>	1
b <sub>27</sub>	-1	b <sub>59</sub>	1	b <sub>91</sub>	-1	b <sub>123</sub>	-1
b <sub>28</sub>	-1	b <sub>60</sub>	1	b <sub>92</sub>	-1	b <sub>124</sub>	-1
b <sub>29</sub>	-1	b <sub>61</sub>	1	b <sub>93</sub>	-1	b <sub>125</sub>	-1
b <sub>30</sub>	-1	b <sub>62</sub>	1	b <sub>94</sub>	-1	b <sub>126</sub>	-1
b <sub>31</sub>	-1	b <sub>63</sub>	1	b <sub>95</sub>	-1	b <sub>127</sub>	-1

[to "Contents"](#)

**PHY Header**

0~65535 byte

R	RATE (5 bits)	LENGTH (16 bits)	CP LEN	SCR 2b	R	BURST MODE
R	R1...R5 3:7	LSB to MSB 8:23	CL	S1:S2 26:27	R	BM
0:2			24:25	28:30		31

BM	Next Packet Status
1	Next packet is not part of burst
0	Next packet is part of burst

CL	Next Packet CP length
00	0
01	TBD
10	64
11	128

Data Rate Mode	R1-R5
1.1	00000
1.2.1	00001
1.2.2	00010
1.3	00011
1.4	00100
2.1	00101
2.2.1	00110
2.2.2	00111
2.2.3	01000
2.3	01001
2.4	01010
3.1	01011
3.2	01100
4.1	01101
4.2	01110

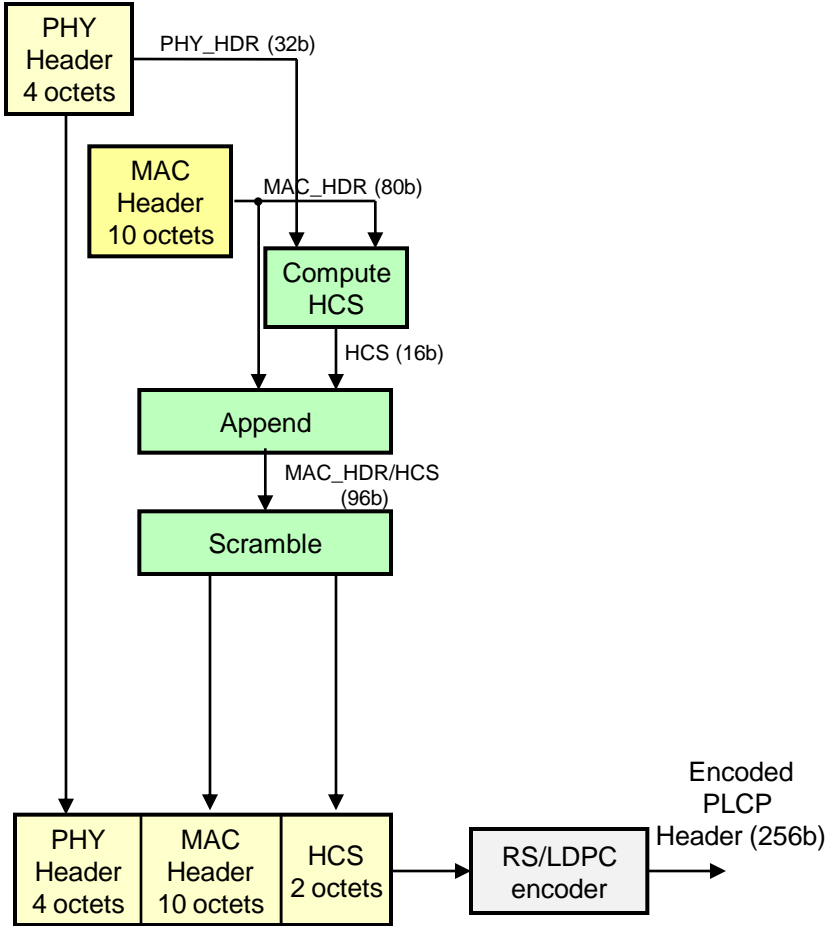

[to "Contents"](#)



# Basic configuration to generate FEC encoded PLCP header for concatenation of RS and systematic convolutional coding encoded payload

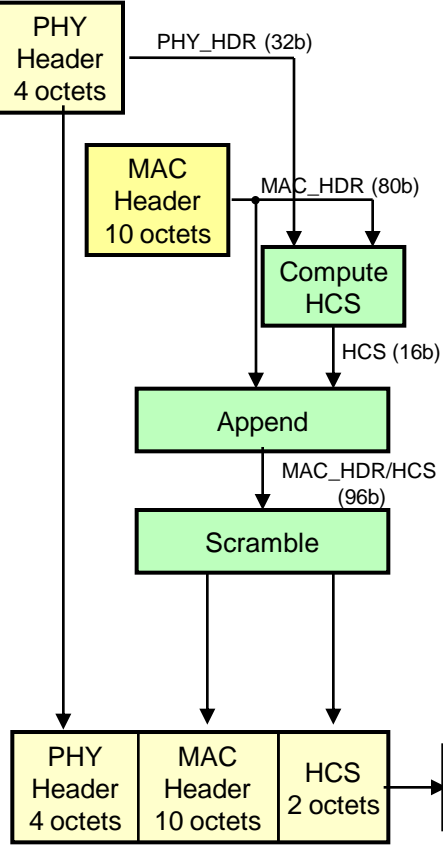

PHY Header 0~65535 byte

R	RATE (5 bits)	LENGTH (16 bits)	CP LEN	SCR 2b	R	BURST MODE
E					E	
S					S	
R	R1...R5 3:7	LSB to MSB 8:23	CL 24:25	S1:S2 26:27	R 28:30	BM 31
0:2						

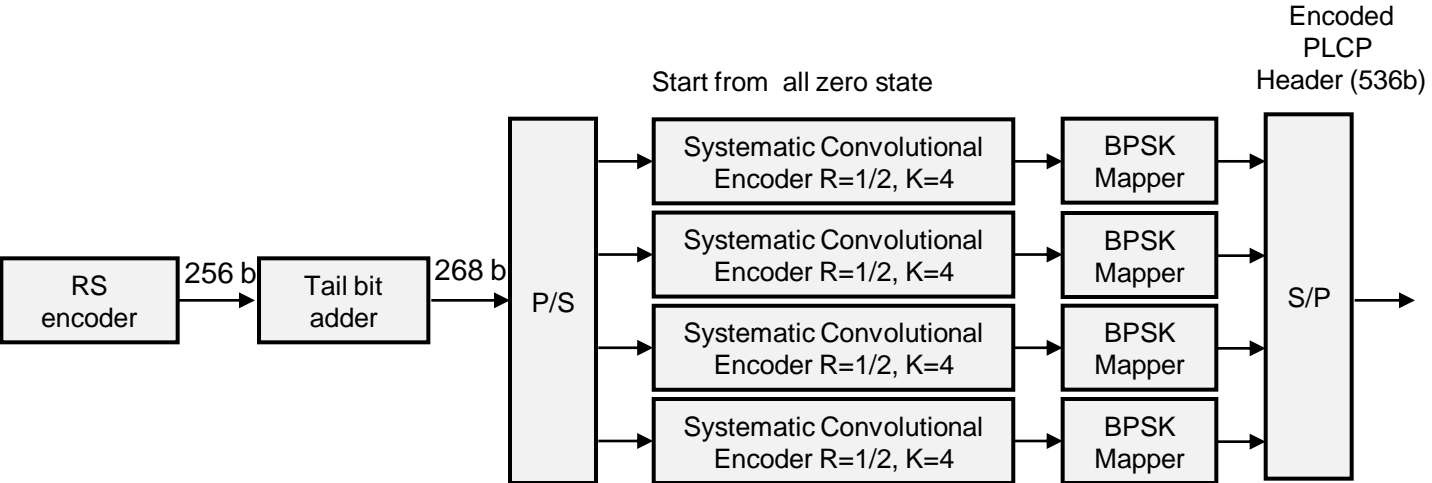

[to "Contents"](#)

# A Cyclic-redundancy-check code (1A12B) proposed for HCS

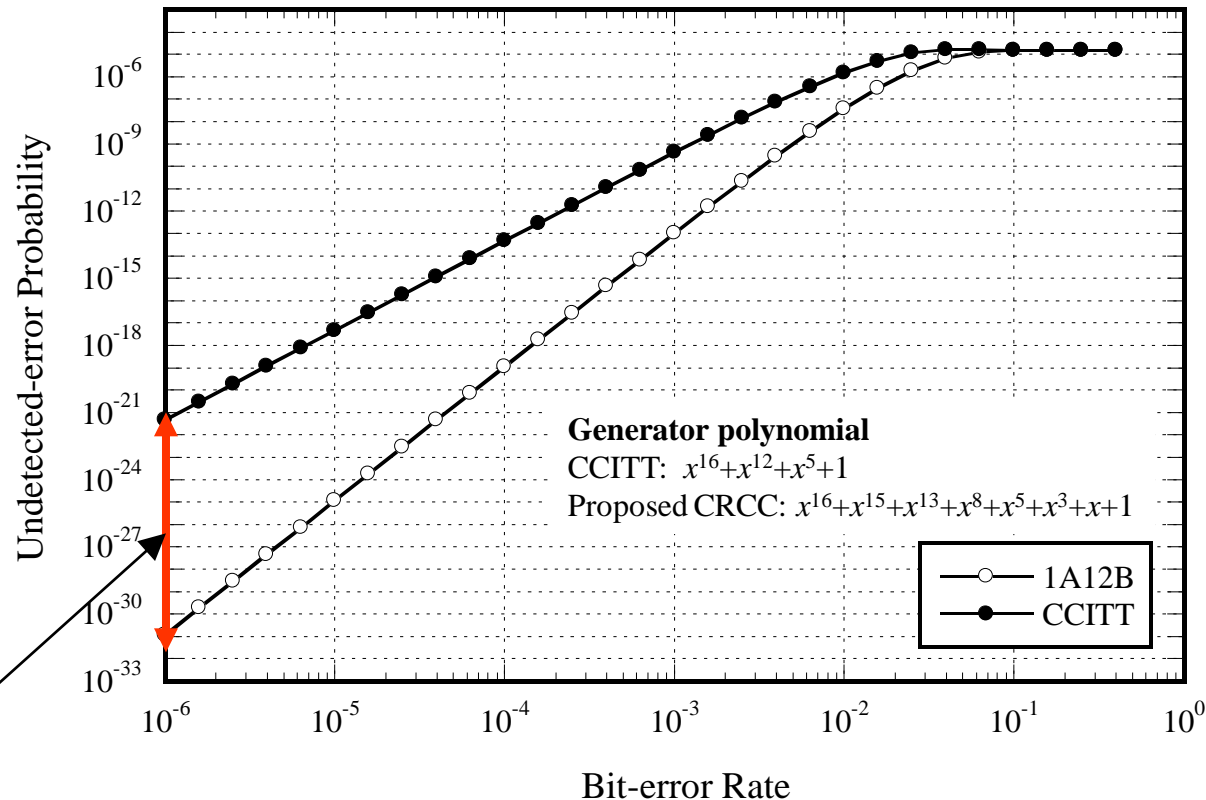

Shows excellent performance for low bit error rate

Undetected-error probabilities as a function of bit-error rate for a codeword length of 120 bits.

# 4. MAC protocol

# Summary of MAC protocol supplement

- **Baseline MAC**
  - 802.15.3b
- **Additional MAC functions**
  - Basic functions
    - Automatic device discovery (ADD)
    - Supporting common mode PHY
    - Interference avoidance
    - Throughput improvement

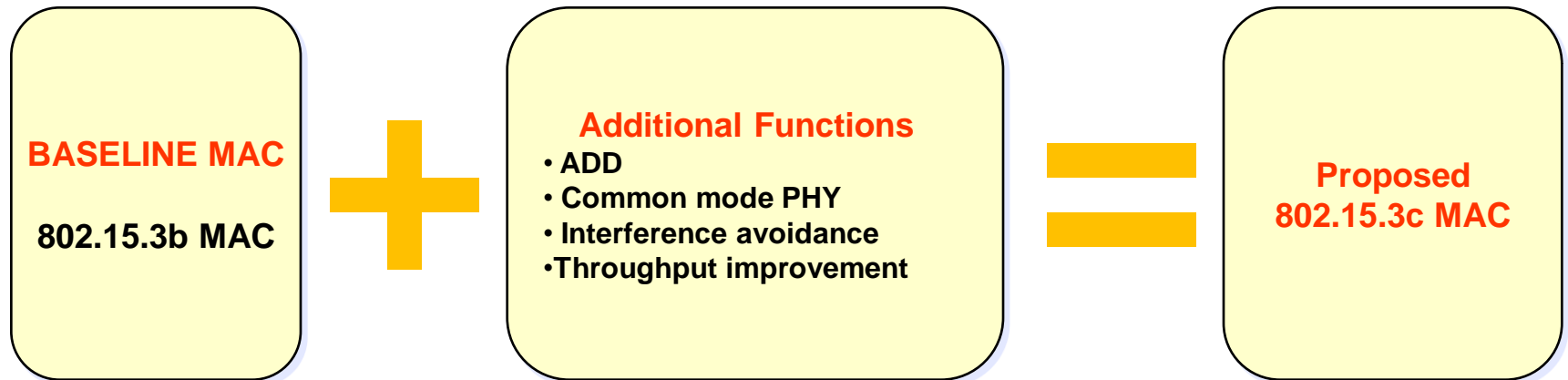

# ADD for directional antenna device is required on Tg3c alternate PHY

Supporting directional communication needed in Tg3c alternate PHY on 60GHz, **automatic device discovery (ADD) for directional antenna devices** is a big challenge in MAC design

- The considered Automatic Device Discovery has following features
  - Directional antenna for data transmission is also used for device discovery by employing successive beaoning and scanning procedure in all directions
  - Fast-rotating beaoning PNC, and slow-rotating scanning DEV are assumed considering DEV burden reduction
  - ADD routine is periodically activated even after DEV association, which enables a new DEV association and recovery from failed matching of antenna directivity

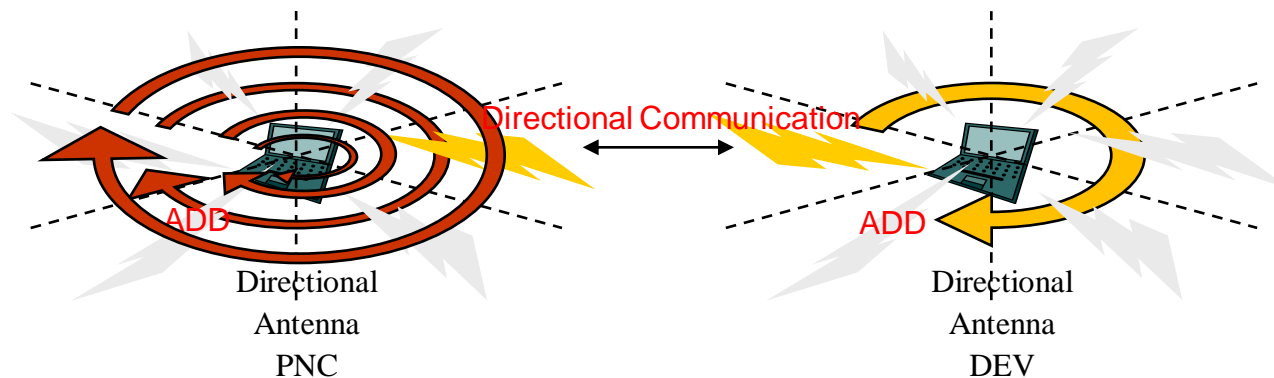

(Automatic device discovery for direction antenna devices)

## ■ Directional antenna device features

- $n$  TX/RX directions are supported
- TX/RX directions:
  - geographical directions sending and receiving Beacons, Control and Data/ACK frames
- Inter Beacon Space (IBS)
  - time from the end of the previous beacon frame to the start of the next beacon frame

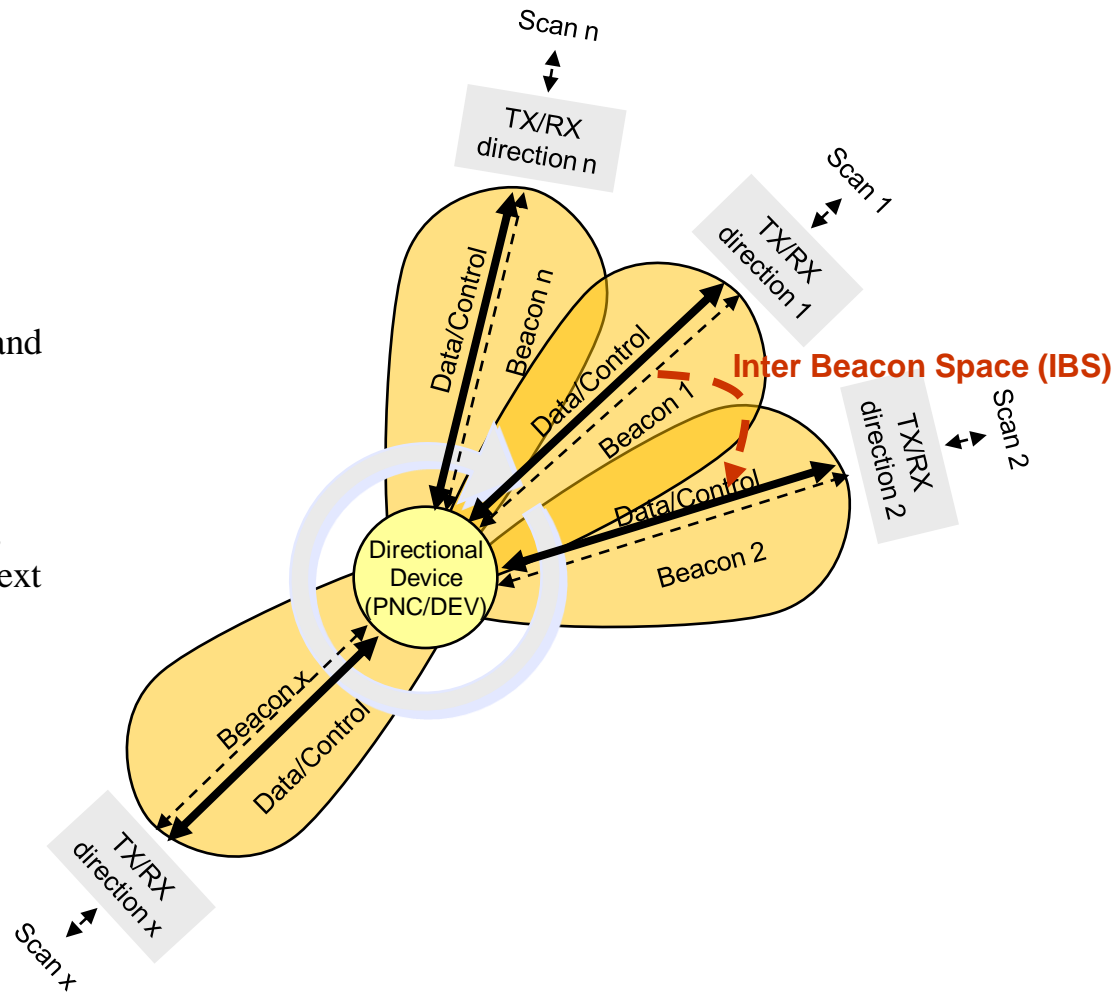

# Interference avoidance

- New DEV or PNC could become the interfering Transmitter in directional communication, Contention Admission Control (CAC) is necessary to avoid interference
- A new ID is defined for some specific DEVs not to associate with the PNC

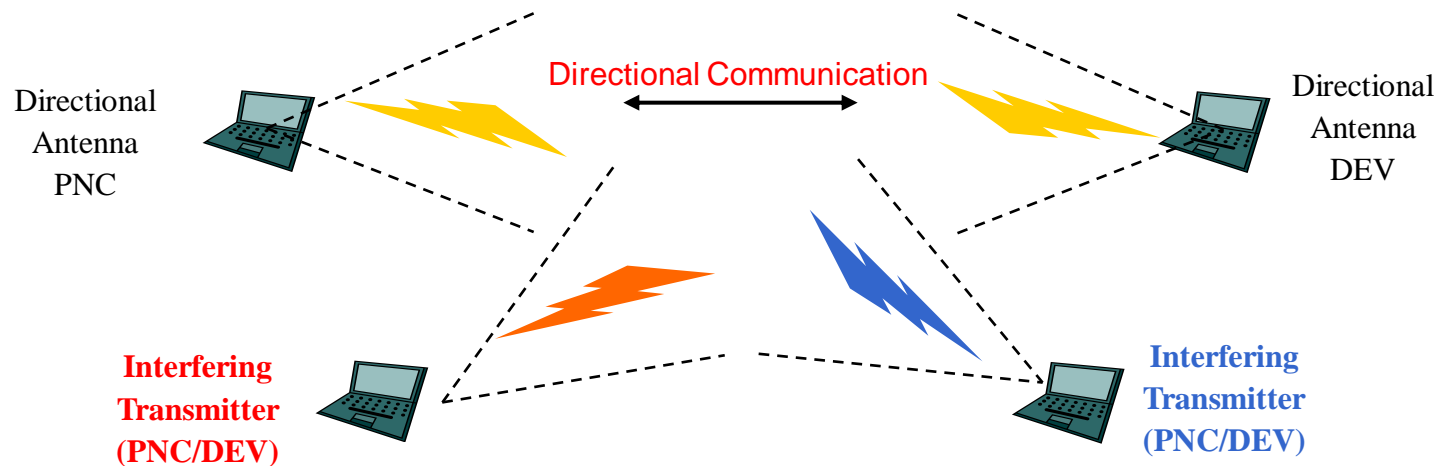

# Throughput improvement

- To achieve higher throughput and improve MAC efficiency, **frame aggregation or frame extension is necessary** in mm wave (60GHz) alternate PHY
- Reason
  - The conventional 802.15 MAC protocols were not enough to achieve high throughput due to limited frame size (defined by up to 12 bit, 2048 byte)
  - The extension of the length of 12 bit to 16 bit is proposed to realize frame aggregation or frame size extension for higher throughput efficiency



# Basic Operation Flow

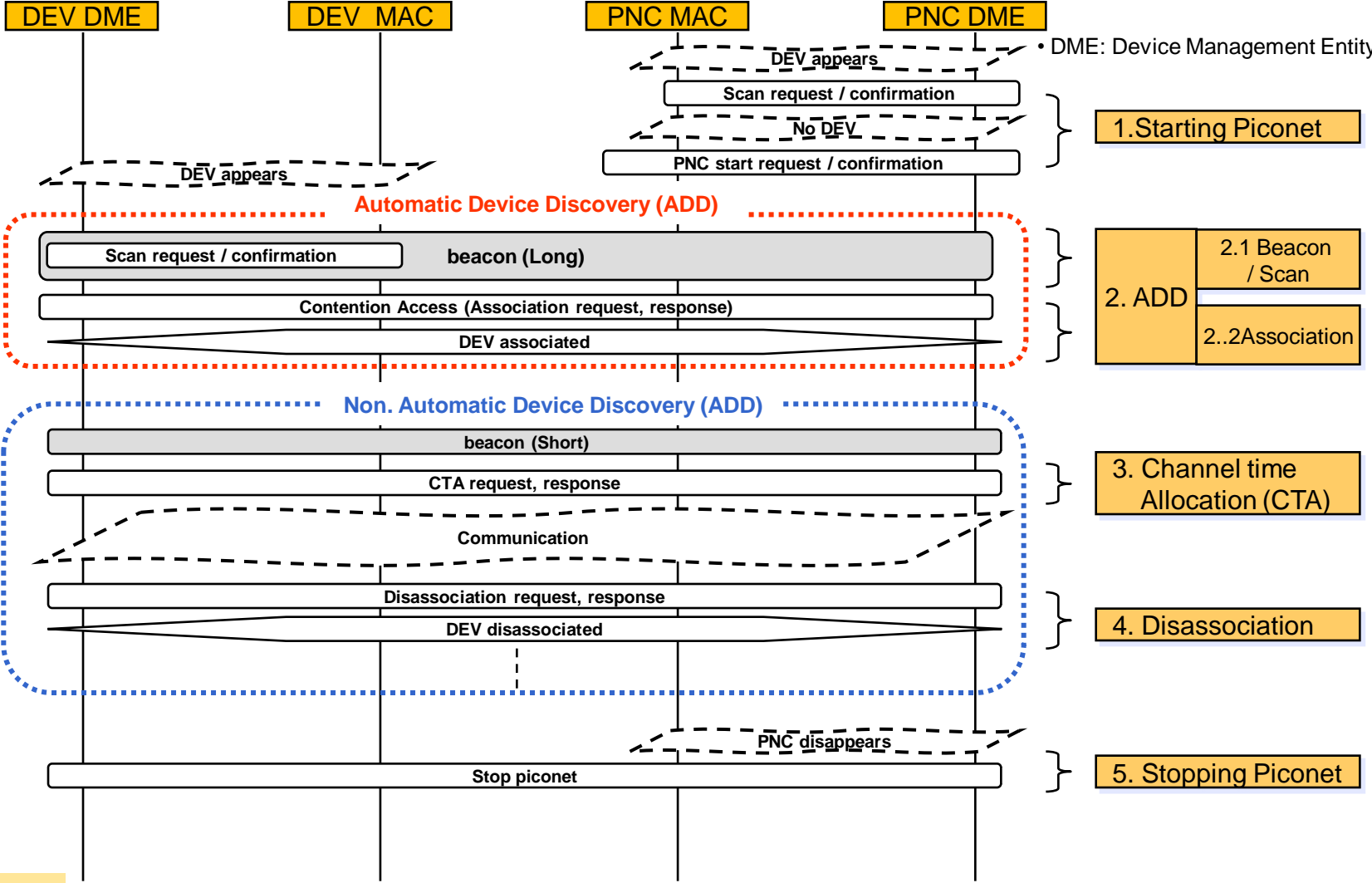

[to "Contents"](#)

# Basic Operation

## ■ 1. Starting piconet

- DEV detects an active piconet using passive scanning for a period of time
- If no desired/connectable piconets are found and DEV is capable of PNC operation, it starts a piconet using an unoccupied channel

## ■ 2. Automatic device discovery (ADD)

- When PNC initiates a piconet, automatic device discovery is performed
- ADD interval
  - Automatic device discovery is periodically performed to allow DEVs to join the piconet
- **2.1 Beacon period**
  - PNC transmits beacon frames periodically to its all available TX/RX directions that enables receivers to detect PNC
  - DEV listens to beacon frames in all available TX/RX directions
- **2.1 Contention access (Association request & response) period (CAP)**
  - When unassociated DEV receives a beacon frame, DEV's association process is performed

## ■ 3. Channel time allocation (CTA)

- When DEV wants to send a stream, DEV requests desired channel time to PNC
- PNC allocates the guarantee time for the stream if necessary, and directional communication is performed

## ■ 4. Disassociation

- When DEV or PNC wants to remove from a piconet or ATP (association time period) expires, disassociation process is performed

## ■ 5. Stopping piconet

- When PNC removes, piconet is stopped.

[to "Contents"](#)

# Superframe Configuration

■ Piconet timing is based on the **superframe** that consists of three parts:

- **1. Beacon Period (BP)** that is used for piconet synchronization and automatic device discovery by transmitting beacon frames from PNC. Two kinds of beacon period are defined as
  - **Long Beacon Period (LBP)** that includes several beacon frames is used for automatic device discovery of directional antenna devices
  - **Short Beacon Period (SBP)** that contains one beacon frame is used for piconet synchronization in data communication
- **2. Contention Access Period (CAP)** that is used for automatic device discovery and especially for transmitting command and data frames using contention based access (CSMA/CA) method. CAP can be divided by several directional CAPs (DCAPs).
  - **Directional CAP (DCAPs):** Each of DCAPs is assigned to one of the PNC's TX/RX directions
- **3. Channel Time Allocation Period (CTAP)** that consists of channel time allocations (CTAs) and/or management CTAs (MCTAs). Command and data frames are transmitted in CTAs

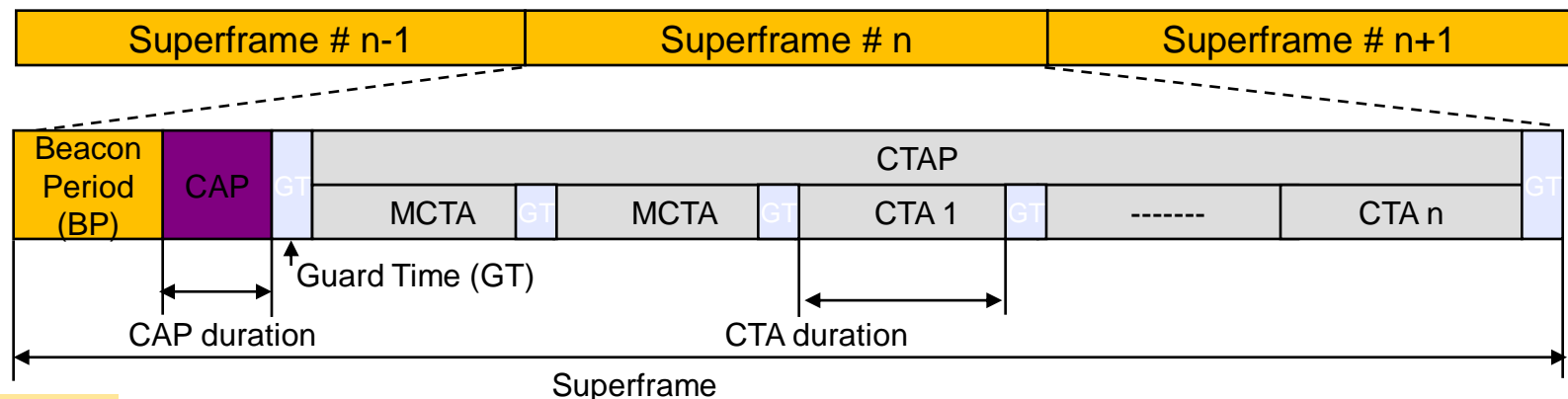

to "Contents"

# Superframe types

- For ADD, special type of superframe types are used, which includes LBP and DCAPs for ADD.
- Superframe operation
  - Automatic device discovery – LBP+DCAPs
  - Channel time allocation – SBP+CAP (or MCTA) / UpLink-Allocation request, DownLink-Allocation response
  - Data transmission – SBP+CTAP (or CAP)

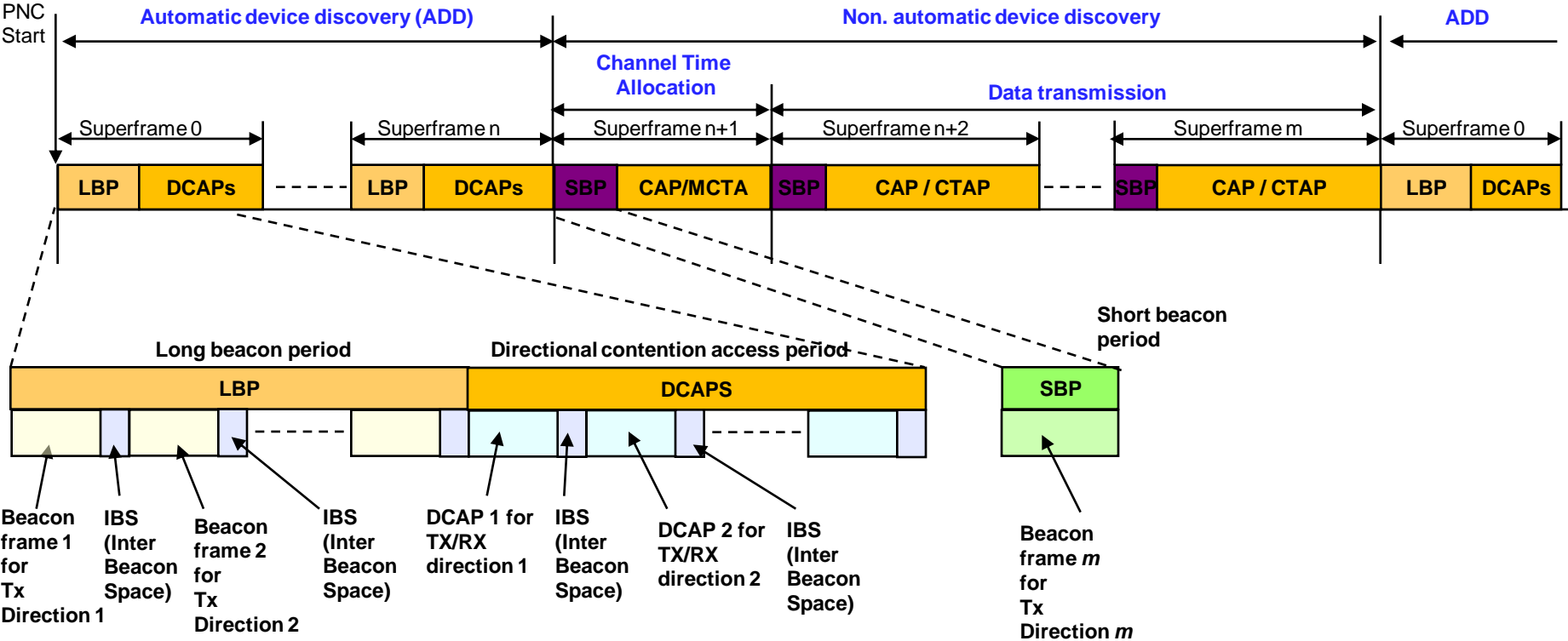

[to "Contents"](#)

## 5. Common mode

## Common mode summary

- Common mode offers Easy Expandability: From Single Carrier to OFDM (or other Single Carriers) and vice versa
- CoMPA basically promotes Single Carrier air interface which best fits to short range LOS communications
- Various WPAN applications, however, may require different air interfaces and market will decide the best air-interface for each
- Common mode proposed by CoMPA is to bridge different air interfaces for different applications offering multiple air interfaces fitting best to applications

# Common Mode Proposed for Huge Expandability

- Common mode to bridge multiple PHY for various applications - from portable to high end by detecting available PHY through common mode
- Single Carrier for Portable applications (UM5) - low power and low cost applications and OFDM for high end applications

## I. With the same channel plan: **Huge expandability**

: **OWN MODE and EXPANDED MODE from other parties – no need to give up emerging market**

- i. SC but different modulation and/or FEC – different bit rates  
: “common mode” will give the opportunity to expand SC air interfaces **EASILY** if there is market

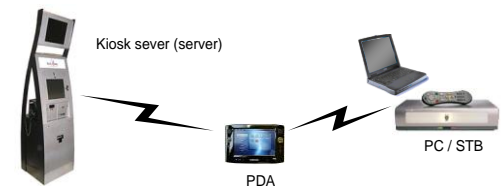

- ii. OFDM

: “common mode” will give the opportunity to expand air interfaces to SC from OFDM **EASILY** if there is market

## II. With different channel plans

Power detection for interference avoidance



# Easy Expandability: From Single Carrier to OFDM and vice versa

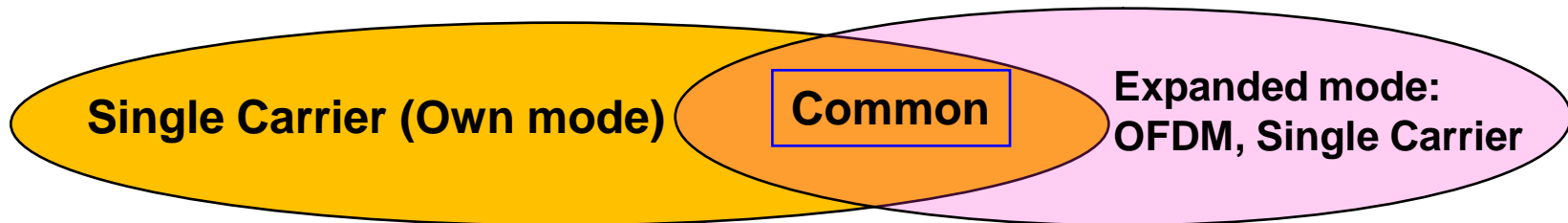

**Expansion from Single Carrier to OFDM or Single Carrier**

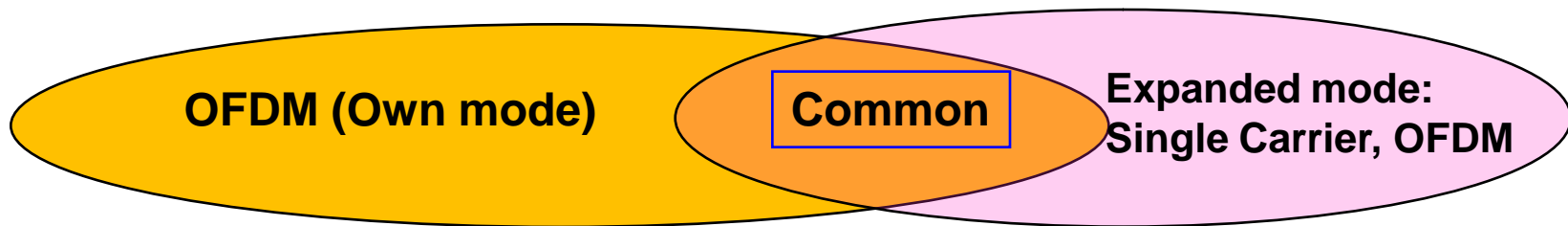

**Expansion from OFDM to Single Carrier or OFDM**



## 6. Items to be reported for PHY

6.1: Mean 90% PER and BER link success probability versus  $E_b/N_0$  for each data rate mode  
(1<sup>st</sup> item to be reported for PHY)

Mode	AWGN		CM1.3		CM2.3		CM3.1		CM9.1	
	BER = 10 <sup>-6</sup>	PER = 0.08	BER = 10 <sup>-6</sup>	PER = 0.08	BER = 10 <sup>-6</sup>	PER = 0.08	BER = 10 <sup>-6</sup>	PER = 0.08	BER = 10 <sup>-6</sup>	PER = 0.08
1.1	7.3	6.5	7.3	6.5	-	-	11.1	8.7	7.3	6.5
1.3	5.1	4.4	5.1	4.4	-	-	6.8	5.6	5.1	5.6
1.4	4.0	3.2	4.0	3.2	-	-	5.2	4.2	4.0	3.2
2.1	7.2	6.6	7.2	6.6	13.5*	11.8*	12.0*	9.1*	7.2	6.6
2.2.1**	5.8	5.3	5.8	5.3	10.9*	9.9*	9.4*	7.8*	5.8	5.3
2.3	5.2	4.4	5.2	4.4	-	-	11.2	7.8	5.2	4.4
2.4	4.1	3.3	4.1	3.3	-	-	6.8	5.2	4.1	3.3
3.1	11.2	10.3	11.2	10.3	19.1*	17.0*	-	-	11.2	10.3
3.2**	9.5	8.6	9.5	8.6	16.5*	14.7*	-	-	9.5	8.6

Unit is dB

■ Both effects of PA non-linearity and Phase-noise considered

■\* means that FDE with CP=128 is used

■\*\* means that number of iterations for an LDPC decoder is 16

[to "Contents"](#)

# Summary of Simulation parameters

Parameters	Value
Symbol rate	1664Msymbol/s
Root raised cosine filter	Roll-off factor = 0.25
Channel model	15-07-0648/r00
Antenna model	Tx and Rx antennas of 30 deg with reference side lobe model with antenna gain of 15.91 dBi (15-06-0474/r00)
Number of channel realizations	100
Power amplifier (PA) model	SiGe model with Output back off (OBO)= 3 dB (15-06-0477/r01)
Phase noise (PN) model	Pole frequency $f_p = 1$ MHz, Zero frequency $f_z = 100$ MHz, PSD(0)=-93 dBc/Hz@1MHz (15-06-0477/r01)
Payload size	2052 byte (Data payload:2048 byte + FCS:4byte)
Frame and timing synchronization:	Perfect
Others	Sum of the whole received signal is the signal power to set $E_b$ in each channel realization Number of iterations for an LDPC decoder: 16

[to "Contents"](#)

# Power amplifier (PA) model

## AM/AM distortion model

$$F_{AM-AM}(V_{out}) = \frac{GV_{in}}{\left(1 + \left(\frac{GV_{in}}{V_{sat}}\right)^{2p}\right)^{\frac{1}{2p}}}$$

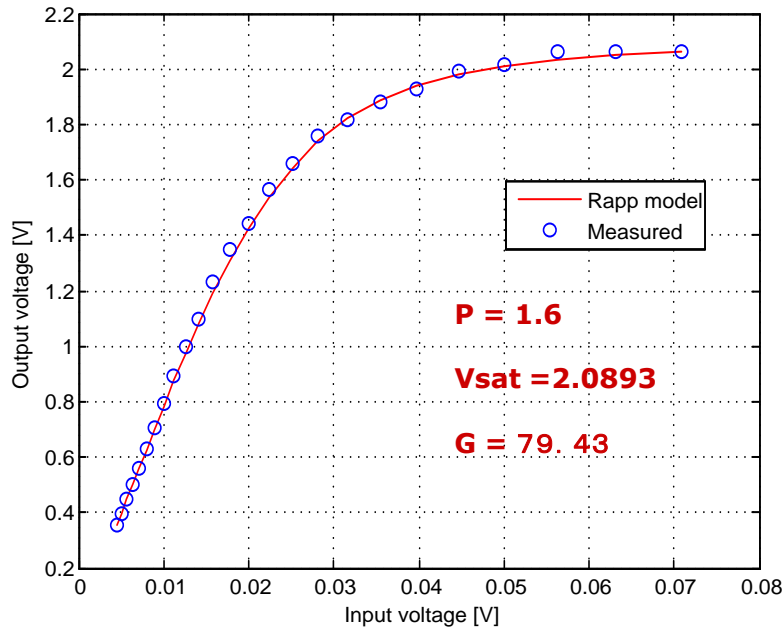

## AM/PM distortion model

$$F_{AM-PM}(\theta) = \frac{Ax^q}{\left(1 + \left(\frac{x}{B}\right)^q\right)}$$

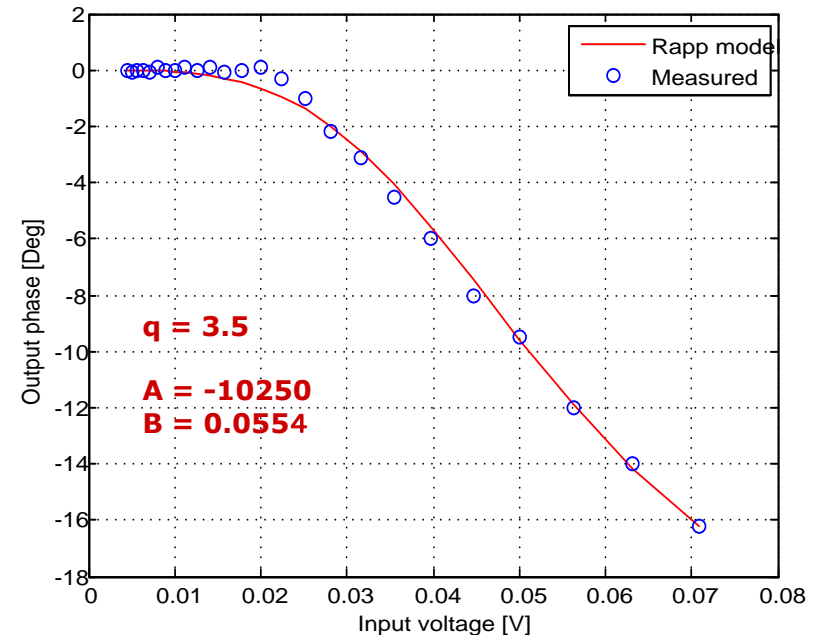

Parameters were obtained by fitting to a Measured BiCMOS PA characteristics

[to "Contents"](#)

# PN model used

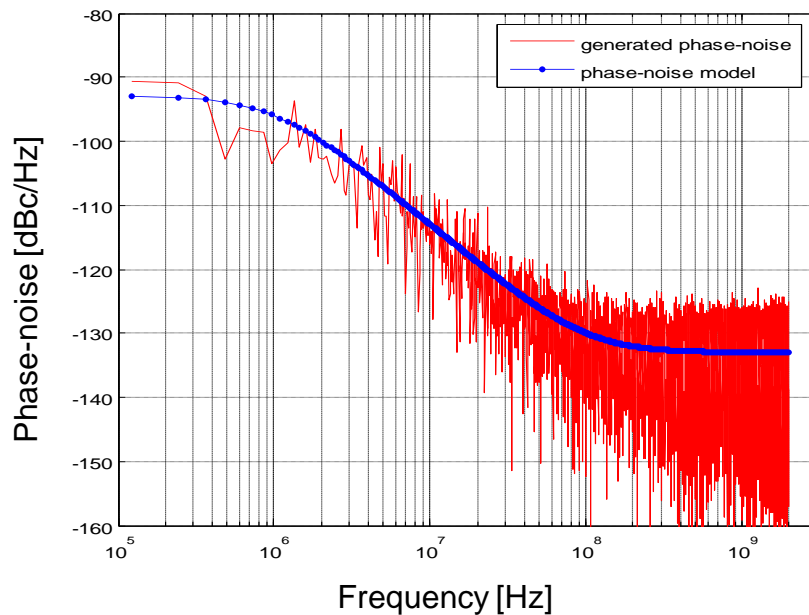

$$PSD(f) = PSD(0) \frac{[1 + (f / f_z)^2]}{[1 + (f / f_p)^2]}$$

$PSD(0) = -93\text{dBc/Hz}@1\text{MHz}$

Pole frequency  $f_p = 1\text{MHz}$

Zero frequency  $f_z = 100\text{MHz}$

## BER

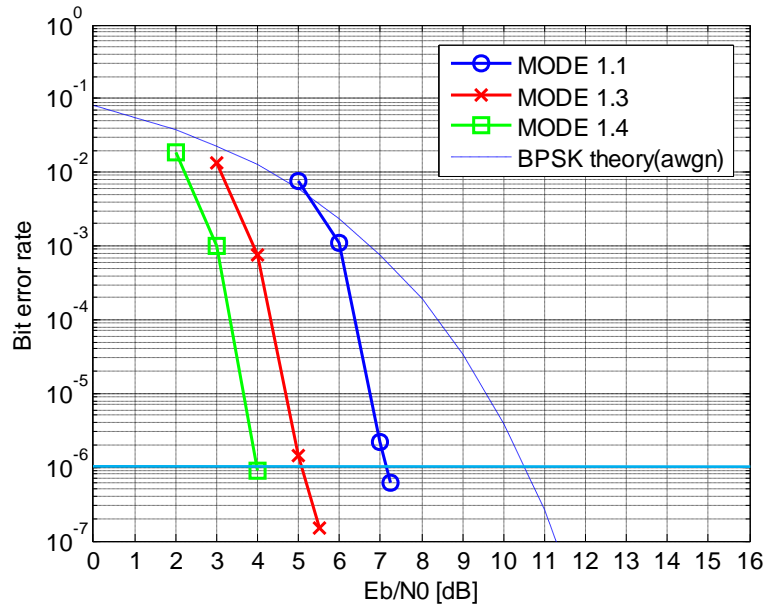

$BER = 10^{-6}$

Mode 1.1: Required  $E_b/N_0 = 7.3$  [dB]

Mode 1.3: Required  $E_b/N_0 = 5.1$  [dB]

Mode 1.4: Required  $E_b/N_0 = 4.0$  [dB]

## PER

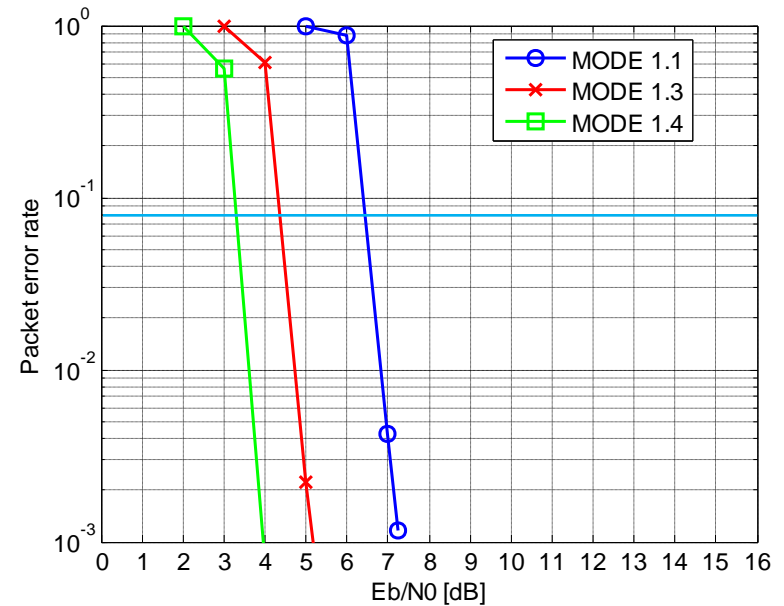

$PER = 0.08$

Mode 1.1: Required  $E_b/N_0 = 6.5$  [dB]

Mode 1.3: Required  $E_b/N_0 = 4.4$  [dB]

Mode 1.4: Required  $E_b/N_0 = 3.2$  [dB]

### BER

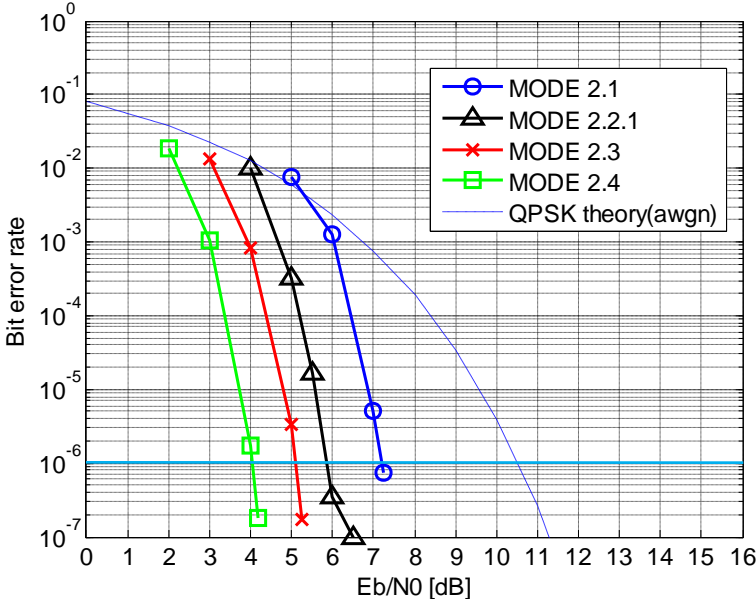

BER=10<sup>-6</sup>

- Mode 2.1 : Required  $E_b/N_o=7.2$  [dB]
- Mode 2.2.1: Required  $E_b/N_o=5.8$  [dB]
- Mode 2.3 : Required  $E_b/N_o=5.2$  [dB]
- Mode 2.4 : Required  $E_b/N_o=4.1$  [dB]

### PER

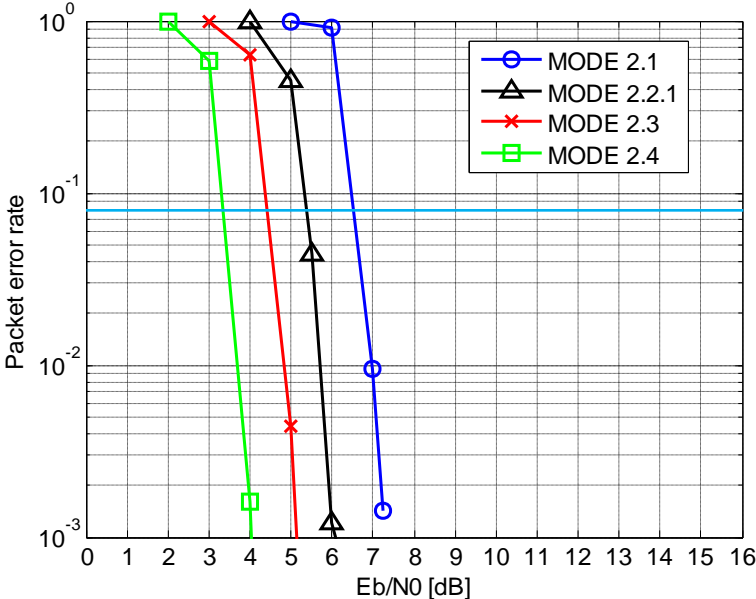

PER=0.08

- Mode 2.1 : Required  $E_b/N_o=6.6$  [dB]
- Mode 2.2.1: Required  $E_b/N_o=5.3$  [dB]
- Mode 2.3 : Required  $E_b/N_o=4.4$  [dB]
- Mode 2.4 : Required  $E_b/N_o=3.3$  [dB]

[to "Contents"](#)

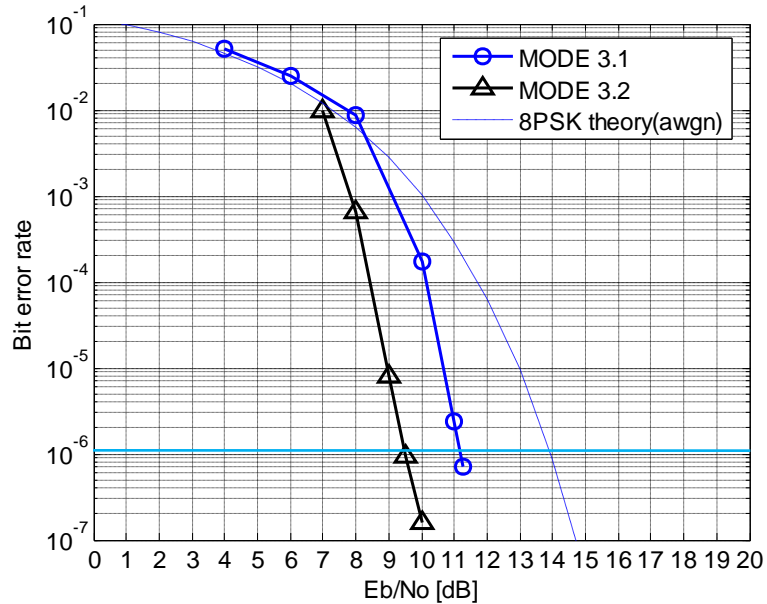

## BER

BER= $10^{-6}$ Mode 3.1: Required  $E_b/N_0=11.2$  [dB]Mode 3.2: Required  $E_b/N_0=9.5$  [dB]

## PER

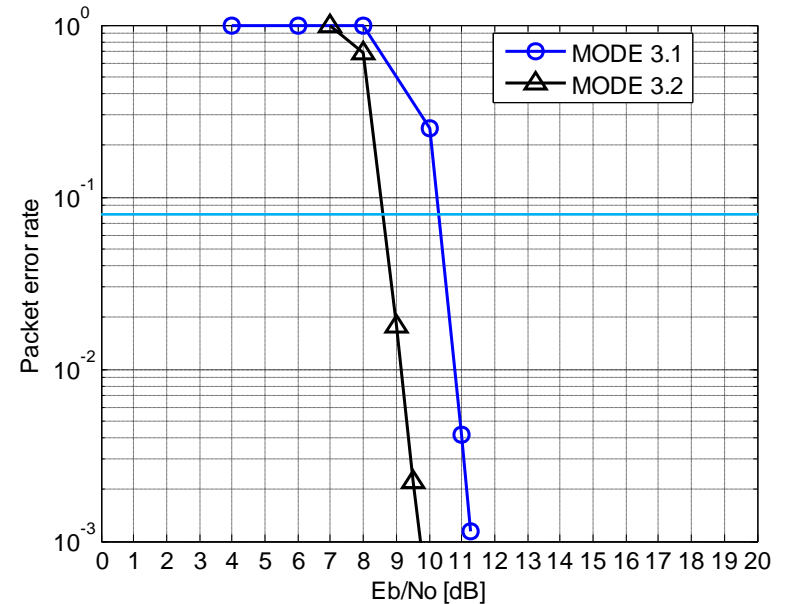

PER=0.08

Mode 3.1: Required  $E_b/N_0=10.3$  [dB]Mode 3.2: Required  $E_b/N_0=8.6$  [dB]

# CM1.3 BPSK (w PA, w PN)

BER

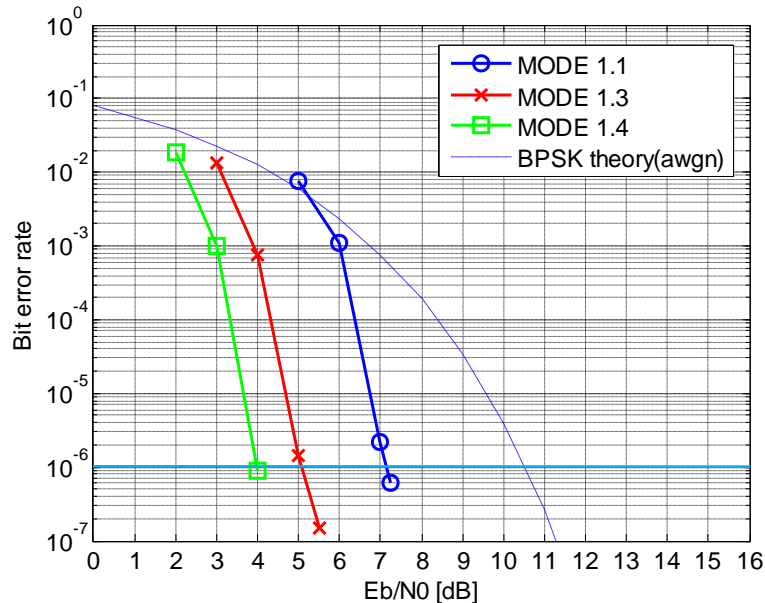

BER=10<sup>-6</sup>

Mode 1.1: Required  $E_b/N_o=7.3$  [dB]

Mode 1.3: Required  $E_b/N_o=5.1$  [dB]

Mode 1.4: Required  $E_b/N_o=4.0$  [dB]

PER

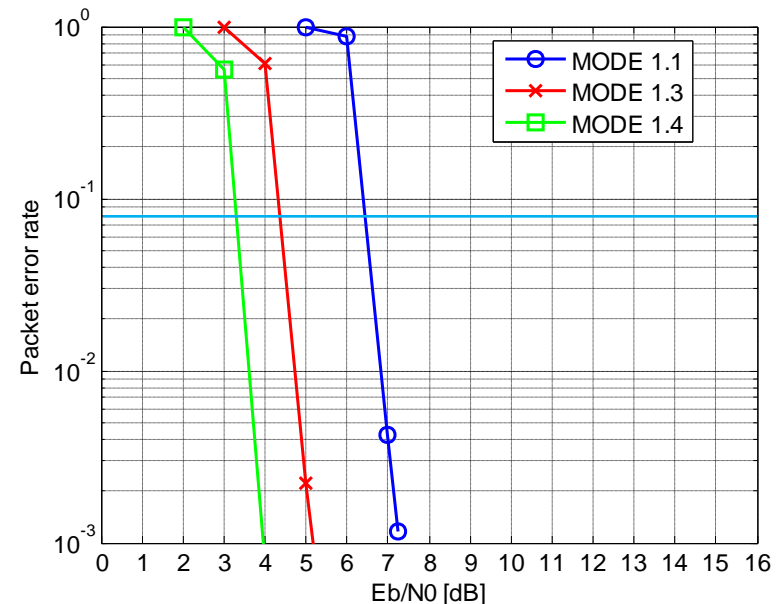

PER=0.08

Mode 1.1: Required  $E_b/N_o=6.5$  [dB]

Mode 1.3: Required  $E_b/N_o=4.4$  [dB]

Mode 1.4: Required  $E_b/N_o=3.2$  [dB]

## BER

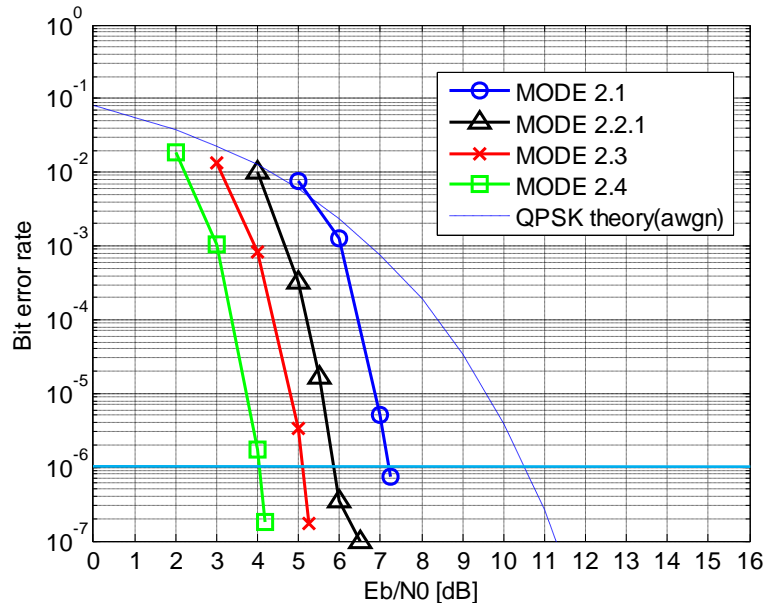
BER =  $10^{-6}$ Mode 2.1 : Required  $E_b/N_0 = 7.2$  [dB]Mode 2.2.1: Required  $E_b/N_0 = 5.8$  [dB]Mode 2.3 : Required  $E_b/N_0 = 5.2$  [dB]Mode 2.4 : Required  $E_b/N_0 = 4.1$  [dB]

## PER

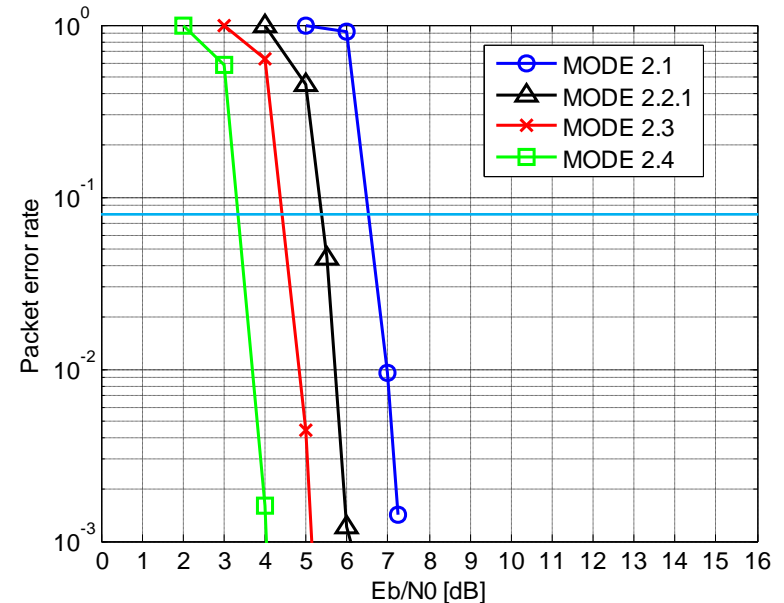

PER = 0.08

Mode 2.1 : Required  $E_b/N_0 = 6.6$  [dB]Mode 2.2.1: Required  $E_b/N_0 = 5.3$  [dB]Mode 2.3 : Required  $E_b/N_0 = 4.4$  [dB]Mode 2.4 : Required  $E_b/N_0 = 3.3$  [dB][to "Contents"](#)

### BER

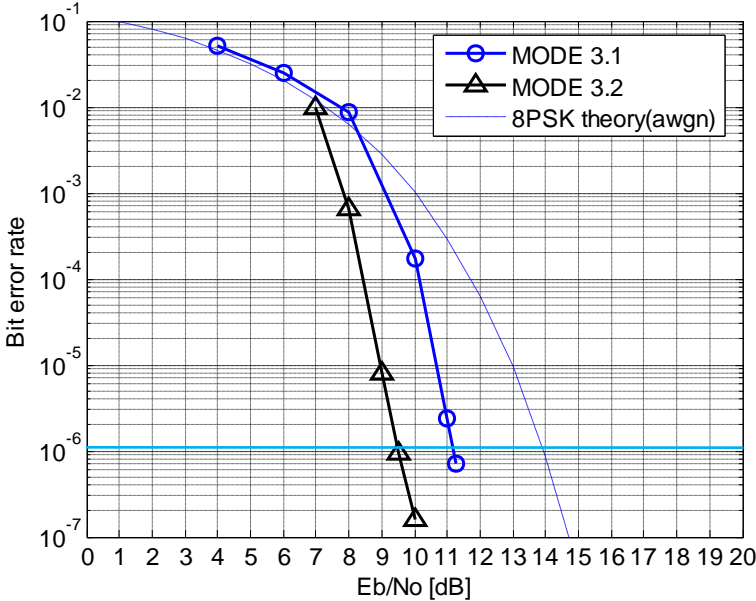

BER= $10^{-6}$

Mode 3.1: Required  $E_b/N_0=11.2$  [dB]

Mode 3.2: Required  $E_b/N_0=9.5$  [dB]

### PER

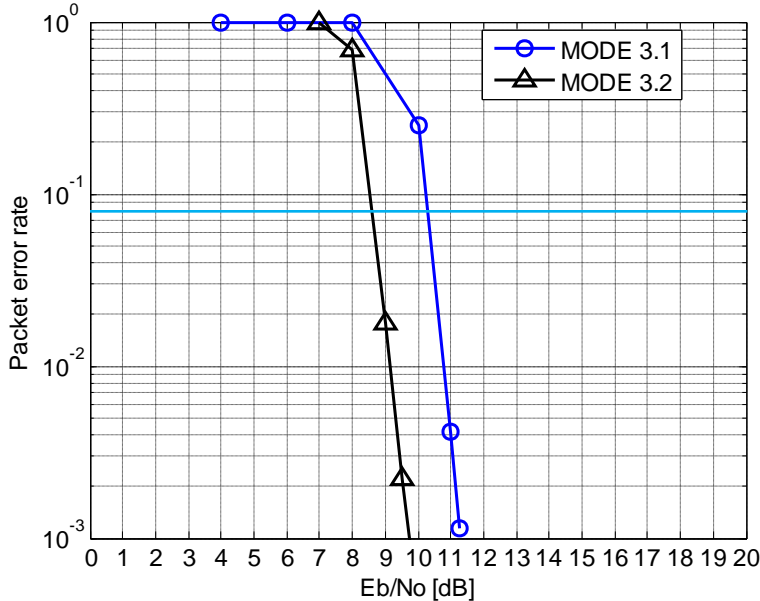

PER=0.08

Mode 3.1: Required  $E_b/N_0=10.3$  [dB]

Mode 3.2: Required  $E_b/N_0=8.6$  [dB]

## BER

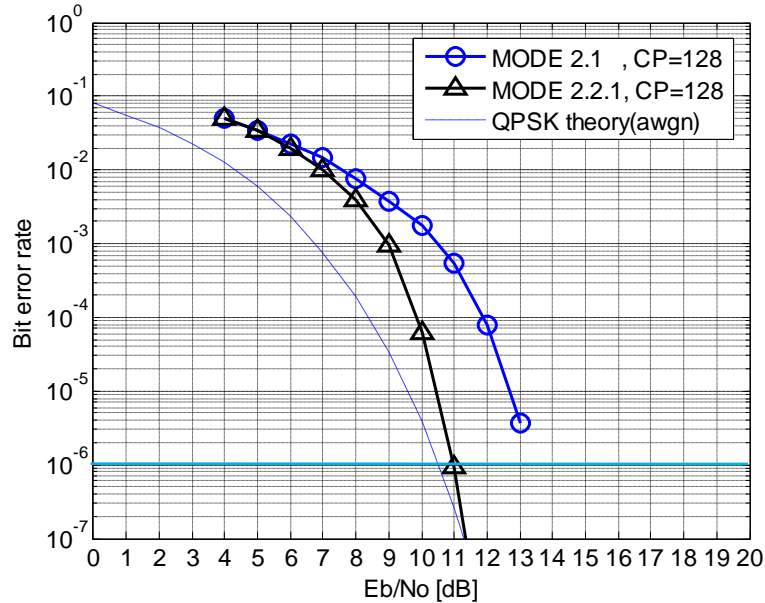

BER= $10^{-6}$

Mode 2.1 : Required  $E_b/N_0=13.5$  [dB]

Mode 2.2.1: Required  $E_b/N_0=10.9$  [dB]

## PER

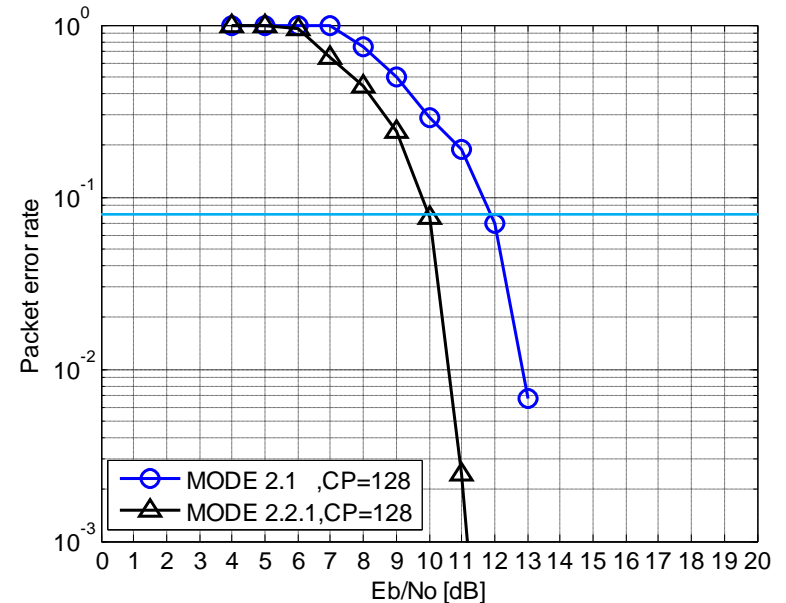

PER=0.08

Mode 2.1 : Required  $E_b/N_0=11.8$  [dB]

Mode 2.2.1: Required  $E_b/N_0=9.9$  [dB]

## BER

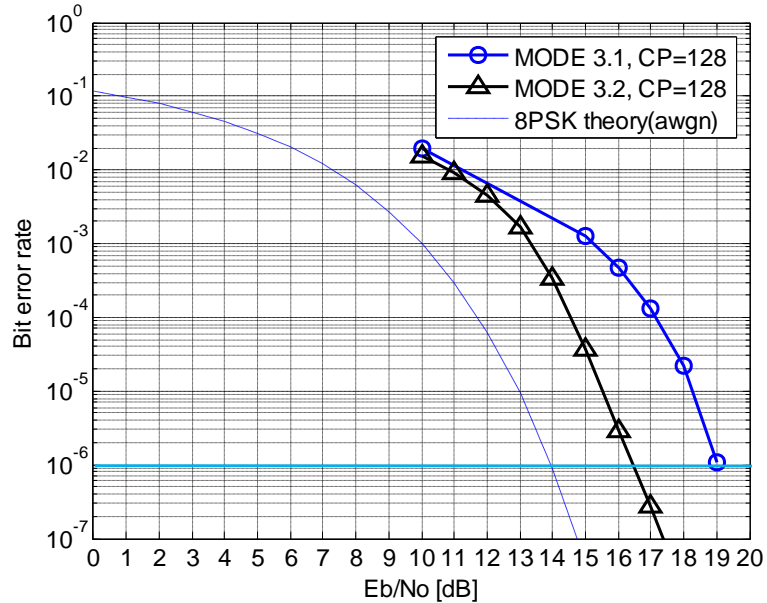
BER= $10^{-6}$ Mode 3.1: Required  $E_b/N_0 = 19.1$  [dB]Mode 3.2: Required  $E_b/N_0 = 16.5$  [dB]

## PER

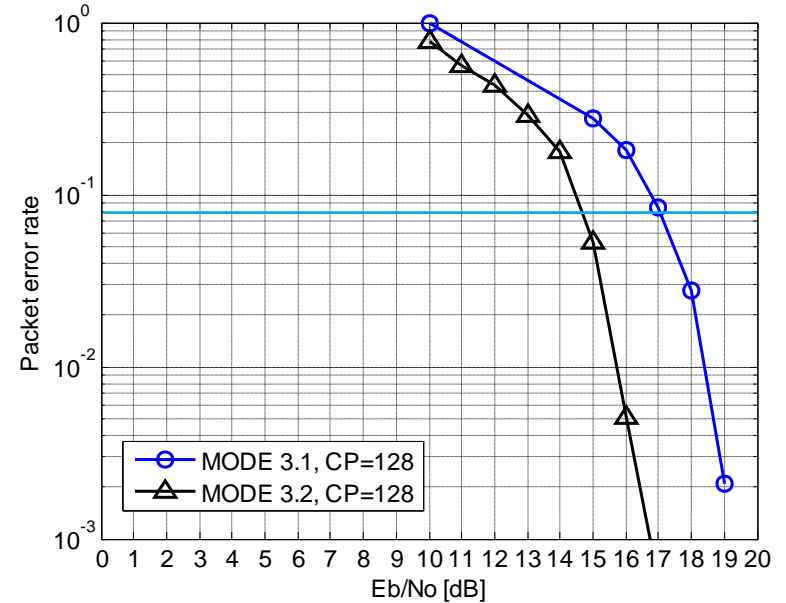

PER=0.08

Mode 3.1: Required  $E_b/N_0 = 17.0$  [dB]Mode 3.2: Required  $E_b/N_0 = 14.7$  [dB]

### BER

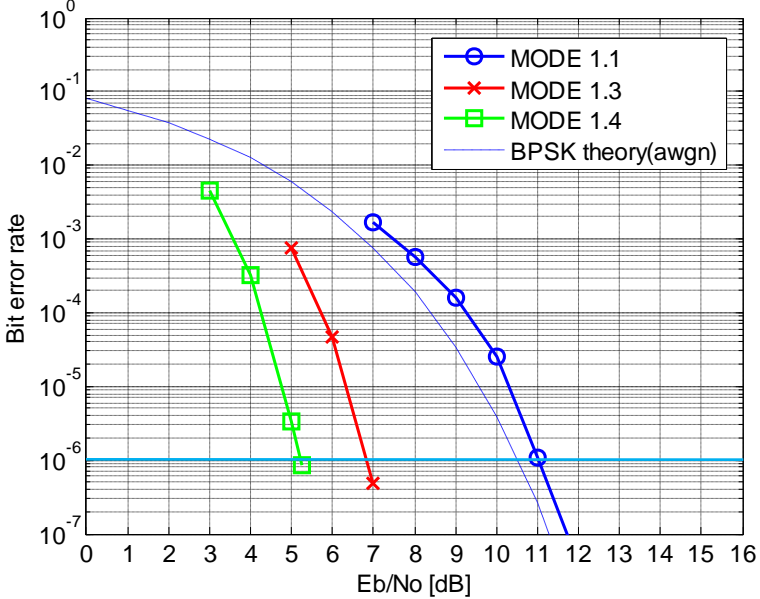

BER= $10^{-6}$

Mode 1.1: Required  $E_b/N_0=11.1$  [dB]

Mode 1.3: Required  $E_b/N_0=6.8$  [dB]

Mode 1.4: Required  $E_b/N_0=5.2$  [dB]

### PER

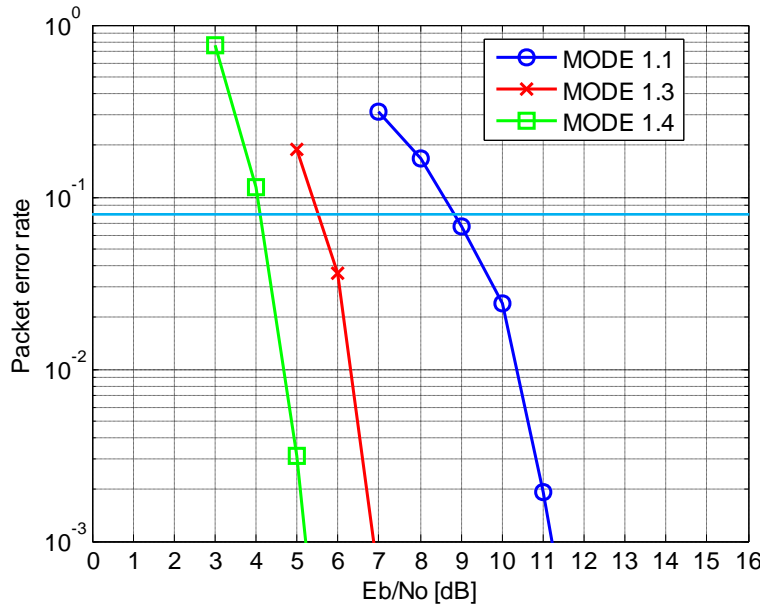

PER=0.08

Mode 1.1: Required  $E_b/N_0=8.7$  [dB]

Mode 1.3: Required  $E_b/N_0=5.6$  [dB]

Mode 1.4: Required  $E_b/N_0=4.2$  [dB]

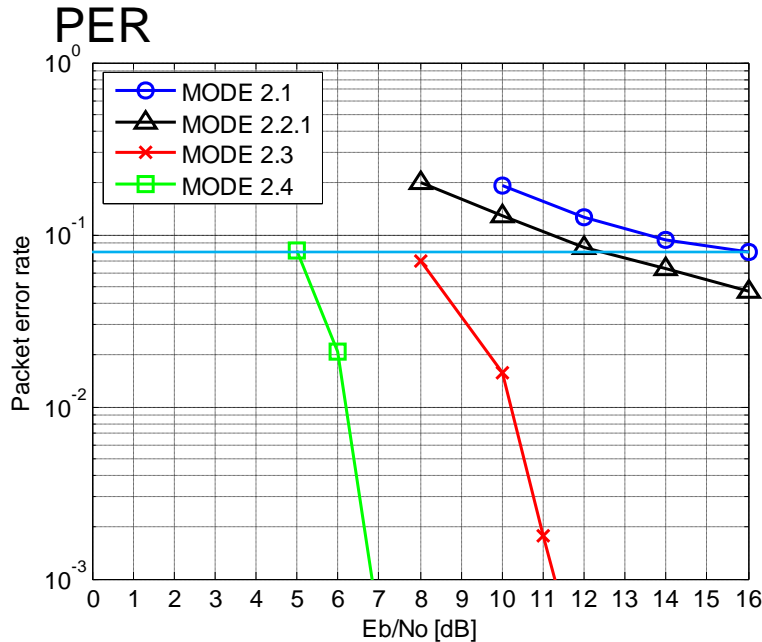
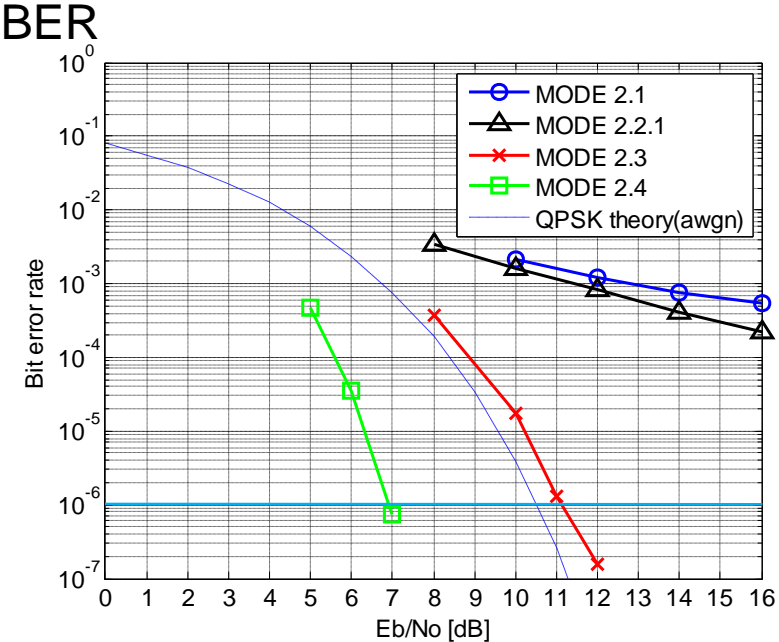

BER= $10^{-6}$   
Mode 2.1: Out of required performance  
Mode 2.2.1: Out of required performance  
Mode 2.3: Required  $E_b/N_0=11.2$  [dB]  
Mode 2.4: Required  $E_b/N_0=6.8$  [dB]

PER=0.08  
Mode 2.1: Required  $E_b/N_0=16.0$  [dB]  
Mode 2.2.1: Required  $E_b/N_0=12.5$  [dB]  
Mode 2.3: Required  $E_b/N_0=7.8$  [dB]  
Mode 2.4: Required  $E_b/N_0=5.2$  [dB]

[to "Contents"](#)



### BER

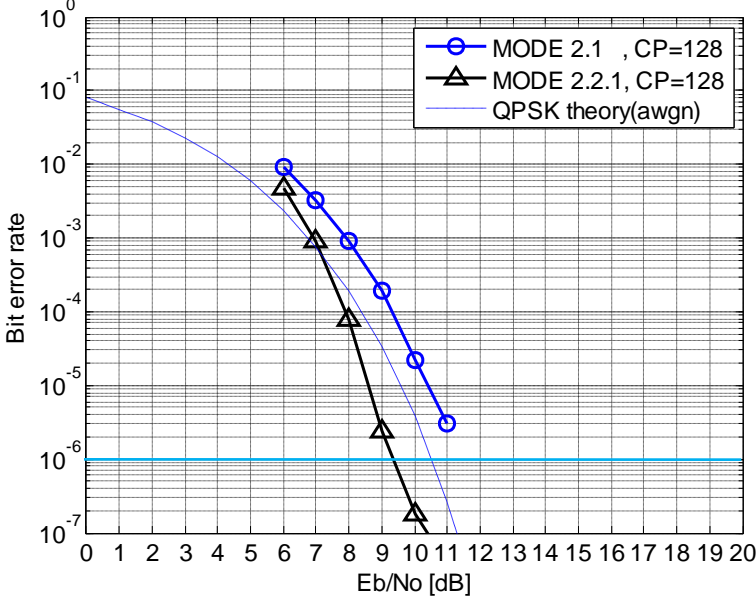

$BER=10^{-6}$

Mode 2.1 : Required  $E_b/N_0=12.0$  [dB]

Mode 2.2.1: Required  $E_b/N_0=9.4$  [dB]

### PER

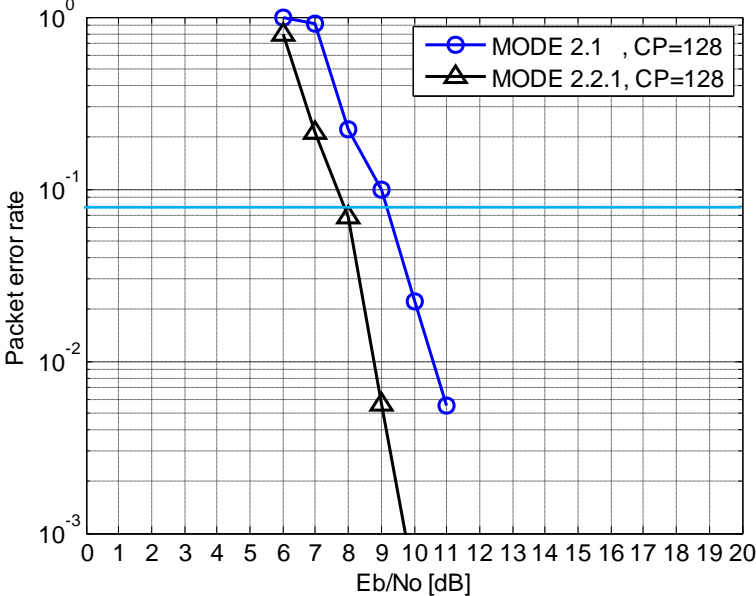

$PER=0.08$

Mode 2.1 : Required  $E_b/N_0=9.1$  [dB]

Mode 2.2.1: Required  $E_b/N_0=7.8$  [dB]

# CM9.1 BPSK (w PA, w PN)

BER

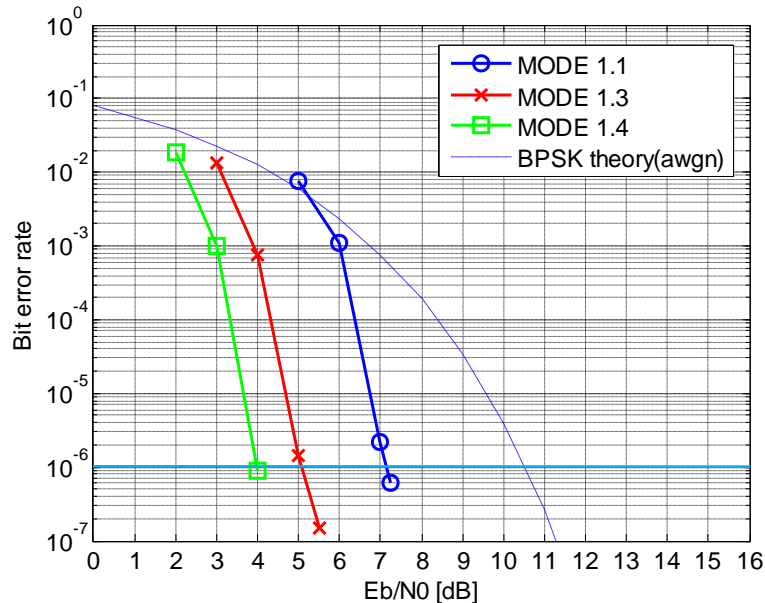

BER=10<sup>-6</sup>

Mode 1.1: Required  $E_b/N_o=7.3$  [dB]

Mode 1.3: Required  $E_b/N_o=5.1$  [dB]

Mode 1.4: Required  $E_b/N_o=4.0$  [dB]

PER

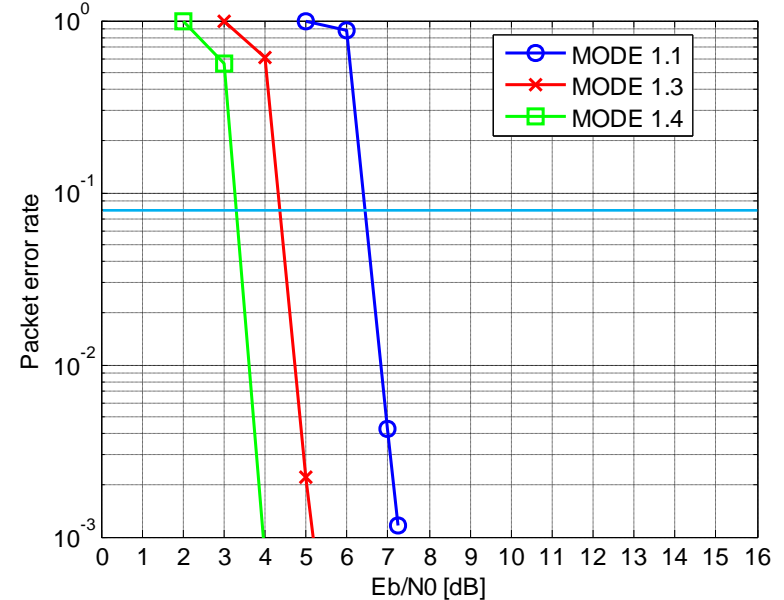

PER=0.08

Mode 1.1: Required  $E_b/N_o=6.5$  [dB]

Mode 1.3: Required  $E_b/N_o=4.4$  [dB]

Mode 1.4: Required  $E_b/N_o=3.2$  [dB]

### BER

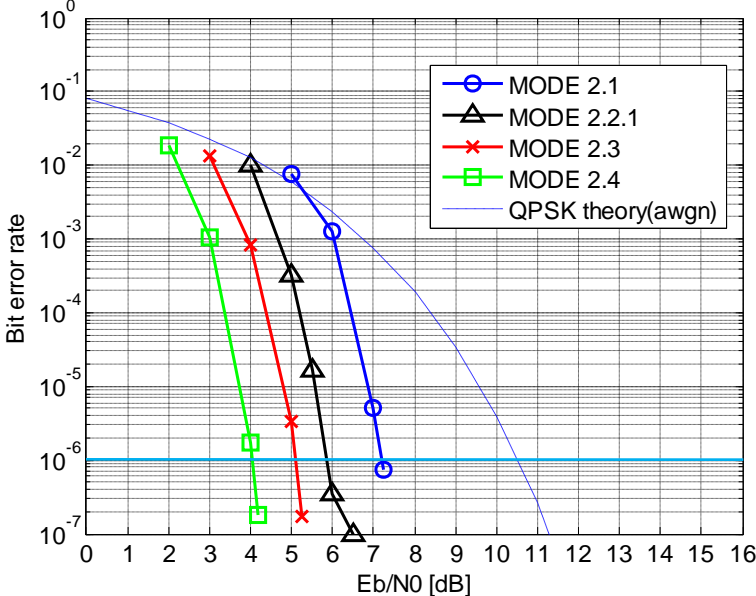

BER= $10^{-6}$

- Mode 2.1 : Required  $E_b/N_0=7.2$  [dB]
- Mode 2.2.1: Required  $E_b/N_0=5.8$  [dB]
- Mode 2.3 : Required  $E_b/N_0=5.2$  [dB]
- Mode 2.4 : Required  $E_b/N_0=4.1$  [dB]

### PER

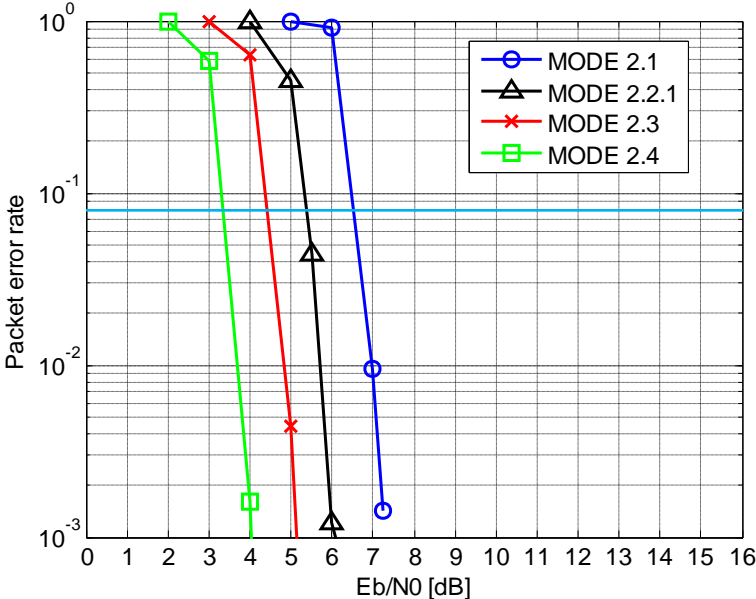

PER=0.08

- Mode 2.1 : Required  $E_b/N_0=6.6$  [dB]
- Mode 2.2.1: Required  $E_b/N_0=5.3$  [dB]
- Mode 2.3 : Required  $E_b/N_0=4.4$  [dB]
- Mode 2.4 : Required  $E_b/N_0=3.3$  [dB]

## BER

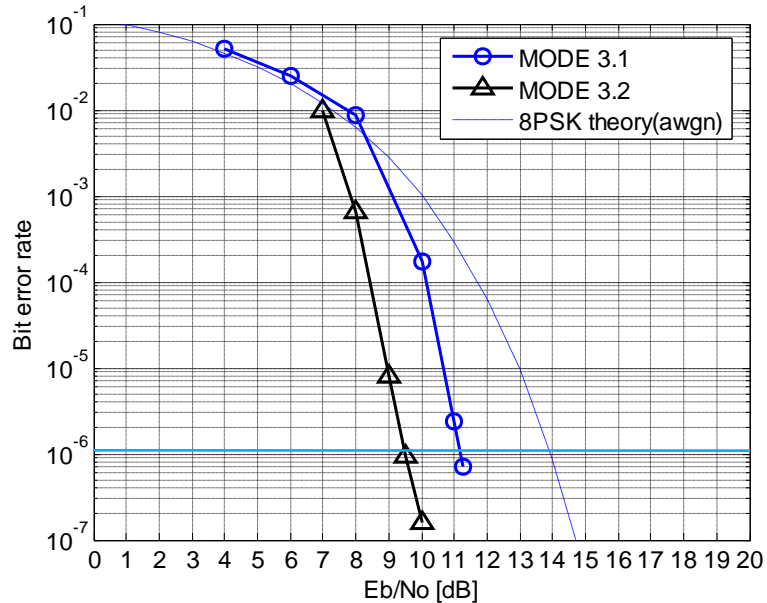
BER= $10^{-6}$ Mode 3.1 : Required  $E_b/N_0=11.2$  [dB]Mode 3.2 : Required  $E_b/N_0=9.5$  [dB]

## PER

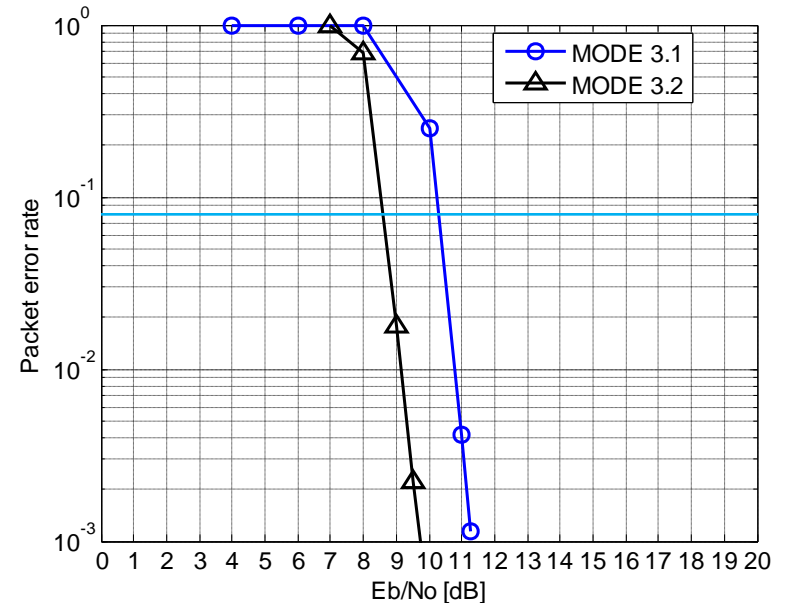

PER=0.08

Mode 3.1 : Required  $E_b/N_0=10.3$  [dB]Mode 3.2 : Required  $E_b/N_0=8.6$  [dB]

6.2. Mean 90% PER and BER link success  
distance for each data rate mode  
(2<sup>nd</sup> item to be reported for PHY)

Mode	AWGN		CM1.3		CM2.3		CM3.1		CM9.1	
	BER = 10 <sup>-6</sup>	PER = 0.08	BER = 10 <sup>-6</sup>	PER = 0.08	BER = 10 <sup>-6</sup>	PER = 0.08	BER = 10 <sup>-6</sup>	PER = 0.08	BER = 10 <sup>-6</sup>	PER = 0.08
1.1	7.3	6.5	7.3	6.5	-	-	11.1	8.7	7.3	6.5
1.3	5.1	4.4	5.1	4.4	-	-	6.8	5.6	5.1	5.6
1.4	4.0	3.2	4.0	3.2	-	-	5.2	4.2	4.0	3.2
2.1	7.2	6.6	7.2	6.6	13.5*	11.8*	12.0*	9.1*	7.2	6.6
2.2.1**	5.8	5.3	5.8	5.3	10.9*	9.9*	9.4*	7.8*	5.8	5.3
2.3	5.2	4.4	5.2	4.4	-	-	11.2	7.8	5.2	4.4
2.4	4.1	3.3	4.1	3.3	-	-	6.8	5.2	4.1	3.3
3.1	11.2	10.3	11.2	10.3	19.1*	17.0*	-	-	11.2	10.3
3.2**	9.5	8.6	9.5	8.6	16.5*	14.7*	-	-	9.5	8.6

Unit is dB

■ Both effects of PA non-linearity and Phase-noise considered

■\* means that FDE with CP=128 is used

■\*\* means that number of iterations for an LDPC decoder is 16

[to "Contents"](#)

# Summary of Link budget and maximum operating range

Items	UM1				UM5	
Required MAC-SAP	1.78		3.56		1.5 & 2.25	
Channel model	1.3	2.3	1.3	2.3	3.1	9.1
Target BER and PER	BER = $10^{-6}$				PER=0.08	
Transmission mode	Mode2.1(HRT)		Mode3.1(HRT)		Mode2.1(HRT)	
Modulation	QPSK		8PSK		QPSK	
Channel coding	RS(255,239)					
CP length used with FFT 512	0	128	0	128	128	0
PHY-SAP payload bit rate	3.119	2.495	4.679	3.743	2.495	3.119
MAC-SAP rate	2.595 <sup>(*)</sup>	2.136 <sup>(*)</sup>	3.593 <sup>(*)</sup>	3.562 <sup>(*)</sup>	1.921 <sup>(*)</sup>	2.321 <sup>(*)</sup>
Required $E_b/N_o$ [dB]	7.2	13.5	11.2	19.1	9.1	6.6
Maximum operating range [m]	<b>24.7</b>	<b>8.4</b>	<b>7.7</b>	<b>2.8</b>	<b>19.8</b>	<b>26.5</b>

(\*) Refer Section 7.1

to "Contents"

# Link budget for each usage model

Usage model	AWGN	UM1				UM5		Unit
Required MAC-SAP	-	1.78		3.65		1.50 & 2.25		Gbps
Channel model	AWGN	CM1.3(LOS residential)	CM2.3(NLOS residential)	CM1.3(LOS residential)	CM2.3(NLOS residential)	CM3.1(LOS office)	CM9.1(Kiosk)	
Target BER or PER	-	BER=10 <sup>-6</sup>				PER=0.08		
Symbol rate		1.664						Gsymbol/s
Transmission mode to realize required MAC-SAP	2.1(HRT)	2.1(HRT)		3.1(HRT)		2.1(HRT)		
Modulation	QPSK	QPSK		8PSK		QPSK		
Channel coding scheme		RS(255, 239)						
Cyclic Prefix length against 512 code length for FDE	0	0	128	0	128	128	0	
PHY-SAP Payload Bit Rate ( $R_b$ )	3.119	3.119	2.495	4.679	3.743	2.495	3.119	Gbps
Average Tx power ( $P_T$ )	10	10	10	10	10	10	10	dBm
Tx antenna gain ( $G_T$ )	15	15	15	15	15	15	15	dBi
Center frequency ( $f_c$ )		60						GHz
Path loss at 1 meter ( $PL_0$ )		68						dB
Rx antenna gain ( $G_R$ )	15	15	15	15	15	15	15	dBi
Average noise power per bit ( $N=-174+10*\log_{10}(R_b)$ )	-79.1	-79.1	-80.0	-77.3	-78.3	-79.1		dBm
Rx Noise Figure Referred to the Antenna Terminal ( $N_F$ )		10						dB
Average noise power per bit ( $P_N=N+N_F$ )	-69.1	-69.1	-70.0	-67.3	-68.3	-69.1		dBm
Required Eb/N0 ( $S$ ) to achieve PER=0.08	6.6	-	-	-	-	*9.1	6.6	
Required Eb/N0 ( $S$ ) to achieve BER=10 <sup>-6</sup>	7.2	7.2	* 13.5	11.2	* 19.1	-	-	dB
Shadowing link margin ( $M_{shadowing}$ )	1	1	5	1	5	1	1	dB
Implementation Loss ( $I$ )		5						dB
Receiver sensitivity ( $P_{th} = S + P_N + M_{shadowing} + I$ )	-55.9	-55.9	-46.5	-50.1	-39.2	-54.0	-56.5	dBm
Tolerable path loss ( $PL = P_T + G_T + G_R - P_N - S - M_{shadowing} - I - PL_0$ )	27.9	27.9	18.5	22.1	11.2	26.0	28.5	dB
<b>Link margin for reference distance (1 m for UM5, 5 m for UM1)</b>	-	<b>20.9</b>	<b>11.5</b>	<b>15.1</b>	<b>4.2</b>	<b>26.0</b>	<b>28.5</b>	<b>dB</b>
<b>Maximum operating range (<math>d = 10^{PL/10n}</math>)</b>	<b>24.7</b>	<b>24.7</b>	<b>8.4</b>	<b>7.7</b>	<b>2.8</b>	<b>19.8</b>	<b>26.5</b>	<b>m</b>

(\*) means FDE is used



## 6.3: Miss detection and false alarm performance of the synchronization versus SNR

( 3<sup>rd</sup> item to be reported for PHY)

### ■ Reference BER performance

- For high-rate transmission (HRT) mode: Mode1.4 (BPSK, RS(255,239)+CC(R=1/2))
- For low-rate transmission (LRT) mode: Mode4.1 (BPSK, RS(255,239), 64 spreading)

# Summary for synchronization performance

- The target probabilities of miss detection and false alarm are set at  $10^{-8}$  against BER threshold of  $10^{-6}$
- The proposed preambles achieve the target probabilities in every mode and channel

## List of miss detection and false alarm probabilities and SNR margin

		AWGN		CM1.3		CM2.3		CM3.1		CM9.1	
		Probability @ required SNR	SNR margin @ $10^{-6}$	Probability @ required SNR	SNR margin @ $10^{-6}$	Probability @ required SNR	SNR margin @ $10^{-6}$	Probability @ required SNR	SNR margin @ $10^{-6}$	Probability @ required SNR	SNR margin @ $10^{-6}$
HRT/ MRT mode	$P_m$	$< 10^{-8}$	7.5 dB	$< 10^{-8}$	7 dB	$< 10^{-8}$	2.7 dB	$< 10^{-8}$	5 dB	$< 10^{-8}$	7.5 dB
	$P_f$	$< 10^{-8}$	9.5 dB	$< 10^{-8}$	8.5 dB	$< 10^{-8}$	8 dB	$< 10^{-8}$	7.5 dB	$< 10^{-8}$	9.5 dB
LRT mode	$P_m$	$< 10^{-8}$	7 dB	$< 10^{-8}$	6.5 dB	$< 10^{-8}$	1.5 dB	$< 10^{-8}$	7 dB	$< 10^{-8}$	7 dB
	$P_f$	$< 10^{-8}$	3.5 dB	$< 10^{-8}$	2.5 dB	$< 10^{-8}$	3 dB	$< 10^{-8}$	4.5 dB	$< 10^{-8}$	3.5 dB

\*  $P_m$  = Miss detection probability,  $P_f$  = False alarm probability  
HRT: High rate transmission, LRT: Low rate transmission

# Definition for synchronization performance

Block diagram of synchronization part

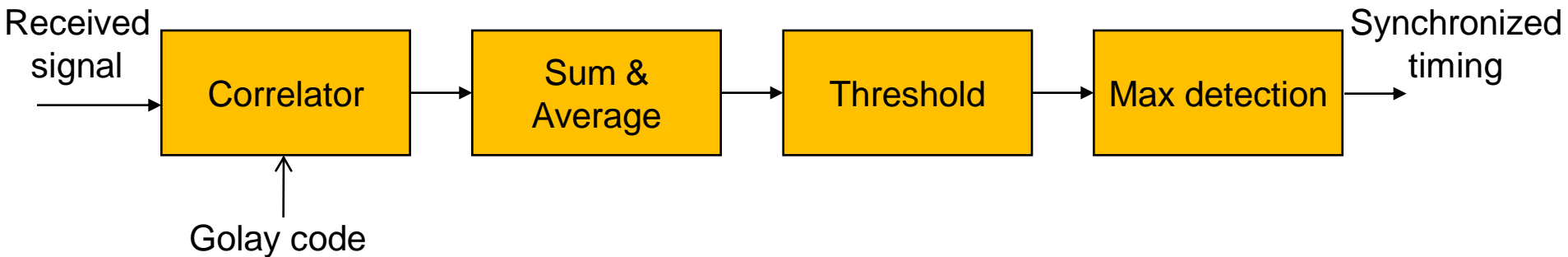

Definition of miss detection and false alarm

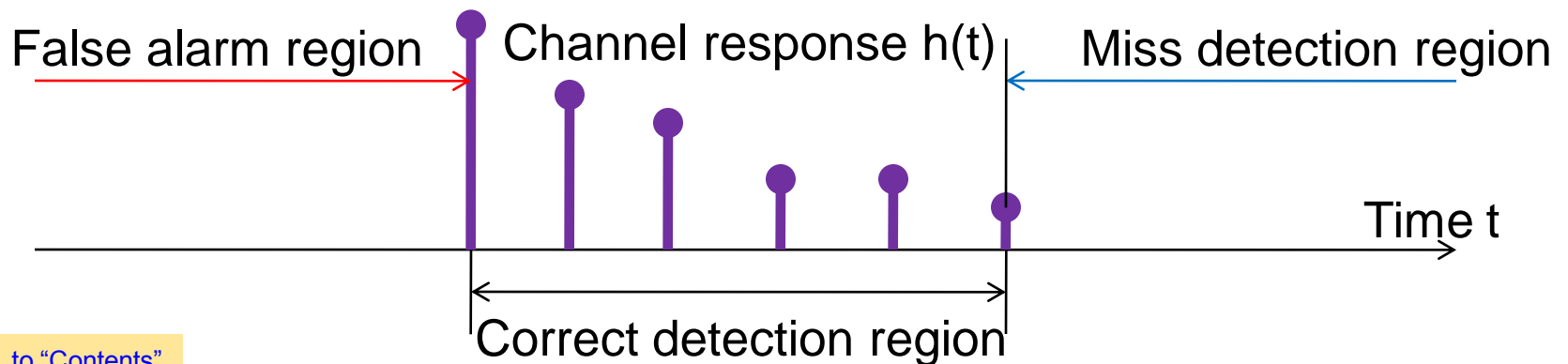

# Parameters for preamble

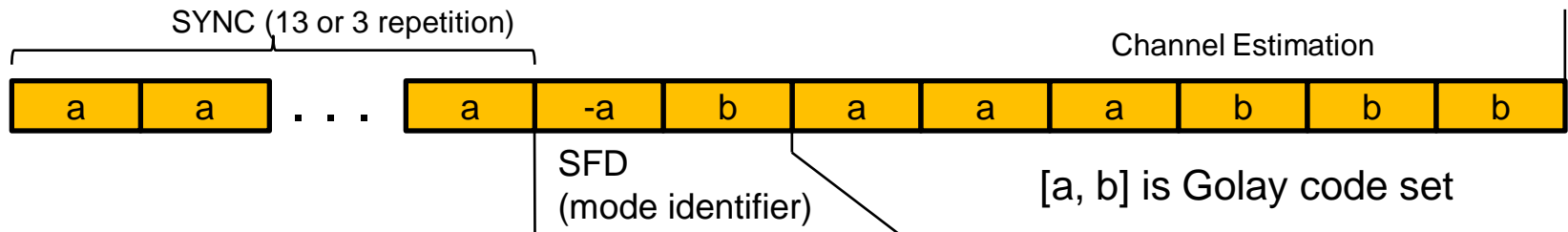

Mode	Symbol rate [Gbps]	SYNC		SFD		CE		Total length	
		Code length $L_s$ [symbols]	# repetitions $N_s$	Code length $L_{sfd}$ [symbols]	# repetitions $N_{sfd}$	Code length $L_{ce}$ [symbols]	# repetitions $N_{ce}$	symbols	nsec
HRT/MRT mode	1.664	128	3	128	2	128	6	1408	846.2
LRT mode	1.664	128	13	128	2	128	6	2688	1615.4

- 1 of 3 and 1 of 13 codes in SYNC are used for AGC and symbol timing recovery in high-rate and low-rate modes, respectively

# Synchronization performance of high-rate transmission mode in AWGN

- 7.5 dB of SNR margin for  $P_m$  against  $10^{-6}$  of the reference BER
- 9.5 dB of SNR margin for  $P_f$  against  $10^{-6}$  of the reference BER

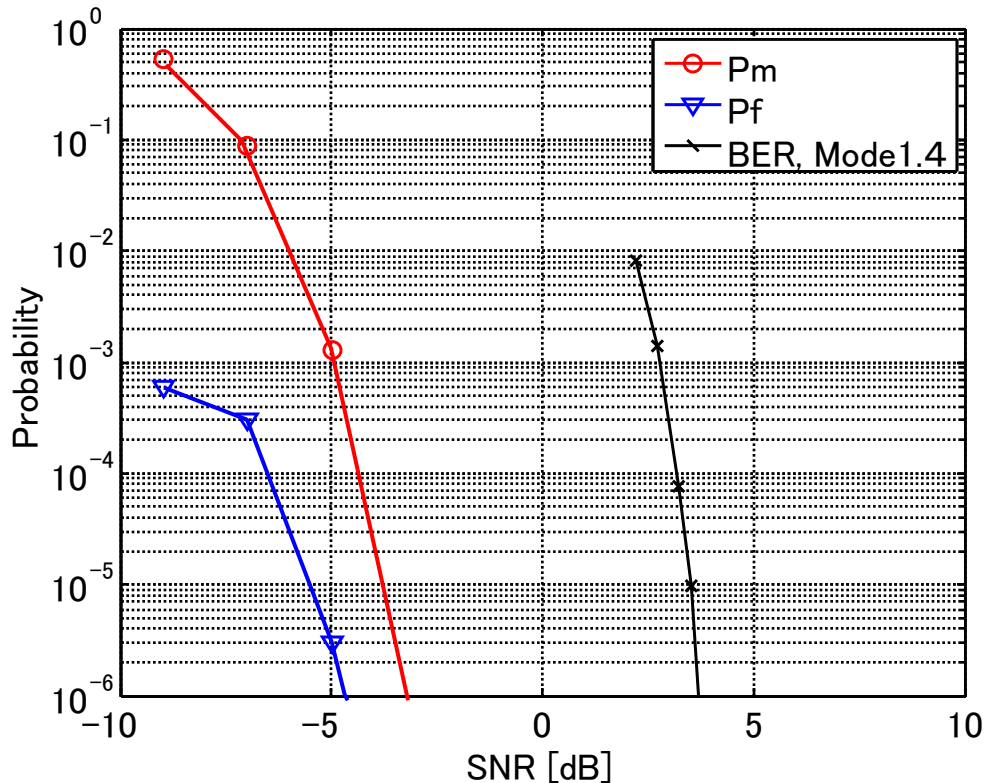

# Synchronization performance of high-rate transmission mode in CM1.3

- 7.0 dB of SNR margin for  $P_m$  against  $10^{-6}$  of the reference BER
- 8.5 dB of SNR margin for  $P_f$  against  $10^{-6}$  of the reference BER

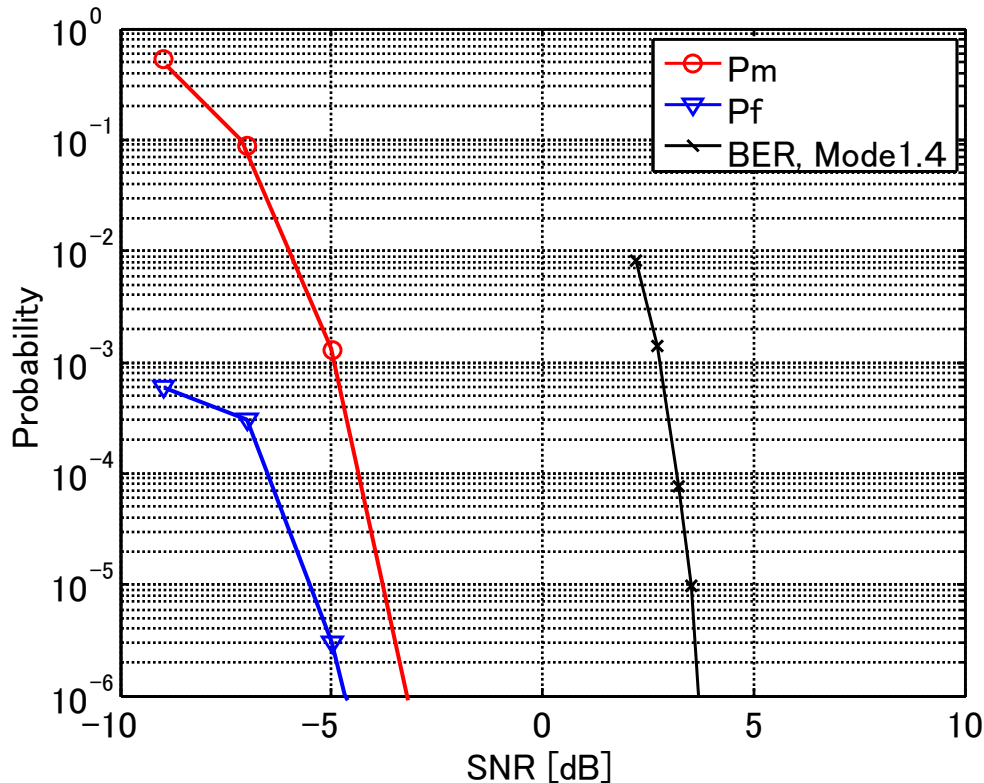

# Synchronization performance of high-rate transmission mode in CM2.3

- 2.7 dB of SNR margin for  $P_m$  against  $10^{-6}$  of the reference BER
- 8.0 dB of SNR margin for  $P_f$  against  $10^{-6}$  of the reference BER

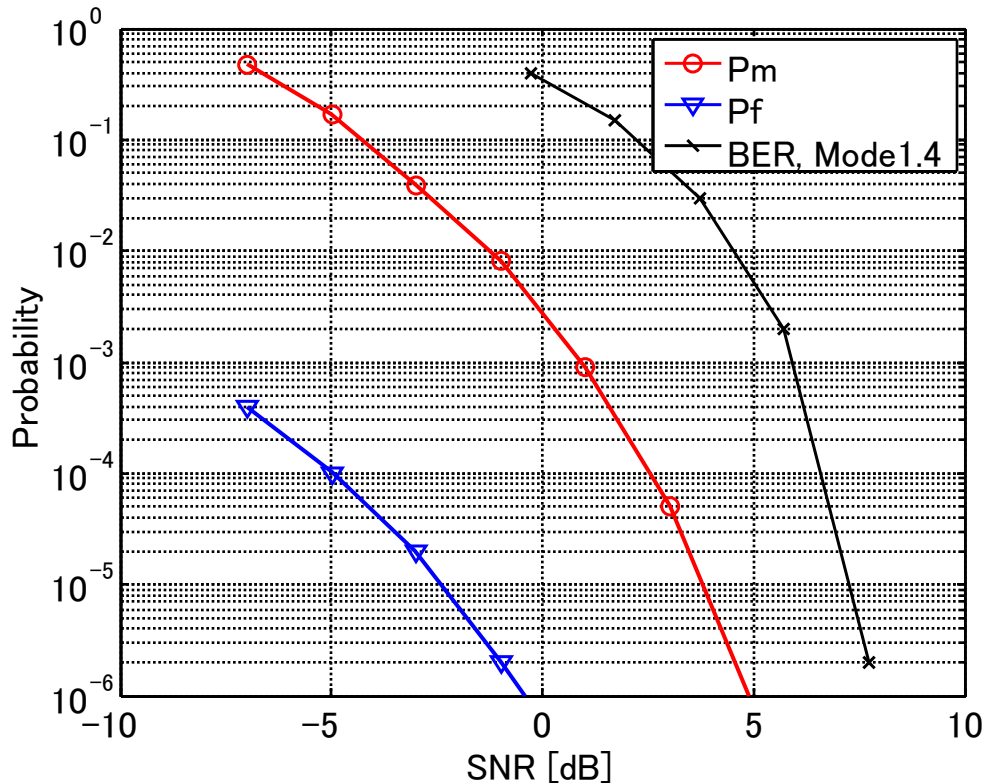

# Synchronization performance of high-rate transmission mode in CM3.1

- 5.0 dB of SNR margin for  $P_m$  against  $10^{-6}$  of the reference BER
- 7.5 dB of SNR margin for  $P_f$  against  $10^{-6}$  of the reference BER

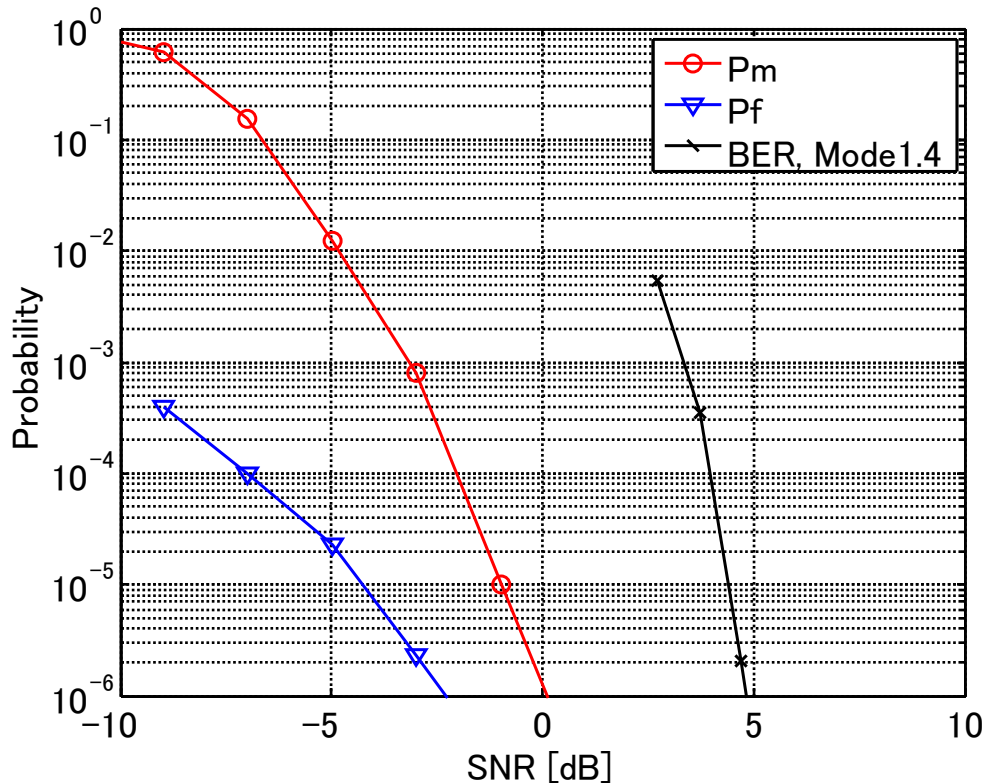



# Synchronization performance of high-rate transmission mode in CM9.1

- 7.5 dB of SNR margin for  $P_m$  against  $10^{-6}$  of the reference BER
- 9.5 dB of SNR margin for  $P_f$  against  $10^{-6}$  of the reference BER

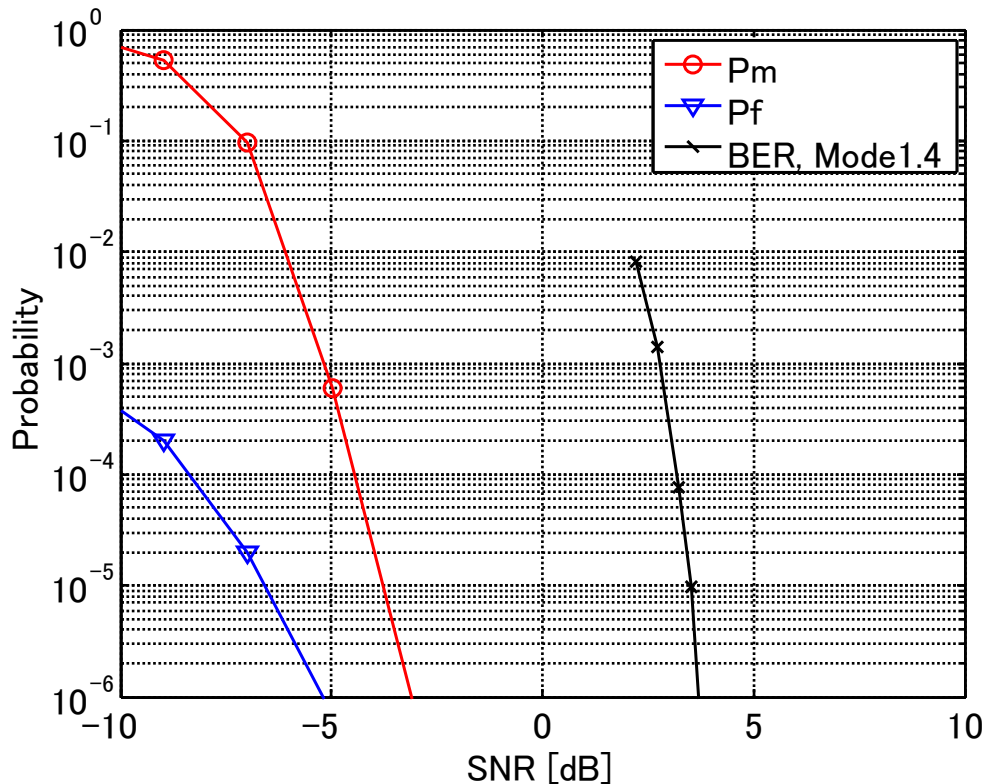

# Synchronization performance of low-rate transmission mode in AWGN

- 7.0 dB of SNR margin for  $P_m$  against  $10^{-6}$  of the reference BER
- 3.5 dB of SNR margin for  $P_f$  against  $10^{-6}$  of the reference BER

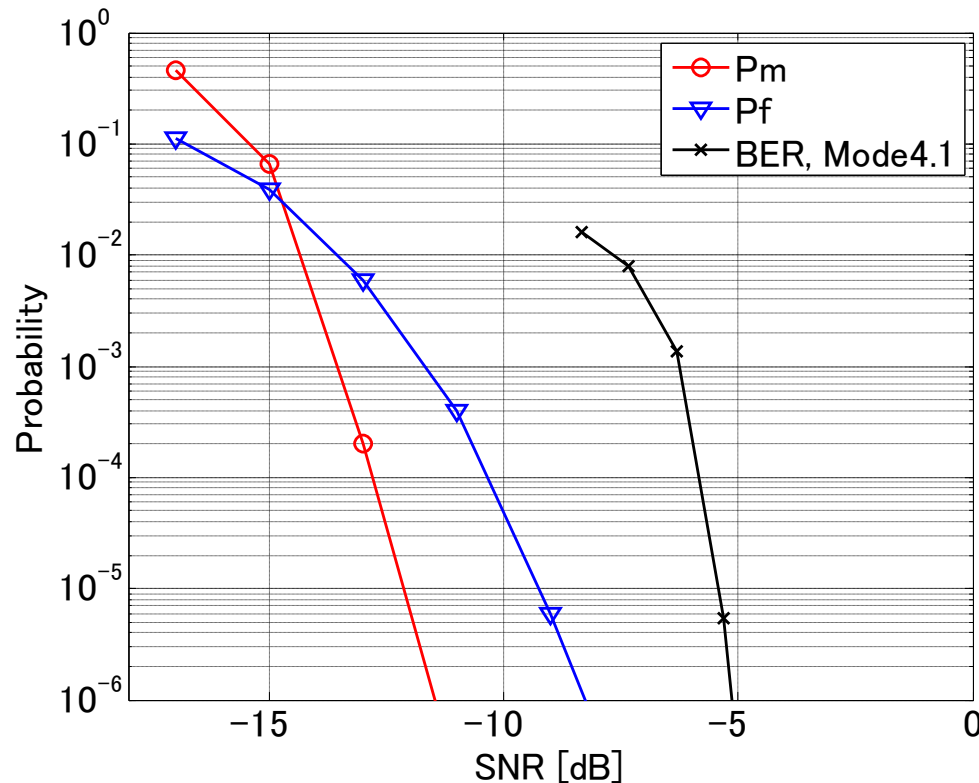

# Synchronization performance of low-rate transmission mode in CM1.3

- 6.5 dB of SNR margin for  $P_m$  against  $10^{-6}$  of the reference BER
- 2.5 dB of SNR margin for  $P_f$  against  $10^{-6}$  of the reference BER

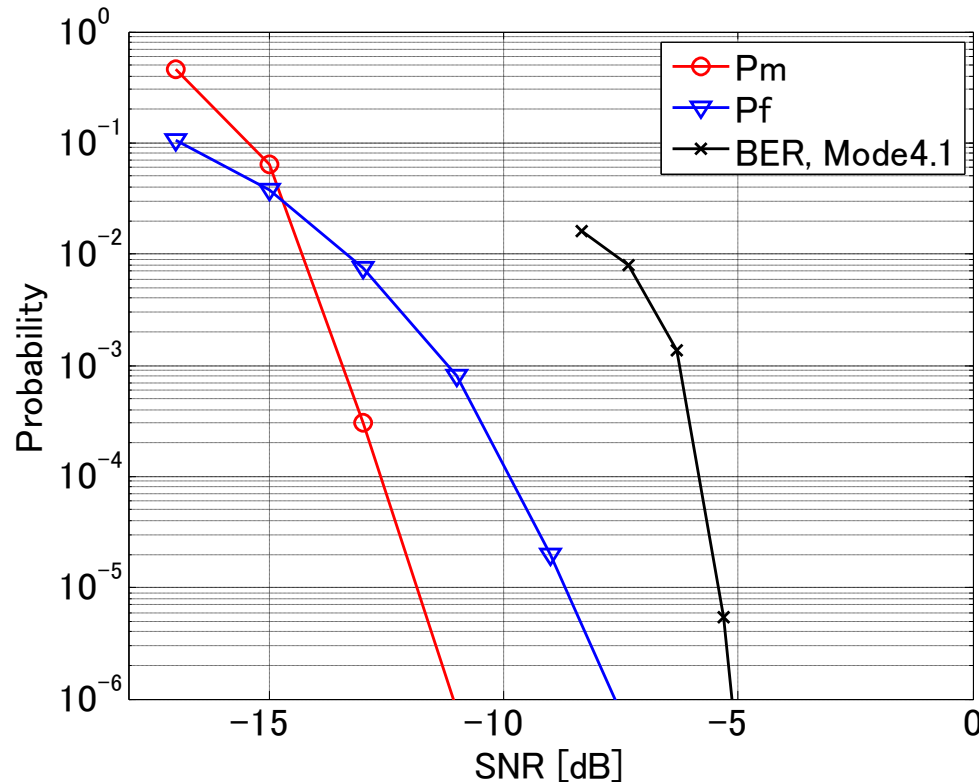

# Synchronization performance of low-rate transmission mode in CM2.3

- 1.5 dB of SNR margin for  $P_m$  against  $10^{-6}$  of the reference BER
- 3.0 dB of SNR margin for  $P_f$  against  $10^{-6}$  of the reference BER

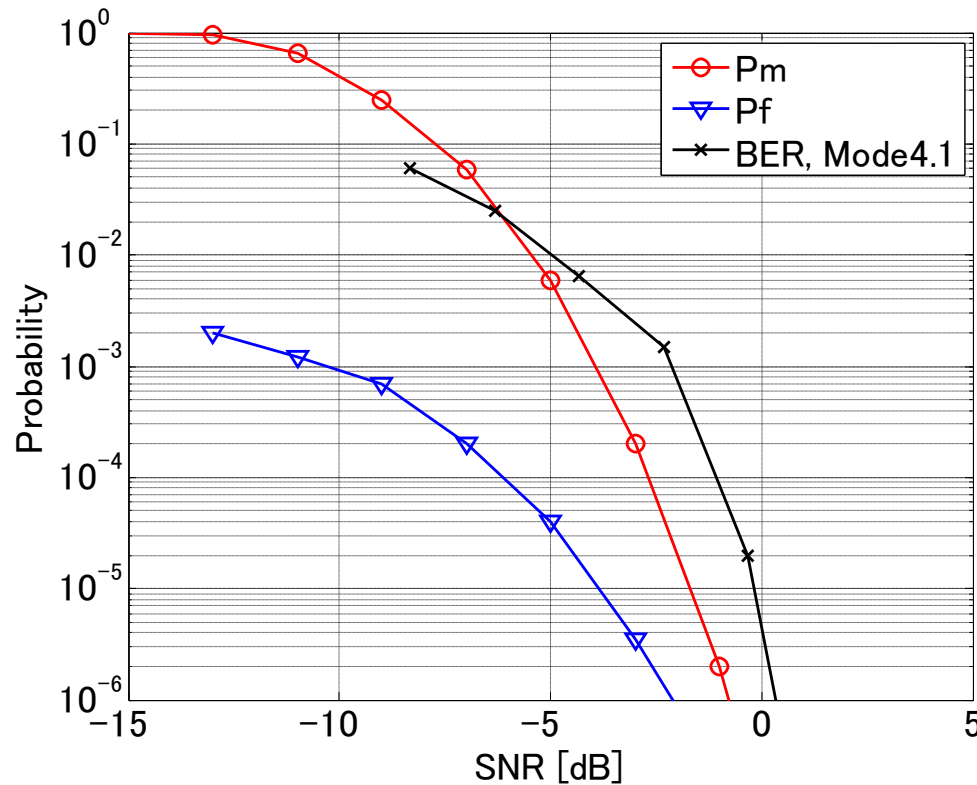

# Synchronization performance of low-rate transmission mode in CM3.1

- 7.0 dB of SNR margin for  $P_m$  against  $10^{-6}$  of the reference BER
- 4.5 dB of SNR margin for  $P_f$  against  $10^{-6}$  of the reference BER

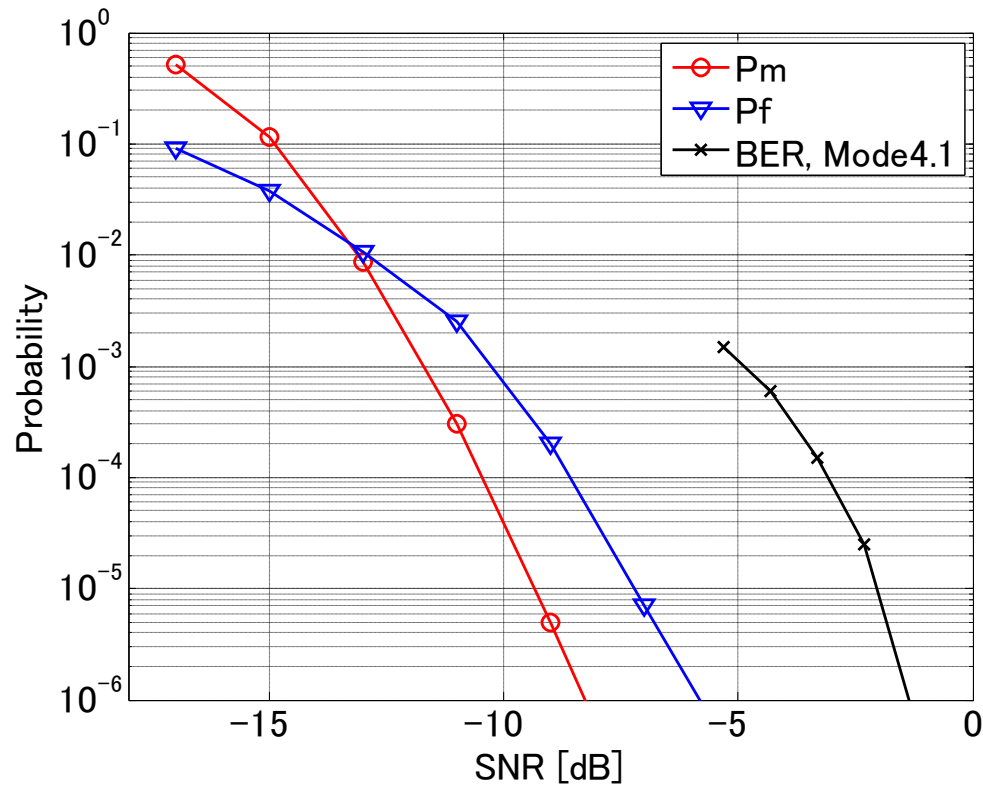

# Synchronization performance of low-rate transmission mode in CM9.1

- 7.0 dB of SNR margin for  $P_m$  against  $10^{-6}$  of the reference BER
- 3.5 dB of SNR margin for  $P_f$  against  $10^{-6}$  of the reference BER

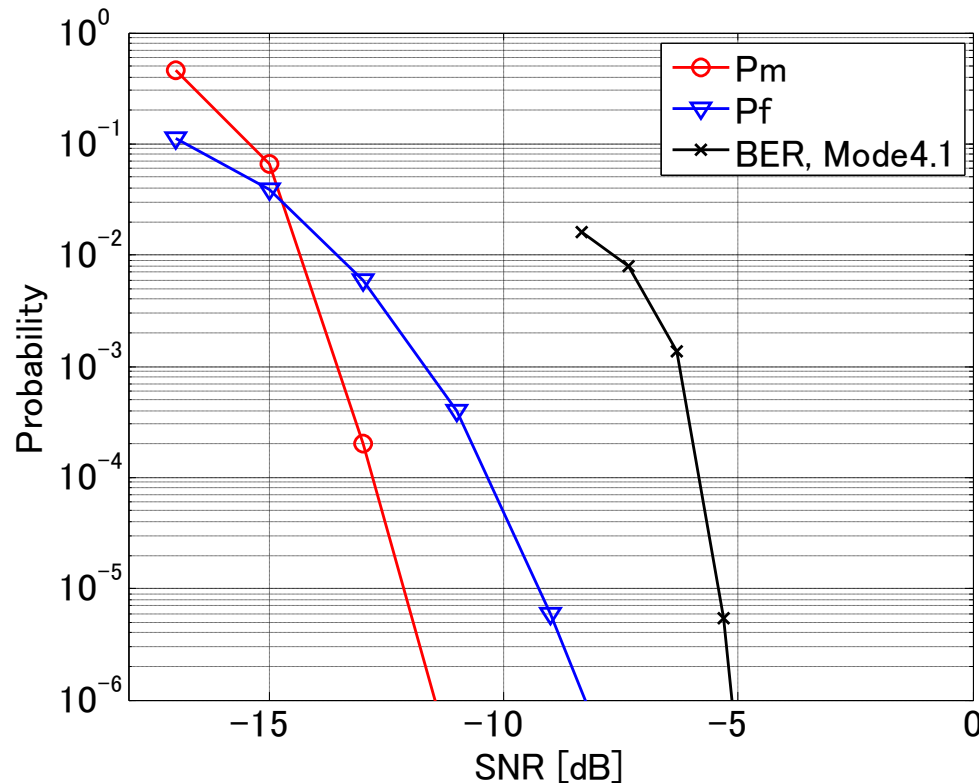

## 6.4: Packet structure parameters ( 4<sup>th</sup> item to be reported for PHY)

# Detailed frame format (before FEC)

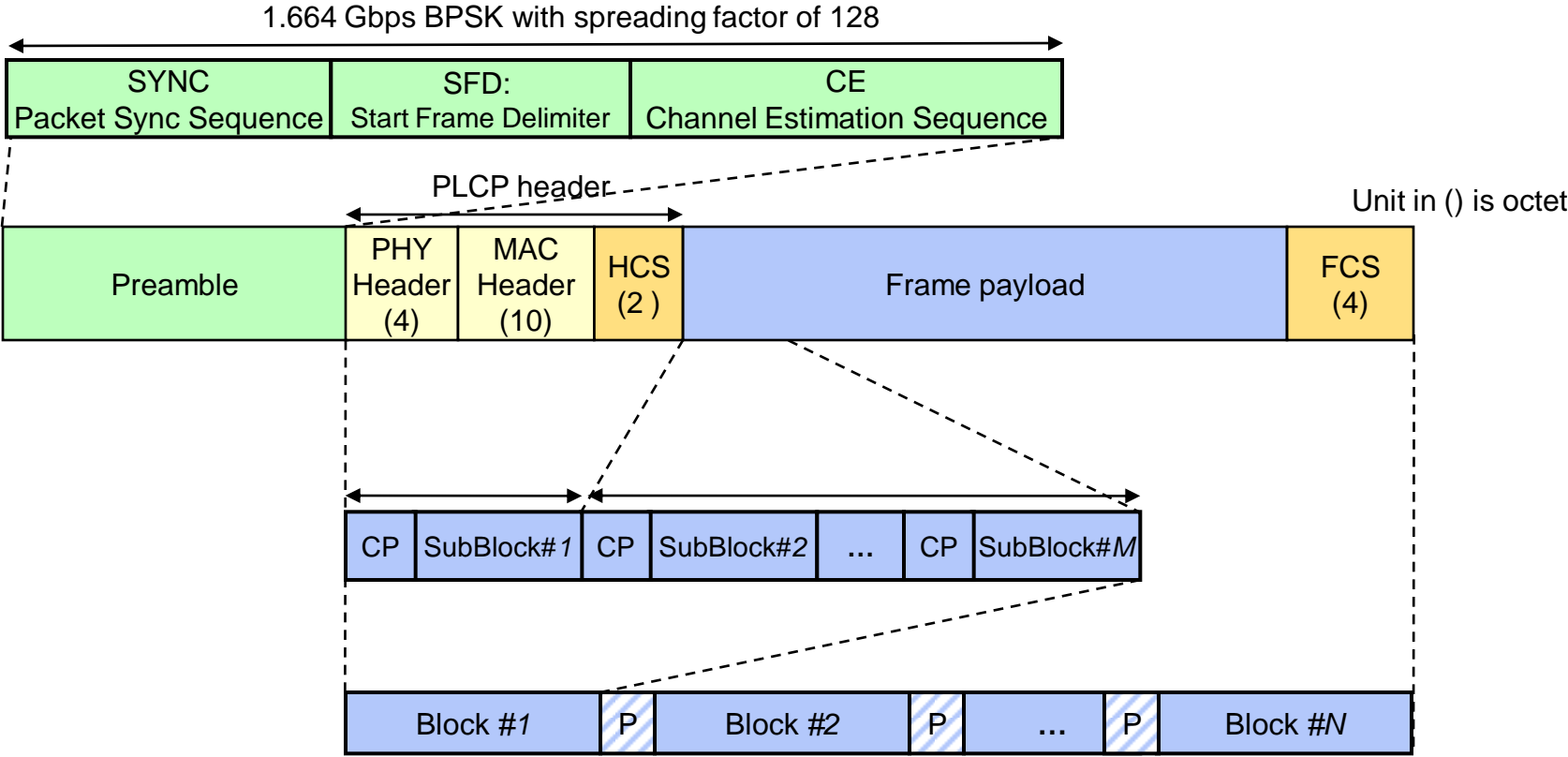

P: Pilot symbols to track drifting clock timing  
CP: Cyclic Prefix



# Major frame format parameters

## ■ Preamble

— Described in [slide 28](#)

## ■ Symbol rate

— Described in [slide 14](#)

## ■ Modulation

— Described in [slide 14~17](#)

## ■ FEC

— Described in [slide 14~17](#)

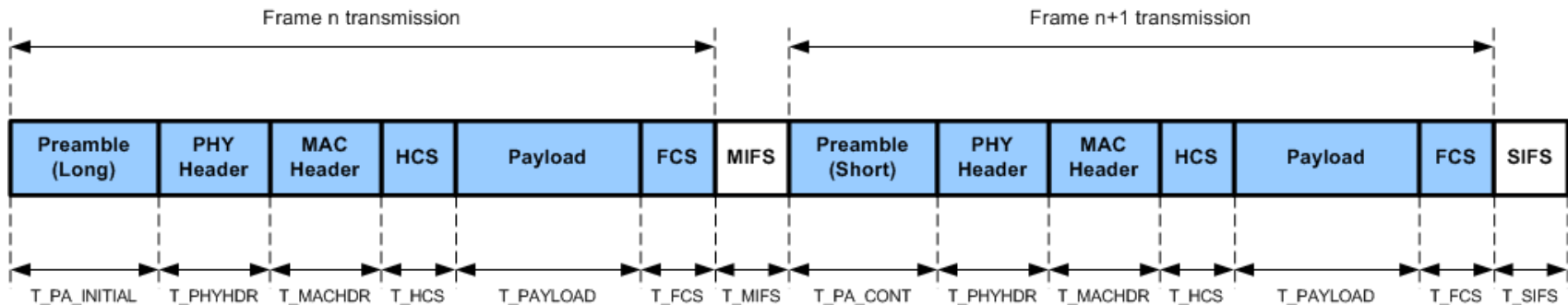

- $T_{PA\_INITIAL}$ : Length of the initial (long) preamble
- $T_{PA\_CONT}$ : Length of the short preamble
- $T_{PHYHDR}$ : Length of the PHY header
- $T_{MACHDR}$ : Length of the MAC header
- $T_{HCS}$ : Length of the header checksum
- $T_{PAYLOAD}$ : Length of the payload
- $T_{FCS}$ : Length of the frame checksum
- $T_{MIFS}$ : Length of the Minimum Inter Frame Space (MIFS)
- $T_{SIFS}$ : Length of the Short Inter Frame Space (SIFS)

Packet overhead is defined here as ...

$$\frac{T_{PA\_INITIAL} + T_{PHYHDR} + T_{MACHDR} + T_{FCS} + T_{HCS}}{T_{PA\_INITIAL} + T_{PHYHDR} + T_{MACHDR} + T_{FCS} + T_{HCS} + T_{PAYLOAD}}$$

Tail bits, staffing bits, pad symbols, and shorting of the last block for RS or LDPC are disregarded for this packet overhead calculation. 2048 byte payload is used for this calculation.

# Packet overhead in each data-rate mode

Mode	CP length [symbol]	PHY – SAP payload bit rate [Gbps]	Period [nsec]									Overhead [%]
			T_PA_INIT IAL	T_PA_CON T	T_PHYHD R	T_MACHD R	T_HCS	T_PAYLOA D	T_FCS	T_MIFS	T_SIFS	
1.1	0	1.560	846.15	846.15	38.46	96.15	19.23	10505.31	20.5	50	2500	8.9
1.1	64	1.386	846.15	846.15	43.27	108.17	21.63	11818.47	23.1	50	2500	8.1
1.1	128	1.248	846.15	846.15	48.08	120.19	24.04	13131.64	25.6	50	2500	7.5
1.2.1	0	1.248	846.15	846.15	38.46	96.15	19.23	13128.21	25.6	50	2500	7.2
1.2.1	64	1.109	846.15	846.15	43.27	108.17	21.63	14769.23	28.8	50	2500	6.6
1.2.1	128	0.998	846.15	846.15	48.08	120.19	24.04	16410.26	32.1	50	2500	6.1
1.2.2	0	0.832	846.15	846.15	38.46	96.15	19.23	19692.31	38.5	50	2500	5.0
1.2.2	64	0.740	846.15	846.15	43.27	108.17	21.63	22153.85	43.3	50	2500	4.6
1.2.2	128	0.666	846.15	846.15	48.08	120.19	24.04	24615.38	48.1	50	2500	4.2
1.3	0	1.170	846.15	846.15	76.92	192.31	38.46	14007.08	27.4	50	2500	7.8
1.3	64	1.040	846.15	846.15	86.54	216.35	43.27	15757.97	30.8	50	2500	7.2
1.3	128	0.936	846.15	846.15	96.15	240.38	48.08	17508.85	34.2	50	2500	6.7
1.4	0	0.780	846.15	846.15	76.92	192.31	38.46	21010.62	41.0	50	2500	5.4
1.4	64	0.693	846.15	846.15	86.54	216.35	43.27	23636.95	46.2	50	2500	5.0
1.4	128	0.624	846.15	846.15	96.15	240.38	48.08	26263.28	51.3	50	2500	4.7

# Packet overhead in each data-rate mode (Cont')

Mode	CP length [symbol]	PHY-SAP payload bit rate [Gbps]	Period [nsec]									Overhead [%]
			T_PA_INITI AL	T_PA_CON T	T_PHYHDR	T_MACHDR	T_HCS	T_PAYLOA D	T_FCS	T_MIFS	T_SIFS	
2.1	0	3.119	846.15	846.15	38.46	96.15	19.23	5252.66	10.3	50	2500	16.1
2.1	64	2.773	846.15	846.15	43.27	108.17	21.63	5909.24	11.5	50	2500	14.9
2.1	128	2.495	846.15	846.15	48.08	120.19	24.04	6565.82	12.8	50	2500	13.8
*2.2.1	0	3.106	846.15	846.15	38.46	96.15	19.23	5274.73	10.3	50	2500	16.1
*2.2.1	64	2.761	846.15	846.15	43.27	108.17	21.63	5934.07	11.6	50	2500	14.8
*2.2.1	128	2.485	846.15	846.15	48.08	120.19	24.04	6593.41	12.9	50	2500	13.8
2.2.1	0	2.912	846.15	846.15	38.46	96.15	19.23	5626.37	11.0	50	2500	15.2
2.2.1	64	2.588	846.15	846.15	43.27	108.17	21.63	6329.67	12.4	50	2500	14.0
2.2.1	128	2.330	846.15	846.15	48.08	120.19	24.04	7032.97	13.7	50	2500	13.0
2.2.2	0	2.496	846.15	846.15	38.46	96.15	19.23	6564.10	12.8	50	2500	13.4
2.2.2	64	2.219	846.15	846.15	43.27	108.17	21.63	7384.62	14.4	50	2500	12.3
2.2.2	128	1.997	846.15	846.15	48.08	120.19	24.04	8205.13	16.0	50	2500	11.4
2.2.3	0	1.664	846.15	846.15	76.92	192.31	38.46	9846.15	19.2	50	2500	9.4
2.2.3	64	1.479	846.15	846.15	86.54	216.35	43.27	11076.92	21.6	50	2500	8.6
2.2.3	128	1.331	846.15	846.15	96.15	240.38	48.08	12307.69	24.0	50	2500	7.9
2.3	0	2.339	846.15	846.15	76.92	192.31	38.46	7003.54	13.7	50	2500	14.3
2.3	64	2.079	846.15	846.15	86.54	216.35	43.27	7878.98	15.4	50	2500	13.3
2.3	128	1.872	846.15	846.15	96.15	240.38	48.08	8754.43	17.1	50	2500	12.5
2.4	0	1.560	846.15	846.15	76.92	192.31	38.46	10505.31	20.5	50	2500	10.1
2.4	64	1.386	846.15	846.15	86.54	216.35	43.27	11818.47	23.1	50	2500	9.3
2.4	128	1.248	846.15	846.15	96.15	240.38	48.08	13131.64	25.6	50	2500	8.7

\* For LDPC (1440,1344)

[to "Contents"](#)

# Packet overhead in each data-rate mode (Cont')

Mode	CP length [symbol]	PHY-SAP payload bit rate [Gbps]	Period [nsec]									Overhead [%]
			T_PA_INITIA L	T_PA_CONT	T_PHYHDR	T_MACHDR	T_HCS	T_PAYLOAD	T_FCS	T_MIFS	T_SIFS	
3.1	0	4.679	846.15	846.15	38.46	96.15	19.23	3501.77	6.8	50	2500	22.3
3.1	64	4.159	846.15	846.15	43.27	108.17	21.63	3939.49	7.7	50	2500	20.7
3.1	128	3.743	846.15	846.15	48.08	120.19	24.04	4377.21	8.5	50	2500	19.3
3.2	0	4.659	846.15	846.15	38.46	96.15	19.23	3516.48	6.9	50	2500	22.3
3.2	64	4.142	846.15	846.15	43.27	108.17	21.63	3956.04	7.7	50	2500	20.6
3.2	128	3.727	846.15	846.15	48.08	120.19	24.04	4395.60	8.6	50	2500	19.2
4.1	0	0.049	1615.38	1615.38	1230.77	3076.92	615.38	336169.94	656.6	50	2500	0.7
4.2	0	0.097	1615.38	1615.38	615.38	1538.46	307.69	168084.97	328.3	50	2500	1.2

## 7. Items to be reported for MAC

- **MAC SAP throughput for UM1 is analyzed as following for basic and extended**
  - **1.78 Gbps@MAC-SAP**
    - QPSK with RS coding achieves 2.595Gbps (LOS)
    - QPSK with RS coding (with FDE, CP=128) achieves 2.136Gbps (NLOS)
    - No-Ack mode
    - Length of payload = 2048 octets
  - **3.56 Gbps@MAC-SAP**
    - 8PSK with RS coding achieves 3.593Gbps (LOS)
    - 8PSK with RS coding (with FDE, CP=128) achieves 3.560Gbps (NLOS) with frame expansion.
    - No-Ack mode
    - Length of payload = 2048(LOS), 10008(NLOS) octets
- **MAC SAP throughput for UM5 is analyzed as following for basic and extended**
  - **1.50 Gbps@MAC-SAP**
    - QPSK with RS coding achieves 2.321Gbps(LOS)
    - Dly-Ack mode
    - Length of payload = 2048 octets
  - **2.25 Gbps@MAC-SAP**
    - QPSK with RS coding achieves 2.321Gbps (LOS)
    - Dly-Ack mode
    - Length of payload = 2048 octets
- **CoMPA MAC proposal meets all system requirements**

1. Throughput analysis for the UM1 scenario, including Character Error Rate (CER) analysis
2. Throughput analysis for the UM5 scenario
3. The ARQ method (if used) and packet aggregation parameters (if used)
4. Assumed durations of Inter-frame spaces
5. PHY mode assumed
6. Frame size
7. CAP duration
8. Preamble types used (if different)
9. Super frame size and guard interval duration



# Definition of ‘data throughput’

- Data throughput definition in 05/493r27 (‘Selection criteria’) is used for throughput analysis for No-ACK and Dly-ACK cases

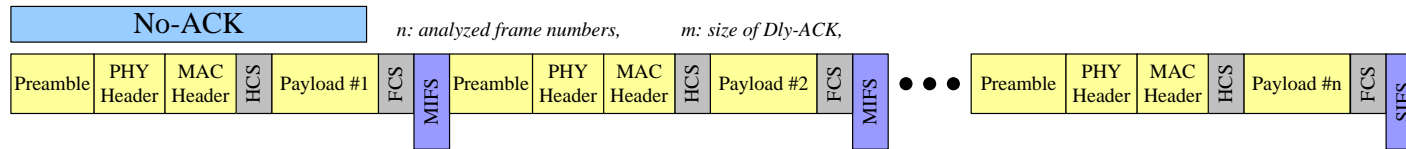

$$Data\_throughput\_No\_ACK = n \times Payload\_bits /$$

$$[n \times (T\_preamble + T\_MACHDR + T\_PHYHDR + T\_HCS + T\_Payload + T\_FCS) + (n-1) \times T\_MIFS + T\_SIFS]$$

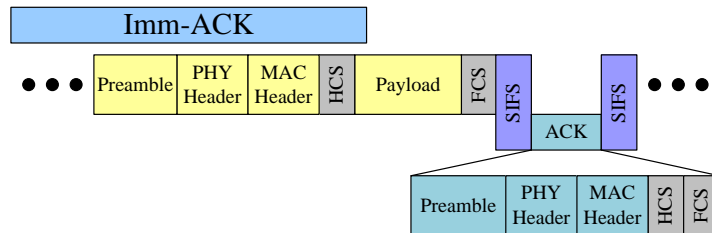

$$Data\_throughput\_Dly\_ACK = Payload\_bits /$$

$$[T\_Payload + 2 \times (T\_preamble + T\_MACHDR + T\_PHYHDR + T\_HCS + T\_FCS) + 2 \times T\_SIFS]$$

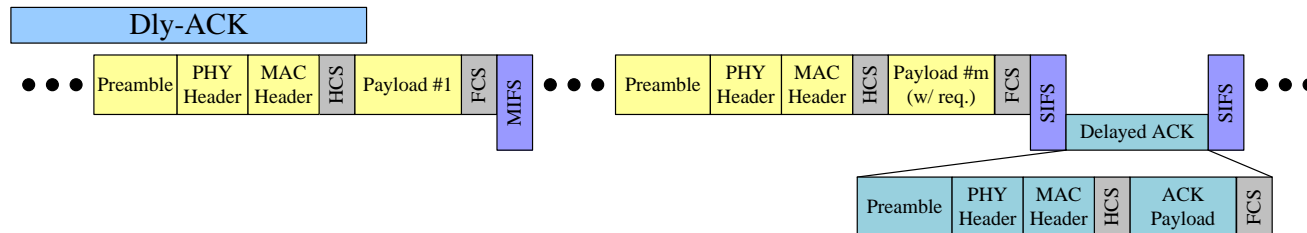

$$Data\_throughput\_Dly\_ACK = (m \times Payload\_bits) /$$

$$[m \times (T\_preamble + T\_MACHDR + T\_PHYHDR + T\_HCS + T\_Payload + T\_FCS) + (m-1) \times T\_MIFS + 2 \times T\_SIFS + T\_Dly\_ACK]$$

[to ‘Contents’](#)

## 7.1: Throughput analysis for the UM1 scenario, including Character Error Rate (CER) analysis

- Throughput analysis for the UM1 scenario is shown in the table below

	Requirement	LOS	NLOS
UM1	1.78Gbps	Data Throughput =2.595Gbps (QPSK with RS (255,239))	Data Throughput =2.136Gbps (QPSK with RS (255,239) (CP=128))
	3.56Gbps	Data Throughput=3.593Gbps (8PSK with RS (255,239))	Data Throughput =3.560Gbps (8PSK with RS (255,239) (CP=128))

- Assumptions
  - No-ACK for data transmission
  - Imm-ACK for channel allocation
- Since CER according to PiER of  $10^{-9}$  or BER of  $10^{-10}$  causes very low FER, data throughput is calculated assuming no frame error

## 7.2: Throughput analysis for the UM5 scenario

- Throughput analysis for the UM5 scenario is shown in the table below

	Requirement	LOS	NLOS
UM5	1.50Gbps	Data Throughput =2.321Gbps (QPSK with RS (255,239))	
	2.25Gbps	Data Throughput =2.321Gbps (QPSK with RS (255,239))	

- Assumptions
  - Dly-ACK for data transmission
  - Imm-ACK for channel allocation
  - Size of ‘Dly-ACK’ is 16 in the analysis
- For analysis simplification, ‘8% of FER’ is translated to 108% transmission instead of 100% transmission

## ■ ARQ

- Go-Back-N( $N \geq 1$ ) is assumed as ARQ method
- No-ACK is employed in UM1
- Dly-ACK is employed in UM5

## ■ Packet aggregation

- Expanded payload up to 10k octet is used for throughput analysis by expanding 16bit-frame-length-field in PHY header (up to 65k octet is possible)
- MSDU aggregation or MPDU aggregation is also available

## ■ Following durations are assumed

### — SIFS: 2.5 $\mu\text{s}$

- SIFS is the length of time that PHY to switch between transmit and receive
- Determined by following signal processing durations with 100% margin for implementation
  - ✓ Equalization: 0.4 $\mu\text{s}$
  - ✓ LDPC decoding: 0.85 $\mu\text{s}$

### — MIFS: 0.05 $\mu\text{s}$

- MIFS is the length of time required for PHY either between successive transmissions or successive reception

■ Assumed PHY modes:

		LOS	NLOS
UM1	1.78Gbps	QPSK with RS (PHY-SAP TR=3.119Gbps)	QPSK with RS or LDPC +FDE (CP=128) (PHY-SAP TR=2.495Gbps)
	3.56Gbps	8PSK with RS (PHY-SAP TR=4.679Gbps)	8PSK with RS or LDPC +FDE (CP=128) (PHY-SAP TR=3.743Gbps)
UM5	1.50Gbps	QPSK with RS (PHY-SAP TR=3.119Gbps)	/
	2.25Gbps	QPSK with RS (PHY-SAP TR=3.119Gbps)	

## 7.6: Frame size

### Assumed Frame size:

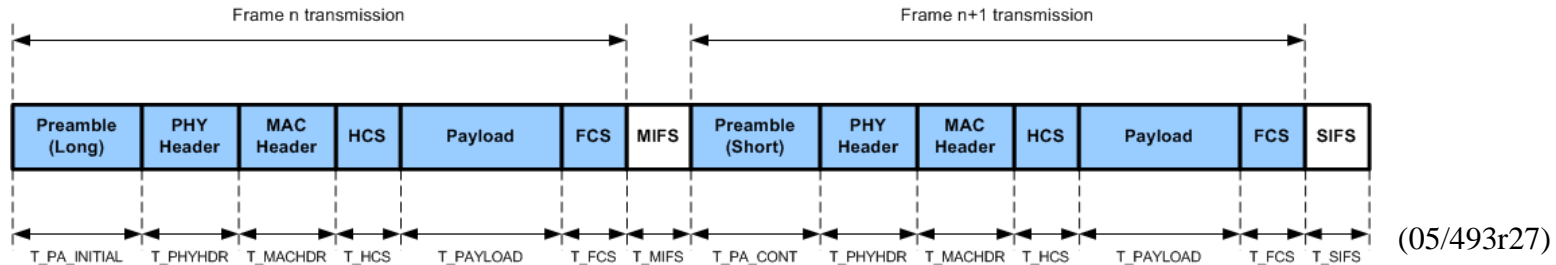

			T_PA_INITIAL/ T_PA_CONT (ns)	T_PHYHDR (ns)	T_MACHDR (ns)	T_HCS (ns)	T_PAYLOAD (ns)	T_FCS (ns)	Frame size (ns)
UM1	1.78Gbps, LOS	QPSK with RS (PHY-SAP TR=3.119Gbps)	846.15	38.46	96.15	19.23	5252.97	10.26	6263.22
	1.78Gbps, NLOS	QPSK with RS or LDPC +FDE (CP=128) (PHY-SAP TR=2.495Gbps)	846.15	48.05	120.12	24.02	6566.73	12.83	7617.9
	3.56Gbps, LOS	8PSK with RS (PHY-SAP TR=4.679Gbps)	846.15	38.46	96.15	19.23	3501.6	6.84	4508.43
	3.56Gbps, NLOS	8PSK with RS or LDPC +FDE (CP=128) (PHY-SAP TR=3.743Gbps)	846.15	48.05	120.12	24.02	21390.33	8.55	22428.67
UM5	1.50Gbps, LOS	QPSK with RS (PHY-SAP TR=3.119Gbps)	846.15	38.46	96.15	19.23	5252.97	10.26	6263.22
	2.25Gbps, LOS	QPSK with RS (PHY-SAP TR=3.119Gbps)	846.15	38.46	96.15	19.23	5252.97	10.26	6263.22

- In UM1-3.56Gbps-NLOS case, frame expansion 10008 octets payload is employed (If MSDU aggregation is used, 5frames aggregation for 10240octets needed for 3.564Gbps throughput)

[to "Contents"](#)

- 2048 octets payload is employed for all others

## 7.7: CAP duration

- A CAP duration of  $300\mu\text{s}$  is assumed (for ADD frame, long CAP may be required)

## 7.8: Preamble types used (if different)

- Same preamble as in ‘7.6: Frame size (the just previous slide)’ is employed



## 7.9: Superframe size and guard interval duration

### - Superframe size -

- Two superframes are defined
  - For beacon period and time slot assignment
    - 1- 20 ms
  - For Automatic Device Discovery
    - Multi-superframe

## 7.9: Superframe size and guard interval duration

### - Guard interval duration -

- Guard interval duration is proposed as following

- GuardTime =  $1\mu\text{s}$

Assumption:

- GuardTime =  $(\text{Beacon\_missing\_times} * 2 + 2) \times \text{MaxDrift}$   
=  $1\mu\text{s}$

- MaxDrift = Clock accuracy (ppm) /  $10^6$  \* Superframe length

- ✓ MaxDrift =  $5(\text{ppm, assumed as } 1-5) / 10^6 * 20\text{ms} = 100\text{ ns}$

- 4 is assumed for Beacon\_missing\_times

## 8. Other items to be reported in “System requirements” and “Selection criteria” documents

## Items 4.2, 4.3.1, 4.3.2, 4.3.3, 6.1, 6.3, 6.7, 6.8, 6.9

- 4.3 Technical feasibility
  - 4.3.1 Manufacturability
    - See from Slide 109
  - 4.3.2 Time to Market
    - 90nm/65nm CMOS process are available now
    - Conventional packaging technology (eg. Flip-Chip) are ready to mass-produce
  - 4.3.3 Regulatory impact
    - Proposal can meet the US, JP, Canada, Korea regulations
  - 6.1 Size and form factor
    - [<sup>\*1</sup>] Fully integrated RF front-end on commercialized CMOS processes have been demonstrated
  - 6.7 Sensitivity for HRT mode (2.1:QPSK with RS(255, 239))
    - For 1.78 Gbps MAC-SAP throughput in UM1: < -54 dBm
    - For 1.5 Gbps MAC-SAP throughput in UM5: < -56 dBm
  - 6.8 Power Management modes
    - All 802.15.3b power management modes are supported
  - 6.9 Antenna practicality
    - Moderate gain antennas are very small
    - [<sup>\*2</sup>] 15 dBi Gain can be created with size of 35 mm<sup>2</sup>
- [<sup>\*1</sup>] S. Emami, C. Doan, A. Niknejad, and R. Brodersen, "A 60-GHz CMOS Fron-End Receiver," ISSCC'07, S10.2
- [<sup>\*2</sup>] H. Tanaka, T. Ohira, "Beam-steerable Planar Array Antennas Using Varactor Diodes for 60-GHz-band Applications," 33rd European Microwave Conference, pp.1067-1070

- UM5 (Kiosk) device that we promote can be implemented on CMOS
- $P_{\text{sat}}$  might be approximately 10 dBm in case of 90nm CMOS

**Reference:**

*T. Yao, et al., "Algorithmic Design of CMOS LNAs and PAs for 60 GHz Radio", IEEE Solid-State Circuits, Vol. 42, No. 5, May 2007*

- Phase shift keying modulation is one of appropriate choices for CMOS
- By integrating all the circuit blocks into CMOS, unnecessary interconnections can be eliminated, which results in less power consumption and lower cost



**Low cost with CMOS**

# CMOS RF Examples

## ■ CMOS Receiver

- *Razavi, “A 60GHz CMOS Receiver Front-End”, IEEE J. Solid-State Circuits, Vol. 41, No.1, January 2006*
  - Voltage Gain 28 dB
  - Noise Figure 12.5 dB
  - 1-dB Compression Point -22.5 dBm
  - Power Dissipation 9 mW
  - Supply Voltage 1.2 V
  - Active Area 300um x 400um
  - Technology 0.13-um CMOS

## ■ CMOS PA

- *T. Yao, et al. “Algorithmic Design of CMOS LNAs and PAs for 60-GHz Radio”, IEEE J. Solid-State Circuits, Vol.42, No.5 May 2007*
  - Frequency 60 GHz
  - Psat +9.3 dBm
  - Gain 5.2 dB
  - Current 26.5 mA (1.5 V)
  - Technology 90 nm CMOS

## ■ CMOS Prescaler

- *C. Lee, et al, “44 GHz Dual-Modulus Divide-by-4/5 Prescaler in 90 nm CMOS Technology”, IEEE CICC, 2006*
  - Frequency Range 38.7G ~ 44 GHz
  - Power Dissipation 45mW, (1.2V)

# Summary of CoMPA PHY proposal

- **Channelization**
  - 2080MHz bandwidth/ch, 4ch/9GHz bandwidth
- **Mandatory Features: 2Gbps@PHY-SAP**
  - Single Carrier (SC) modulation (QPSK) with Reed Solomon (RS) coding (with frequency domain equalizer (FDE) for NLOS environments)
- **Optional Features: 3Gbps@PHY-SAP**
  - SC modulation (8PSK or TC8PSK) with RS coding or LDPC (with FDE for NLOS environments)
- **Three transmission modes are supported**
  - High rate transmission mode (HRT)
  - Medium rate transmission mode (MRT)
  - Low rate transmission mode (LRT)
- **Flexible standard to support multiple PHY**
  - Support co-existence of multiple PHYs and interference avoidance among the PHY networks with different channel plans
- **CoMPA PHY proposal meets all system requirements**