

# AI/ML for communication assisted sensing in 802.11 networks

Date: 2023-04-24

Authors:

<b>Name</b>	<b>Affiliations</b>	<b>Address</b>	<b>Phone</b>	<b>email</b>
Francesca Meneghello	University of Padova	Via Gradenigo 6/b, Padova, 35131 Italy	207-331-2378	fr.meneghello@northeastern.edu
Francesco Restuccia	Northeastern University	360 Huntington Ave, Boston, MA 02215 USA	617-373-3655	frestuc@northeastern.edu

# Outline

- Communication assisted sensing in 802.11
- The role of AI/ML
- Application examples
- Technical challenges and transformations

# Communication assisted sensing

- IEEE 802.11bf will not define algorithms for sensing → left to implementation and open to research

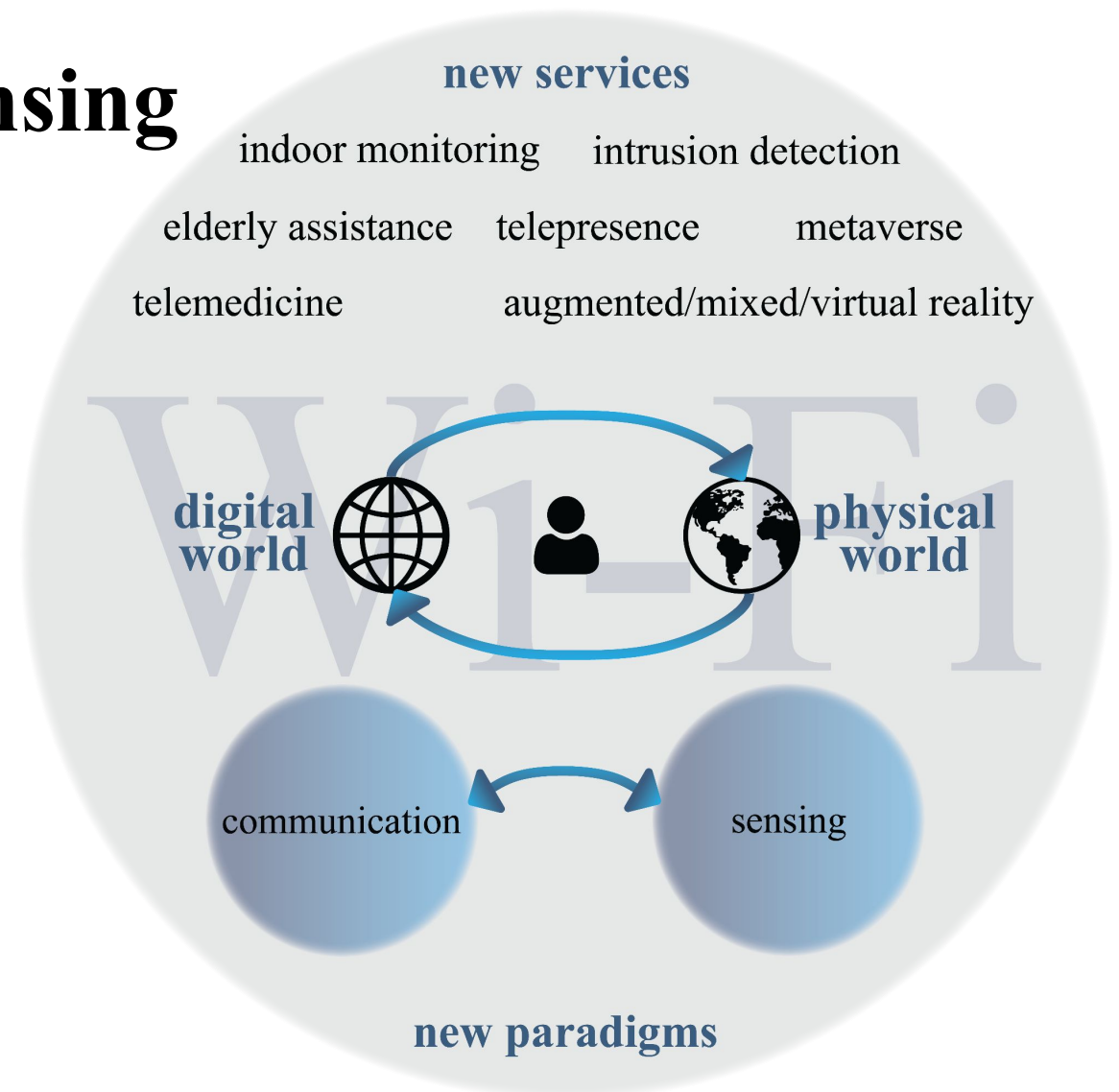

# The role of AI/ML

- Complexity sensing tasks
- Complexity of radio signal propagation (multi-path)
- High amount of channel data to be processed
- Plug and play algorithms

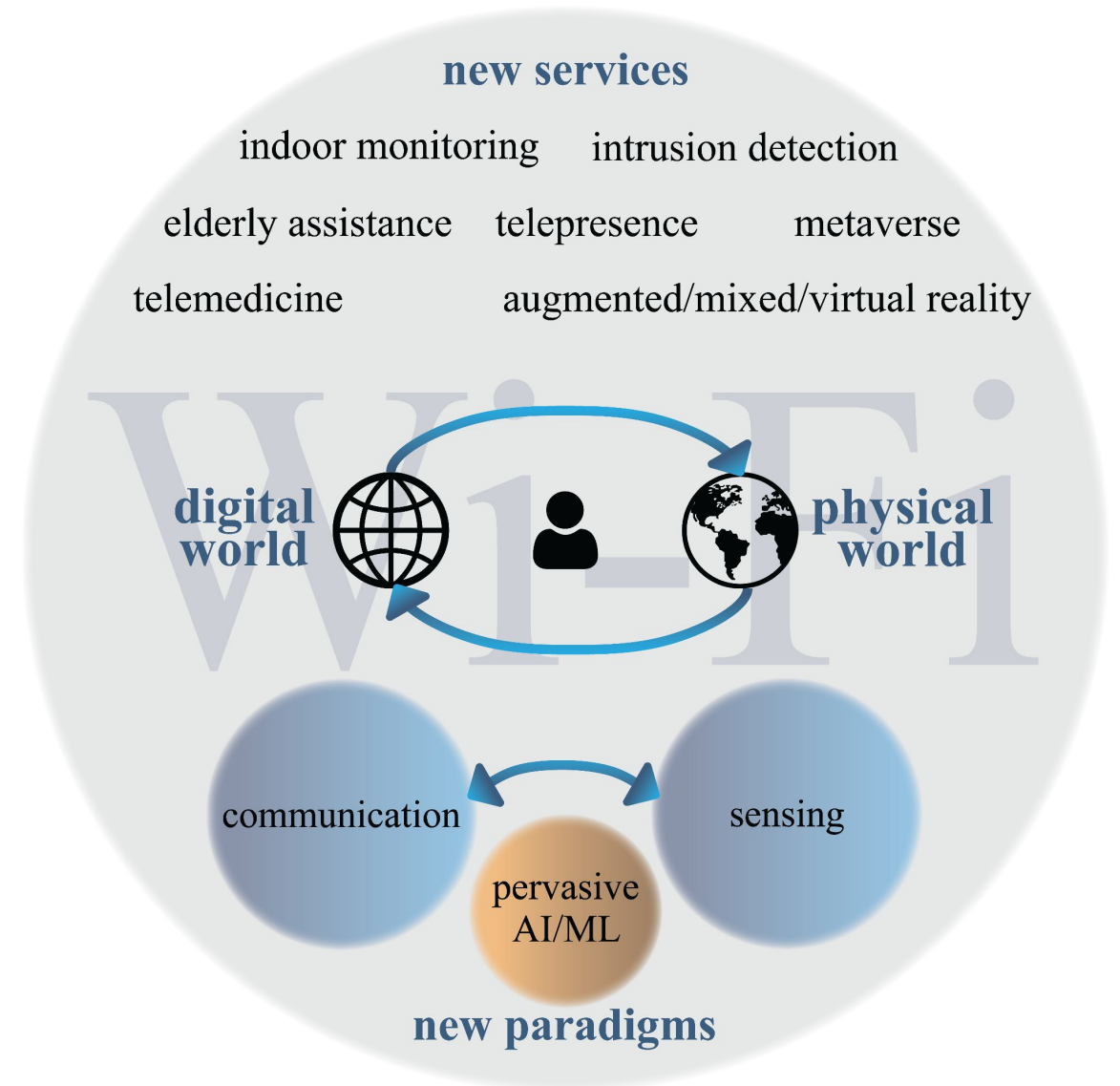

## Examples of application - key observations

The **channel frequency response (CFR)** is affected by

- the presence of obstacles – fixed and moving objects and people – in the environment → **SHARP**
- TX / RX hardware imperfections → **DeepCSI**

**AI/ML algorithms can be used to capture and classify those features**

## Examples of application - 1/2

F. Meneghello, D. Garlisi, N. Dal Fabbro, I. Tinnirello and M. Rossi,  
“**SHARP**: Environment and Person Independent Activity Recognition  
with Commodity IEEE 802.11 Access Points”

**IEEE Transactions on Mobile Computing 2022**

**Objective:** environment/people independent human activity recognition through 802.11 routers  
**SHARP main idea:** leverage the Doppler effect to remove the contributions of static obstacles

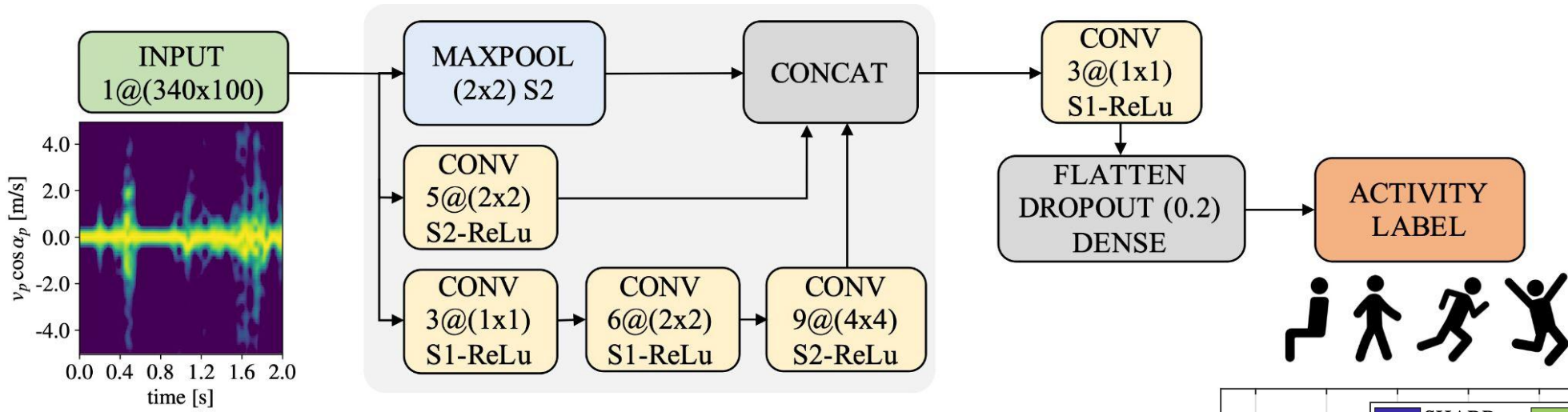

**AI/ML challenge:**  
 The CFR from commercial devices is affected by a phase offset

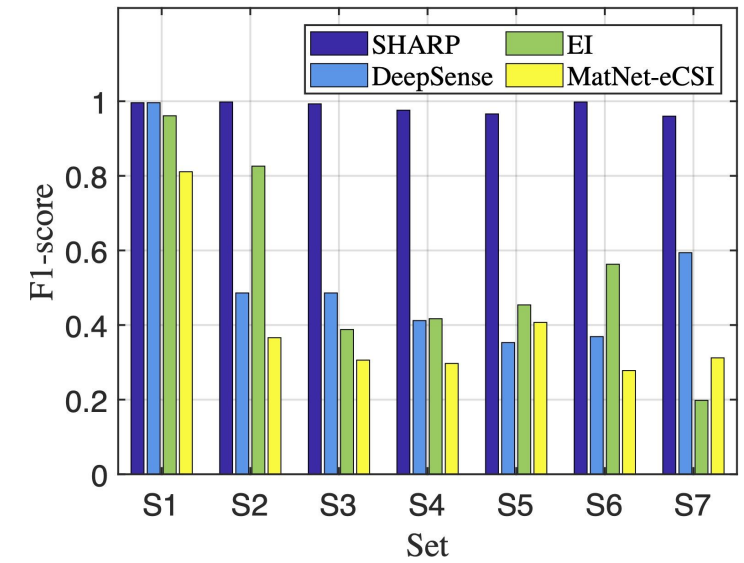
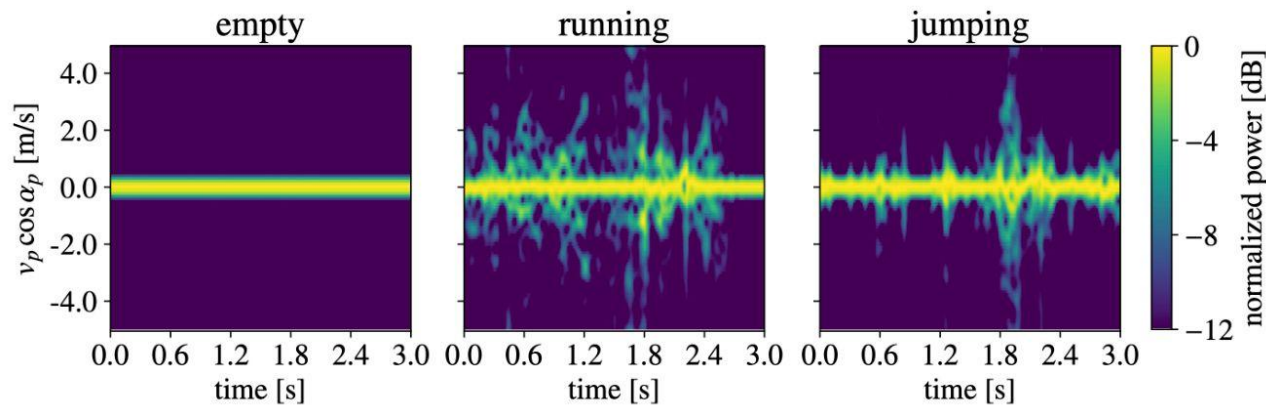

## Examples of application - 2/2

F. Meneghello, M. Rossi and F. Restuccia,

“**DeepCSI**: Rethinking Wi-Fi Radio Fingerprinting Through  
MU-MIMO CSI Feedback Deep Learning”

**IEEE ICDCS 2022**



**Objective:** obtain a **fingerprint of the beamformer** for device authentication

**DeepCSI main idea:** circuitry imperfections percolate onto the standard compliant 802.11 beamforming feedback

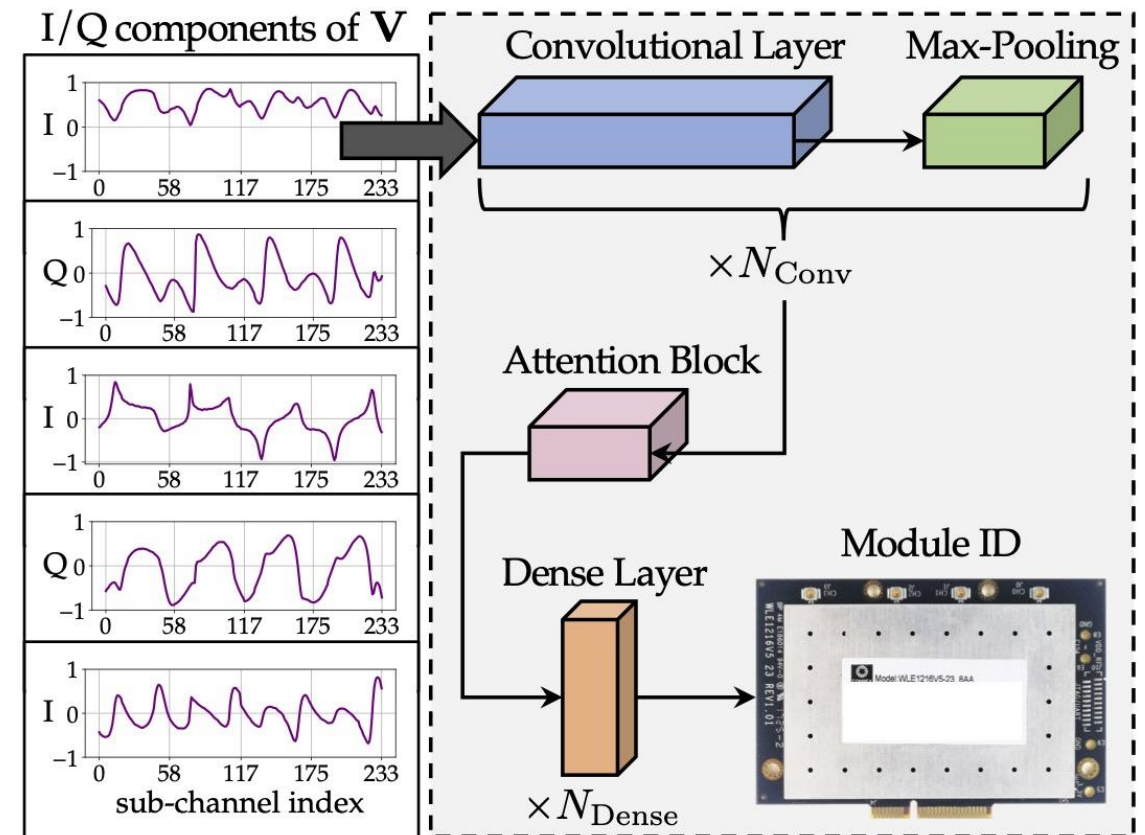
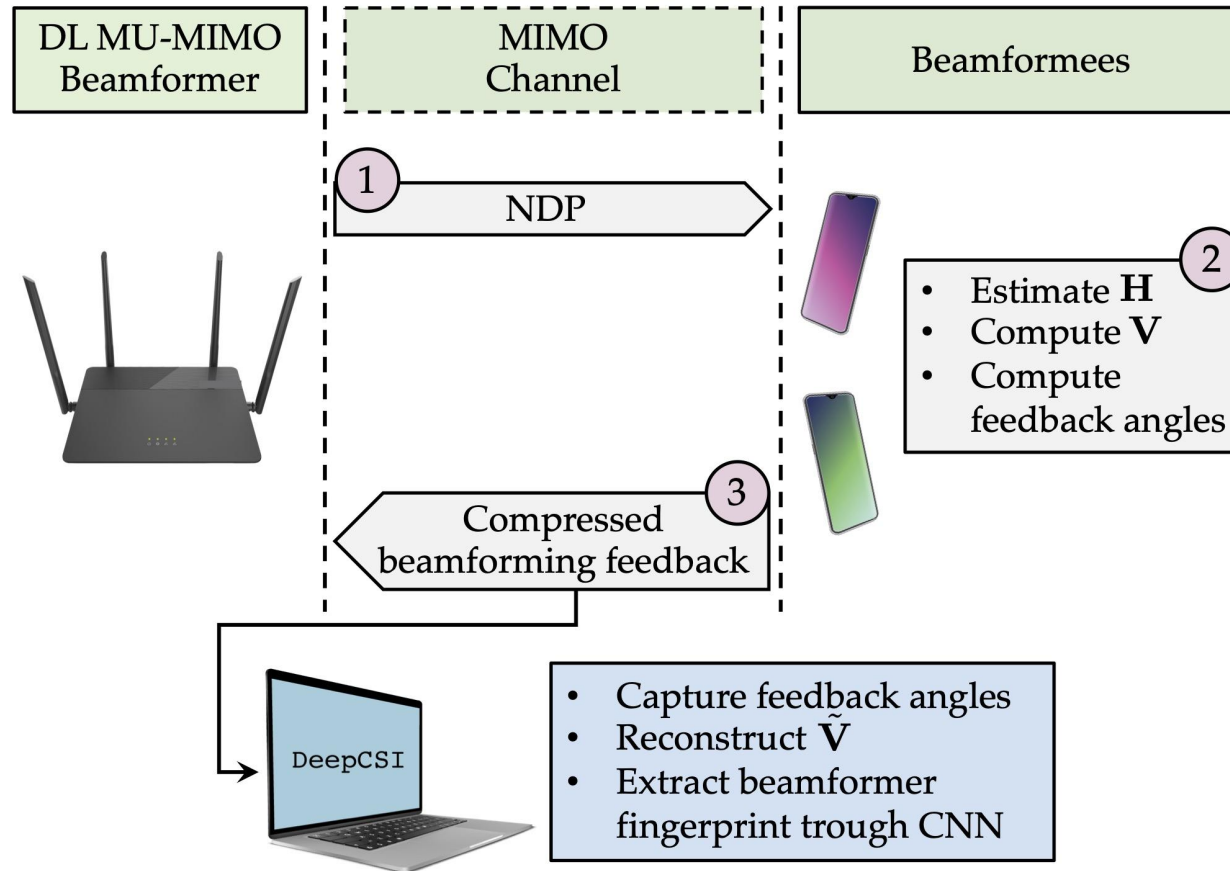

**AI/ML challenge:** The quantization of the 802.11 beamforming feedback affects the performance of the ML algorithm

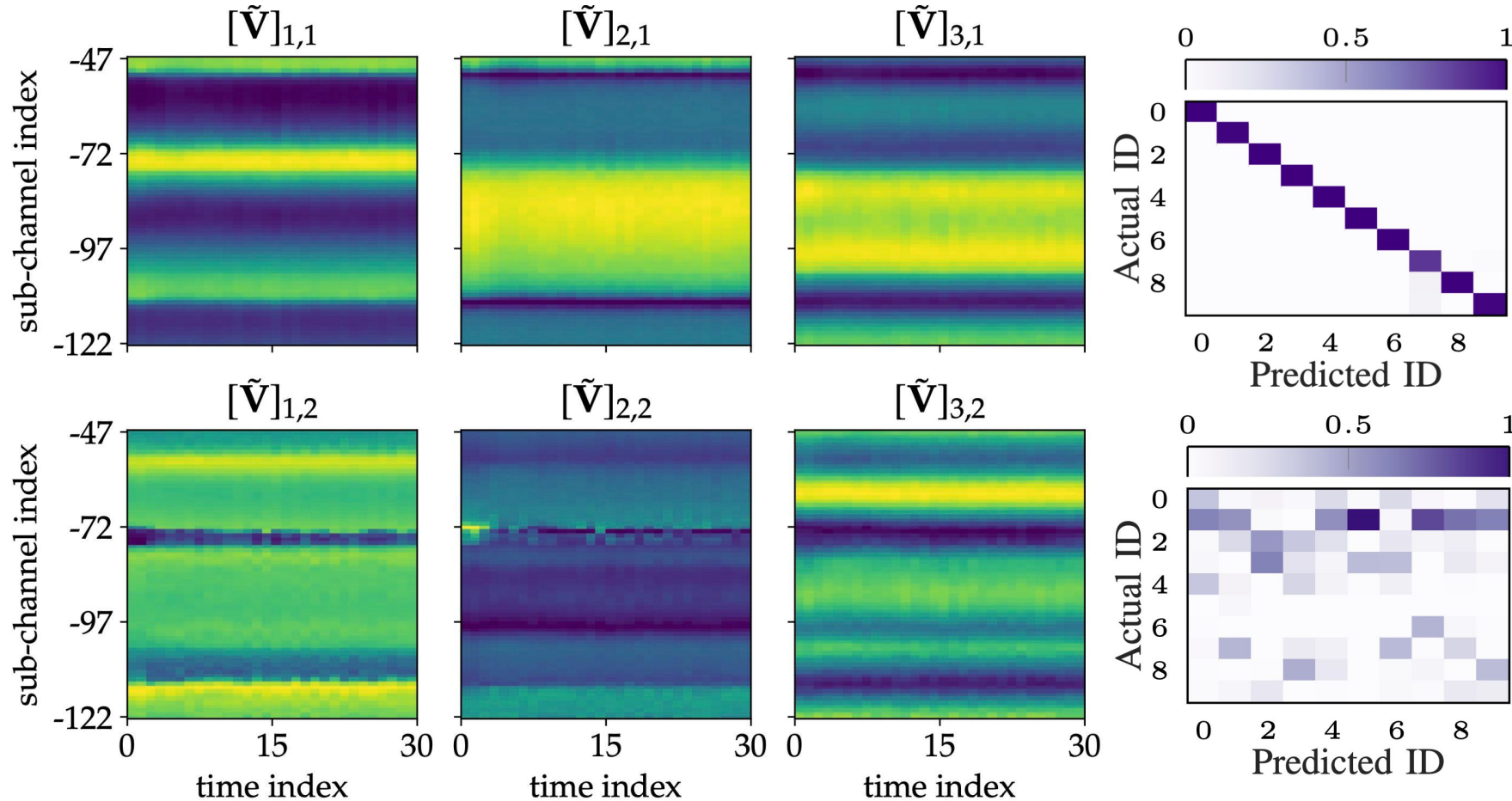

CFR and ML identification performance **first stream**

CFR and ML identification performance **second stream**

# Technical challenges

- How to design AI/ML algorithms that are **robust to undesired hardware imperfections** (CFR offsets)?
- How to obtain a **tradeoff** between the efficiency of feedback transmission and the accuracy of the AI/ML sensing algorithms?

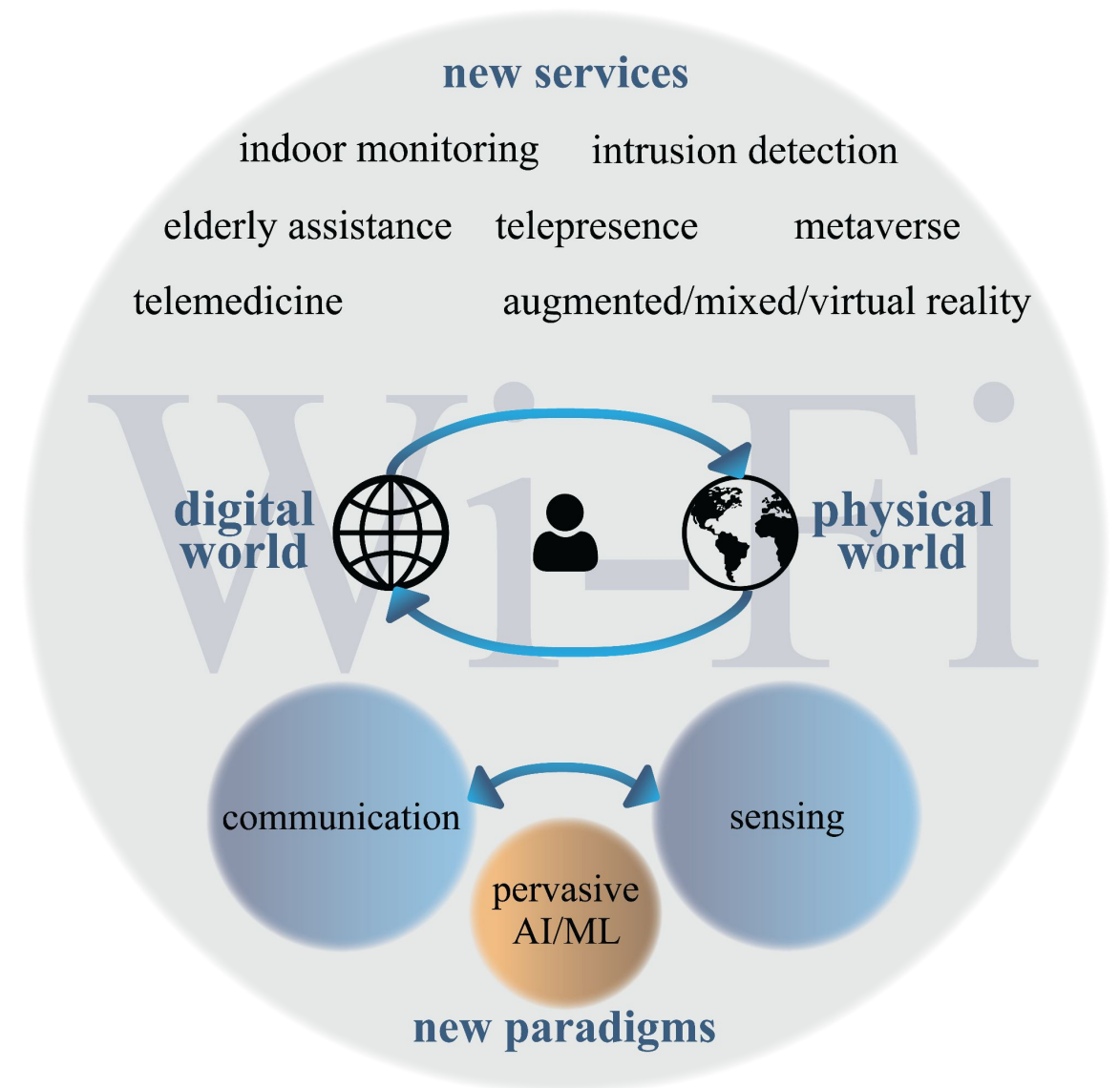

# Technical transformations

Need to consider the **AI/ML requirements for accurate and robust sensing algorithms** within the 802.11 protocol design.

Ideas:

- **transmit reference CFR data** to correct (when needed) phase offsets due to hardware imperfections
- regularly (but sparsely) **transmit uncompressed CFR feedback** for sensing purposes that can be also used to calibrate compressed feedback

**Thanks!**  
**Questions?**