

# IEEE 802 Standards on Light Communication

Date: 2023-03-13

Authors:

Name	Affiliations	Address	Phone	email
Volker Jungnickel	Fraunhofer HHI	Einsteinufer 37, 10587 Berlin	+49 162 255 2756	volker.jungnickel@hhi.fraunhofer.de
Lennert Bober				bober@ieee.org
Tuncer Baykas	Ofinno			tbaykas@ieee.org
Nikola Serfimovski	pureLiFi			nikola.serafimovski@purelifi.com
San-Kyu Lim	ETRI			sklim@etri.re.kr

## Abstract

**IEEE 802 recently finished new standards for optical wireless communications. 802.15.13 introduced a new MAC and two PHY layers enabling high reliability, low latency, and low power transmission for industrial wireless applications, and 802.11bb defines how to reuse the 802.11 MAC and OFDM-based PHYs over optical links, aiming at large-volume applications e.g., in enterprise and home scenarios. The tutorial presents major use cases, technical solutions, and recent technology demos in a variety of applications.**

## Disclaimer

**This presentation should be considered as the personal views of the presenters not as a formal position, explanation, or interpretation of IEEE.**

**Per IEEE-SA Standards Board Bylaws, August 2020:** *At lectures, symposia, seminars, or educational courses, an individual presenting information on IEEE standards shall make it clear that his or her views should be considered the personal views of that individual rather than the formal position of IEEE.*

# Outline

- **What is Light Communication?**
- **IEEE P802.15.13**
- **IEEE P802.11bb**
- **Technology demos**
- **Summary**

- **What is LC?**
- Other LC standards

# What is Light Communication?

## Key facts

- **Mobile communication by using light**
- **Mobile, bidirectional, high-speed data**
- **Complementary to RF**

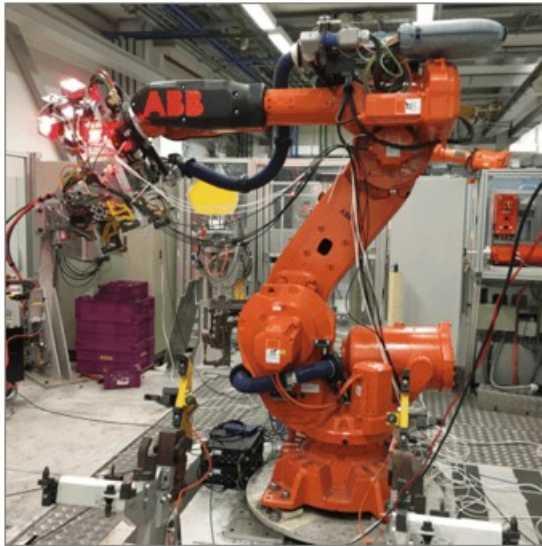

## Unique selling points

- **Higher capacity/area in small “hotspots”**
  - 1...10 Mbps/m<sup>2</sup> (Wi-Fi 6...7), >100 Mbps/m<sup>2</sup> (LC)
- **High service quality: guaranteed delivery at low latency**
  - robust against jamming
  - deterministic channel access

## Strategic use

- **RF is already mature and well established**
  - has issues in dense scenarios
- **LC adds new value to RF**
  - important synergies, both indoors and outdoors
- **Hybrid RF and LC is better than each technology alone**

- What is LC?
- Other LC standards

# LC is useful where RF has limitations

## Defence & Environment

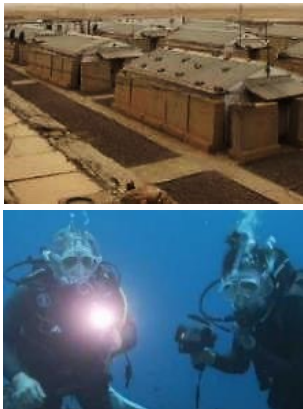

Field command  
Secure comms  
Harsh enviro  
Underwater

## Data & Industrial



Data centres  
Industry 4.0  
IoT sensors  
Safe enviro

## Office & Commercial



Smart building  
Secure comms  
Dense network  
Net offload

## Retail & Financial



Indoor location  
Shop analytics  
Payments  
Back office

## Smart City & Transport



Smart city  
Smart transport  
Streetlights  
Backhaul

## Consumer & Lifestyle



Mobile devices  
Smart home  
Entertainment  
Lighting

# LC domains

- Light allows connectivity over various distances
- Ultra short range
  - inter-chip interconnects, in-body networks
- **Short-range**
  - optical WLAN, in-flight, car-to-X, indoor positioning, industrial wireless
- Medium-/long range
  - inter-building, mobile backhaul, underwater
- Ultra-long range
  - satellite feeder links, satellite-to-satellite



- What is LC?
- Other LC standards

# Taxonomy of LC

Differences types of light communications have different applications.

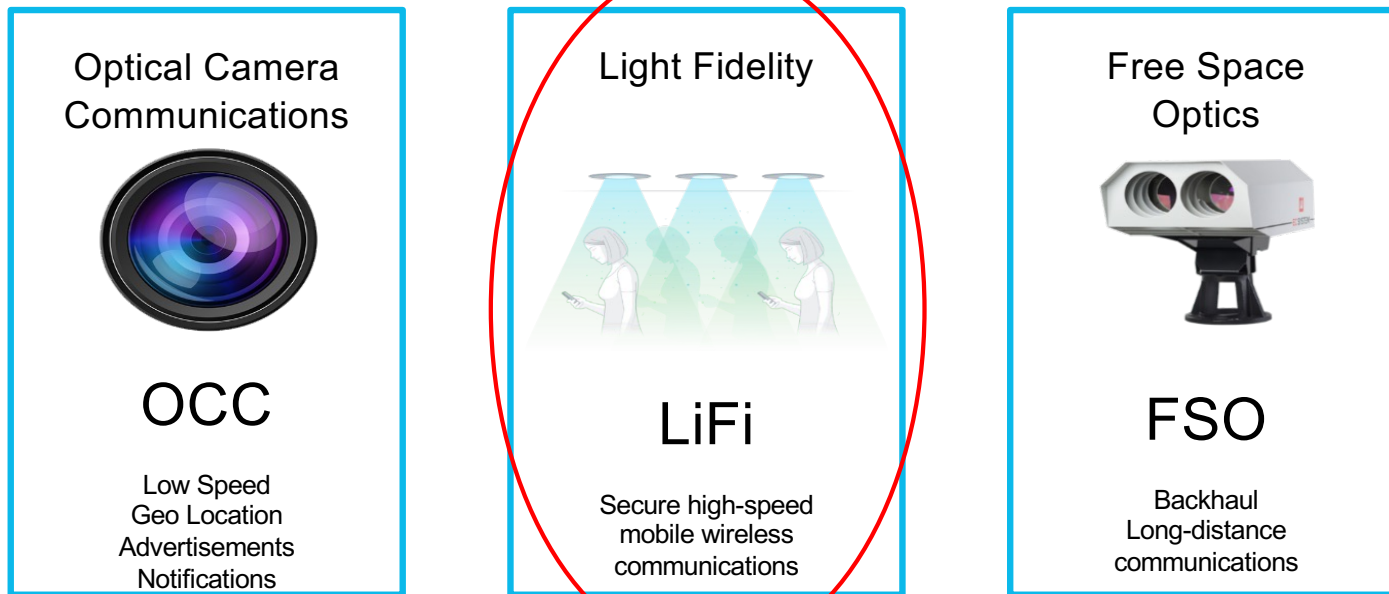



- What is LC?
- Other LC standards



## Hybrid RF/LC

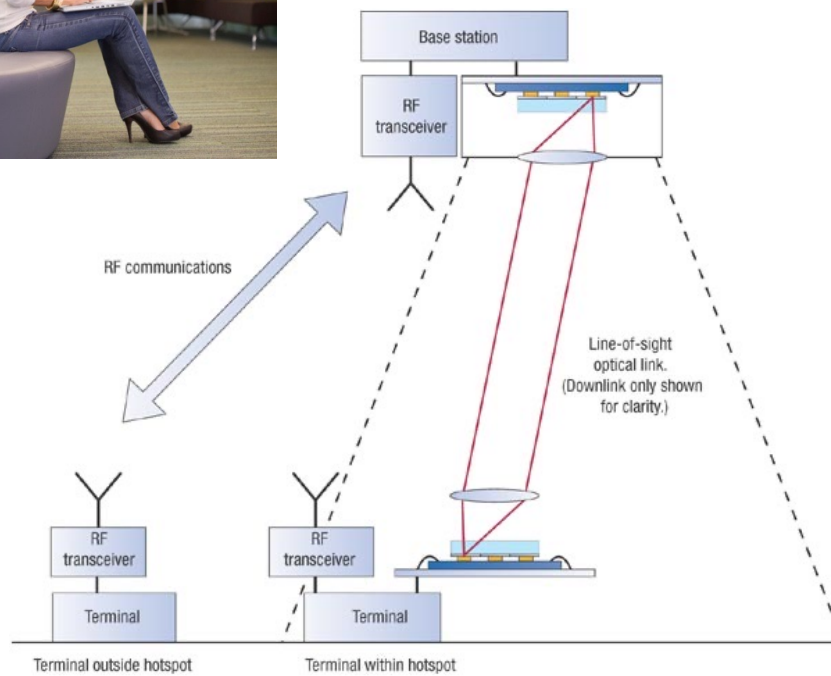

- **Optical small cells**
  - densify radio-based WLAN
  - using infrared or visible light
  - 100 Mbit/s ... 10 Gbit/s per link
  - eventually integrated with lighting
- **Low-cost off-the-shelf components**
  - LEDs, laser diodes
  - silicon photodiodes
  - digital signal processing

Dominic O'Brien, Gareth Parry & Paul Stavrinou **Optical hot spots speed up wireless communications** Nature Photonics 1, 245 - 247 (2007)

- **What is LC?**
- Other LC standards

## Basic LC link

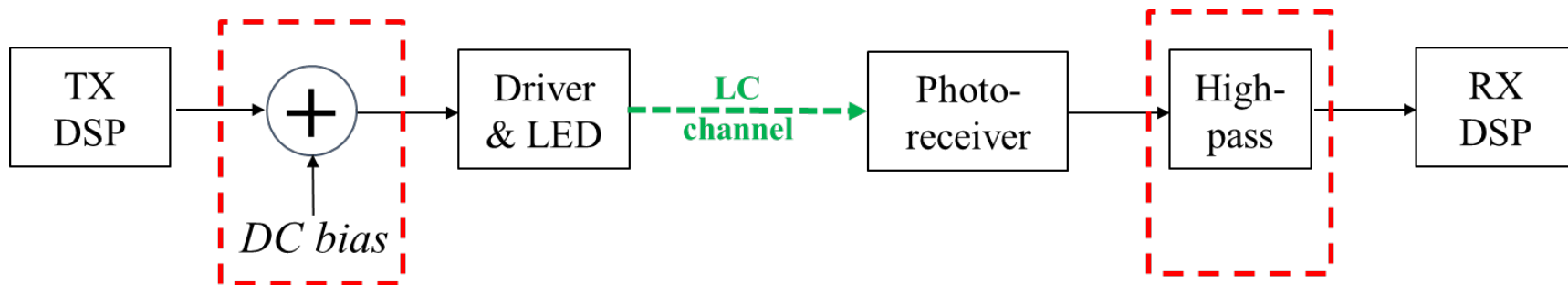

- **TX and RX DSP can be very similar to RF.**
- **A real-valued waveform is needed and a bias is added.**
- **The biased waveform is transmitted by LED and detected by photodiode**
- **The high-pass removes the DC bias and possible ambient/sun light.**
- **Only the AC signal is used for communication, in the presence of thermal and shot noise.**



# TX frontend

- Introduction
- **What is LC?**
- Other LC standards

- **Any solid state light source can be used**
  - LEDs, Lasers and VCSELs support different bandwidth
- **802.15.13: UV, VIS and IR betw. 190 nm and 10000 nm**
  - intended for specialty applications
- **802.11bb supports IR between 800 an and 1000 nm**
  - compare **IR** versus **visible light** at same drive currents
- **IR has 10x more signal and 40x higher bandwidth**
  - conversion from blue to white, phosphor reduces the speed
  - higher e/o and o/e conversion coefficients in IR vs. blue

Amplitude response of the Li-Fi system in LOS

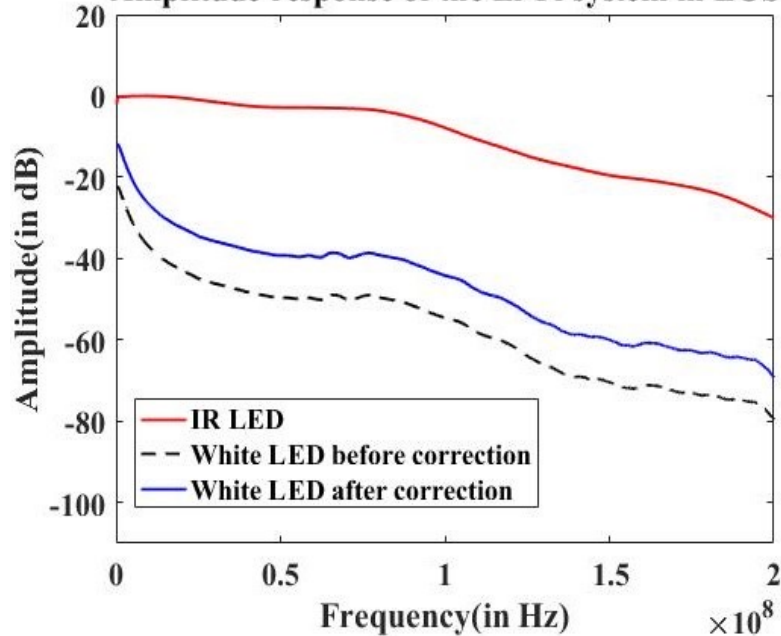

Sreelal M. Mana et al, "Experiments in Non-Line-of-Sight Li-Fi Channels," 2019 Global LIFI Congress, Paris, France, 2019

# RX frontend

- Introduction
- **What is LC?**
- Other LC standards

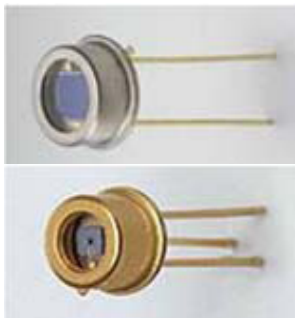

## ■ PIN photodiode

- large area, limited sensitivity, low cost

## ■ Avalanche photodiode (APD)

- smaller area, higher sensitivity, higher cost

## ■ Optical concentrator (OC)

- increased effective area, reduced field-of-view

## ■ Transimpedance amplifier (TIA)

- small photocurrent ( $\mu\text{A}$ ) into useful voltage (V)

## ■ Bootstrapping (BS)

- increases bandwidth

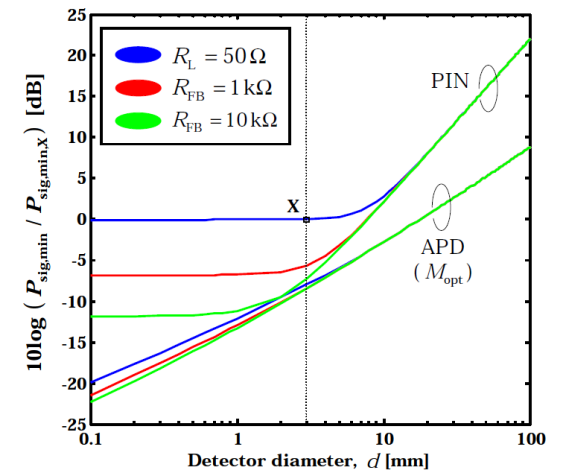
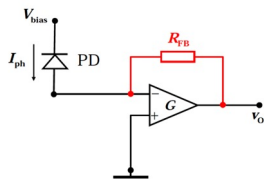
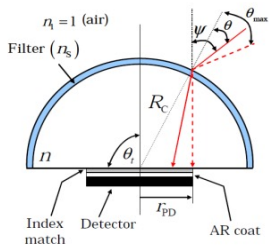

Jelena. Vucic, Ph.D. thesis, TU Berlin, 2009

# Light propagation

- Introduction
- **What is LC?**
- Other LC standards

BS: base station, MS: mobile station

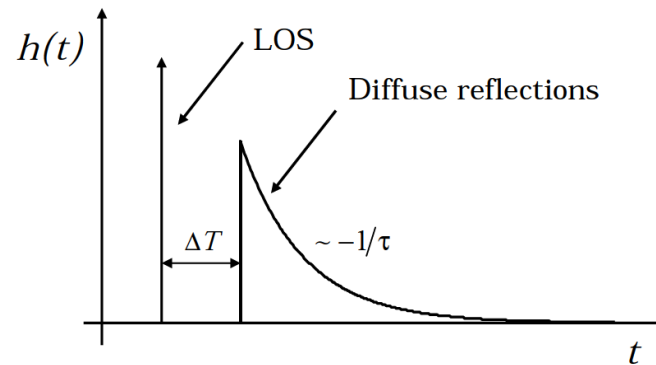
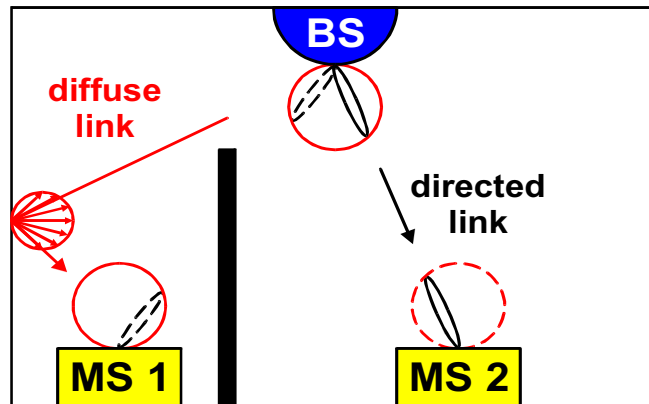

- **Direct link (LOS)**

- high power
- blocking is critical
- no multipath
- high bandwidth

- **Diffuse link (NLOS)**

- low power
- blocking is less relevant
- inherent support for mobility
- multipath → 1<sup>st</sup> order low pass, reduced bandwidth

# LOS vs. diffuse

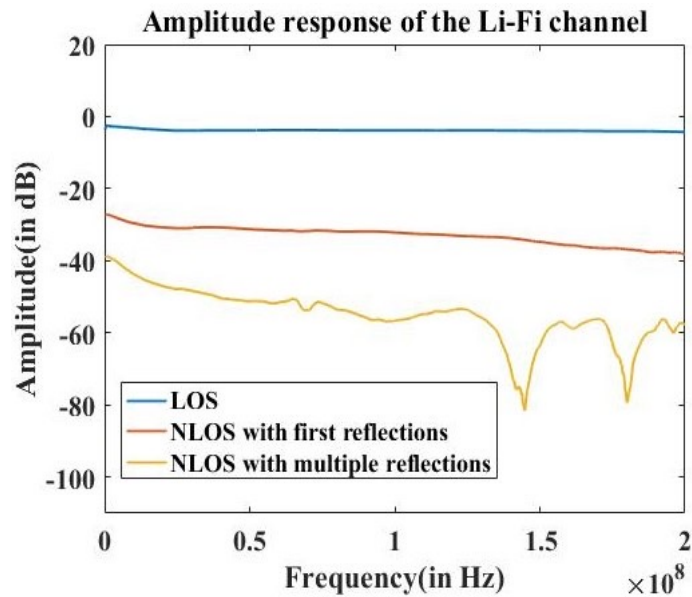
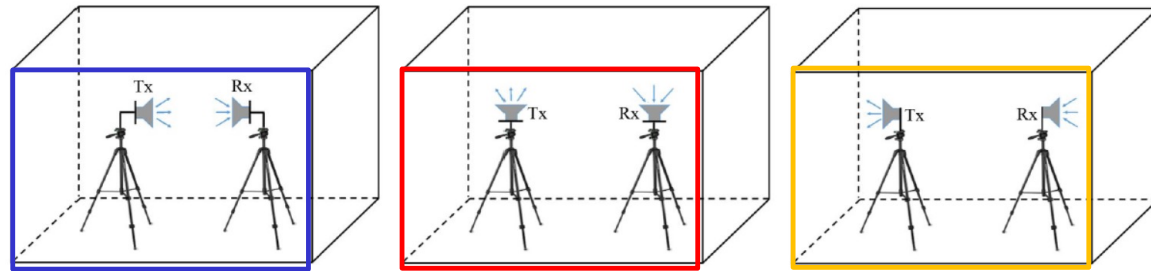

- **LOS is the dominant signal, if it is free**
  - high power and high bandwidth
- **First-order reflections**
  - 25 dB reduced power, rather high bandwidth
- **Higher-order reflections only**
  - 35 dB reduced power, lower bandwidth

Sreelal M. Mana et al, "Experiments in Non-Line-of-Sight Li-Fi Channels," 2019 Global LIFI Congress, Paris, France, 2019

# Other LC standards

- Introduction
- What is LC?
- Other LC standards



- **IrDA – Infrared Data Association**

- Founded 1993 to establish interoperable solution for infrared light data networking
- Initial IrDA Data standard released in 1994 for P2P communications over IR light
- Several amendments with bitrates to 1 Gb/s and providing broad application support



- **IEEE 802.15.7**

- Task Group on Visible Light Communication established in Jan 2009
- IEEE Std 802.15.7-2011, later revised to IEEE Std 802.15.7-2018
- Now focusing on **Optical Camera Communication (OCC)**

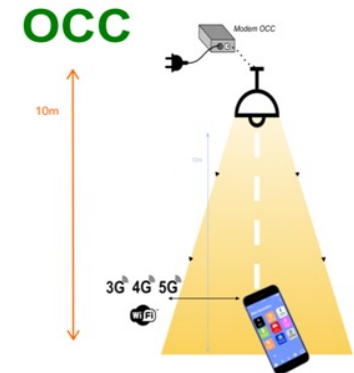

# ITU-T G.9991

- Introduction
- What is LC?
- **Other LC standards**

- **G.9991 is used for almost all LC products today**
- **Based on home networking standard G.996x (G.hn coax mode)**
  - chipsets from multiple vendors are available
- **Developed by ITU-T Q18/SG15: In-premises networking**
  - started 2015, first approval April 2019, latest update in April 2021
  - DCO-OFDM PHY, (DC biased Optical OFDM), adaptive bitloading, up to 2 Gbps
  - MAC (TDMA, CSMA) allows for Quality-of-Service through medium reservation for transmissions

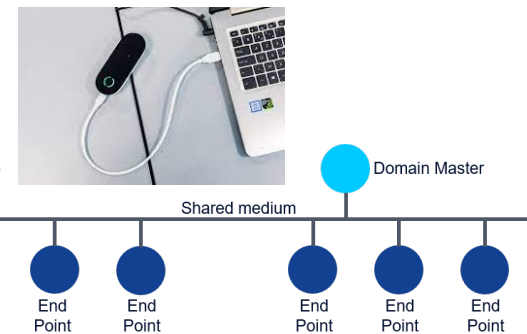



## New LC standards address different markets

- **802.15.13**
  - high-end capabilities for industrial / medical / FWA markets
  - new features for increased range, higher reliability, deterministic latency
- **802.11bb**
  - capabilities address the consumer market
  - easy integration with commercially available chipsets, infrastructures and ecosystem

# IEEE P802.15.13 - Overview

- IEEE P802.15.13
- Architecture & Service
- PHYs
- MAC
- Status

- **Focus: Industrial applications**
  - new standard including MAC and PHY
- **Goals: Simplicity, low implementation barrier**
  - simplified MAC
  - basic data transmission w/o security supported
  - two new PHYs
- **Star topology network**
  - coordinator manages the network
  - members associate with the network
  - allows P2MP or P2P communication
- **Interconnection with 802 LANs**

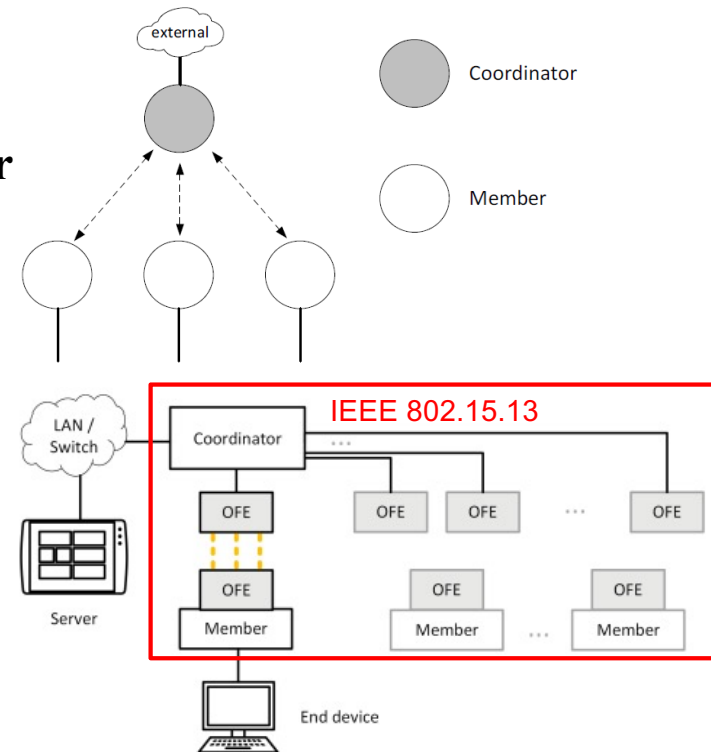

# Architecture and service of 802.15.13

- IEEE P802.15.13
- **Architecture & Service**
- PHYs
- MAC
- Status

- **Data transmission always between Coordinator and Members**
  - Coordinator bridges data between two members
  - Only exception are relays
- **MAC Data interface**
  - EUI-48 addresses
  - Supports 802.1 MAC service
  - Shim not yet in 802.1AC (t.b.d.)

Table 13 Parameters of the MD-DATA.request primitive.

Name	Range	Description
DestinationAddress	MAC address	The destination address of the MSDU.
SourceAddress	MAC address	The source address of the MSDU.
MsdU	Octet Sequence	The MSDU in EtherType format, i.e., starting with the Length/Type field and ending with the MAC Client Data field as defined in IEEE Std 802.3™.
Priority	[0, 7]	The priority of the MSDU, as detailed in IEEE Std 802.1AC.
Acknowledged	TRUE, FALSE	Whether the associated MSDU is transmitted with acknowledgment request.

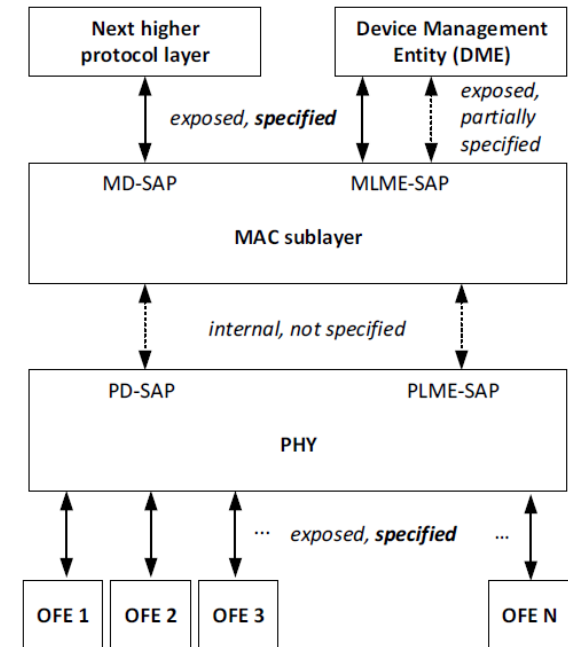
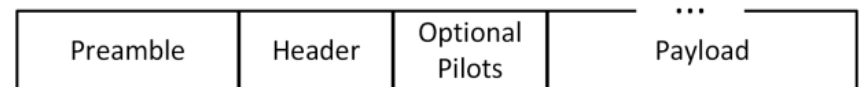

Figure 8 OWPAN device architecture.

- IEEE P802.15.13
- Architecture & Service
- **PHYs**
- MAC
- Status

## Physical layers (PHYs)

- **Two physical layers (PHYs) with distinct properties**
  - OOK modulation → Energy efficiency
  - OFDM modulation → Spectral efficiency
- **Both support important features for LC:**
  - Bandwidth and rate adaptation to OFE and channel properties
  - MIMO pilots for channel estimation between multiple TX and RX
  - Cyclic prefix for frequency domain equalization
- **Both have similar Physical layer protocol data unit (PPDU) format:**
  - Preamble: for frame detection and channel estimation
  - Header: information about further PPDU structure
  - Optional pilots: for MIMO channel estimation
  - Payload: contains MAC data



# OOK & OFDM

- IEEE P802.15.13
- Architecture & Service
- PHYs
- MAC
- Status

- **OOK: „PM-PHY“**

- Clock (symbol) rates 12.5 ... 200 MHz
- Reed-Solomon error coding
- 8b10b line coding removes DC
- Cyclic prefix 160 or 1280 ns

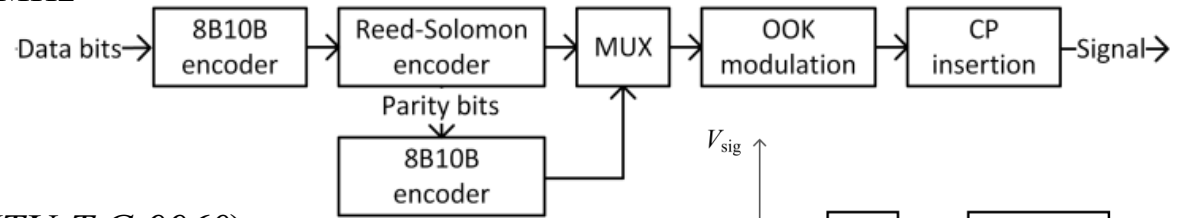

- **OFDM: „HB-PHY“** (*inspired by ITU-T G.9960*)

- Bandwidths 50, 100 and 200 MHz
- Adaptive bitloading → use optical frontend efficiently
- LDPC encoding for high performance
- Cyclic prefix: 160 to 1280 ns

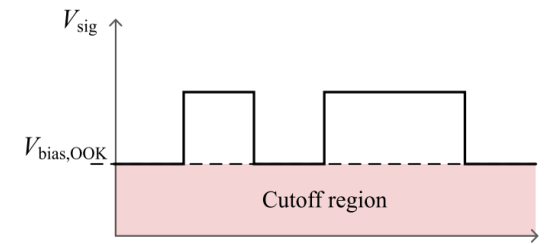
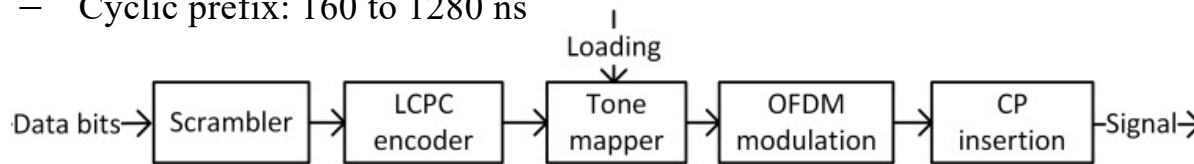

M. Hinrichs et al., "A Physical Layer for Low Power Optical Wireless Communications," in *IEEE Transactions on Green Communications and Networking*, vol. 5, no. 1, pp. 4-17, March 2021

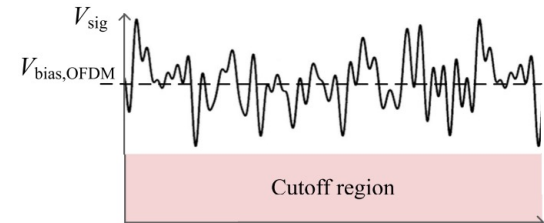

M. Hinrichs et al., "A Physical Layer for Low Power Optical Wireless Communications," in *IEEE Transactions on Green Communications and Networking*, vol. 5, no. 1, pp. 4-17, March 2021

# Channel access in 802.15.13

- IEEE P802.15.13
- Architecture & Service
- PHYs
- **MAC**
- Status

- **Two mechanisms: Scheduled & polled channel access**
- **Scheduled medium access – TDMA reservations without carrier sensing**
  - Random access & “guaranteed” access in *random time slices (RTS)* and *guaranteed time slices (GTS)*
  - Coordinator transmits control frames for synchronization and slice distribution regularly but in variable slot
  - Members transmit in allocated slices

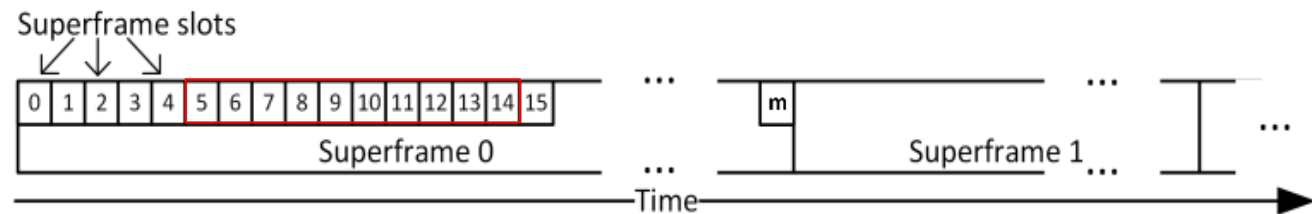

- **Polled medium access (based on IEEE 802.11 PCF)**
  - Coordinator polls for random and dedicated transmissions
  - One (dedicated) or more (random) members transmit after receiving a poll frame

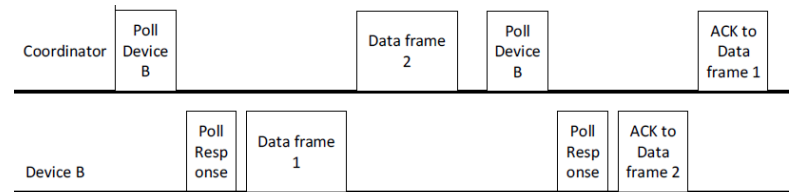

# Other features in 802.15.13 MAC

- IEEE P802.15.13
- Architecture & Service
- PHYs
- **MAC**
- Status

- **Acknowledgment & Retransmission**
  - Single, Block ACK
  - Both not immediate due to possible fronthaul delay
- **PHY rate adaptation feedback**
  - MCS (=clock rate) selection for PM-PHY
  - Adaptive bitloading for HB-PHY
- **Fragmentation & Aggregation**
  - For efficient use of available resources
- **One general frame format (MPDU)**
  - Three frame types – *data, control, management*
  - Protocol information exchanged in „elements”, that reside in MPDU payload

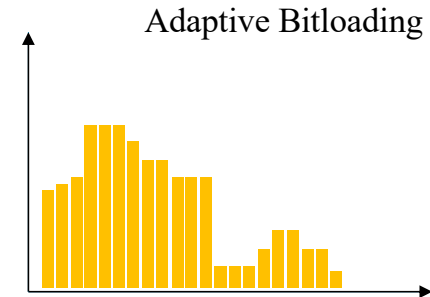

2 Octets	6 Octets	6 Octets	2 Octets	0/2 Octets	0/2 Octets	0/8 Octets	variable	4 Octets
Frame Control	Receiver Address	Transmitter Address	Payload Element ID	Sequence Control	Fragmentation Control	Relay Control	Payload	FCS
MAC header								

# Distributed MIMO in 802.15.13

- IEEE P802.15.13
- Architecture & Service
- PHYs
- **MAC**
- Status

- **Multiple optical frontends (OFEs)**
  - Spatial multiplexing & diversity through MISO TX
  - Spatially distributed OFEs (D-OFE) connected via “fronthaul”
  - Fronthaul details are implementation-specific
- **MIMO Feedback routine for OFE selection**
  - Parallel transmission of orthogonal pilots from OFEs
  - CSI feedback of member’s observed OFEs to coordinator
  - Coordinator schedules medium access based on CSI

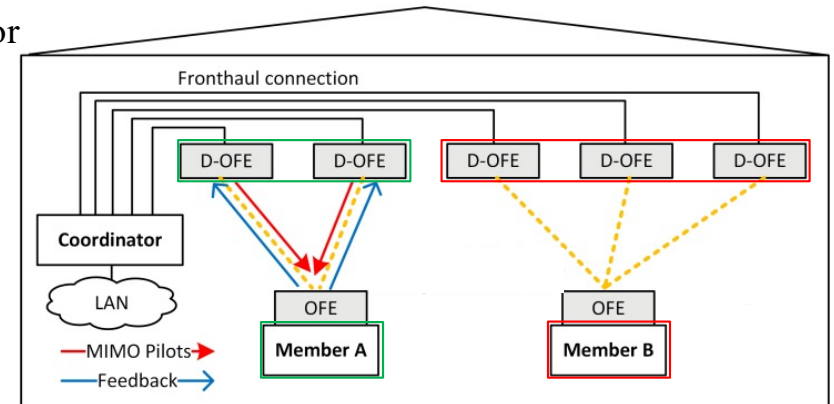
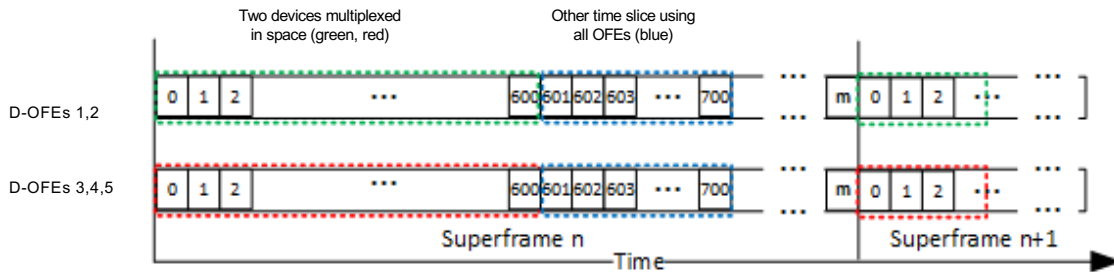
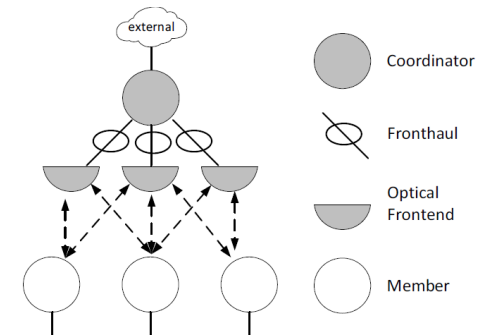



# Relaying in 802.15.13

- IEEE P802.15.13
- Architecture & Service
- PHYs
- **MAC**
- Status

- **Make use of secondary light sources**
  - overcome LOS blocking, enhance the range
- **Relay selection**
  - relay and relayed device listen to the environment (learning)
  - report transmitter addresses of MPDUs to the coordinator
- **Significant gains up to 30 dB were observed**
  - suitable relay has a free LOS and it shortens the distance

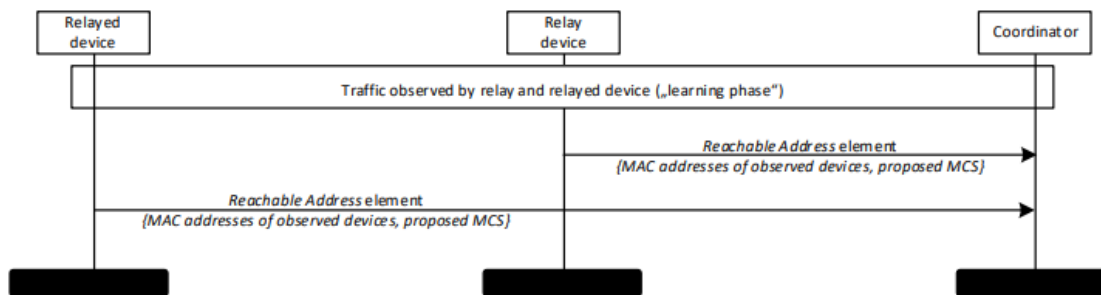
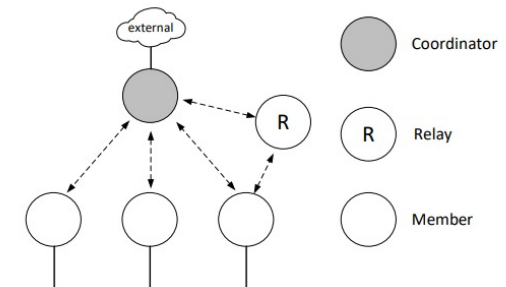

# Implementation of 802.15.13

- IEEE P802.15.13
- Architecture & Service
- PHYs
- MAC
- **Status**

- **Validation through prototyping**
  - FPGA-based PHY implementation
  - MAC on general-purpose CPU
  - Bugs were found and fixed
- **Features**
  - PM-PHY is done, HB-PHY is in progress
  - Next: D-MIMO over Ethernet fronthaul, relaying
- **Test deployments**
  - in medical and industrial environments
  - projects LINCNET, 5G-COMPASS
- **Video about HILIGHT project available**
  - [https://www.youtube.com/watch?v=NEWqi\\_QHUV8](https://www.youtube.com/watch?v=NEWqi_QHUV8)



# P802.15.13 is finalized

- IEEE P802.15.13
- Architecture & Service
- PHYs
- MAC
- **Status**

- **Draft D10 is approved for publication by IEEE SA board**
- **Available in IEEEExplore:**  
**<https://ieeexplore.ieee.org/document/9963940>**
- **Awaiting publication Q2-3/2023**

P802.15.13-D10.0, November 2022  
Draft Standard for Multi-Gigabit per Second Optical Wireless Communications (OWC), with Ranges up to 200 Meters, for both Stationary and Mobile Devices

1 **IEEE P802.15.13™-D10**  
2 **Draft Standard for Multi-Gigabit per**  
3 **Second Optical Wireless**  
4 **Communications (OWC), with Ranges**  
5 **up to 200 Meters, for both Stationary**  
6 **and Mobile Devices**

7 Developed by the  
8 IEEE Computer Society  
9 of the  
10 IEEE LAN/MAN Standards Committee  
11  
12  
13  
14 Approved «Date Approved»  
15  
16 IEEE SA Standards Board  
17  
18 Copyright © 2022 by The Institute of Electrical and Electronics Engineers, Inc.  
19 Three Park Avenue  
20 New York, New York 10016-5997, USA  
21 All rights reserved.

22 This document is an unapproved draft of a proposed IEEE Standard. As such, this document is subject to  
23 change. USE AT YOUR OWN RISK. IEEE copyright statements SHALL NOT BE REMOVED from draft  
24 or approved IEEE standards, or modified in any way. Because this is an unapproved draft, this document  
25 must not be utilized for any conformance/compliance purposes. Permission is hereby granted for officers  
26 from each IEEE Standards Working Group or Committee to reproduce the draft document developed by that  
27 Working Group for purposes of international standardization consideration. IEEE Standards Department  
28 must be informed of the submission for consideration prior to any reproduction for international  
29 standardization consideration ([stds.ieee.org](mailto:stds.ieee.org)). Prior to adoption of this document, in whole or in part, by  
30 another standards development organization, permission must first be obtained from the IEEE Standards  
31 Department ([stds.ieee.org](mailto:stds.ieee.org)). When requesting permission, IEEE Standards Department will require a  
32 copy of the standard development organization's document highlighting the use of IEEE content. Other  
33 entities seeking permission to reproduce this document, in whole or in part, must also obtain permission from  
34 the IEEE Standards Department.

35 IEEE Standards Department  
36 445 Hoes Lane  
37 Piscataway, NJ 08854, USA  
38

1  
Copyright © 2022 IEEE. All rights reserved.  
This is an unapproved IEEE Standards Draft, subject to change.

# IEEE 802.11bb overview

- IEEE P802.11bb
- PHY
- Status

- **802.11bb aims at LC for the mass market**
- **IEEE 802.11 is the world's most common communications standard**
  - Over 3.8 billion Wi-Fi chipsets were shipped globally in 2021 in everything from smartphones, TVs, CCTV cameras, baby monitors, etc.
  - The large established market and open standards have created a highly competitive, vibrant ecosystem of devices, testing facilities, etc.
- **Deploying LC on a global scale requires reducing the barrier to entry for anyone looking to produce interoperable systems**
- **IEEE 802.11bb offers the simplest integration route with the highest number of possible device integration options**

# 802.11bb PHY concept

- IEEE P802.11bb
- PHY
- Status

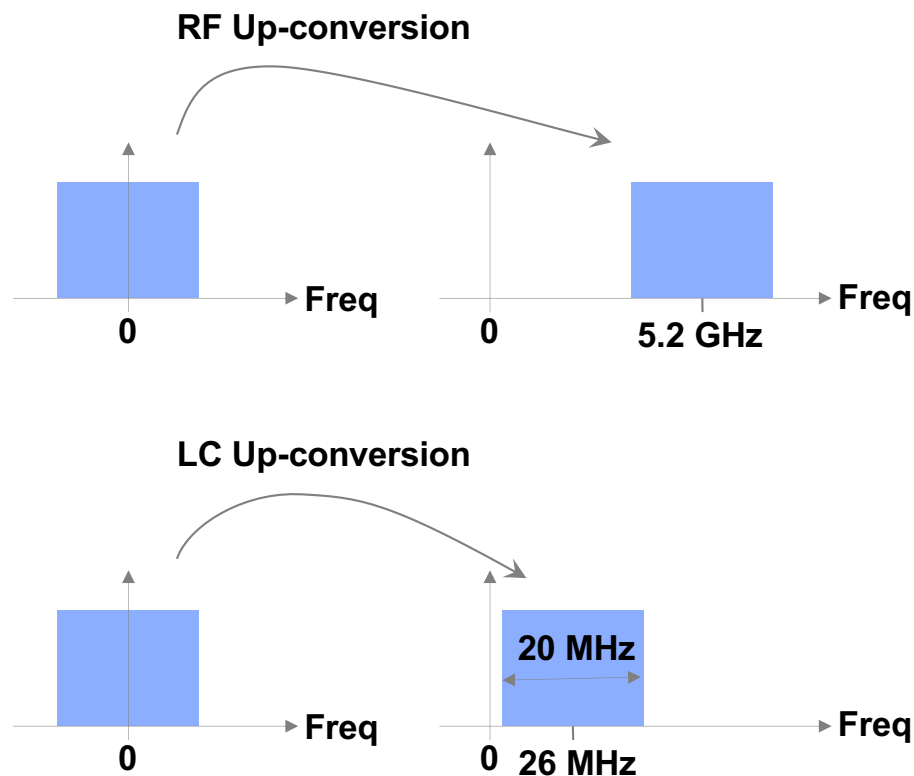

- **KISS approach: Reuse existing PHYs and MAC from 802.11**
  - RF frontend up-converts baseband signals onto e.g. 5.2 GHz
  - LC frontend up-converts baseband onto lower IF carrier frequency e.g. 26 MHz in the case of 20 MHz baseband signal
  - allows to convert any existing Wi-Fi chip solution into a LC solution through adding cheap circuitry
- **Same bitrates, same interfaces, same capabilities like Wi-Fi**

# PHY Implementation options

- IEEE P802.11bb
- PHY
- Status

Existing Wi-Fi chipsets

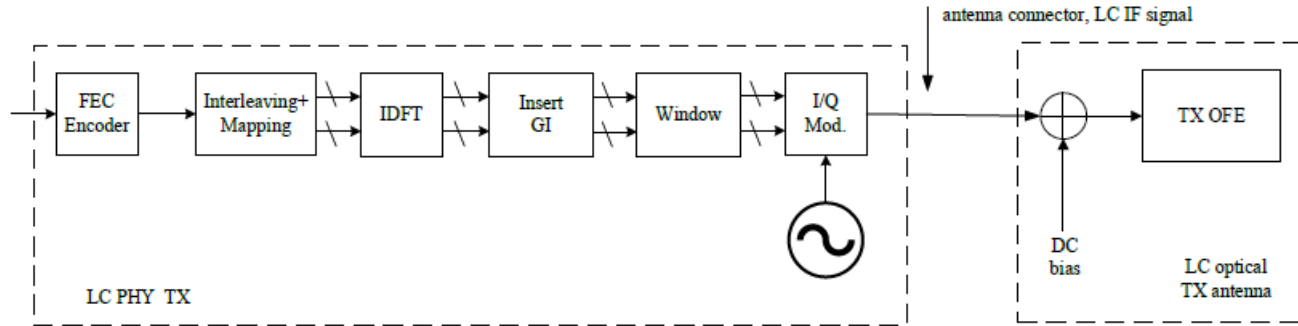

Direct Conversion

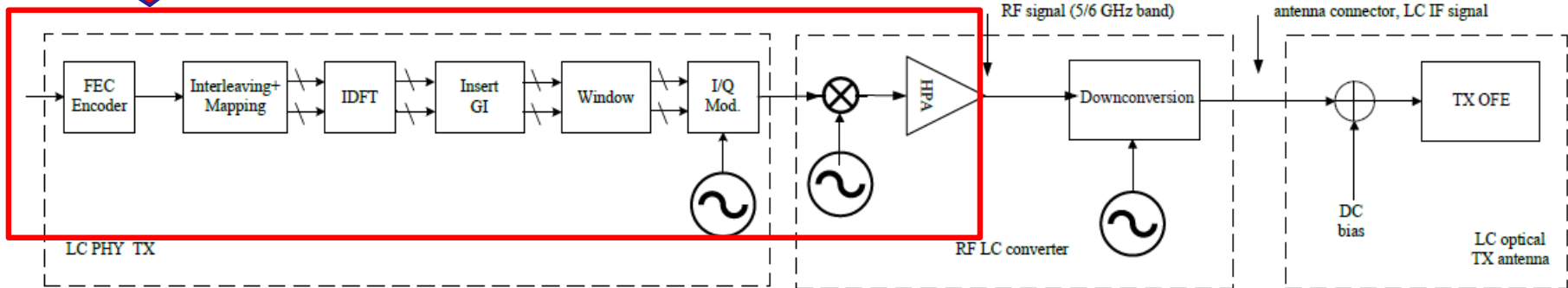

Up/Down Conversion from RF

# LC IF mappings from 5 and 6 GHz

- IEEE P802.11bb
- PHY
- Status

Table 31-1— RF to LC IF Mapping for channels in the 5 GHz and 6 GHz bands

Channel number	RF frequency band	RF center frequency (MHz)	LC IF center frequency (MHz)	Channel width					
				20 MHz	40 MHz PrimaryChannel LowerBehaviour	40 MHz PrimaryChannel UpperBehaviour	40 MHz	80 MHz / 80+80 MHz	160 MHz
34	5 GHz	5170	16	Channel number 36 16 MHz-36 MHz	Channel number 36 16 MHz-56 MHz	Channel number 40 16 MHz-56 MHz	N.A.	Channel center frequency index 42 16 MHz-96 MHz	160 MHz
36		5180	26						
38		5190	36	Channel number 40 36 MHz-56 MHz	Channel number 44 56 MHz-76 MHz	Channel number 48 56 MHz-96 MHz			
40		5200	46						
42		5210	56	Channel number 44 56 MHz-96 MHz	Channel number 52 96 MHz-136 MHz	Channel number 56 96 MHz-136 MHz			
44		5220	66						
46		5230	76	Channel number 48 76 MHz-96 MHz	Channel number 60 136 MHz-156 MHz	Channel number 64 136 MHz-176 MHz			
48		5240	86						
50		5250	96	Channel number 52 96 MHz-136 MHz	Channel number 60 136 MHz-176 MHz	Channel number 64 136 MHz-176 MHz			
52		5260	106						
54		5270	116	Channel number 56 116 MHz-136 MHz	Channel number 60 136 MHz-156 MHz	Channel number 64 136 MHz-176 MHz			
56		5280	126						
58		5290	136	Channel number 60 136 MHz-156 MHz	Channel number 64 136 MHz-176 MHz	Channel number 64 136 MHz-176 MHz			
60		5300	146						
62		5310	156	Channel number 64 156 MHz-176 MHz	Channel number 64 136 MHz-176 MHz	Channel number 64 136 MHz-176 MHz			
64		5320	166						
1		5955	176	Channel number 1 176 MHz-196 MHz			Channel center frequency index 3 176 MHz-216 MHz		
3		5965	196						

## • 802.11bb channel mapping

- RF channels 1-64 with centre frequencies from 5.19-5.32 GHz as a block to LC IF centre frequencies 26-166 MHz
- RF channels 1-64 with centre frequencies from 5.955-6.095 GHz as a block to LC IF centre frequencies 206-326 MHz

# Spatial and wavelength multiplexing

- IEEE P802.11bb
- PHY
- Status

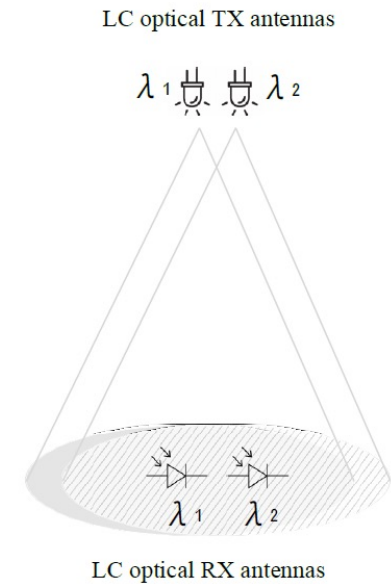
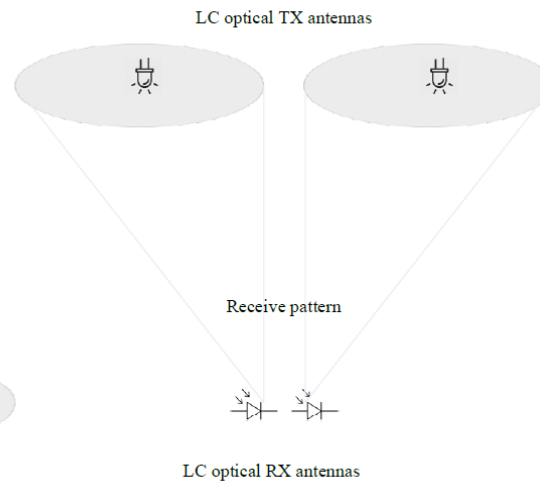
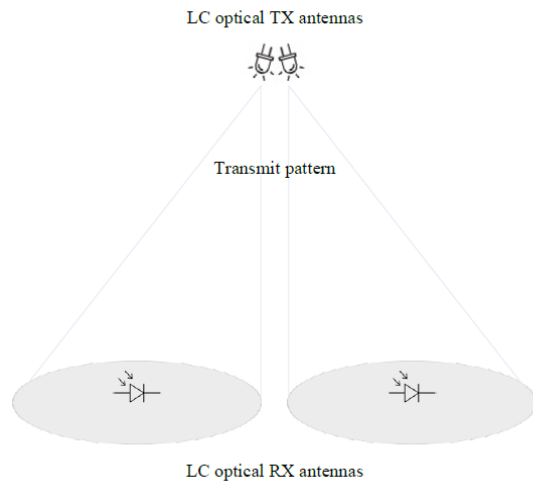

## Spatial Multiplexing

## Wavelength Division Multiplexing

- 1) 800nm – 900nm
- 2) 900nm – 1000nm



# CCA and LC repetition in 802.11bb

- IEEE P802.11bb
- PHY
- Status

- 802.11bb systems shall have the same requirements for Clear Channel Assessment (CCA) as those for existing Wi-Fi 4, Wi-Fi 5 and Wi-Fi 6 chipsets
- 802.11bb suggests an LC repetition approach where the LC AP immediately retransmits the received signal from a STA using amplify-and-forward as an example

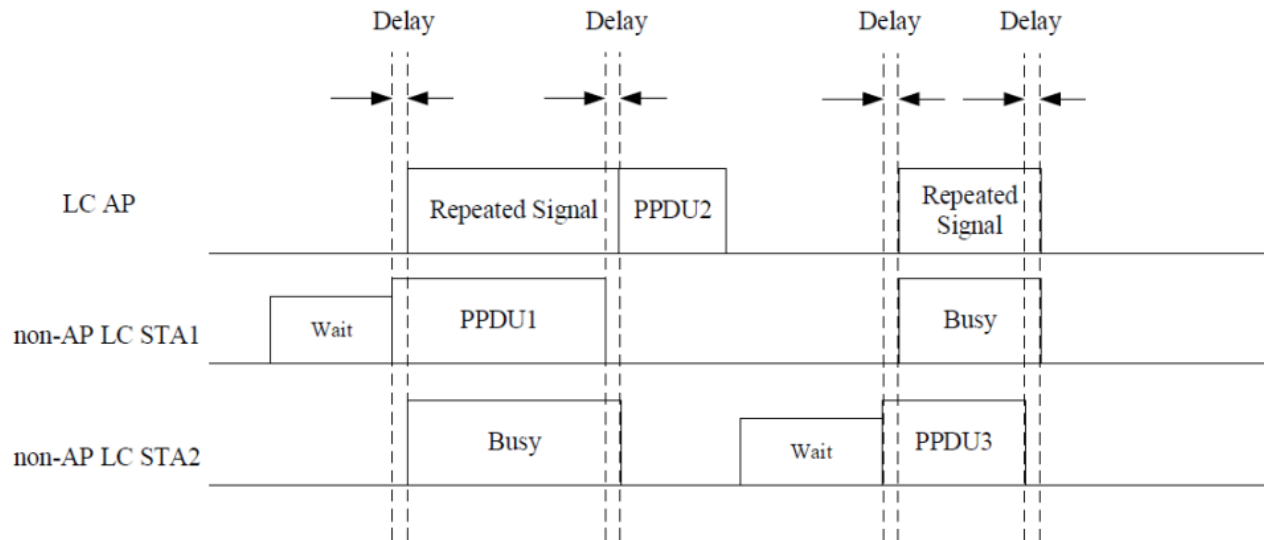

# P802.11bb is almost finalized

- IEEE P802.11bb
- PHY
- Status

- **IEEE P802.11bb D6.0**

- Approved with 96%
- is available at the IEEE store

<https://ieeexplore.ieee.org/document/10042199>

- **Draft 7.0 is currently in third IEEE SA recirculation ballot closing on 14 Mar**

- Expected final 802.11 WG approval in Mar. 2023
- Expected final 802 LMSC Approval in Mar. 2023
- Expected RevCom & SA Board Approval by Jul. 2023

PP802.11bb/D7.0, March 2023  
 Draft Standard for Information Technology—Telecommunications and Information Exchange between Systems Local and Metropolitan Area Networks—Specific Requirements  
 Part 11: Wireless LAN Medium Access Control (MAC) and Physical Layer (PHY) Specifications  
 Amendment 7: Light Communications

**IEEE P802.11bb™/D7.0 March 2023**  
 (amendment to IEEE Std. 802.11™-2020  
 as amended by IEEE Std. 802.11ax™-2021,  
 IEEE Std. 802.11ay™-2021,  
 IEEE Std. 802.11ba™-2021,  
 IEEE P802.11az™/D7.0,  
 IEEE P802.11bc™/D6.0,  
 and IEEE P802.11bd™/D6.0)

**802.11bb™/D7.0**  
**Draft Standard for Information Technology—Telecommunications and Information Exchange between Systems Local and Metropolitan Area Networks—Specific Requirements**

**Part 11: Wireless LAN Medium Access Control (MAC) and Physical Layer (PHY) Specifications**

**Amendment 7: Light Communications**

Prepared by 802.11 Working Group of  
 LANMAN Standards Committee of the IEEE Computer Society  
 Copyright © 2023 by The Institute of Electrical and Electronics Engineers, Inc.  
 Three Park Avenue  
 New York, New York 10016-5997, USA  
 All rights reserved.

This document is an unapproved draft of a proposed IEEE Standard. As such, this document is subject to change. USE AT YOUR OWN RISK! IEEE copyright statements SHALL NOT BE REMOVED from draft or approved IEEE standards, or modified in any way. Because this is an unapproved draft, this document must not be utilized for any conformance/compliance purposes. Permission is hereby granted for officers from each IEEE Standards Working Group or Committee to reproduce the draft document developed by that Working Group for purposes of international standardization consideration. IEEE Standards Department must be informed of the submission for consideration prior to any reproduction for international standardization consideration ([stds\\_int@ieee.org](mailto:stds_int@ieee.org)). Prior to adoption of this document, in whole or in part, by another standards development organization, permission must first be obtained from the IEEE Standards Department ([stds\\_int@ieee.org](mailto:stds_int@ieee.org)). When requesting permission, IEEE Standards Department will require a copy of the standard development organization's document highlighting the use of IEEE content. Other entities seeking permission to reproduce this document, in whole or in part, must also obtain permission from the IEEE Standards Department.

IEEE Standards Department  
 445 Hoes Lane  
 Piscataway, NJ 08854, USA

Copyright © 2023 IEEE. All rights reserved.  
 This is an unapproved IEEE Standards Draft, subject to change.

# Mobile device integration

- **Video available**
  - <https://vimeo.com/734356392>
- **Minaturized optical antenna**
  - key for integration into mobile devices
  - multiple optical antennas needed
  - pointing into different directions
  - omnidirectional coverage enables mobility
- **Applications**
  - device-to-device (D2D) communication
  - short-range mobile access, e.g. to a desk light



Light Communications Alliance (LCA) in a nutshell

Formed in 2018

10

OUR FOCUS TECHNOLOGIES

LiFi

OCC

FSO

**MOTIVATION**

Delivering the benefits of ubiquitous Light Communications to serve people & technologies, requires a far-reaching & coherent ecosystem working at a determined pace

**MISSION**

Driving a consistent, focused & concise approach to market education that will highlight the benefits, use cases & timelines for Light Communications

**HOW**

Aligning leaders across every industry to develop or envisage business models using Light Communication systems & technologies by defining a standard of education in an efficient communication & co-operation frame.



## 802.11bb Next steps

- IEEE P802.11bb
- PHY
- **Status**

- **Support for continued education on the benefits of LC**
  - Consider joining the Light Communications Alliance
  - <http://lightcommunications.org/>
- **Enable Wi-Fi 7 support for LC**
- **Identify certification body for LC**
- **Define certification process**
- **Develop test specifications**

# Industrial Communication

- **Video available**
  - <https://www.youtube.com/watch?v=tEJkIPv2KIA>
  - 00:30...02:49
- **Integration of a distributed LC cell in 5G SA network**
  - via Non-3GPP Interworking Function (N3IWF)
  - seamless mobility between LiFi and 5G

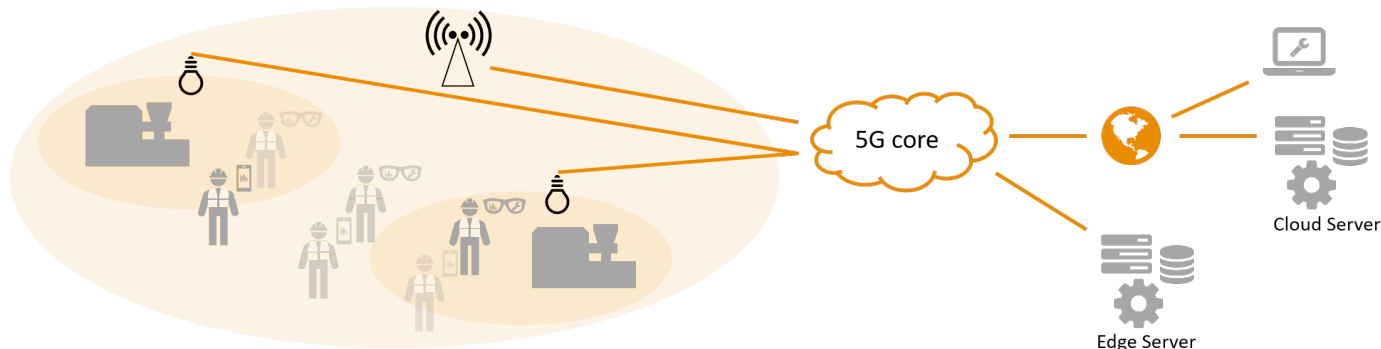

- Technology demos

## Classrooms

- **Video available:**
  - <https://www.youtube.com/watch?v=8KH6FHuVa6M>
  - 00:00...03:00
- **LC in a class room**
  - Multiple LC frontends at the ceiling next to luminaires
  - Dongles with USB-C interface
  - 1 Gbit/s DL, 100 Mbit/s UL

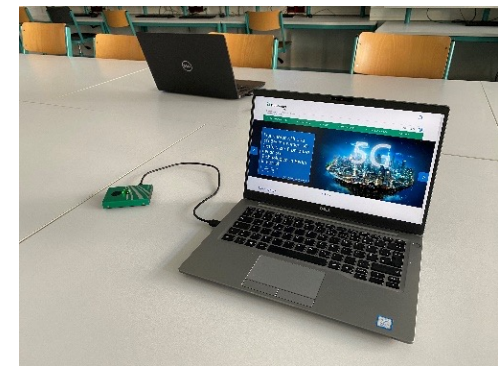
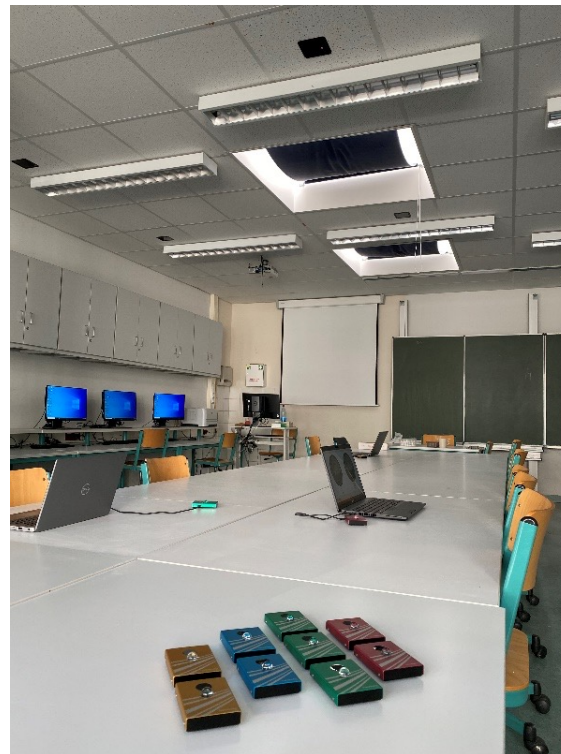

## Residential

- **Video available**
  - <https://youtu.be/NbcmVXobGW0>
  - 00:00...01:30 and 02:24...04:25
- **Living room covered by LC**
  - at KPN location in the harbor of Rotterdam/NL
  - large area coverage with Signify TrueLiFi
  - hotspot area covered by HHI Gbit LiFi link
- **Integration with other technologies**
  - powerline communication used as backhaul
  - handoff between Wi-Fi and LiFi





# Fixed Wireless Access

- Video available
  - <https://youtu.be/rpA9XrO2XqY>
  - 00:31...04:22
- **Broadband access service via LC**
  - Wireless-to-the-Home (WttH)
- **Transmission through window glass**
  - RF is blocked, LC goes through
- **High quality FWA link**
  - 1 Gbit/s, < 1 ms latency, < 1 % loss
- **High reliability**
  - weather-independent performance
- **Applications**
  - high-speed Internet, video streaming

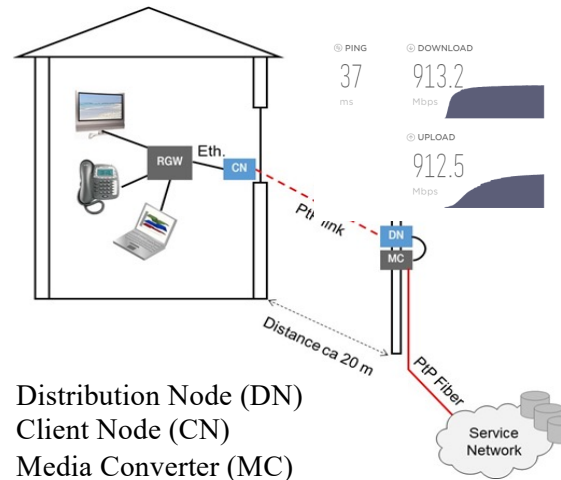

## • Technology demos



- Technology demos

# Industrial AIoT

- **Video available**
  - <https://etri.gov-dooray.com/mail/big-files/4663576d494c7333-255f35fc968ff277-306a05e75fec5df8-1870353be84>
- **Safety management using LC**
  - two cameras estimate the distance of people moving around the forklift
  - one has Artificial Intelligence of Things (AIoT) functionality, the other has not
  - via LC, the other camera connects to AIoT
  - this way, a joint decision can be made and a security alert is issued in case of risk

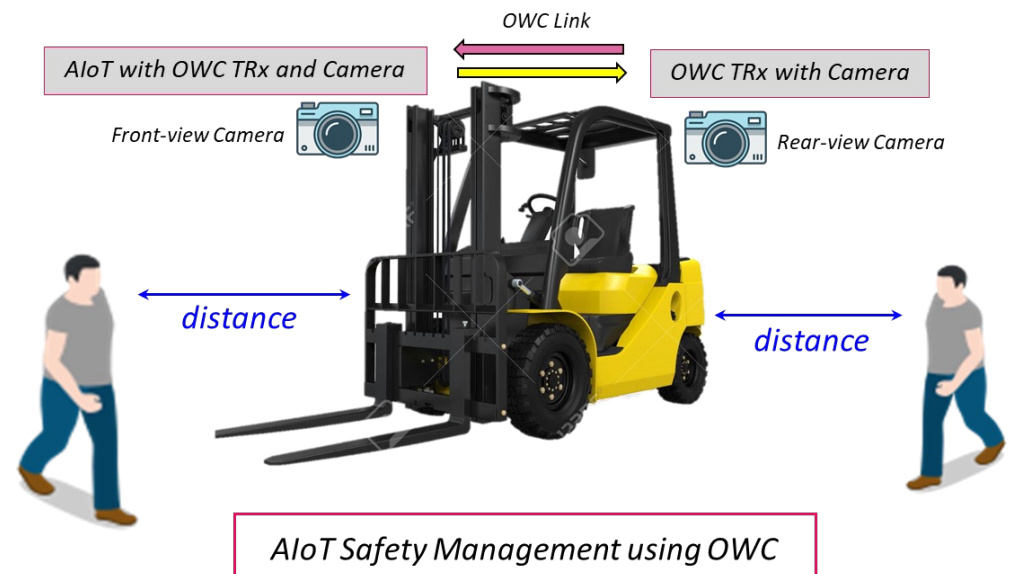

# Industrial Positioning

• Technology demos

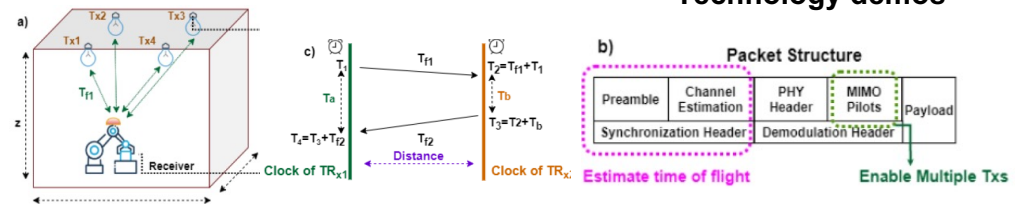

- Video available
  - <https://www.youtube.com/watch?v=tEJkIPv2KIA>
  - 00:31...01:21 and 02:10...03:25
- LC allows precise positioning
  - LOS is primary propagation path → higher precision
  - measurements available in PHY (synch, MIMO pilots)
  - triangulation with distributed MIMO → 3D position
- 3 cm error in 3D is demonstrated
  - after sophisticated calibration routine
  - near-realtime demonstration in Weidmüller factory
- Applications
  - „indoor GPS“ for automated guided vehicle (AGV)
  - aid artificial intelligence (AI) with context information

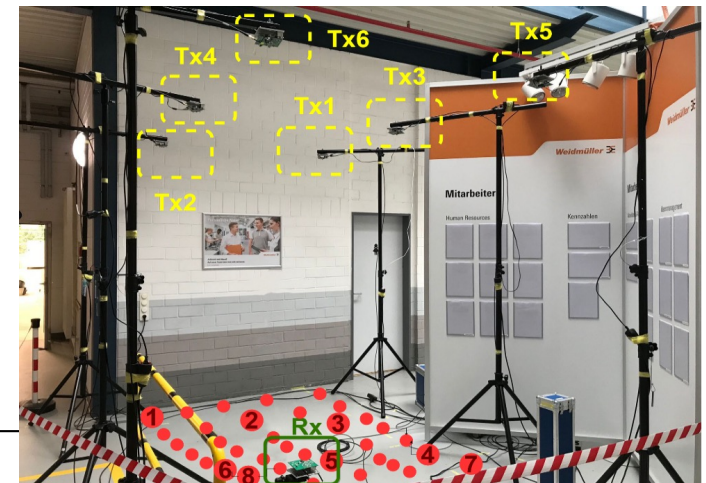
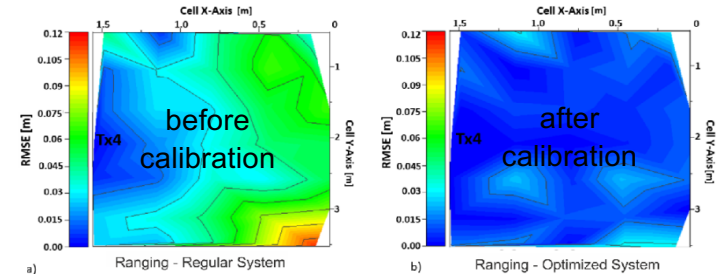

## Summary

- **LC is promising in applications where RF is limited.**
  - Optical frontends use solid state lighting devices with driver and photodiodes with amplifier.
  - Light travels primarily through LOS, unlike RF.
- **IEEE 802 has developed two new standards for LC.**
  - 802.15.13 for industrial/medical applications
  - 802.11bb for residential/consumer applications.
- **Prototypes and early products are available for testing.**
  - fixed wireless access, industrial communication and positioning, residential and home applications.
- **Proposed next step is hybrid integration of LC and RF.**

## International efforts

- A variety of projects has contributed to the development of light communication.



H2020 WORTECS

Wireless Optical/Radio Tera-bit CommunicationS

<https://wortecs.eurestools.eu/> (EU, 2017-20)



H2020 Enhance Lighting for the Internet of Things (EU, 2018-22)

<https://www.eliot-h2020.eu/>



H2020 5G-CLARITY

Beyond 5G Multi-Tenant Private Networks Integrating Cellular, Wi-Fi, and LiFi, Powered by Artificial Intelligence and Intent Based Policy

<https://www.5gclarity.com/> (EU, 2019-22)

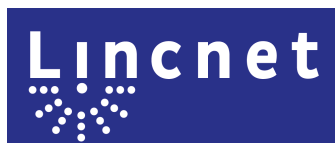

LiFi-based 5G for industrial and medical networks (BMWK, 2022-24)

<https://www.lincnet.de/en-gb>



H2020 B5G-OPEN

Beyond 5G - Optical nEtwork coNtinuum

<https://www.b5g-open.eu/> (EU, 2021-24)

## 5G-COMPASS

Convergent Open Mobile and secure Provider-ASSisted 5G indoor and hotspot network

(BMDV, 2023-24)

# **Backup**

## LC vs. RF

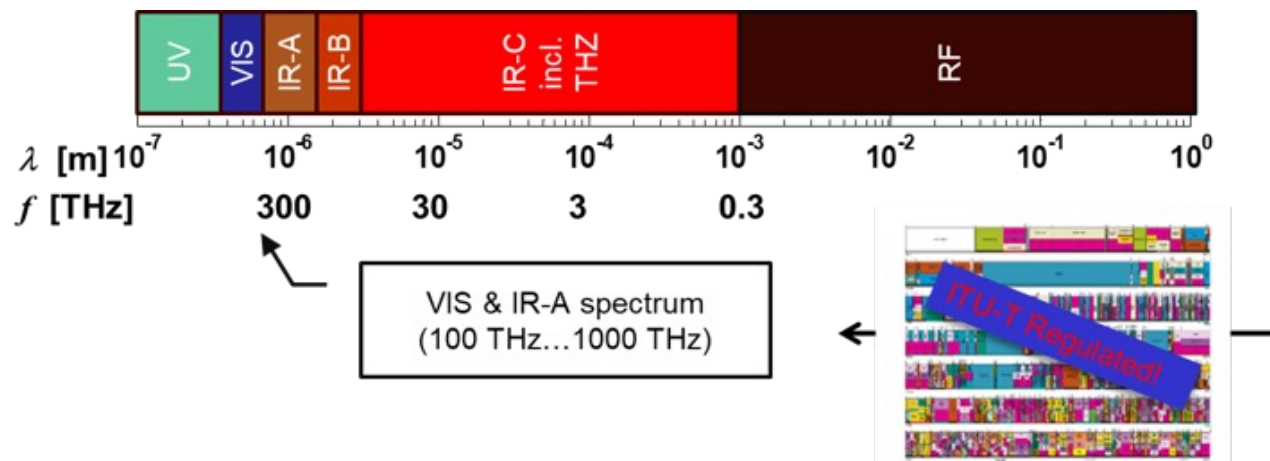

- **Light spectrum is unregulated, similar like RF in ISM bands, limited by eye safety**
- **Communication is possible wherever the light goes**
- **LC has shorter range and is more directional than RF**
- **While RF often propagates via multi-path, light travels primarily via the LOS**



## TX frontend: LEDs

- Low-cost high-power LEDs became available, e.g. for lighting
- For data transmission, LED can be modulated at high speed
- Flicker is invisible for the human eye
- Blue LED + phosphor
  - blue LED is fast (~20 MHz)
  - phosphor is slow (1-2 MHz)
- R+G+B type
  - wavelength-division multiplexing (WDM → 802.11bb)
  - ~20 MHz per color
  - higher cost

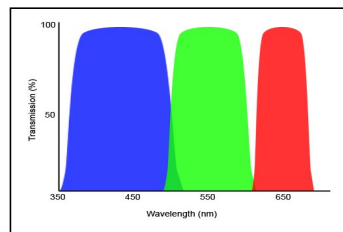
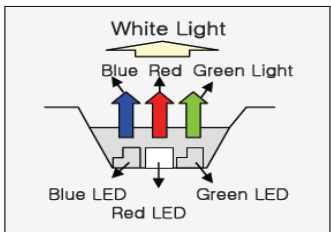
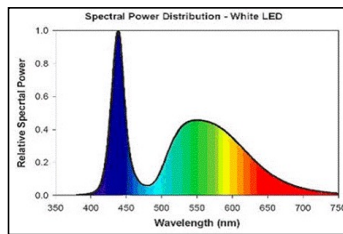
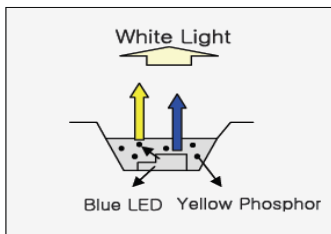



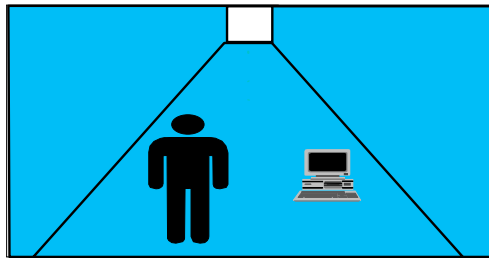

## Directed and diffuse link

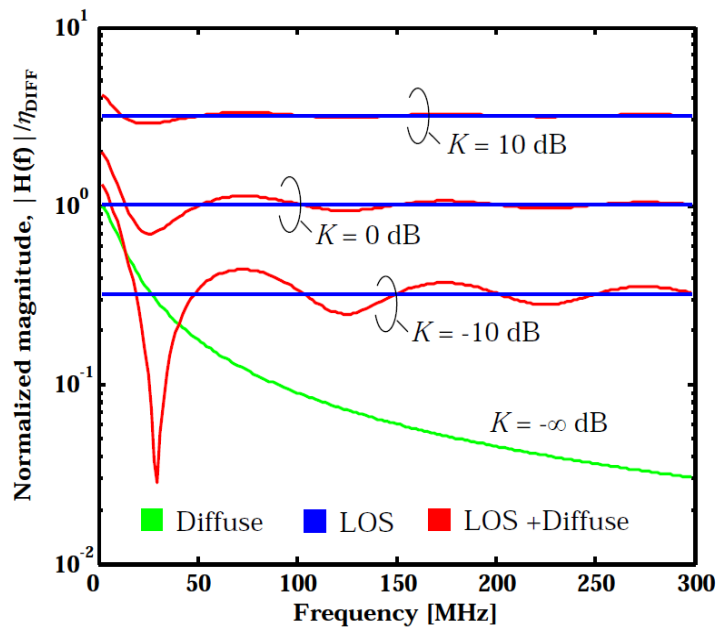

- **Channel response depends on**
  - Rice factor
  - $$K[\text{dB}] = 20 \log \frac{\eta_{\text{LOS}}}{\eta_{\text{DIFF}}}$$
  - delay  $\Delta\tau$  between direct and diffuse link
  
- **Compound channel is frequency-selective**
  - rare “fading” effects
  - when LOS and NLOS are similarly strong
  - in room corners, or when Tx and/or Rx are tilted

# Distributed MIMO

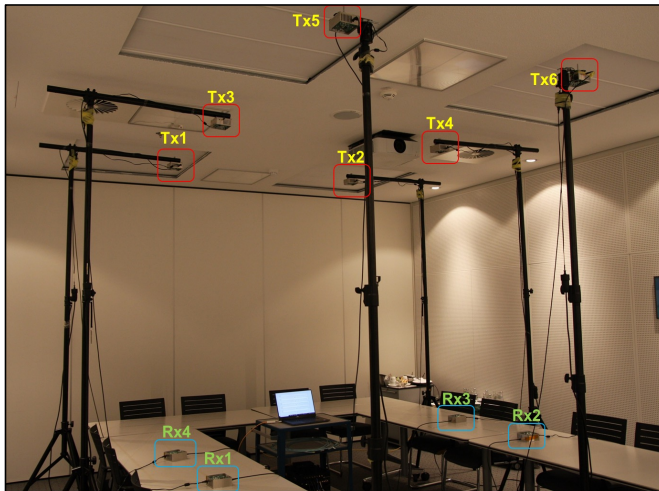

- 6 optical frontends, 4 users
- can be considered as distributed MIMO
- measured with LC channel sounder
- channel rank depends on user location

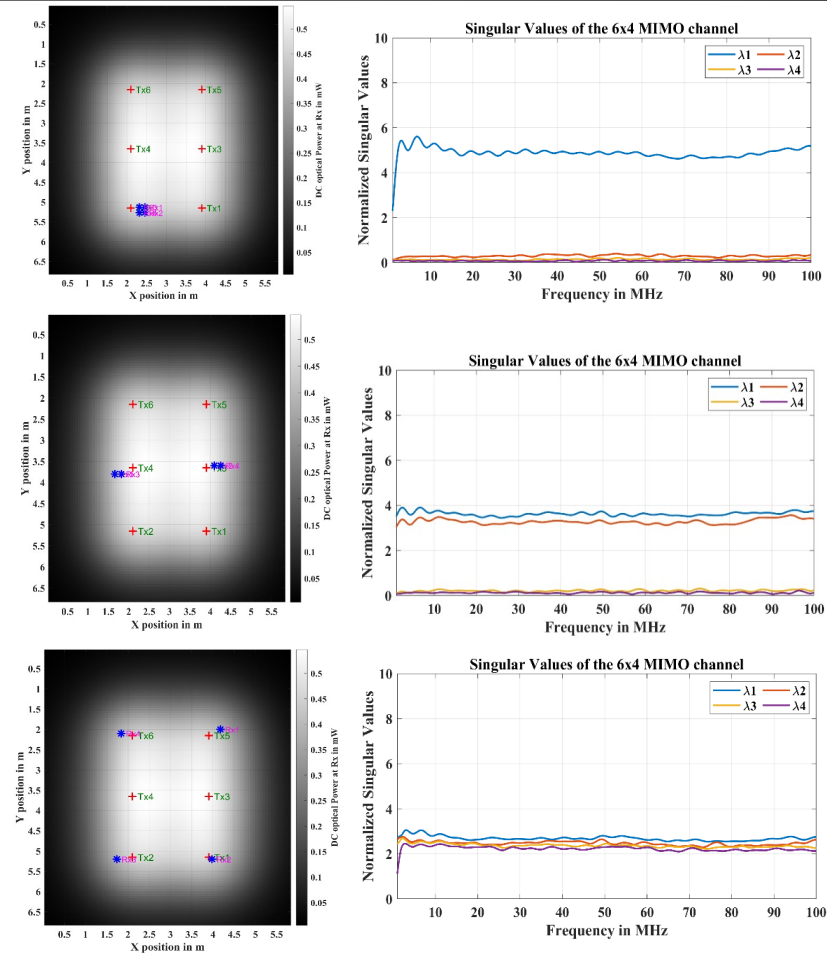

Channel rank = 1

Channel rank = 2

Channel rank = 4

# Fronthaul technologies for LC

## Polymer Optical Fiber (POF)

## Powerline Communications (PLC)

## Power-over-Ethernet (PoE)

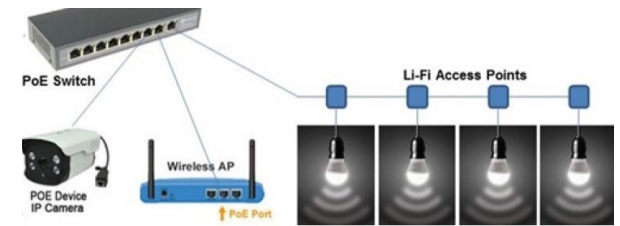
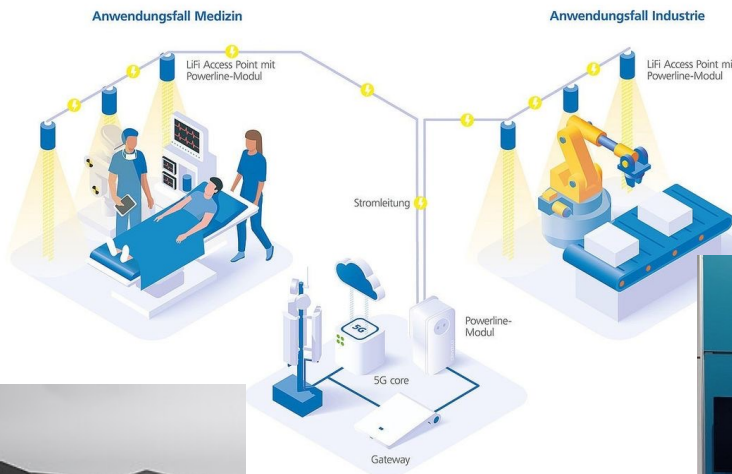
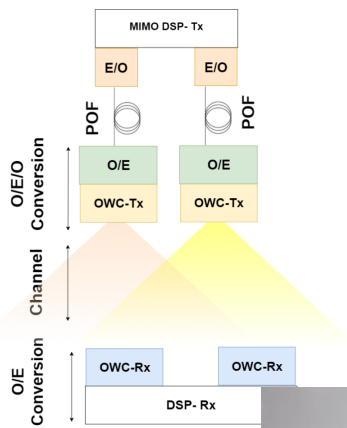

LC-over-POF  
ECOC 2022  
Fraunhofer-HHI



LC-over-PLC  
MWC 2023  
Fraunhofer  
HHI, devolo



LC-over-PoE  
Signify 2021



## How to encode over LC channel

- **LC is baseband channel, starting from DC up to some upper BW**
- **You and Kahn provided an upper bound on LC capacity (TMS bound)**

R. You and J. Kahn, „Upper-bounding the capacity of optical IM/DD Channels with multiple-subcarrier modulation and fixed bias using trigonometric moment space method“, IEEE Trans. Inf. Theory, Vol. 48, No. 2, Feb. 2002

- **Vucic provided a formula for TMS bound in frequency-selective LC channel**

J. Vucic, Ph.D. thesis, TU Berlin, 2009

$$C \left[ \frac{\text{bit}}{\text{s}} \right] \leq B_{SC} \sum_{n=1}^{N_{opt}} \log_2 \left( \underbrace{\frac{\eta^2 P_O^2}{N_D} H_n^2}_{\gamma_n} \left( 4 N_{opt} 2^{\frac{1}{2 N_{opt}}} \right)^{-1} \right)$$

$\gamma$  **effective SNR**

$B_{SC}$  **subcarrier bandwidth**

$N_{opt} \leq N - 1$  **optimal no. of carriers**

$P_O$  **optical power**

$h$  **optical path gain**

$N_D$  **detector noise**

# Optimized TMS bound

- Maximize the bound using  $N_{opt}$
- Diffused link: low-frequency subcarriers are used
- Direct link: all subcarriers are used

$B = 100 \text{ MHz}, N - 1 = 63,$   
 $B_{SC} = B / N = \text{const.},$   
 $P_O = 400 \text{ mW}, \eta = 1 \text{ A/W}$

Jelena Vucic, Ph.D. thesis, TU Berlin, 2009

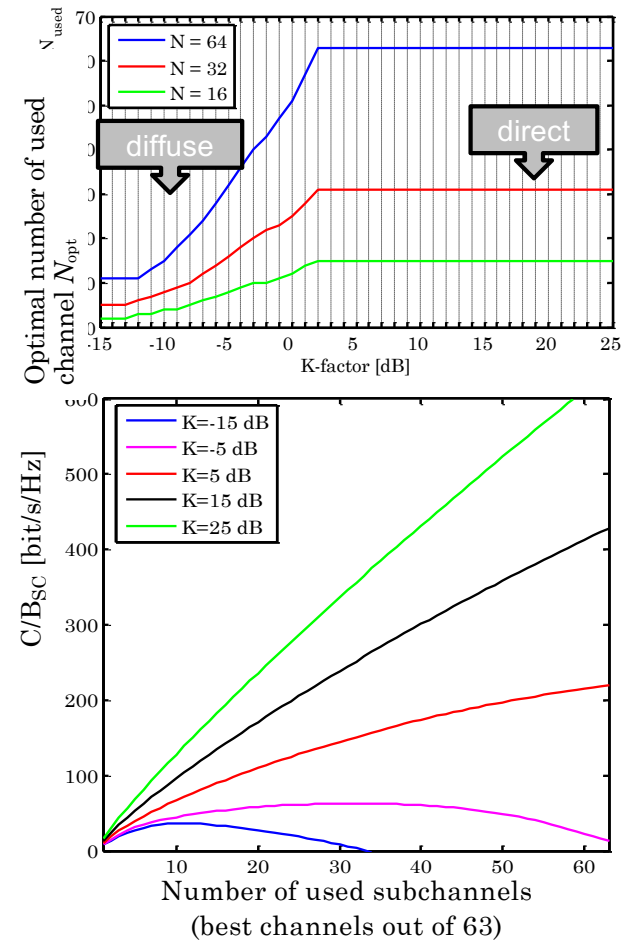

# Implementation

- **Mobile LC channel is frequency-selective and time variant**
- **Rate-adaptive approach based on feedback over the reverse link**

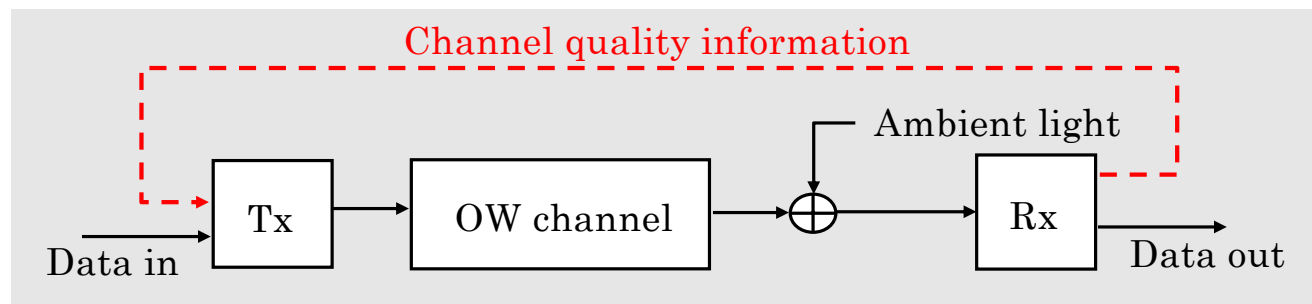

- **Compensation of channel dispersion effects**
  - Orthogonal frequency-division multiplex (OFDM)
  - Adaptive bitloading

J. Grubor et al. „Capacity Analysis in Wireless Infrared Communication using Adaptive Multiple Subcarrier Transmission, ICTON We C2.7, 2005.

# Controlled clipping

- LC waveform is clipped below zero in the digital domain

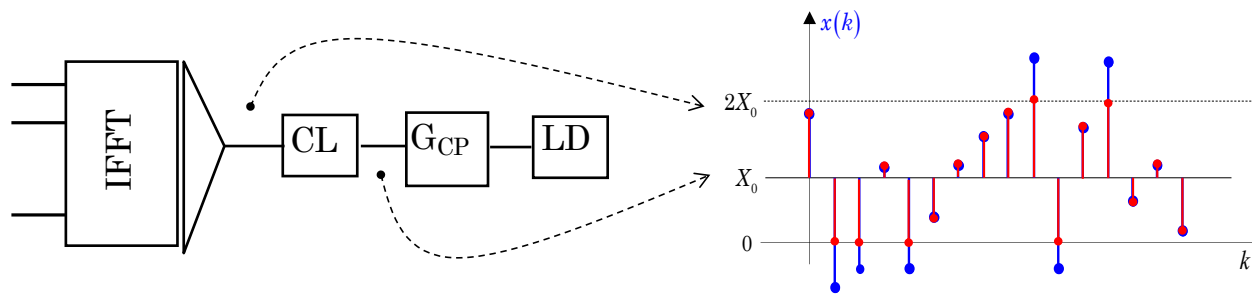

Jelena Vucic, Ph.D. thesis, TU Berlin, 2009

- **Clipping is tolerated while errors are corrected**
  - needs powerful forward error correction, such as LDPC
  - retransmissions (selective repeat)

- **Link adaptation with controlled clipping**

- inner loop: adaptive bit-loading using fixed thresholds
- outer-loop: adapt all bit-loading thresholds so that desired error rate is reached

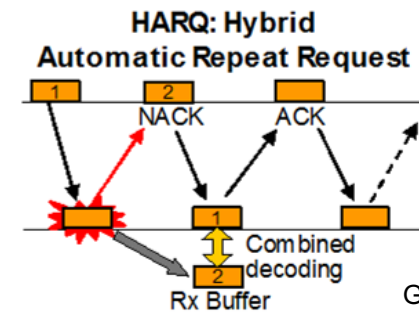

Graph from NSN

# Efficient coding over LC channels

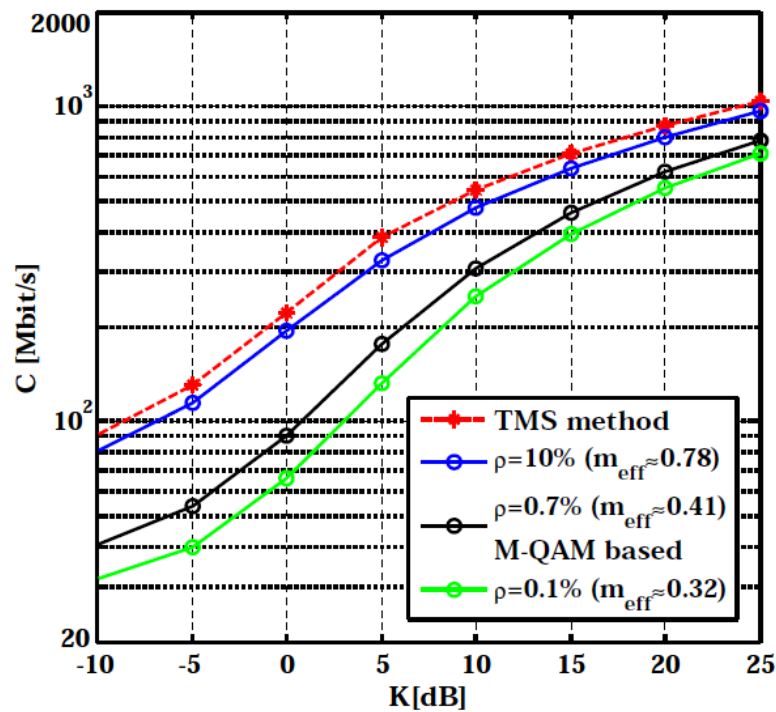

$P_{opt}=400$  mW,  $h=1A/W$ ,  $B=100$  MHz,  $N=64$

- **Red** is the upper bound using TMS
- **DCO-OFDM with waterfilling**
  - **Green**: Clipping is nearly avoided
  - **Blue**: 10% clipping probability
- **Gap to the TMS bound is very small**

J. Vucic, Ph.D. thesis, TU Berlin, 2009

- **DC-OFDM with waterfilling and controlled clipping is near to the TMS bound**



# VCSEL arrays: Bandwidth like mm-wave

- **Vertical cavity surface emitting laser (VCSEL)**
  - circular beam shape, few mW per VSEL
  - 20-30 GHz bandwidth for single VCSELs
- **VCSEL arrays**
  - 100s of VCSELs combined, parasitic L/C
  - similar area and beam shape like LED
- **Available for mass-market**
  - developed for LIDAR, also useful die LC
  - large VCSEL arrays still have few GHz BW
  - 2.5 Gbaud demonstrated in large coverage area

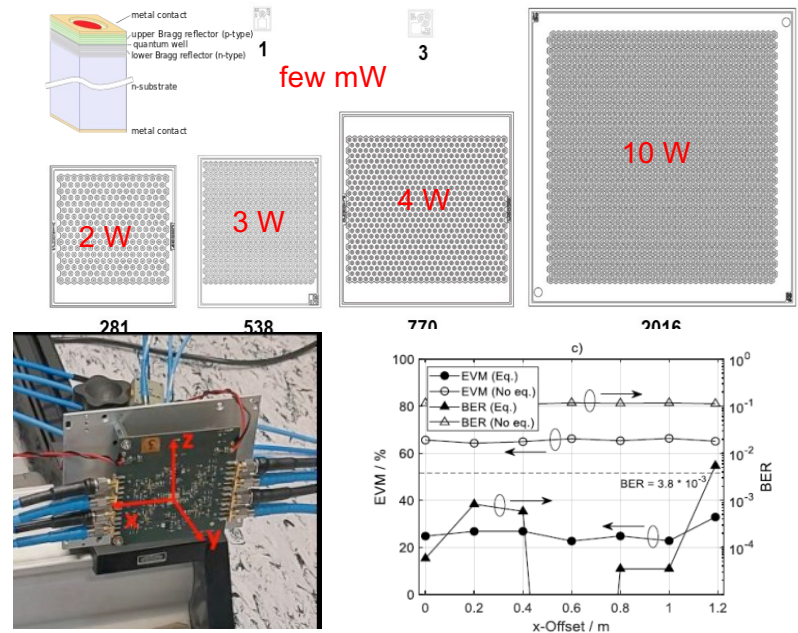

M. Hinrichs et al. Demonstration of 1.75 Gbit/s VCSEL-based Non-Directed Optical Wireless Communications with OOK and FDE ECOC 2022, paper We5.52

## Future: Individually addressable arrays

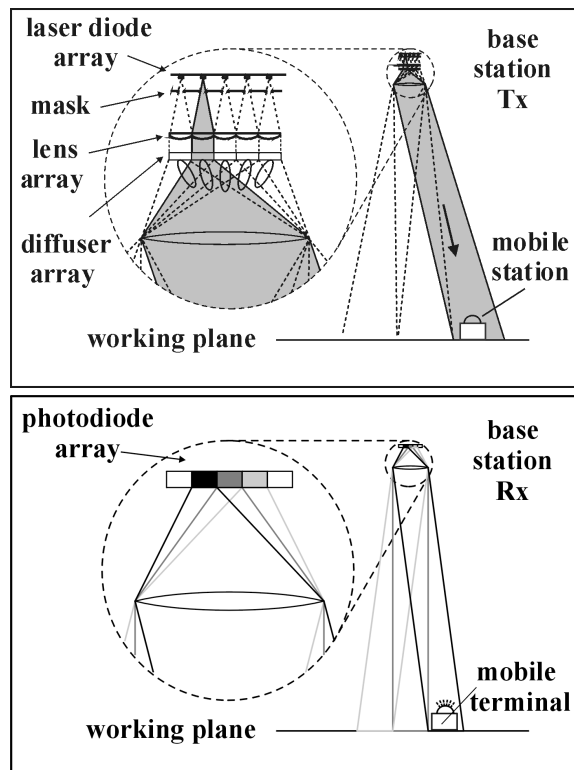

### ■ Select pixels in the TX array

- illuminate only the sector where the Rx is located
- pixel groups: complexity vs. energy savings
- higher bandwidth, use of drivers from fiber optics

### ■ Select pixels in the RX array

- smaller PD area = higher bandwidth
- bootstrapping becomes obsolete → lower noise
- spatially selective RX to suppress unwanted interference
- from ambient light or other mobile devices
- spatial multiplexing

V. Jungnickel et al., Electronic Tracking for Wireless Infrared Communications, IEEE Trans. Wireless Commun., Vol. 2, No. 5, Sept. 2003

## Impact of arrays

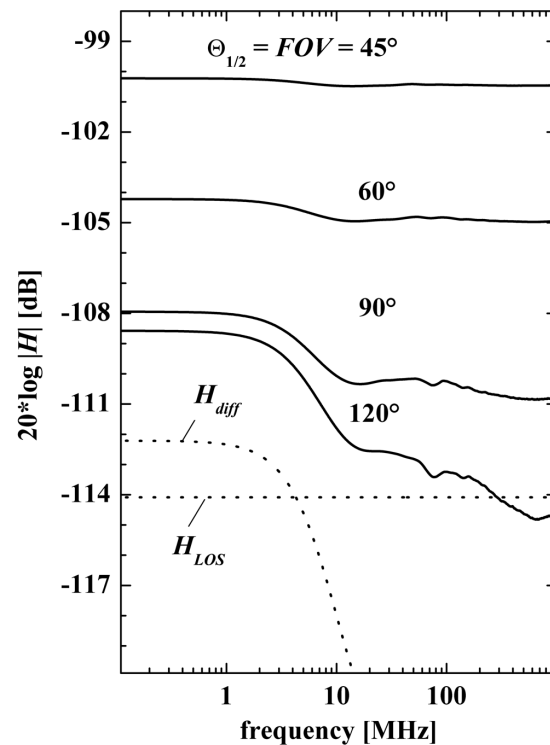

- **Shown results are for critical scenario**
  - LOS signal is increased
  - NLOS signal is reduced
- **RX power and bandwidth are increased**
- **Moderate sector sizes will be enough**
  - No need for pencil beams

V, Jungnickel et al., Electronic Tracking for Wireless Infrared Communications, IEEE Trans. Wireless Commun., Vol. 2, No. 5, Sept. 2003