

Load balancing challenges in AI fabric

Weiqiang Cheng (China Mobile)

Ruixue Wang (China Mobile)

Jieyu Li (China Mobile)

Yadong Liu (Tencent)

AI Traffic pattern challenge

Traditional DC Traffic pattern

- Many asynchronous small BW flows.
- Chaotic pattern averages out to consistent load.

AI (All-to-all Collective) Traffic Pattern

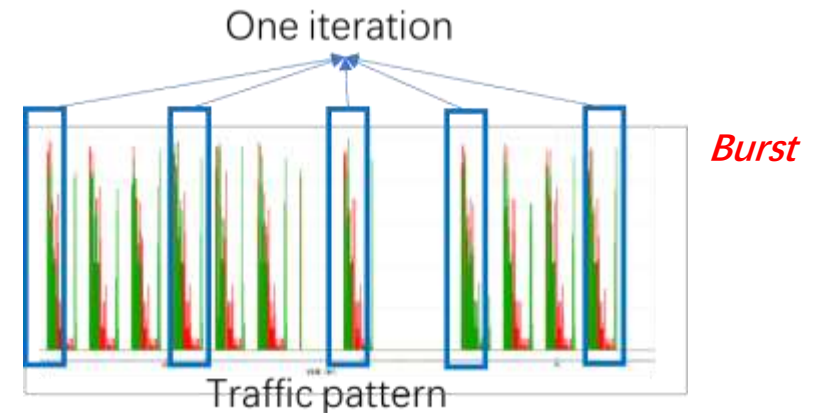
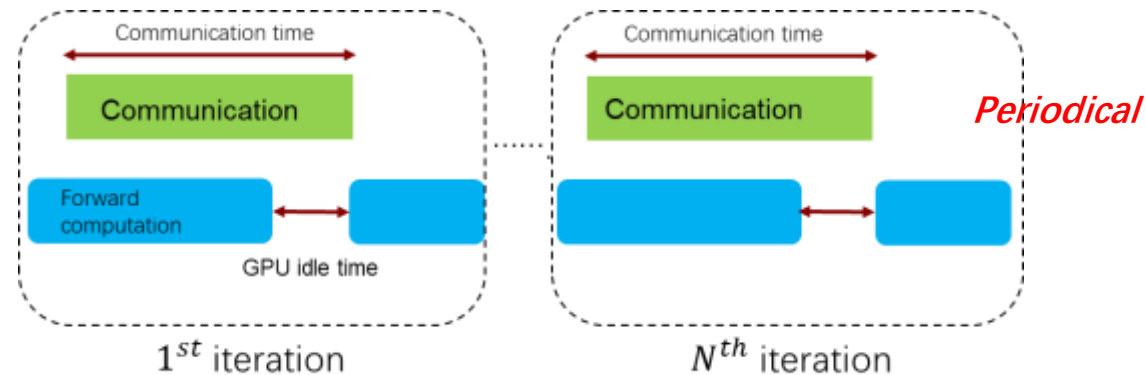

- Few **synchronous** high BW flows.
- Synchronization **magnifies** long tail latency and **bad load balancing decisions**.

Traditional flow-based LB perform poorly

- Flow-based load balancing means switches distribute packets to multiple paths in the flow granularity, and Packets within a flow take the same forwarding path.
- The **inherent drawback** of flow-based LB is its **coarse granularity**:
 - It does not take into account the size of different flows;
 - Especially in AI fabric, it's hard to balance the few and high bandwidth flows well.

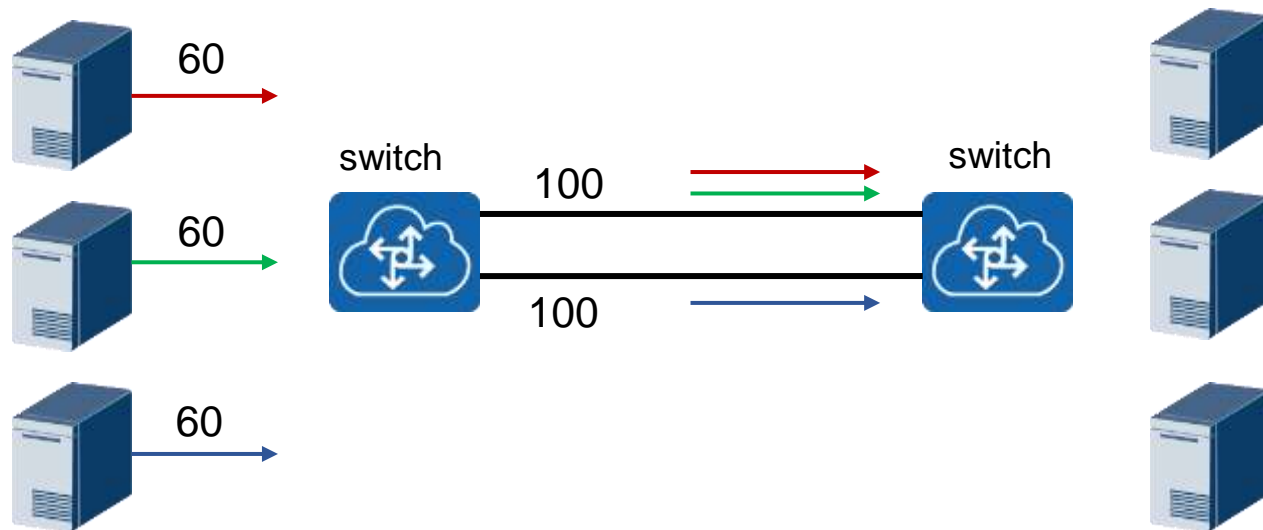

Example

- When the number of flows is not divisible by the number of available paths, it's impossible to get an optimal balance using flow-based LB.

Packet-spray-based LB become the trend for AI fabric (1)

- Packet spray means switches distribute each packet to multiple paths independently, making the load on the network more balanced than flow-based.
- There are several routes supporting packet spray:
 - Cell-based in dedicated network or ethernet-based: **Standardization** → ✓ **Ethernet-based**.
 - NIC-driven or Network-driven: **Applicable to different scenarios**. → Focus on **network-driven** solution in this document.
- **Basic Architecture of network-driven packet spraying in ethernet:**

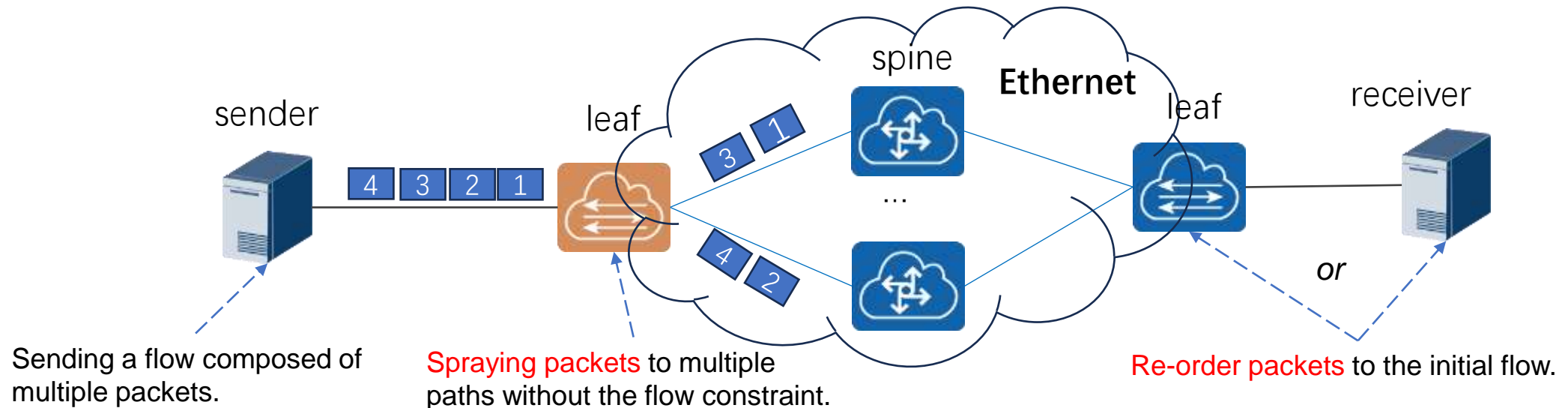

Packet-spray-based LB become the trend for AI fabric (2)

- We conduct an experiment to evaluate the performance of flow-based and packet-spray-based LB.

Experiment settings

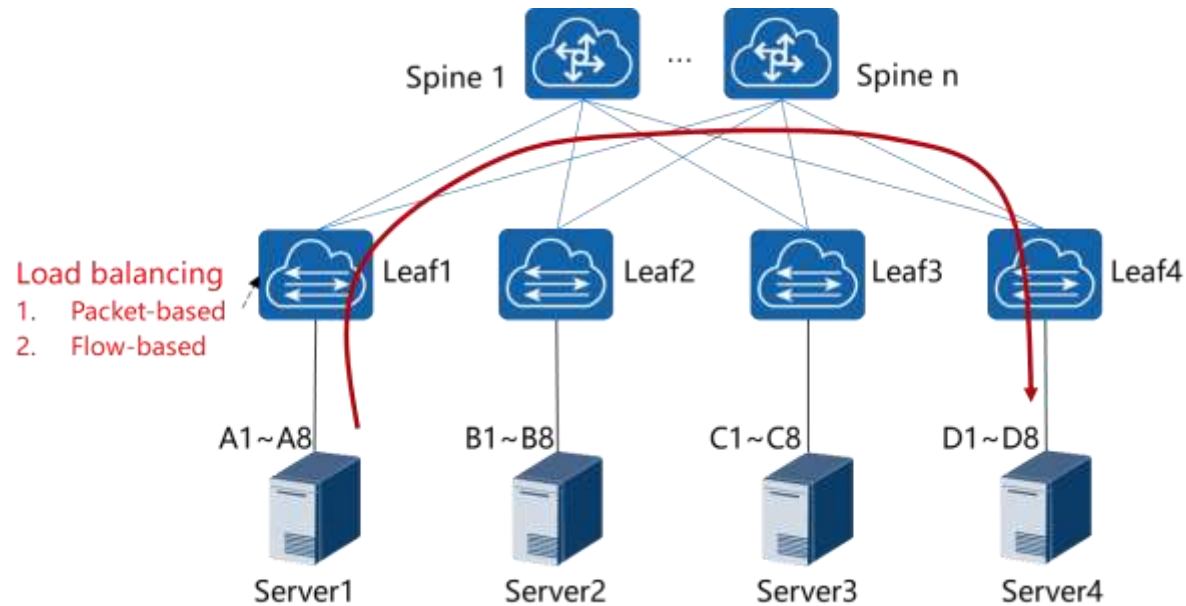

Results

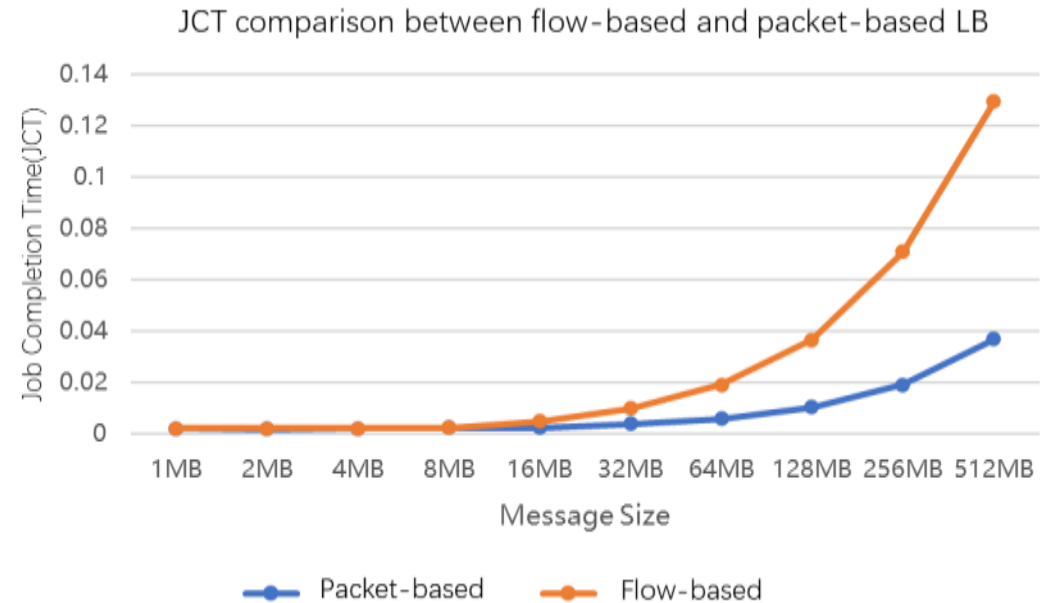

- The topology is the classic two-layer clos network, 4 servers, 8GPU with 8 NICs in a server.
- There are 8 jobs running: A1~D1、A2~D2....A8~D8.
- Testing the task completion time (JCT) of flow-based and packet-spray-based load balance under different message size.
- In a 512MB scenario, JCT of packet-spray-based LB is reduced to about **one-third** compared to flow-based.

Challenges in Packet-based LB

- The main side-effect of packet-spray-based LB is causing packets of a flow arriving at receiver **out of order**:

- Re-order problem.

- **Reliability problem: Loss-detection and retransmission;**

- **Out-of-order** cause performance degradation significantly under **Go-back-N** mechanism.

- The mainstream RNIC adopt Go-back-N mechanism to provide reliability.
- A lot of out-of-order packets may trigger frequently Go-back-N, resulting in a precipitous decline in throughput, as shown in the right emulation.

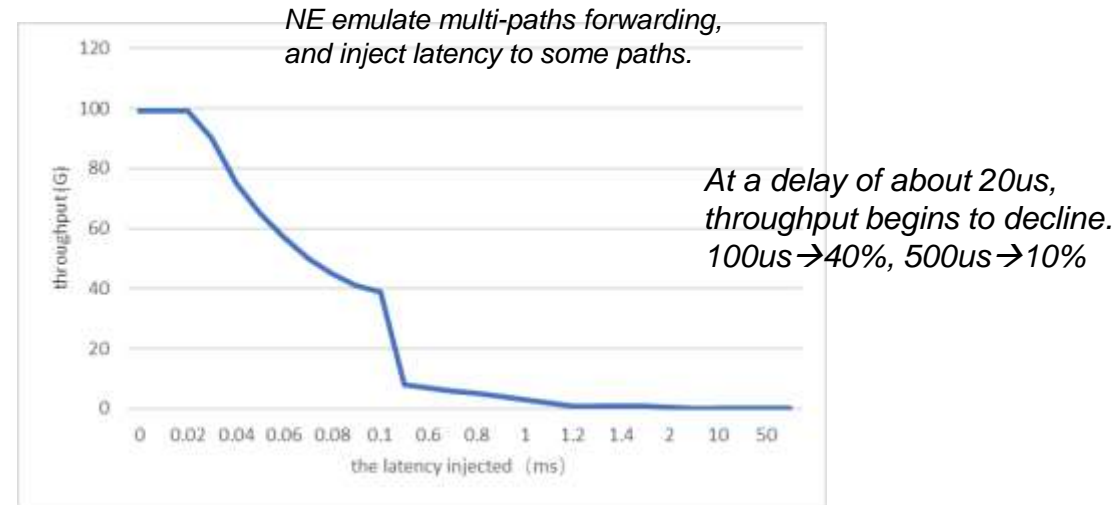
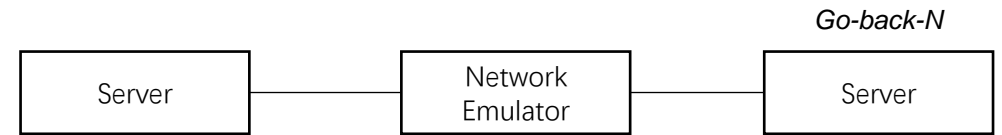

- **RNIC can adopt Selective ACK to improve GO-back-N, but still existing problems hindering performance.**

- The receiver **can not directly determine** whether **the packet is lost or just out of order** through the PSN,
- **relying on the timeout mechanism** to detect packet loss **reduces the sending rate.**
- **Accurate fast-retransmit is necessary, but only by receiver is often not possible.**

- **A preliminary conclusion is that processing out-of-order packets exclusively on the receiver NIC can hardly achieve optimal performance.**

Network can do more...

- In packet-spray-based LB, the root difficulty of **receiver** dealing with out of order packets is that **it does not know the forwarding path and state of each packet**.
- An intuitive solution is that **network provide receiver the path information of packet forwarding** to help loss detection and fast retransmission.

Key idea: network device **insert the path information(e.g. Path ID) into packet header**, so that the receiver can detect the loss more quickly and execute fast retransmission.

Example

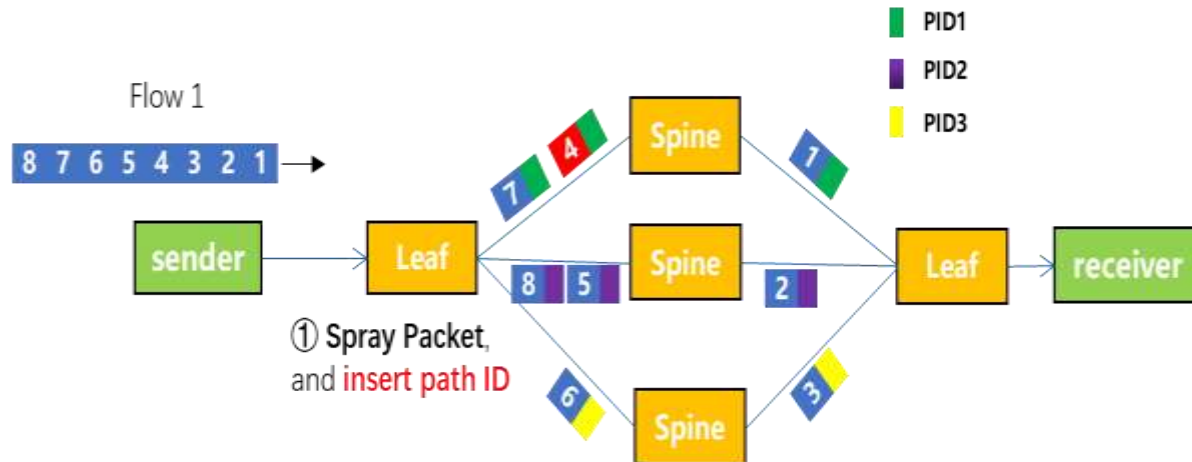

② Update the receiving window of flow 1, *assume the 'hole' is packet 4:*

PSN	1	2	3	4	5	6	7	8
state	1	1	1	0	1	1	1	0

③ Update the max receiving PSN of each path of flow 1:

- Path 1: maxRcvPSN[1]:7
- Path 2: maxRcvPSN[2]:5
- Path 3: maxRcvPSN[3]:6

④ Compare the hole number with maxRcvPSN of each path:

- If hole number < maxRcvPSN of all paths → Packet 4 loss

Current industrial support for packet-based LB

① Cisco: Silicon one

- *“An alternate solution is to use a fully scheduled fabric to connect the GPUs. This approach **sprays packets** across all links and reorders the packets at the exit, so no network congestion builds up. Simply put, it allows for an ideal interconnect under all traffic conditions.”*
- [Solutions - Cisco Silicon One Product Family White Paper - Cisco](#)

② Broadcom: Tomahawk 5

- *“It supports both **per-packet spray** and flowlet modes of operation and can be enabled selectively for different traffic types with ineligible flows falling back to hash-based ECMP. DLB is successfully deployed in multiple networks today.”*
- [Cognitive routing in the Tomahawk 5 data center switch \(broadcom.com\)](#)

③ Juniper: Junos OS

- *“**Randomly sprays the packets** to the aggregate next hops to ensure that the next hops are equally loaded resulting in packet reordering.”*
- [Per-packet random spray load balancing | Juniper Networks Pathfinder Feature Explorer](#)

.....

- **The mainstream chip vendors (Cisco, Broadcom, Nvidia..) have supported the packet spraying to balance load, but their solutions are different. → **standardization of packet-spray-based load balancing on ethernet is needed.****

Summary

- Introduce the drawbacks of traditional flow-based ECMP for AI fabric, and packet-spray-based load balancing become the trend.
- Analyze the challenges bring to receiver in packet-spray-based load balancing.
- Network can assist receiver to solve the challenges.
- **Potential Standard Requirements:** Need to standardize path information in L2 for network-assisted fast retransmission, such as path ID.

Next Action

- **Propose a Study/Work Item** : Packet-Spray-Based AI Fabric
- **Scope** : Packet-Spray-Based Load Balance 、 Packet-Spray-Based Congestion Control、 Reorder、 Ethernet QoS、 Telemetry、 high-precision OAM、 Protection etc.

Thank You !