

Ambiguity in the MAC Service

Roger Marks
(EthAirNet Associates; Huawei)

roger@ethair.net

+1 802 capable

2022-06-15

Copyright policy note: “Q: Do I need permission if I am using IEEE standards for comparison or discussion only? A: IEEE SA Working Groups are permitted to present (i.e., display during a Working Group meeting) and review information from an approved IEEE standard.”

-see <https://standards.ieee.org/faqs/copyrights/working-group-and-activity-chairs/>

MAC Service Specifications

- Sources considered here:
 - IEEE Std 802-2014
 - *IEEE Standard for Local and Metropolitan Area Networks: Overview and Architecture*
 - IEEE Std 802.1Q-2018
 - *IEEE Standard for Local and Metropolitan Area Networks — Bridges and Bridged Networks*
 - IEEE Std 802.1AC-2016
 - *IEEE Standard for Local and metropolitan area networks — Media Access Control (MAC) Service Definition*
 - IEEE Std 802.2-1998
 - *Logical Link Control*
 - IEEE Std 802.3-2018
 - *IEEE Standard for Ethernet*

MAC Service per IEEE Std 802

- *The MAC sublayer provides one or more MAC service access points (MSAPs) as interfaces to the LLC sublayer in an end station.*
- *Figure 7 shows the position of the bridging functions within the MAC sublayer; note particularly that relaying and filtering are considered to belong entirely within the MAC sublayer.*

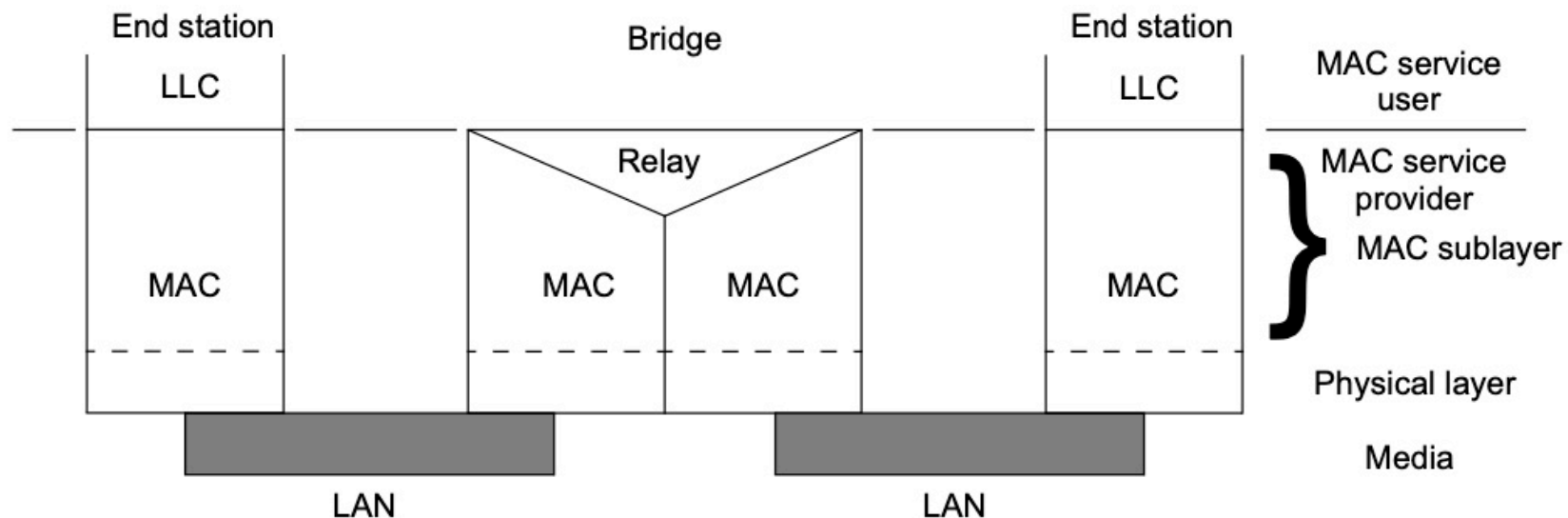

Figure 7—Internal organization of the MAC sublayer with bridging

MAC Service per IEEE Std 802.2

- *This subclause specifies the services required of the MAC sublayer by the LLC sublayer to allow the local LLC sublayer entity to exchange LLC data units with peer LLC sublayer entities.*
 - *NOTE—Work is in progress to produce a single-service specification that is common to all the MAC sublayers. When this is available, it will be referenced in this International Standard instead of the current MAC service text.*
 - *MA-UNITDATA request: This primitive requests the transfer of an MSDU from a local LLC sublayer entity to a single peer LLC sub-layer entity, or multiple peer LLC sublayer entities in the case of group addresses.*
 - *MA-UNITDATA indication: This primitive defines the transfer of a MSDU from the MAC sublayer entity to the LLC sublayer entity, or entities in the case of group addresses. In the absence of errors, the contents of the data parameter are logically complete and unchanged relative to the data parameter in the associated MA-UNITDATA request primitive.*
 - *When generated: The MA-UNITDATA indication primitive is passed from the MAC sublayer entity to the LLC sublayer entity or entities to indicate the arrival of a frame at the local MAC sublayer entity. Frames are reported only if at the MAC sublayer they are validly formatted, received without error, and their destination address designates the local MAC sublayer entity*
- **Note:** The standards mix “MA-UNITDATA” and “MA_UNITDATA”.

MAC Service per IEEE Std 802.1Q (1/2)

- *Abstract: This standard specifies how the Media Access Control (MAC) Service is supported by Bridged Networks...*
 - *6. Support of the MAC Service*
 - *The MAC Service provided in end stations attached to MAC Bridged Networks and Virtual Bridged Networks is the (unconfirmed) connectionless mode MAC Service defined in IEEE Std 802.1AC. The MAC Service is defined as an abstraction of the features common to a number of specific MAC Services; it describes the transfer of user data between source and destination end stations, via MA-UNITDATA request primitives and corresponding MA-UNITDATA indication primitives issued at MAC Service Access Points (MSAPs). Each MA-UNITDATA request and indication primitive has four parameters: Destination Address, Source Address, MAC Service data unit (MSDU), and Priority.*

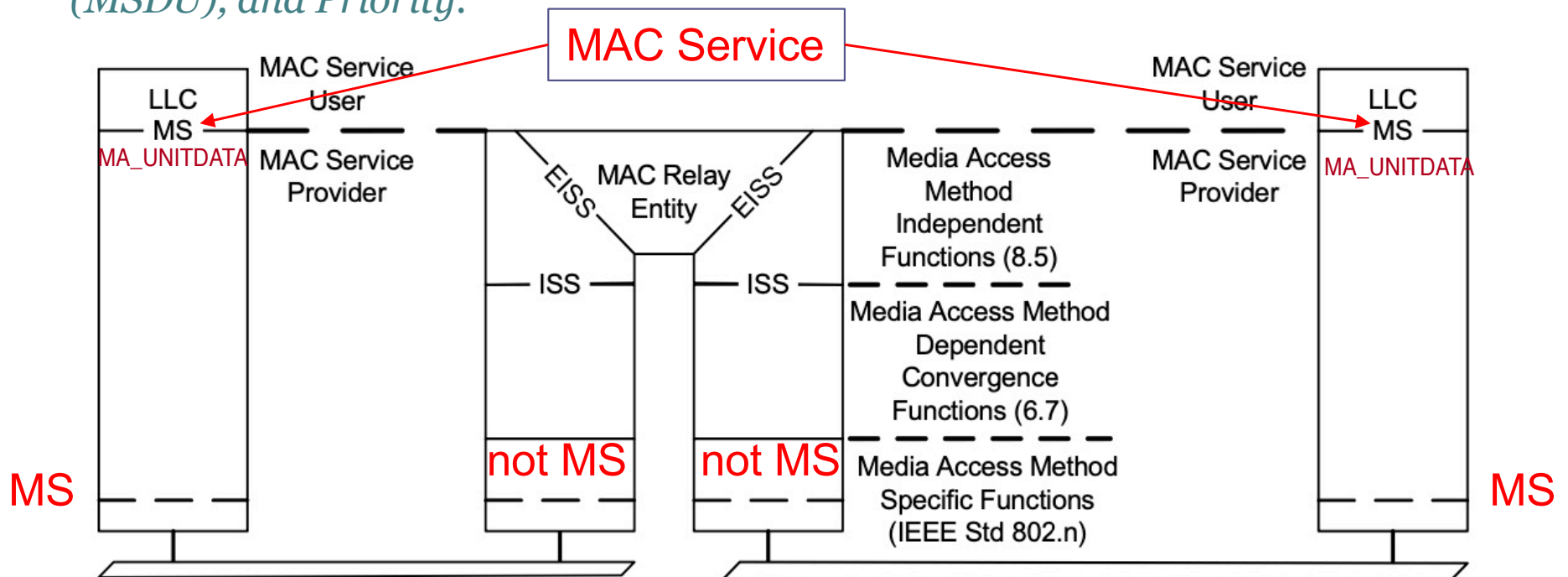

MAC Service per IEEE Std 802.1Q (2/2)

- MAC services terminating at the bridge itself (special case).

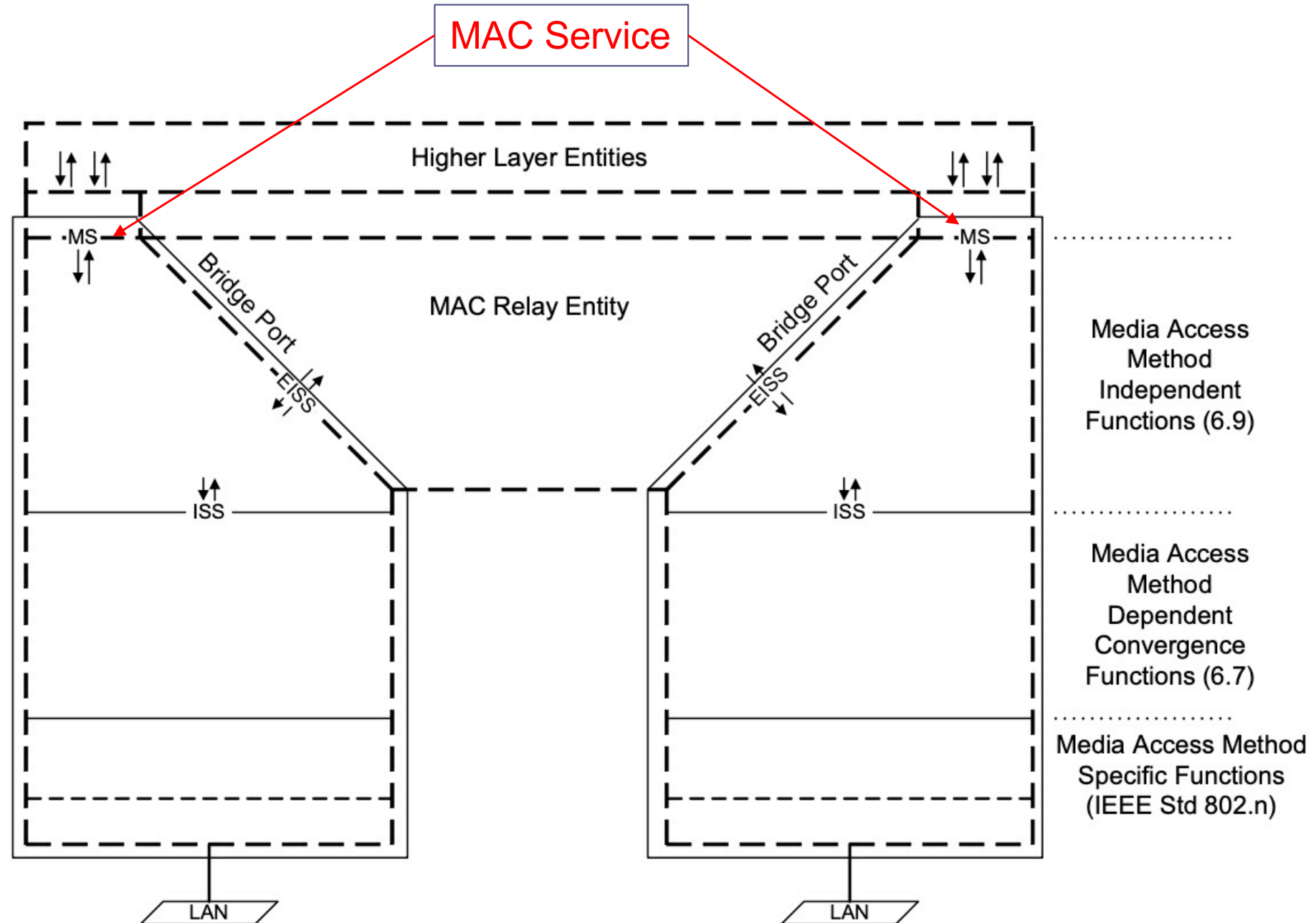

MAC Service per IEEE 802.1AC (1/2)

- *The MAC Service provides a connectionless-mode service for the transparent transfer of data between MAC Service users. It makes invisible to these MAC Service users the way that supporting communications resources are used to achieve this transfer.*

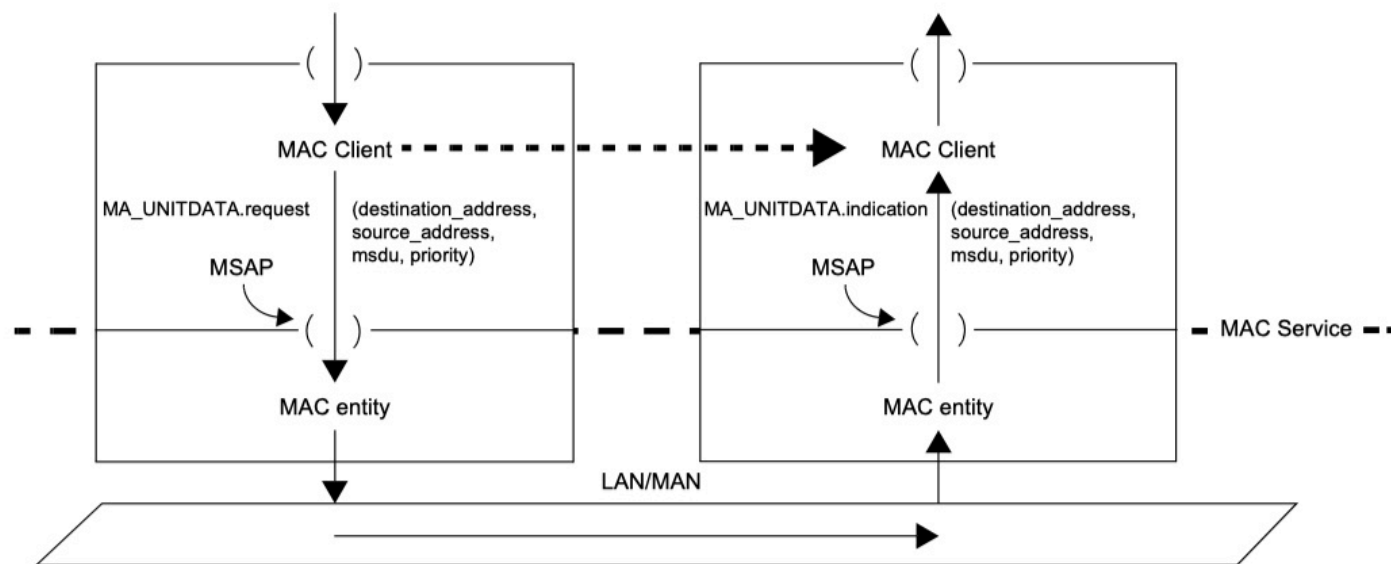

- *Two unit-data primitives are specified for the connectionless-mode data transmission service, an MA_UNITDATA.indication and an MA_UNITDATA.request, together with the parameters of those primitives. Each MA_UNITDATA indication corresponds to the receipt of an error-free MAC frame from a LAN. A data request primitive is invoked to transmit a frame to an individual LAN.*
 - MA_UNITDATA.request and MA_UNITDATA.indication are not detailed, as they are in IEEE 802.2. For example, no “when generated” statement.

MAC Service per IEEE 802.3 (1 / 3)

- *Media Access Control (MAC) service specification*
 - *The services provided by the MAC sublayer allow the local MAC client entity to exchange LLC data units with peer LLC sublayer entities.*
 - *MAC clients may include the Logical Link Control (LLC) sublayer, Bridge Relay Entity, or other users of ISO/IEC LAN International Standard MAC services*

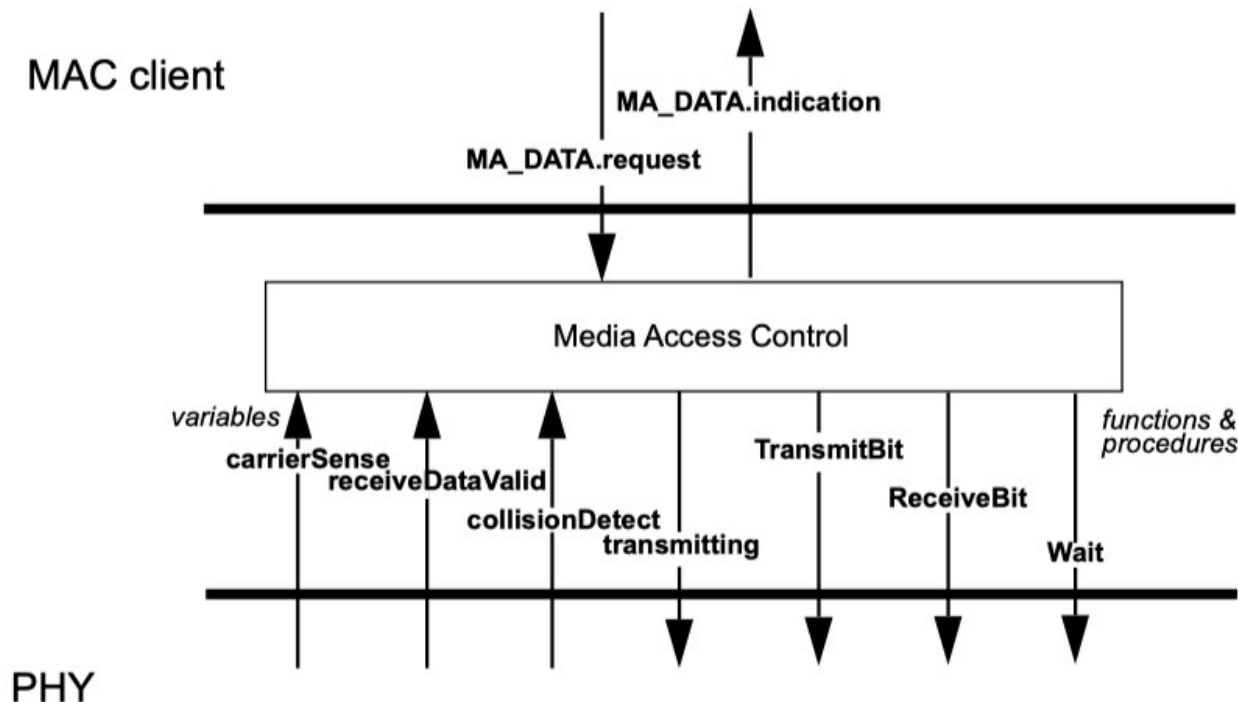

MAC Service per 802.1AC (2/2)

- (MAC Service primitives) can be used to transmit an independent, self-contained MSDU from one MSAP to another MSAP in a single service access
- [at a bridge ISS] Each MAC entity examines all frames received on the LAN to which it is attached. All error-free received user data frames give rise to M_UNITDATA indication primitives.
- For the Ethernet Convergence Function:

 - When the convergence function receives an MA_DATA.indication primitive from the underlying MAC Service, it generates a corresponding M_UNITDATA.indication ...
 - When the convergence function receives an M_UNITDATA.request primitive, it generates a corresponding MA_DATA.request to the underlying MAC Service:...

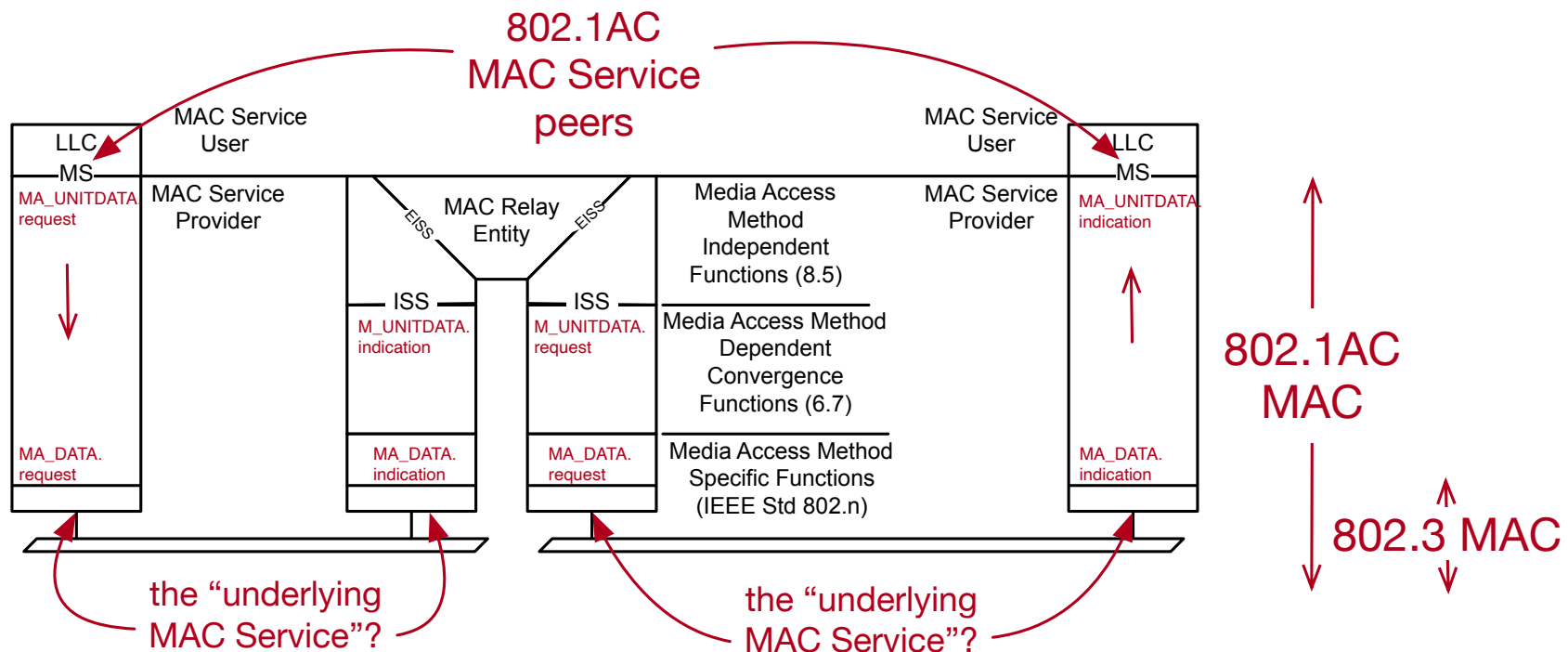

MAC Service per IEEE 802.3 (2/3)

- *2.3 Detailed service specification [MAC Service]*
 - *MA_DATA.indication ... defines the transfer of data from the MAC sublayer entity... to the MAC client entity or entities....*
 - *When generated: MA_DATA.indication is passed from the MAC sublayer entity... to the MAC client entity or entities to indicate the arrival of a frame to the local MAC sublayer entity that is destined for the MAC client. Such frames are reported only if they are validly formed, received without error, and their destination address designates the local MAC entity.*
 - This description matches the functionality required at the end station.
 - But it seems no MA_DATA.indication is passed to a bridge (unless DA is local).
- *4/4A Frame reception*
 - *ReceiveFrame ... calls the internal function ReceiveDataDecap to return the frame's fields to the MAC client if the frame's address indicates that it should do so. [see function LayerMgmtRecognizeAddress]*
 - *The MAC sublayer may also provide the capability of operating in the promiscuous receive mode. In this mode of operation, the MAC sublayer recognizes and accepts all valid frames, regardless of their Destination Address field values.*
 - but promiscuous receive mode seems to not provide the 802.3 MAC Service of Clause 2 and not generate MA_DATA.indication, per Clause 2
 - *Though Figure 4A-4 seems to indicate that MA_DATA.indication is provided in promiscuous mode*

MAC Service per IEEE 802.3 (3/3)

Note: Note whenever there is any apparent ambiguity concerning the definition of some aspect of the MAC method, it is the Pascal procedural specification in 4A.2.7 through 4A.2.10 that should be consulted for the definitive statement. That excludes this figure.

4A.3.2.2.4 MAC client receive interface state diagram

Figure 4A–4 specifies the behavior of the receive interface to the MAC client.

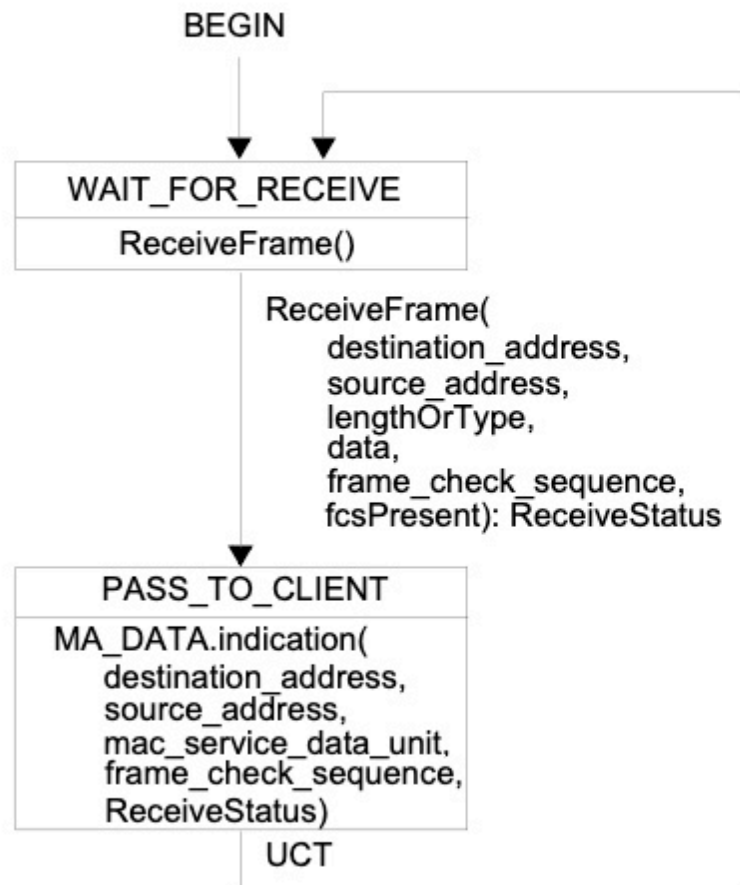

Passes received frames to client, regardless of frame errors and (in promiscuous mode) regardless of destination address.

Error details (in ReceiveStatus) are passed to Client, though “ReceiveStatus is not mapped to any MAC client parameter by the service interface defined in 2.3.2.” But, per 2.3.2.2, it “is used to pass status information to the MAC client entity”.

802.3 (2.3.2.5) says parameter “is not mapped to any parameter and is ignored by MA_UNITDATA.indication” (and the same for MA_UNITDATA.indication).

802.1AC maps MA_DATA.indication to M_UNITDATA.indication but does not refer to the ReceiveStatus field.

Figure 4A–4—MAC client receive interface state diagram

Example Issues

- IEEE Std 802.3 (§3.4) says:
 - *The contents of invalid MAC frames shall not be passed to the LLC or MAC Control sublayers. Invalid MAC frames may be ignored, discarded, or used in a private manner by MAC clients other than LLC or MAC control.*
 - IEEE 802.3 says “MAC clients may include the Logical Link Control (LLC) sublayer, Bridge Relay Entity, or other users of ISO/IEC LAN International Standard MAC services”
 - So, are invalid MAC frames passed (or can they be passed) to the bridge Convergence Function?
- It’s been said that the MAC does not know whether it’s sitting under an LLC entity or a bridge.
 - **But the 802.3 MAC does know the difference:**
 - If the client is LLC, the MAC filters by DA and generates MA_DATA.indication.
 - If the client is the Convergence Function, it seems promiscuous mode must be used.
- If the DA-filtering behavior depends on the nature of the client, then can other behaviors (e.g., error-filtering behavior) also depend on the nature of the Client?
 - Note: Per 4A, errored frame results in MA_DATA.indication, with error reported in field ReceiveStatus (which “is not mapped to any MAC client parameter by the service interface defined in 2.3.2” and “may be used in an implementation dependent manner.”)
- Issues like these have fed misunderstanding in Cut-Through Forwarding discussions.

Extra Issue: Synchronicity

- 802.3 §4A.2.9 :
 - *The ReceiveFrame operation is synchronous. The operation does not complete until a frame has been received.*
- 802.3 §4A.3.1 :
 - *The synchronous (one frame at a time) nature of the frame transmission and reception operations is a property of the architectural interface between the MAC client and MAC sublayers, and need not be reflected in the implementation interface between a station and its sublayer.*
- Question:
 - What is the distinction between the “architectural interface” and the “implementation interface”?
 - 802.3 §4A.2.2.1:
 - *The handling of incoming and outgoing frames is rather stylized in the procedural model, in the sense that frames are handled as single entities by most of the MAC sublayer and are only serialized for presentation to the Physical Layer. In reality, many implementations will instead handle frames serially on a bit, octet or word basis. This approach has not been reflected in the procedural model, since this only complicates the description of the functions without changing them in any way.*
 - Does “implementation” infer “conformance”?
 - As in the term “Protocol implementation conformance statement (PICS)”?

Questions

- Is the MAC service as understood by 802.1AC the same MAC service as understood by 802.3?
- Does 802.3 specify how operation is differentiated when the client is the Convergence Function?
 - Does it specify that promiscuous receive mode is required?
 - Does it provide an alternative to the “MAC Service”?
 - Does it specify an alternative to MA_DATA.indication?
 - Does 802.3 specify how the MAC identifies the nature of the client so it can determine when to use promiscuous receive mode?
- Is the Ethernet Convergence Function of 802.1AC consistent with IEEE Std 802.3?
 - It depends on MA_DATA.indication, but 802.3 (§2.3) specifies that MA_DATA.indication is not issued to the relay.
 - Should it specify promiscuous receive mode?
- Should the IEEE 802 architecture be amended to clarify the nature of the MAC Service and how the upper (LLC-to-LLC MAC) Service is related to the lower (LLC-to-bridge) service supported in a LAN link?
 - Should the terminology distinguish the end-to-end MAC from the MAC link?
- Is there a need for better understanding and harmonization of the architecture and interfaces among IEEE 802 standards?