

VLAN-aware end stations in the IEEE 802 Architecture

Notice to WG Chair: This contribution is “previously published” per the IEEE SA Copyright Policy, as it includes material previously published in IEEE Std 802.1Q and IEEE Std 802.

Note: Personal views of contributor expressed herein.

Roger Marks (EthAirNet Associates; Huawei)

roger@ethair.net

+1 802 capable

4 February 2022

Do VLANs belong in the 802 Architecture?

- *I suspect that the real difference between our approaches to 802 is that I strongly disagree that IEEE Std 802 should make more than passing mention of VLANs. VLANs are not an architectural concept fundamental to IEEE 802. It is the service that is fundamental; VLANs are merely a multiplexing technique for the service, on par with virtualization techniques such as Ethernet-over-XYZ.*
 - Norm Finn
 - Nendica reflector, 2022-01-27
- Thanks to Norm for articulating the concern. This contribution is a first attempt to address it.

VLANs in IEEE Std 802

- IEEE Std 802-2014
 - No reference to VLAN-aware end stations.
 - Minimal references to VLANs in bridges:
 - *IEEE Std 802.1Q adds additional capabilities to the bridge specification in IEEE Std 802.1D including virtual local area networks (VLANs), priorities, and provider bridging, as described in 5.3.2.5.*
 - *IEEE Std 802.1Q specifies the method by which the MAC service is supported by virtual bridged LANs, the principles of operation of those networks, and the operation of VLAN-aware bridges, including management, protocols, and algorithms.*
- This document is not about bridging; it is about VLAN-aware end stations.
 - *end station: A functional unit in an IEEE 802 network that acts as a source of, and/or destination for, link layer data traffic carried on the network.*

VLANs in MAC Standards

- MAC standards recognize the existence of the VLAN tag (C-Tag)
- Do not say how it got into the frame.
- Do not say how it is used at the end station.
- IEEE Std 802.3
 - Recognizes VLAN-tagged frame as distinct
 - not simply a particular EtherType
 - Extended maximum length
- IEEE Std 802.11
 - Recognizes VLAN tags as frame classifiers
- IEEE Std 802.16
 - Recognizes VLAN tags as frame classifiers

VLAN-aware end stations in 802.1Q

- See IVL example in F.1.2:

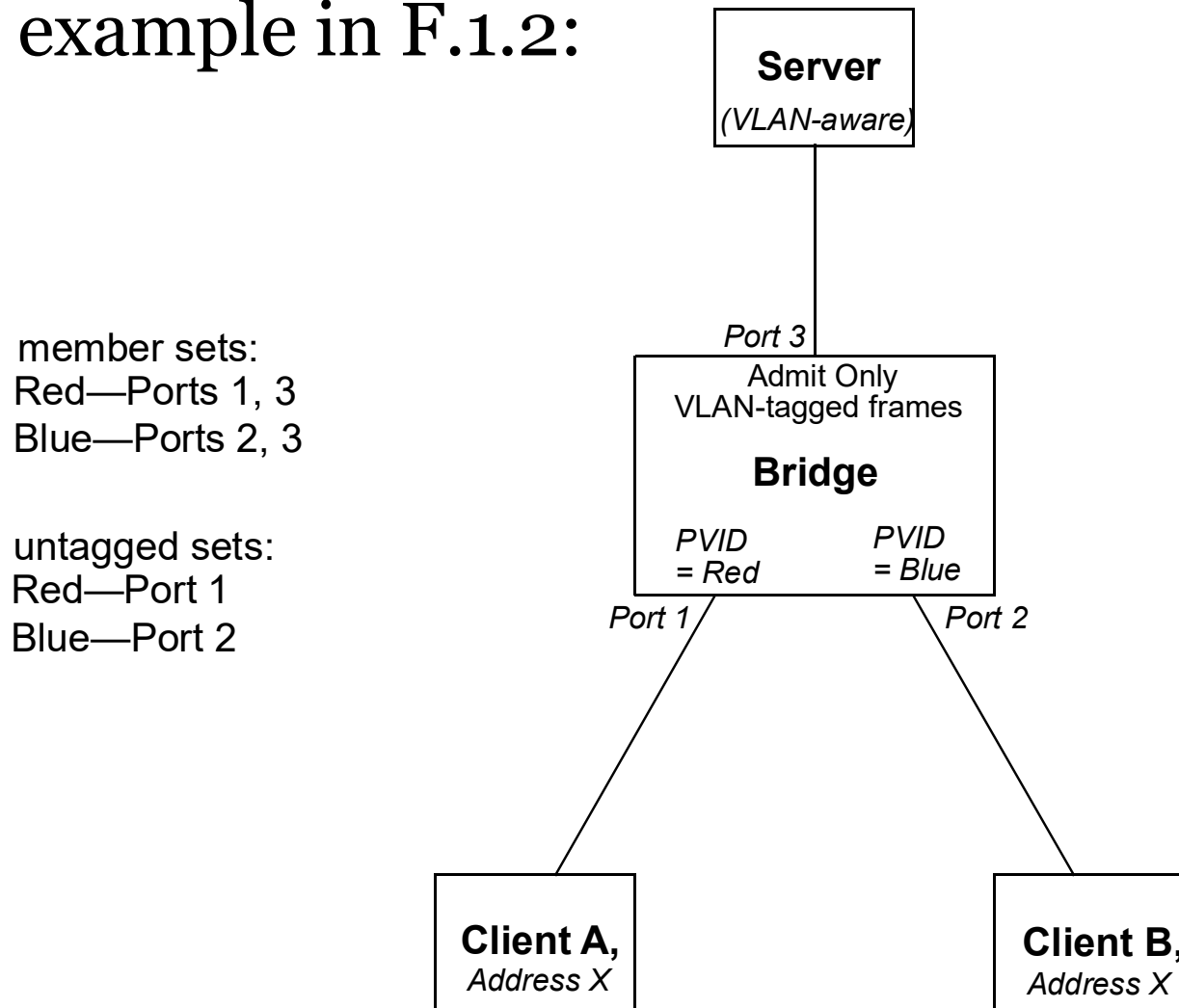

Figure F-3—Duplicate MAC addresses

IEEE 802 Reference Model

MSAP MAC service access point
LSAP link service access point

PSAP PHY service access point

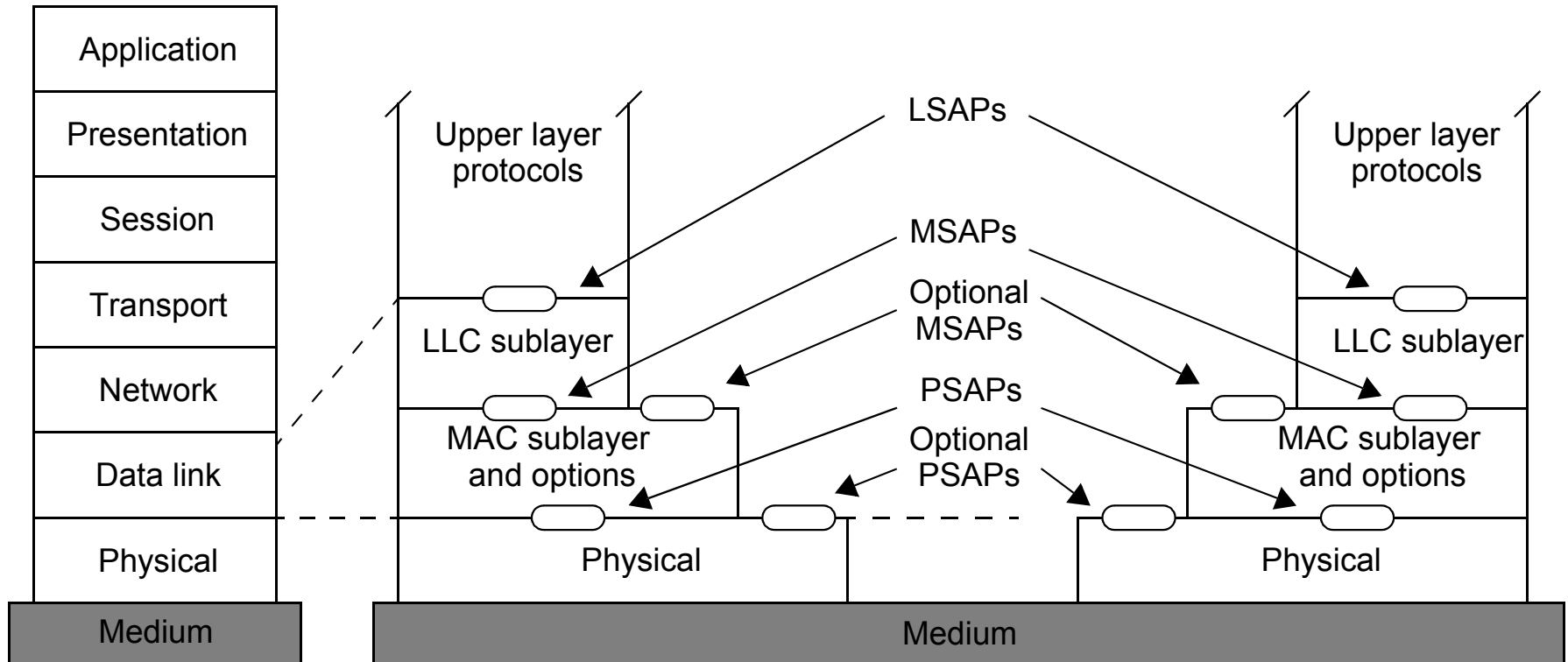
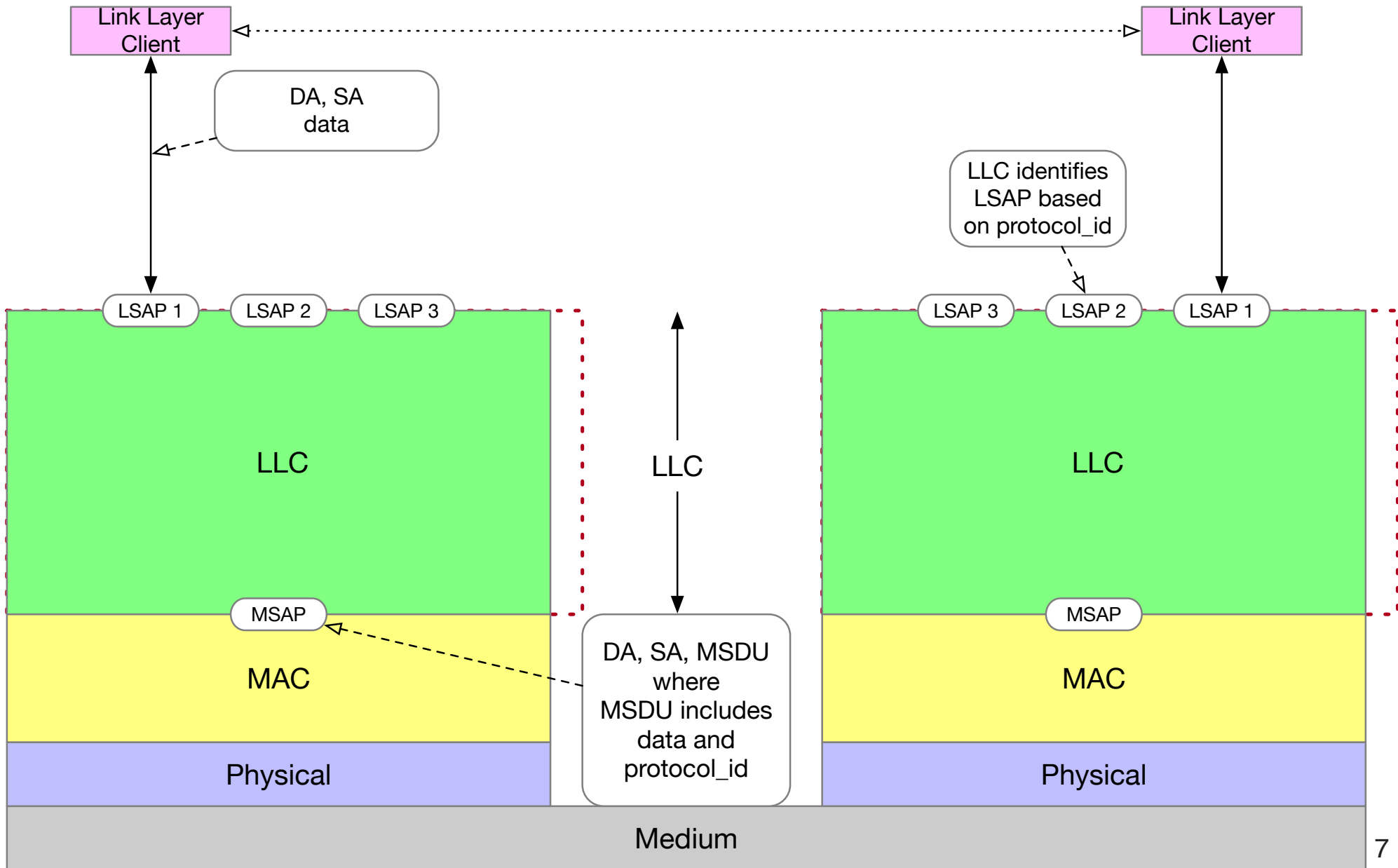
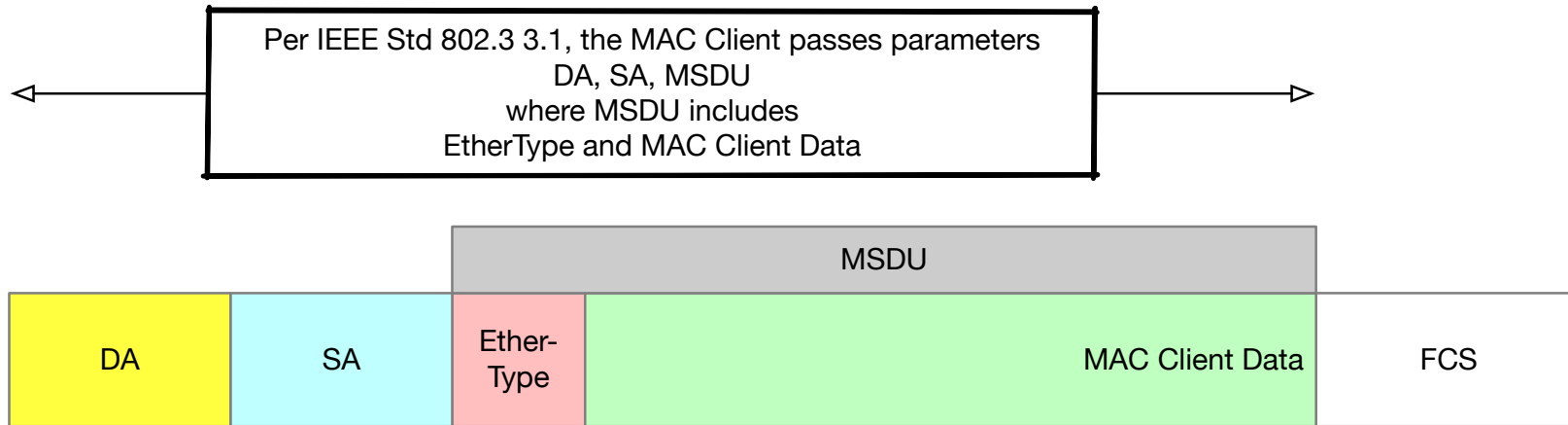

Figure 3—IEEE 802 RM for end stations

Tagless 802 reference model



example: Ethernet frame with EtherType



MAC Client may be LLC, Bridge Relay, other

VLAN tag (C-tag)

[example: Ethernet frame with EtherType]

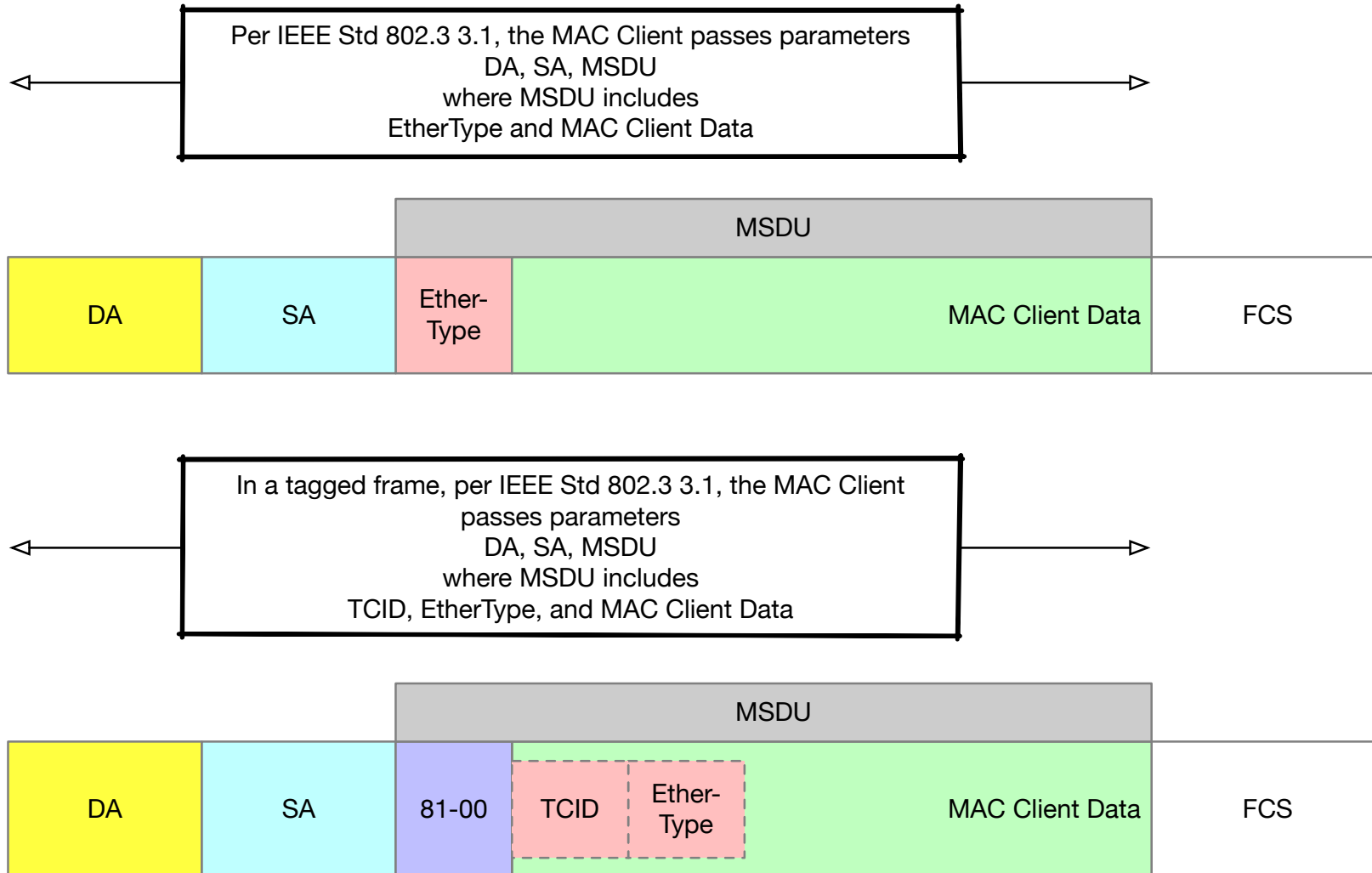

TCID source and sink in VLAN-aware end station

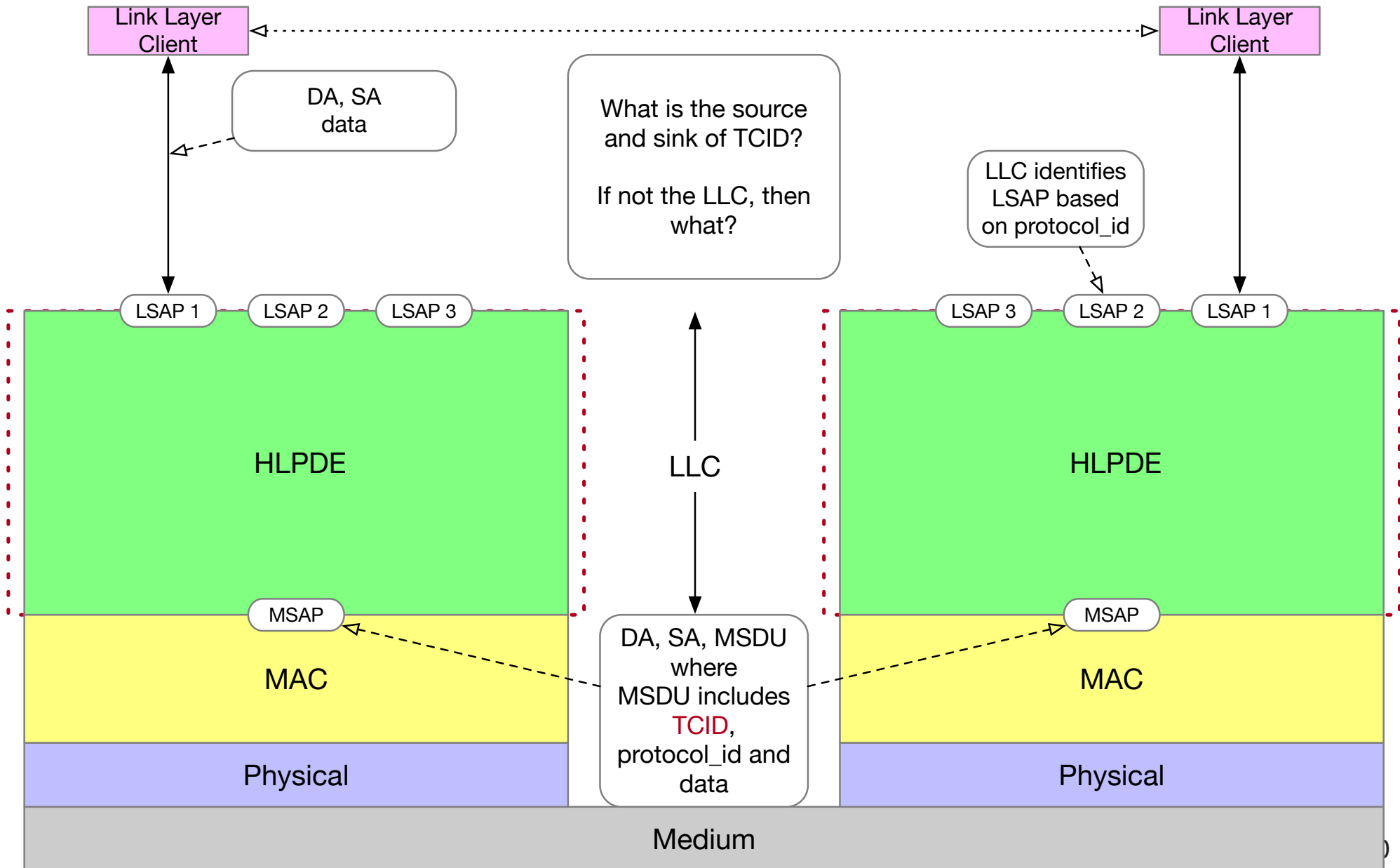

LLC handles TCID

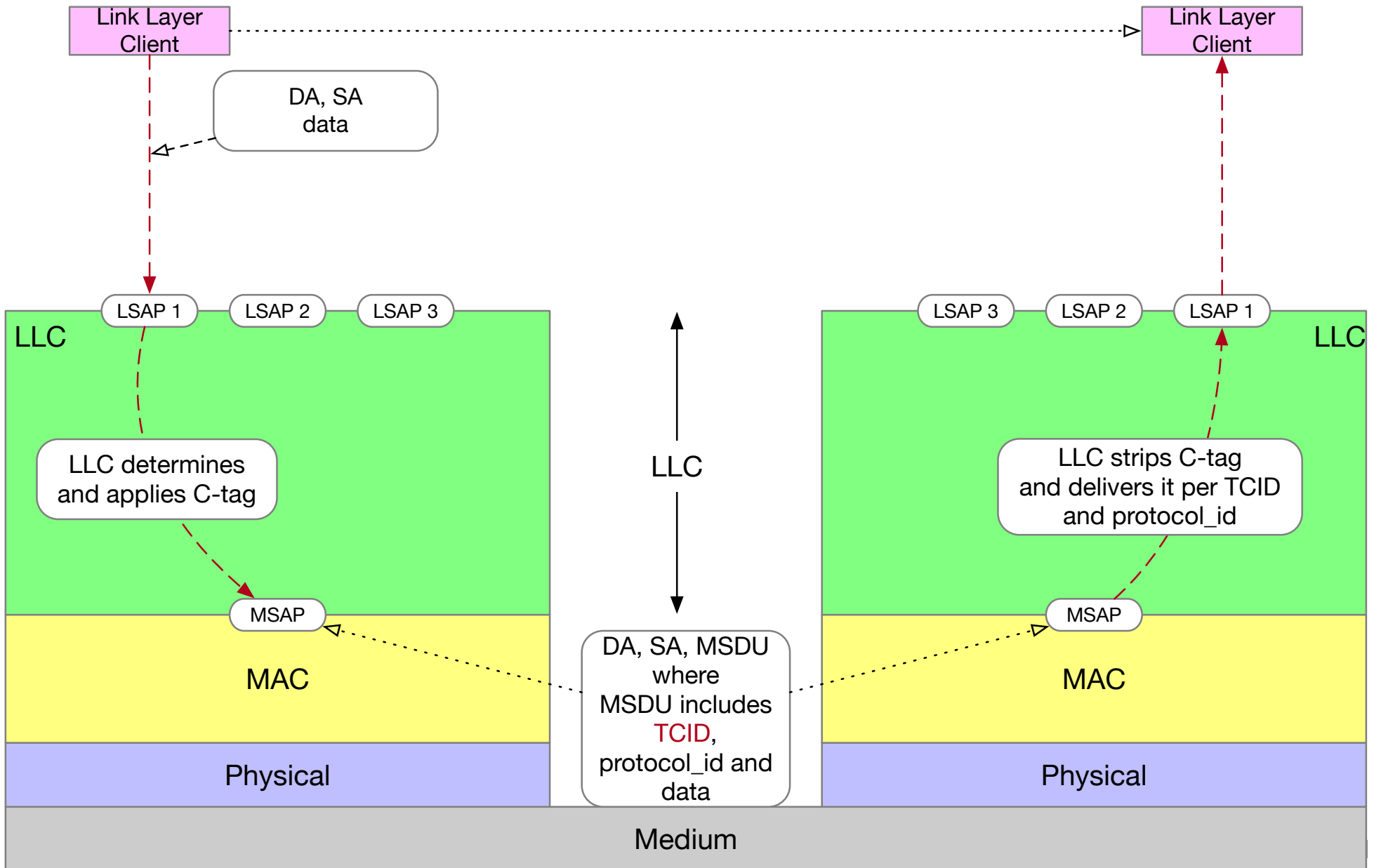

VLAN-aware end station requires VLAN-aware LLC

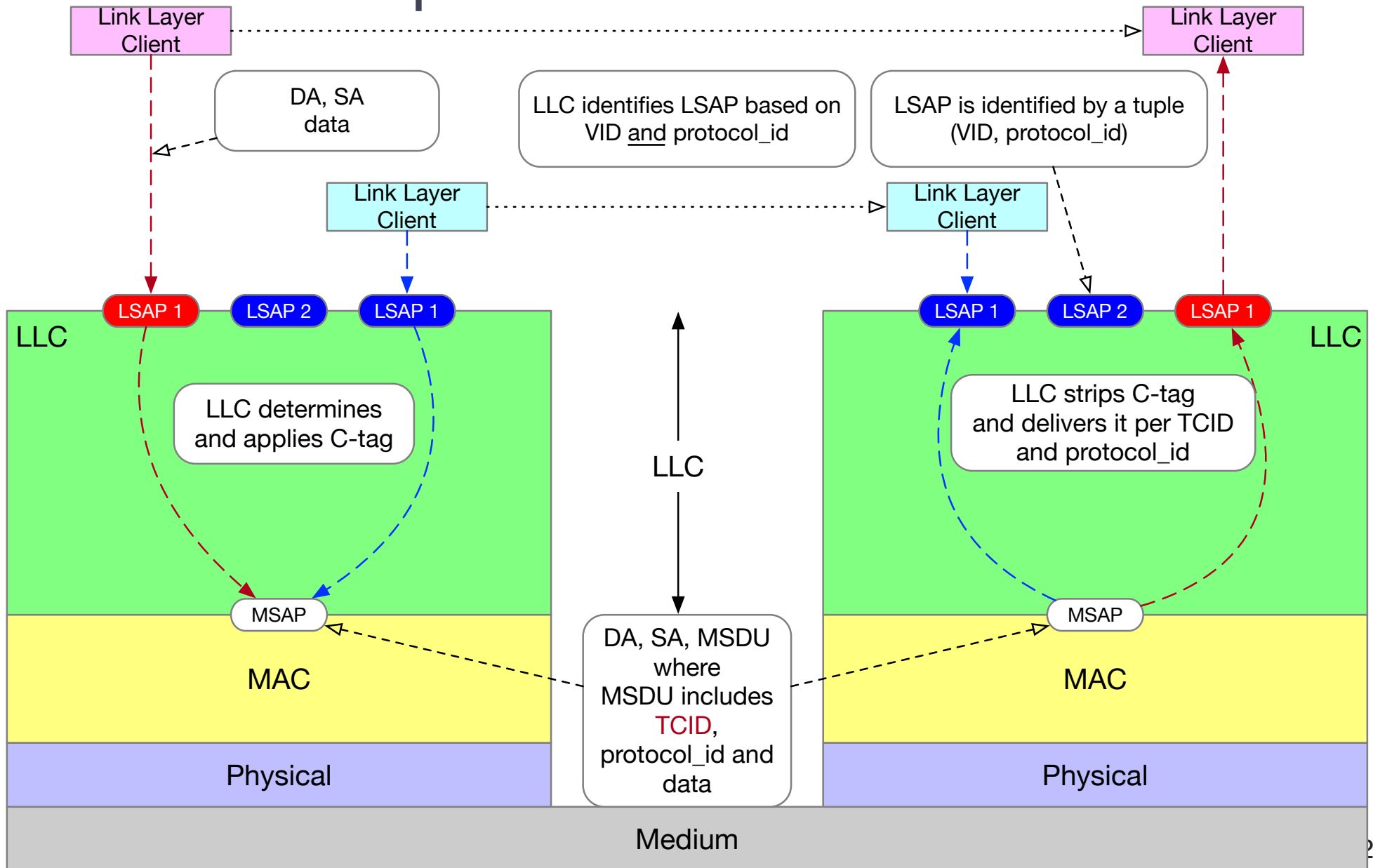

Partition LLC into HLDPE and C-tag Entity

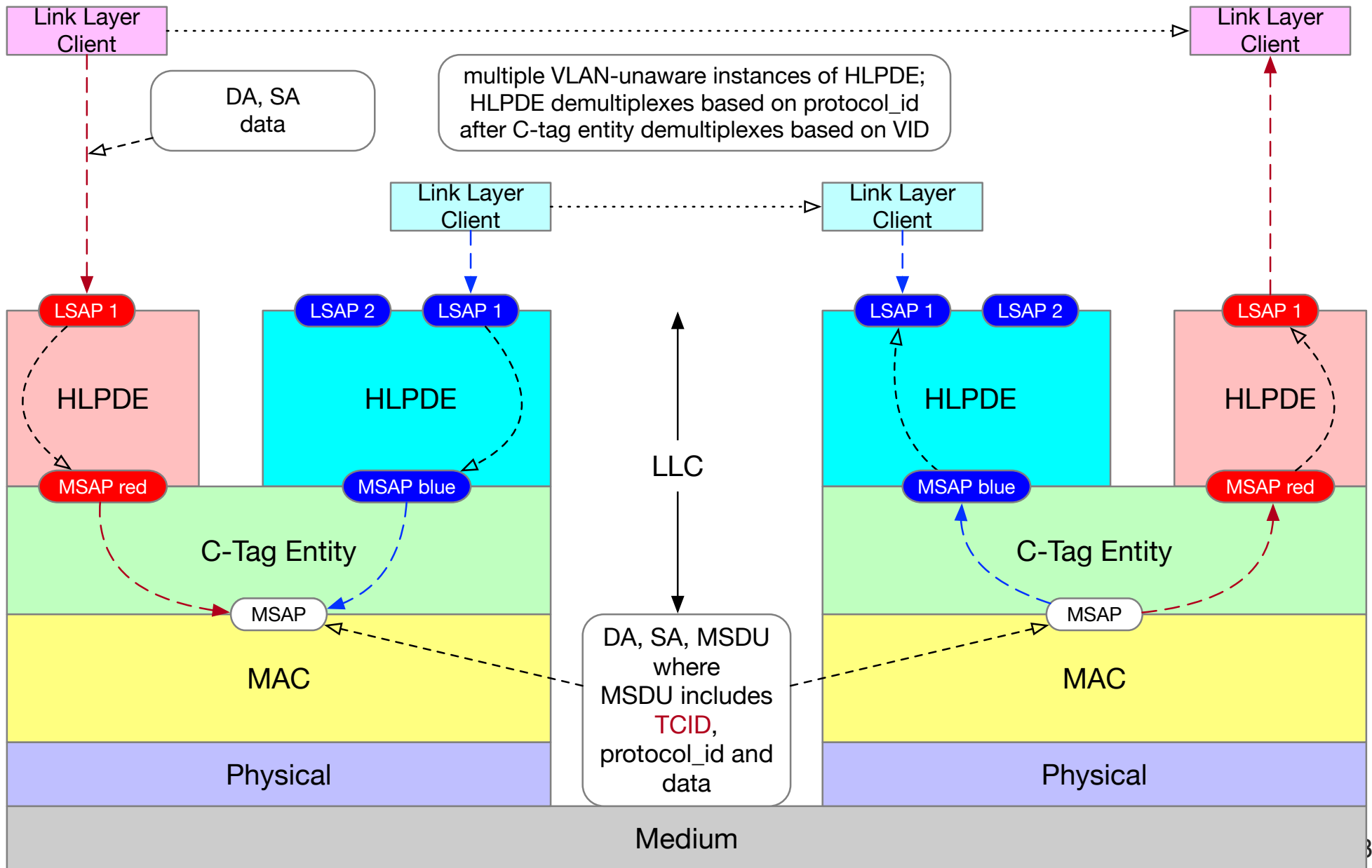

EISS Multiplex Entity in 802.1Q

The EISS Multiplex Entity enables **shims** defined for the ISS to use the EISS. Figure 6-6 illustrates two EISS Multiplex Entities placed back-to-back.

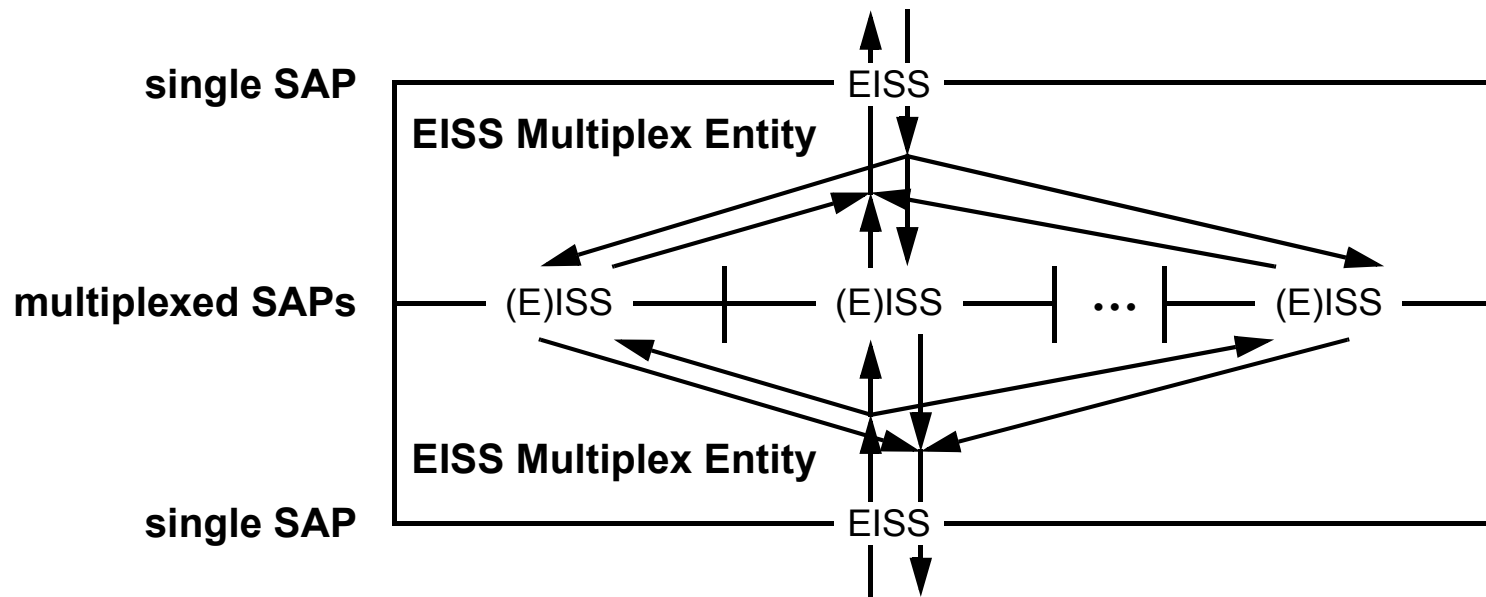
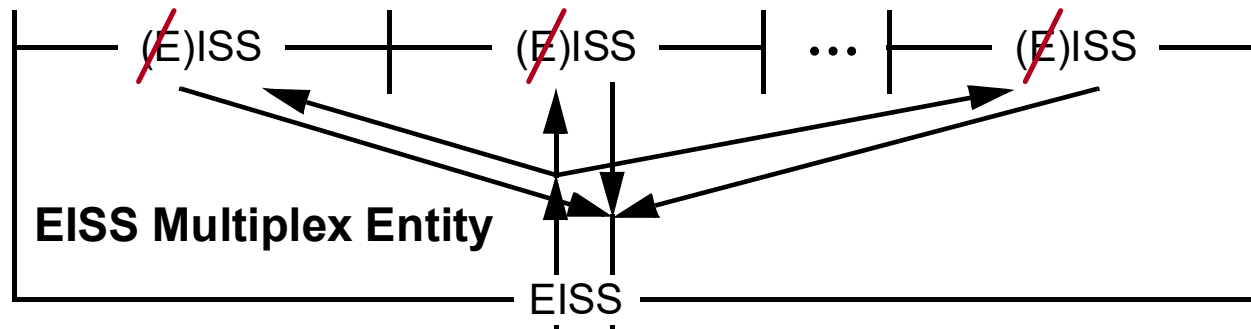

Figure 6-6—Two back-to-back EISS Multiplex Entities

VLAN-aware end station per 802.1Q

*A **VLAN-aware end station** can use the EISS Multiplex Entity (6.17) to provide multiple SAPs, one per VID of interest, to separate MAC Clients.*

-IEEE Std 802.1Q-2018



Division of LLC into HLDPE and EISS Multiplex Entity

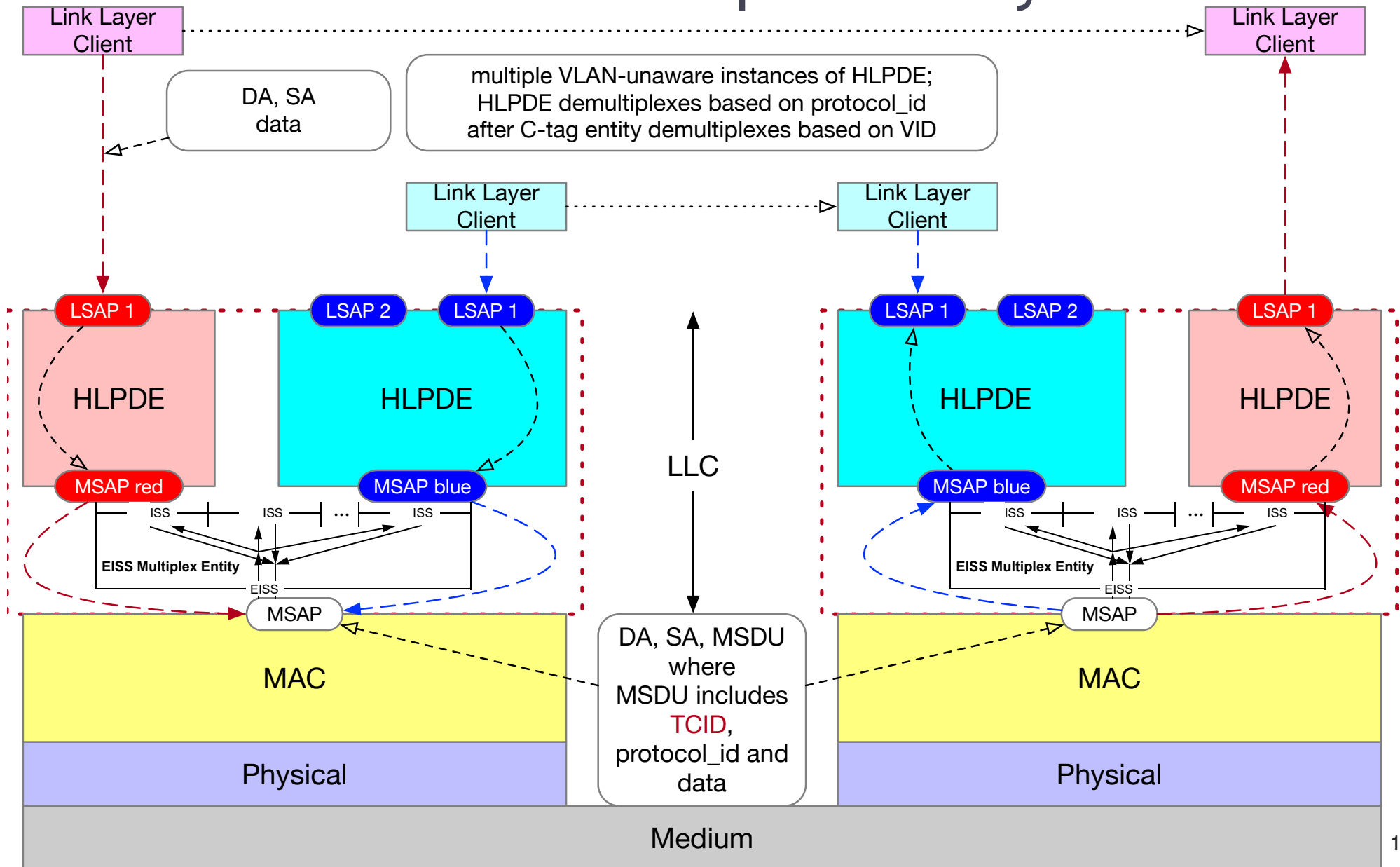

VLAN-aware HLPDE includes EISS Multiplex entity

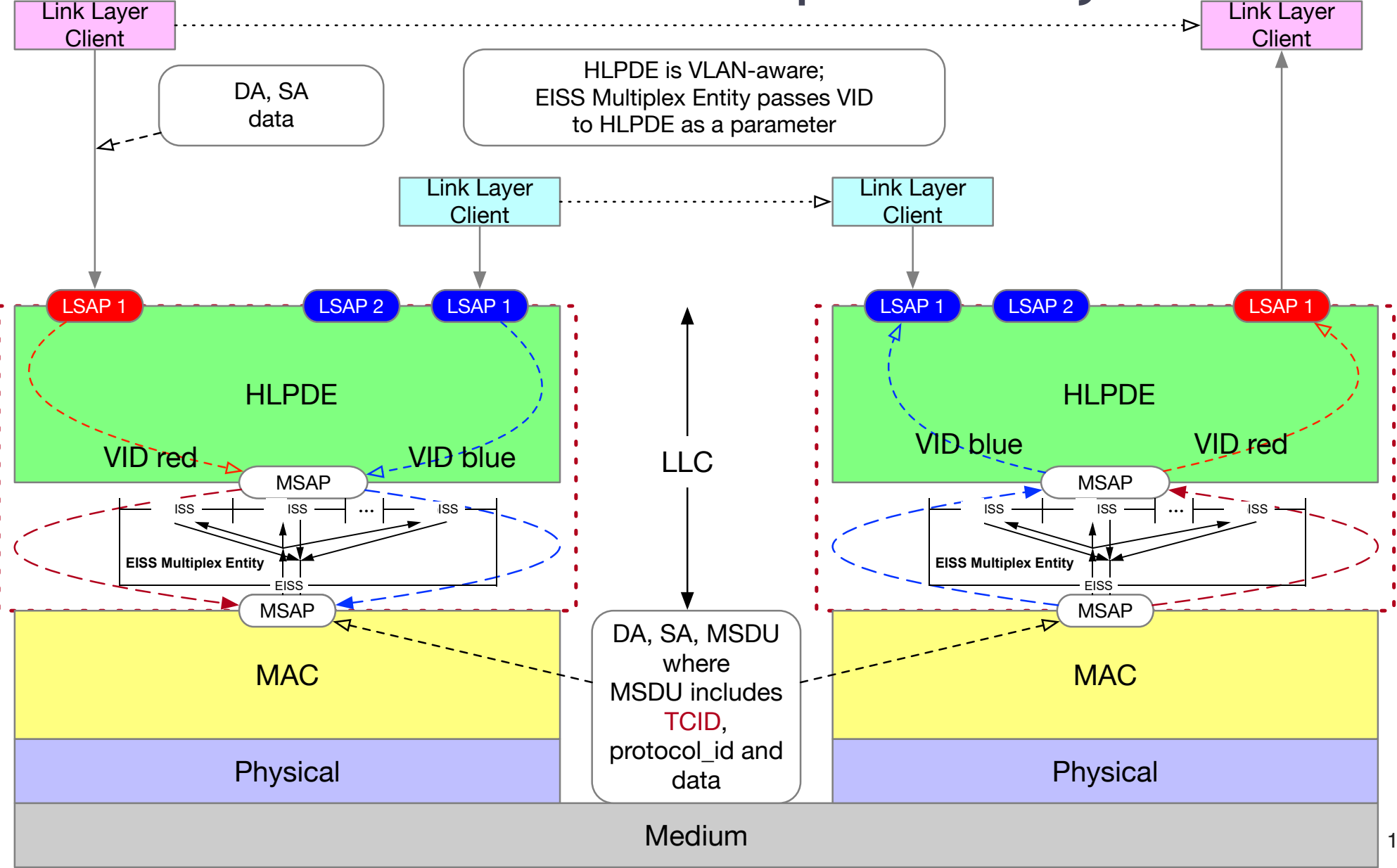

LLC C-tag Model: simple example

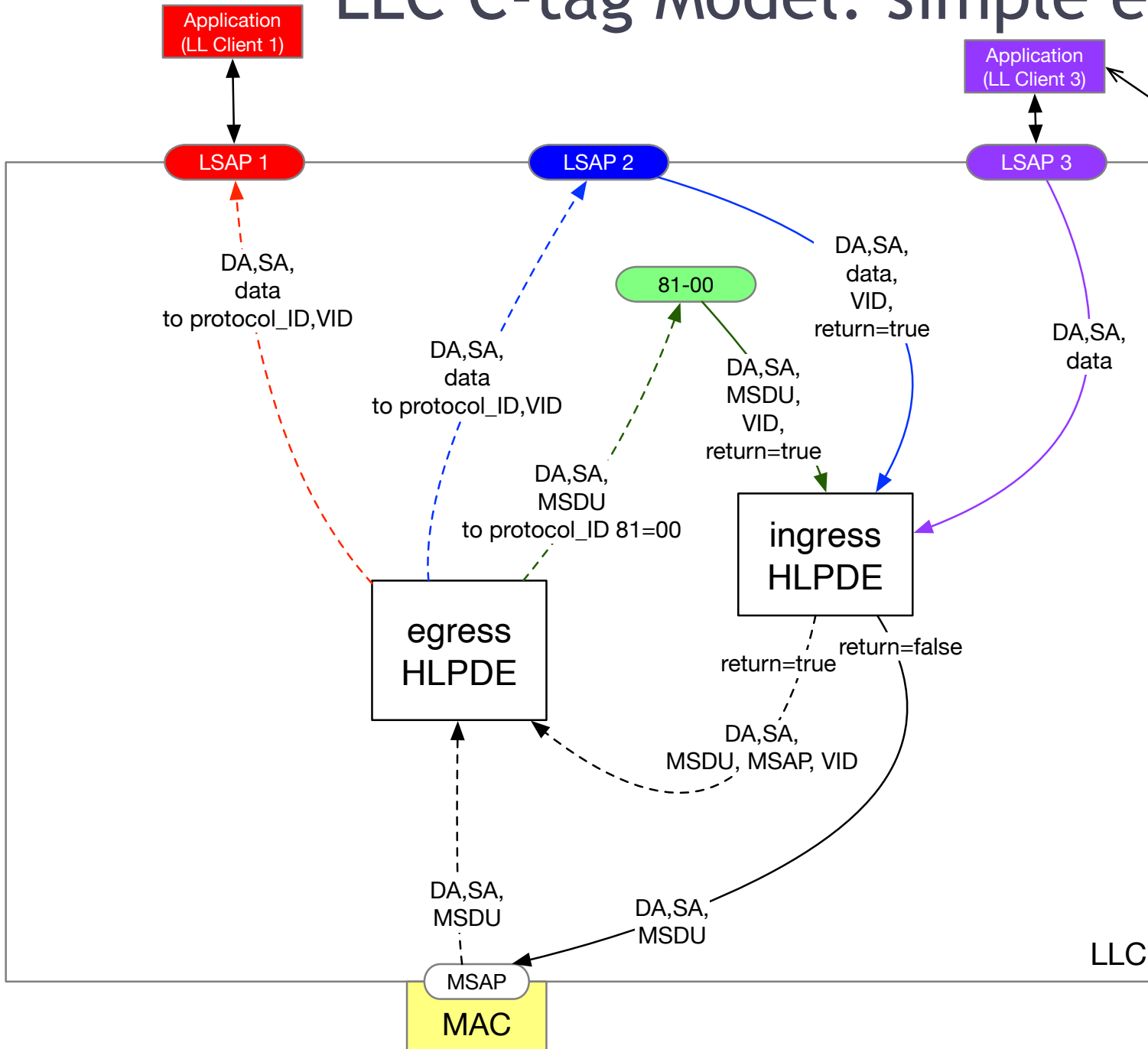

“a source of, and/or destination for, link layer data traffic carried on the network”

(text from the definition of “end station”)

What if: 81-00 is just another LSAP?

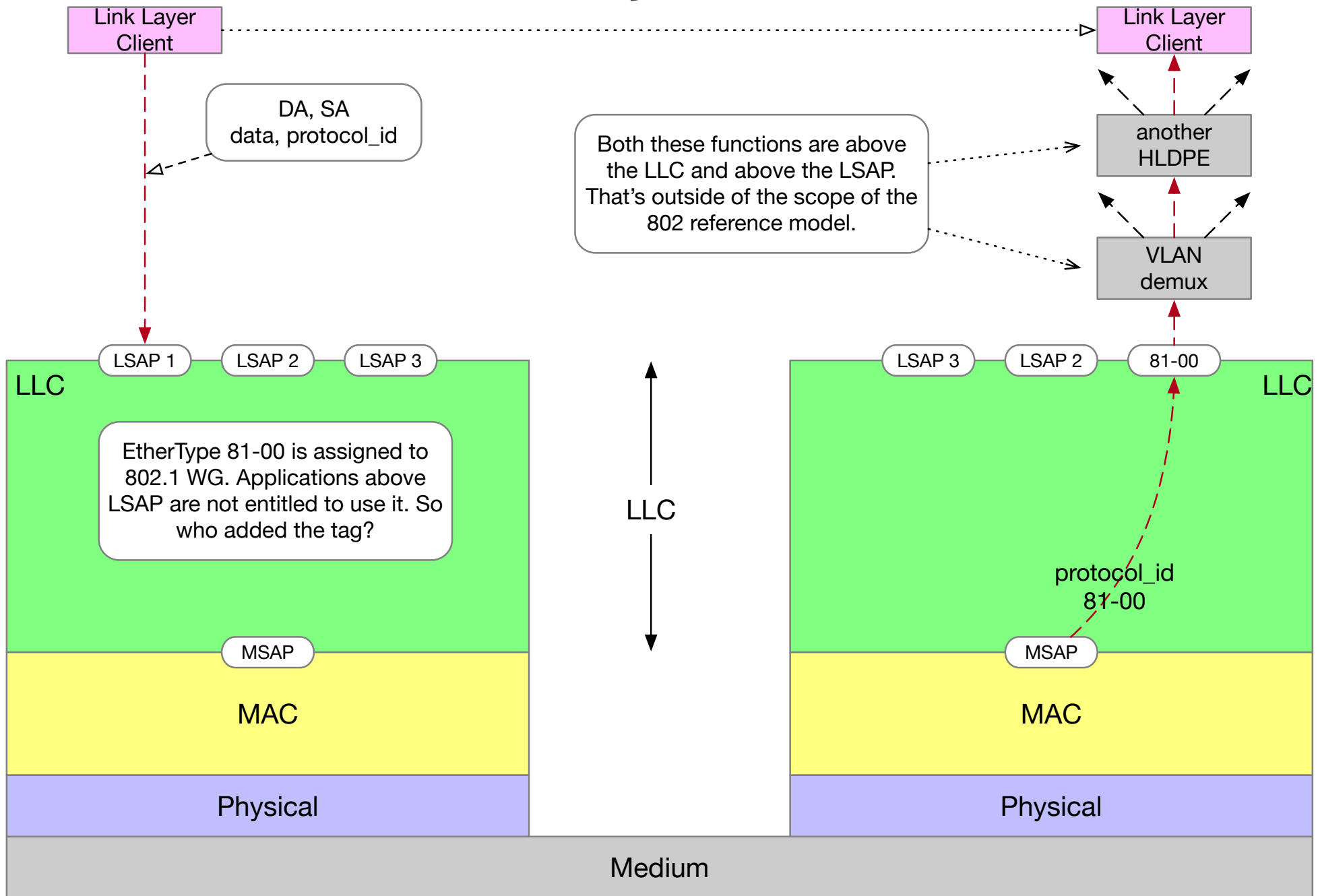

View: VLANs belong in the 802 Architecture

- Multiplexing at the Link Layer is a core functionality of the 802 architecture.
- VLAN-aware end stations are described in 802 standards.
- In the real world, VLAN-aware end stations exist and are attached to 802 networks.
- In VLAN-aware end stations, the C-tag is created and consumed in the LLC.
- In VLAN-aware end stations, both the VID and the protocol ID are required to distinguish LSAPs and therefore distinguish Link Layer clients.
- VLANs are a core, though poorly documented, aspect of the 802 architecture.