



# Making the Case for Open, Softwarized, Data-Driven 802 Networks

Francesco Restuccia  
Assistant Professor

Electrical and Computer Engineering  
Associate Faculty, WIOT and Roux Institute  
Northeastern University, United States

Email: [frestuc@northeastern.edu](mailto:frestuc@northeastern.edu)

Website: <https://restuccialab.org>

DCN: 1-21-0078-00-ICne

- My field is **wireless** comms and systems
  - I can mainly speak from that perspective
- Similar concepts can be applied to wired networks
- Any feedback is mostly appreciated

# The Quest for Wireless Performance

Autonomous driving



Smart factory



VR/AR Gaming



- New applications demand higher **BW**, lower **latency**
- **Edge** computing is becoming more and more necessary
- Establishing URLLC will be fundamental for **802 networks**

# Main Strategy So Far?

- Increase Bandwidth (2x)

160 MHz  
(802.11ax)

320 MHz  
(802.11be)

- Increase Spatial Streams (2x)

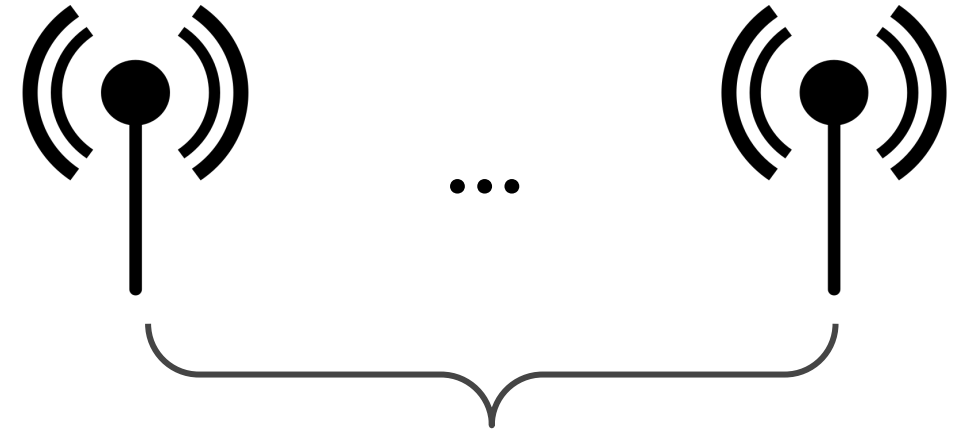

**16 Spatial Streams**  
**4 SS per STA**

Garcia-Rodriguez, Adrian, et al. "IEEE 802.11 be: Wi-Fi 7 Strikes Back." *IEEE Communications Magazine* 59.4 (2021): 102-108.

# Spectrum Bandwidth @ 6 GHz

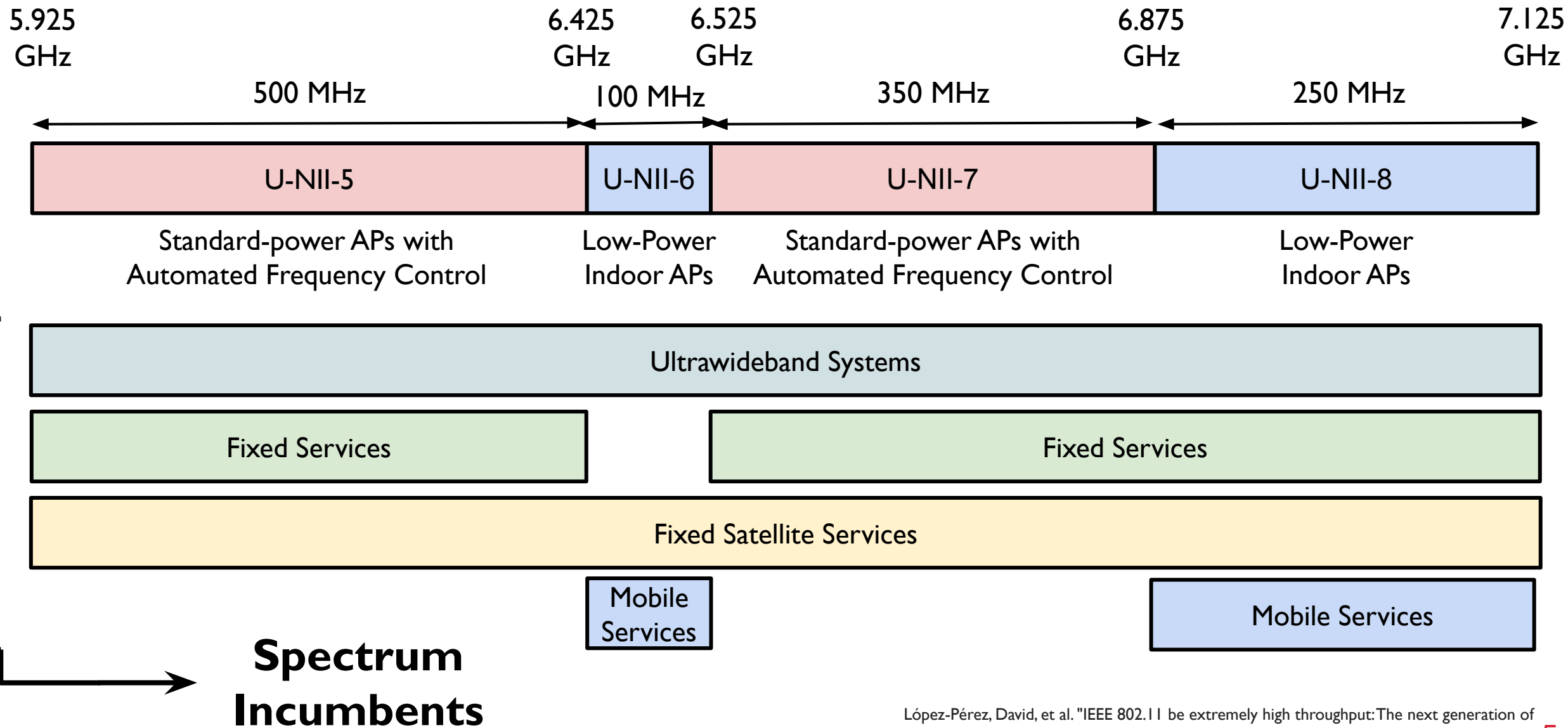

**Is this enough as a  
Long-term Strategy?**

# Complex and Crowded Spectrum

> 4x Human Population!

Number of global active Connections (installed base) in Bn

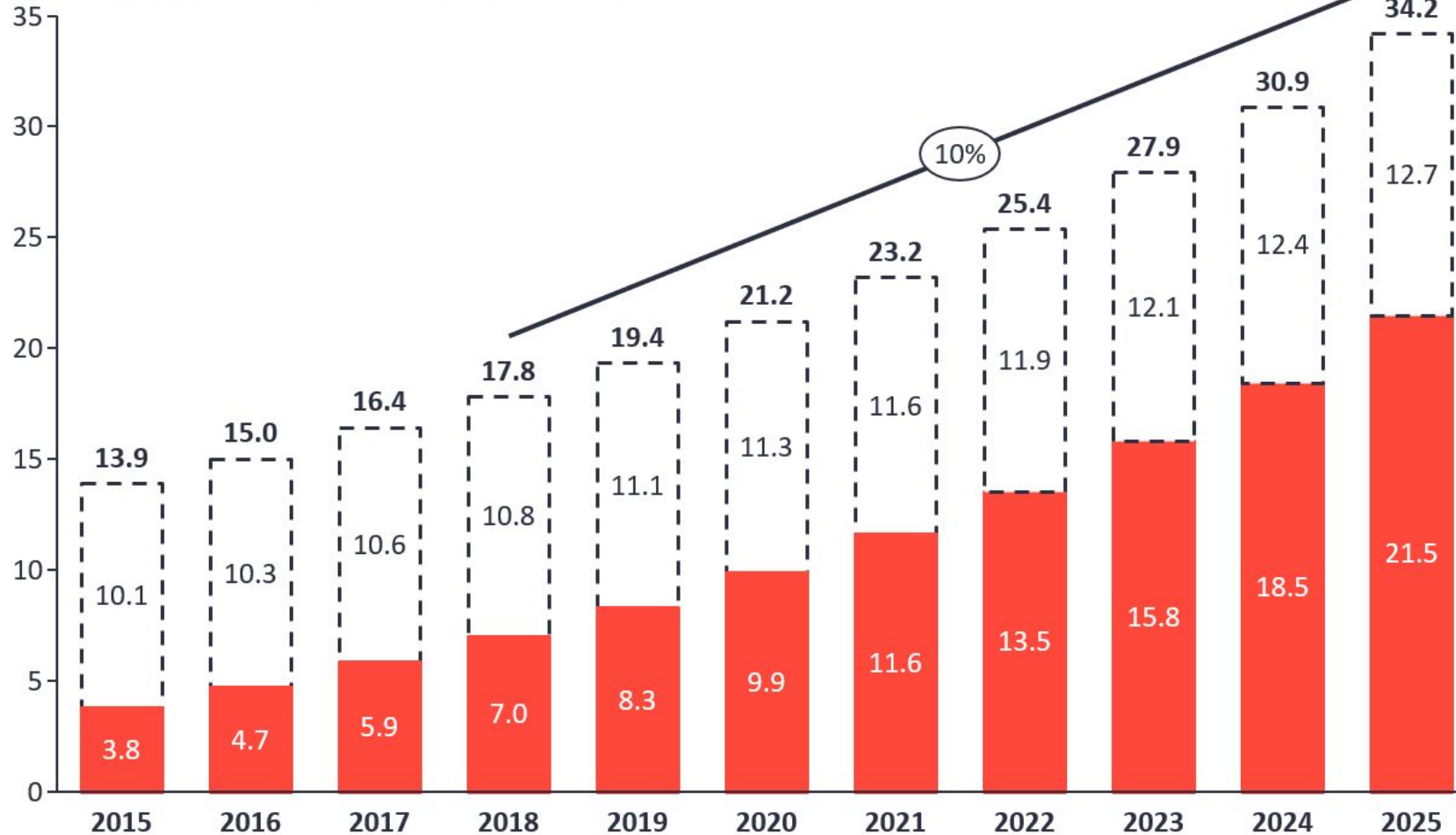

**Huge BW  
Implies  
Need for  
Spectrum  
Sharing**

Note: Non-IoT includes all mobile phones, tablets, PCs, laptops, and fixed line phones. IoT includes all consumer and B2B devices connected – see IoT break-down for further details  
Source: IoT Analytics Research 2018

## CSI Feedback Overhead

- 8x8 MU-MIMO network at 160 MHz
  - 486 subcarriers x 56 angles/subcarrier x 16 bits/angle ~ **53 kB**
- Every 5ms, airtime overhead is  $435,456 / 0.05 = \mathbf{1.088 \text{ Mbit/s}}$

## Increasing Inter-Stream and Inter-User Interference

- More users and more SS, more frequent CSI probes

**This results in increased HW cost  
LESS SALES!**



**Throwing more BW and SS is likely  
not to be enough as a long-term strategy**

**Real-time AI-driven techniques will  
become fundamental to deal with the  
increased spectrum complexity**

**What are other  
communities  
doing about this?**

# Open and Virtualized 5G network

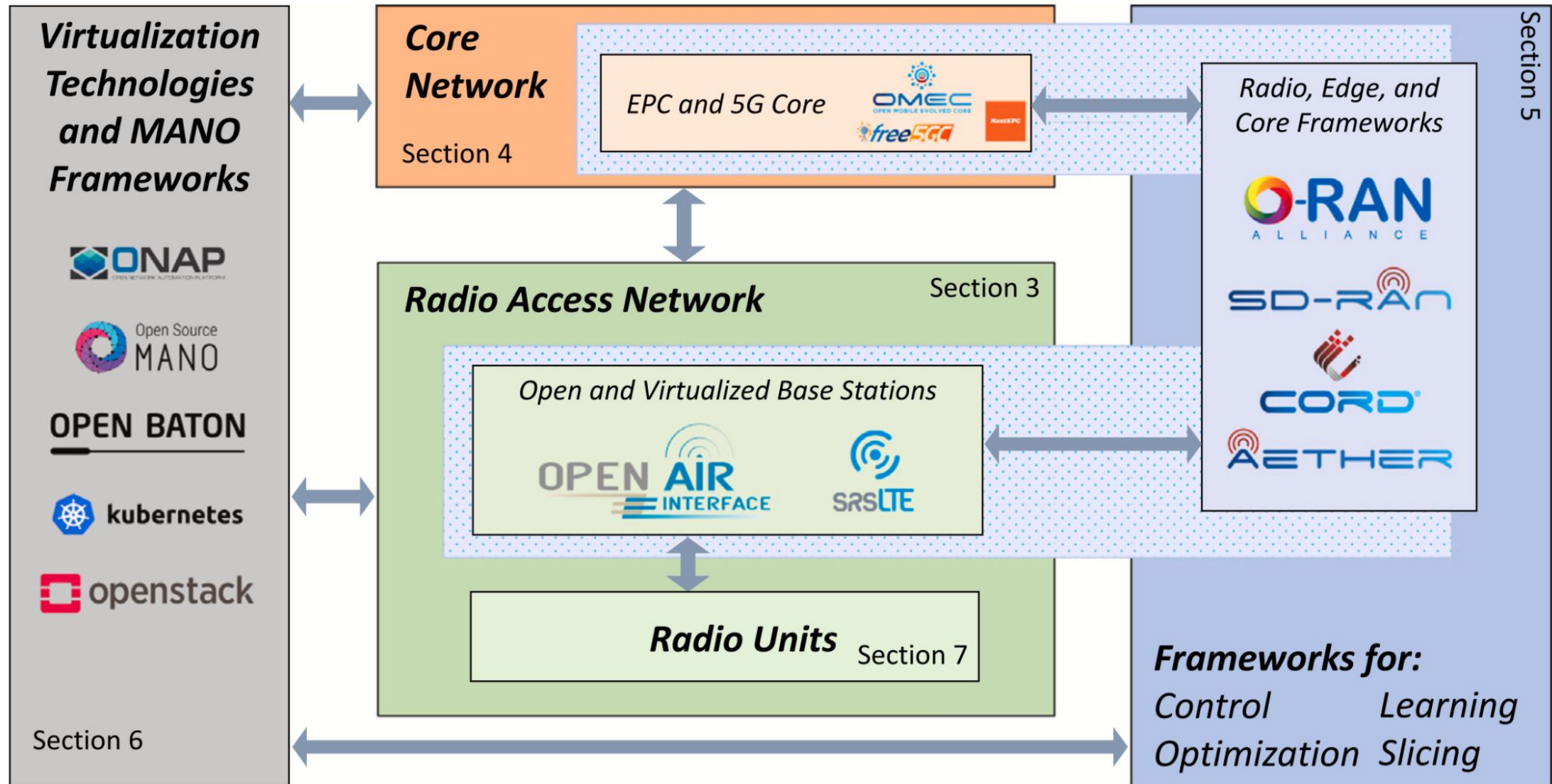

# The O-RAN Paradigm

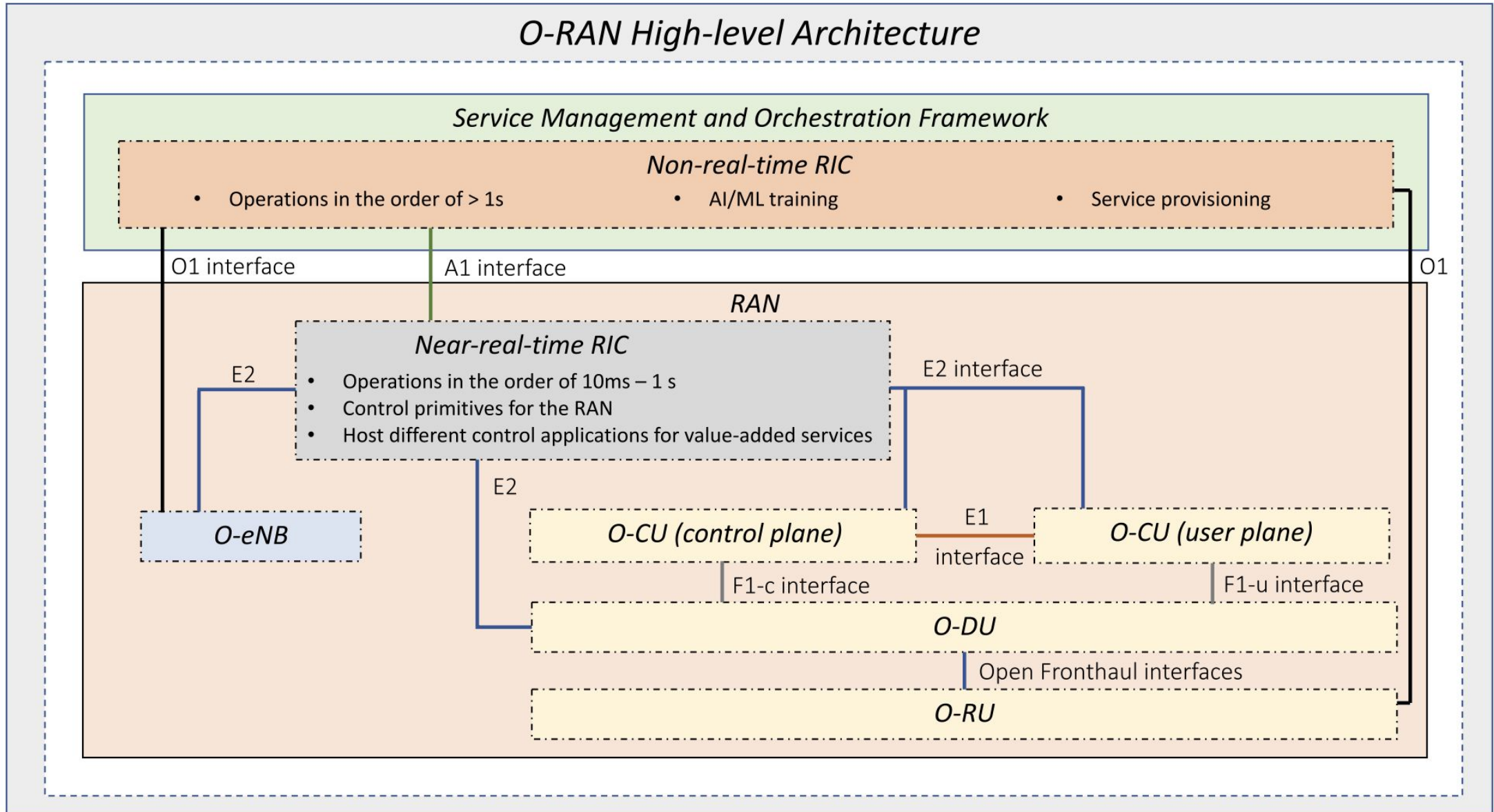

# Openness Enables Full-Stack AI-based Control

I need to stream **4K video** to **100 users** in **Times Square, NY** from **8pm to 9pm**

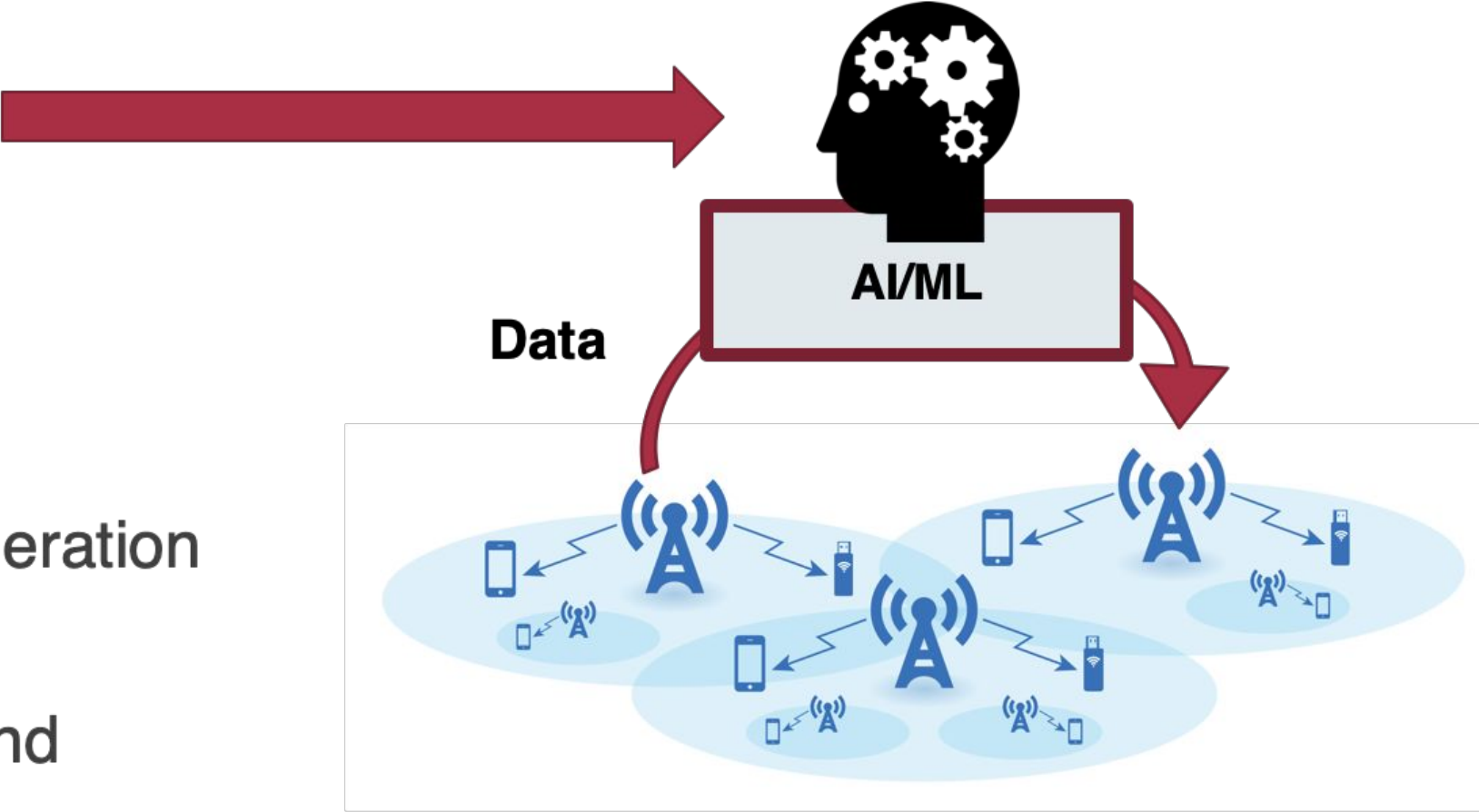

- **Automated** software generation
- **Intent recognition**
- **Adapt** to network state and traffic demand
- **Best performance**
- **Zero-touch reconfiguration**

# Advantages of Open, Virtualized Networks

---

1. Disaggregation of **hardware** and **software** possible
2. AI operations can be integrated **by design** into the network
3. Interoperability enables diversity and **reduces CAPEX (60%)**
4. **Future-proof** – no rip and replace infrastructure
5. Easier maintenance results in **reduced OPEX (65%)**
6. Faster deployments, higher throughput, coverage and capacity

**O-RAN market is estimated to attain a revenue of USD 419.51 Million in 2021 and USD 21,371.47 Million in 2028, CAGR of 83.1%**

<https://www.researchnester.com/reports/open-radio-access-network-market/2781>

Parallel Wireless, “OpenRAN – 7 vital benefits for MNOs,” <https://www.parallelwireless.com/blog/openran-7-vital-benefits-for-mnos/>

**Better service to the final customer**  
**Mobile subscriptions costs going down**  
**802 standards could become obsolete**

**How do we fill the  
current gap?**



# Dealing With Complexity: AI Techniques

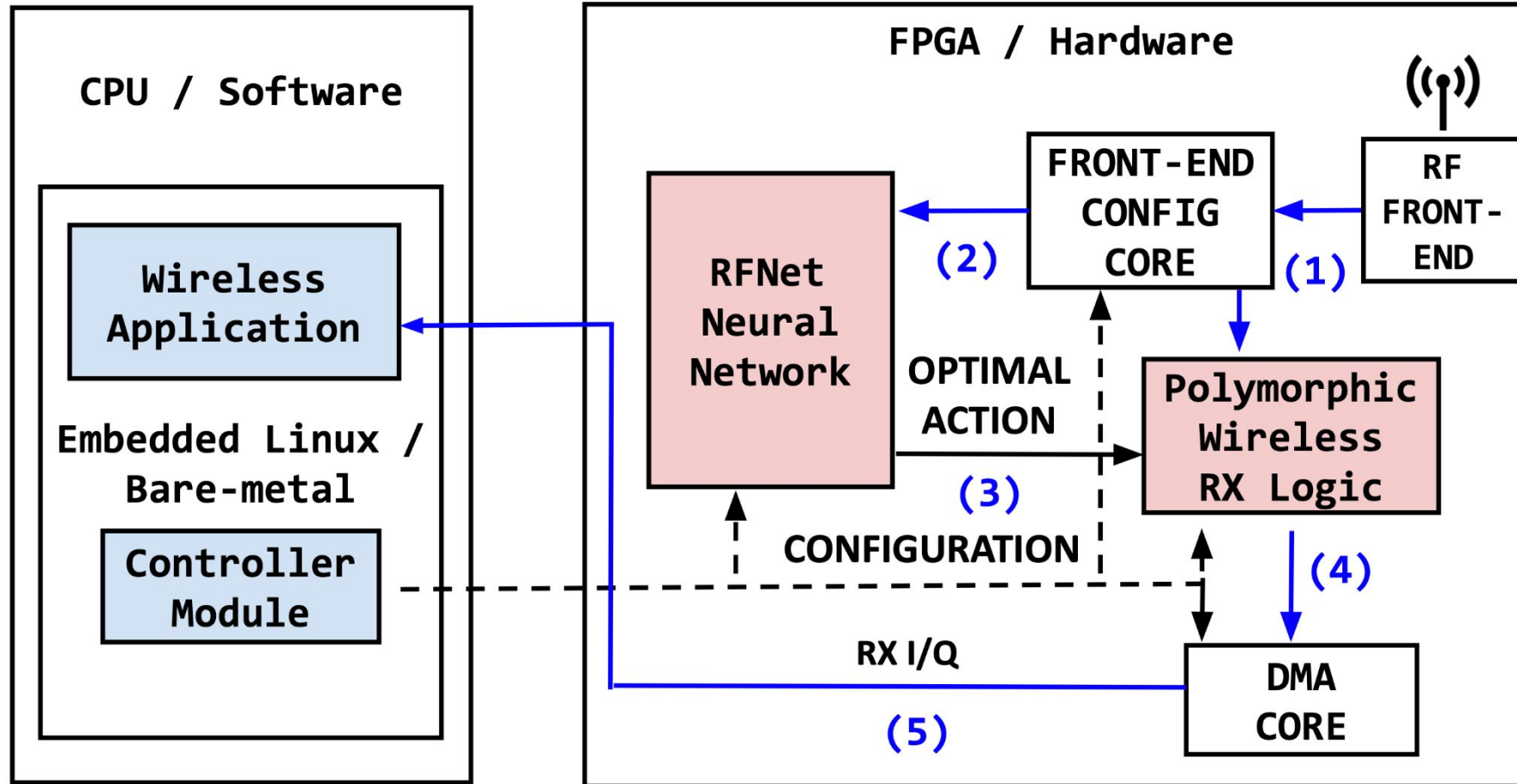

**17x less  
latency**

**15x less  
energy**

F. Restuccia and T. Melodia, "Big Data Goes Small: Real-Time Spectrum-Driven Embedded Wireless Networking Through Deep Learning in the RF Loop," **IEEE INFOCOM 2019**

# AI Techniques for Zero-Touch Network Control

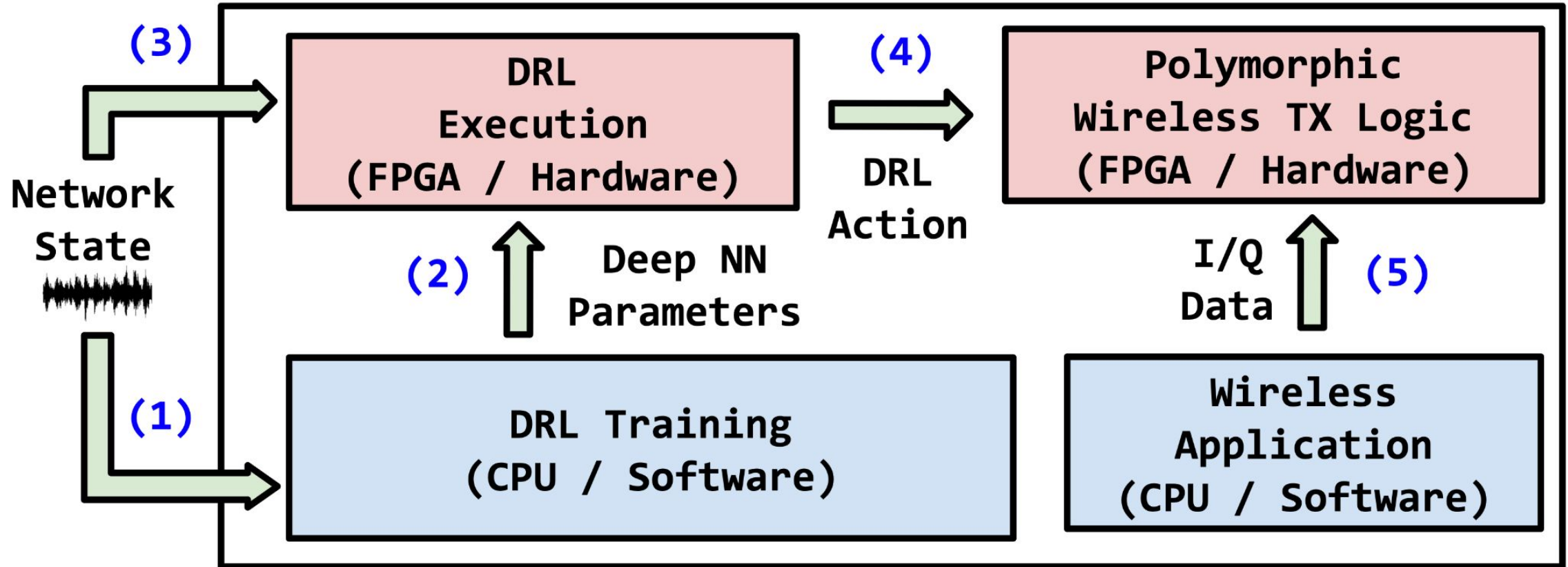

F. Restuccia and T. Melodia, "DeepWiERL: Bringing Deep Reinforcement Learning to the Internet of Self-Adaptive Things," **IEEE INFOCOM 2020**

# Spectrum Sharing b/w Wi-Fi and 5G

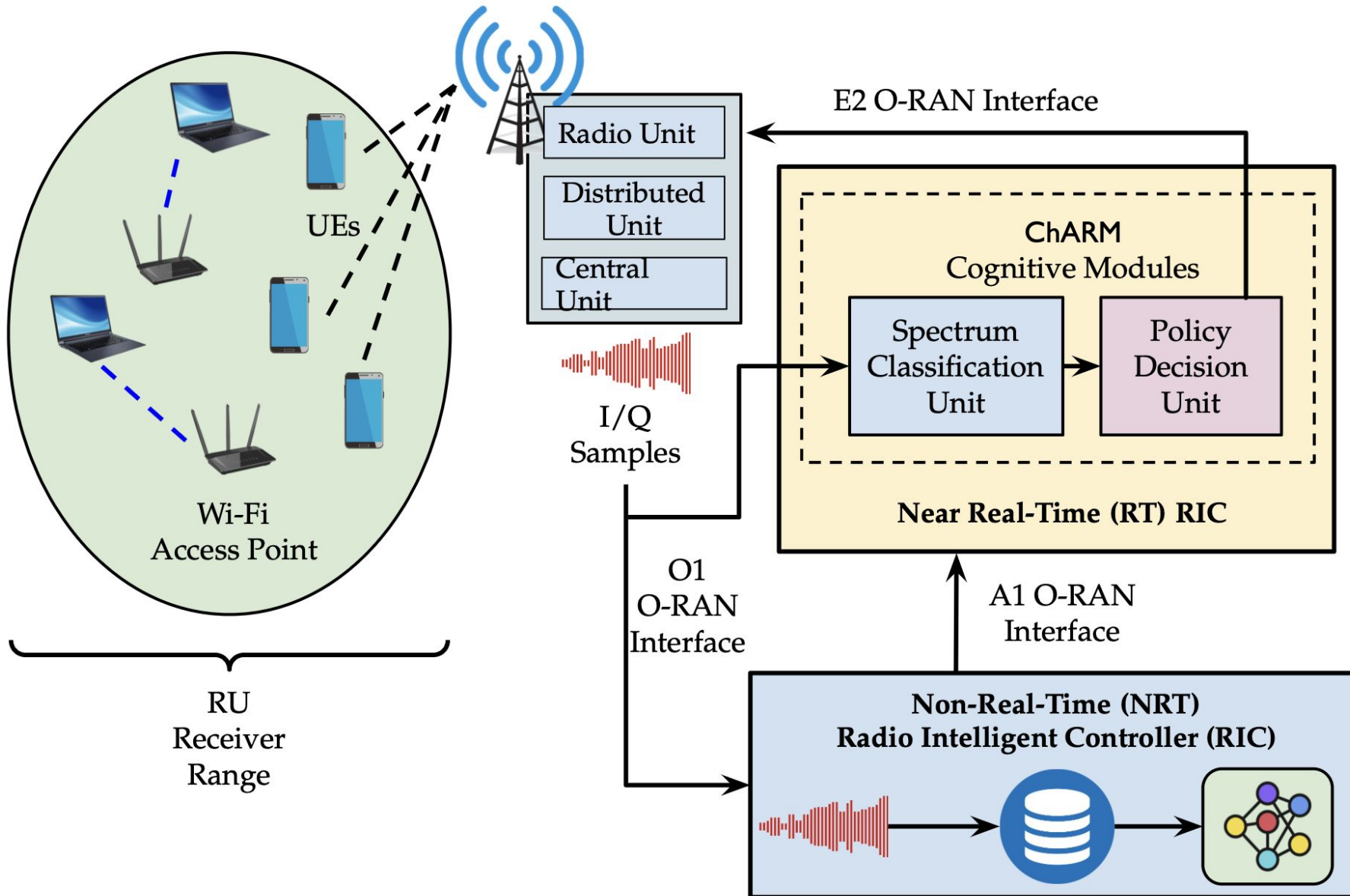

L. Baldesi, F. Restuccia and T. Melodia, "ChARM: NextG Spectrum Sharing Through Data-Driven Real-Time O-RAN Dynamic Control," **IEEE INFOCOM 2022**

**802 networks should adopt **open, softwarized** strategies similar to **O-RAN** to remain competitive**

**802 networks should learn to coexist with other technologies and **embed AI by design** into their architecture**

**Thanks!**  
**Questions?**