

**INDUSTRY CONNECTIONS  
REPORT**

**IEEE 802 Nendica Report:**

**Flexible Factory IoT—Use Cases and  
Communication Requirements for Wired  
and Wireless Bridged Networks**

# IEEE 802 Nendica Report: Flexible Factory IoT—Use Cases and Communication Requirements for Wired and Wireless Bridged Networks

---

## Editor

Name	Affiliation
Zein, Nader	NEC Europe Ltd. (NLE GmbH)

## Nendica Chair

Name	Affiliation
Marks, Roger	Huawei

## Contributors/Supporters

Name	Affiliation
Hasegawa, Akio	Advanced Telecommunications Research Institute International (ATR)
Kondo, Yoshihisa	Advanced Telecommunications Research Institute International (ATR)
Weber, Karl	Beckhoff
Hasegawa, Jun	Fujitsu Kansai-Chubu Net-Tech Limited
Naitou, Syouji	Fujitsu Kansai-Chubu Net-Tech Limited
Hamaminato, Makoto	Fujitsu Laboratories Ltd.
Nishikawa, Takurou	Fujitsu Limited
Sato, Shinichi	Fujitsu Limited
Wang, Hao	Fujitsu R&D Center Co., Ltd.
Su, Yi	Fujitsu R&D Center Co., Ltd.
Marks, Roger	Huawei
Kato, Toshio	Mobile Techno Corp.
Murata, Syuuichi	Mobile Techno Corp.
Yoshimura, Masahiro	Mobile Techno Corp.
Tomita, Hisanori	Murata Machinery, Ltd.
Itaya, Satoko	National Institute of Information and Communications Technology (NICT)
Kojima, Fumihide	National Institute of Information and Communications Technology (NICT)
Koto, Hajime	National Institute of Information and Communications Technology (NICT)
Mochinaga, Mika	National Institute of Information and Communications Technology (NICT)
Ohori, Fumiko	National Institute of Information and Communications Technology (NICT)

<b>Name</b>	<b>Affiliation</b>
Ohsawa, Tomoki	National Institute of Information and Communications Technology (NICT)
Hirabayashi, Chiaki	NEC Communication Systems, Ltd.
Ikenoue, Yuichi	NEC Communication Systems, Ltd.
Hayashi, Takeshi	NEC Corporation
Hidaka, Youichi	NEC Corporation
Inoue, Takamichi	NEC Corporation
Kato, Rintaro	NEC Corporation
Kobayashi, Tsukasa	NEC Corporation
Maruhashi, Kenichi	NEC Corporation
Nakajima, Taketoshi	NEC Corporation
Okayama, Yoshimitsu	NEC Corporation
Osuga, Toru	NEC Corporation
Zein, Nader	NEC Europe Ltd.(NLE GmbH)
Fujimoto, Takuya	OMRON Corporation
Ikumo, Masahiro	OMRON Corporation
Saito, Keisuke	OMRON Corporation
Yamada, Ryota	OMRON Corporation
Ohue, Hiroshi	Panasonic Corporation
Amagai, Akihiro	Sanritz Automation Co., Ltd.

## Trademarks and Disclaimers

*IEEE believes the information in this publication is accurate as of its publication date; such information is subject to change without notice. IEEE is not responsible for any inadvertent errors.*

**Copyright © 2020 IEEE. All rights reserved.**

IEEE owns the copyright to this Work in all forms of media. Copyright in the content retrieved, displayed or output from this Work is owned by IEEE and is protected by the copyright laws of the United States and by international treaties. IEEE reserves all rights not expressly granted.

IEEE is providing the Work to you at no charge. However, the Work is not to be considered within the “Public Domain,” as IEEE is, and at all times shall remain the sole copyright holder in the Work.

Except as allowed by the copyright laws of the United States of America or applicable international treaties, you may not further copy, prepare, and/or distribute copies of the Work, nor significant portions of the Work, in any form, without prior written permission from IEEE.

Requests for permission to reprint the Work, in whole or in part, or requests for a license to reproduce and/or distribute the Work, in any form, must be submitted via email to [stds-ipr@ieee.org](mailto:stds-ipr@ieee.org), or in writing to:

IEEE SA Licensing and Contracts  
445 Hoes Lane  
Piscataway, NJ 08854

Comments on this report are welcomed by Nendica: the IEEE 802 “Network Enhancements for the Next Decade” Industry Connections Activity: <<https://1.ieee802.org/802-nendica>>  
Comment submission instructions are available at: <<https://1.ieee802.org/802-nendica/nendica-ffiot>>  
Comments will be considered for a future revision of this document and may stimulate the development of a new revision.

---

*The Institute of Electrical and Electronics Engineers, Inc.  
3 Park Avenue, New York, NY 10016-5997, USA*

*Copyright © 2020 by The Institute of Electrical and Electronics Engineers, Inc.  
All rights reserved. Published April 2020. Printed in the United States of America.*

*IEEE and 802 are registered trademarks in the U.S. Patent & Trademark Office, owned by The Institute of Electrical and Electronics Engineers, Incorporated.*

PDF: ISBN 978-1-5044-6229-7 STDVA23928

*IEEE prohibits discrimination, harassment, and bullying. For more information, visit*  
<http://www.ieee.org/web/aboutus/whatis/policies/p9-26.html>.

*No part of this publication may be reproduced in any form, in an electronic retrieval system, or otherwise, without the prior written permission of the publisher.*

*To order IEEE Press Publications, call 1-800-678-IEEE.  
Find IEEE standards and standards-related product listings at: <http://standards.ieee.org>*

## **NOTICE AND DISCLAIMER OF LIABILITY CONCERNING THE USE OF IEEE SA INDUSTRY CONNECTIONS DOCUMENTS**

This IEEE Standards Association (“IEEE SA”) Industry Connections publication (“Work”) is not a consensus standard document. Specifically, this document is NOT AN IEEE STANDARD. Information contained in this Work has been created by, or obtained from, sources believed to be reliable, and reviewed by members of the IEEE SA Industry Connections activity that produced this Work. IEEE and the IEEE SA Industry Connections activity members expressly disclaim all warranties (express, implied, and statutory) related to this Work, including, but not limited to, the warranties of: merchantability; fitness for a particular purpose; non-infringement; quality, accuracy, effectiveness, currency, or completeness of the Work or content within the Work. In addition, IEEE and the IEEE SA Industry Connections activity members disclaim any and all conditions relating to: results; and workmanlike effort. This IEEE SA Industry Connections document is supplied “AS IS” and “WITH ALL FAULTS.”

Although the IEEE SA Industry Connections activity members who have created this Work believe that the information and guidance given in this Work serve as an enhancement to users, all persons must rely upon their own skill and judgment when making use of it. IN NO EVENT SHALL IEEE OR IEEE SA INDUSTRY CONNECTIONS ACTIVITY MEMBERS BE LIABLE FOR ANY ERRORS OR OMISSIONS OR DIRECT, INDIRECT, INCIDENTAL, SPECIAL, EXEMPLARY, OR CONSEQUENTIAL DAMAGES (INCLUDING, BUT NOT LIMITED TO: PROCUREMENT OF SUBSTITUTE GOODS OR SERVICES; LOSS OF USE, DATA, OR PROFITS; OR BUSINESS INTERRUPTION) HOWEVER CAUSED AND ON ANY THEORY OF LIABILITY, WHETHER IN CONTRACT, STRICT LIABILITY, OR TORT (INCLUDING NEGLIGENCE OR OTHERWISE) ARISING IN ANY WAY OUT OF THE USE OF THIS WORK, EVEN IF ADVISED OF THE POSSIBILITY OF SUCH DAMAGE AND REGARDLESS OF WHETHER SUCH DAMAGE WAS FORESEEABLE.

Further, information contained in this Work may be protected by intellectual property rights held by third parties or organizations, and the use of this information may require the user to negotiate with any such rights holders in order to legally acquire the rights to do so, and such rights holders may refuse to grant such rights. Attention is also called to the possibility that implementation of any or all of this Work may require use of subject matter covered by patent rights. By publication of this Work, no position is taken by the IEEE with respect to the existence or validity of any patent rights in connection therewith. The IEEE is not responsible for identifying patent rights for which a license may be required, or for conducting inquiries into the legal validity or scope of patents claims. Users are expressly advised that determination of the validity of any patent rights, and the risk of infringement of such rights, is entirely their own responsibility. No commitment to grant licenses under patent rights on a reasonable or non-discriminatory basis has been sought or received from any rights holder. The policies and procedures under which this document was created can be viewed at <http://standards.ieee.org/about/sasb/iccom/>.

This Work is published with the understanding that IEEE and the IEEE SA Industry Connections activity members are supplying information through this Work, not attempting to render engineering or other professional services. If such services are required, the assistance of an appropriate professional should be sought. IEEE is not responsible for the statements and opinions advanced in this Work.

# TABLE OF CONTENTS

1. INTRODUCTION .....	1
Scope .....	2
Purpose.....	2
2. FACTORY OVERVIEW AND COMMUNICATION NETWORK ENVIRONMENT .....	3
Factory communication network environment .....	3
Coordination System for Factory Automation .....	5
Radio Environment within Factories .....	6
Severe Environment for Wireless Communications.....	6
Uncoordinated and Independent Systems.....	8
3. WIRELESS APPLICATIONS AND COMMUNICATION REQUIREMENTS ...	9
Scope of wireless applications in factory .....	9
Wireless applications.....	9
Communication requirements .....	10
Details of wireless application and communication requirements....	12
4. FACTORY USAGE SCENARIOS.....	18
Usage scenarios example: Metal processing site .....	18
Usage scenarios example: Mechanical assembly site .....	19
Usage scenarios example: Elevated and high temperature work site .....	21
Usage scenarios example: Logistics warehouse site .....	22
5. TECHNOLOGICAL ENHANCEMENT OF NETWORKING FOR FLEXIBLE FACTORY IOT .....	24
Coexisting of wide variety of factory applications with different requirements .....	24
Overview of the standard landscape for Flexible Factory IoT.....	25
Gaps analysis of existing standards and technologies for Flexible Factory network .....	26
End-to-end stream reservation in a wired/wireless integrated network .....	26
Wireless link redundancy for reliability and jitter improvement .....	27
Adaptation to rapid changes in wireless environments.....	29

Coordination among wireless systems in unlicensed bands.....	32
Future directions towards enhancements for Flexible Factory network .....	33
End-to-end network control and coordination .....	33
6. CONCLUSIONS .....	37
7. CITATIONS.....	38

# 1

## INTRODUCTION

Until recently, factories have utilized mainly wired communication. A survey (Nalin,<sup>1</sup> [1]) indicates that the market share of wired networks in factory automation is 94%. However, shorter product development cycles have demanded greater flexibility in the layout of machines and sequence of processes. As a result, there are increasing expectations for the use of wireless connectivity among machines in the manufacturing and factory processes.

When considering the network evolution within factories, consideration should take into account legacy manufacturing machines that have been in service for many decades. Within factory installations, sensors are attached to machines for the purpose of monitoring, operations, and preventive maintenance. According to a survey by Japan's Ministry of Economy, Trade and Industry, the lifetime of production machines is long, and about 10.9% of them have been used for more than 30 years, as shown in Figure 1. In many cases, sensors continue to be used long after they have been introduced, resulting in the coexistence of sensors and their communication interfaces in different generations as well within machines.

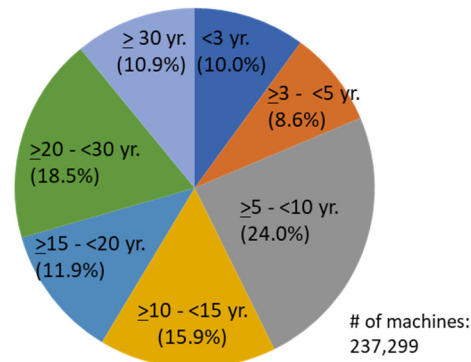

Figure 1—Share of production machines by age [2]<sup>2</sup>

Some industrial automation systems, which are built with resilience, have been in continuous operation for more than 30 years without being out of service. To adopt more wireless communications successfully in these systems, careful consideration is needed for wired and wireless bridged network.

This report considers the need for network requirements in an evolving factory environment referred to as “Flexible Factory.” Flexible Factory represents an evolved site for flexible on-demand manufacturing of variable product types with variable production volumes. Flexibility in the factory

<sup>1</sup>Information on references can be found at the end of the document in the Citations section.

<sup>2</sup>Data came from a survey of 1033 Japanese factories administrated by Ministry of Economy, Trade and Industry of Japan in 2013. Total number of machines was 237,299, including grinders (12.5%), industrial robots (9.3%), automated assembly machines (8.8%), welding/fusing machines (8.7%), lathe machines (7.9%), press machines (6.7%), machining centers (5.5%), and others.



environment emphasizes mobility and configurability of manufacturing facilities. In support of the flexibility, human operators are engaged with the production process in order to oversee the on-demand production. This new flexibility requires the factory network to evolve to include wireless connectivity in support of increased mobility of humans and automated vehicles, and the reallocation of facilities.

The “Flexible Factory” concept is one aspect of Smart Manufacturing [3] indicating the enhancement of mobility and configurability of manufacturing facilities. It is supported by successful integration of wireless connectivity into the wired network in factories.

The report addresses integrated wired and wireless Internet of Things (IoT) communications in the Flexible Factory environment, considering expected evolution to dense radio device utilization. The report includes use cases and requirements within the factory wireless environment, with a focus on bridged Layer 2 networks. It presents problems and challenges observed within the factory and reports on feasible solutions for overcoming these issues. Topics that may benefit from standardization are addressed in the Section 5 “Technological Enhancement of Networking for Flexible Factory IOT.”

## Scope

The scope of this report includes use cases and communication requirements for Flexible Factory networks. Dense use of wireless devices with differentiated quality of service (QoS) requirements and operation in a Flexible Factory environment are taken into consideration. Gap analysis from existing IEEE 802 standards and necessary technology enhancement are also covered in the context of time-sensitive networks for the future.

## Purpose

The purpose of this report is to document issues and challenges in managing reliable and time-sensitive connectivity in Flexible Factory, in which various equipment, sensors, and actuators are attached to the wired network via wireless connections. The report includes technical analyses of the identified features and functions in wired and wireless IEEE 802 technologies for managing requirements in end-to-end (E2E) network connectivity. The results of the analysis lead to recommendations for enhancements of IEEE 802 standards supporting the integration of wired and wireless factory networks.

# 2 FACTORY OVERVIEW AND COMMUNICATION NETWORK ENVIRONMENT

## Factory communication network environment

Trends to connect devices such as sensors and cameras to factory networks are accelerated by a strong demand for improving productivity under the constraints of pressure for cost reduction. Connection of information on production processes and supply chain management within a factory and across factories has become increasingly important. It is also important to consider future needs of new technologies and network deployments, in spite of the typical long lifetime of any deployed technology in the factory floor. Communication networks in factories will undoubtedly change in the next decade by incorporating more and more wireless connectivities, enabling flexibility in the factories.

Figure 2 shows an example of a network for a vehicle assembly line in a factory today. Industrial control systems are ranging in scale from a few modular panel-mounted controllers to thousands of field connections. They provide remote access to data attributed to various devices such as sensors, actuators, motors, etc. The larger systems are usually implemented by Distributed Control Systems (DCS) or Supervisory Control and Data Acquisition (SCADA) systems, which manage Programmable Logic Controllers (PLCs) in the field. The entities labeled in Figure 2 as ‘App x’ indicate system applications, e.g., preventive maintenance, management of materials and products, and machine movement monitoring.

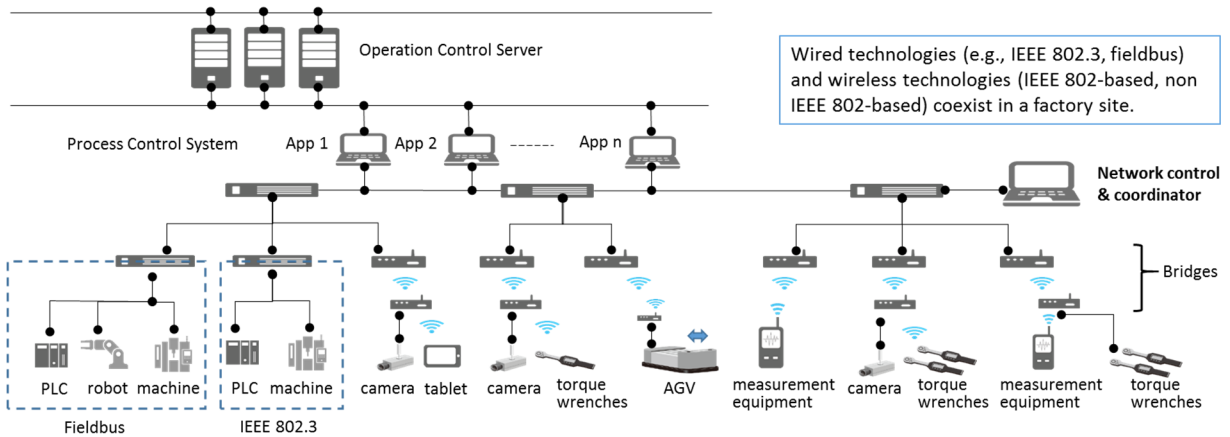

**Figure 2—Example of network topology for a vehicle assembly line**

The factory network infrastructure primarily provides the communication between and within these components and systems. One of the distinctive features of factory networks is that the physical devices connecting to the network are used to control and monitor real-world actions and conditions. This results in a strong emphasis on differentiated QoS.

Due to performance and market advantages, Ethernet has emerged as the dominant standard for the physical and medium-access control layers of factory networks. In the long term, Ethernet-based industrial communication systems, such as in IEC 61784-1 [4] and IEC 61784-2 [5], are replacing traditional fieldbus (IEC 61158 [6]) in order to support multiple higher layer protocols that support the interconnection of devices with various bandwidth requirements including PLCs, HMI (Human Machine Interface), and devices requiring high-speed communications. In industrial communication markets, the use of Ethernet has become increasingly favorable due to the introduction of the determinism based on the IEEE 802 Time-Sensitive Networking (TSN) standards. This set of standards for bridges and bridged networks, developed and supported by the IEEE 802.1 TSN Task Group, supports deterministic services such as guaranteed packet transport with bounded latency, low packet delay variation, and low packet loss. For further information about the TSN Task Group and a list of approved standards and projects in development, see the TSN Task Group webpage [7].

Future industrial factory networks are expected to use more wireless to reduce the installation cost as well as to enhance flexibility. By utilizing wireless communications, it is possible to collect useful information from IoT sensors to flexibly allocate equipment, such as cameras, and to analyze the status of humans and machines. Wireless is an essential element that enables flexible layout of machines and order of manufacturing processes to adapt to variable-type, variable-volume production, and mass customization (Flexible Factory Partner Alliance webpage [8]).

Transmitting and receiving data over a wireless link is not always as reliable as a wired link, for example when radio is operating over shared spectrum in a crowded environment, or in spectrum with non-communicating radio emitting devices.

In this case, more effort will be required for wireless communication because of its limited and shared radio resources and the sensitive nature of the environment in which it operates. Details of methods for increasing radio links reliability is discussed in [9] and [10]. To aid the successful integration of wired and wireless systems, network control and coordination is essential. This needs to be capable of provisioning (and re-provisioning as network resources fluctuate) to meet bandwidth and QoS requirements (see Figure 2) and can be based on IEEE 802.1 TSN [7] (in particular the draft project IEEE P802.1Qdj) and IEC [11] standards. Further consideration on E2E network control and coordination is given in the report in section “Future directions towards enhancements for Flexible Factory network.”

Within the factory network, there is a variety of traffic types generated from different factory applications. These are characterized as either periodic with constant bit rate or sporadic with various packet sizes. There are a number of functions and mechanisms in the aforementioned IEEE 802 TSN standards that can be used for managing and prioritizing traffic transmission across the factory network according to their QoS requirements. Note that mechanisms designed for fixed bandwidth allocation do not work well for sporadic traffic.

Some factories have employed wireline networks using the Fieldbus protocol. Wireless communications have not been used extensively in factories, mainly because of their reliability, security, deployment, control, and other requirements. Technology developments as well as standardization are keys to success for wireless utilization. If these efforts are proven successful, wireless use for IoT connectivity in factories can increase the connectivity of mobile or moving devices and units that cannot be connected to a wired network because of technology and topology

constraints. Wireless communication helps to locate people and things moving around. It can also help to protect people on the factory floor and help them identify critical situations more quickly while in motion.

When the factory network is extended over radio, the dynamic variation in bandwidth over the radio segment due to non-deterministic noise/interference, distortion, and fading will require provisioning of that segment so that anticipated reductions in the total available bandwidth still allow bandwidth commitments to be met. Increased emphasis has to be placed on safe equipment operation in cases of bandwidth outage, and the reaction of higher layer protocols (e.g., TCP) and signalling to bandwidth degradation beyond that usually available needs to be understood. As such, analysis phase should be conducted according to IEC 62657-2 [10] to determine if the application requirements can or cannot be met by using wireless communication

Security consideration is important for factory networks to protect confidentiality, integrity, and availability of data. Security guarantees of data integrity and data origin authenticity (received packets have been received as sent, and were sent by the authenticated system identified by the source MAC address) require the delivery of the original frame as sent, even if additional unsecured control information is added to, or removed from, the frame during transition. To satisfy the requirement, security standards are provided, which include IEEE Std 802.1X for Port-Based Network Access Control, IEEE Std 802.1AE for Media Access Control (MAC) Security, IEEE Std 802.11i for wireless security, IEC 62443 [12] for industrial network and system security, and many others. Security guidelines may also enhance security level for operation and maintenance of the networks. Some of them cover networks for IoT Safety/Security Development [13] and Flexible Factory [14].

Successful factory automation with a high degree of flexibility, dynamic management, and control of end-to-end streams across mixed wired and wireless links may be facilitated by E2E coordination as illustrated in Figure 2. Other topologies are also considered in IEC 62657-2 [10] and IEC 62657-4 [11] that support both centralized and decentralized.

The impact of applying QoS control and time synchronization functions and protocols to heterogeneous factory networks with mixed wired and wireless links is further analyzed in the following sections. First, however, details of the environment and causes of radio impairments to the factory environment are presented.

## Coordination System for Factory Automation

In current factories, various facilities and equipment with different standards, of different generations, and by different vendors, coexist in the same site. This heterogeneous factory environment is known as Brownfield (Hantel, et al.[15]). Such networks must consider various wireless interfaces, which include Wi-Fi, Bluetooth, Zigbee, WirelessHART, ISA100.11a, IO-Link Wireless, LPWA, and so on. IEC has produced coexistence guidelines for manually configuring wireless systems and networks for co-existence (IEC 62657-1:2017 [9], IEC 62657-2 [10]). In order to overcome the variable environment for wireless communications (see “Radio Environment within Factories” that follows), coordination as described in “Coordination among wireless systems in unlicensed bands” may prove superior to static configuration of network elements for co-existence. The same concept is drafted in the IEC 62657-4 [11] and the associated architecture is drafted in the IEC 62657-3 [16].

## Radio Environment within Factories

Some factory applications require reliable, low-latency, and low-jitter data transmission compared with applications in other environments, like offices and homes. Furthermore, measurement results show that some factories are facing difficulties due to the severe environment for wireless communications and/or existence of uncoordinated and independent systems in the same space.

### (a) Severe Environment for Wireless Communications

Two main sources of impairment to radio signals within the factory environment cause unpredictable variations to channel capacity, namely:

1. Fluctuation of signal strength
2. Electromagnetic interference

Following are examples of such impairments observed within the factory environment.

#### Example of Fluctuation of Signal Strength

Figure 3 illustrates an environment in which the measurements of Figure 4 were collected. The line of sight between the transmitter and the receiver was not blocked by any obstacle during measurement.

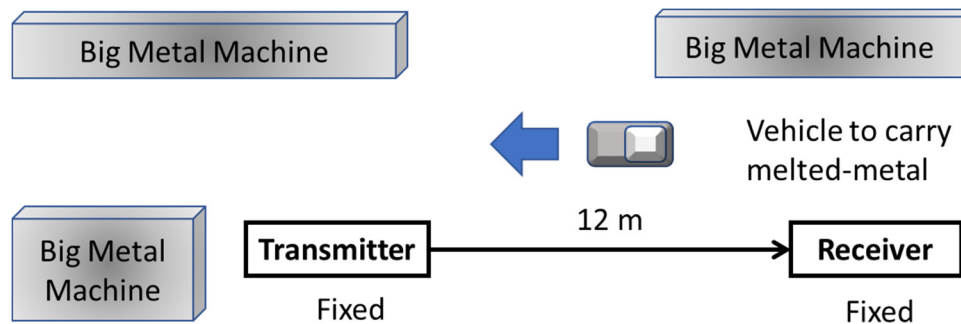

**Figure 3—Layout in factory for which measurement of RSSI is recorded**

The observed Received Signal Strength Indicator (RSSI) measurement for this layout is shown in Figure 4. A packet with 54 bytes was sent at each sequential number (Seq no.) with 10 ms separation at a data rate of 6 Mbit/s.

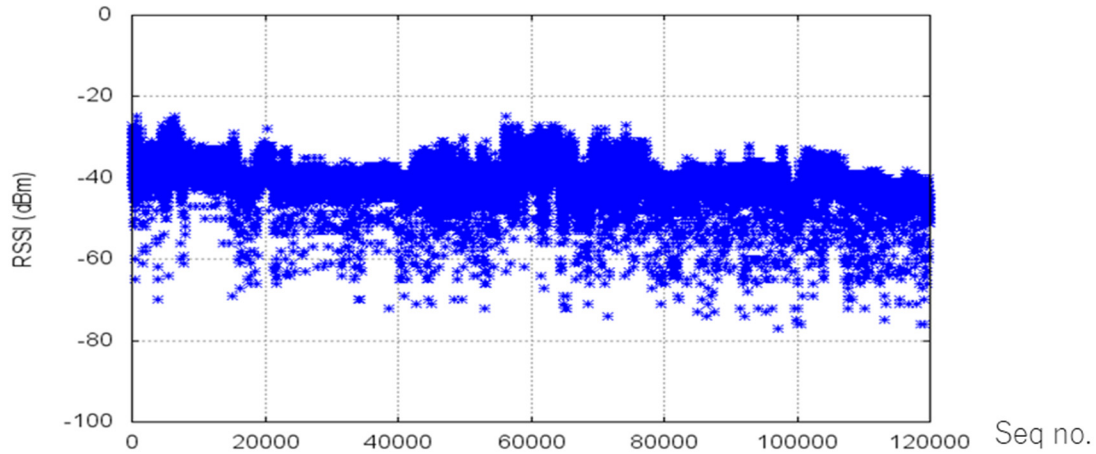
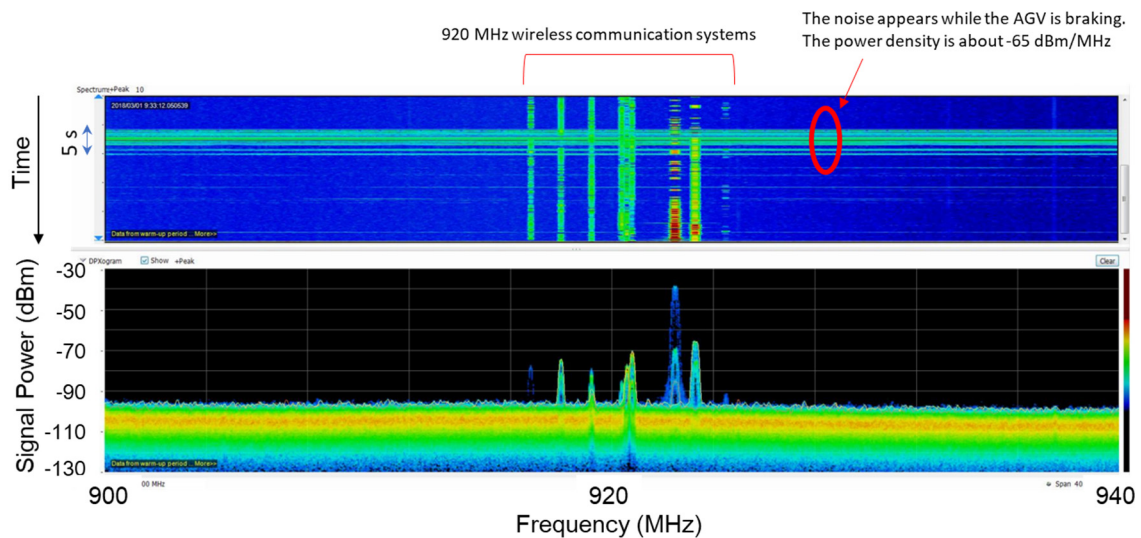

**Figure 4—RSSI fluctuation in factory**

This fluctuation in RSSI shown in Figure 4 may be due to motions of materials, parts, products, and carriers in closed space, with multi-path reflections. Similar issues are reported in the NIST report entitled “Guide to Industrial Wireless Systems Deployments” [17].

**Example of Noises:**

Measurements within one factory environment indicate considerable noise signal within the 920 MHz band. This is shown in Figure 5. The source of the noise signal has been confirmed as Automated Guided Vehicles (AGVs), as the noise appears while the AGV is braking.



**Figure 5—Measured noise spectral density**

The observed noise power was  $-65$  dBm/MHz, above the receiver sensitivity for the 920 MHz wireless systems.

### (b) Uncoordinated and Independent Systems

The modernized factory environment leads to the addition and reconfiguration of machines and equipment, much of which is outfitted with wireless network interfaces. This new environment brings about the requirement for coexistence of heterogeneous and legacy devices and systems.

When considering the coexistence of uncoordinated wireless systems, we observe the problem of interference between legacy wireless communications, used by some machinery in the factory, with the newly introduced wireless systems. In certain factories, many troubles appear after introducing the new wireless systems. The cause of this trouble is mutual interference between the newly introduced wireless system and legacy systems using legacy communication protocols, such as those based on IEEE Std 802.11 and other systems whose frequency channels overlap in the 2.4 GHz band. An example of a technique to avoid this problem is to assign two separate channels for the two systems in different bands.

Figure 6 shows wireless signals operating in the 2.4 GHz band in an existing factory site where two systems coexist. The legacy system occupies one narrow channel, but only three Wi-Fi channels are available. Because there is no common scheme for collision avoidance among different communication protocols, an independent channel should be assigned for each system to help ensure stable factory operation. This limits the number of wireless systems, with different communication protocols, that can operate in the same frequency band in a factory area.

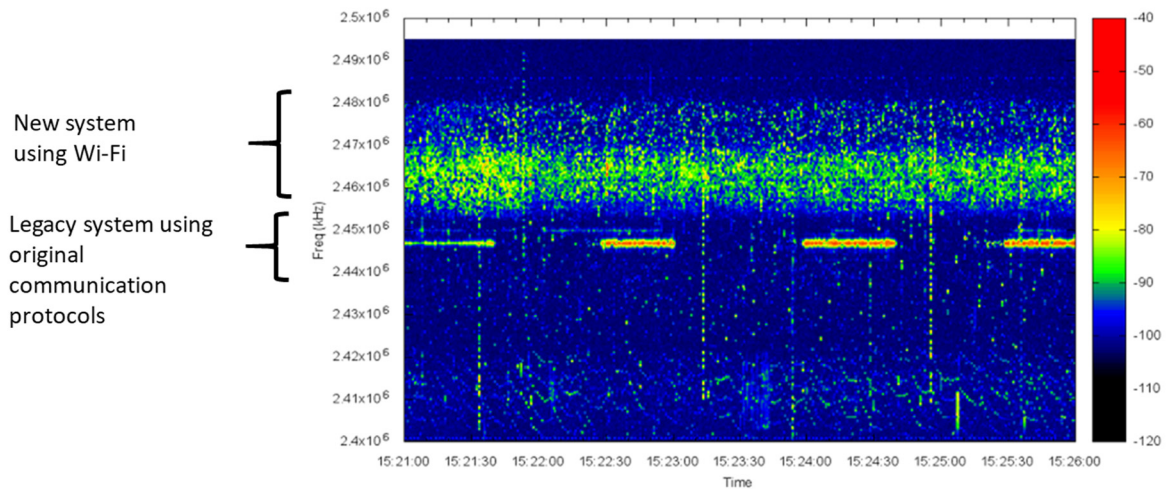

**Figure 6—Wireless signals with coexistence of different wireless technologies—The vertical and horizontal-axes show frequency (Hz) and time, and color shows signal strength (dBm) in a bar on the right hand side**

# 3 WIRELESS APPLICATIONS AND COMMUNICATION REQUIREMENTS

## Scope of wireless applications in factory

The wireless applications considered in this section illustrate wireless systems that are used currently or in the near future within factories and related facilities. The applications correspond to wireless systems that are installed for a specific purpose.

For example, wireless applications are highlighted in the factory network as shown in Figure 7. The colored lines indicate the data streams planned for specific purposes such as “Collecting Management Information.” The wireless sub-networks consisting of multiple wireless connections are deployed to support the information transmission and aggregation for different applications.

The factory network must be built, configured, and managed to support the successful operation with wireless links. In some cases, a critical application may demand a separate wireless segment setup due to special concerns.

Section 4, entitled “Factory Usage Scenarios,” considers factory sites with large needs for wireless communication and describes usage scenarios in which multiple wireless applications coexist.

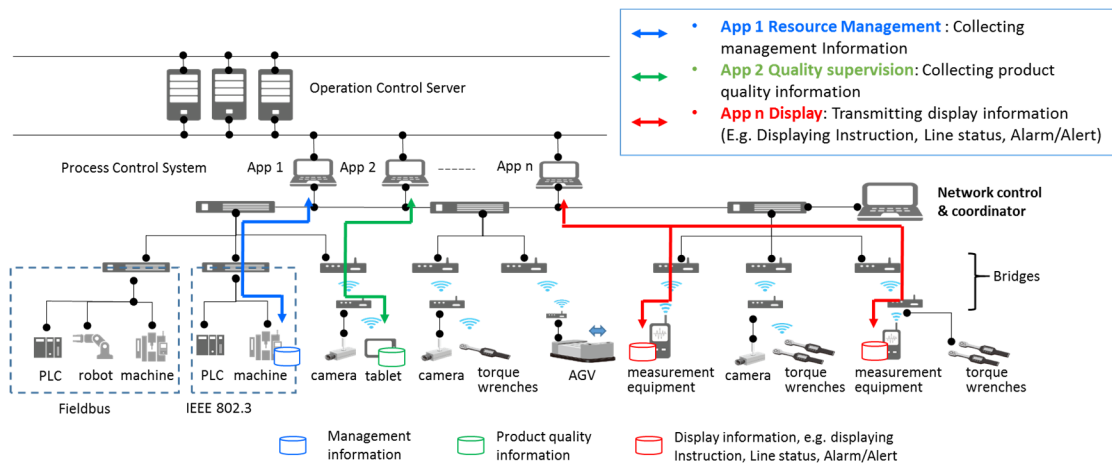

Figure 7—Wireless applications in factory

## Wireless applications

In a usage survey (Flexile Factory Project [18]) of wireless communication in factories, characteristics of various applications were collected. These are classified according to their purposes, and organized by their communication requirements. Collected wireless applications are listed in Table 1. These were divided into six categories, (equipment control, quality supervision, factory resource management, display, human safety, and others), and then subdivided into thirteen classifications according to their corresponding purposes.



**Table 1—Wireless applications**

Category	Description	Classification according to the purpose
Equipment Control	Sending commands to mobile vehicles, production equipment, and receiving status information	(1) Controlling and operating of production equipment, auxiliary equipment
Quality Supervision	Collecting information related to products and states of machines during production	(2) Checking that material is being produced with correct precision (3) Checking that production is proceeding with correct procedure and status
Factory Resource Management	Collecting information about whether production is proceeding under proper environmental conditions, and whether personnel and things <sup>3</sup> contributing to productivity enhancement are being managed appropriately	(4) Checking that the production environment (e.g., according to factors such as temperature, pressure, etc.) is being appropriately managed (5) Monitoring movement of people and things (6) Checking the status of equipment and checking the material, small equipment and tool stocks (7) Monitoring the maintenance status of equipment during operation (8) Appropriate recording of work and production status
Display	For workers, receiving necessary support information.  For managers, monitoring the production process and production status	(9) Providing appropriate work support, such as instructions and tracking information  (10) Visually display whether the process is proceeding without congestion or delay, production irregularities  (11) Visually display the production status, the production schedule, and any deviations or operational abnormalities
Human Safety	Collecting information about dangers to workers	(12) Ensuring the safety of workers
Others	Communication infrastructure with non-specific purposes	(13) Cases other than the above

## Communication requirements

Figure 8 shows representative wireless applications, with corresponding classifications (1)–(13) from Table 1, and their wireless communication features. Values of data size, data generation rate, number of wireless nodes, and so forth, depend on the required functions of the systems. Wireless

<sup>3</sup>Physical objects such as materials and equipment related to production are called “things”.

networks use different wireless frequency bands and wireless standards. High-frequency bands such as 60 GHz band are expected to be effective for systems with relatively large data volume requirements (image inspection equipment, etc.). 5 GHz band and 2.4 GHz band networks are used for systems with medium requirements of data sizes and data generation rate, such as distributing control programs and control of mobile equipment. Relatively low wireless frequency bands such as below 1 GHz are being used for applications with low power requirements (such as environmental sensing).<sup>4</sup>

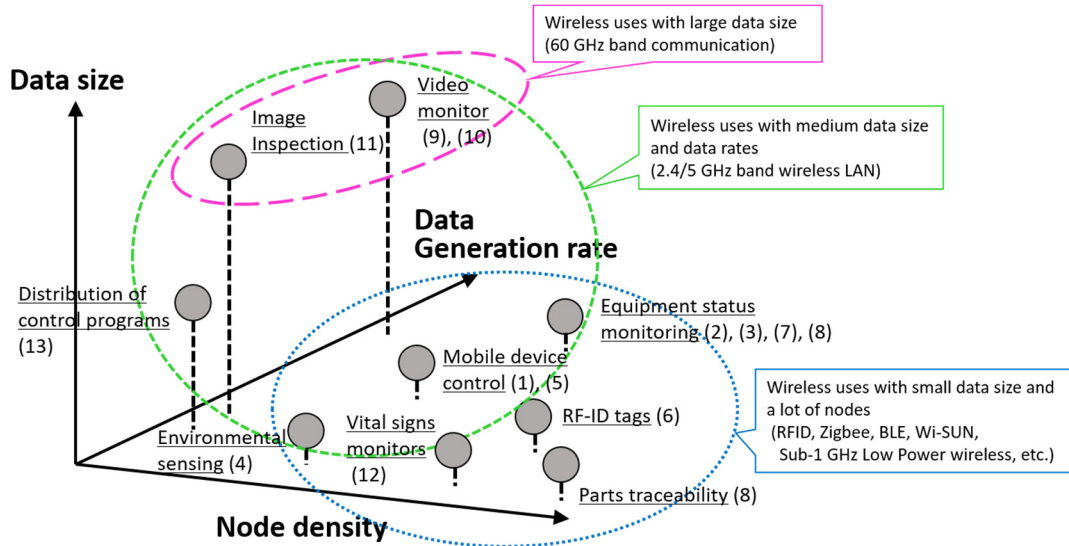

**Figure 8—Representative wireless applications with corresponding classifications (1)–(13) from Table 1 and their wireless communication features**

Figure 9 shows the permissible delay for representative wireless applications as in Flexible Factory Project [18] and NICT press release [21]. This permissible delay is for end-to-end including wired and wireless portions. For some wireless applications, such as robot control and urgent announcement, the urgency and accuracy of information arrival timing requires less than one millisecond latency. On the other hand, particularly in the categories of quality (inline inspection, etc.) and management (preventive maintenance, etc.), there are many wireless applications that tolerate latencies larger than 100 ms.

<sup>4</sup>Lower-frequency radio waves propagate better than higher-frequency ones. This allows a better range and lower transmitting power, resulting in low power consumption. Environmental sensing that requires long life battery operation is a good example of low power applications. Lower-frequency bands below 1 GHz have become typical for such applications [19] [20].

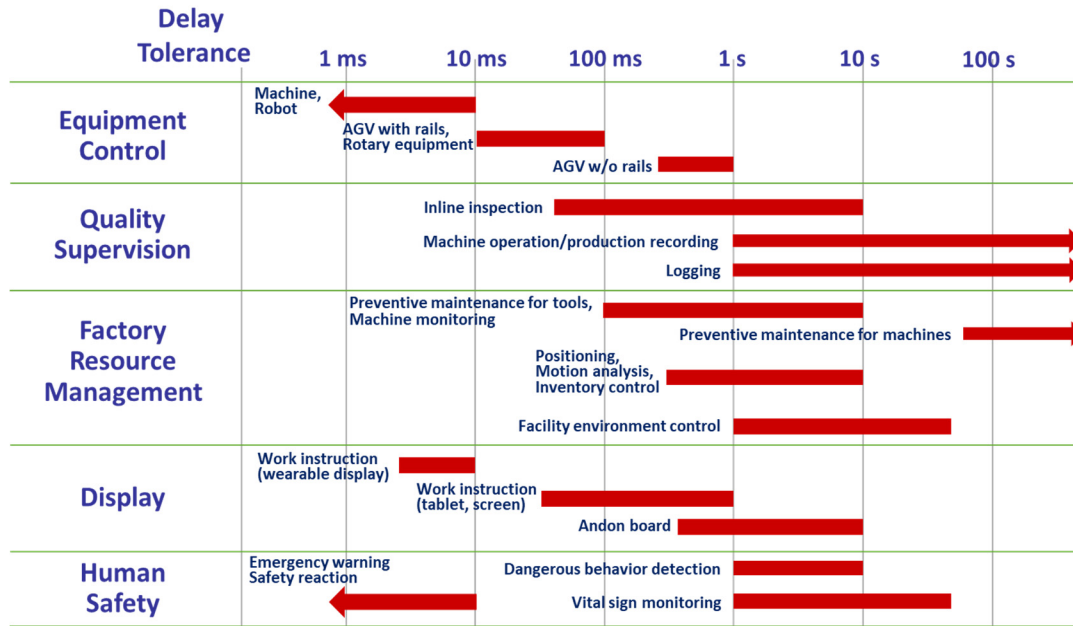

Figure 9—Permissible delay of representative wireless applications

### Details of wireless application and communication requirements

Communication requirements for the thirteen classifications of wireless applications are organized in Table 2 to Table 14. Each table contains further detailed purpose of the wireless application, corresponding information, and the communication requirements of transmitted data size, communication rate, delivery time tolerance, and node density.<sup>5</sup> These attributes are based on a survey involving for a number of samples within many factories.<sup>6</sup>

Table 2—List of wireless applications and communication requirements for equipment control

(1) Controlling, operating, and commanding of production equipment and auxiliary equipment

No.	Wireless application		Communication requirements			
	Purpose	Corresponding Information	Transmit Data Size (bytes)	Communication Rate	Delivery Time Tolerance	Node density
1	Control of liquid injection	Water volume	64	Once per 1 min	100 ms	1
2	Operation of conveyor control switch	PLC	16	5 per 1 d	100 ms	5

Table continues

<sup>5</sup>Node density: number of terminals per 20 m × 20 m. This area dimension is based on the structure in a typical factory in which pillars are separated by 20 m.

<sup>6</sup>The survey in [18] was conducted in 2016 by collecting information from factories of foods, beverages, steels, pulp and paper mill, semiconductors, electrical equipment, electronics devices, communication devices, automotive, chemical plant, precision instruments, and metal processing. The survey included information from companies that provide devices and equipment with communication functions to factories. Additional information available on the internet was also included in the survey results.

No.	Wireless application		Communication requirements			
	Purpose	Corresponding Information	Transmit Data Size (bytes)	Communication Rate	Delivery Time Tolerance	Node density
3	AGV control	Go signal, positioning	100	Once per 1 min	100 ms	1 to 10
4	Bottle filling	Fill valves	400	Once per 1 ms	500 $\mu$ s	2
5	Warehouse	Stacker crane positioning	10	Once per 2 ms to 5 ms	1 ms	1 to 20

**Table 3—List of wireless applications and communication requirements for Quality Supervision -1**

(2) Checking that products are being produced with correct precision

No.	Wireless application		Communication requirements			
	Purpose	Corresponding Information	Data Size (bytes)	Communication Rate	Delivery Time Tolerance	Node density
6	Size inspection by line camera (line sensor)	Size measurements	30 K	Once per 1 s	5 s	1 to 5
7	Detect defect state	Defect information (video)	500	Once per 100 ms	500 ms	1 to 5
8	Detect incorrect operation	Anomalous behavior due to adding impurities (e.g., Contamination)	1 M	Once per 1 s	10 s	1 to 5

**Table 4—List of wireless applications and communication requirements for Quality Supervision -2**

(3) Checking that manufacture is proceeding with correct procedure and status

No.	Wireless application		Communication requirements			
	Purpose	Corresponding Information	Data Size (bytes)	Communication Rate	Arrival Time Tolerance	Node density
9	Sensing for managing air conditioning	Air stream to control temperature in different zones	64	Once per 1 s	1 min	1
10	Monitoring of equipment	State of tools, disposables	A few hundreds	Once per 1 s	1 s	2
11	Counting number of wrench operations	Pulses	64	Once per 1 min	100 ms	10

**Table 5—List of wireless applications and communication requirements for  
Factory Resource Management -1**

(4) Checking that the factory environment is being correctly managed

No.	Wireless application		Communication requirements			
	Purpose	Corresponding Information	Transmit Data Size (bytes)	Communication Rate	Delivery Time Tolerance	Node density
12	Managing clean room (booth)dust count	Dust count (particles)	32	Once per 1 min	5 s	5
13	Managing carbon dioxide concentration	CO <sub>2</sub> concentration	16	Once per 1 min	5 s	2
14	Preventive maintenance	Machine's temperature	A few tens	Once per event	1 s	2

**Table 6—List of wireless applications and communication requirements for  
Factory Resource Management -2**

(5) Monitoring movement of people and things

No.	Wireless application		Communication requirements			
	Purpose	Corresponding Information	Transmit Data Size (bytes)	Communication Rate	Delivery Time Tolerance	Node density
15	Movement analysis	Wireless beacon	A few tens	Twice per 1 s	A few seconds	1 to 10
16	Measuring location of people and things, e.g., radio beacon	Transmission time (phase), radio signal strength, etc.	A few tens of thousands	Once per 1 s	1 s	2
17	Measuring location of products	Location of products during manufacture	200	Once per 1 s	1 s	20

**Table 7—List of wireless applications and communication requirements for Factory Resource Management -3**

(6) Checking the status of equipment and checking the material, small equipment and tool stocks

No.	Wireless application		Communication requirements			
	Purpose	Corresponding Information	Transmit Data Size (bytes)	Communication Rate	Delivery Time Tolerance	Node density
18	Racking assets (beacon transmission)	Information of equipment and things	200	Once per 1 s	1 s	20
19	Tracking parts, stock	RFID tag	1 K	1~10 times per 30 min	100 ms	3 to 30

**Table 8—List of wireless applications and communication requirements for Factory Resource Management -4**

(7) Monitoring the maintenance status of equipment during operation

No.	Wireless application		Communication requirements			
	Purpose	Corresponding Information	Transmit Data Size (bytes)	Communication Rate	Delivery Time Tolerance	Node density
20	Managing facilities	Activity of PLC	4 K	Once per 1 s ~ once per 1 min	1 s ~ few tens of 1 s	1 to 10
21	Measuring energy	Energy, current fluctuation	64	Once per 1 min	1 min	1
22	Monitoring revolving warning light	Defect information	100	A few times per 1 h	1 s	25

**Table 9—List of wireless applications and communication requirements for Factory Resource Management -5**

(8) Appropriate recording of work and production status

No.	Wireless application		Communication requirements			
	Purpose	Corresponding Information	Transmit Data Size (bytes)	Communication Rate	Delivery Time Tolerance	Node density
23	Work record	Text data	100	Once per 1 min	1 s	9
24	Work proof	Certification data	1 K	Once per 3 h	10 s	9
25	Checking completion of process	Image, torque waveform	100 K	Once per 1 s (up to 1 min)	200 ms	1 to 14
26		OK, NG	100	Once per 1 s (up to 1 min)	200 ms	1 to 14

**Table 10—List of wireless applications and communication requirements for Display -1**  
 (9) Providing appropriate work support, such as instructions and tracking information

No.	Wireless application		Communication requirements			
	Purpose	Corresponding Information	Transmit Data Size (bytes)	Communication Rate	Delivery Time Tolerance	Node density
27	Work commands (wearable device)	Image	600	Once per 10 s ~ 1 min	1~10 s	10 to 20
28	View work manual	Text data	100	Once per 1 h	10 s	9
29	Display information (image display)	Image (video/still image)	5 M	Once per 10 s ~ 1 min	A few seconds	1 to 5

**Table 11—List of wireless applications and communication requirements for Display -2**  
 (10) Visually display whether the process is proceeding without congestion or delay production irregularities

No.	Wireless application		Communication requirements			
	Purpose	Corresponding Information	Transmit Data Size (bytes)	Communication Rate	Delivery Time Tolerance	Node density
30	Managing congestion	Counter (number or remaining number)	A few bytes	Once per 10 s ~ 1 min	A few seconds	1 to 10
31	Managing operation activity	Activity of PLC	128	Once per 1 h	100 ms	2
32	Displaying revolving warning light	ON/OFF	A few bytes	Once per 10 s ~ 1 min	0.5~2.5 s	30

**Table 12—List of wireless applications and communication requirements for Display -3**  
 (11) Visually display the production status, the production schedule, and any deviations or operational abnormalities

No.	Wireless application		Communication requirements			
	Purpose	Corresponding Information	Transmit Data Size (bytes)	Communication Rate	Delivery Time Tolerance	Node density
33	Managing operation activity	Image	6 K	30 per 1 s (30fps)	500 ms	1
34	Supporting workers	PLC	200	Once per 10 s ~ 1 min	500 ms	5

Table continues

No.	Wireless application		Communication requirements			
	Purpose	Corresponding Information	Transmit Data Size (bytes)	Communication Rate	Delivery Time Tolerance	Node density
35	Supporting maintenance	Image, audio	200	Once per 100 ms	500 ms	1

**Table 13—List of wireless applications and communication requirements for human safety**  
(12) Ensuring the safety of worker

No.	Wireless application		Communication requirements			
	Purpose	Corresponding Information	Transmit Data Size (bytes)	Communication Rate	Delivery Time Tolerance	Node density
36	Detecting dangerous operation	Image	6 K	10 per 1 s (10fps)	1 s	1
37	Collecting bio info for managing worker safety	Vitals information (wearable)	100	Once per 10 s	1 s	9
38		Vitals information (fixed, relay)	200	Once per 1 min	5 s	20
39		Gait	About 100K	~10 per 1 s (1 fps~10 fps)	1 min	10 to 20
40	Detect entry to forbidden area	Body temperature, infrared	2	When event occurs	1 s	1
41	Detect entry in the proximity of a machine	Position of human (via connected wireless unit)	10-30	100 to 1000 per 1 s	2 to 20 ms	1 to 50

**Table 14—List of wireless applications and communication requirements for others**  
(13) Cases other than above

No.	Wireless application		Communication requirements			
	Purpose	Corresponding Information	Transmit Data Size (bytes)	Communication Rate	Delivery Time Tolerance	Node density
42	Sending data to robot teaching box	Coordinates	Few hundred thousand bytes	Twice per year	Less than 500 ms (safety standard)	10
43	Relay of images moving	Video	20 K	30 per 1 s	20 ms	5
44	Techniques, knowhow from experts	Video, torque waveforms	24 K	60 per 1 s (60 fps)	None	1



# 4

## FACTORY USAGE SCENARIOS

The usage scenario represents a complete manufacturing process that utilize a number of factory applications to achieve a deliverable product. Examples of factor usage scenarios include the following:

- Metal processing site
- Mechanical assembly site
- Elevated and high temperature work site
- Logistics warehouse site

Example factory-usage scenarios and their collective applications used are described next.

### Usage scenarios example: Metal processing site

An illustration depicting a wireless usage scene at a metal working site is shown in Figure 10. A building has a row of machine tools, and materials and products (things) are managed in a certain area of the building. Workers are at locations within the building as needed to operate the machines. In the case of operation monitoring and preventive maintenance, sensors may be attached to machines. Because machine tools may be used for twenty to thirty years, there may be many old machines, with sensors attached after installation. Communication is necessary to collect information from sensors, but if ceilings are high, installing wiring requires high site work, making the cost of wiring expensive. The cost and long work times required by rewiring work when machines are relocated make wireless communication desirable. In the case of management of objects and analysis of worker movement, the subjects move, so the use of wireless communication is a necessity.

In the case of operation monitoring, monitor cameras and sensors are installed on machines to monitor the operation status of the machines. For wireless operation, wired LAN to wireless LAN media converters are installed on wired LAN ports. On machines without wired LAN ports, adaptors may be connected for wireless networking. A wireless network is formed between the machines and a wireless access point, and when an intermittently operated machine is switched on, a link with a wireless access point is established automatically without human intervention. As the wireless interference conditions change with the ON/OFF of wireless devices operating in coordination with the intermittent operation start and stop of nearby machines, it is necessary for the wireless network to have flexibility, such as monitoring the radio environment and switching the used frequency channel. Using this network, time series data such as vibration and torque waveforms acquired by tools and sensors inside machines during operation are sent to a server. Using the acquired data on the server, analysis software detects anomalies or anomaly precursors, and informs a manager. According to requirements such as the number of devices, transmitted data volume, and necessity of real-time response, the data is transmitted by an appropriate wireless network such as wireless LAN, Bluetooth, or Zigbee.

In the case of preventive maintenance, various sensors are installed on machine tools. The sensors and wireless communication device are implemented on a single terminal, and terminals may execute primary processing before sending, or the gateway may execute primary processing on data

collected from sensors via a wireless network. When sensors and a wireless device are implemented on a single terminal, the terminal may aggregate data received from other terminals within radio range and attach it to its own data when it transmits to reduce the number of transmissions. It may be necessary to sample or compress the data to reduce the volume of data transmitted. In addition, data may be normally recorded at the terminal, but limited under certain conditions in order to reduce the data volume.

In the case of management of objects and movement of workers, wireless communications such as Bluetooth Low Energy (BLE) are used to monitor the locations of people and things. A wireless location monitoring system uses tags that periodically transmit beacons, and gateways that receive the beacons. Multiple gateways are placed in the monitor area and tags are attached to each person or thing to be monitored. Beacons transmitted by a tag are received by multiple gateways and the received signal strengths are used to determine the location of the tag. By obtaining acceleration information as well as tag ID, the accuracy of location information can be increased. Wireless communication is also used when an operator remotely operates a robot with a terminal called a teaching box. The operator moves around the robot to visually check the position of the robot and its relation with the object being processed. The movement of the operator is only around the robot and not over a wide area, but it is important that the response of the wireless communications is fast. In order to help ensure safety, commands triggered by an emergency stop switch need to be transmitted immediately and reliably.

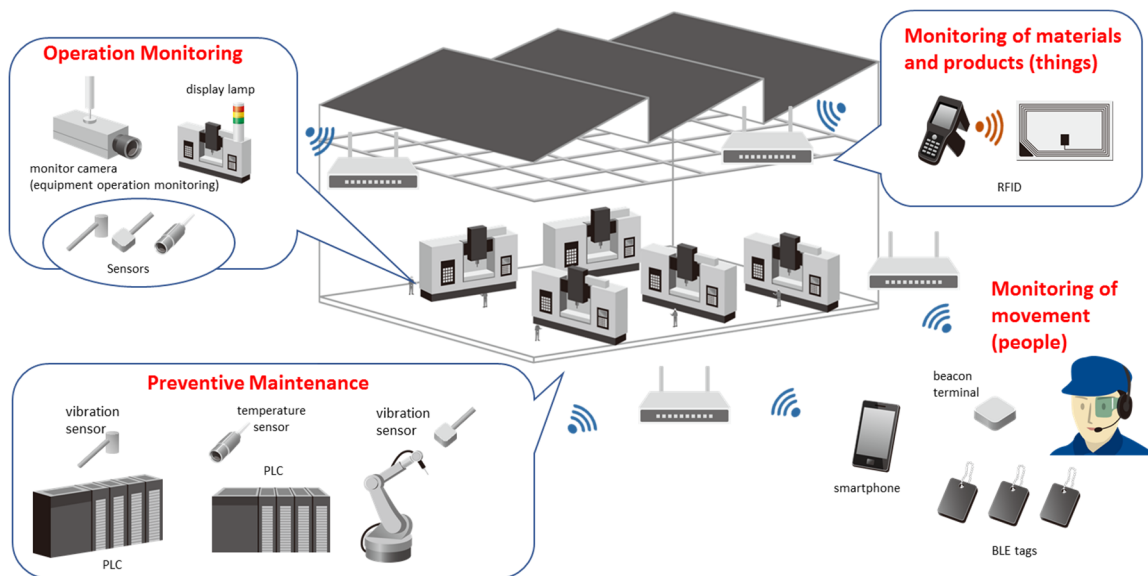

**Figure 10—Usage scene: Metal working site**

### Usage scenarios example: Mechanical assembly site

A wireless usage scene at a mechanical assembly site is shown in Figure 11 as an example in automotive plant. In a mechanical assembly plant, the benefit of wireless communications is expected where there is management of building systems for collection and analysis of data for quality management and traceability, and management of operations, such as AGVs for transport of components.

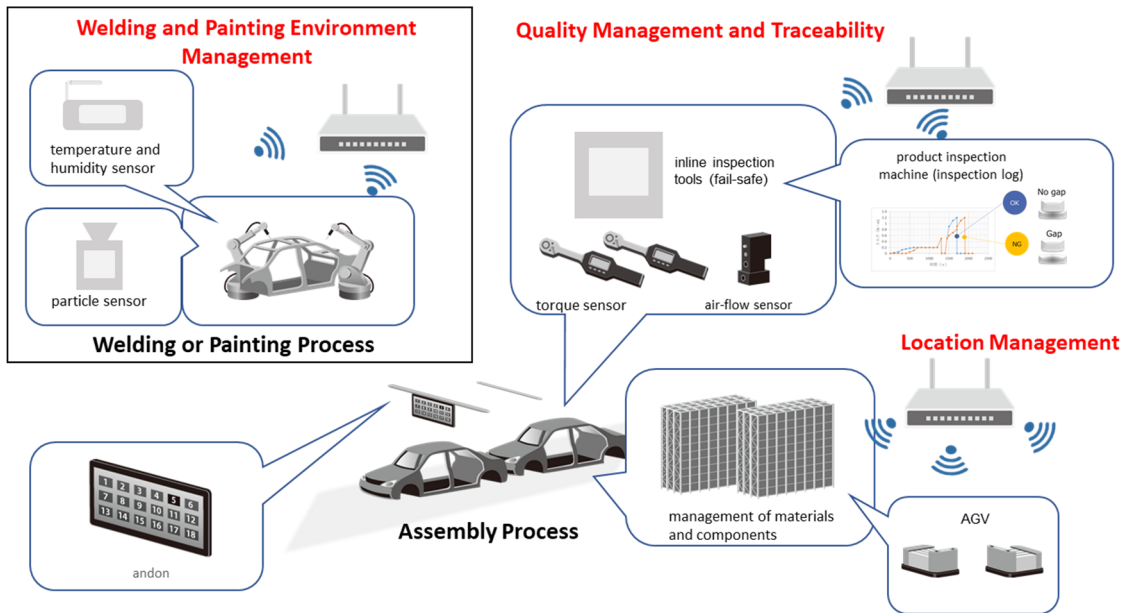

**Figure 11—Usage scene example: Mechanical assembly site (automotive plant)**

Wireless communication is used to send data to servers—inspection data from large numbers of workbenches, operation sequences in Programmable Logic Controllers (PLC) used for machine control, error information, and environmental information. Also, work tools such as torque-wrenches, acquire and send data to servers such as the number of wrench operations and the success of the operations, and even time series data such as vibration and torque waveforms. As ISO 9001 specifies the mandatory recording of inspection data, it requires the reliable collection of data, although strict requirements are not imposed on communication latency. Hence when transmitting data, it is necessary to check radio usage in the neighborhood, and use available frequency bands and time slots (transmission times) according to the requirements such as number of machines, transmitted data volume, and necessity of real-time response.

In the case of production management display (such as an “Andon” display board), in coordination with the above information, wireless communication is used to send data for real-time display of production status information, such as production schedule, production progress, and production line operation status.

In the case of AGV with autonomous driving ability, the AGV itself will be able to control its current position and path. Each AGV will be sent a command “go from position A to position B” from a parent device (fixed device) and the AGV will move accordingly. As an AGV may move over a wide area in a factory, it is possible that in some locations the quality of wireless communication will degrade due to physical obstruction by facilities and manufacturing machine tools. Hence, it is necessary to consider the radio propagation environment when deciding where to place wireless access points and to consider the use of multi-hop networks. The number of mobile vehicles used in factories is continuing to increase, and the related issues of the radio environment will require more consideration in the future.

In a modern automotive plant, the welding or painting process is usually located adjacent to the mechanical assembly. As such, IoT devices such as temperature, humidity, and particle sensors are used for environmental monitoring in places such as paint-shops or clean-booths as shown in Figure 13. Wireless communication is used for collecting sensor information remotely at any time from outside the rooms where the sensors are installed without requiring reconstruction work. The sensors transmit collected environmental information to an upper layer server at periodic time intervals. It is required that no data loss occurs. As such, communication routes can be checked when necessary at times of trouble, and relay devices can be installed where radio signal reception is weak without complex expert knowhow.

### Usage scenarios example: Elevated and high temperature work site

Figure 12 shows an illustration of a wireless communication scene in an elevated and high-temperature work site. In production sites such as chemical plants and steel plants, there are intrinsic dangers due to collisions and falls, and extreme environments with high temperatures and high humidity. Monitoring each worker's location and situation from vitals sensors and visual images will be an important application. Workers move about, so it is necessary to collect data using wireless communication. It is assumed that production facilities will be used for many years, so it is necessary to collect information about facility operation and monitor facility operation from a preventive maintenance perspective. In regard to collecting information from existing facilities, the use of wireless systems that can be easily be added are promising for monitoring facility operation using cameras and indicator lights.

In a production site with elevated or high-temperature work places, such as a drying furnace or a blast furnace, wireless communication is used to manage the safety of workers by collecting workers' vitals sensor information (pulse, activity, body temperature, room temperature, posture for fall detection, etc.) and environmental information (temperature and humidity, pressure, dew point, etc.), and remotely monitoring the situation at the production site using cameras etc. In such cases, wireless communications, such as multi-hop networks with wireless LAN/920 MHz communication, are used to collect data. Using sensors that detect entry into forbidden areas, combined with BLE beacons, it is possible to monitor the location of workers and warn of entry into dangerous areas. Wireless communications are basically used to transmit position information and vital information of each worker, but it is also possible to send alerts to workers and managers when an abnormal situation arises. Vitals sensors should be of types that do not interfere with the work to be performed, such as wristwatch type, pendant type, or breast-pocket type.

The communication terminals in a production site may form a wireless multi-hop network, and upload sensor data to a cloud service or server (where the data is finally collected) via a gateway. The uploaded data is used to monitor the worker's status. For example, in the case of a system with a path from a sensor attached to a worker via a gateway to a server, wireless communication from the sensor to the gateway might use 920 MHz band communication, wireless LAN, or Bluetooth. Communication from gateway to server will require connection via 3G/LTE or wired LAN. When the server is far from the gateway, and it is necessary to have a wireless connection (such as when wiring is not possible) a wireless mesh using wireless LAN, or a point-to-point 60 GHz frequency band system may be used as a backbone. In this case, interference between the wireless backbone and the communication between sensors and gateway must be considered.

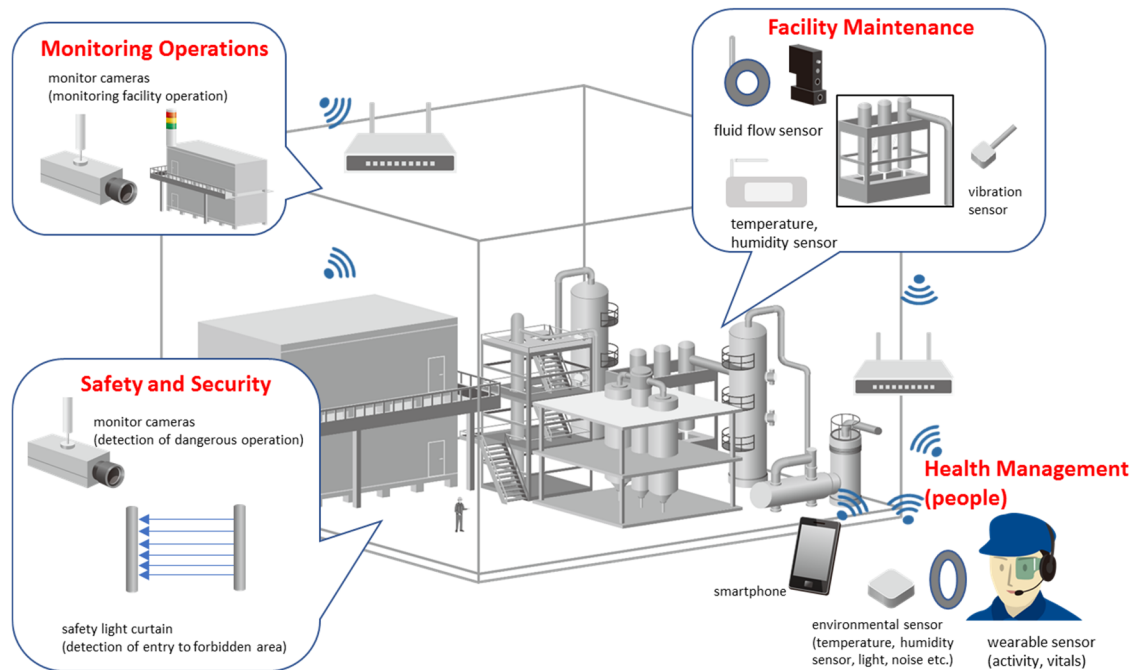

**Figure 12—Usage scene example: Elevated and high temperature work site**

### Usage scenarios example: Logistics warehouse site

In a logistics warehouse,<sup>7</sup> as shown in Figure 13, three-dimensional automatic storage<sup>8</sup> is used to increase spatial use efficiency. Operation of a three-dimensional automatic storage system requires monitoring of storage operation, preventive maintenance of the stacking system, management of AGV movement, and so on. A large-scale warehouse has multiple storage racks placed in a row, each over 30 m height and 100 m length, and separated by a few meters or less.

The operational status of the warehouse is monitored in conjunction with the transport of storage items in and out by a computer-controlled stacker-crane. When the stacker-crane makes an emergency stop due to detecting a stacking fault, workers might have to climb up a high ladder, tens of meters high, to manually check and repair the stack.

When the inspection and repair operation is in a high place, there is greater danger for the worker and operation delay time increases. Previously, workers had to spend time checking the storage even when there was actually no need to stop. Now cameras are used to remotely check the situation on the stacks and the stacker-crane to decide whether operation should be halted or continued, reducing the number of dangerous tasks for workers, and reducing the average time to recovering normal operation. However, in large-scale storage systems, the stacker-cranes move over large ranges, and wiring to cameras attached to stacker-cranes is difficult. Using wireless cameras eliminates the need for signal cables, and so the installation of wireless cameras in three-dimensional automatic storage systems is increasing. Information is sent from the wireless devices

<sup>7</sup>A warehouse in which items are stored and managed in racks, and moved in and out automatically with computer control.

<sup>8</sup>Equipment for transporting in and out of a three-dimensional automatic storage system.

on the luggage platform of the stacker-crane to wireless access points (fixed stations) that are placed at one or both ends of the stacker-crane's floor rail.

The images sent from the camera could be video (for example, 30 frames-per-second VGA) or still images (for example, JPEG or PNG with VGA resolution). The speed of the luggage-platform could be as fast as 5 m/s, and the wireless device should automatically select, connect to, and transmit data to the wireless access point with the best link quality. It should also avoid interference with wireless devices on other stacker-cranes that might be running on parallel racks separated by just a few meters.

In three-dimensional automated storage systems, higher speeds of stacker cranes and their continuous operation are required to increase the transport efficiency. Sensors are attached to the drive system that drives the vertical motion of the luggage-platform, and the drive system that drives horizontal motion of the crane along its rails. A wireless communication device relays the sensor data, and computer analysis, and learning of the data is used for preventive maintenance of the drive systems.

In some cases, in order to increase the flexibility of the layout in the warehouse, the luggage carried out by a stacker-crane is transported to another storage or work place by a forklift or AGV. The magnetic tape that is used on the floor to guide the motion of a trackless AGV cannot carry data, so control information such as destination is sent by wireless communication. Also, forklifts and AGVs have devices for detecting their location, and location information is relayed by wireless communication. Location information collected from forklifts and AGVs is used to manage their operation. Methods are also being developed to improve transport efficiency by coordinating their motion with stacker-cranes, allowing the selection of the AGV with the shortest travel distance, for example.

Concerning the use of sensors for preventive maintenance on drive systems of stacker-cranes, and managing movement of forklifts and AGVs, in large-scale factories, the range of motion may extend over large areas with various large structures such as three-dimensional storage racks. Therefore, the placement of wireless access points, the selection of wireless frequency band, and possible use of directional antenna are important issues.

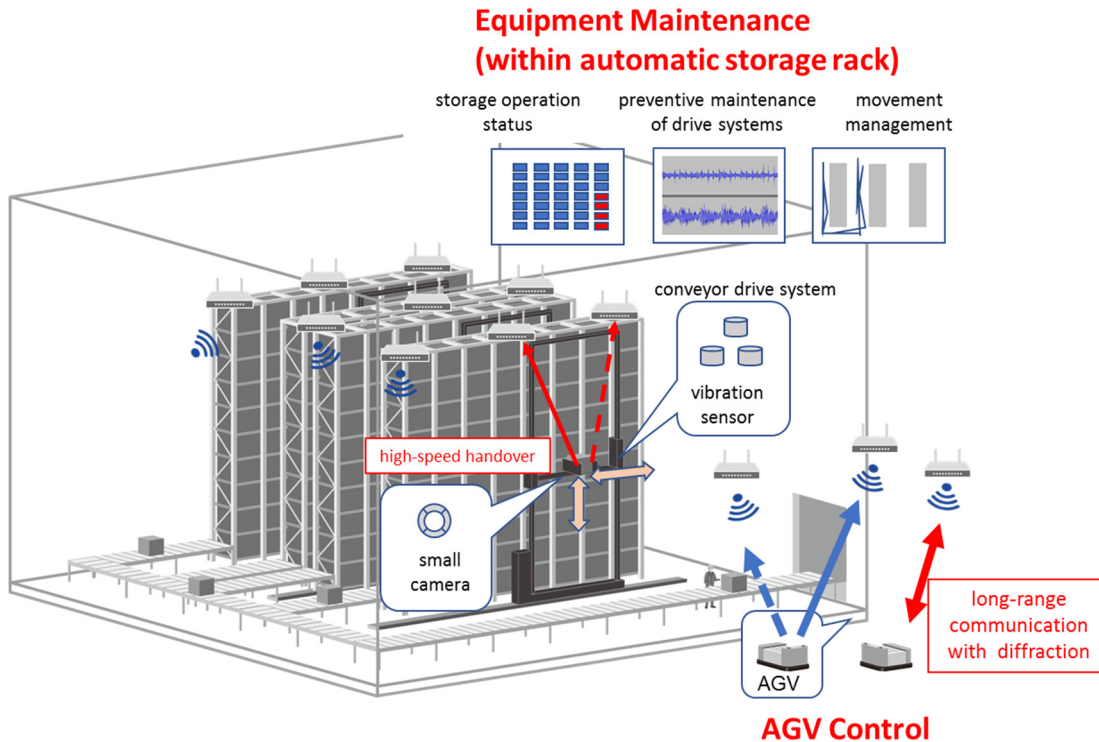

Figure 13—Usage scene example: Logistics warehouse site

## 5 TECHNOLOGICAL ENHANCEMENT OF NETWORKING FOR FLEXIBLE FACTORY IOT

### Coexisting of wide variety of factory applications with different requirements

According to Figure 9 and Table 2 through Table 14 in “Wireless Applications and Communication Requirements,” examples of QoS tolerances in factory applications are summarized in Table 15. Table 15 shows that tolerance of latency is classified into small, medium, or large; tolerance of bandwidth is classified into wide, medium, or narrow; and tolerance of packet loss is classified into loss intolerant or loss-tolerant. It means that factory applications may be represented by not only traffic classes but also additional information related to QoS requirements, which include traffic flow identification and specifications in IEEE Std 802.1Q [22] or similar specifications depicting data attributes.

In addition, there would be a requirement to map priority from the IEEE 802.1 domain to the specific media (e.g., wireless link) and achieve the required performance.

**Table 15—Examples of QoS Tolerances in Factory Applications**

Category of Wireless Applications	QoS Tolerances							
	Latency (ms)			Bandwidth (kbit/s)			Packet Loss	
	<100	100~1000	>1000	>1000	100~1000	<100	Loss-intolerant	Loss-tolerant
Equipment Control	✓	✓				✓	✓	
Quality Supervision	✓	✓	✓	✓	✓	✓	✓	
Factory Resource Management		✓	✓	✓	✓	✓	✓	✓
Display		✓	✓	✓	✓	✓	✓	✓
Human Safety	✓		✓	✓	✓	✓	✓	✓
Others		✓	✓	✓			✓	✓

**Overview of the standard landscape for Flexible Factory IoT**

A list of relevant existing standards and standard projects are provided in Table 16.

**Table 16—Standards and Projects relevant to Flexible Factory Network**

Working Group	Standard and Project	Title
IEEE 802.1	IEEE Std 802.1Q-2018 Clause 35	Stream Reservation Protocol (SRP)
	IEEE Std 802.1AS-REV	Timing and Synchronization for Time-Sensitive Applications
	IEEE Std 802.1BA	Audio Video Bridging (AVB) Systems
	IEEE Std 802.1Qcc	Stream Reservation Protocol (SRP) Enhancements and Performance Improvements
	IEEE Std 802.1CB	Frame Replication and Elimination for Reliability
	IEEE Std 802.1Q-2018 Clause 36	Priority-based Flow Control
	IEEE Std 802.1CF-2019	IEEE Recommended Practice for Network Reference Model and Functional Description of IEEE 802® Access Network
	IEC/IEEE 60802	TSN Profile for Industrial Automation
IEEE 802.11	IEEE Std 802.11aa	MAC Enhancements for Robust Audio Video Streaming
	IEEE Std 802.11ak	Enhancements for Transit Links Within Bridged Networks
	IEEE Std 802.11e	Medium Access Control (MAC) Quality of Service Enhancements
	IEEE Std 802.11ae	Prioritization of Management Frames

Non IEEE 802 standards also exist and can be found in IEC website [23].

TSN defines standard L2 technology to provide deterministic capability on IEEE 802.1Q bridged networks. It guarantees end-to-end QoS for the real-time applications with bounded latency, minimized jitter, and high reliability. Industries like automotive, industrial, and professional audio



comprised by multiple network devices will benefit from deterministic connectivity and optimization over Ethernet wires.

Future industrial wireless communications will take advantage of this infrastructure. The wired/wireless integrated networks for future flexible factories IoT scenarios should be able to accommodate various applications with different end-to-end QoS requirements. These requirements can be guaranteed by closing the gaps within the following functions:

- End-to-end stream reservation in a wired/wireless integrated network
- Wireless link redundancy for reliability and jitter improvement
- Adaptation to rapid changes in wireless environments
- Coordination among the wireless transmissions in the unlicensed bands

## Gaps analysis of existing standards and technologies for Flexible Factory network

### End-to-end stream reservation in a wired/wireless integrated network

Streams are used to describe the data communication between end stations with strict time requirements. In 2010, the 'Audio/Video Bridging (predecessor of TSN) Task Group' standardized the Stream Reservation Protocol (SRP) as IEEE Std 802.1Q-2018 Clause 35, which was then incorporated in the mainline IEEE 802.1Q standard.

The protocol allows end stations to register their willingness to "Talk" or "Listen" to specific streams, and it propagates that information through the network to reserve resources for the streams. Network bridges between the end stations maintain bandwidth reservation records when a Talker and one or more Listeners register their intentions for the same stream over a network path with sufficient bandwidth and other resources. SRP utilizes three signaling protocols from IEEE Std 802.1Q-2018, MMRP (subclause 10.9), MVRP (Clause 11), MSRP (subclause 35.1), and the new draft project IEEE P802.1Qdd on Resource Allocation Protocol to establish stream reservations across a bridged network.

IEEE Std 802.11aa specifies a set of enhancements to the original IEEE 802.11 MAC QoS functions that enables the transportation of AV streams with robustness and reliability over wireless shared medium. It defines the interworking with bridge networks to facilitate end-to-end stream reservations when one or more IEEE 802.11 wireless links are in between Talker and Listener.

It is stated in Annex C.3 of IEEE Std 802.1Q that "From the bandwidth reservation standpoint, an IEEE 802.11 BSS network is modeled as a Bridge." As one of the essential advantages of SRP, it provides a single bandwidth reservation protocol across multiple media types of both wired and wireless.

The recently published standard, IEEE Std 802.1Qcc, specifies a set of large enhancements to SRP, introducing the concept of a centralized configuration model with a centralized network controller (CNC). As shown in Figure 14, CNC is a new system level entity that may be capable of calculating the best possible solution for a set of predefined configuration and configure the bridges to meet those QoS demands conveyed through the User Network Interfaces (UNI). Within UNI, the attributes about traffic specifics and maximum latency are shared with the CNC for proper stream management in an end-to-end perspective.

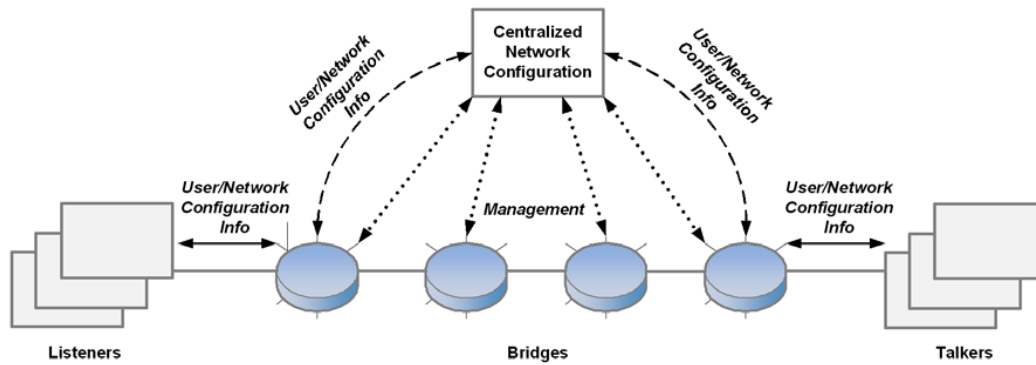

**Figure 14—Centralized configuration bridge network**

Such a new paradigm can be much appreciated in the wired/wireless integrated networks in flexible factories, as shown in Figure 15. If partial network resources like bandwidth cannot temporarily meet the performance required by the traffic streams, the CNC will notify the user and work out a solution with modified configuration to accommodate the QoS requirements of the system. A CNC type of wireless controller for both bridges and IEEE 802.11 AP/STA will certainly be helpful in the scenario to address the unstable wireless bandwidth and latency issues. By managing all the traffic streams between all connections in the network, the robustness of the stream reservation and the network efficiency will both be improved.

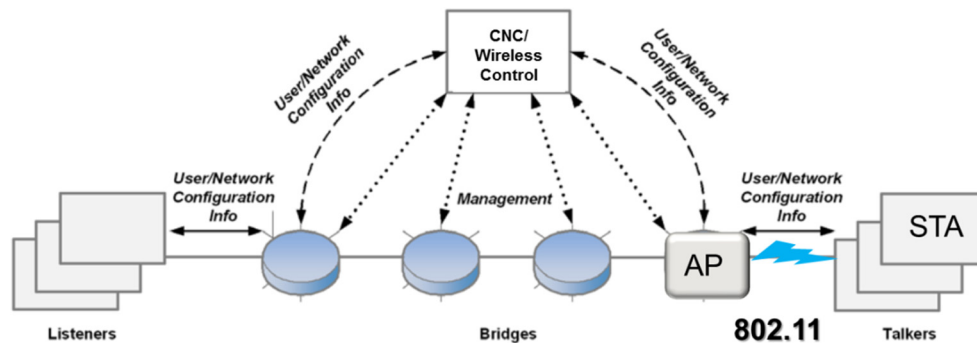

**Figure 15—Centralized configuration heterogeneous network**

### Wireless link redundancy for reliability and jitter improvement

Beginning in approximately 2012, efforts began in the IEEE 802 TSN Task Group to specify seamless redundancy in conjunction with TSN streams, particularly to address Layer 2 networks in industrial control and automotive markets. Eventually, this led to the completion and publication of IEEE Std 802.1CB-2017, specifying “Frame Replication and Elimination for Reliability” (FRER). IEEE Std 802.1CB provides specifications “for bridges and end systems that provide identification and replication of packets for redundant transmission, identification of duplicate packets, and elimination of duplicate packets.” Essentially, packets are duplicated and transmitted along differentiated paths; copies received at the destination, following the first, are discarded. The

purpose is “to increase the probability that a given packet will be delivered,” and to do so in a timely manner. FRER “can substantially reduce the probability of packet loss due to equipment failures.”<sup>9</sup>

FRER emphasizes improvement in loss, rather than latency. FRER is built upon earlier TSN standards and groups and, accordingly, presumes that frames are parts of a stream carried along a provisioned reservation. As a result, the latency of the reservation may be determined and presumed bounded; the bounds, however, depend on the reliability of the network along the reserved path. FRER can, in effect, provide instantaneous backup of each frame. This dramatically reduces the frame loss rate due to independent failure of identical equipment, roughly squaring it. For example, if each of two independent paths experiences a frame loss rate of  $\epsilon$ , FRER would be expected to result in a frame loss rate of  $\epsilon^2$ . The difference may be highly significant in practice.

FRER is specified to apply only to frames carried in TSN streams. Not all streams in a network need to be subject to FRER; it can be limited to mission-critical streams only.

The concept of frame duplication and duplicate elimination preceded TSN discussions toward IEEE Std 802.1CB. In fact, the concept was standardized as early as 2010 in IEC 62439-3:2010, “Parallel Redundancy Protocol (PRP) and High-availability Seamless Redundancy (HSR).” The standard supports the use of Ethernet in industrial applications. While HSR and PRP do not support the flexibility to sequence frames per stream that IEEE Std 802.1CB provides, they are both capable of transmitting TSN streams. A number of industrial applications of PRP have followed.

The use of PRP wireless networks is not excluded and has been explicitly studied. This case is similar in principle but may be qualitatively different because the wireless link may be far more variable than the typical industrial wire link. As a result, a frame may be delayed significantly and unpredictably on a link without equipment failure. One implication is that, in the wireless environment, PRP may be more prominently used for jitter reduction rather than simply for frame loss.

Rentschler and Laukemann presented a study at the 2012 IEEE 17th International Conference on Emerging Technologies & Factory Automation (ETFA 2012) regarding redundancy and wireless LAN (WLAN) [24]. Industrial applications were a key target. The study noted that “wireless transmission is known to be error-prone and its error characteristics behave time-variable and non-deterministic. This labels wireless communication as not very well suited for industrial applications with tight reliability requirements, such as guaranteed maximum latency times for packet transmission.” The authors indicate that they consider “reliability, latency and jitter... as the most important criteria for industrial communication systems.”

Rentschler and Laukemann applied the standardized IEC PRP protocol to two parallel wireless LANs (WLANs) based on IEEE Std 802.11n; one of the two WLANs operated in the presence of interfering WLAN traffic. Regarding latency, the paper demonstrated that the minimum latency is attained without PRP, because the PRP processing adds delay. However, the maximum latency is attained with PRP, because PRP chooses the frame arriving first. PRP improved jitter (average deviation of the mean latency) by about 40% in one example. The paper reported examples in which frame loss

---

<sup>9</sup>IEEE Std 802.1CB includes the following note: “The term *packet* is often used in this document in places where the reader of IEEE 802 standards would expect the term *frame*. Where the standard specifically refers to the use of IEEE 802 services, the term *frame* is used. Where the standard refers to more generalized instances of connectionless services, the term *packet* is used.”

was around 0.02% per individual WLAN, but in which frame errors were not observed using PRP due to the unlikelihood of simultaneous loss of both packets.

The Rentschler and Laukemann study does not address the resource requirements necessary to implement PRP. In the wired case, whether PRP or FRER, the additional bandwidth resources to support redundancy may be supported by a cable and some switch ports. However, in the wireless case, the primary resource is a radio channel. As noted, one of the two available wireless channels in the Rentschler and Laukemann experiment was dedicated solely to the link. However, as discussed throughout this report, spectrum resources are limited in the factory environment. Each duplicated frame consumes twice the spectral resource of a single frame. If interference and channel availability are limiting factors, transmitting each packet in duplicate seems likely to be counter-productive. However, in some circumstances, such as for low-bandwidth mission-critical control messaging, duplicate wireless transmission might prove effective.

Another issue that needs to be considered regarding the application of PRP or FRER duplication in the wireless setting is the degree to which the pair of wireless channels is independent. For many realistic scenarios, such independence is a reasonable assumption in many wired networks. In the wireless case, the LAN elements may be physically separate, but the wireless environments may nevertheless be correlated. Operating the two links in different radio channels, or better yet different radio bands, can help to separate the interference conditions. However, even then, it is easy to imagine scenarios that would result in simultaneous degeneration of both links. One example might be a broadband noise source that affects both channels. Another example is that of large moving machinery, such as a moving truck discussed earlier in this report, which blocks the direct line-of-sight of two antennas.

A number of wireless industrial applications of PRP have been introduced in the market, primarily regarding WLAN. However, no wireless applications of IEEE Std 802.1CB have been identified. Perhaps the best explanation is that IEEE 802.1 TSN is rarely implemented in wireless networks and wireless traffic is rarely carried in TSN stream reservations, and therefore IEEE 802.1CB FRER is inapplicable. Should IEEE 802.1 TSN functionality, including TSN streams, become introduced into wireless networks, techniques such as FRER could be considered.

Concepts like FRER may find application in contributing to improved reliability and jitter in wireless factory networks. However, some of the challenges discussed will first need to be addressed and resolved.

### **Adaptation to rapid changes in wireless environments**

Modern manufacturing process requires fast feedback to get immediate response after each action by worker in management and operation to increase high productivity and high quality of products, simultaneously, where human and machines tightly collaborate in high-mix and low-volume production. Permissible delay in feedback messages for most wireless applications in this sense is ranging from 20 ms to 10 s as shown in Figure 9. The lower boundary may be determined by human reaction time (Kosinski [25]). For example, in an application in which an online inspection occurs, an action by worker is checked by a system as to whether it is good or not. He/she receives go/no-go signal from the system indicating to whether to proceed to the next action or not. In the network accommodating factory, applications such as quality supervision, factory resource management, display, and some of equipment control and safety, permissible latencies within 100 ms or less for

communications between a terminal and a management system of the factory application are considered reasonable.

In a typical factory structure (or layout), there are many metallic objects that are moving in a closed space, resulting in unforeseeable fluctuation in RSSI due to rapid change in propagation condition. An example of measurement in a metal casting site showed RSSI changed by more than 20 dB within a short time ranging from tens of milliseconds to hundreds of milliseconds as shown earlier in Figure 4. The bandwidth might decrease by one-tenth in a case during RSSI dropped. Another example of measurement in a large machine assembly site indicted burst-loss occurred for the duration of several hundred milliseconds as shown in Figure 16.

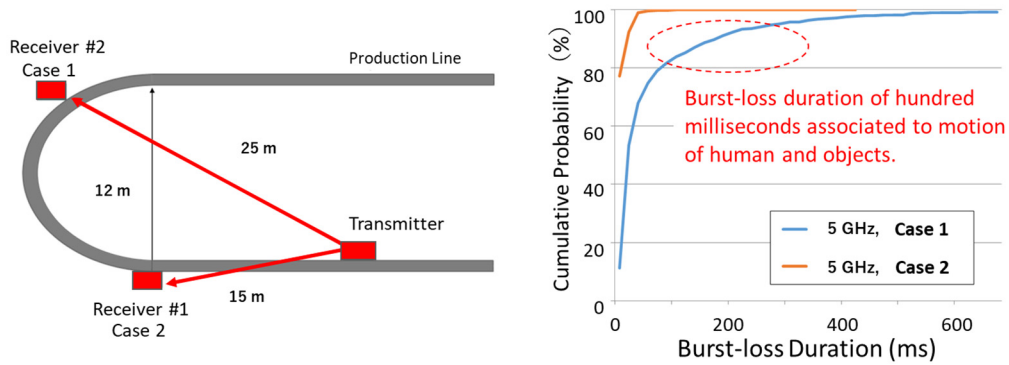

**Figure 16—Burst-loss measurement in a large machine assembly site [26]**

In order to help ensure transfer of information between terminals in a dynamically changing wireless environment within the allowed latency as required by factory applications, a fast and efficient queuing control and forwarding mechanism to multiple links is needed while maintaining required QoS for the application. For this purpose, we consider the applicability of the Priority-base Flow Control (PFC) protocol specified in the IEEE Std 802.1Q-2018, as shown in Figure 17.

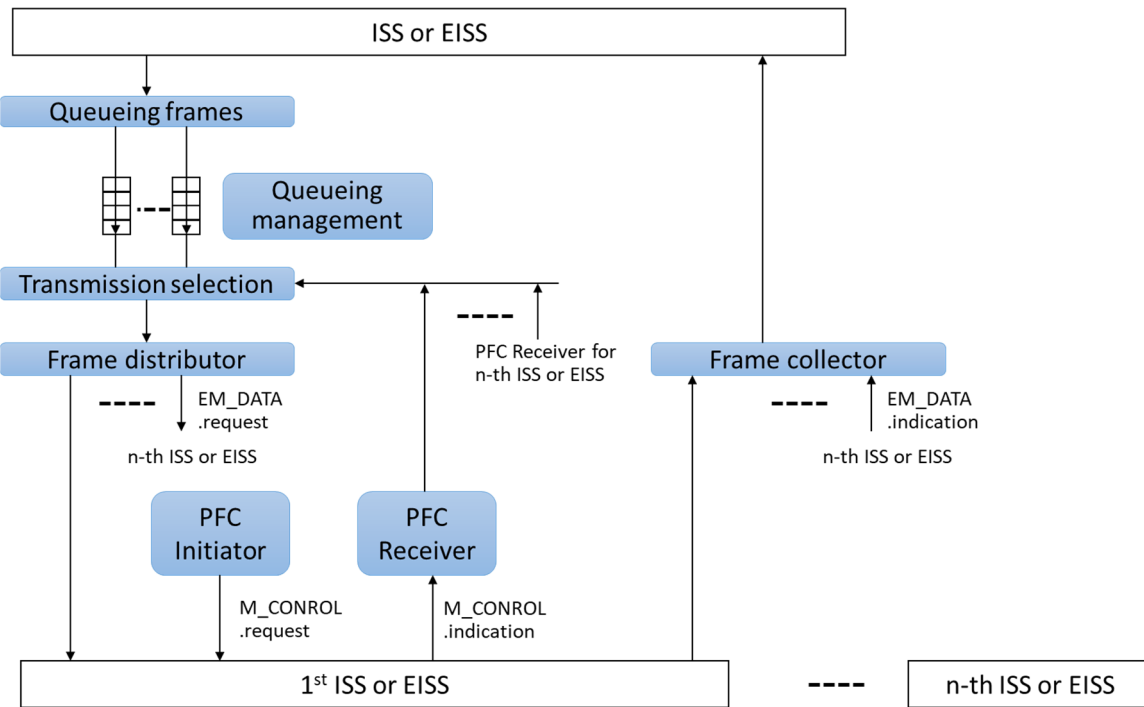

**Figure 17—PFC aware system queue functions with Link Aggregation  
(Rewritten Figure 36-4 in IEEE Std 802.1Q-2018)**

It should be noted that the application of PFC has been so far used in data center environment.<sup>10</sup> However, when used in a factory environment such as the one described previously, the performance and efficiency of the PFC protocols can be degraded significantly due to reduced available bandwidth between terminals. A real-time video streaming is a good example illustrating when the performance of the PFC function can be improved when operating in varying radio propagation conditions. Traffic for the video stream is allocated high priority in normal operation condition (i.e., traffic type for video has higher priority than traffic for critical applications according to Table I-2 in IEEE Std 802.1Q-2018 [22]). With varying RSSI, the available bandwidth between terminals is reduced. In real-time video streaming application, video quality can be adapted to available link bandwidth (along the end-to-end path) at the codec source. However, until this video adaptation is complete, while the bandwidth of the link is low and the video quality is degraded below its usable level, streaming is paused, although further packets are incoming to the queueing buffer that are not useable any more. This is the current operation of PFC because data loss is not allowed in a data center for which the PFC protocol was originally designed.

Since the video packets are no longer usable, pause operation and preserving the video packets is no longer valid during this transition period. During this period, the packets for streaming are discarded and critical traffic continues to be sent. A more efficient operation method is to discard the unusable video packets until useful video packets are sent again. This occurs when video adaptation to a lower quality matching the available bandwidth, or the link bandwidth is recovered naturally or by switching to a new link with sufficient bandwidth.

<sup>10</sup>Subclause 36.1.1 in IEEE Std 802.1Q-2018 reads “Operation of PFC is limited to a data center environment.”

If another ISS (or EISS) connection becomes available for the video stream application, data frame can then be forwarded dynamically at the bridge (Table 17).

**Table 17—Gaps between Current PFC (IEEE Std 802.1Q-2018) and Functions to be enhanced**

Current PFC (IEEE Std 802.1Q-2018)	Functions to be enhanced
Eight (max) links can be independently paused and restarted by queue control. Only no loss is acceptable for data center environment.	Not only “pause” but also “discard” are acceptable if QoS requirements of factory applications permit it.
There is no specific description about “frame distributor”.	Dynamic frame distributor mechanism is required to follow rapid changing bandwidth and to avoid burst losses for each ISS/EISS connected to a wireless media.
—	It is required to have negotiation function with a factory application for data rate reductions to determine if this reduction is acceptable to the application.

The issue here is to adapt to rapid changes in wireless environments while ensuring a variety of QoS requirements across the end-to-end connection of the whole network. Flow control at the bridge may be based on data attributes and flow control information coordinated over the network by a coordinator, as shown in in Figure 2.

#### Coordination among wireless systems in unlicensed bands

As for the factory IoT, wireless technologies that work in unlicensed bands are used in many cases because they have large cost advantage in network deployment. Normally, such unlicensed bands wireless technologies have MAC layer functionalities that enable coexistence with various wireless systems—CSMA/CA of Wi-Fi and frequency hopping of Bluetooth, for example. These functionalities make network deployment simple. However, stable quality of service is difficult to keep with such simple schemes especially when many wireless systems share the same wireless resources. It is because each wireless system, which consists of multiple wireless stations and is managed by a base station, works independently based on their own probabilistic approach without any coordination with the other wireless systems. In the factory IoT usage scenarios, many wireless systems work in a broad area, which is not separated completely in terms of wireless resource, and such competition of wireless systems in unlicensed bands is unavoidable.

To mitigate the impact of the competition in unlicensed bands, it is necessary to coordinate wireless systems in factory as much as possible. To assign channels of each wireless system according to required bandwidth of applications is a simple example of the coordination. Both distributed and centralized manner can be applied for the coordination. However, wireless systems need to be connected to the same wired network for exchanging control data. Wired network of the factory IoT needs to handle the control data for the wireless system coordination in addition to application data of each wireless systems. Figure 18 illustrates an overview of centralized type of coordinated wireless systems.

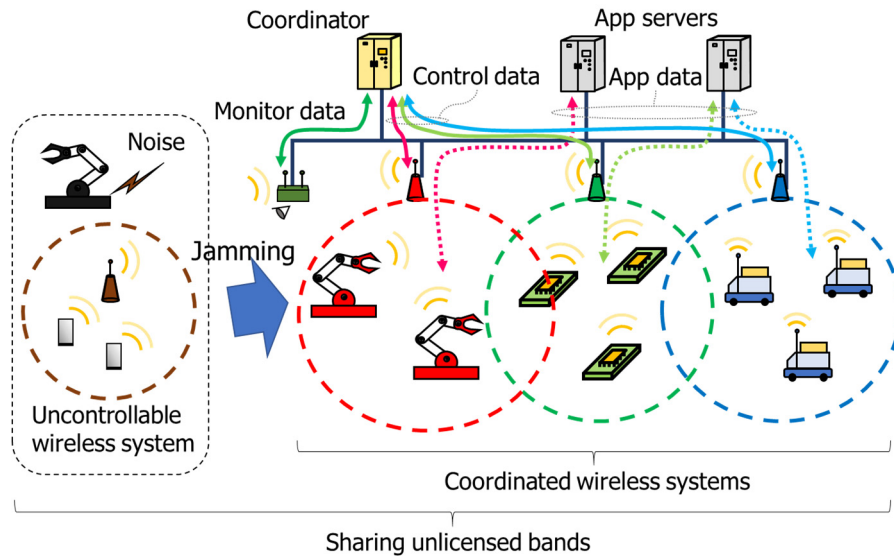

**Figure 18—Overview of coordinated wireless systems**

Ideally, all the wireless systems in an area should be connected to the same network and coordinated together. However, it is difficult to root out uncontrollable wireless systems in all the cases and noise from non-communication devices, such as machine tools, needs to be taken into consideration. It is necessary to monitor wireless channels, analyze behavior of such interferers, and estimate available wireless resources accurately for allocating wireless resources according to demands of applications. The wired network of the factory IoT needs to handle the monitoring data as well.

As latency of control data exchange and monitoring data exchange among wireless systems becomes lower, more efficient wireless system coordination becomes available. Improvement of latency of bridging is one of the issues for the efficient coordination of the wireless systems.

## Future directions towards enhancements for Flexible Factory network

### End-to-end network control and coordination

Within flexible factory scenarios, networks need to meet various traffic requirements and provide QoS at application level. There are different types of data flow between factory applications and network nodes, such as devices, access points, gateways, switches, bridges, and routers. To keep QoS across the factory network with prioritized control, data attributes are introduced at network nodes. Data attributes are defined based on characteristics of applications and its corresponding requirements. These attributes are attached to the data field and mapped to appropriate traffic types. Setting data attributes for factory applications rather than extending traffic types is essential for backward compatibility to existing standards.

Centralized control and coordination mechanism is required in order to ensure end-to-end QoS provisioning over the entire factory network, even in the brownfield where various facilities and equipment with different standards, of different generations, and by different vendors, coexist. The following control functions over the wired/wireless network are anticipated for coordination purpose:



1. Control of data flows across wireless links.
2. Joint coordination of frequency channel and forwarding paths.
3. Spatial control for wireless links, i.e., power and antenna directivity.

Coordination is achieved by a coordinator managing the factory network. As illustrated in Figure 19, the Bridge/AP of each sub-network is deployed for various applications. L2 data frames need to communicate between individual devices or towards the application server. The control policy could be provided by the coordinator for each sub-network for the ease of implementation, in cases where they should be provided on individual device basis by an application specific-policy template.

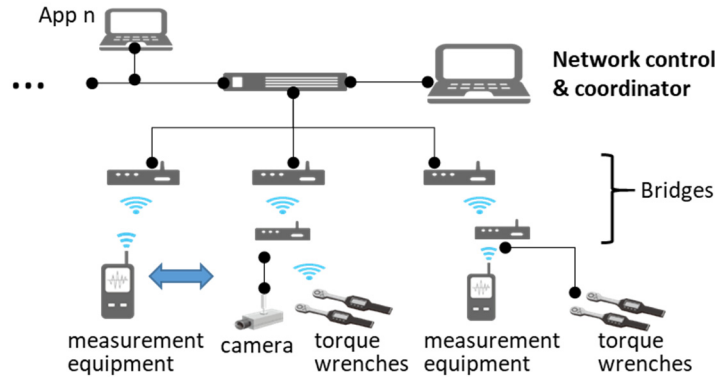

**Figure 19—Typical network scenario for flexible factory IoT**

Wireless link or path quality is changing rapidly (from milliseconds to seconds) due to multipath fading and shadowing in the closed environment of factories where human, product, and material handling equipment, e.g., forklift trucks and AGVs, are moving. It is required to reserve minimum bandwidth for priority application by enhancing bridge functions, despite the degradation in the local link quality. For the purpose of reliability, queuing and forwarding, mechanisms for redundancy need to be defined to use data attributes over the network. The coordinator can set policies for transmission of application data in a way that tolerates the degradation in the network due to the bandwidth changes. The control policies should be established to ensure the low priority bulk data transfer does not impact the transmission of the high- priority, critical messages and important data.

For coordination and control of a factory network made up of several tens of systems, a huge tightly-controlled network and computing resources would be required. Tight control directly conducted by the coordinator is impractical. This implies the necessity for hierarchical control consisting of (1) a centralized coordinator that implements the global control for coordination of independent systems to satisfy requirements of each factory applications, and (2) the distributed coordination agent on each individual Bridge/AP that serves as local control for each system according to control policy. The control policy implies how radio resources of time, frequency, and space are utilized to optimize operation of entire network in a factory.

To realize the hierarchical control, more information needs to be concentrated on the centralized controller enabling an autonomous operation and quick response. For this purpose, the following three items need to be considered for standardization:

- a) Control policy: messages and interfaces between a coordinator and various systems.
- b) Information on wireless environment: link/path quality.
- c) Data attributes: common information including various requirements, e.g., data rates (or data size at an application level and data frequency), latency, affordability of packet loss. The information is helpful for transportation of various traffics by better control of flows when mapping to traffic classes, scheduling, and forwarding.

### A unified network reference model

Network reference model (NRM) for flexible factory IoT network is a generic representation that includes multiple network interfaces, multiple network access technologies, and multiple applications. The NRM defined in IEEE Std 802.1CF [27] is appropriate for this purpose and can be used to generalize the concept of a centralized configuration paradigm and to explain how data attributes are managed as informative description as well. The minimum enhancement could be achieved by creating a factory profile consisting of the reference model and data attributes. Specification of new protocols is subject to further investigation.

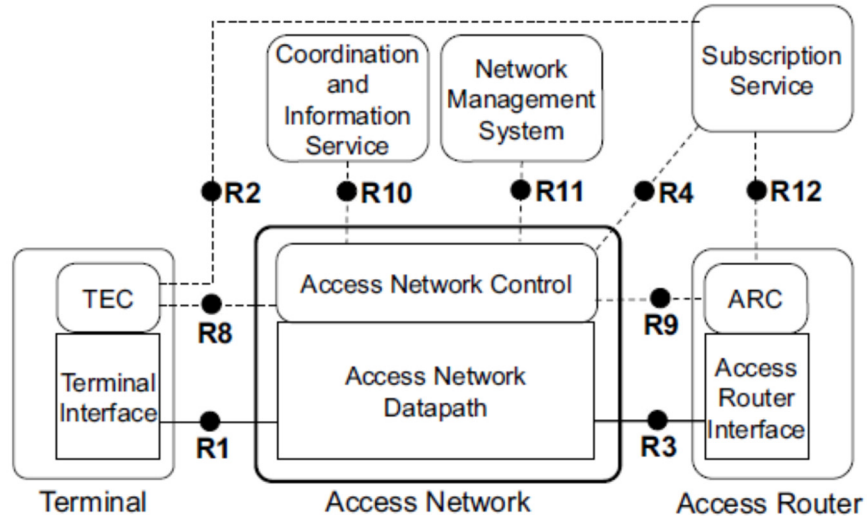

**Figure 20—Network reference model defined in IEEE Std 802.1CF**

The aforementioned network scenarios shown in Figure 20 can be mapped to IEEE Std 802.1CF NRM as depicted in Figure 21. Bridge/AP represents the node of attachment (NA) providing wired/wireless access through R1 to the terminals (devices). L2 data frames with common data attributes are aggregated and forwarded to the second level bridges, represented as backhaul (BH) through R6 datapath interface. The coordinator is located in the access network control (ANC) providing control policy to the underlay bridges and APs through R5 and R6 control interfaces.<sup>11</sup>

<sup>11</sup>Refer to Clause 5 of the IEEE Std 802.1CF [27] for detailed information of network reference model (NRM).

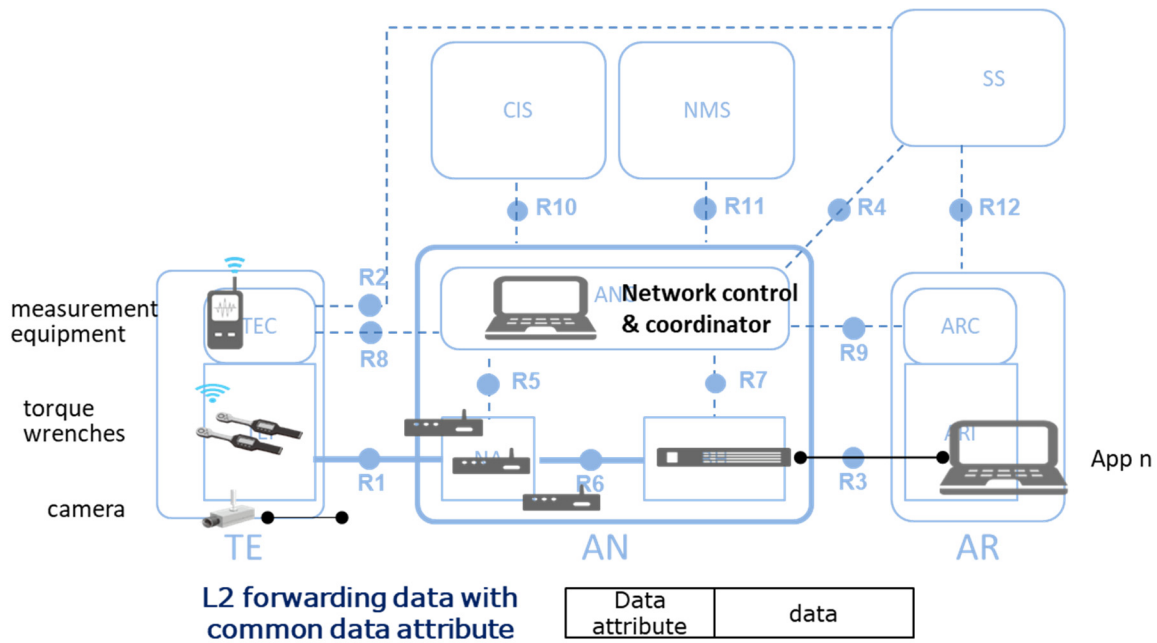

**Figure 21—Mapping factory network to IEEE 802.1CF NRM**

The centralized coordinator fits well in the role of ANC providing enhancements to IEEE 802.1 protocols and procedures, e.g., SRP, for time-sensitive applications. More complex TSN use cases benefit from the complete knowledge of streams in the network, especially for the ones going through wireless mediums, which are stored and processed by the coordinator.

In the case that performance requirements cannot be guaranteed as promised due to e.g., bandwidth fluctuation, the coordinator may respond quickly based on its knowledge of the global network resources and adjust parameter settings among all bridges/APs. Based on control policy, network resources could be adaptively assigned with the goal of maintaining stable streams. It ensures that the end-to-end QoS provided by the factory network meet the different requirements from the wide variety of factory applications.

Further to the aforementioned considerations, when wireless is used in factory networks and systems, some TSN features may be required to perform seamlessly as they would over the wired portion of the network. This implies additional challenges that need further consideration, such as the impact on latency and reliability of the wireless links at Layer 1/2.

The radio environment in the factory also poses additional challenges. NIST “Guide to Industrial Wireless Systems Deployments” [17] gives good guidance on planning and deploying wireless systems within the factory environment. Characterization of radio channels in factory environments may additionally help, if available, with such planning and deployment.

# 6 CONCLUSIONS

Communication in factories has until now been mainly wired communication. There are increasing expectations for the use of wireless connectivity among machines in the manufacturing and factory processes. Future industrial factory networks are expected to use more wireless to reduce the installation cost as well as to enhance flexibility. As such, the factory network needs to support the successful operation of various wireless applications.

This report addresses integrated wired and wireless IoT communications in the factory environment, and includes use cases and requirements with a focus on bridged Layer 2 networks. It presents problems and challenges observed within the factory and reports on possible solutions for overcoming some of these issues in order to enable flexibility within factories.

One distinct aspect of factory networks is that the physical devices connecting to the network are used to control and monitor real-world actions and conditions. This requires the provisioning of QoS for a variety of traffic types that may be characterized as either periodic or sporadic. In a flexible factory, humans are engaged in the control and monitoring system and therefore need to be interconnected with the network in order to interact with physical devices and machinery.

When the factory network is extended over radio, some incompatibility in QoS provisioning between wired and wireless segments becomes apparent due to unpredictable variations in the available bandwidth over the radio segment. In order to overcome the variable environment for wireless communications, coordination among network elements is required.

The report considers communication requirements for six categories of wireless applications, which are classified according to their purpose.

For factory applications, QoS latency tolerance is classified into small, medium, or large. Bandwidth tolerance is classified into wide, medium, or narrow, and the tolerance for packet loss is classified into loss intolerant or loss-tolerant. This implies that factory applications may be represented by not only traffic classes but also additional information related to QoS requirements, which include traffic flows identification and specifications. To deal with a large number of QoS class requirements, defining usage of tag fields may be needed for precise and fine QoS control over L2. Any priority tag must be understood in both wired and wireless networks, which may require tag translation among the two.

Future industrial wireless communications will take advantage of TSN functions and features specified in IEEE Std 802.1. The wired/wireless integrated networks for future flexible factories IoT scenarios should be able to accommodate various applications with different end-to-end QoS requirements. These requirements can be met by closing the gaps within the following functions:

- End-to-end stream reservation in a wired/wireless integrated network
- Wireless link redundancy for reliability and jitter improvement
- Adaptation to rapid changes in wireless environments
- Coordination among the wireless transmissions in the unlicensed bands

Coordination mechanism is required in order to ensure end-to-end QoS provisioning over the entire factory network. The following control functions over the wired/wireless network are anticipated for coordination purpose:

- Control of data flows across wireless links.
- Joint coordination of frequency channel and forwarding paths.
- Spatial control for wireless links, i.e., power and antenna directivity.

For the purpose of reliability, queueing and forwarding, mechanisms for redundancy need to make use of data attributes over the network. The coordinator can set policies for transmission of application data in a way that tolerates the degradation in the network due to the bandwidth changes that can occur over the wireless links.

A hierarchical control system consists of a centralized coordinator and distributed coordination agent on each individual Bridge/AP. For the purpose of satisfying requirements of each factory applications, the following considerations need to be standardized:

- Control policy: Messages and interfaces between a coordinator and various systems.
- Information on wireless environment: Link/path quality.
- Data attributes: Common information including various requirements, e.g., data rates (or data size at an application level and data frequency), latency, affordability of packet loss.

When wireless is used in factory networks and systems, some TSN features may be required to perform seamlessly as they would over the wired portion of the network. This implies additional challenges that need further consideration, such as the impact on latency and reliability of the wireless links at Layer 1/2.

The radio environment in the factory also poses additional challenges. Characterization of radio channels in factory environments may additionally help, if available, with such planning and deployment.

## CITATIONS

- [1] Nalin, Michela, “Industrial Ethernet is now bigger than fieldbuses,” February 2018. <https://www.hms-networks.com/news-and-insights/2018/02/27/industrial-ethernet-is-now-bigger-than-fieldbuses>.
- [2] “Summary of results, Questionnaire survey regarding production equipment holding period, etc., (in Japanese),” May 2013, Ministry of Economy, Trade and Industry, Industrial Machinery Division, <http://warp.da.ndl.go.jp/info:ndljp/pid/10383604/www.meti.go.jp/press/2013/05/20130531001/20130531001-2.pdf>.
- [3] “AI standards help accelerate digitalization of smart manufacturing,” June 2019, IEC, <https://www.iecotech.org/Technical-Committees/2019-06/AI-standards-help-accelerate-digitalization-of-smart-manufacturing>.

- [4] IEC 61748-1, Industrial communication networks—Profiles Part 1: Fieldbus profiles, Part 1,” April 2019, TC 65/SC 65C—Industrial networks.
- [5] IEC 61748-2: Industrial communication networks—Profiles—Part 2: Additional fieldbus profiles for real-time networks based on ISO/IEC/IEEE 8802-3,” April 2019, TC 65/SC 65C—Industrial networks.
- [6] IEC 61158: Industrial communication networks—Fieldbus specifications, Part 1, 2, 3-1, 3-2, 3-3 and 3-4),” July 2014, IEC TC 65/SC 65C—Industrial networks.
- [7] IEEE 802.1 Time-Sensitive Networking (TSN) Task Group webpage, <https://1.ieee802.org/tsn/>.
- [8] Flexible Factory Partner Alliance Webpage, <https://www.ffp-a.org/tech/index.html>.
- [9] IEC 62657-1:2017, Industrial communication networks—Wireless communication networks—Part 1: Wireless communication requirements and spectrum considerations, June 2017, IEC TC 65/SC 65C—Industrial networks.
- [10] IEC 62657-2, Industrial communication networks—Wireless communication networks—Part 2: Coexistence management, May 2017, IEC TC 65/SC 65C—Industrial networks.
- [11] IEC 62657-4 ED1, Industrial communication networks—Wireless communication networks—Part 4: Coexistence management with central coordination of wireless applications, Draft version 65C/916/CD, July 2018, IEC TC 65/SC 65C—Industrial networks.
- [12] IEC 62443 Series, Industrial communication networks—Network and system security
- [13] Guidance for Practice Regarding “IoT Safety/Security Development Guidelines,” Information-technology Promotion Agency (IPA), <https://www.ipa.go.jp/files/000063228.pdf>.
- [14] Flexible Factory Security Guidelines, Flexible Factory Partner Alliance, [https://www.ffp-a.org/document/files/190920\\_FFSG\\_p.pdf](https://www.ffp-a.org/document/files/190920_FFSG_p.pdf).
- [15] Mark Hantel; Steindl, Günter; Woods, Jordon; and Don Pannell, “New Ethernet Applications –Industrial Networking Requirements,” March 2018, [http://www.ieee802.org/3/ad\\_hoc/ngrates/public/18\\_03/woods\\_nea\\_01\\_0318.pdf](http://www.ieee802.org/3/ad_hoc/ngrates/public/18_03/woods_nea_01_0318.pdf).
- [16] IEC 62657-3 ED1, Industrial communication networks—Wireless communication networks—Part 3: automated coexistence management and application guidance, Draft version 65C/916/CD, December 2019, IEC TC 65/SC 65C—Industrial networks.
- [17] Candell, Richard; Hany, Mohamed T.; Lee, Kang B.; Liu, Yongkang; Quimby, Jeanne T.; and Remley, Catherine A., “Guide to Industrial Wireless Systems Deployments,” May 2018, <https://www.nist.gov/publications/guide-industrial-wireless-systems-deployments>.
- [18] Flexible Factory Project, “Wireless use cases and communication requirements in factories (abridged edition),” Version 1.0, February 2018, NICT. <https://www2.nict.go.jp/wireless/en/ffpj-wp.html>.
- [19] Vetti, Svein; Olsson, Jonas; and Copley, Jeanna, “Sub-1 GHz long-range communication and smartphone connection for IoT applications,” September 2016, Texas Instruments, <http://www.ti.com/lit/wp/swry026/swry026.pdf>.

- [20] Low Power Radio Solution, “Sub-1GHz Radio The Best Solution for the Internet of Things?” <http://www.lprs.co.uk/about-us/news-and-events/rf-articles/sub1ghz-radio-solution-for-iot.html>.
- [21] NICT Press Release, “Verification Project of Wireless Communication Technologies to Accelerate Factory IoT,” March 2017. <https://www.nict.go.jp/en/press/2017/03/01-1.html>.
- [22] IEEE Std 802.1Q-2018 (Revision of IEEE Std 802.1Q-2011), IEEE Standard for Local and metropolitan area networks—Bridges and Bridged Networks, July 2019, <https://ieeexplore.ieee.org/document/8686439/>.
- [23] IEC SC 65C, Industrial Networks Group webpage, [https://www.iec.ch/dyn/www/f?p=103:29:19336108265271:::FSP\\_ORG\\_ID,FSP\\_LANG\\_ID:1376,25#1](https://www.iec.ch/dyn/www/f?p=103:29:19336108265271:::FSP_ORG_ID,FSP_LANG_ID:1376,25#1).
- [24] Rentschler, Markus and Laukemann, Per, “Performance Analysis of Parallel Redundant WLAN,” 17-21 Sept. 2012, ETFA 2012, sponsored by IEEE Industrial Electronics Society.
- [25] Kosinkski, Robert J., “A Literature Review on Reaction Time,” September 2013, Clemson University, <http://www.cognaction.org/cogs105/readings/clemson.rt.pdf>.
- [26] Maruhashi, Kenichi, et. al., “Wired/Wireless Convergence for Factory IoT,” November 2017, <https://mentor.ieee.org/802.1/dcn/17/1-17-0011-02-ICne-wired-wireless-convergence-for-factory-iot.pdf>.
- [27] IEEE Std 802.1CF-2019, IEEE Recommended Practice for Network Reference Model and Functional Description of IEEE 802<sup>®</sup> Access Network, May 2019, <https://ieeexplore.ieee.org/document/8726453>.

# RAISING THE WORLD'S STANDARDS

---



3 Park Avenue, New York, NY 10016-5997 USA [standards.ieee.org](http://standards.ieee.org)

Tel.+1732-981-0060 Fax+1732-562-1571