

**IEEE-SA Industry Connections Report**

**[Wired/Wireless Use Cases and  
Communication Requirements for  
Flexible Factories IoT Bridged  
Network]**

DRAFT



IEEE | 3 Park Avenue | New York, NY 10016-5997 | USA

---

*Copyright © 20xx IEEE. All rights reserved.*

# Wired/Wireless Use Cases and Communication Requirements for Flexible Factories IoT Bridged Network

---

Author [TBD]  
and any other important  
authoring details



## Trademarks and Disclaimers

*IEEE believes the information in this publication is accurate as of its publication date; such information is subject to change without notice. IEEE is not responsible for any inadvertent errors.*

---

*The Institute of Electrical and Electronics Engineers, Inc.  
3 Park Avenue, New York, NY 10016-5997, USA*

*Copyright © 20xx by The Institute of Electrical and Electronics Engineers, Inc.  
All rights reserved. Published Month 20xx. Printed in the United States of America.*

*IEEE is a registered trademark in the U. S. Patent & Trademark Office, owned by The Institute of Electrical and Electronics Engineers, Incorporated.*

PDF: ISBN 978-0-7381-xxxx-x STDVxxxxx  
Print: ISBN 978-0-7381-xxxx-x STDPDVxxxxx

*IEEE prohibits discrimination, harassment, and bullying. For more information, visit  
<http://www.ieee.org/web/aboutus/whatis/policies/p9-26.html>*

*No part of this publication may be reproduced in any form, in an electronic retrieval system, or otherwise, without the prior written permission of the publisher.*

*To order IEEE Press Publications, call 1-800-678-IEEE.  
Find IEEE standards and standards-related product listings at: <http://standards.ieee.org>*

## **Notice and Disclaimer of Liability Concerning the Use of IEEE-SA Industry Connections Documents**

*This IEEE Standards Association (“IEEE-SA”) Industry Connections publication (“Work”) is not a consensus standard document. Specifically, this document is NOT AN IEEE STANDARD. Information contained in this Work has been created by, or obtained from, sources believed to be reliable, and reviewed by members of the IEEE-SA Industry Connections activity that produced this Work. IEEE and the IEEE-SA Industry Connections activity members expressly disclaim all warranties (express, implied, and statutory) related to this Work, including, but not limited to, the warranties of: merchantability; fitness for a particular purpose; non-infringement; quality, accuracy, effectiveness, currency, or completeness of the Work or content within the Work. In addition, IEEE and the IEEE-SA Industry Connections activity members disclaim any and all conditions relating to: results; and workmanlike effort. This IEEE-SA Industry Connections document is supplied “AS IS” and “WITH ALL FAULTS.”*

*Although the IEEE-SA Industry Connections activity members who have created this Work believe that the information and guidance given in this Work serve as an enhancement to users, all persons must rely upon their own skill and judgment when making use of it. IN NO EVENT SHALL IEEE OR IEEE-SA INDUSTRY CONNECTIONS ACTIVITY MEMBERS BE LIABLE FOR ANY ERRORS OR OMISSIONS OR DIRECT, INDIRECT, INCIDENTAL, SPECIAL, EXEMPLARY, OR CONSEQUENTIAL DAMAGES (INCLUDING, BUT NOT LIMITED TO: PROCUREMENT OF SUBSTITUTE GOODS OR SERVICES; LOSS OF USE, DATA, OR PROFITS; OR BUSINESS INTERRUPTION) HOWEVER CAUSED AND ON ANY THEORY OF LIABILITY, WHETHER IN CONTRACT, STRICT LIABILITY, OR TORT (INCLUDING NEGLIGENCE OR OTHERWISE) ARISING IN ANY WAY OUT OF THE USE OF THIS WORK, EVEN IF ADVISED OF THE POSSIBILITY OF SUCH DAMAGE AND REGARDLESS OF WHETHER SUCH DAMAGE WAS FORESEEABLE.*

*Further, information contained in this Work may be protected by intellectual property rights held by third parties or organizations, and the use of this information may require the user to negotiate with any such rights holders in order to legally acquire the rights to do so, and such rights holders may refuse to grant such rights. Attention is also called to the possibility that implementation of any or all of this Work may require use of subject matter covered by patent rights. By publication of this Work, no position is taken by the IEEE with respect to the existence or validity of any patent rights in connection therewith. The IEEE is not responsible for identifying patent rights for which a license may be required, or for conducting inquiries into the legal validity or scope of patents claims. Users are expressly advised that determination of the validity of any patent rights, and the risk of infringement of such rights, is entirely their own responsibility. No commitment to grant licenses under patent rights on a reasonable or non-discriminatory basis has been sought or received from any rights holder. The policies and procedures under which this document was created can be viewed at <http://standards.ieee.org/about/sasb/iccom/>.*

*This Work is published with the understanding that IEEE and the IEEE-SA Industry Connections activity members are supplying information through this Work, not attempting to render engineering or other professional services. If such services are required, the assistance of an appropriate professional should be sought. IEEE is not responsible for the statements and opinions advanced in this Work.*

**CONTENTS**

**INTRODUCTION ..... 1**  
Scope.....2  
Purpose .....2

**DEFINITIONS ..... 2**

**FACTORY OVERVIEW AND OPERATION ENVIRONMENT ..... 3**  
Factory communication network environment .....3  
Radio Environment within Factories .....4  
    (a) The Severe Environment for Wireless Communications.....5  
    (b) Uncoordinated and Independent Systems .....7

**WIRELESS APPLICATIONS AND COMMUNICATION REQUIREMENTS ..... 9**  
Scope of wireless applications in factory.....9  
Wireless applications.....9  
Communication requirements ..... 10  
Details of wireless application and communication requirements ..... 12

**FACTORY USAGE SCENARIOS..... 18**  
Usage scenarios example: Metal processing site ..... 18  
Usage scenarios example: Mechanical assembly site ..... 20  
Usage scenarios example: Elevated and high temperature work site.... 21  
Usage scenarios example: Logistics warehouse site ..... 22

**TECHNOLOGICAL ENHANCEMENT OF NETWORKING FOR FLEXIBLE  
FACTORY IOT ..... 24**  
Concept of architecture ..... 24  
Gaps in existing IEEE 802 technologies ..... 24

**CONCLUSIONS ..... 26**

**CITATIONS ..... 26**

DRAFT

# Wired/Wireless Use Cases and Communication Requirements for Flexible Factories IoT Bridged Network

## Introduction

Communication used in factories has until now been mainly wired communication, which has been preferred for its reliability. However, in recent years the shorter times of product development cycles demands greater flexibility in the layout of machines and sequence of processes, and there are increasing expectations for the use of radio links amongst of the sensors and machines used in the manufacturing and factory processes.

When considering the network evolution within factories, consideration should take into account legacy manufacturing machine that are in service for many decades.

Within factory installations, for the purpose of monitoring operations and preventive maintenance sensors are be attached to machines. According to the survey by Japan's Ministry of Economy, Trade and Industry , lifetime of production machines is generally long and about 10.9% of them have been used for more than 30 years as shown in [Figure 1](#). There may be many old machines, with sensors attached after installation.

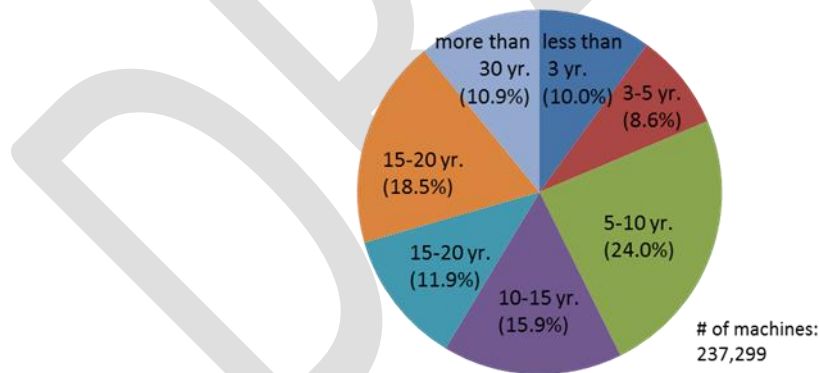

Figure 1 Share of production machines by age<sup>1</sup>

This report is developed under the IEEE 802 Network Enhancements for Next Decade Industry Connections Activity (NEND-ICA). It addresses the **integration and bridged** wired and wireless IoT communications in the factory environment considering its foreseen evolution that include dense radio devices utilization. The report includes use cases and requirements within the factory wireless environment. It presents problems and challenges observed within the factory

<sup>1</sup> [http://www.soumu.go.jp/main\\_content/000469037.pdf](http://www.soumu.go.jp/main_content/000469037.pdf)



and reports on feasibility of some possible solutions for overcoming these issues. Areas that may benefit from standardization are highlighted.

The report then presents an underlying End to End network architecture which encompasses the operation and control of the various services in the factory network according to their dynamic QoS requirements. It analyses the applicable standards and features in wired and wireless IEEE 802 technologies to achieve the requirements in End-to-End (E2E) network connectivity for integrated wired and wireless connectivity in factory environment.

## Scope

The scope of this report is to capture current and future network requirements taking into consideration dense use of radio devices and its operation in factory environment. The report presents analysis of issues and challenges identified in maintaining reliable and time sensitive/constraint deliverable of control messages and data traffic across wired and wireless bridged network within the identified factory environment. Also to present analysis of applicable standards and features in wired and wireless IEEE802 technologies for managing requirements in E2E network connectivity.

There was a question about the use of “bridged” network. The use of bridges in the factory network is common since multiple LAN wired and wireless with different segments which are generally bridged. Updated figure 1 that shows bridges used within the factory network

## Purpose

The purpose of this report is to present an overview of issues and challenges in managing a reliable and time sensitive connectivity in E2E wired and wireless network characterized by dense radio devices installation and noisy factory environment. The report will also present technical analyses of the desired features and functions in wired and wireless IEEE802 technologies for managing requirements in E2E network connectivity which can be used in an IEEE 802 standard solution based on time critical requirements for integrated wired and wireless connectivity within the factory environment.

## Definitions

## Factory Overview and Operation environment

### Factory communication network environment

Recent trends to introduce IoT devices, such as sensors and cameras in the factories are accelerated by strong demand for improving productivity under the constraints of reduced workers in aging population society and pressure for cost reduction. Digitalization of the factories as well as connection of information on production process and supply chain management within a factory and across factories becomes important. It is no doubt that commutation networks will be changing in factories for the next decade.

There are several system applications, e.g., preventive maintenance, management of materials and products, monitoring of movements and machine monitors which are integrated in the network. Future industrial network for a factory may consist of wired and wireless bridges for the aforementioned systems. The successful integration of wired and wireless systems is indispensable and more efforts will be required for wireless communication because of its limited and shared radio resources and the sensitive nature of the environment in which it will operate in. A [layered or hierarchal] network architecture is required in order to configure, coordinate radio technologies coexistence and manage the end to end flows and streams as illustrated in the following [Figure 2](#).

Need to insert here a figure for the factory multi layers network architecture taken from one of the presentations made earlier in IEEE802.1 illustration E2E flow management and coordination of radio technologies used within the factor. (done)

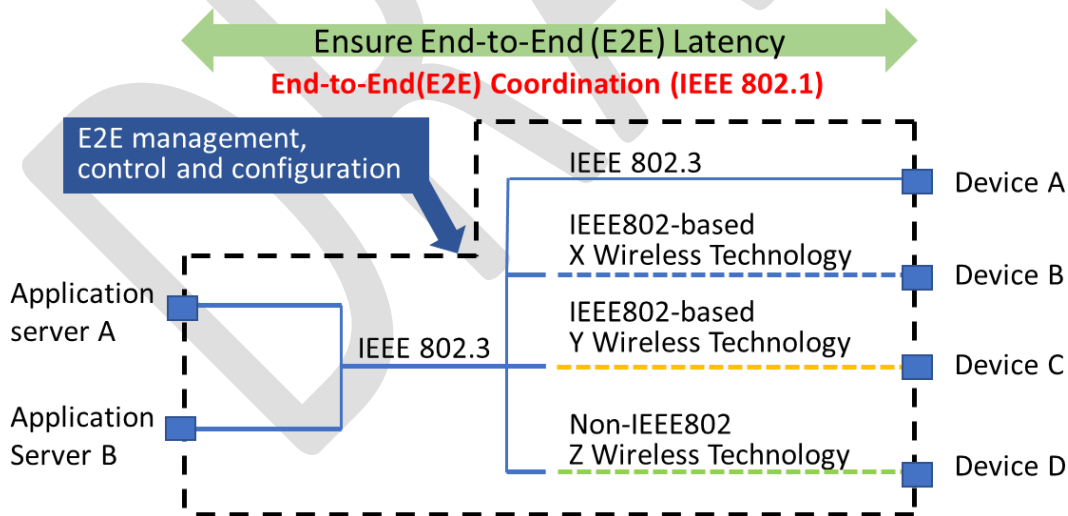

Figure 2 Example of Network Topology in Factory Environment

Replace in figure "application A/B" with "application server A/B".

End-to-End (E2E) network topology for a factory today is configured by combination of wired LAN, such as 802.3, IEEE802-based and non-IEEE802 wireless technologies.

In order for factory IoT system to work well, a higher layer End to End coordination system is needed to configure, manage, and control data frames/streams that are transported in a mix of different technologies with varying QoS performance and attributes.

Traditionally, wireless communications have not been popular in the manufacturing field. There are still many stand-alone machines managed manually by skilled workers. Advanced factories, on the other hand, have been using communication networks called fieldbus - a type of wireline network. One of the reasons wireless communications have not been used extensively in factories is because there are doubts about their stability and reliability. Technology developments as well as standardization are keys to success for wireless utilization. If these efforts are proven successful, wireless use for IoT connectivity in factory will increase resulting in more flexibility in the manufacturing process and improved productivity within the factory environment.

One of the main considerations within the factory network is the need for the provisioning of QoS for large number of M2M type of data generated from many sensors at the same time with different priority-classes. These data types are periodic in nature and have relatively short packet size.

When the factory network is extended over radio, some incompatibility in QoS provisioning between wired and wireless segments become apparent. The first is due to dynamic variations in the available bandwidth (capacity and throughput) over the radio segment as results of the non-deterministic noise/interference, distortions and fading. These dynamic variations cause congestion not just because overloading of the data streams but also because of the wireless link quality deterioration. Under such conditions, the existing IEEE 802 protocols may not function properly.

Therefore, for the successful factory automation with high degree of flexibility, dynamic management and control of end-to-end streams across mixed wired and wireless links required some kind of End-to-End coordination is necessary as illustrated in [Figure 2](#) above.

Impact of applying QoS and Time Synchronizations functions and protocols to heterogeneous factory network with mixed wired and wireless links in factory network is further analyzed in section "Factory End to End Network Architecture" with potential and possible solutions discussed. But first, details of the environment and cause of impairments and distortions to radio signals within the factory environment are presented next.

## Radio Environment within Factories

It is true that wireless communications are not always difficult everywhere in factories. However, we have to consider that some applications require high-reliable, low-latency and low-jitter data transmission compared with other application in other places like offices and homes in general. Furthermore, the measurement results have revealed that some factories are facing difficulties

coming from (a) severe environment for wireless communications, and/or (b) existence of uncoordinated and independent systems in the same space.

### (a) The Severe Environment for Wireless Communications

There are two source of impairment to radio signal within the factory environment that cause unpredictable variations to channel capacity, namely:

1. Fluctuation of signal strength
2. Noises

As follows are examples of such impairments observed within the factory environment.

#### Example of Fluctuation of signal Strength:

The layout of the environment for which measurements are made is shown in the [Figure 3](#) below. Master and slave transceivers were located in LOS condition and there was no blockage during measurement.

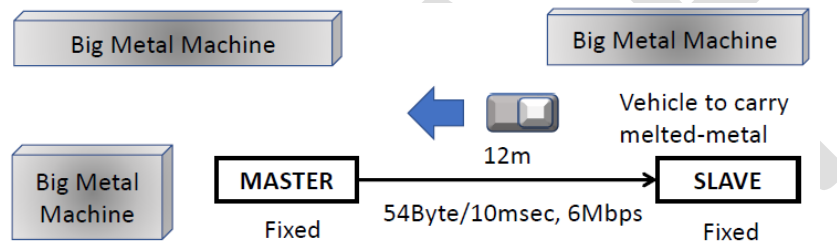

**Figure 3 Layout in factory for which measurement of RSSI is recorded**

The observed RSSI measurement in LOS condition is shown in [Figure 4](#) below.

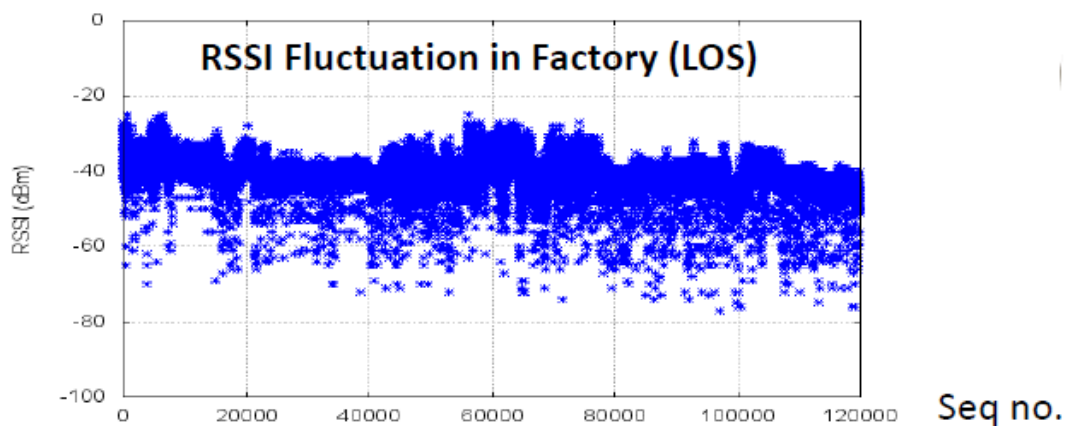
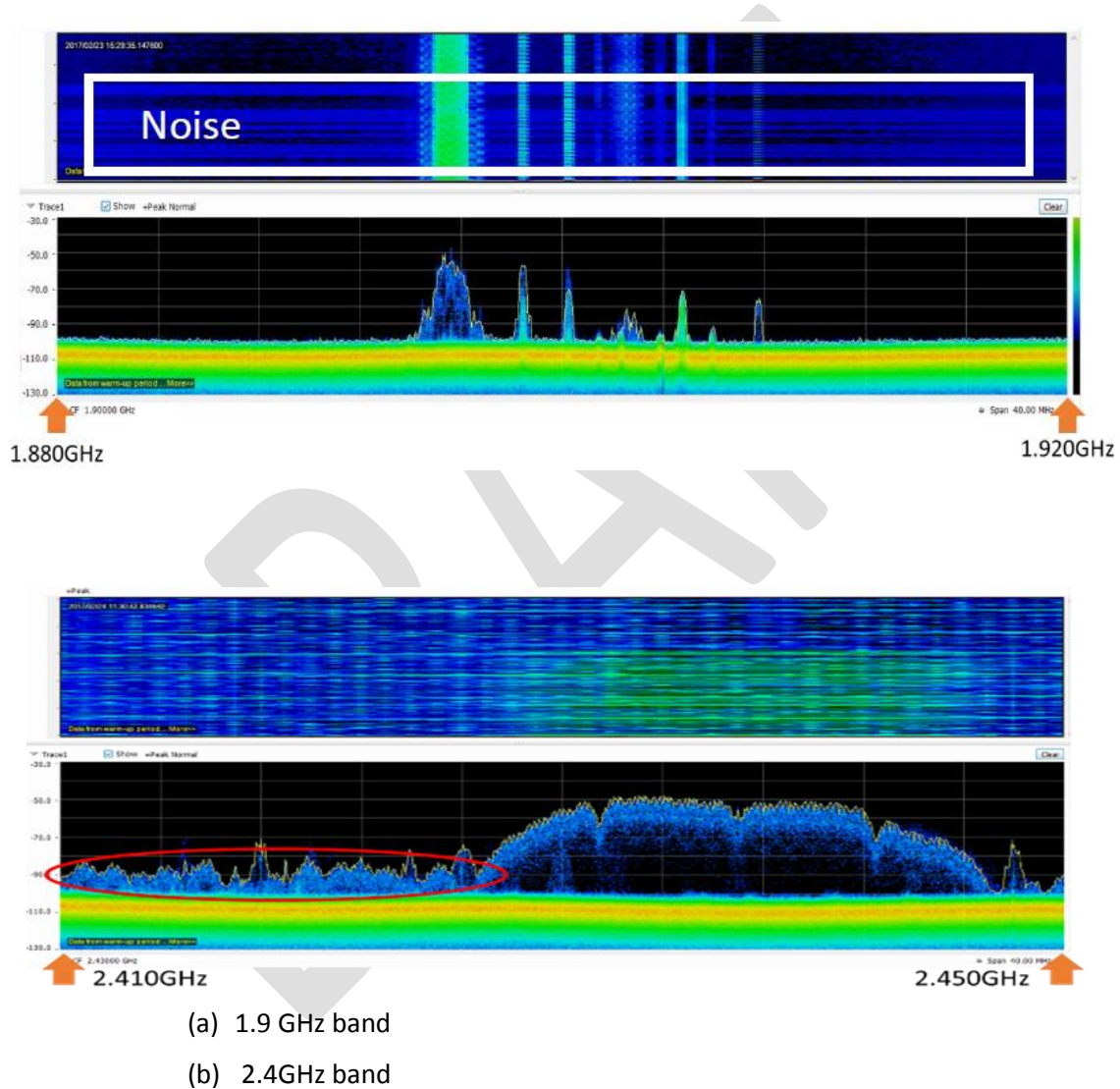

**Figure 4 RSSI Fluctuation in Factory (LOS)**

This fluctuation in RSSI is due to motions of materials, parts, products and carriers in closed space.

**Example of Noises:**

While carrying radio measurement within the factory environment strong noise signals were observed within the 1.9 GHz band and the 2.4 GHz band. These are shown in [Figure 5](#).



**Figure 5 Measured noise spectral density within (a) 1.9 GHz band and (b) 2.4 GHz band**

In the 1.9 GHz band, the noise appears to cause problems for the communication with particular machines as well as problem for using the 1.9GHz band for internal telephone system.

The source of these noises is attributed to some kinds of manufacturing machines that are causing interference for wireless communications.

### (b) Uncoordinated and Independent Systems

This issue within the factory environment is attributed to the progressive nature which leads to stepped approach of addition and installation of machines and equipment in the factory and due to coexistence of heterogeneous and legacy devices/systems used within the factory.

An example of using wireless technology in the factory is shown in [Figure 6](#).

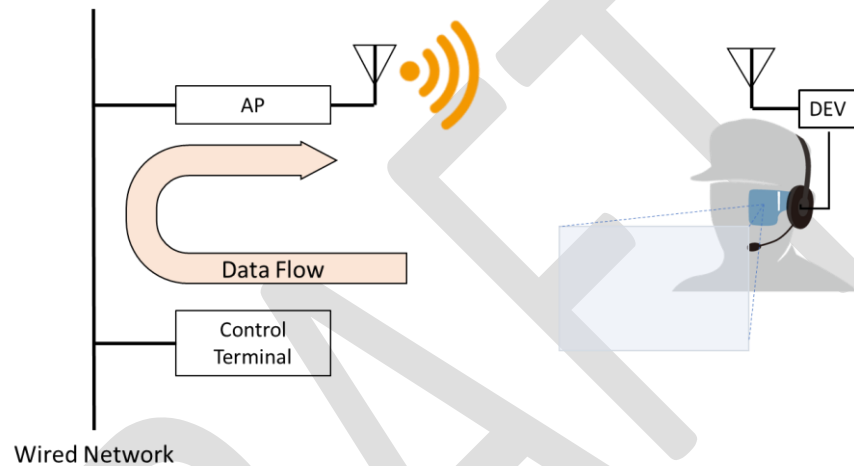

**Figure 6 video monitor application as an example of using wireless technology**

In this example it illustrates an application in which the data flow across the wired network and bridged across to the wireless domain. In this application there are QoS requirements and latency constraints for both the video signal and the control signal. Potential problem is a bottleneck for which delay or uncoordinated signal flow may occur due to disturbance and/or degradation in the radio signal.

When considering the coexistence of uncoordinated wireless systems, we observe the problem of interference between the legacy wireless communications used by some machinery in the factory with the new systems using Wi-Fi. The overlapping of signal causing potential interference is illustrated in [Figure 7](#).



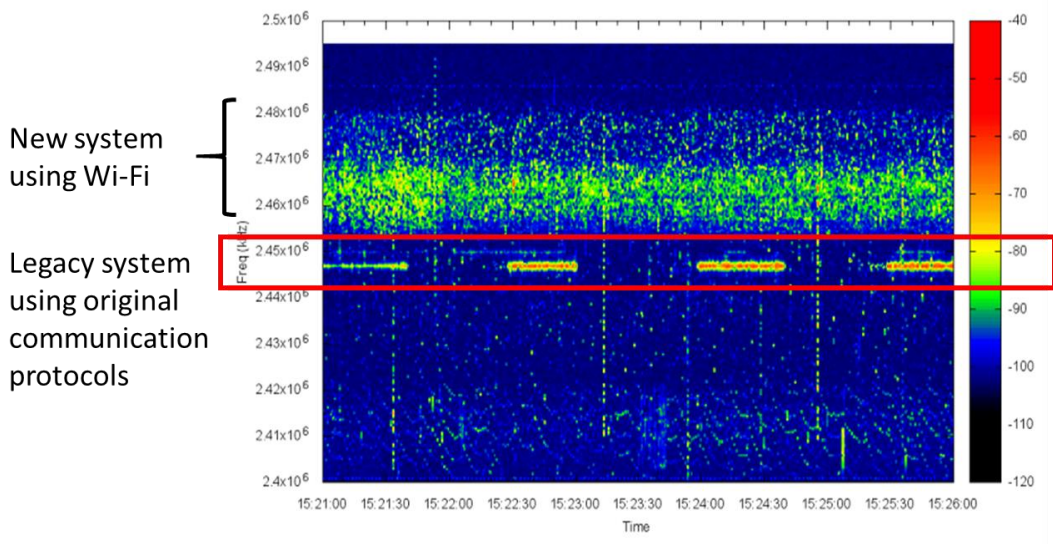

Figure 7 Coexistence of different wireless technologies

Some of the problems observe relates to the packet delivery delay. Figure 8 shows packet loss and packet delivery delay with different interference level. The packet latency increased from 8ms in case of no interference to around 2 second in the presence interference due to lack of coordination amongst the used wireless systems used in the factory.

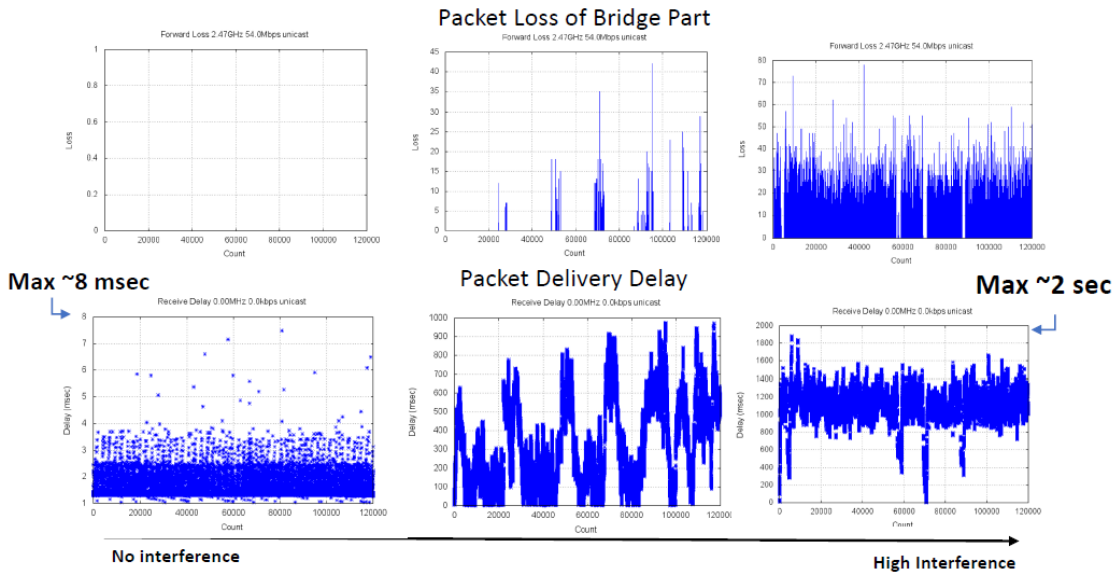

Figure 8 Impact of interference on latency in uncoordinated wireless systems

In this document, wireless applications and communication requirements are described the subsequent sections to understand what shall be improved and enhanced for successful integrated wired and wireless systems.

## Wireless applications and communication requirements

### Scope of wireless applications in factory

The wireless applications considered in this clause illustrate the use of wireless systems that are currently used –or will be used soon - in factories and factory related facilities. The applications correspond to wireless systems that are installed for specific purpose.

For example, wireless systems shown in [Figure 9](#), there are individual systems (within the dotted lines) introduced for specific purposes such as “Collecting Management Information”, and a wireless network consisting of multiple such wireless systems and transmitting information aggregated by them. In this case, each individual system corresponds to a wireless application and described in following sub sections, but not the whole wireless network. That is, each wireless segment is considered as a separate application.

Section “Factory Usage Scenario” considers actual factory sites with large needs for wireless communication and describes usage scenarios where multiple wireless applications coexist.

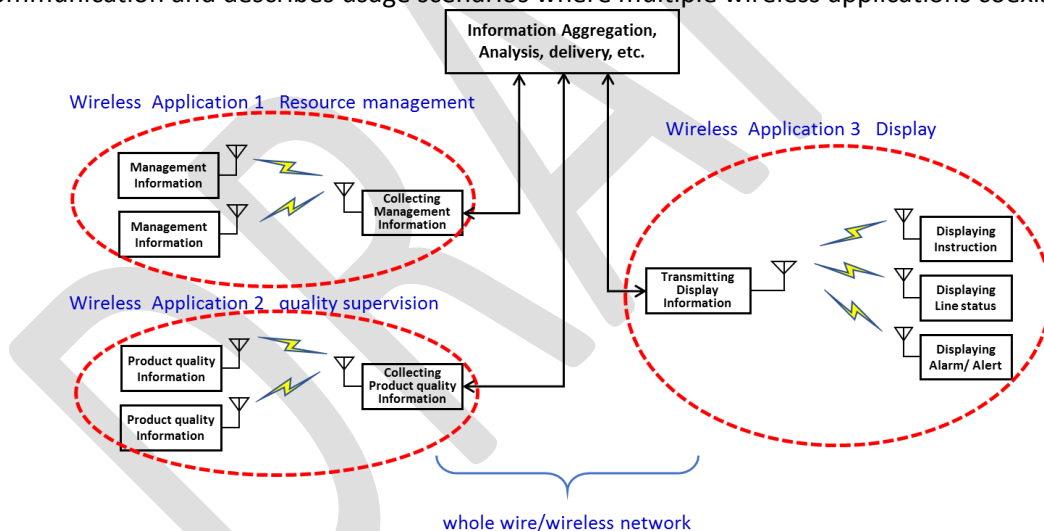

**Figure 9 Scope of wireless applications in factory**

### Wireless applications

In our usage survey of wireless communication in factories, we collected characteristics of various applications. We classified them according to their purposes, and organized their communication requirements. List of collected wireless applications are shown in Table 1. They were divided into six categories (equipment control, quality supervision, resource management, display, Human safety, and others) and then subdivided into thirteen classifications according to their corresponding purposes.



**Table 1 Wireless applications**

Category	Description	Classification according to the purpose
Equipment Control	sending commands to mobile vehicles, production equipment	(1) Controlling, operating and commanding of production equipment, auxiliary equipment
Quality Supervision	collecting information related to products and states of machines during production	(2) Checking that products are being produced with correct precision (3) Checking that production is proceeding with correct procedure and status
Factory Resource Management	collecting information about whether production is proceeding under proper environmental conditions, and whether personnel and things <sup>2</sup> contributing to productivity enhancement are being managed appropriately	(4) Checking that the production environment is being appropriately managed (5) Monitoring movement of people and things (6) Checking the management status of equipment and materials (stock) (7) Checking that the production equipment is being maintained (8) Appropriate recording of work and production status
Display	For workers, receiving necessary support information, for managers, monitoring the production process and production status	(9) Providing appropriate work support (10) Visually display whether the process is proceeding without congestion or delay (11) Visually display the production status
Human Safety	collecting information about dangers to workers	(12) Ensuring the safety of workers
Other	Communication infrastructure with non-specific purposes	(13) Cases other than the above

### Communication requirements

Figure 10 shows representative wireless applications and their features of wireless communication. Values of data size, data generation rate, number of wireless nodes, and so forth are different for different systems in factories, and according to the required functions of the systems. They use different wireless frequency bands and wireless standards. High frequency bands such as 60 GHz band are expected to be effective for systems with relatively large data volume requirements (image inspection equipment, etc.). 5 GHz band and 2.4 GHz band are being used for systems with medium requirements of data sizes and data generation rate, such as distributing control programs and control of mobile equipment. Relatively low

<sup>2</sup> Physical objects such as materials and equipment related to production are called “things”

wireless frequency bands such as 920 MHz band are being used for applications with low power requirements (such as environmental sensing).

Note from OmniRAN review (20180305)  
 Number of nodes per area.  
 Number of hops is critical in wired.  
 Number of nodes within 1 “[coverage] area or collision domain or overlapping radio service area” is critical due to shared radio resources etc.  
 Agreed to Define number of nodes, as it requires more explanation. (open)

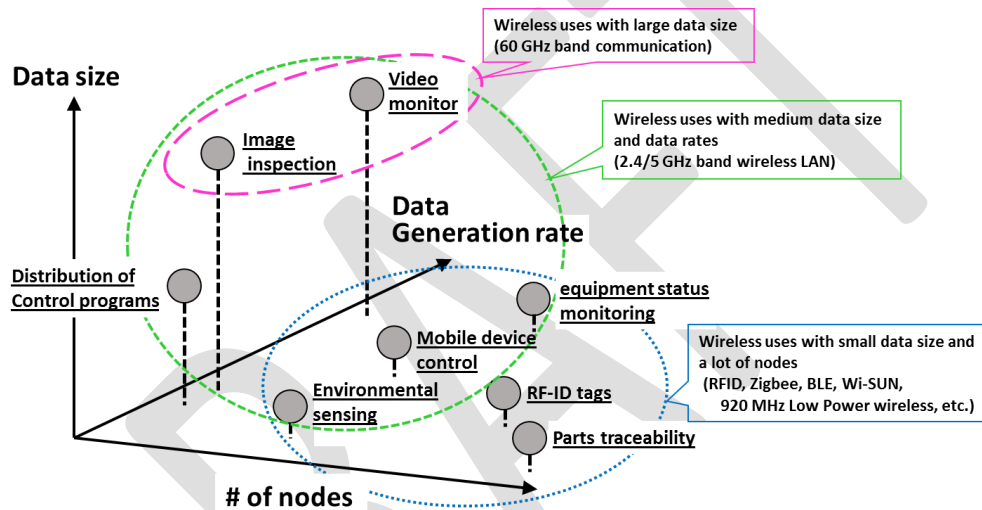

**Figure 10 Representative wireless applications and their features of wireless communication**

Figure 11 shows the permissible delay for representative wireless applications. There are wireless applications, such as robot control and urgent announcements, for which the urgency and accuracy of information arrival timing requires less than one millisecond latency. On the other hand, particularly in the categories of quality (inline inspection, etc.) and management (preventive maintenance, etc.), there are many wireless applications that tolerate latencies larger than hundred milliseconds.

Note from OmniRAN 20180305:  
 Need to define what latency means and the assumptions used. (open)

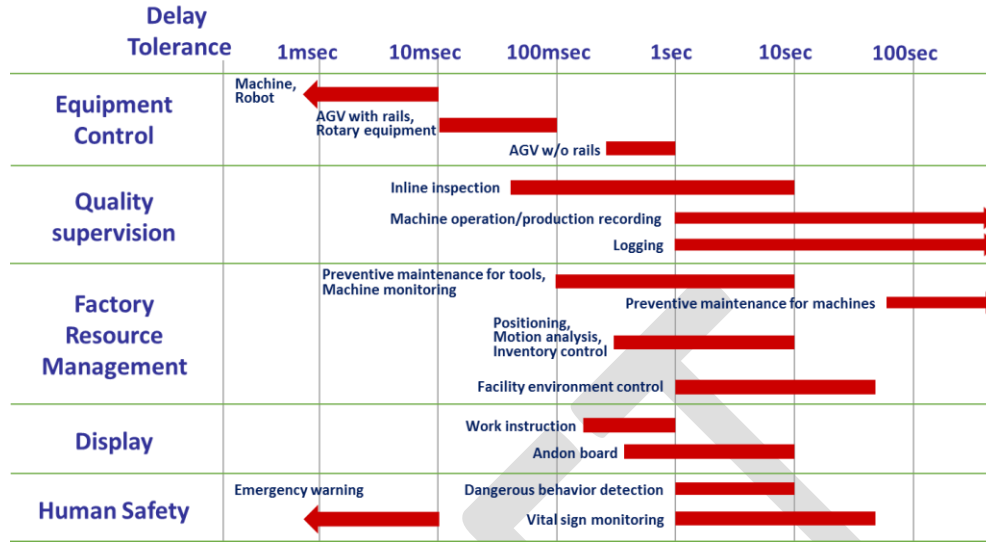

Figure 11 Permissible latencies of representative wireless applications

### Details of wireless application and communication requirements

Communication requirements for the thirteen classifications of wireless applications are organized in Table 2 to 14. Each table contains further detailed purpose of the wireless application, corresponding information, and the communication requirements of transmitted data size, communication rate, delivery time tolerance, and Node density<sup>3</sup>. These attributes are based on observation for a number of samples within the factories surveyed.

Note from OmniRAN 20180305

The 20mx20m is coming from the structure of typical factory in which pillar are separated by 20 m. (done)

Need to also make a statement that these are based on observations on samples of factory surveyed. And the result present summary of this observations. (done)

If the number of nodes is for typical, what is the maximum. (open)

Note for some application we have the numbers in others we don't have.

For the report we don't need accurate statistics but at least the order of number of nodes per application.

To consider some kind of traffic classification for listed application. Ore give reference to current examples where traffic classification is used for industry applications. (open)

<sup>3</sup> Node density :number of terminals per 20m x 20m. This area dimension is based on the structure in a typical; factory in which pillar are separated by 20m.

**Table 2 List of wireless applications and communication requirements for equipment control**

Controlling, operating and commanding of production equipment and auxiliary equipment

No .	Wireless application		Communication requirements			
	Purpose	Corresponding Information	Transmit Data Size (bytes)	Communication Rate	Delivery Time Tolerance	Node density
1	control of liquid injection	water volume	64	once per 1 min.	100 msec.	1
2	operation of conveyor control switch	PLC	16	5 per day	100 msec.	5

**Table 3 List of wireless applications and communication requirements for Quality Supervision -1**

Checking that products are being produced with correct precision

No .	Wireless application		Communication requirements			
	Purpose	Corresponding Information	Data Size (bytes)	Communication Rate	Delivery Time Tolerance	Node density
3	size inspection by line camera (line sensor)	size measurements	30K	once per sec.	5 sec.	1
4	detect defect state	defect information (video)	500	one per 100 msec.	500 msec.	1
5	detect incorrect operation	anomalous behavior due to adding impurities	1M	once per sec.	10 sec.	1

**Table 4 List of wireless applications and communication requirements for Quality Supervision -2**

Checking that manufacture is proceeding with correct procedure and status

No .	Wireless application		Communication requirements			
	Purpose	Corresponding Information	Data Size (bytes)	Communication Rate	Arrival Time Tolerance	Node density
6	sensing for	air stream	64	once per sec.	1 min.	1

	managing air conditioning					
7	monitoring of equipment	state of tools, disposables	a few hundreds	once per sec.	1 sec.	2
8	counting number of failsafe wrench operations	pulses	64	once per 1 min.	100 msec.	10

**Table 5 List of wireless applications and communication requirements for Factory Resource Management -1**

Checking that the factory environment is being correctly managed

No.	Wireless application		Communication requirements			
	Purpose	Corresponding Information	Transmit Data Size (bytes)	Communication Rate	Delivery Time Tolerance	Node density
9	managing clean room (booth)dust count	Dust count (particles)	32	once per min.	5 sec.	5
10	managing carbon dioxide concentration	CO2 concentration	16	once per min.	5 sec.	2
11	preventive maintenance	machine's temperature	a few tens	real-time	1 sec.	2

**Table 6 List of wireless applications and communication requirements for Factory Resource Management -2**

Monitoring movement of people and things

No.	Wireless application		Communication requirements			
	Purpose	Corresponding Information	Transmit Data Size (bytes)	Communication Rate	Delivery Time Tolerance	Node density
12	movement analysis	wireless beacon	a few tens	twice per sec.	few secs.	
13	measuring location of	transmission time (phase),	a few tens of	once per sec.	1 sec.	2

	people and things	radio signal strength, etc.	thousands			
14	measuring location of products	location of products during manufacture	200	once per sec.	1 sec.	20

**Table 7 List of wireless applications and communication requirements for Factory Resource Management -3**

Checking the management status of equipment and materials (stock)

No.	Wireless application		Communication requirements			
	Purpose	Corresponding Information	Transmit Data Size (bytes)	Communication Rate	Delivery Time Tolerance	Node density
15	racking assets (beacon transmission)	information of equipment and things	200	once per sec.	1 sec.	20
16	tracking parts, stock	RFID tag	1K	1~10 times per 30 mins.	100 msec.	3 to 30

**Table 8 List of wireless applications and communication requirements for Factory Resource Management -4**

Checking that production equipment are being maintained

No.	Wireless application		Communication requirements			
	Purpose	Corresponding Information	Transmit Data Size (bytes)	Communication Rate	Delivery Time Tolerance	Node density
17	managing facilities	activity of PLC	4K	once per sec. ~ once per min.	one ~ few tens of secs.	
18	measuring energy consumption	energy, current	64	once per min.	1 min.	1
19	monitoring revolving warning light	defect information	100	few times per hour	10 sec.	25

**Table 9 List of wireless applications and communication requirements for Factory Resource Management -5**

Appropriate recording of work and production status

No.	Wireless application		Communication requirements			
	Purpose	Corresponding Information	Transmit Data Size (bytes)	Communication Rate	Delivery Time Tolerance	Node density
20	work record	text data	100	once per min.	1 sec.	9
21	work proof	certification data	1K	once per 3 hours	10 sec.	9
22	Checking completion of process	image, torque waveform	100~100K	once per 10 secs. ~ 1 min.	1 sec.	5

**Table 10 List of wireless applications and communication requirements for Display -1**

Providing appropriate work support

No.	Wireless application		Communication requirements			
	Purpose	Corresponding Information	Transmit Data Size (bytes)	Communication Rate	Delivery Time Tolerance	Node density
23	work commands (wearable device)	image	600	once per 10 secs. ~ 1 min.	1~10 sec.	10 to 20
24	view work manual	text data	100	once per hour	10 sec.	9
25	display information (image display)	image (video/still image)	5M	once per 10 secs. ~ 1 min.	few sec.	

**Table 11 List of wireless applications and communication requirements for Display -2**

Visually display whether the process is proceeding without congestion or delay

No.	Wireless application		Communication requirements			
	Purpose	Corresponding Information	Transmit Data Size (bytes)	Communication Rate	Delivery Time Tolerance	Node density
26	managing congestion	counter (number or remaining number)	few bytes	once per 10 secs. ~ 1 min.	few sec.	
27	managing operation activity	activity of PLC	128	once per hour	100 msec	2
28	displaying	ON/OFF	ew bytes	once per 10	0.5~2.5	30

	revolving warning light		(a few contact points)	secs. ~ 1 min.	sec.	
--	-------------------------	--	------------------------	----------------	------	--

**Table 12 List of wireless applications and communication requirements for Display -3**

Visualization for monitoring production status

No.	Wireless application		Communication requirements			
	Purpose	Corresponding Information	Transmit Data Size (bytes)	Communication Rate	Delivery Time Tolerance	Node density
29	managing operation activity	image	6K	Continuous	500 msec.	1
30	supporting workers	PLC	200	once per 10 secs. ~ 1 min.	500 msec.	5
31	supporting maintenance	image, audio	200	once per 100 msec.	500 msec.	1

**Table 13 List of wireless applications and communication requirements for Human safety**

Ensuring the safety of worker

No.	Wireless application		Communication requirements			
	Purpose	Corresponding Information	Transmit Data Size (bytes)	Communication Rate	Delivery Time Tolerance	Node density
32	detecting dangerous operation	image	6K	0 per sec. (10fps)	1 sec.	1
33	Collecting bio info for managing worker safety	vitals information	100	once per 10 sec.	1 sec.	9
34		vitals information	200	once per 1 min.	5 sec.	20
35		gait	about 100K	~10 per sec (1fps~10fps)	1 min.	10 to 20
36	detect entry to forbidden area	body temperature, infrared	2	when event occurs	1 sec.	1

**Table 14 List of wireless applications and communication requirements for others**

Cases other than above

No.	Wireless application		Communication requirements			
	Purpose	Corresponding	Transmit	Communication	Delivery	Node



		g Information	Data Size (bytes)	n Rate	Time Tolerance	density
37	sending data to robot teaching box	coordinates	few hundred kilobytes	twice per year	less than 500 msec. (safety standard)	10
38	relay of images moving	video	75K	30 per sec.		1
39	techniques, knowhow from experts	video, torque waveforms	24K	0 per sec. (60fps)	None	1

## Factory Usage scenarios

Need introductory text to explain that a factory usage scenario is complete manufacturing process scenarios that utilize a collective applications to achieve a deliverable product. (Done.)

It will also be useful to include typical life span of a factory installation. (Done in the introduction section)

The usage scenario represents a complete manufacturing process that utilize a number of factory applications to achieve a deliverable product. Examples of factor usage scenarios includes:

- Metal processing site
- Mechanical assembly site
- Elevated and high temperature work site
- Logistics warehouse site

As follows we give detail description of these example factory usage scenarios and its collective applications used to within each of these manufacturing scenarios.

### Usage scenarios example: Metal processing site

An illustration depicting a wireless usage scene at a metal working site is shown in [Figure 12](#). A building has a row of machine tools, and materials and products (things) are managed in a certain area of the building. Workers are at locations within the building as needed to operate the machines. In the case of operation monitoring and preventive maintenance, sensors may be

attached to machines. As machine tools may be used for twenty to thirty years, there may be many old machines, with sensors attached after installation. Communication is necessary to collect information from sensors, but if ceilings are high, installing wiring requires high site work, making the cost of wiring expensive. The cost and long work times required by rewiring work when machines are relocated make wireless communication desirable. In the case of management of objects and analysis of worker movement, the subjects move, so the use of wireless communication is a necessity.

In the case of operation monitoring, monitor cameras and sensors are installed on machines to monitor the operation status of the machines. For wireless operation, wired LAN to wireless LAN media converters are installed on wired LAN ports. On machines without wired LAN ports, adaptors may be connected for wireless networking. A wireless network is formed between the machines and a wireless access point, and when an intermittently operated machine is switched on, a link with a wireless access point is established automatically without human intervention. As the wireless interference conditions change with the ON/OFF of wireless devices operating in coordination with the intermittent operation start and stop of nearby machines, it is necessary for the wireless network to have flexibility, such as monitoring the radio environment and switching the used frequency channel. Using this network, time series data such as vibration and torque waveforms acquired by tools and sensors inside machines during operation are sent to a server. Using the acquired data on the server, analysis software detects anomalies or anomaly precursors, and informs a manager. According to requirements such as the number of devices, transmitted data volume, and necessity of real time response, the data is transmitted by an appropriate wireless network such as wireless LAN, Bluetooth, or Zigbee.

In the case of preventive maintenance, various sensors are installed on machine tools. The sensors and wireless communication device are implemented on a single terminal, and terminals may execute primary processing before sending, or the gateway may execute primary processing on data collected from sensors via a wireless network. When sensors and wireless device are implemented on a single terminal, the terminal may aggregate data received from other terminals within radio range and attach it to its own data when it transmits, to reduce the number of transmissions. It may be necessary to sample or compress the data to reduce the volume of data transmitted. Also, data may be normally recorded at the terminal, but limited under certain conditions in order to reduce the data volume.

In the case of management of objects and movement of workers, wireless communications such as Bluetooth Low Energy (BLE) are used to monitor the locations of people and things. A wireless location monitoring system uses tags which periodically transmit beacons and gateways which receive the beacons. Multiple gateways are placed in the monitor area and tags are attached to each person or thing to be monitored. Beacons transmitted by a tag are received by multiple gateways and the received signal strengths are used to determine the location of the tag. By obtaining acceleration information as well as tag ID, the accuracy of location information can be increased. Wireless communication is also used when an operator remotely operates a robot with a terminal called a teaching box. The operator moves around the robot to visually check the position of the robot and its relation with the object being processed. The movement of the operator is only around the robot and not over a wide area, but it is important that the response of the wireless communications is fast. In order to ensure safety, commands triggered by an emergency stop switch need to be transmitted immediately and reliably.

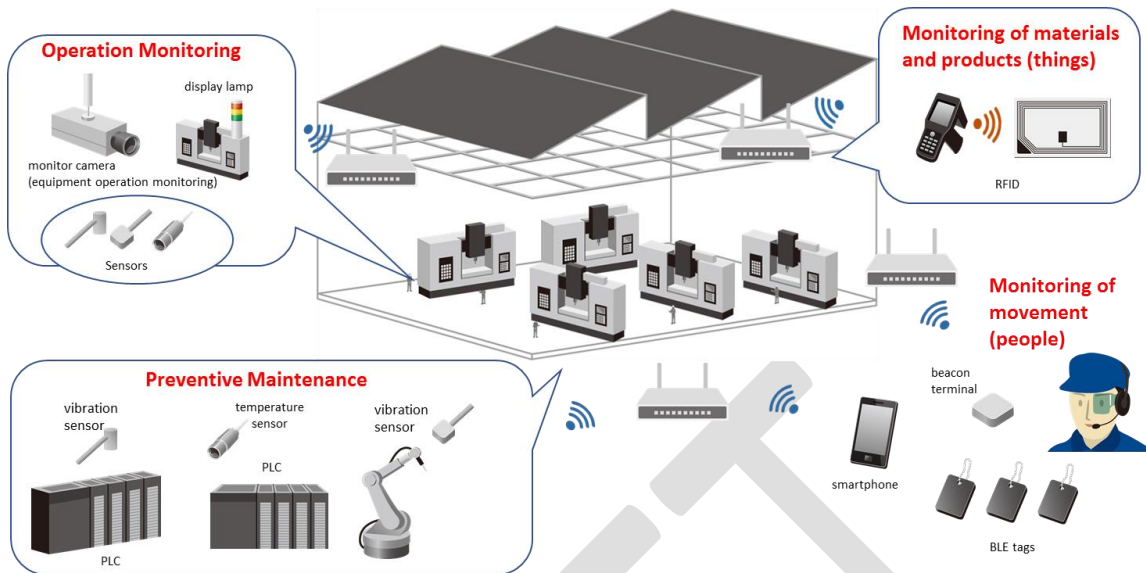

**Figure 12 Usage scene: Metal working site**

### Usage scenarios example: Mechanical assembly site

A wireless usage scene at a mechanical assembly plant is shown in [Figure 13](#). In a mechanical assembly plant, the benefit of wireless communications is expected where management of the environment is necessary, such as during welding and painting, building systems for collection and analysis of data for quality management and traceability, and management of operations, such as Automated Guided Vehicles (AGV) for transport of components.

Sensors such as temperature and humidity sensors and particle sensors are used for environmental monitoring in places such as a paint shop or a clean booth. Wireless communication is used for collecting sensor information because it is possible to manage data from remote rooms, and install sensors inside a room, such as in a clean booth, easily at any time without requiring reconstruction work. The sensors transmit collected environmental information to an upper layer server at periodic time intervals. It is required that no data is lost, that communication routes can be checked when necessary at times of trouble, and relay devices can be installed where radio signal reception is weak without complex expert knowhow.

Wireless communication is used to send data to servers - inspection data from large numbers of workbenches, operation sequences in Programmable Logic Controllers (PLC) used for machine control, error information and environmental information. Also, work tools such as torque-wrenches, acquire and send to servers data such as the number of wrench operations and the success of the operations, and even time series data such as vibration and torque waveforms. As ISO 9001 specifies the mandatory recording of inspection data, it requires the reliable collection of data, although strict requirements are not imposed on communication latency. Hence when transmitting data, it is necessary to check radio usage in the neighborhood, and use available frequency bands and time slots (transmission times) according to the requirements such as number of machines, transmitted data volume and necessity of real-time response.

In the case of production management display (such as an “Andon” display board), in coordination with the above information, wireless communication is used to send data for real-time display of production status information, such as production schedule, production progress and production line operation status.

In the case of AGV with autonomous driving ability, the AGV itself will be able to control its current position and path. Each AGV will be sent a command “go from position A to position B” from a parent device (fixed device) and the AGV will move accordingly. As an AGV may move over a wide area in a factory, it is possible that in some locations the quality of wireless communication will degrade due to physical obstruction by facilities and manufacturing machine tools. Hence, it is necessary to consider the radio propagation environment when deciding where to place wireless access points and to consider the use of multi-hop networks. The number of mobile vehicles used in factories is continuing to increase, and the related issues of the radio environment will require more consideration in the future.

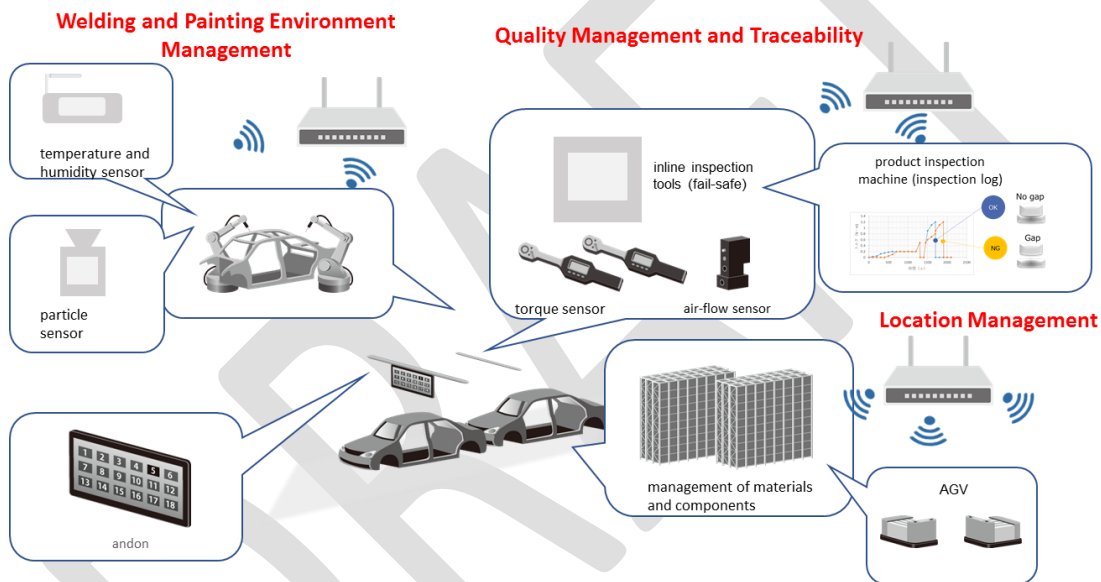

Figure 13 Usage scene example: Mechanical assembly site

### Usage scenarios example: Elevated and high temperature work site

Figure 14 shows an illustration of a wireless communication scene in an elevated and high temperature work site. In production sites such as chemical plants and steel plants, there are intrinsic dangers due to collisions and falls, and extreme environments with high temperature, high humidity. Monitoring each worker’s location and situation from vitals sensors and visual images will be an important application. Workers move about, so it is necessary to collect data using wireless communication. It is assumed that production facilities will be used for many years, so it is necessary to collect information about facility operation and monitor facility operation from the point of view of preventive maintenance. In regard to collecting information from existing facilities, the use of wireless systems that can be easily added are promising for monitoring facility operation using cameras and indicator lights.

In a production site with elevated or high temperature work places, such as a drying furnace or a blast furnace, wireless communication is used to manage the safety of workers, by collecting

workers' vitals sensor information (pulse, activity, body temperature, room temperature, posture (fall detection), etc.) and environmental information (temperature and humidity, pressure, dew point, etc.), and remotely monitoring the situation at the production site using cameras etc. In such cases, wireless communications, such as multi-hop networks with wireless LAN / 920 MHz communication, are used to collect data. Using sensors that detect entry into forbidden areas, combined with BLE beacons, it is possible to monitor the location of workers and warn of entry into dangerous areas. Wireless communications are basically used to transmit position information and vital information of each worker, but it is also possible to send alerts to workers and managers when an abnormal situation arises. Vitals sensors should be of types that do not interfere with work, such as wristwatch type, pendant type, or breast-pocket type.

The communication terminals in a production site may form a wireless multi-hop network, and upload sensor data to a cloud service or server (where the data is finally collected) via a gateway. The uploaded data is used to monitor the workers status. For example, in the case of a system with a path from a sensor attached to a worker via a gateway to a server, wireless communication from the sensor to the gateway might use 920MHz band communication, wireless LAN, or Bluetooth. Communication from gateway to server will require connection via 3G/LTE or wired LAN. When the server is far from the gateway, and it is necessary to have a wireless connection (such as when wiring is not possible) a wireless mesh using wireless LAN, or a point-to-point 60 GHz frequency band system may be used as a backbone. In this case, interference between the wireless backbone and the communication between sensors and gateway must be considered.

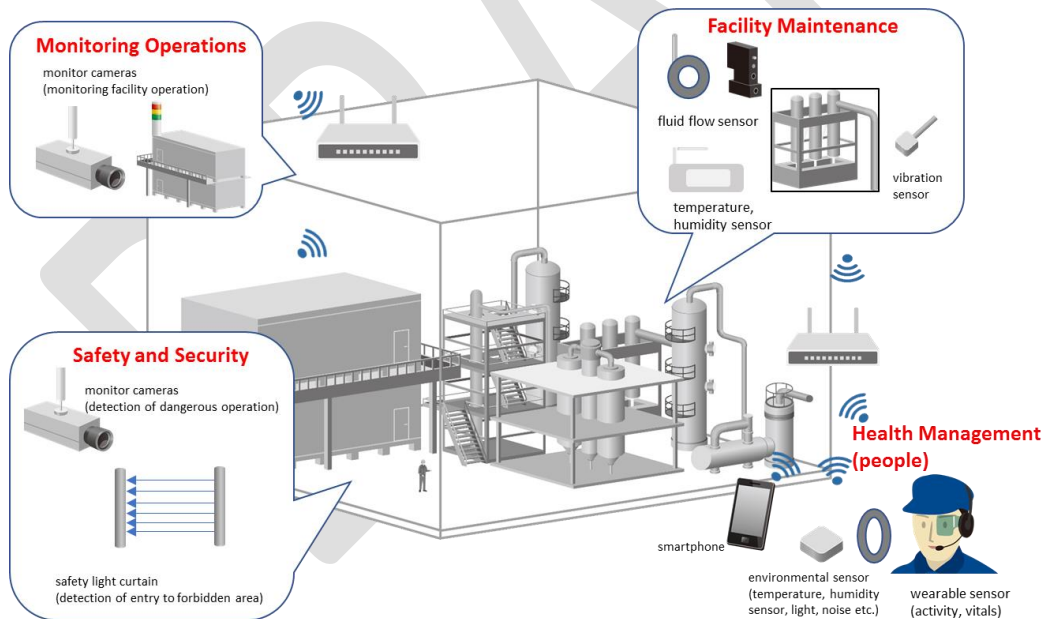

Figure 14 Usage scene example: Elevated and high temperature work site

## Usage scenarios example: Logistics warehouse site

In a logistics warehouse<sup>4</sup>, as shown in [Figure 15](#), three-dimensional automatic storage<sup>5</sup> is used to increase spatial use efficiency. Operation of a three-dimensional automatic storage system requires monitoring of storage operation, preventive maintenance of the stacking system, management of automated guided vehicle (AGV) movement, and so on. A large scale warehouse has multiple storage racks placed in a rows, each of over 30m height and 100m length, and separated by a few meters or less.

The operational status of the warehouse is monitored in conjunction with the transport of storage items in and out by a computer-controlled stacker-crane. When the stacker-crane makes an emergency stop due to detecting a stacking fault, workers might have to climb up a high ladder, tens of meters high, to manually check and repair the stack. When the inspection and repair operation is in a high place, there is greater danger for the worker and operation delay time increases. Previously, workers had to spend time checking the storage even when there was actually no need to stop. Now cameras are used to remotely check the situation on the stacks and the stacker-crane to decide whether operation should be halted or continued, reducing the number of dangerous tasks of workers, and reducing the average time to recovering normal operation. However, in large-scale storage systems, the stacker-cranes move over large ranges, and wiring to cameras attached to stacker-cranes is difficult. Using wireless cameras eliminates the need for signal cables, and so the installing of wireless cameras in three-dimensional automatic storage systems is increasing. Information is sent from the wireless devices on the luggage platform of the stacker-crane to wireless access points (fixed stations) which are placed at one or both ends of the stacker-crane's floor rail.

The images sent from the camera could be video (for example, 30 frames-per-second VGA) or still images (for example, JPEG or PNG with VGA resolution). The speed of the luggage-platform could be as fast as 5 meters-per-second, and the wireless device should automatically select, connect to, and transmit data to the wireless access point with the best link quality. It should also avoid interference with wireless devices on other stacker-cranes which might be running on parallel racks separated by just a few meters.

In three-dimensional automated storage systems, higher speeds of stacker cranes and their continuous operation are required to increase the transport efficiency. Sensors are attached to the drive system that drives the vertical motion of the luggage-platform, and the drive system that drives horizontal motion of the crane along its rails. A wireless communication device relays the sensor data, and computer analysis and learning of the data is used for preventive maintenance of the drive systems.

In some cases, in order to increase the flexibility of the layout in the warehouse, the luggage carried out by a stacker-crane is transported to another storage or work place by a forklift or AGV. The magnetic tape that is used taped on the floor to guide the motion of a trackless AGV cannot carry data, so control information such as destination is sent by wireless communication. Also, forklifts and AGVs have devices for detecting their location, and location information is relayed by wireless communication. Location information collected from forklifts and AGVs is used to manage their operation, and methods are being developed to improve transport

---

<sup>4</sup> A warehouse in which items are stored and managed in racks, and moved in and out automatically with computer control.

<sup>5</sup> Equipment for transporting in and out of a three-dimensional automatic storage system.

efficiency by coordinating their motion with stacker-cranes, allowing the selection of the AGV with the shortest travel distance, for example.

In regard to use of sensors for preventive maintenance on drive systems of stacker-cranes, and managing movement of forklifts and AGVs, in large scale factories, the range of motion may extend over large areas with various large structures such as three-dimensional storage racks, so the placement of wireless access points and the selection of wireless frequency band are important issues.

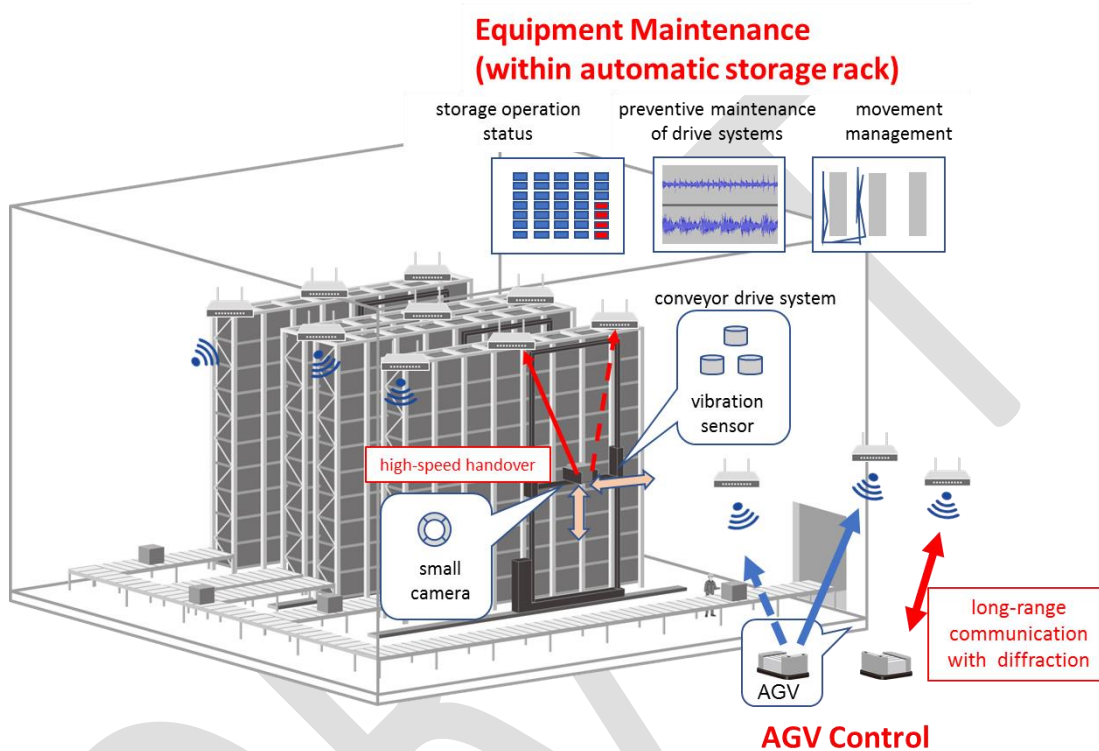

Figure 15 Usage scene example: Logistics warehouse site

## Technological Enhancement of Networking for Flexible Factory IoT Factory End-to-End Network architecture

### Concept of architecture

### Gaps in existing IEEE 802 technologies



Preliminary and partial material inserted here (i.e. provisionally). More is needed. But check first on the intended contents of this section.

Note from OmniRan 20180305:

- List which of the listed functions address each of the TSN attributes such as synchronization, latency, reliability, rate constraint, etc.
- Also how the various traffic types are applied within the architecture to manage the traffic for each application addressed previously.
- Need to address Implication of nodes density on the TSN protocols. (in wired network this is not an issue since it does not have the problem of nodes density).

QoS management of streams across their paths is important in the automation of factories. There are several functions and protocols within existing IEEE802 standards that maybe used for the provision of QoS and priority control over bridged network. Example of such functions are given as follows.

- Stream Reservation Protocol (SRP)/Multiple Stream Reservation Protocol (MSRP). [802.1Qat]
- Forwarding and Queuing for Time-Sensitive Streams (FQTSS) [802.1Qav]
- Generalized Precision Time Protocol (gPTP)[802.1AS]
- Priority-based Flow Control (PFC) [802.1Qbb]
- Congestion Notification (CN) [802.1Qbb]
- Enhanced Transmission Selection (ETS) [802.1Qaz]
- Access Categories (ACs) for priority in EDCA [802.11e]
- Quality-of-service Management Frame (QMF) [802.11ae]

As an example, the Priority-based Flow Control (PFC) in the congestion notification protocols of IEEE802.1Qbb can create eight separate virtual links on a physical link. It enables pause based on user priorities or classes of service. As illustrated in [Figure 16](#) below virtual link Six is signalled to stop because it is associated with the lowest QoS class. The PFC protocol functions well when the bandwidth in a physical link is stable and sufficiently larger than the required bandwidth of each virtual link.



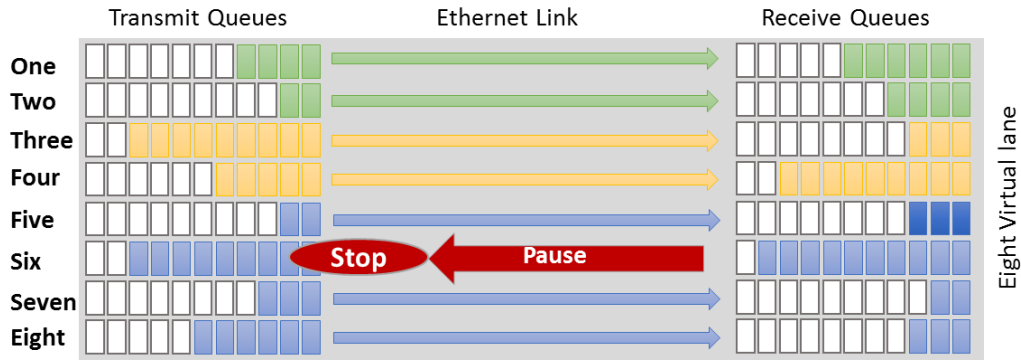

**Figure 16 Example of operation of the PFC function**

By considering the PFC operation under multi-hop scenario potentially with wireless links which has narrow and fluctuating nature of bandwidth, it is difficult to establish separated multiple virtual links with a margin. In such a case, data streams rush into the physical link with the lowest latency regardless of actual bandwidth at that time. This may cause congestion at a node leading to unnecessary stopping/interruption as illustrated by the example in [Figure 17](#) below.

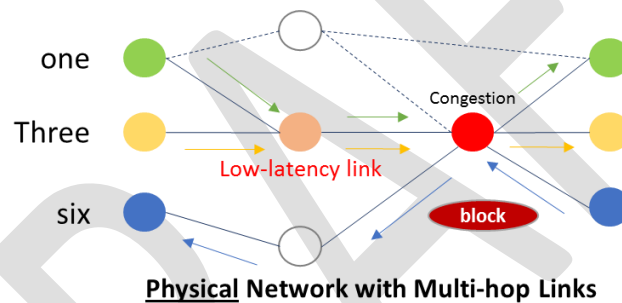

**Physical Network with Multi-hop Links**

**Figure 17 Impact of PFC function over multi-hop links with fluctuating bandwidth**

It is easily observed that PFC on a single hop may not be sufficient to guarantee the overall end-to-end communication quality in the integrated wired and wireless network topology shown in [Figure 17](#). To eliminate congestion and keep effective virtualization, dynamic load balance or other mechanism in a forcible manner in the wireless part is required.

## Conclusions

More body text. More body text. More body text. More body text. More body text. More body text.

## Citations

[1]

DRAFT