



## **TUTORIAL**

# **Switching Transients, Transformer Failures and Practical Solutions**

David D. Shipp, PE  
Fellow, IEEE  
Capstone Engineering  
3300 Tarr Hollow Rd.  
Murrysville, PA 15668  
daviddshipp@gmail.com

Thomas J. Dionise, PE  
Senior Member, IEEE  
Eaton Electrical Group  
130 Commonwealth Dr.  
Warrendale, PA 15086  
thomasjdionise@eaton.com

**2016 IEEE Houston Section  
Continuing Education on Demand  
Houston, TX  
February 9 – 10, 2016**



TABLE OF CONTENTS

**1.0 INTRODUCTION.....1-1**

**2.0 TRANSFORMER FAILURES, ANALYSIS, SOLUTIONS.....2-1**

**3.0 PT & CPT FAILURES, ANALYSIS, SOLUTIONS .....3-1**

**4.0 REFERENCES.....4-1**





## 1.0 INTRODUCTION

Switching transients associated with circuit breakers have been observed for many years. Recently this phenomenon has been attributed to a significant number of transformer failures involving primary circuit breaker switching. These transformer failures had common contributing factors such as 1) primary vacuum or SF-6 breaker, 2) short cable or bus connection to transformer, and 3) application involving dry-type or cast coil transformers and some liquid filled.

This tutorial will review these recent transformer failures due to primary circuit breaker switching transients to show the severity of damage caused by the voltage surge and discuss the common contributing factors. Next, switching transient simulations in the electromagnetic transients program (EMTP) will give case studies which illustrate how breaker characteristics of current chopping and re-strike combine with critical circuit characteristics to cause transformer failure.

This tutorial will also address two special types of medium voltage transformer failures: 1) potential transformer (PT) failures due to ferroresonance, and 2) reduced voltage auto-transformer (RVAT) failures. For both of these medium voltage switching transient induced transformer failures, the tutorial will provide means of prediction, measurement and practical solution.

Design and installation considerations will be addressed, especially the challenges of retrofitting a snubber to an existing facility with limited space. Finally, several techniques and equipment that have proven to successfully mitigate the breaker switching transients will be presented including surge arresters, surge capacitors, snubbers and these in combination.

Note: This page intentionally left blank.

## 2.0 TRANSFORMER FAILURES, ANALYSIS, SOLUTIONS

This section contains copies of the power point slides used during the presentation. The slides have been printed for convenience of note taking.

Note: This page intentionally left blank.

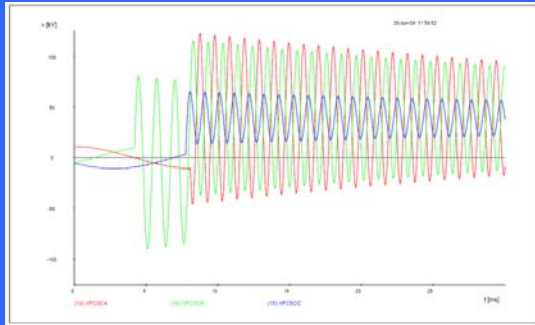

## Part 1 - Transformer Failure Due to Circuit Breaker Induced Switching Transients

David D. Shipp, PE  
Fellow, IEEE  
Capstone Engineering  
3300 Tarr Hollow Rd.  
Murrysville, PA 15668

Thomas J. Dionise, PE  
Senior Member, IEEE  
Eaton Electrical Group  
130 Commonwealth Dr.  
Warrendale, PA 15086

IEEE Houston CED  
February 9-10, 2016

### Introduction

- Switching transients associated with circuit breakers observed for many years
- Breaking opening/closing interacts with the circuit elements producing a transient
- The severity of the transient is magnified by breaker characteristics
  - Current chopping on opening
  - Pre-strike or re-ignition on closing
- In limited instances, the transient overvoltage exceeds transformer BIL resulting in failure
- RC snubber in combination with surge arrester mitigates the transient

## Introduction - Outline

- Forensic evidence and history of failures
- Underlying concepts
- Predicting performance with simulations
- Mitigating the transients with snubbers
- Concerns for data centers & overall industry
- Custom designing the snubber
- Snubber performance measurements
- Other considerations

## Data Center NJ – Forensic Evidence

- Four electricians “simultaneously” opened four 26kV VCBs
  - simulate utility outage
  - systems transferred to standby generation
  - “loud pop” in Sub Rm B
  - the relay for VCB feeding transformer TB3 signaled trip
- Minutes later, two electricians “simultaneously” closed two 26kV VCBs
  - breakers to Sub Rm A
  - transformer TA3 failed catastrophically

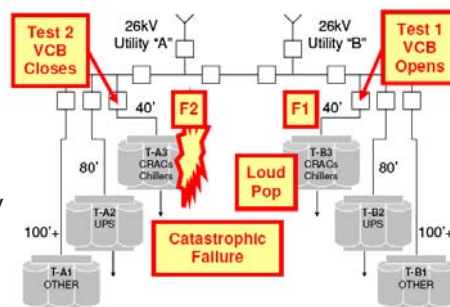

## Transformer Failure #2 - Energization

- Examination of primary windings
  - Coil-to-coil tap burn off
  - Winding showed an upward twist
  - Burn marks from the initial blast
  - Transient on first turns of windings



5

## Transformer Failure #1 – De-energization

- Examination of primary windings
  - Flash and burn marks on b-phase at bottom & middle
  - Bottom - Indicate a coil-to-coil flashover (high dv/dt)
  - Middle – cable used to make delta swung free (lack of support)
  - Transformer passed BIL test at 150kV but failed at 162kV

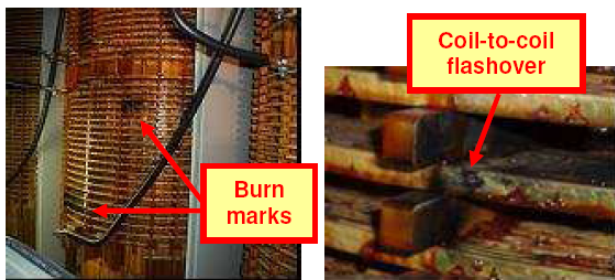

### Both failed units:

- 40 feet of cable
- High efficiency design
- VCB switching



6

## History of Failures – Forensic Review

Case	Facility	Circuit			Transformer***			Vacuum Breaker	
		Voltage	Feet	Bil	Type	Arrester	Failure Mode	Vendor	Switching
1*	Hydro Dam	13.80	20	50	Dry	No	1st turn	A	Close
2	Hospital	13.80	27	95	Dry	No	1st turn	A	Close
3	Railroad	26.40	37	150	Liquid	N/A	middle	A	Open
4	Data Center	26.40	40	150	Cast coil	Yes	1st turn	B	Close/Open
			80	150	Cast coil	Yes	None	B	Close
5	Oil Field	33.00	7		Dry	No	1st turn	C	Close
6**	Oil Drill Ship	11.00	<30	75	Cast coil	Yes	1st turn	C	Close

Notes: \* = 40-50yrs. old with new breaker. \*\* = 2 yrs. old. All others new.  
 \*\*\* = All transformers unloaded or lightly loaded when switched.



7

## Common Parameters

### “Rules of Thumb” to screen applications:

- Generally, short distance between circuit breaker and transformer
  - about 200 feet or less
- Dry-type transformer
  - oil filled and cast coil not immune and low BIL
- Inductive load being switched
  - transformer, motor, etc. (light load or no load)
- Circuit breaker switching characteristics:
  - chop (vacuum or SF6) or restrike (vacuum)



8



## Underlying Concepts - Current Chop

- VCB opens, arc burns metal vapor
- Heat supplied by current
- As current goes to zero, metal vapor ceases
- Arc ceases or “chops”
- All breaker chop current
  - low end 3 – 5A
  - high end 21A

Contact Material	Average (A)	Maximum (A)
CU	15	21
Ag	4	7
Cr	7	16
W	14	50
Cr-Cu (75 wt %) ← Modern VI	3	5
Cr-Cu-Bi (5 wt %)	1	3
Cr-Cu-Sb (9 wt %)	4	11
Cu-Bi (0.15 wt %) ← Older VI	6	21
WC-Ag (50 wt %)	1.5	2.5
W-Cu (30 wt %)	5	10
Co-AG-SE	0.4	0.8
Cu-Bi-Pb	1	9

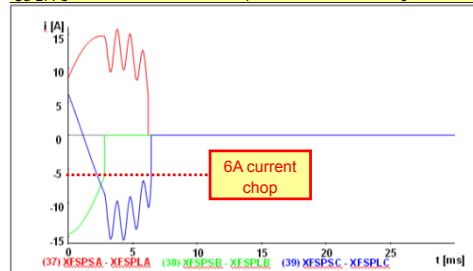

## Reignition and Voltage Escalation

- Current chop plus system C and L imposes high frequency TRV on VCB contacts
- If TRV exceeds breaker rated TRV, then reignition occurs
- VCB closes and then opens high frequency current
- Multiple reignitions lead to voltage escalation

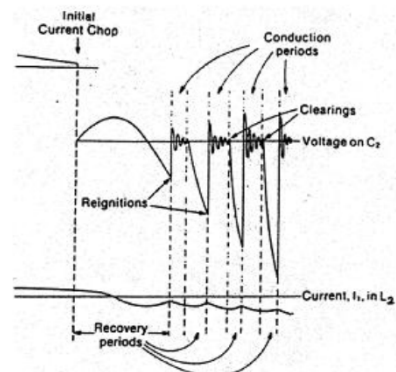

## Switching Inductive Circuits

- Current cannot change instantaneously in an inductor (conservation of energy)
- Energy Equation  $\frac{1}{2} LI^2 = \frac{1}{2} CV^2$  or  $V = I \sqrt{L/C}$
- $V_{\text{transient}} = V_{\text{energy}} + V_{\text{dc}} + V_{\text{osc}}$
- $V_{\text{energy}}$  is from the Energy Equation
- $V_{\text{dc}}$  = DC Off-set due to system X/R
- $V_{\text{osc}}$  = the Oscillatory Ring Wave

## Transformer Limits

- Magnitude – BIL Ratings
- Rate-of-change (dv/dt) Limits
- **Both MUST Be Met**
- Dry Type transformers particularly susceptible
- Liquid Filled Not Immune
- Consider the “Hammer Effect”

## Predicting Performance – EMTF Simulations

- For purposes of screening applications for damaging TOVs
- Source, breaker, cable and transformer modeled
- Breaker models for current chop and re-ignition

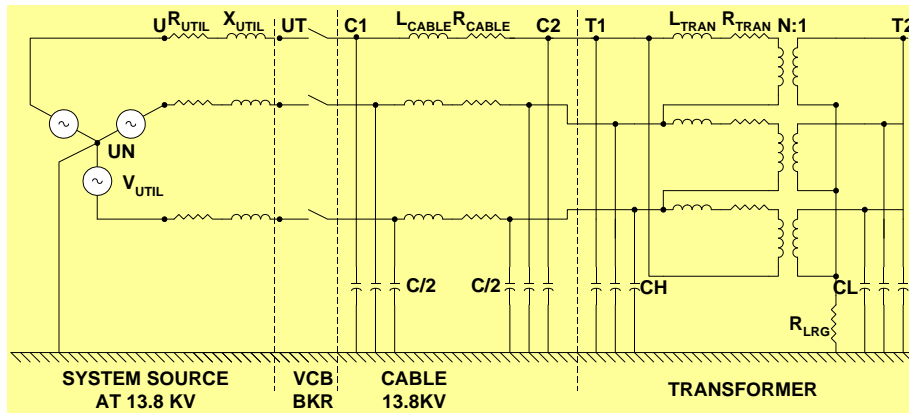

**EATON**  
Powering Business Worldwide

13

## Matching Model to Measurements

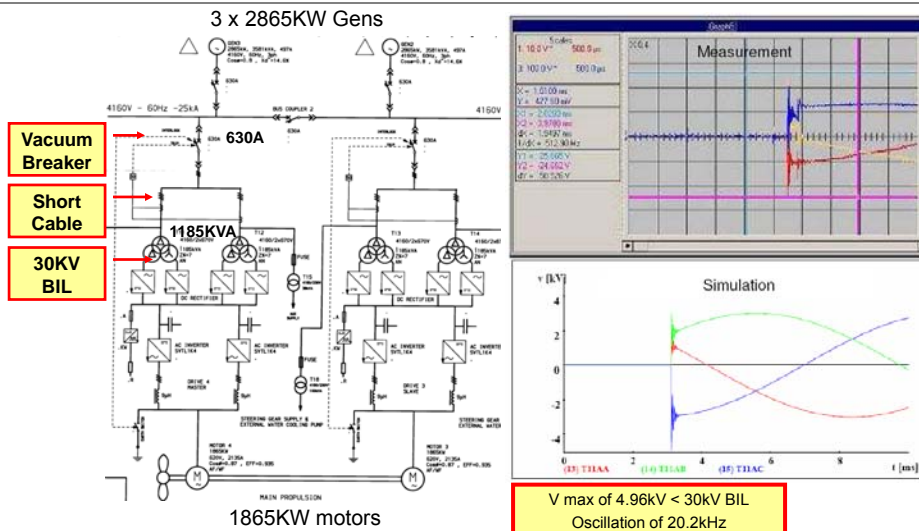

**EATON**  
Powering Business Worldwide

14

## Transient Mitigation

- Surge Arrester
  - Overvoltage protection (magnitude only)
- Surge Arrester + Surge Capacitor
  - Overvoltage protection
  - Slows down rate-of-rise
- Surge Arrester + RC Snubber
  - Overvoltage protection
  - Slows down rate-of-rise
  - Reduces DC offset and provides damping

## Breaker Opening Followed by Reignition

Transient Recovery Voltage	IEEE ANSI C37.06 C37.011	Note
E2 (kV)	9.044	8.9
T2 (µsec)	79	50
RRRV (kV/µsec)	.1145	.1780

TRV exceeds limit

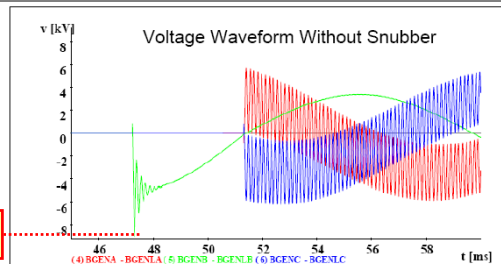

Transient Recovery Voltage	IEEE ANSI C37.06 C37.011	Note
E2	7.702	8.9
T2	149	50
RRRV	.0517	.1780

TRV within limit

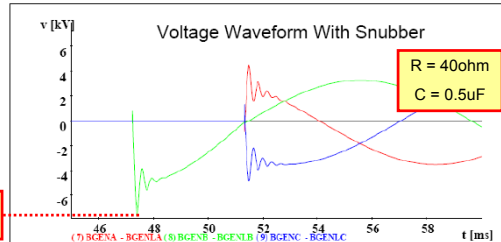

## Case 4 Data Center – New Jersey

- Commissioning Failure
  - 26.4 kV
  - Vendor “B” VCBs
  - 4 Bkrs Switched at Once
    - 2 Dry Type Txmrs Failed
    - (40 Ft of Cable)
    - 2 Txmrs Did not Fail
    - (80 Ft of Cable)
- Unfaulted Txmr Winding
  - Failed BIL @162 kV
  - Rated BIL 150 kV

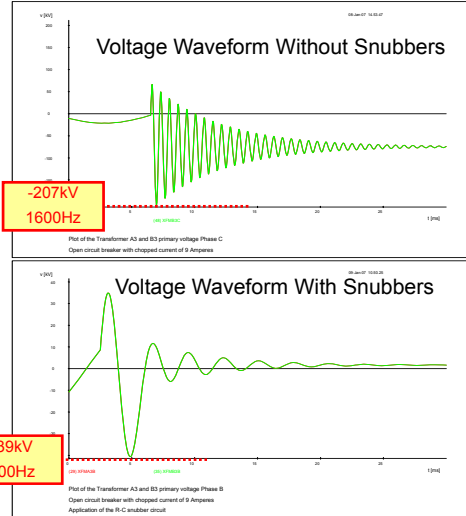

## Data Center - Georgia

- Proactive Analysis
  - 2x 24.8kV lines
  - 2 x 12.5MVA service
  - 13.2kV ring bus
  - 2 x 2250KW generators
  - 6 x 3750KVA cast-coil transformers 90kV BIL
  - VCBs on primary side
  - 109 – 249 ft. cables

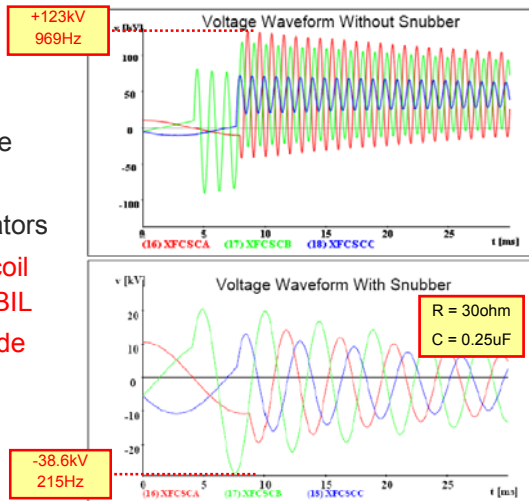

## Case 6 Data Center 2 – New Jersey

- Proactive Analysis
  - 13.2 kV
  - Vendor “B” VCBs
  - 3 MVA Dry Type Txmrs
  - 60 ft Cable – Required Snubbers
  - 157 ft Cable – Required Snubbers
  - No Problem at Startup

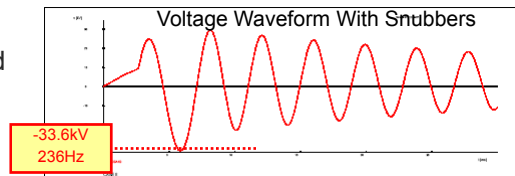
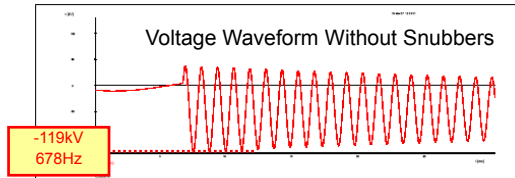

## Data Center – Indiana

- Proactive Analysis
  - 12.47 kV System
  - Vendor “A” VCBs
  - 270 Feet of Cable
  - 95kV BIL transformers
  - No Snubbers Required

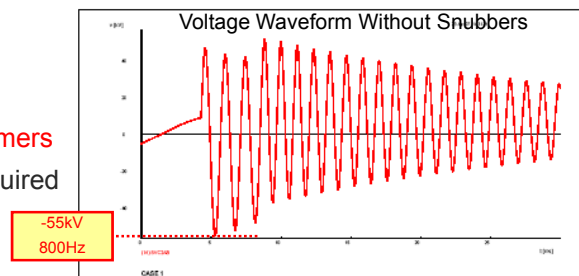

## Case 3 - Railroad Substation Nov. 2006

- Failure Analysis
  - **Vacuum Breaker** – Vendor “A”
  - 26.4 kV
  - 150 kV BIL
  - Generic Liquid Filled Rectifier Transformer
  - **37 feet of Cable**
  - Switched with secondary Rectifier Capacitors
  - **Internal Resonance** with DC bus capacitor

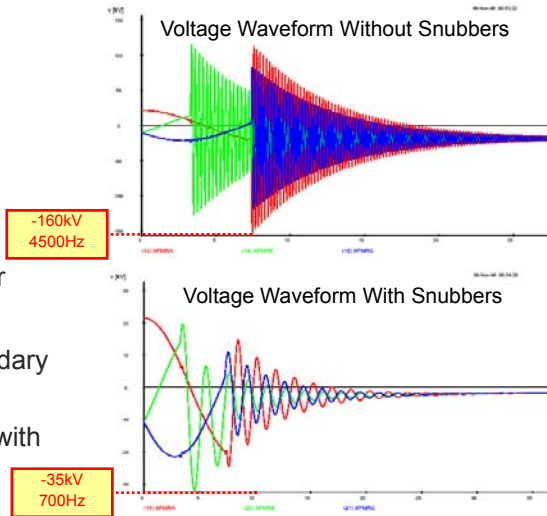

**EATON**  
Powering Business Worldwide

21

## Case 7 - Chemical Plant - NC March 2007

- Study before operating
  - 12.47 kV System
  - **20+ Year Old Oil Filled Transformers**
  - Vendor “A” **Vacuum Breakers** retrofitted on Primary
  - **10 Feet of Cable**
  - No Problem at Startup

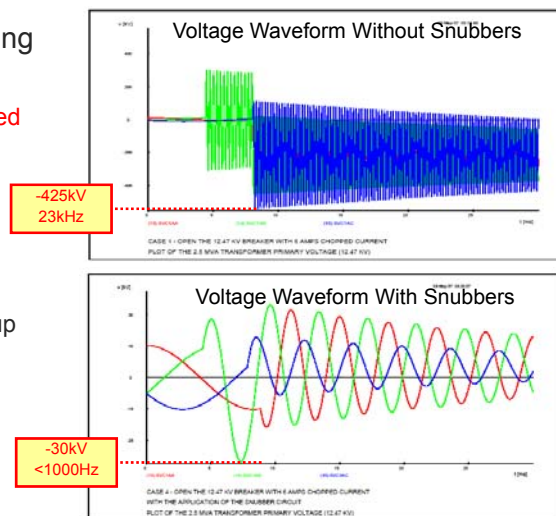

**EATON**  
Powering Business Worldwide

22

## Case 5 - Oil Field – Africa June 2007

- Vacuum Breaker – Vendor “D”
- 33 kV
- 7 Feet of Cable
- Dry Type Transformer
- 36 Pulse VSD, 4000HP motor
- Arresters Were Applied
- Transformer Failed Upon Energization



23

## Case 11 Paper Mill – 13.8 kV

- 4 x Cast Coil Transformer failures Vendor E, 13.8kV/600V, 1.5MVA and one 2MVA.
- Vendor C vacuum breaker
- Failure 2/3 into winding – internal resonance



24



## Case 12 Hospital – Kentucky – 12.47 kV

- Failure during commissioning
  - Emergency Room Transformers
  - Vendor C Vacuum Breakers
  - Vendor F, Transformer
- VPI transformer



**EATON**  
Powering Business Worldwide

25

## Special Conditions

- Highly Inductive Circuits
- Internal Resonance
- Switching Transients – Opening
- Switching Transients – Closing
- Ferro-Resonance – Closing
- Ferro-Resonance – Opening (20 HZ Saturation)

**EATON**  
Powering Business Worldwide

26

## Special Condition: Switching a Highly Inductive Circuit

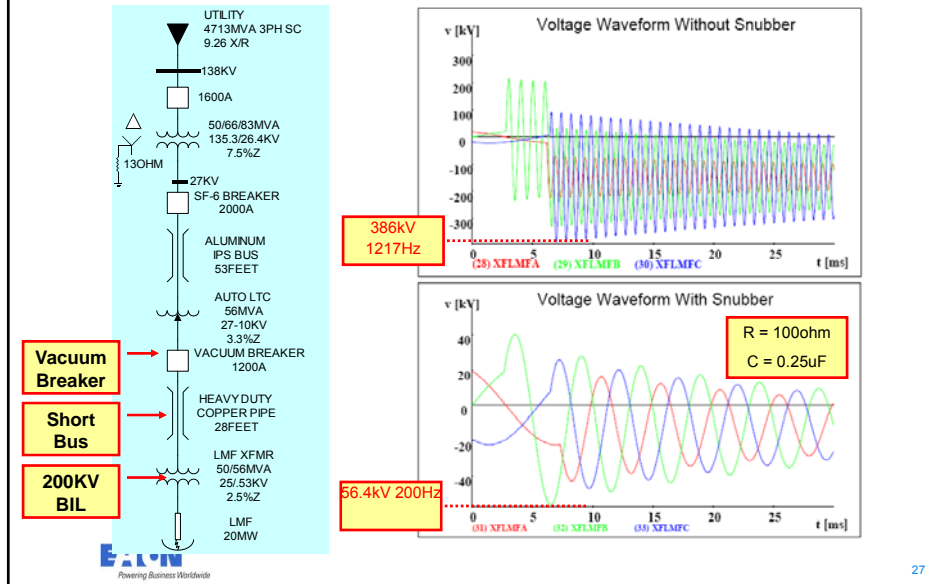

## Case 14 – another highly inductive circuit Breaker Failure – TRV / RRRV

- 34.5 kV Vacuum Breaker Feeding Slave Transformer
- 13.8 kV 15,000 HP Motor
- VCB opened during starting sequence

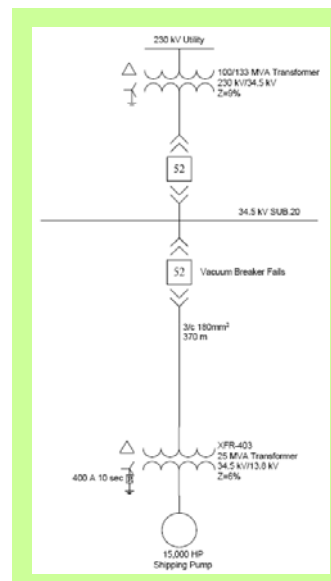

## Case 14 – another inductive circuit Breaker Failure – TRV / RRRV

- Locked rotor amps recorded by DFR
- 3 cycles then VCB opens

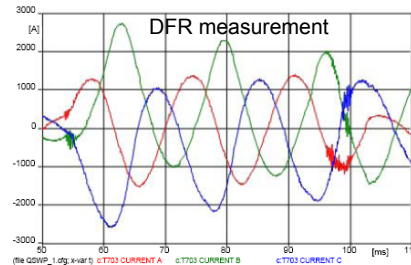

Current waveform passing through switchgear incomer A recorded by DFR TR—4 at Sub 20, 17:06:15.922980 Wed 11 Mar 2009 (70)

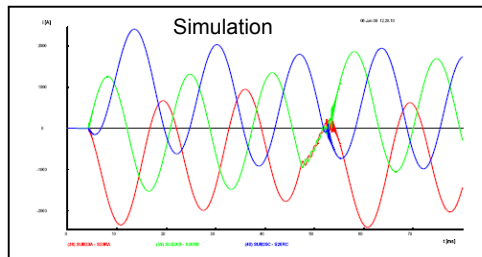

29

## Case 14 – another inductive circuit Breaker Failure – TRV / RRRV

- VCB interrupts highly inductive current at 3cy
- Transient overvoltage
- Excessive TRV & RRRV
- Causes breaker failure

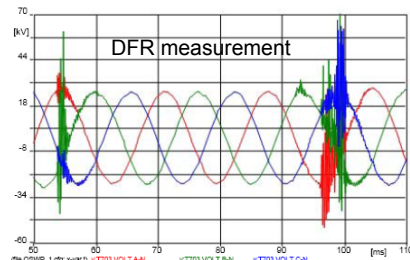

Voltage waveform at 34.5kV bus 020-SG-402-B1 recorded by DFR TR—4 at Sub 20, 17:06:15.922980 Wed 11 Mar 2009 (70)

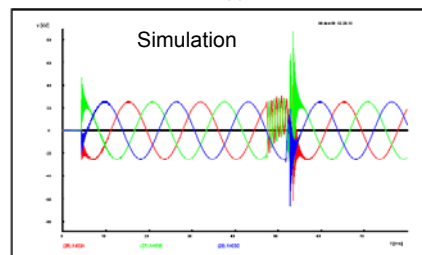

30

## Special Condition: Internal resonance

- Each transformer has a natural frequency
- Natural frequency due to characteristics of design
- Circuit breaker switching may excite natural frequency of transformer

$$NF = \frac{1}{2\pi\sqrt{LC}}$$

## Field Tests – transformer natural frequencies

- Sweep Frequency Response Analysis

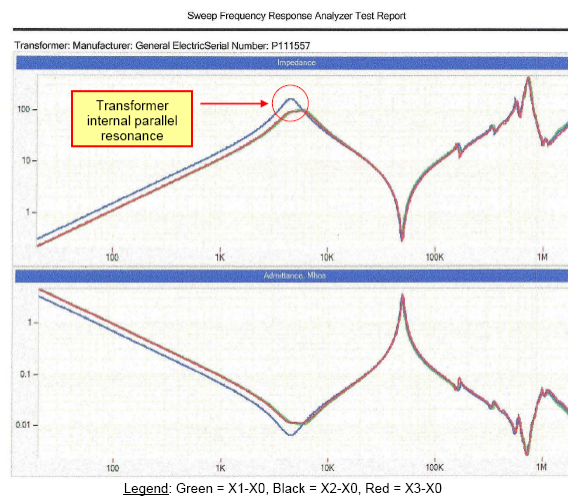

## Special condition: Case 13 4160V Motor Starter RVAT Failures

- 4160V Motor Starter
- 5000HP
- Reduced voltage auto transformer (RVAT) starter
- 3 failures on 1 of 5 starters
- Wye point failure – SA on wye
- Tap point failure
- [Internal resonance](#)
- Layer wound
- Failed layer-to-layer

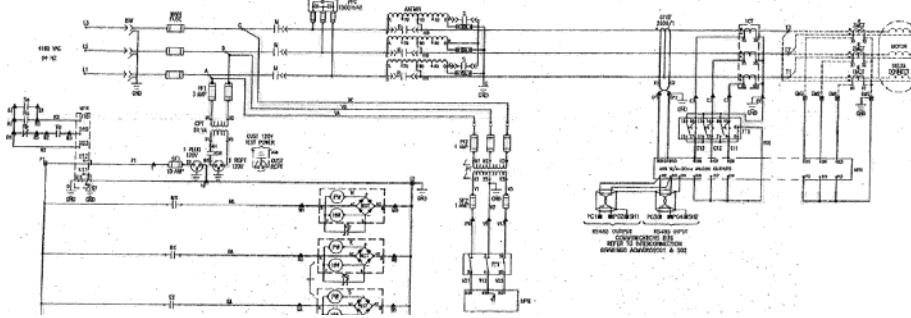

**EATON**  
Powering Business Worldwide

33

## Case 13 RVAT Starter – 1<sup>st</sup> Failure



**EATON**  
Powering Business Worldwide

34

## Case 13 RVAT – 1<sup>st</sup> Failure a closer look



**EAT•N**  
Powering Business Worldwide

35

## Case 13 RVAT Starter – 2<sup>nd</sup> Failure

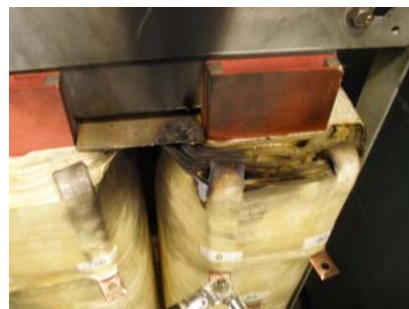

**EAT•N**  
Powering Business Worldwide

36

## Case 13 - Run Contactor Closes 3516 Hz

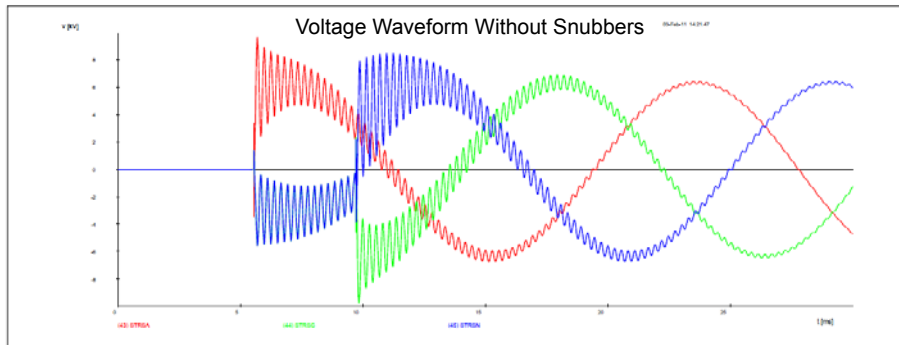

## Case 13 - Sweep Frequency Test 4500 Hz (Admittance)

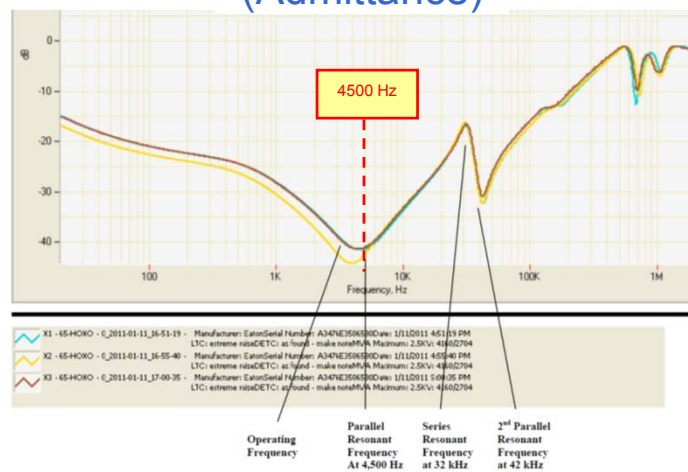

## Case 13 - Run Contactor Closes 844 Hz With Snubber

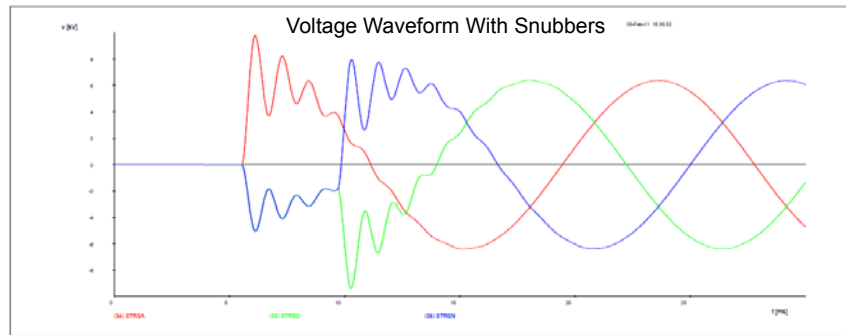

## Pipeline Pump Station ASD Transformer Failures

### PIPELINE PUMP STATION

- 5 x 6.9kV ASD driven vertical pumps
- Main pump motors are 2000 HP, 6000V
- 2.5MVA, 6900/750V, dry-type transformer with 5 x phase shifted secondaries
  - During dry commissioning Pump#2 ASD experienced a failure of the transformer
  - 7 months later at full operation Pump#2 failed again
  - 2 days later Pump#5 had a similar failure
  - Transients or resonance suspected as causes

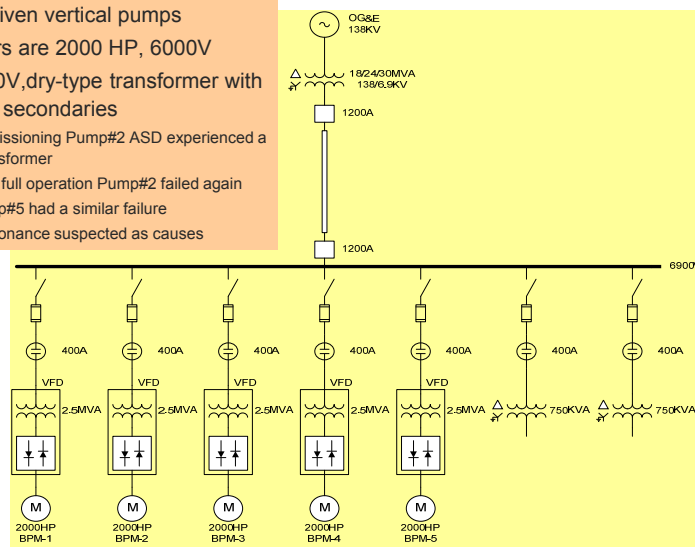



## Pipeline Pump Station ASD Transformer Failures

Voltage Dividers 6.9kV & Scope 10MS/s  
at ASD transformer terminals

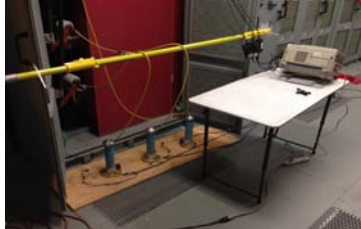

High-speed measurements of contactor  
prestrikes with decreasing intervals

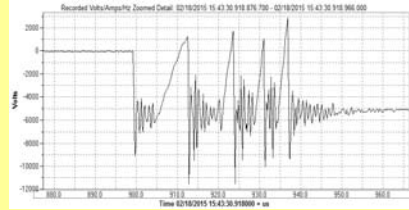

30 kHz oscillation on contactor closing

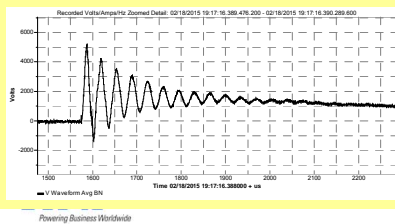

High-speed measurements of contactor  
prestrikes with increasing intervals

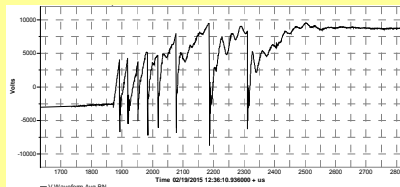

41

## Pipeline Pump Station ASD Transformer Failures

### SFRA TEST RESULTS

- parallel resonances near 4 and 35 kHz
- series resonance near 40 and 55 kHz
- 30 kHz voltage oscillations recorded during closing and opening of the contactor
- magnitude of 1.0 per unit and frequency near 30 kHz
- switching frequency near transformer internal resonance frequency per SFRA test
- switching event may be exciting an internal resonance
- causes high voltage to occur within transformer winding that may exceed the insulation withstand leading to eventual failure

30 kHz oscillation on contactor closing

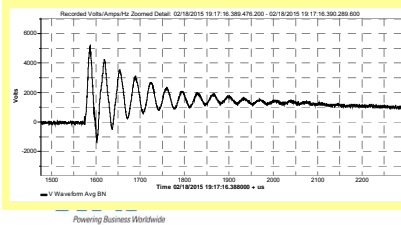

Sweep Frequency Response Analysis Test  
shows internal modes

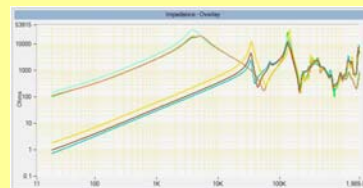

42

## Pipeline Pump Station Matching simulations to measurements for ASD2

Transformer voltage - contactor opening

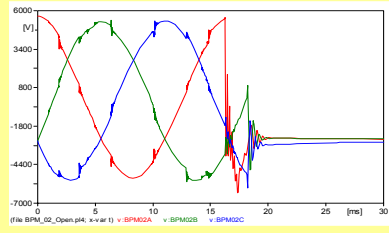

Transformer voltage - contactor closing

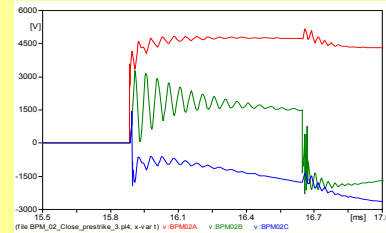

Transformer voltage - contactor opening  
(measured)

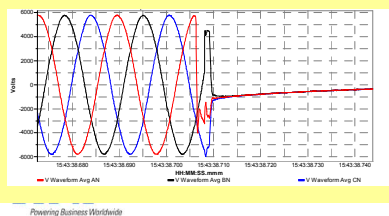

Transformer voltage - contactor closing  
(measured)

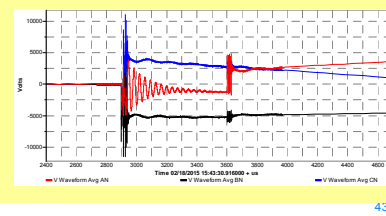

43

## Pipeline Pump Station Solution: Snubbers

Transformer voltage – prestrike on closing

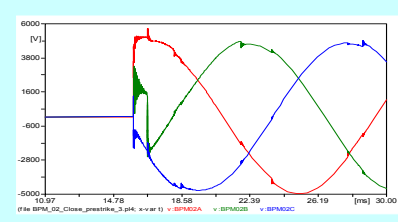

Transformer voltage – no prestrike closing

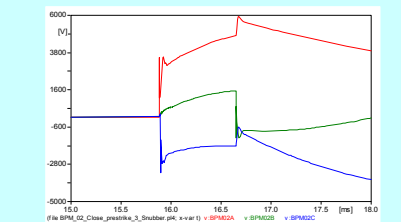

Snubber: 40Ohm, 0.5uF, 7.2kV

Contactor withstand - prestrike on closing

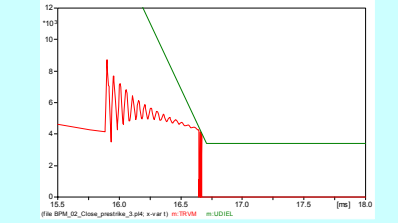

Contactor withstand no prestrike on closing

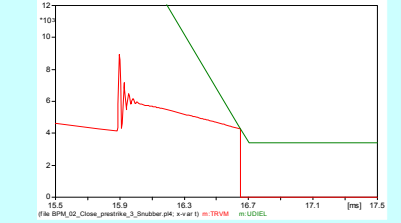

44

## Offshore Platform – RVAT Failures Oil Shipping Pumps & VRU

### VRU & OIL SHIPPING PUMPS

- 4 x 5937 kVA, 4.16 kV generators
- 4 x 2500 HP, 4.16kV pumps
- 8 RVAT failures from 2001 to 2013
- Teardown/Failure analysis indicated layer-to-layer failure
- Internal resonance identified as a possible failure mode
- Undertook Transient Study coupled with SFRA testing to determine root cause of failures & find solution

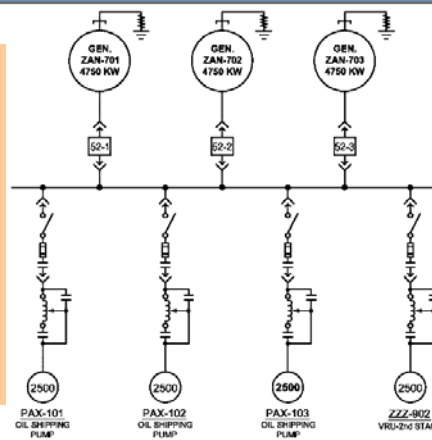

**Model predicted switching transients to compare with transformer resonant frequencies**



45

## Offshore Platform Autotransformer Starter Circuit

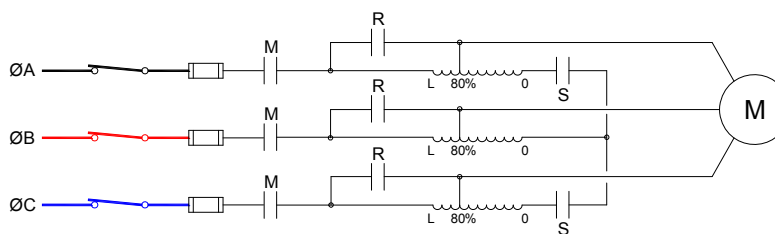

**Ready to Start - All Contactors Open**



46

## Layer to Layer Failures



Only **319 Volts** Maximum during Normal Operation



47

## Offshore Platform - Transformer Internal Resonance Determined by Test



**Sweep Frequency Response Analysis (SFRA) Testing identifies internal resonant frequencies**



48

## Offshore Platform RVAT Results of Transient Simulations

Simulation	Close M Frequency (kHz)	Open S Frequency (kHz)	Series/Parallel Internal Resonance (kHz)
No compensation	21.2	6.4	First - 5/22 Second - 30/400
C at motor	17.2	2.2	First - 5/22 Second - 30/400
RC at 100% tap and C at motor	6.6	2.1	First - 5/22 Second - 30/400
RC at 100% and 0% taps as well as motor	-	0.5	First - 5/22 Second - 30/400

## Offshore Platform RVAT Vacuum Interrupter (VI) Current Chop

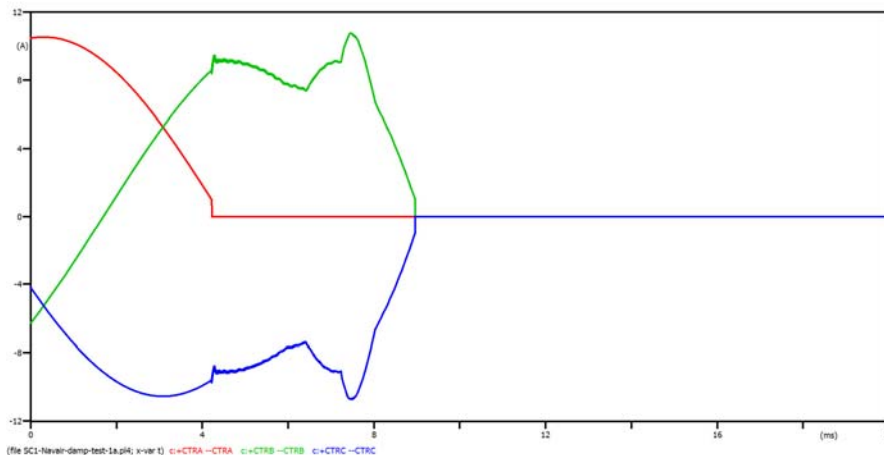

**Example of 1Amp Current Chop on Red Phase with Current continuing to flow on Blue and Green Phases**

## System Model

Voltage at RVAT 100% tap when M closes

(no surge protection)

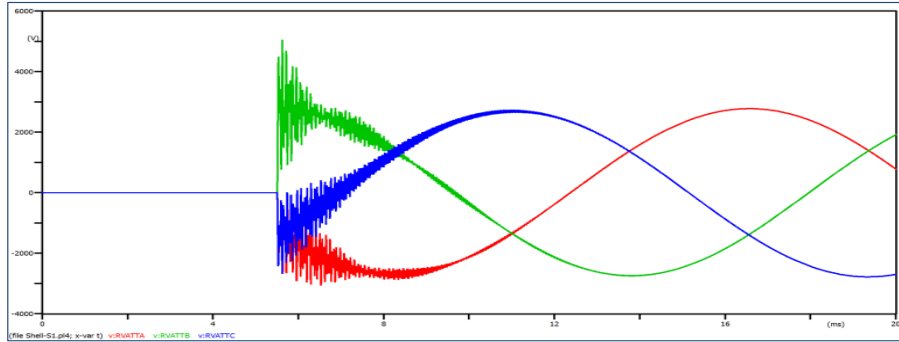

TOV (kV)	Frequency (kHz)	Series/Parallel Internal Resonance (kHz)	Acceptable Unacceptable
5.0	21.2	First - 5/22 Second - 30/400	Unacceptable



51

## System Model

Voltage at RVAT 100% tap when M closes

(surge cap at motor)

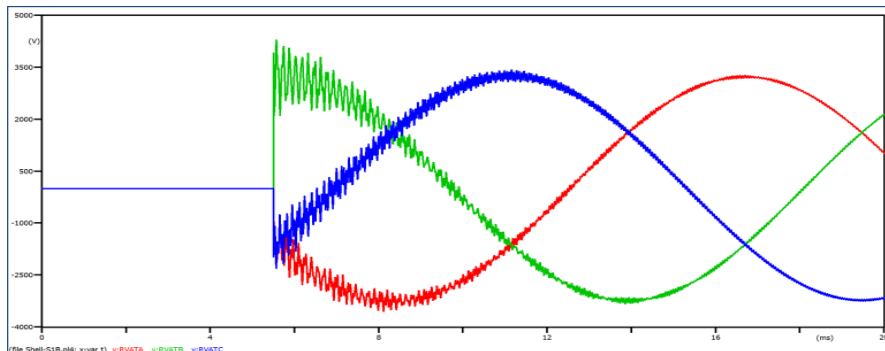

TOV (kV)	Frequency (kHz)	Series/Parallel Internal Resonance (kHz)	Acceptable Unacceptable
4.3	17.2	First - 5/22 Second - 30/400	Unacceptable



52

## System Model

Voltage at RVAT 100% tap when M closes

(RC Snubber at 100% Tap and Surge Cap at Motor)

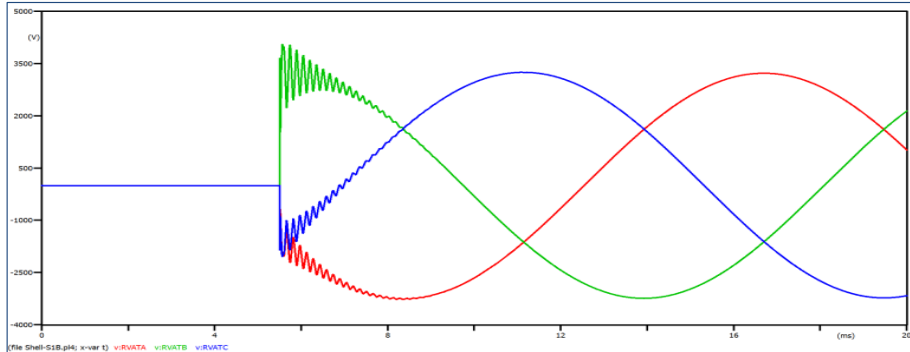

TOV (kV)	Frequency (kHz)	Series/Parallel Internal Resonance (kHz)	Acceptable Unacceptable
4.0	6.6	First - 5/22 Second - 30/400	Unacceptable



53

## System Model

Voltage at RVAT 100% tap when M closes

(RC Snubber at 100% Tap, 0% Tap and Motor)

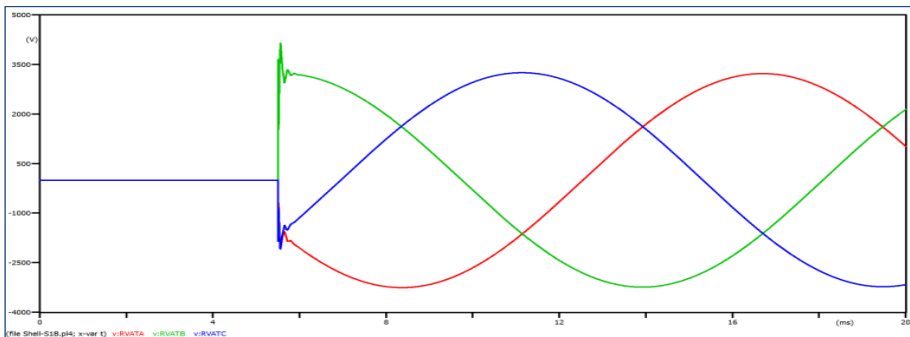

TOV (kV)	Frequency (kHz)	Series/Parallel Internal Resonance (kHz)	Acceptable Unacceptable
4.1	-	First - 5/22 Second - 30/400	Acceptable



54

## System Model

Voltage at RVAT 0 % tap when S opens  
(no surge protection)

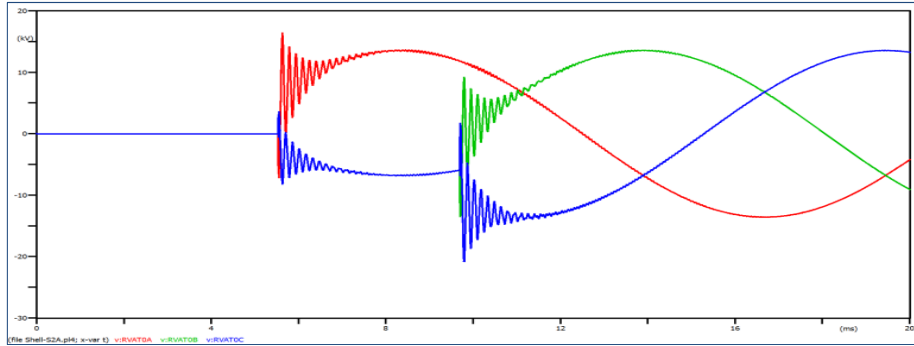

TOV (kV)	Frequency (kHz)	Series/Parallel Internal Resonance (kHz)	Acceptable Unacceptable
20.7	6.4	First - 5/22 Second - 30/400	Unacceptable



55

## System Model

Voltage at RVAT 0 % tap when S opens  
(surge cap at motor)

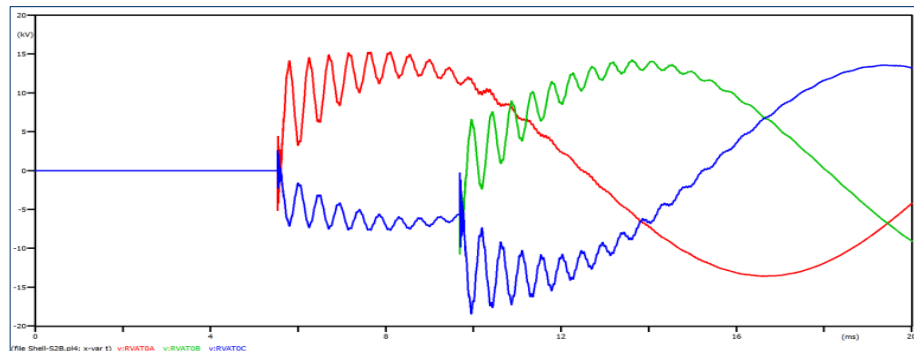

TOV (kV)	Frequency (kHz)	Series/Parallel Internal Resonance (kHz)	Acceptable Unacceptable
14.0	2.2	First - 5/22 Second - 30/400	Acceptable



56



## System Model

Voltage at RVAT 0 % tap when S opens

(RC Snubber at 100% Tap and Surge Cap at Motor)

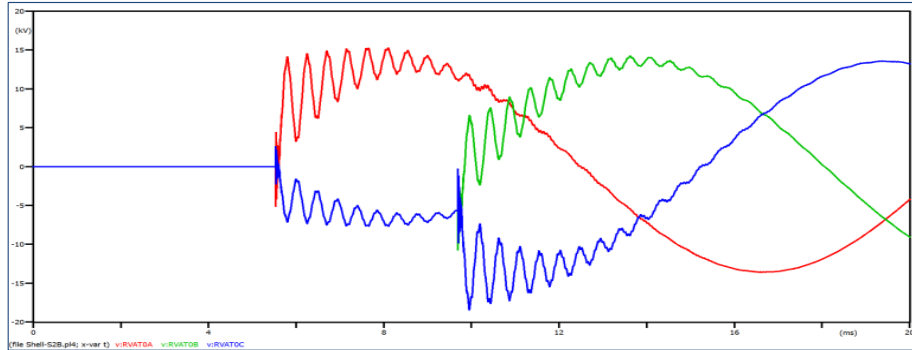

TOV (kV)	Frequency (kHz)	Series/Parallel Internal Resonance (kHz)	Acceptable Unacceptable
13.7	2.1	First - 5/22 Second - 30/400	Acceptable



57

## System Model

Voltage at RVAT 0 % tap when S opens

(RC Snubber at 100% Tap, 0% Tap and Motor)

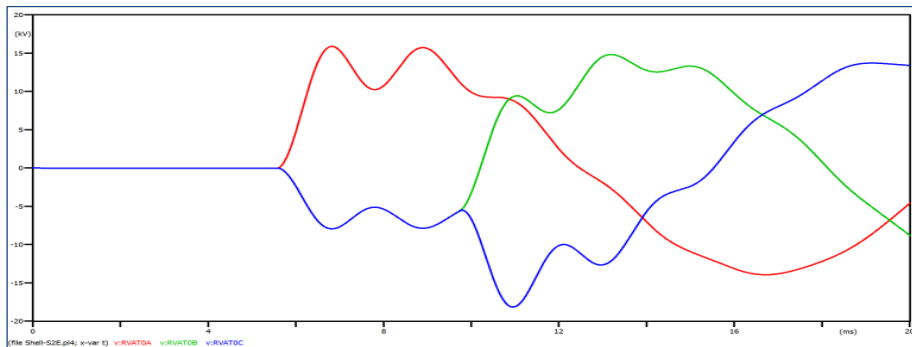

TOV (kV)	Frequency (kHz)	Series/Parallel Internal Resonance (kHz)	Acceptable Unacceptable
18.0	0.5	First - 5/22 Second - 30/400	Acceptable



58

## Concerns for Data Centers

- Data Centers Fall into the **Highest Risk Category**
- High Power Density
- Close Proximities
- Frequent Switching
- High Efficiency Designs

## Concerns for Industry at Large

- **VCB retrofit for primary load break switch (LBS)**
  - Units subs with LBS and no secondary main
  - Arc flash issues on sec main (no room to install secondary main breaker)
  - Retrofit VCB in LBS box solves AF issue
- **VCB for rectifier (or isolation) transformer**
  - DC drives for feed water pumps
  - VCB on primary
  - Short run of cable to transformer (often dry type)
- **New unit sub with primary VCB**
  - Metal enclosed vacuum switchgear
  - 7500KVA transformer for gen boilers to meet EPA requirement
  - 5 feet of bus

## Snubber Design and Application

### How do you start?

- Results of the transient switching study
  - Resistor and surge capacitor specification
  - The location of the snubber equipment.
  - What are you trying to protect?
- A spec ? or Customer discussions?
  - Fuses, alarm circuits, pilot light indications, horn
- Physical layout of the area
  - Indoors, or outdoors ? What are space limitations?
- Design examples and photos.



72

## Considerations

- Where do we locate the snubber?
- Where does the high frequency transient come from?
- What are the clearance requirements for the voltage level? Metal enclosed equipment standards C37.20.
- What configurations are necessary for high frequency transients?



73

## Considerations for Potential Transformers / CPTs Where Switching May be an Issue

- Switching Unloaded PTs on the line side of the Main Bkr
- Switching PTs with Cables longer than 100 feet
- Switching PTs with Unloaded Power Txmrs
- Open-Delta Connections
- Failure Investigations



74

## Designing the Snubber

- 15kV typical snubber & arrester
  - transformer protection
- non-inductive ceramic resistor
  - 25 ohms to 50 ohms
- surge capacitor
  - Standard capacitor ratings 0.15  $\mu$ F to 0.35  $\mu$ F
  - 3-phase 13.8kV solidly ground
  - 1-phase 13.8kV LRG

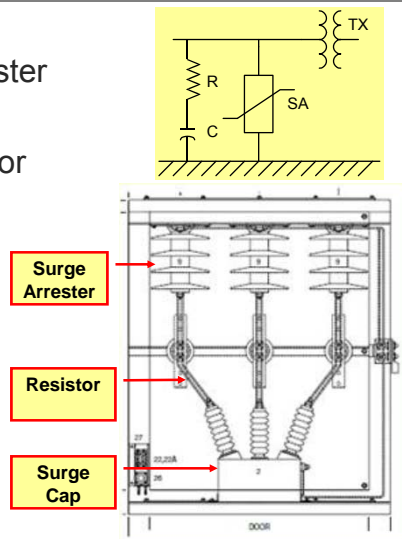

15kV snubber for mounting inside transformer (open design)



## Top hat and switchgear designs

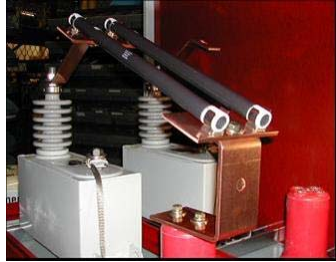

15kV snubber for mounting above transformer (top hat)



15kV snubber in MV switchgear (switchgear design)



13.8kV snubber in metal enclosed switchgear



76

## Data Center New Jersey - design

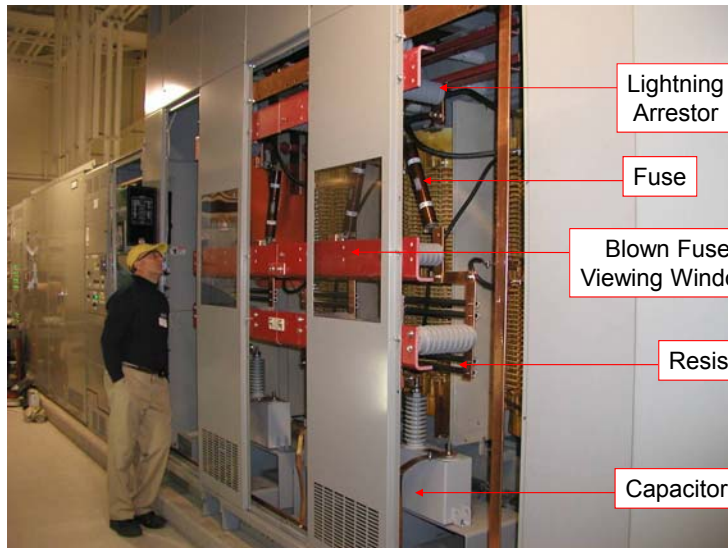

77

## Data Center Georgia - compact design

- Compact 15 kV design
- 20" wide x 30" deep x 78" high

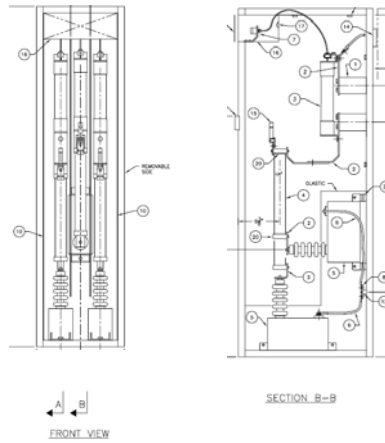

78

## Snubber - Compact design



15kV snubber (compact)  
NEMA1 enclosure



15kV snubber (compact) next to  
MV switch to transformer

**EATON**  
Powering Business Worldwide

79

## Casino - horizontal mount



12.47kV snubber mounted horizontally above transformer  
78" L x 45" W x 24" H



80

## Snubber - horizontal mount

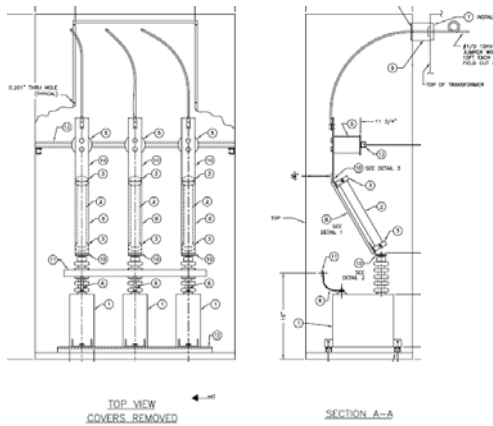

12.47kV snubber mounted horizontally above transformer



81

## Office Building – top hat

- This 15 kV design was mounted above the MVS. The resistors had not been installed.  
36”L x 54”D x 45”H.



82

## Snubber - top hat

- Note the fuse and resistor are mounted at angle
- contains the high frequency switching transients.

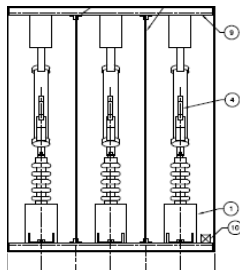

FRONT VIEW

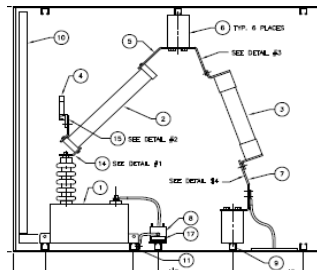

RIGHT SIDE VIEW



83



## Ferry Propulsion System – 5 kV Snubber

- Install within an existing transformer enclosure

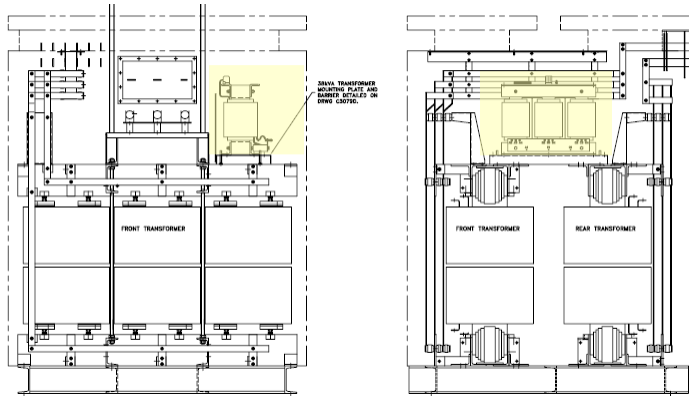

84

## Ferry Propulsion System – 5 kV Snubber

- Top view and side view – 32”L x 24”D x 24”H

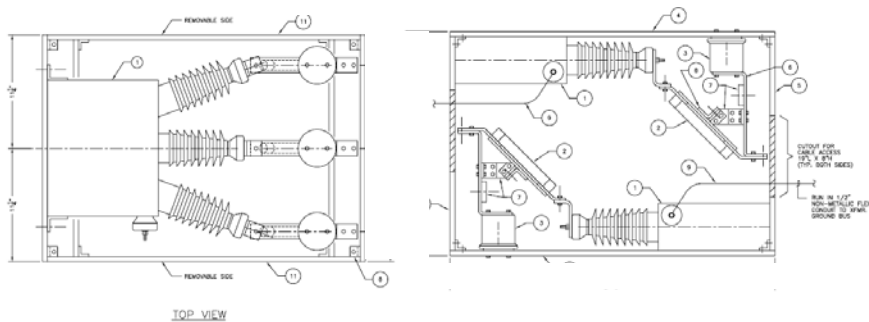

85

## Custom Designs – grounding considerations

- 13.8 kV solidly grounded system
  - VCB retrofit for load break switch
  - 3-phase surge cap
- 13.8 kV low resistance grounded
  - VCB retrofit for Load break switch
  - 1-phase surge cap
  - 2 x resistors in parallel
- 13.8 kV low resistance grounded
  - new VCB
  - New 13.8/2.4kV 7500 KVA transformer
  - 1-phase surge caps and single resistors



86

## Design Options – Detect Functionality

- **None (oversized and treated like a lightning arrester)**
- Glow tube indicators
  - visible through a window in the switchgear door
  - provide a visual indication of snubber continuity
- Current sensors
  - monitor the continuity of the resistor and fuse
  - alarm on loss of continuity
- fused protection
  - Mandated by some industries
  - alarm signal can be sent to the plant DCS or SCADA system
  - alert the operating personnel that these snubber components have failed



Glow Tube



Current Sensor



87

## Design Options - Fuse Blown Detection

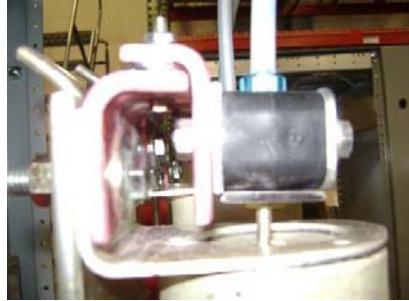
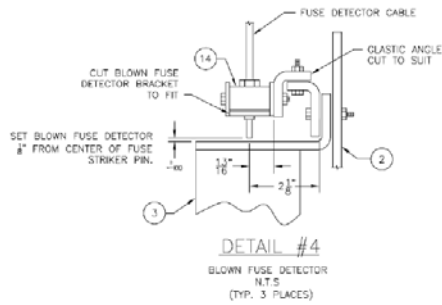

- The fuse striker pin operates a mechanical linkage and operates a micro switch when the fuse blows.



88

## Snubber Performance Measurements

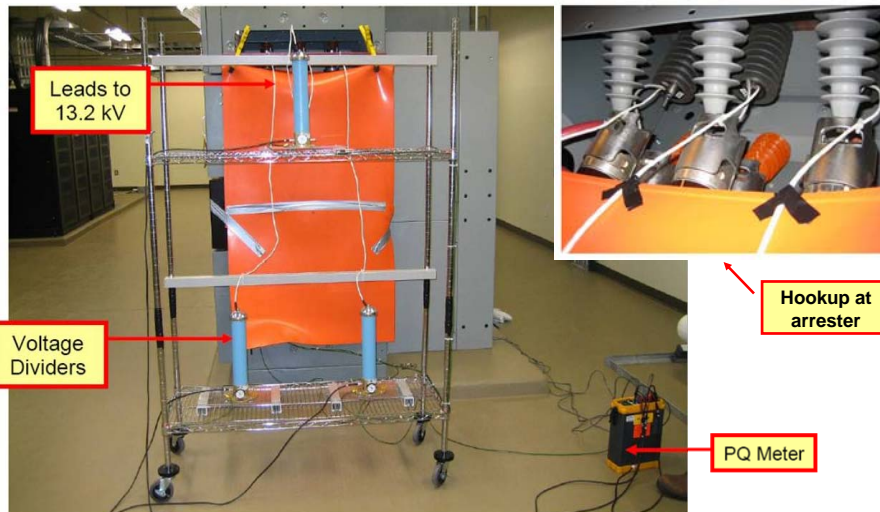

89

## Test Procedure

- Test Procedure required by contractor
- Prepared 2 weeks in advance of testing
- Develop instructions for site personnel
- Included safety briefing each day
- Site specifics supplied by the contractor
  - LO/TO instructions
  - Breaker operations
- All meter connections made de-energized & LO/TO
- No one in transformer room during tests
- Signature of “Responsible Engineer” before test
- See detailed test procedure form



90

## Test Equipment

- Test equipment included voltage dividers and a transient recording device
- Voltage Dividers
  - Capacitive and resistive elements
  - 10MHz frequency response
  - SF6 insulated
- Three-Phase Power Quality Recorder
  - transient voltage waveshape sampling
  - 8000 Vpeak full scale, 200 nsec sample resolution
  - 5 Mhz sampling



91

## Voltage Divider Connections

- Highly stranded No. 8, 15 kV insulated hookup wire requested (10KV DC supplied)
- Insulated wire was a precaution – could have used bare conductor
- maintained 8inch minimum separation for 15kV between phases and ground
- Routed wires with gradual curve – no 90 degree bends
- Connection at surge arrester at bus to transformer primary windings



92

## Measurements – Energize & De-energize

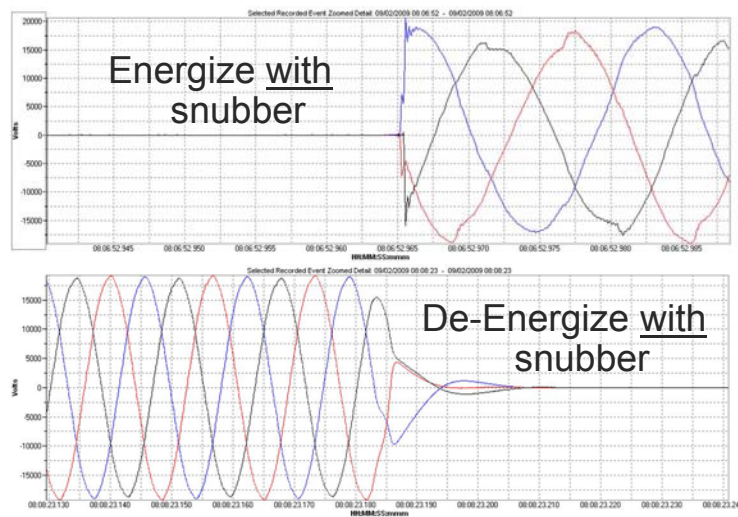

93

## Special Measurements – Electric Arc Furnace



Voltage Dividers Installed at Primary Bushings of Transformer



PQ Meter and Test Leads



94

## EAF Measurements – Energize

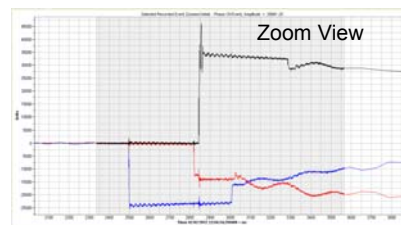
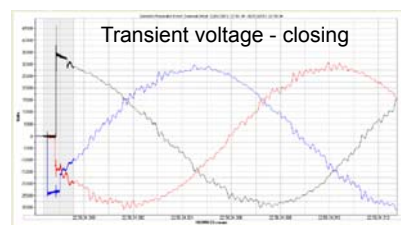
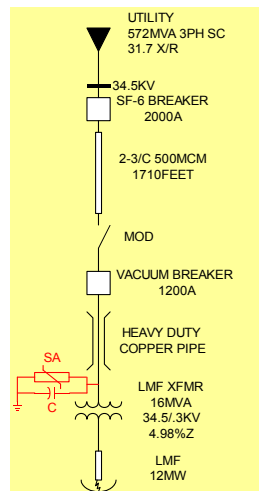

95

## EAF Measurements – Prestrike on closing

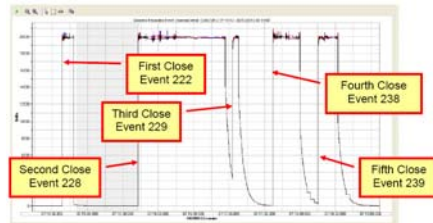

- 5 open/close operations in less than 4.5 min. !!!

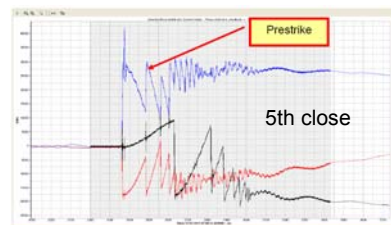

## Conclusions

- This is a System Problem
  - Transformer, Cable, Switching Device, Proximity
  - Statistical Event , Possible Undetected Failures
- **Highest Risk Category**
  - High Power Density
  - Close Proximities
  - Frequent Switching
- Other industries also at risk
  - oil, paper, chemical, hospitals, propulsion, etc.
- Lives, Property and Uptime are all at risk

## Conclusions

- Switching Transients Study
  - Quantifies Problem
  - Predict Exposure / Risk
  - Select Best / Most Cost Effective Solution
  - Do “What if” Cases
  - Verify Results

## Conclusions

- Factor into Design Up-front
- Do Study – Results Are Breaker Manufacturer Specific
- Use Protection Only When / Where Needed (if not there, cannot fail)
- Fused or Unfused Snubbers?
- Loss of Fuse Detection?
- Discrete Snubber Components?
- Fear Not! - Mitigating Techniques Have Been Proven



## Conclusions

- “Rule of Thumb” - Vacuum breaker, short cable or bus and dry type transformer (aged or low BIL liquid filled)
  - Not all VCB primary switching of transformers require snubbers
  - Transformer failures due to primary VCB switching transients do occur
  - Current chop and re-ignition combine with unique circuit parameters
- RC Snubbers
  - plus arresters mitigate the transient
  - Retrofits require custom design of snubber
  - Field measurements confirm snubber performance



### **3.0 PT & CPT FAILURES, ANALYSIS, SOLUTIONS**

This section contains copies of the power point slides used during the presentation. The slides have been printed for convenience of note taking.

Note: This page intentionally left blank.



## Part 2 - Potential Transformer and Control Power Transformer Failures, Analysis & Solutions

David D. Shipp, PE  
Fellow, IEEE  
Capstone Engineering  
3300 Tarr Hollow Rd.  
Murrysville, PA 15668

Thomas J. Dionise, PE  
Senior Member, IEEE  
Eaton Electrical Group  
130 Commonwealth Dr.  
Warrendale, PA 15086

IEEE Houston CED  
February 9-10, 2016

### Introduction

- PTs and CPTs applied in system designs not seen 10 years ago
- PSE has investigated nearly 150 PT and CPT failures in past 3 years alone
- Failures may take hours, days or weeks to be detected
- Across all voltages – 5kV, 15kV, 25kV and 35kV
- Failures not unique to any one manufacturer
- Failure modes
  - Ferroresonance, Internal Resonance & Transient Overvoltage
- Solutions
  - damping resistors, snubbers, others

## PT failure – damage limited to PT

- PTs and CPTs applied in new 26.4kV system
- Failed during commissioning

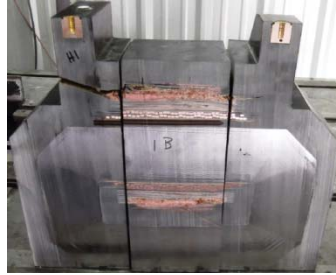

3

## PT failure – catastrophic

- PTs applied in new 34.5kV system
- Failed shortly after startup and commissioning



4

## Transformer cross section

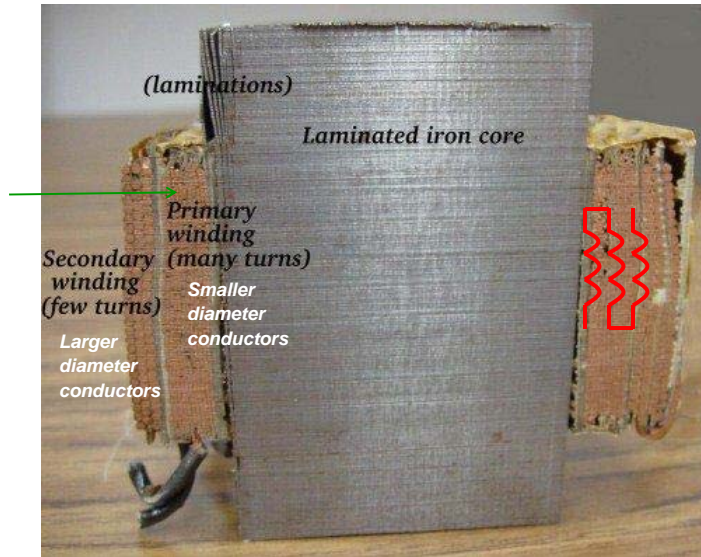

**EATON**  
Powering Business Worldwide

5

## Ferroresonance phenomenon and the PT

- When the source of current is interrupted, the trapped **dc** charge on the cables (capacitance) discharges into the PT.

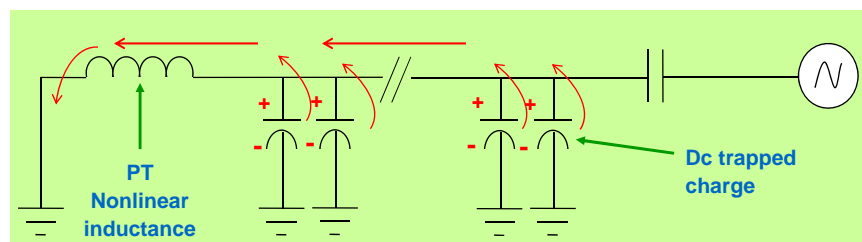
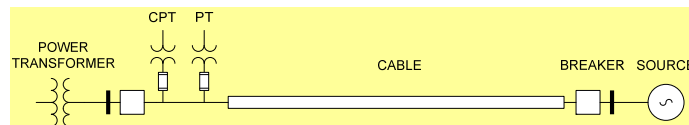

**EATON**  
Powering Business Worldwide

6

## System simplified diagram

- The primary system circuit can be further simplified by lumping the system capacitance into a single representative capacitor and representing the inductance of the transformer as multiple smaller inductors in series.

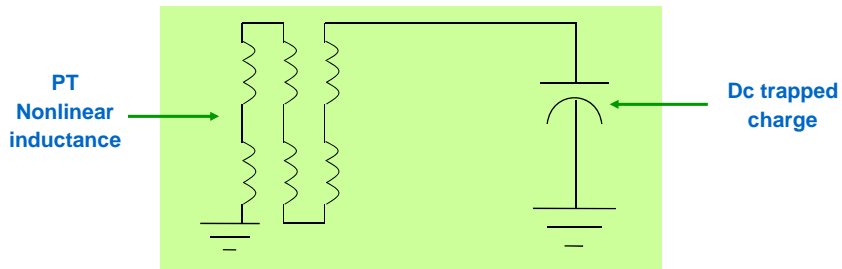

## Excitation curve for PT

- Referring to the excitation diagram, one can see that it takes very little overvoltage to drive significantly higher excitation current through the thin primary conductors.
- With a turns ratio of 208/1, for only a 50% increase in voltage (180 V), the primary excitation current alone is 0.06 A (i.e. 13.346 / 208) – or the full load rating of the primary winding.

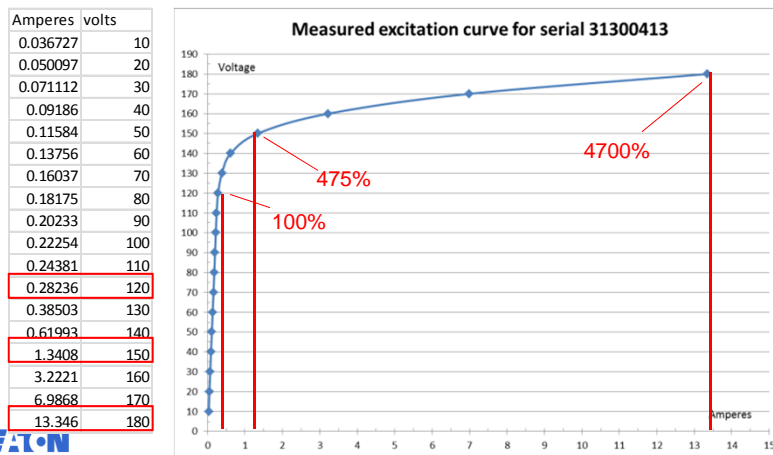



## Insulation failure

- The over voltage across the primary winding is not equally distributed, resulting in high stress voltage differences across some of the windings.
  - If the voltage difference between winding is in excess of their dielectric/insulation limits...

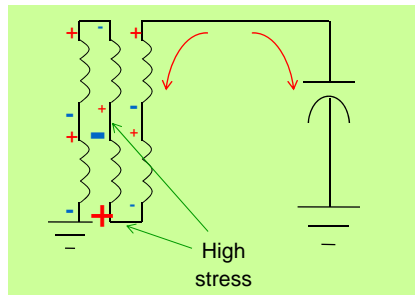

## Insulation failure

- When the dielectric rating of the insulation is exceeded, adjacent windings short together, heat and pressure build-up, and the VT housing ruptures.
- Could take days to weeks before the external evidence occurs.



## Special Condition: Case 15 PT failures Midwest Data Center

- 12.47 kV System / 120 MW Load
- Bkr Pairs with Unloaded wye-wye PTs for Auto Transfer Sensing at Load End of Cables
- Multiple Open and Closed Operations were Performed Preceding the Failure.
- 1<sup>st</sup> failure – Smoke But fuses did not Blow – Cleared Manually.



11

## Case 15 Midwest Data Center

- 2<sup>nd</sup> Failure – Identical Switching Events
- Open Transitioned Back to Source “A”
- A few Minutes Later A Load “Pop” Was heard.
- More Smoke + B Phase Fuse Blew
- Measurements Were Taken – Snuck Up on Problem without PT Loading – Risked Failure



12

## Case 15 Data Center Illinois – PT Ferroresonance

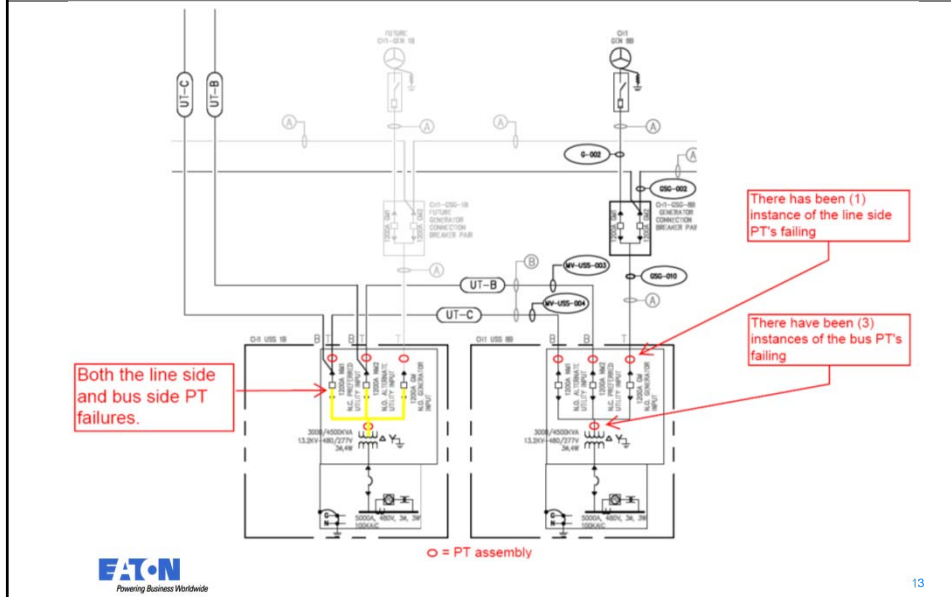

## Special Condition: PT Ferroresonance

- upstream circuit breaker opens
- a DC trapped voltage is left on the open cable
- saturates the transformer magnetizing impedance
- results in erratic voltage waveform
- Low current – fuse does not blow
- oscillation will last for a long period of time until eventual failure of the PT
- PT failure may be immediate or may occur over time after many exposures
- PT ferroresonance may also be called PT saturation



## Special Condition: PT Ferroresonance

- 12.47 kV System / 120 MW Load
- Bkr Pairs with Unloaded wye-wye PTs for Auto Transfer Sensing at Load End of Cables
- Multiple Open and Closed Operations were Performed Preceding the Failure.
- 1st failure – Smoke But fuses did not Blow – Cleared Manually. 2nd Failure – Identical Switching Events
- Open Transitioned Back to Source “A”
- A few Minutes Later A Load “Pop” Was heard.
- More Smoke + B Phase Fuse Blew
- Measurements Were Taken – Snuck Up on Problem without PT Loading – Risked Failure



## Data Center Illinois – PT Ferro-Resonance Switched Utility Off – Source Side PTs

- No Snubber
- 170 kV peaks
- 22 kHz
- 20 HZ Ferro
- Open Delta

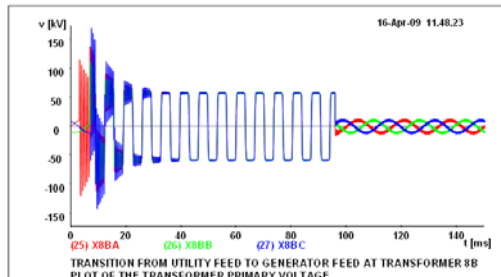

- With Snubber
- 2000 HZ
- No Ferro R

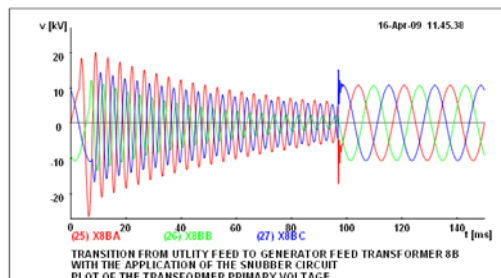

16

## Data Center Illinois – PT Ferro-Resonance Zoom of Previous Slide

Transition from utility to gen (utility breaker opening)

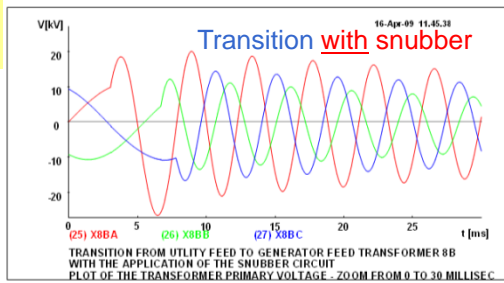
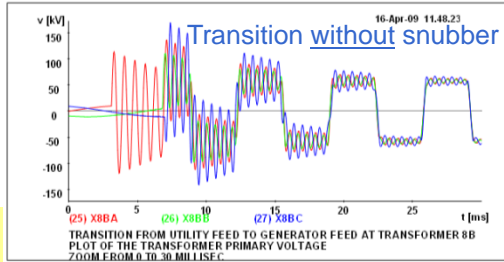

17

## Data Center Illinois – PT Transient Voltage Wye-Wye Load Side PTs / 3 MVA - Closing

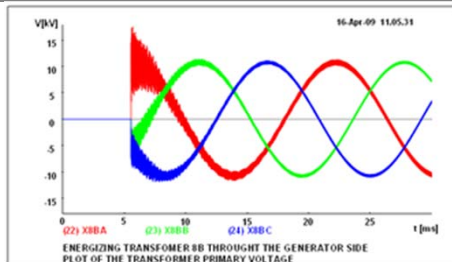

- Close Gen Breaker Without Snubbers

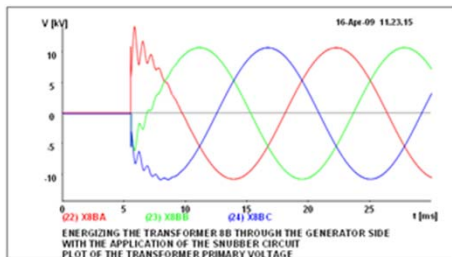

- Close Gen Breaker With Snubbers



18

# Data Center Illinois – PT transient overvoltage

De-Energize without snubber

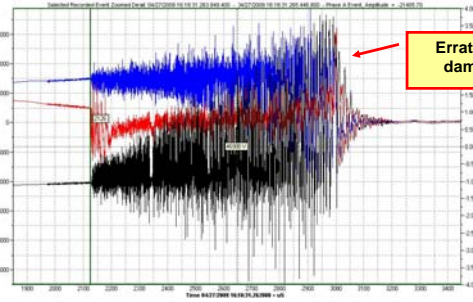

De-energize with snubber

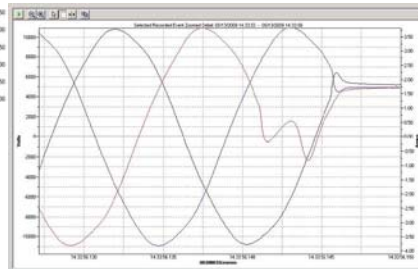

# PT transient overvoltage on Energization

Energize without snubber

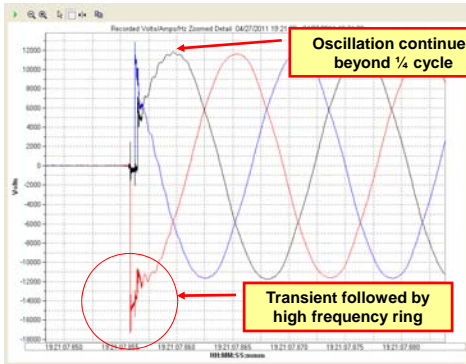

Energize with snubber

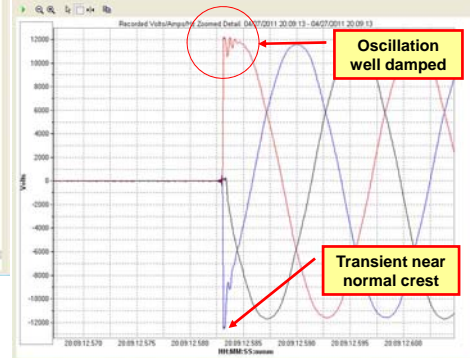

## Special Condition: PT Ferroresonance – Damping Resistor Commercial Bldg – NY City

- Corrective measures:
  - RC snubber
  - **Damping resistor**

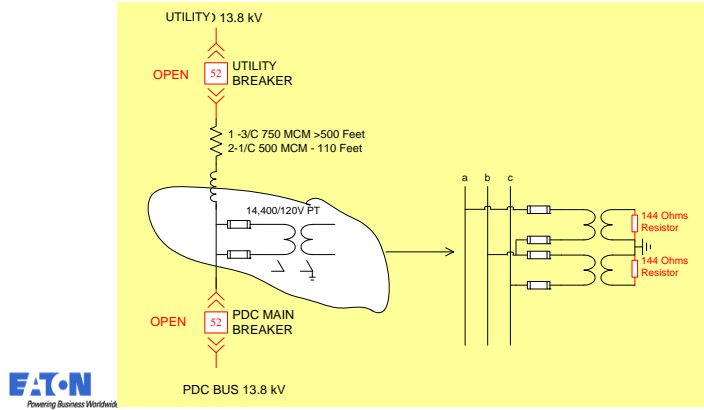

**EATON**  
Powering Business Worldwide

21

## PT Ferroresonance – Damping Resistor

De-energize  
without  
damping R

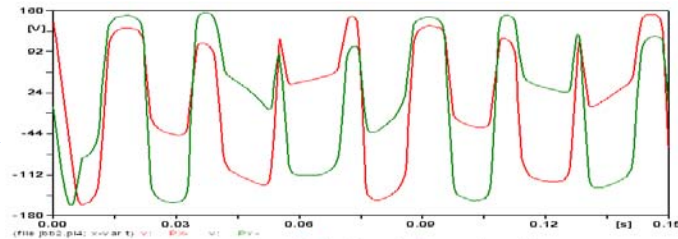

De-energize  
with  
damping R

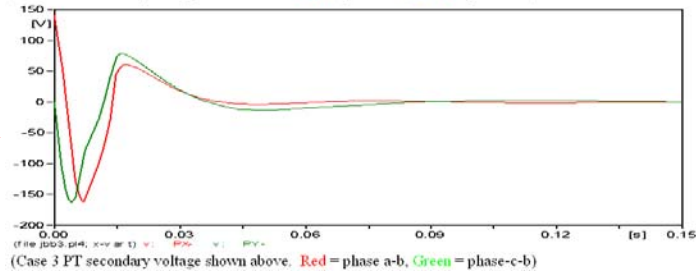

**EATON**  
Powering Business Worldwide

22



## Cogen Facility Special condition: VT Ferroresonance

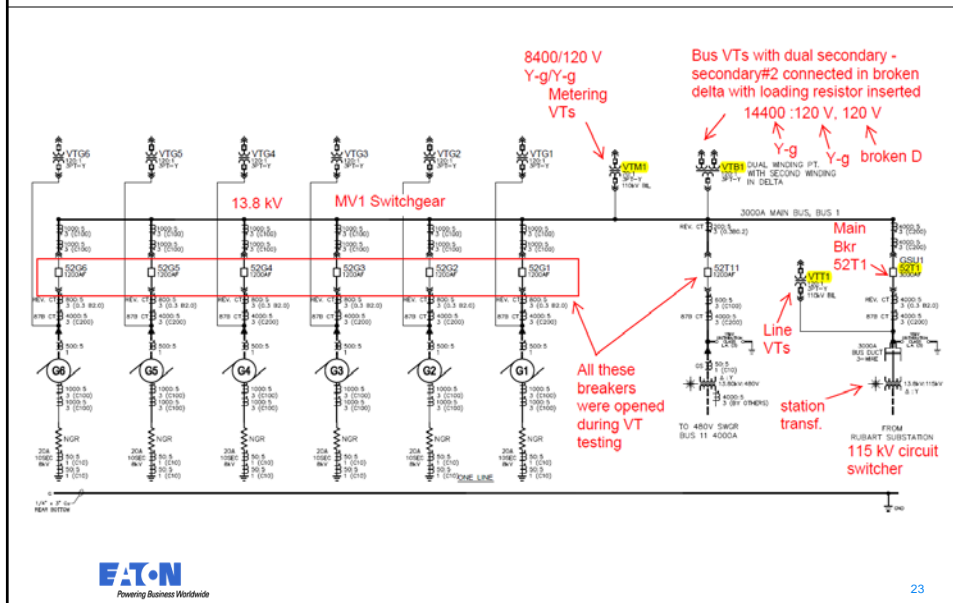

## Cogen Facility PT ferroresonance – closing of main breaker

20140319 MV2 (VTT2 Closing 52 T2\_Bus PT racked\_in\_meter PT racked\_in\_VTB2 burden 79.7 ohms\_VTM2 primary and secondary fuses installed and meter test switches open)

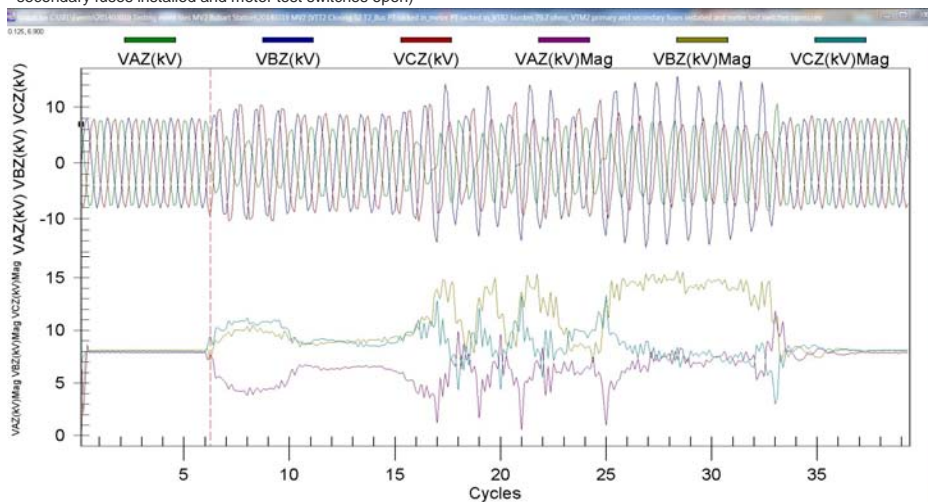



## Cogen Facility PT ferroresonance – opening of main breaker

20140319 MV2 (V0 trip\_VTT2 Tripping 52 T2\_Bus PT racked in\_meter PT racked in\_VTB2 burden 79.7 ohms\_VTM2 primary and secondary fuses installed and meter test switches open\_2)

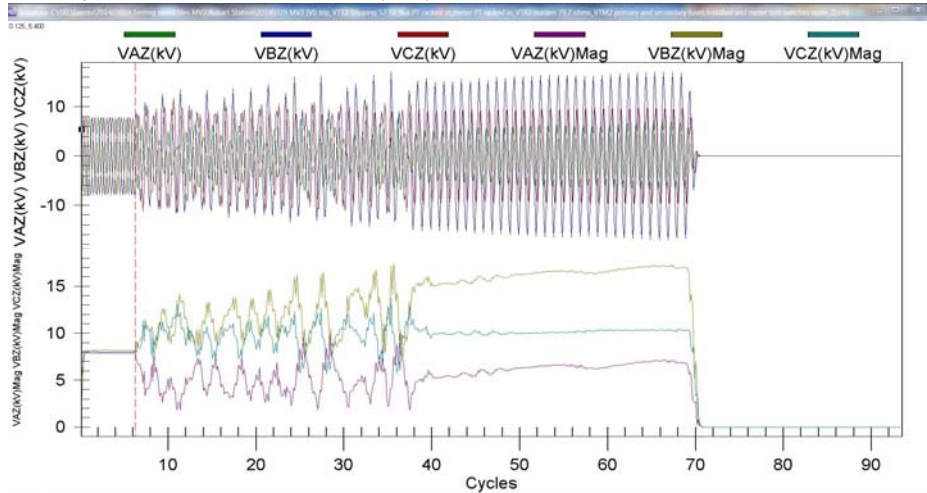

**EATON**  
Powering Business Worldwide

25

## Cogen Facility PT ferroresonance – closing of main breaker

20140321 MV2 (VTT2 Closing 52 T2\_Bus PT racked in\_meter PT racked in\_VTB2 burden 79.7 ohms\_VTM2 (14400 to 120) primary and secondary fuses installed and meter test switches open\_2)

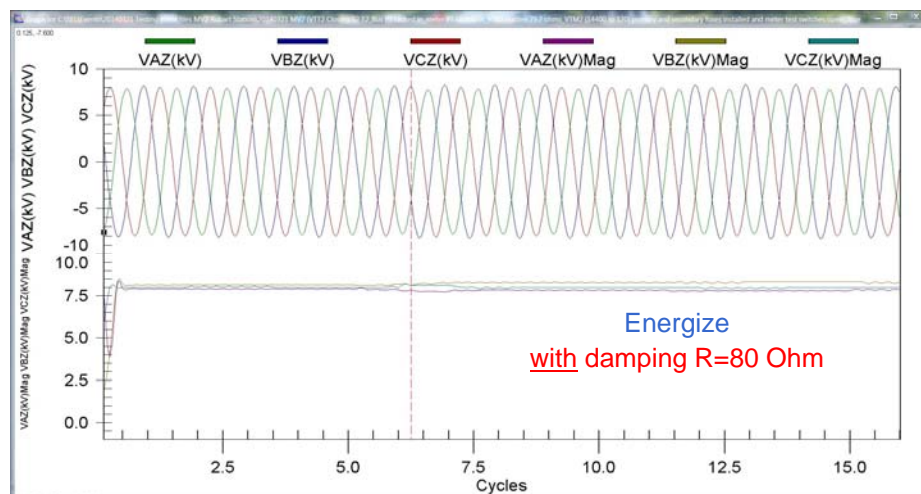

**EATON**  
Powering Business Worldwide

26

## Cogen Facility PT ferroresonance – opening of main breaker

20140321 MV2 (VTT2 Tripping 52 T2\_Bus PT racked in\_meter PT racked in\_VTB2 burden **79.7 ohms\_VTM2 (14400 to 120)** primary and secondary fuses installed and meter test switches open)

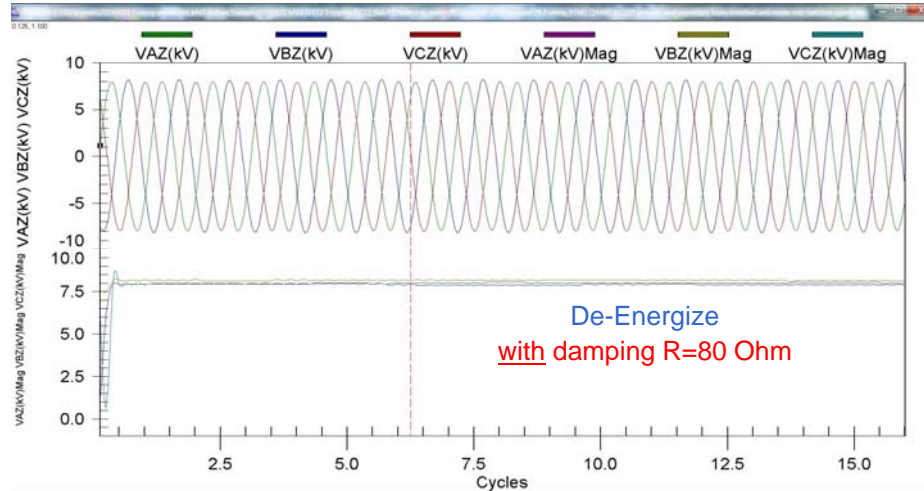

**EATON**  
Powering Business Worldwide

27

## Data Center Wyoming VT failures

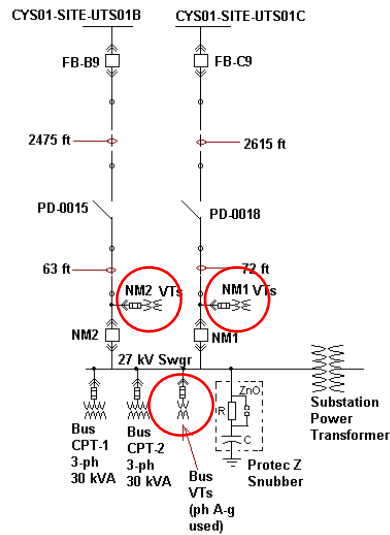

- Two line-end VTs at 24.9 kV in the switchgear failed on Nov. 18, 2013 which initiated our investigation
- During the investigation, the bus VTs for the same gear failed on Dec. 28, 2013.

**EATON**  
Powering Business Worldwide

28

# Line-end VT failures



29

# Line-end VT failures



30

## Bus VT failures



Powering Business Worldwide

31

## Solutions

- The desired solution is to only apply increased loading on the transformer during the condition in which it would go into ferroresonance.
- The **saturable reactor** on the secondary side of the vt only conducts current when the voltage begins to increase above its saturation voltage – but below that of the vt's saturation voltage.
- An “off the shelf” reactor was initial used for testing, but produced worse results since it saturated below the secondary operating voltage of the vt – premature saturation.

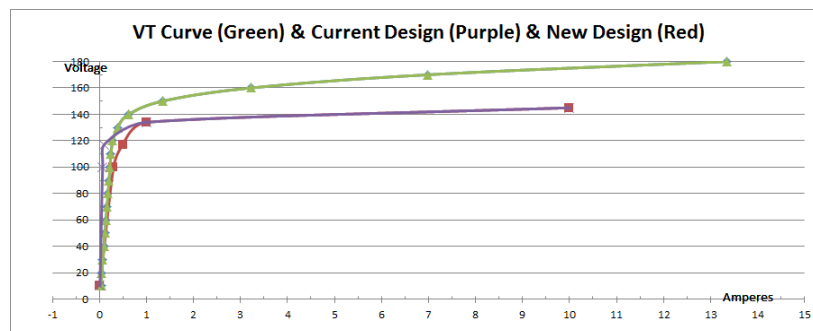

EATON  
Powering Business Worldwide

32

## Saturable reactor circuit

- The **reactor** is sized such that as  $V_s$  increases, the reactor saturates just before the  $v_t$ . It is designed to absorb the high excitation current and act as a switch to insert its internal resistance.
  - In addition to matching the magnetic characteristics to the specific  $v_t$ , the reactor's internal resistance is "tuned" to the system parameters for critical damping.
  - Since the reactor saturates before the  $v_t$  and inserts its resistance into the secondary circuit, the  $v_t$  never goes into saturation.
  - Eaton's modeling was used to direct ABB how to optimize the saturation characteristic and the resistance value.
- The high secondary current is reflected back into the primary, but it is such a short duration that it does not overheat the primary windings.

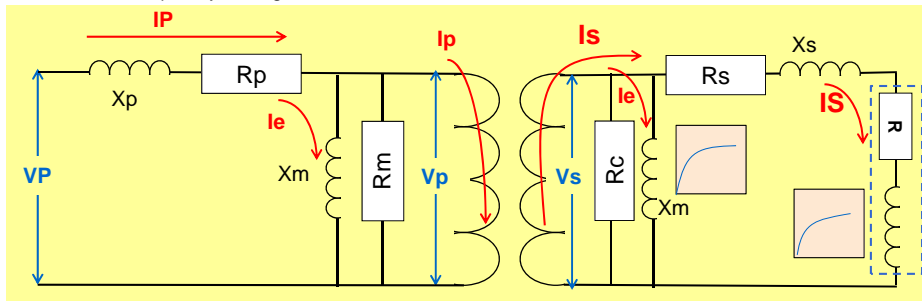

**EATON**  
Powering Business Worldwide

© 2014 Eaton. All Rights Reserved.

33

## University Campus VT failures

- Line-end open-delta PTs at 34.5 kV in the switchgear failed on Oct. 3, 2014 which initiated our investigation
- PTs failed catastrophically taking out switchgear bus and breaker
- Collateral damage to switchgear room

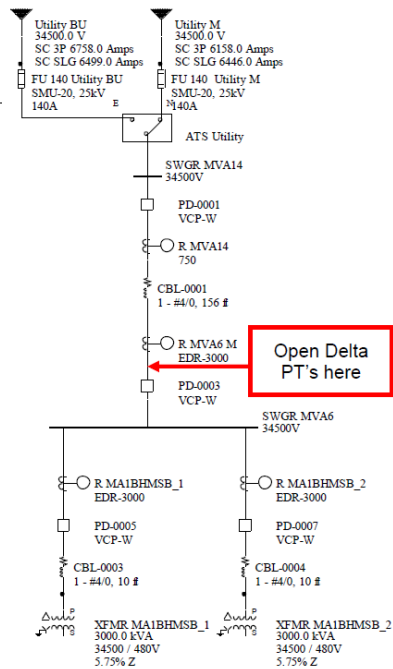

**EATON**  
Powering Business Worldwide

34

## University Campus PT failure – catastrophic

- PTs applied in new 34.5kV system
- Failed shortly after startup



**EATON**  
Powering Business Worldwide

35

## University campus – solutions for PT

- Install snubber  $R=50\text{ohm}$ ,  $C=0.125\mu\text{F}$ , 34.5kV
- Install new Yg Yg PTs with damping resistors

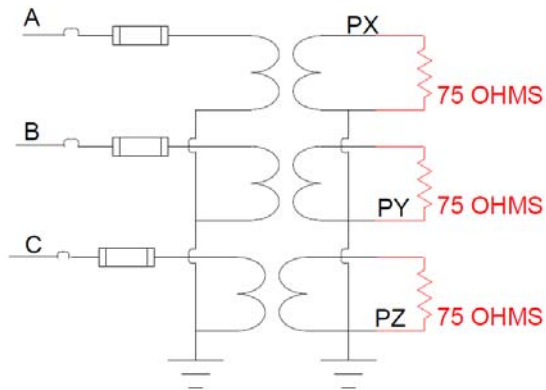

**EATON**  
Powering Business Worldwide

36



## Nano Chip Facility CPT failures: Ferroresonance and dV/dt

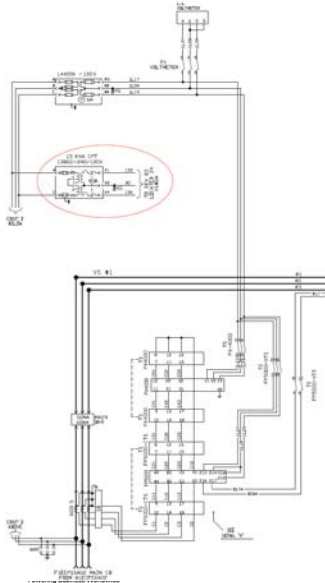

- 13.8kV circuit experienced CPT failure on December 3, 2012 at approximately 3PM.
- CPT failure occurred in 13.8kV switchgear F1ECPSSA02, which is supplied approximately 1500 feet away by breaker F1ECPSSA02 in switchgear H1ECPSSA02.
- CPT was located immediately on the line side of the incoming main breaker of switchgear F1ECPSSA02.
- The CPT failure began as a line-to-ground fault and quickly escalated to a double-line-to-ground fault.
- This fault was successfully detected and cleared by breaker F1ECPSSA02 and its associated Eaton FP5000 protective relay.
- The FP5000 successfully captured and recorded the fault data
- **First of 5 CPT and VT failures.**

37

## Nano Chip Facility CPT failure: Ferroresonance and dV/dt

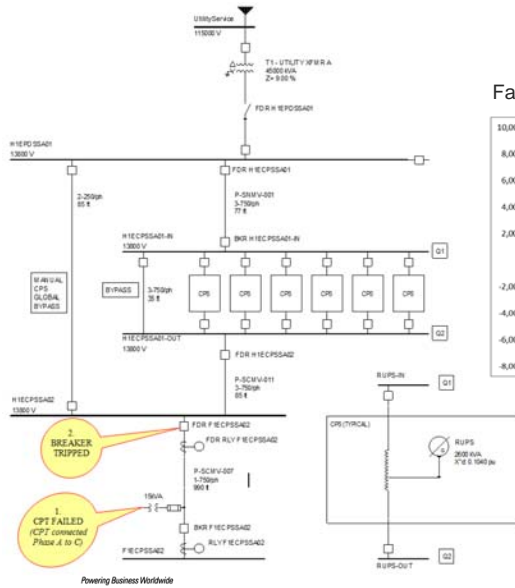

Fault Currents, Phases A, B, C, and Ground (IX)

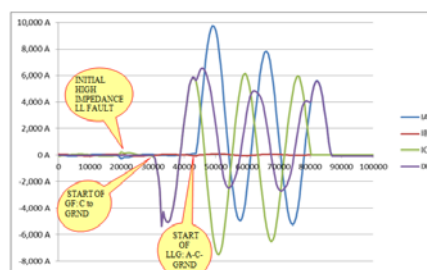

38

## Nano Chip Facility CPT failure: Ferroresonance and dV/dt



**EATON**  
Powering Business Worldwide

39

## Nano Chip Facility VT Ferroresonance

- The study showed ferroresonance could occur with the subject CPT.
  - Installing a **resistive load** on the secondary of the CPT solves the CPT Ferroresonance problem.
  - This **resistive load** provides sufficient damping to counter CPT ferroresonance during opening of the upstream VCB2.
- The analysis also showed that a high frequency, high dv/dt voltage transient could also occur on the 13.8kV line supplying the CPT during energization.
  - Applying the **RC snubber circuit** to the 13.8 kV circuit will reduce the magnitude, frequency, and dv/dt of the transient overvoltage that can occur during switching of the vacuum breaker

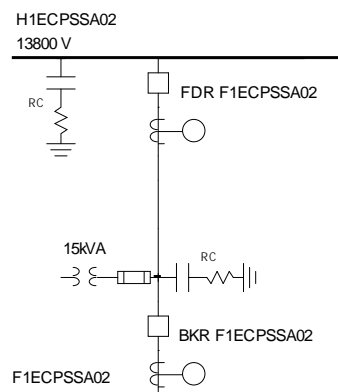

**EATON**  
Powering Business Worldwide

40



## Train Station - Primary Switch Three Line Diagram (Typical for Sub 6C and 7A)

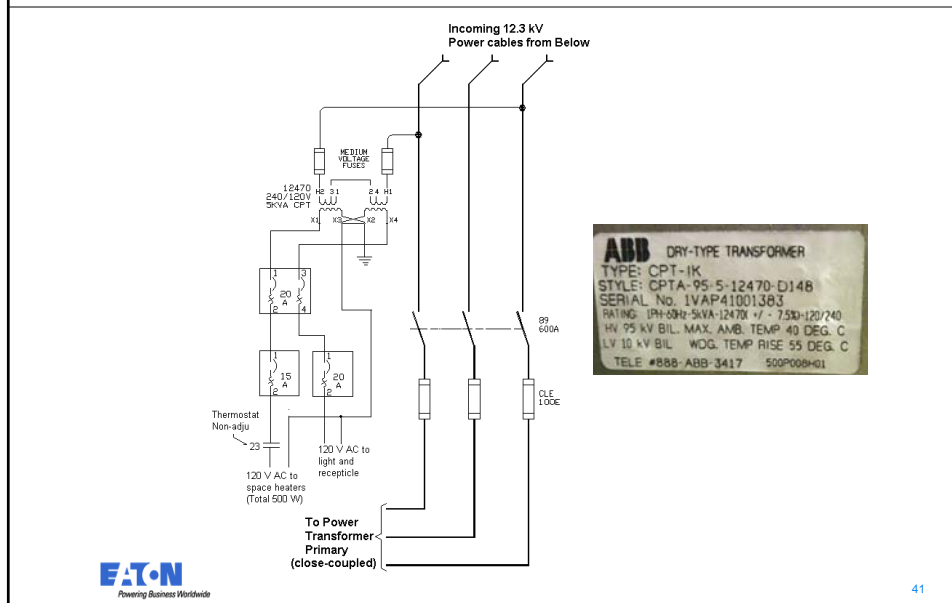

## Electrical Faults

- Electrical fault occurred in incoming cable compartments of MVS Sub 6C and Sub 7A.
- CPTs in both subs were connected on source side across phase A –C. Both CPTs were damaged.
- Both subs were being fed from the same utility source.
- Power Fuses installed in upstream utility equipment cleared the fault.

## Sub 7A – CPT Viewing from rear of the Switchgear

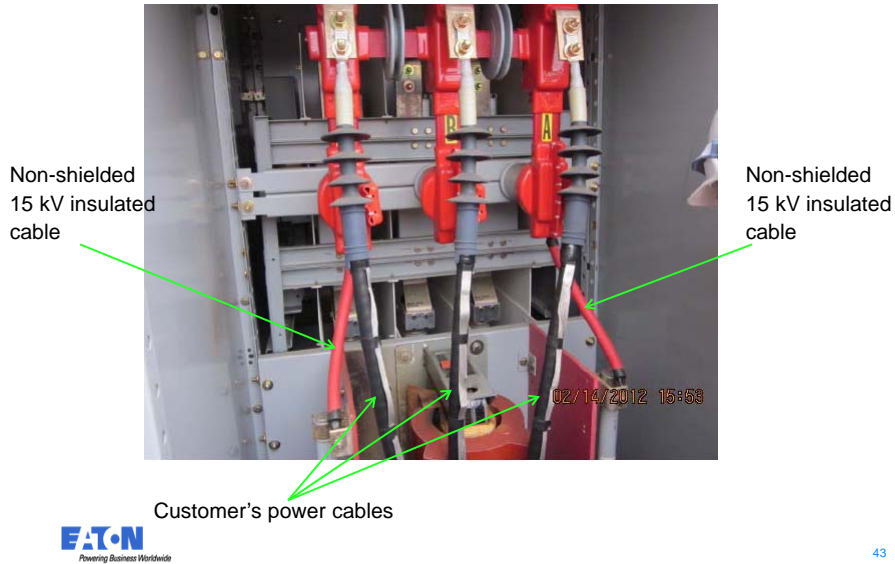

## Sub 6C – CPT Viewing from rear of the Switchgear

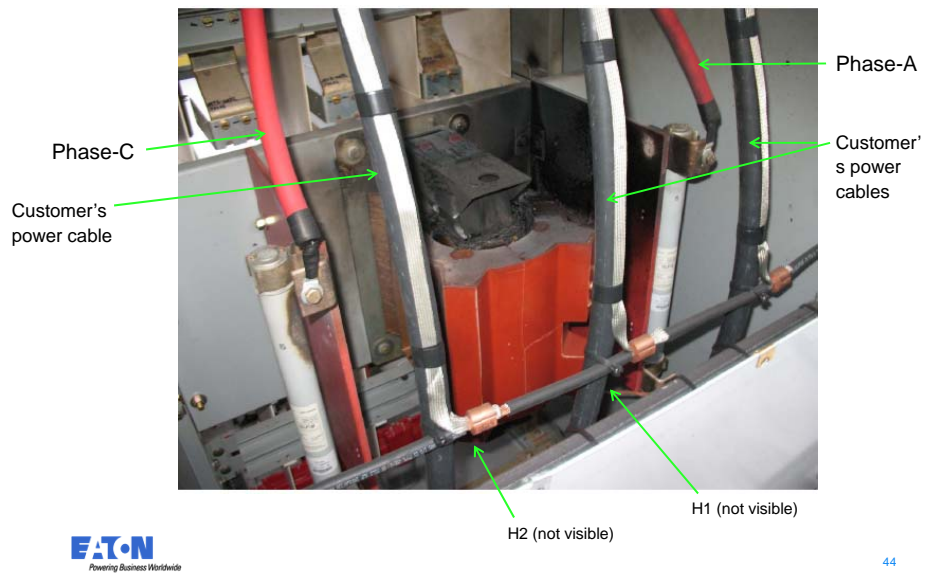

## Sub – 6C CPT Dissection at ABB

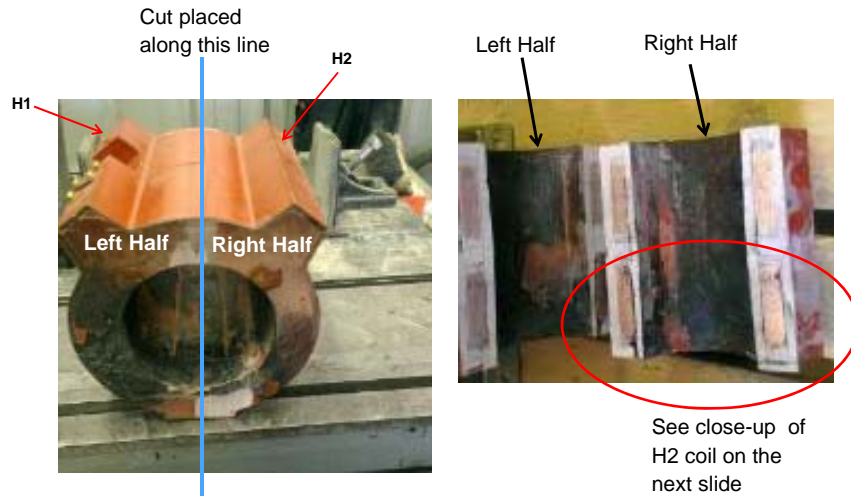

45

## Sub 7A – CPT Dissection at ABB

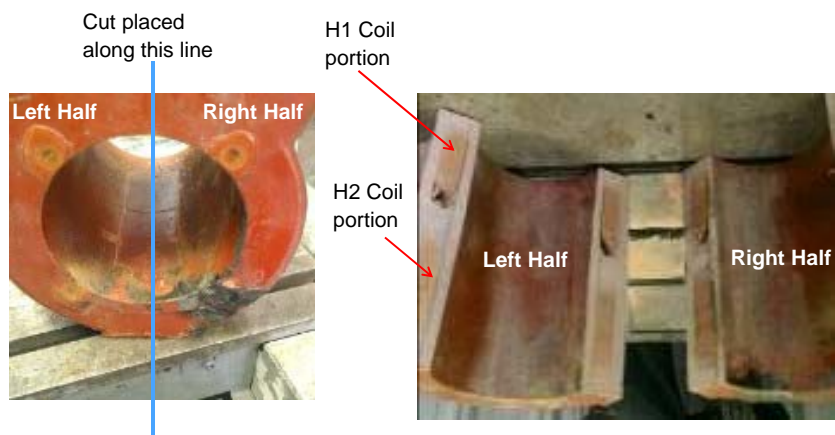

H1 Coil portion is seen damaged. Damage is located approximately in the middle of H1-H2 winding.



46

## Agricultural Chemical Plant CPT failure



**EATON**  
Powering Business Worldwide

- Site has experienced a blown CPT on the MVA less than 1 year from startup
- gear fed from 13.8Kv MV switch lineup next to the utility switchyard
- MV capacitors are located here
- Approximately 2800 ft. of cable from MV switches to MVA lineups
- CPT is rated 13800/240-120 V, 1-phase, 5 kVA

47

## Industrial Gas Facility CPT fuse failure due to sustained overload

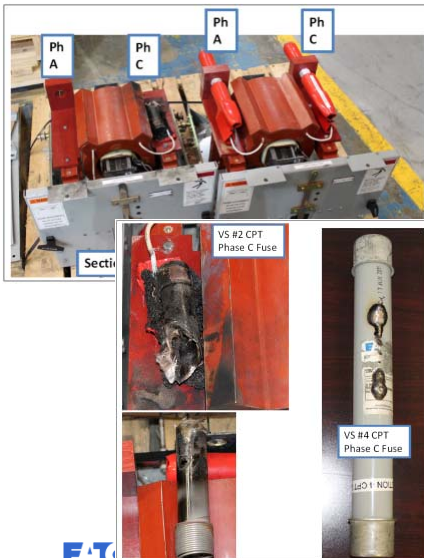

**EATON**  
Powering Business Worldwide

- 7/12 - Phase-C fuse failed in CPT drawer in Vertical Section #2. Fuse and some parts were replaced, CPT tested OK and put back in service.
- 11/12 - The CPT drawer in Section 2 had another catastrophic failure of the C Phase fuse. Also, the CPT in Section 4 blew a fuse on the C phase at the same time
- Findings: Fuses failed due to sustained low level overload.

48

## Pumped Hydro Station – PT Failures

- 2 x 13.2 kV transformer busses
- 2 x 140 MVA generator/motor per bus
- common SFC starting system capable of starting any of the 4 motor/generators
- synchronizing and paralleling of MG to the transformer bus.
- No. 1 Bus Down River is 560 MVA
- No. 2 Bus Up River is also 560 MVA.

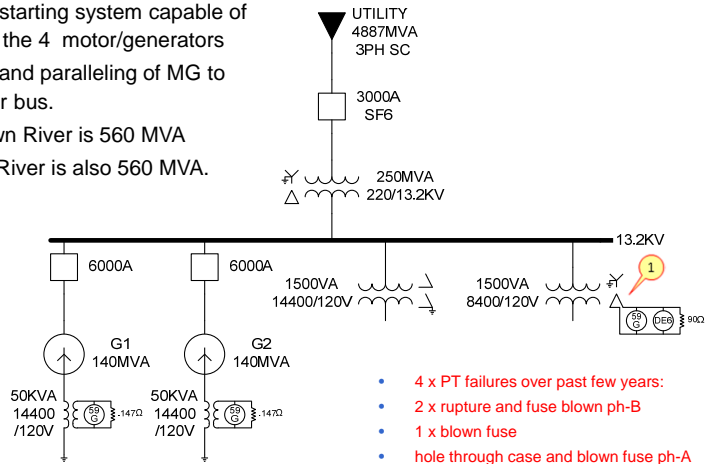

- 4 x PT failures over past few years:
- 2 x rupture and fuse blown ph-B
- 1 x blown fuse
- hole through case and blown fuse ph-A

**EATON**  
Powering Business Worldwide

49

## Pumped Hydro Station Existing Saturable Reactor & Resistor

Close 230KV breaker with & without saturable L and R

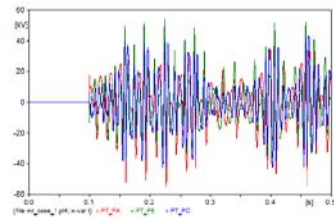

Open 230KV breaker with & without saturable L and R

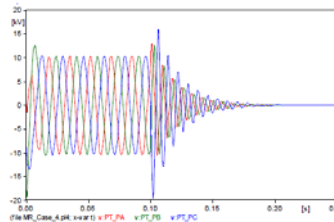
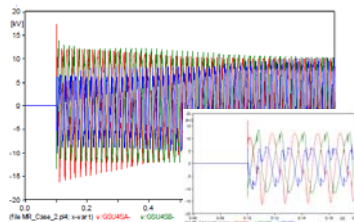
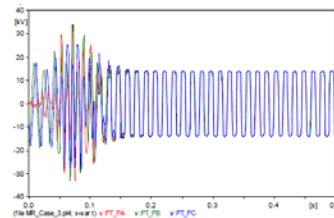

**EATON**  
Powering Business Worldwide

Wye-broken Delta Transformer with Saturable R and L

50

## Pumped Hydro Station Solution: Grounding Transformer with HRG

Close 230KV breaker with & without grounding transformer

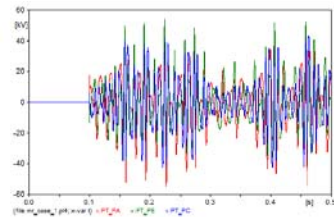

Open 230KV breaker with & without grounding transformer

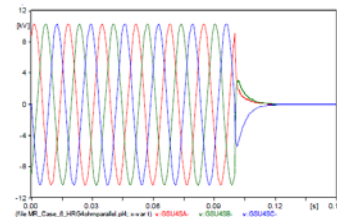
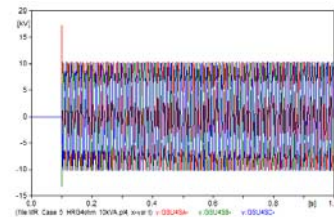
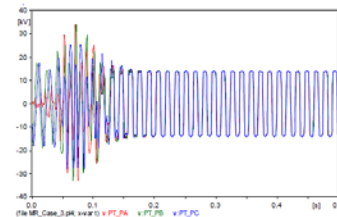

Grounding Transformer: Wye-broken Delta 1.4A

51

## Pumped Hydro Station Solution: Grounding Transformer with HRG

- Removed wye-grounded / broken-delta PTs from the Transformer Busses Nos. 1, 2, 3 and 4.
- Installed grounding transformer wye-grounded 13.8 kV primary and broken delta 120V secondary.
- Connected 4 Ohm resistor in the broken delta to give about 1.3 A GF current at 13.8 kV.
- If GF occurs before the generator is connected, then it alarms but does not trip.
- When generator comes online, each generator is a source of about 15 A of GF current.
- If GF occurs with one or two generators online, then the GF is detected then cleared.

Parameter	Specification
KVA per phase	10
Impedance (%)	5
Vpri (Volts)	13,800
Vsec (Volts)	120
Resistance (Ohm)	4
Isec (Amps)	51.59
Ipri (Amps)	1.346

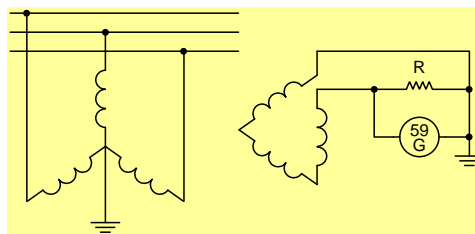

52

# New Data Center - Washington

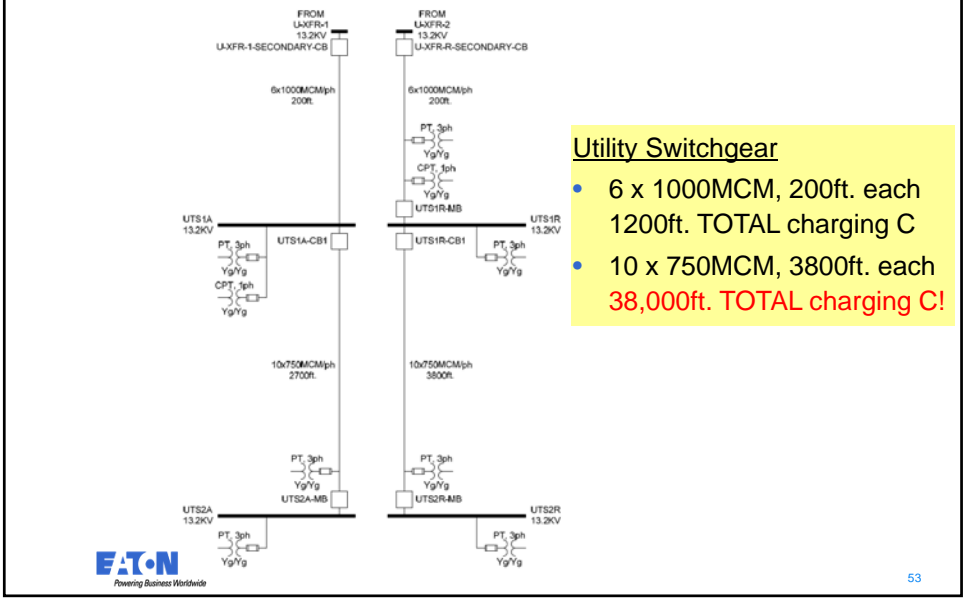

# New Data Center - Washington Solution: Damping Resistor

Open utility breaker with & without resistor on line-end PT

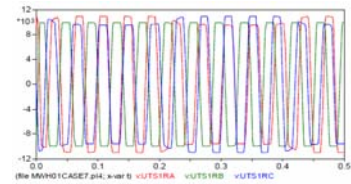

Open utility breaker with & without resistor on bus PT

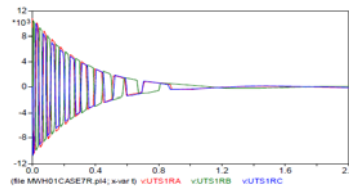
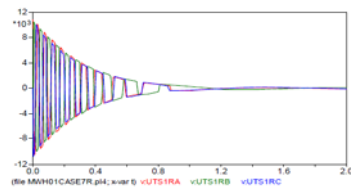
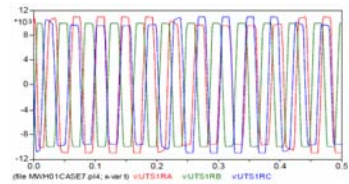



## New Data Center - Washington Solution: Snubber

Open utility breaker with &  
without snubber on line-end PT

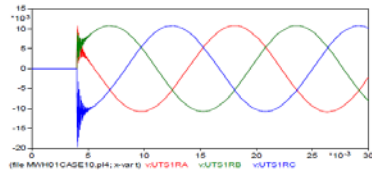

Open utility breaker with &  
without snubber on bus PT

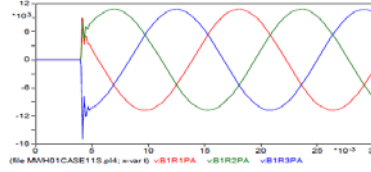
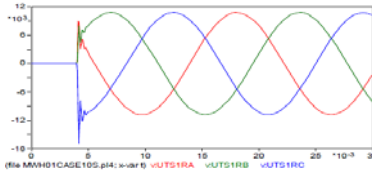
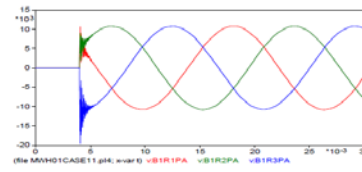

Line-End PT & Bus PT: snubber

55

## New Data Center - Washington Solutions: Damping Resistors & Snubbers

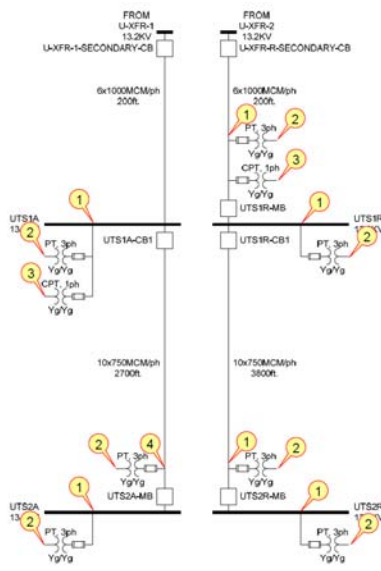

### SOLUTION

1. Add snubber 30 ohms & 0.5  $\mu$ F  
Add 10kV duty class surge arrester.
2. Add 333W resistors per phase\*
3. Add 1000W resistors per phase\*
4. Add snubber 30 ohms & 1 $\mu$ F  
Add 10kV duty class surge arrester

\*Note: Use a special designed circuit.



56



# New Data Center – Washington

## Damping resistors with optional switching

### PT & CPT Damping resistors

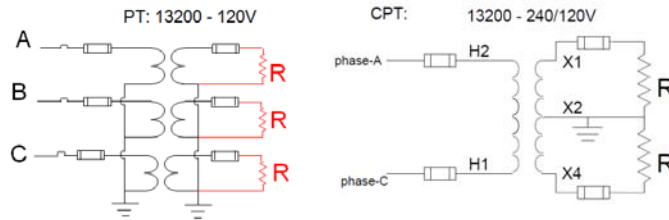

### PT & CPT Damping resistors - switchable

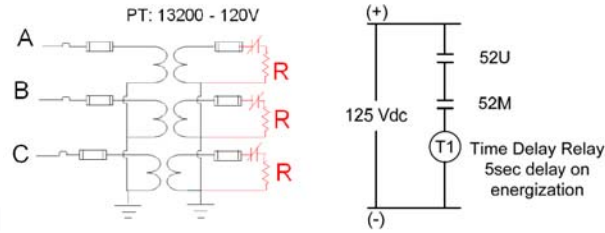

57

# Interstate Tunnel

## South Portal (North Portal similar)

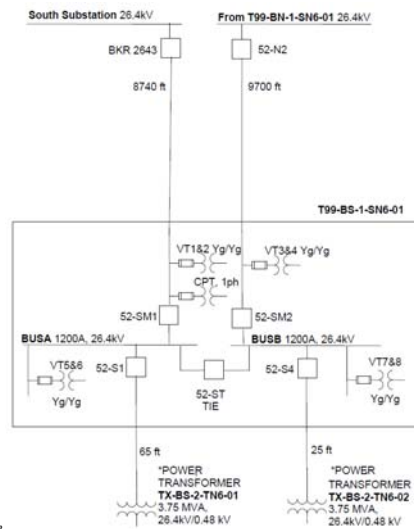

58

- TUNNEL OVERVIEW**
- 2 x utility feeders
  - O/H 26.4kV Line: **8740 Feet** 954kCM ACSR from South Substation
  - U/G 26.4kV Line: **1000 Feet** (2) 1000kCM Cu 28kV solid dielectric cable per phase, and **840 Feet** of 500kCM Cu 28kV solid dielectric cable per phase from Broad St. Substation.
  - Feeder 52-N2 to 52-SM2 consists of **9700 feet** of #2/0 cable.
  - Feeder 52-S2 to 52-NM2 consists of **9700 feet** of #2/0 cable.

## Interstate Tunnel Solution: Damping Resistor

Open utility breaker with &  
without resistor on line-end PT

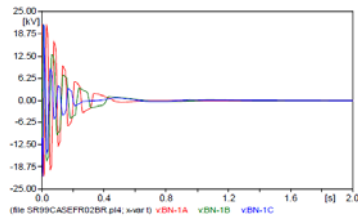
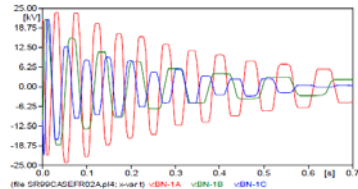

Open utility breaker with &  
without resistor on bus PT

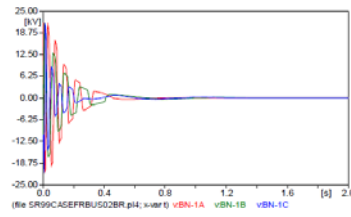
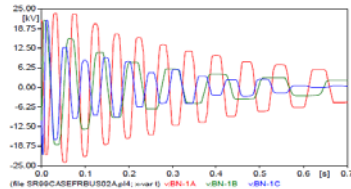

Line-End PT & Bus PT: damping resistor

59

## Interstate Tunnel Solution: Snubber

Open utility breaker with &  
without snubber on line-end PT

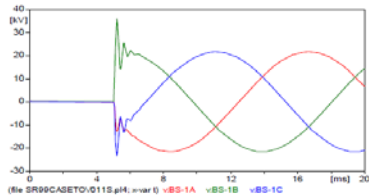
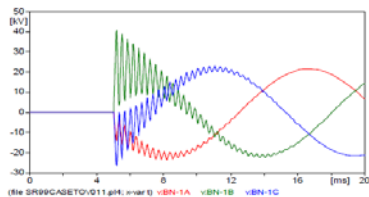

Open utility breaker with &  
without snubber on bus PT

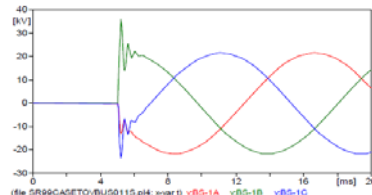
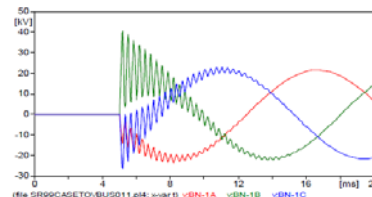

Line-End PT & Bus PT: snubber

60

## Interstate Tunnel Solutions: Damping Resistors & Snubbers

### South Portal (North Portal similar)

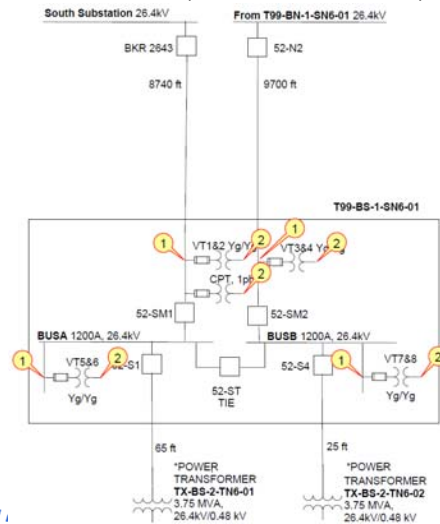

#### SOLUTION

1. Add snubber 150ohms & 0.5 $\mu$ F  
Add 21kV duty class surge arrester.
2. Add 750W resistors per phase

## Utility Substation Canada VT failure due to HV winding open circuit



- New 230kV substation suffered a VT failure at the 35kV level within the secondary SWGR.
- Occurred about 15 minutes after initial energization.
- The VT is for revenue metering within the utility compartment.
- Findings: The H2 connection to ground on the PT's was not made prior to energization. The PT's were energized with the HV winding open circuit!

## PT & CPT – Configurations of Concern

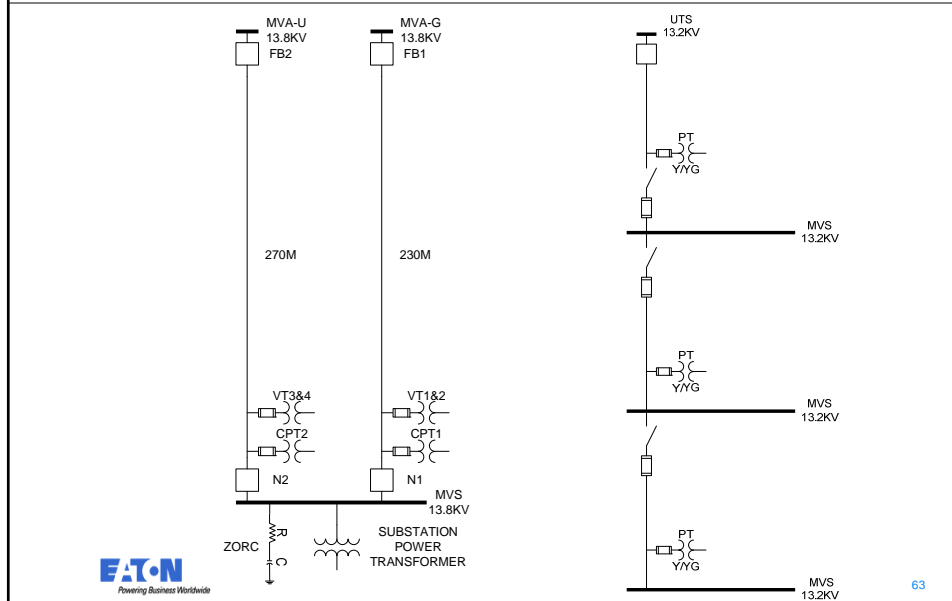

## Conclusions

- This is a System Problem
  - PT, Cable, Switching Device
  - Statistical Event , Possible Undetected Failures
- **Highest Risk Category**
  - PTs used at line-ends to detect available source
  - Frequent Switching
- Other industries also at risk
  - oil, paper, chemical, hospitals, propulsion, etc.
- Lives, Property and Uptime are all at risk

## Conclusions

- Switching Transients Study
  - Quantifies Problem
  - Predict Exposure / Risk
  - Select Best / Most Cost Effective Solution
    - Snubbers and Surge Arresters
    - Damping Resistors
    - Saturable inductor
    - Other
  - Do “What if” Cases
  - Verify Results



## 4.0 REFERENCES

This section contains references on the subject of switching transients and ferroresonance. A list of useful references is given to guide the reader through the study of the subject. Copies of recent IEEE papers by the presenters on the subject are also given.

### *Switching Transients*

1. Shipp, Dionise, Lorch and MacFarlane, "Transformer Failure Due to Circuit Breaker Induced Switching Transients", IEEE Transactions on Industry Applications, April/May 2011.\*
2. Shipp, Dionise, Lorch and MacFarlane, "Vacuum Circuit Breaker Transients During Switching of an LMF Transformer", IEEE Transactions on Industry Applications, January/February 2012.\*
3. Shipp, Dionise, Lorch and McDermit, "Medium Voltage Switching Transient Induced Potential Transformer Failures; Prediction, Measurement and Practical Solutions", IEEE I&CPS Conference Record, May 2012.\*
4. ANSI/IEEE, A Guide to Describe the Occurrence and Mitigation of Switching Transients Induced By Transformer And Switching Device Interaction, C57.142-Draft.
5. D. Shipp, R. Hoerauf, "Characteristics and Applications of Various Arc Interrupting Methods," IEEE Transactions Industry Applications, vol 27, pp 849-861, Sep/Oct 1991.
6. ANSI/IEEE, Standard for AC High-Voltage Generator Circuit Breakers on a Symmetrical Current Basis, C37.013-1997.
7. ANSI/IEEE, Application Guide for Transient Recovery Voltage for AC High-Voltage Circuit Breakers, C37.011-2005.
8. D. Durocher, "Considerations in Unit Substation Design to Optimize Reliability and Electrical Workplace Safety", ESW2010-3, 2010 IEEE IAS Electrical Safety Workshop, Memphis.

### *Ferroresonance*

1. IEEE Standard Dictionary of Electrical and Electronics Terms, ANSI/IEEE Std 100-1984.
2. Hopkinson, R.H., "Ferroresonant Overvoltages Due to Open Conductors," General Electric, 1967, pp. 3 - 6.
3. Westinghouse Distribution Transformer Guide, Westinghouse Electric Corp., Distribution Transformer Division, Athens, GA, June 1979, revised April 1986, Chapter 4 Ferroresonance, pp. 36 - 40.
4. IEEE Guide for Application of Transformers, ANSI/IEEE C57.105-1978, Chapter 7 Ferroresonance, pp. 22 – 28.
5. Distribution Technical Guide, Ontario Hydro, Ontario, Canada, May 1999, original issue May 1978, pp. 72.1-1 – 72.1-10.
6. Greenwood, A., "Electrical Transients in Power Systems", Wiley & Sons, 1971, pp. 91-93.
7. Kojovic, L., Bonner, A., "Ferroresonance - Culprit and Scapegoat", Cooper Power Systems, The Line, December 1998.

\*Note: Copies of these paperes are provided.



# Transformer Failure Due to Circuit-Breaker-Induced Switching Transients

David D. Shipp, *Fellow, IEEE*, Thomas J. Dionise, *Senior Member, IEEE*,  
Visuth Lorch, and Bill G. MacFarlane, *Member, IEEE*

**Abstract**—Switching transients associated with circuit breakers have been observed for many years. Recently, this phenomenon has been attributed to a significant number of transformer failures involving primary circuit-breaker switching. These transformer failures had common contributing factors such as the following: 1) primary vacuum or SF-6 breaker; 2) short cable or bus connection to transformer; and 3) application involving dry-type or cast-coil transformers and some liquid-filled ones. This paper will review these recent transformer failures due to primary circuit-breaker switching transients to show the severity of damage caused by the voltage surge and discuss the common contributing factors. Next, switching transient simulations in the electromagnetic transients program will give case studies which illustrate how breaker characteristics of current chopping and restrike combine with critical circuit characteristics to cause transformer failure. Design and installation considerations will be addressed, particularly the challenges of retrofitting a snubber to an existing facility with limited space. Finally, several techniques and equipment that have proven to successfully mitigate the breaker switching transients will be presented, including surge arresters, surge capacitors, snubbers, and these in combination.

**Index Terms**—Electromagnetic Transients Program (EMTP) simulations, *RC* snubbers, SF-6 breakers, surge arresters, switching transients, vacuum breakers.

## I. INTRODUCTION

TODAY, medium-voltage metal-clad and metal-enclosed switchgears that use vacuum circuit breakers are applied over a broad range of circuits. These are one of many types of equipment in the total distribution system. Whenever a switching device is opened or closed, certain interactions of the power system elements with the switching device can cause high-frequency voltage transients in the system. The voltage-transient severity is exacerbated when the circuit breaker operates abnormally, i.e., current chopping upon opening and prestrike or reignition voltage escalation upon closing. Such complex phenomena in combination with unique circuit characteristics can produce voltage transients involving energies

Manuscript received June 4, 2010; accepted July 9, 2010. Date of publication December 23, 2010; date of current version March 18, 2011. Paper 2010-PPIC-188, presented at the 2010 IEEE Pulp and Paper Industry Conference, San Antonio, TX, June 21–23, and approved for publication in the IEEE TRANSACTIONS ON INDUSTRY APPLICATIONS by the Pulp and Paper Industry Committee of the IEEE Industry Applications Society.

The authors are with Eaton Electrical Group, Warrendale, PA 15086 USA (e-mail: davidshipp@eaton.com; thomasjdionise@eaton.com; visuthlorch@eaton.com; billgmacfarlane@eaton.com).

Color versions of one or more of the figures in this paper are available online at <http://ieeexplore.ieee.org>.

Digital Object Identifier 10.1109/TIA.2010.2101996

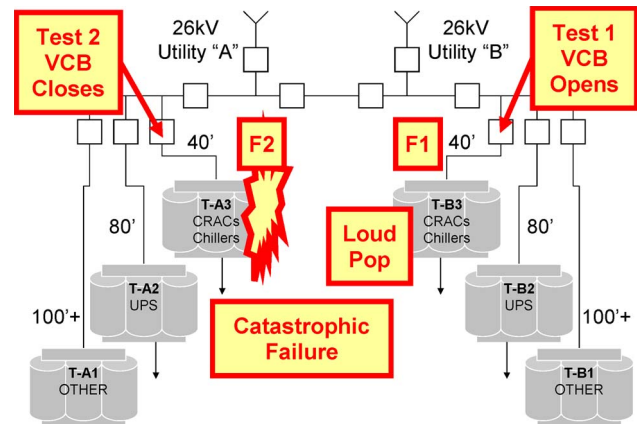

Fig. 1. Simplified electrical distribution system for data center.

which can fail distribution equipment such as transformers. Transformer failures due to circuit-breaker-induced switching transients are a major concern, which is receiving attention in a draft standard [1] and the focus of this paper.

### A. Forensic Evidence for a Unique Case

Consider the case study of a new data center with a 26-kV double-ended loop-through feed to six dry-type transformers each rated at 3000 kVA AA/3390 kVA FA and 26/0.48 kV and delta-wye solidly grounded, as shown in Fig. 1. The transformer primary winding is of 150-kV basic impulse insulation level (BIL). A vacuum breaker was used to switch the transformer. The 4/0 cable between the breaker and the transformer was 33 kV and 133% ethylene propylene rubber. Primary arresters were installed. The transformers were fully tested, including turns ratio, insulation resistance, etc. Functional tests were completed, including uninterruptible power supply (UPS) full load, UPS transient, data center room validation, etc. In the final phase of commissioning, a “pull-the-plug” test was implemented with the following results.

- 1) *De-Energization Failure #1*. Four electricians “simultaneously” opened four 26-kV vacuum breakers to simulate a general utility outage. All systems successfully transferred to standby generation but a “loud pop” was heard in Substation Room B and the relay for the vacuum circuit breaker feeding transformer TB3 signaled a trip.
- 2) *Energization Failure #2*. Minutes later, two electricians “simultaneously” closed two 26-kV vacuum breakers to substation Room A. Transformer TA3 failed catastrophically.

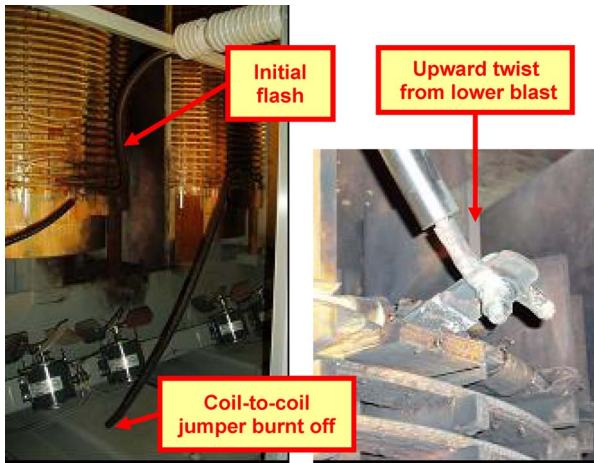

Fig. 2. Transformer failure #2 during energization.

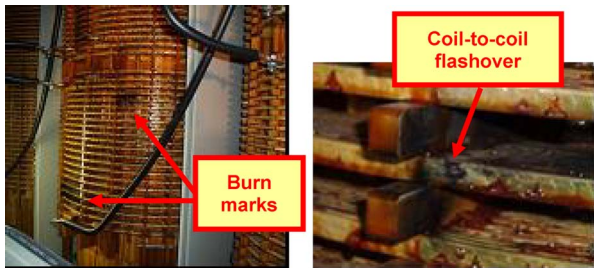

Fig. 3. Transformer failure #1 during de-energization.

Failure #2 is shown in Fig. 2. Examination of the primary windings revealed that the coil-to-coil tap burnt off and the winding terminal showed an upward twist. The burn marks from the initial Flash indicated the transient concentrated on the first turns of the windings. Typically, closing the vacuum breaker to energize the transformer is the worst condition.

Failure #1 is shown in Fig. 3. Examination of the primary windings revealed Flash and burn marks on the B-phase winding at the bottom and middle. Those at the top indicate a coil-to-coil failure, not a winding-to-winding failure, and indicate a transient voltage with high  $dv/dt$ . Those in the middle were a result of the cable (used to make the delta connection) swinging free. Supports were only lacking for this jumper (oversight during manufacturing) which could not withstand the forces of the transient. This transformer passed the BIL test at 150-kV BIL but ultimately failed at 162-kV BIL.

All six transformers and cables were identical, but only two failed during the vacuum-circuit-breaker switching. The significant difference was that the two failed units had 40 ft of feeder cable while the others had 80 or 100 ft of feeder cable. This short 40-ft cable, high-efficiency transformer, and vacuum circuit breaker proved to be the right combination to produce a damaging voltage transient on both energization and de-energization.

### B. History of Failures and Forensic Review

The previous example is not an isolated case. Instead, it is representative of a growing number of transformer failures

TABLE I  
HISTORY OF TRANSFORMER FAILURES RELATED TO  
PRIMARY VACUUM BREAKER SWITCHING

Case	Facility	Circuit		Transformer***			Vacuum Breaker		
		Voltage	Cable Feet	Bil	Type	Arrester	Failure Mode	Vendor	Switching
1*	Hydro Dam	13.80	20	50	Dry	No	1st turn	A	Close
2	Hospital	13.80	27	95	Dry	No	1st turn	A	Close
3	Railroad	26.40	37	150	Liquid	N/A	middle	A	Open
4	Data Center	26.40	40	150	Cast coil	Yes	1st turn	B	Close/Open
			80	150	Cast coil	Yes	None	B	Close
5	Oil Field	33.00	7		Dry	No	1st turn	C	Close
6**	Oil Drill Ship	11.00	<30	75	Cast coil	Yes	1st turn	C	Close

Notes: \* = 40-50 yrs. old with new breaker. \*\* = 2 yrs. old. All others new.  
\*\*\* = All transformers unloaded or lightly loaded when switched.

due to primary switching of vacuum breakers. Table I details a history of transformers related to primary switching of vacuum breakers occurring within the past three years.

In Case 1, in a hydro dam, the transformer was “value engineered” with a 13.8-kV primary-winding BIL of 50 kV. The BIL should have been 95 kV for the 13.8-kV class.

The 1955 switchgear was replaced with modern vacuum breakers with only 20 ft of cable to the transformer. The user chose to energize the transformer before conducting a switching transient analysis and failed the transformer primary winding. The post mortem analysis revealed that no surge protection was applied.

In Case 2, in a hospital, the vacuum breaker was close-coupled through 27 ft of cable to a 2500-kVA dry-type transformer with a 95-kV-BIL primary winding. The vacuum breakers were supplied with no surge protection because the particular vacuum breaker installed had a very low value of current chop. During vacuum breaker switching of the transformer, the transformer failed. The transformer was rewound, and surge protection/snubbers were installed.

In Case 3, in a railroad substation, vacuum breakers applied at 26.4 kV were used to switch a liquid-filled rectifier transformer with 150-kV-BIL primary winding. The switching transient overvoltage (TOV) failed the middle of the primary winding. Forensic analysis determined a rectifier with dc link capacitors, and the transformer inductance formed an internal resonance that was excited by the switching. Such an  $LC$  series resonance typically fails the middle of the transformer primary winding.

In Case 4, in a data center, vacuum breakers applied at 26.4 kV were used to switch six dry-type transformers with 150-kV-BIL primary windings under light load. Two transformers failed, one on breaker closing and the other on opening. The failed transformers were connected by 40 ft of cable to the vacuum breaker, while the other transformers had either 80 or 100 ft of cable. Arresters were in place at the time of failure, but there were no snubbers.

In Case 5, in an oil field, a dry-type transformer for a variable speed drive (VSD) had multiple windings to achieve a 36-pulse effective “harmonic-free” VSD. A vacuum breaker at 33 kV was separated from the transformer by only 7 ft of cable.

TABLE II  
CURRENT CHOP VERSUS CONTACT MATERIAL

Contact Material	Average (A)	Maximum (A)
CU	15	21
Ag	4	7
Cr	7	16
W	14	50
Cr-Cu (75 wt %)	3	5
Cr-Cu-Bi (5 wt %)	1	3
Cr-Cu-Sb (9 wt %)	4	11
Cu-Bi (0.15 wt %)	6	21
WC-Ag (50 wt %)	1.5	2.5
W-Cu (30 wt %)	5	10
Co-AG-SE	0.4	0.8
Cu-Bi-Pb	1	9

Arresters were applied on the primary winding. However, upon closing the breaker, the transformer failed.

Finally, in Case 6, in an oil drilling ship, vacuum breakers designed to International Electrotechnical Commission (IEC) standards were applied at 11 kV and connected by 30 ft of cable to a dry-type cast-coil propulsion transformer rated at 7500 kVA. The transformer was also designed to IEC standards, and the primary winding had a BIL of 75 kV. The IEC transformer BIL is much lower than the American National Standards Institute (ANSI) BIL for the same voltage class winding. The transformer failed upon opening the breaker.

### C. Common Parameters

The severity of the voltage surge, i.e., high magnitude and high frequency, and the damage caused by the voltage surge are determined by the circuit characteristics. The following are some “rules-of-thumb” to screen applications for potentially damaging switching transient voltages.

- 1) generally, short distance between circuit breaker and transformer (about 200 ft or less);
- 2) dry-type transformer (oil filled and cast coil not immune) and low BIL;
- 3) inductive load being switched (transformer, motor, etc.);
- 4) circuit-breaker switching characteristics: chop (vacuum or SF-6) or restrike (vacuum).

### D. Underlying Concepts

- 3) *Current Chop*. When a vacuum breaker opens, an arc burns in the metal vapor from the contacts, which requires a high temperature at the arc roots [2]. Heat is supplied by the current flow, and as the current approaches zero, the metal vapor production decreases. When the metal vapor can no longer support the arc, the arc suddenly ceases or “chops out.” This “chop out” of the arc called “current chop” stores energy in the system. If the breaker opens at a normal current zero at  $180^\circ$ , then there is no stored energy in the system. If the breaker opens, chopping current at  $170^\circ$ , then energy is stored in the system.

Current chop in vacuum circuit breakers is a material problem. Older vacuum interrupters (VIs) used copper–bismuth. Modern VIs use copper–chromium. Most copper–chromium VIs have a low current chop of

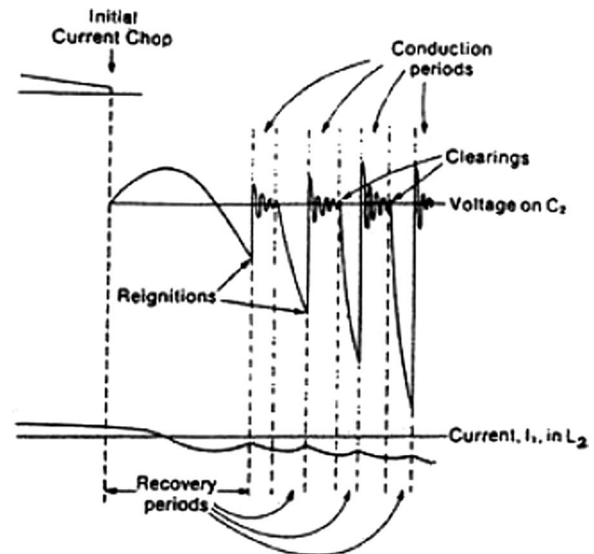

Fig. 4. Voltage escalation due to successive reignitions.

3–5 A, offering excellent interruption performance and a moderate weld strength. Table II shows the average and maximum levels of current chop for copper–chromium, copper–bismuth, and other contact materials. It should be noted that both vacuum and SF-6 interrupters current chop. Current chop is not unique to vacuum breakers.

- 4) *Reignition*. Current chop, even though very small, coupled with the system capacitance and transformer inductance can impose a high-frequency transient recovery voltage (TRV) on the contacts. If this high-frequency TRV exceeds the rated TRV of the breaker, reignition occurs. Repetitive reignitions can occur when the contacts part just before a current zero and the breaker interrupts at high-frequency zeros, as shown in Fig. 4. On each successive reignition, the voltage escalates. The voltage may build up and break down several times before interrupting. Although current-chop escalation with modern VIs is rare, a variation of this concept applies on closing called prestrike.
- 5) *Switching inductive circuits*. The transformer is a highly inductive load with an iron core. The effect of switching this inductive load and core must be considered. The current cannot change instantaneously in an inductor. Energy cannot be created or destroyed; only the form of energy is changed. The energy in the inductor is described by

$$1/2LI^2 = 1/2CV^2 \quad \text{or} \quad V = I\sqrt{L/C}. \quad (1)$$

From the energy equation, it can be seen that, for short cables,  $C$  is very small, which results in a very high surge impedance  $\sqrt{L/C}$ . Energizing a cable produces a traveling wave which reflects when it meets the discontinuity in surge impedance between the cable and the transformer. The surge impedance of a cable may be under  $50 \Omega$ , while the surge impedance of the transformer is  $300\text{--}3000 \Omega$ . In theory, the reflection can be as high as 2 per unit.



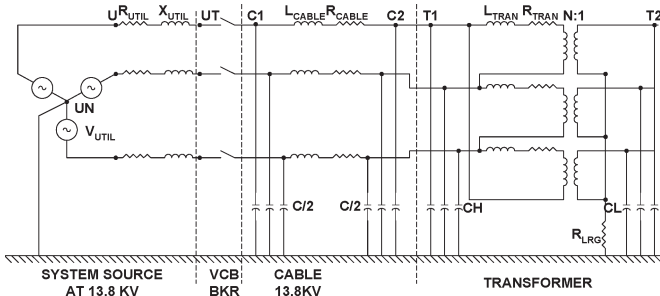

Fig. 5. Important circuit elements for EMTF modeling.

Vacuum circuit breakers are prone to current chopping and voltage reignition while SF-6 circuit breakers are more prone to just current chopping. Air circuit breakers are not prone to either of any significant magnitude. Manufacturers design vacuum-circuit-breaker contacts to minimize the severity and occurrence of abnormal switching leading to severe voltage surges (the lowest current-chop characteristics are 3–5 A). Regardless of the circuit-breaker manufacturer, voltage surges do occur.

E. Characteristics of the Voltage Transient and Transformer Limits

The voltage transient that develops following the vacuum-circuit-breaker switching is influenced by three factors: stored energy, dc offset, and the oscillatory ring wave. The voltage component is due to the stored energy. The dc offset is determined by the  $X/R$  ratio of the cable and the transformer. The oscillatory ring wave is a result of the capacitance and inductance of the cable and the transformer. The magnitude of the voltage transient is compared with the transformer BIL. If the magnitude is excessive, then the transformer winding will likely fail line to ground. If the voltage transient has excessive rate of rise ( $dv/dt$ ), then the transformer winding will likely fail turn to turn (natural frequency of ring wave). For the transformer to survive the transient, the insulation must be able to withstand both the magnitude and the  $dv/dt$ . Dry-type transformers are particularly susceptible to vacuum or SF-6 breaker switching transients. However, oil- or liquid-filled transformers are not immune. The oil has capacitance and acts like a surge capacitor to slow the rate of rise of the voltage transient. The trend in modern-day power systems is to install transformers with high-efficiency design. As a result, these high-efficiency transformers have a very small resistance, which offers little or no damping to the voltage transient. Also, the repetitive effect, i.e., small indentations in the insulation, can occur with each successive peak of the voltage transient.

II. PREDICTING PERFORMANCE WITH SIMULATIONS

A. Modeling the Circuit

When a statistical approach is taken for switching transients, complex modeling requires a frequency-dependent transformer model and an arc model of the circuit breaker. For purposes of screening applications for potentially damaging switching transients, a simpler approach is suggested with the important

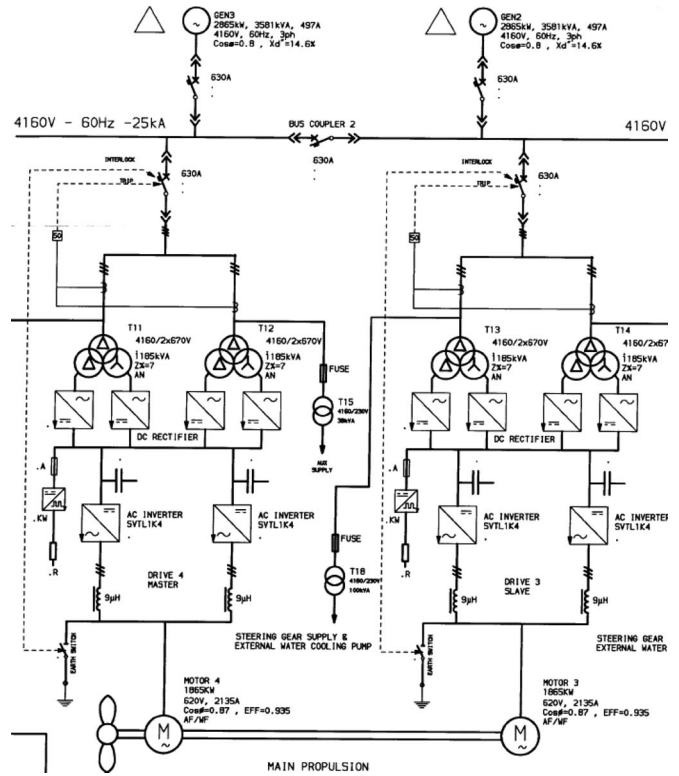

Fig. 6. Simplified electrical system for ship propulsion drive.

circuit elements modeled in electromagnetic transients program (EMTP) consisting of the source, breaker, cable, and transformer, as shown in Fig. 5. The cable is represented by a Pi model consisting of the series impedance and half of the cable charging at each end. In some cases, multiple Pi models are used to represent the cable. The vacuum or SF-6 breaker is represented by a switch with different models for opening (current chop), restriking (excessive magnitude of TRV), reignition (excessive frequency of TRV), and closing (prestrike). The three-phase transformer model consists of the leakage impedance, magnetizing branch, and winding capacitances from high to ground and low to ground. For oil-filled transformers, the oil acts like a dielectric so the high-to-low capacitance is modeled. In cases requiring more detail, the transformer saturation and hysteresis effects are modeled.

The choice of the integration time step will depend upon the anticipated frequency of the voltage transient. If it is too large, the time steps will “miss” the frequency effects. If it is too small, then this will lead to excessive simulation times. The Nyquist criteria call for a minimum sample rate of twice the anticipated frequency. In switching transients, the anticipated frequency is 3–25 kHz. When the circuit breaker opens, the transformer primary winding is ungrounded. Also, the ring wave is a function of the natural frequency of the circuit

$$f_{\text{natural}} = 1/(2\pi\sqrt{LC}). \tag{2}$$

The iron core of the transformer dominates the inductance of the circuit. The capacitance is very small for the dry-type transformer and short cable. Consequently, the circuit’s natural frequency is 3–25 kHz with relatively short cables.

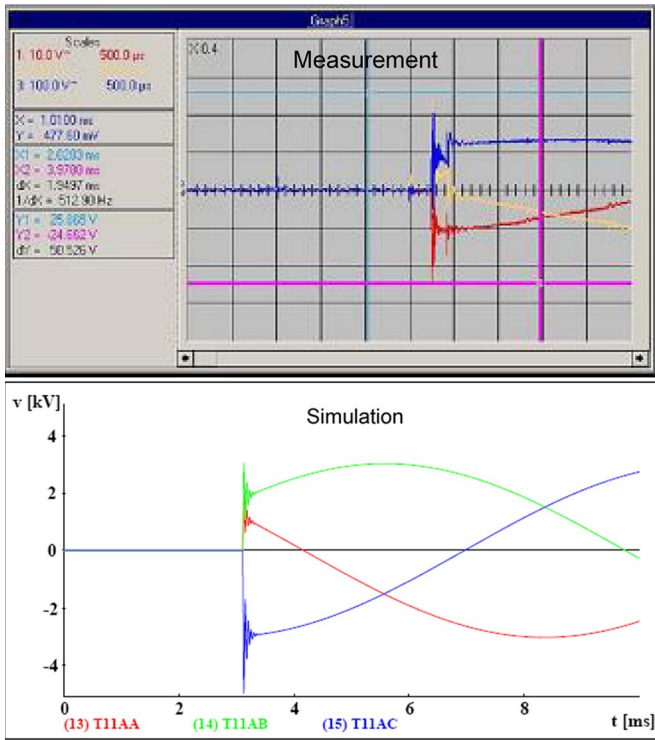

Fig. 7. Matching the simulation to field measurements.

### B. Mitigating the Switching Transient

Various surge protection schemes exist to protect the transformer primary winding from vacuum-breaker-switching-induced transients. A surge arrester provides basic overvoltage protection (magnitude only). The arrester limits the peak voltage of the transient voltage waveform. The surge arrester does not limit the rate of rise of the TOV. A surge capacitor in combination with the surge arrester slows down the rate of rise of the TOV in addition to limiting the peak voltage but does nothing for the reflection or dc offset. The number of arrester operations is greatly reduced because of the slower rate of rise. There is a possibility of virtual current chopping. Finally, adding a resistor to the surge capacitor and surge arrester provides damping, reduces the dc offset of the TOV waveform, and minimizes the potential for virtual current chopping. The resistor and surge capacitor are considered an  $RC$  snubber. Selecting the values of resistance and capacitance are best determined by a switching transient analysis study, simulating the circuit effects with and without the snubber.

### C. Matching the Model to Measurements

The results obtained from simulation of switching transients in EMTF are only as good as the choice of model and data used. When available, field measurements taken during the switching transients enable verification of the EMTF model. The EMTF model can be adjusted as needed to match the actual field-measured conditions. To illustrate this approach, consider the ship propulsion electrical system in Fig. 6.

The system consists of  $3 \times 2865$ -kW generators, a 4160-V three-phase bus, two 1865-kW drives/motors for forward

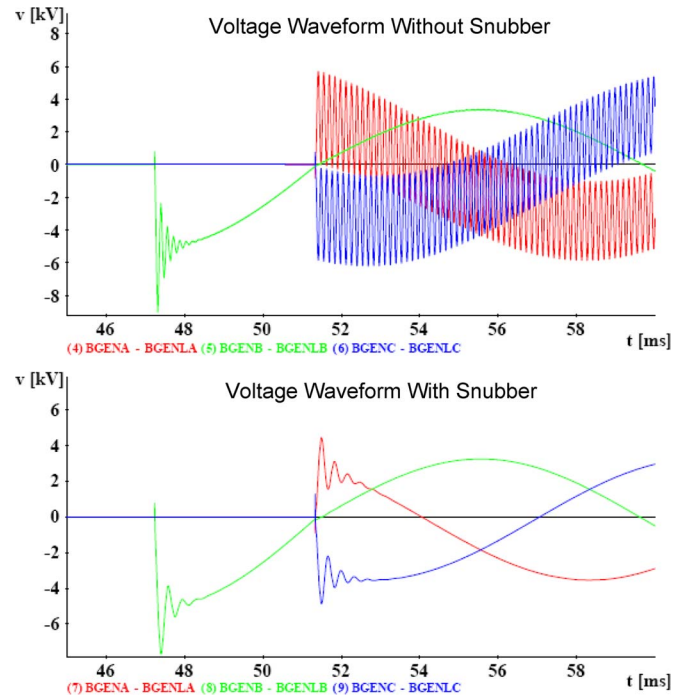

Fig. 8. TRV leading to reignition during energization of drive transformer with and without snubber.

TABLE III  
CURRENT CHOP AND REIGNITION CASES FOR DRIVE PROPULSION  
TRANSFORMER SWITCHING

Case	Vacuum Breaker	Current Chop (A)	RC	TOV (kV)	Freq (Hz)	Transf BIL	Note
1	Close	N/A	N	4.965	20,203	30	U
2	Close	N/A	Y	3.982	<1000	30	A
5	Open	6	N	31.895	958	30	U
6	Open	6	Y	8.953	299	30	A

Case	Vacuum Breaker	Current Chop Note1 (A)	RC	Transient Recovery Voltage (kV/ $\mu$ sec)	IEEE ANSI C37.06 Limit	Note
3	Reignition	6	N	E2 (kV)	9.044	8.9
				T2 ( $\mu$ sec)	79	50
				RRRV (kV/ $\mu$ sec)	0.1145	0.178
4	Reignition	6	Y	E2	7.702	8.9
				T2	149	50
				RRRV	0.0517	0.178

Notes: U = unacceptable. A = acceptable. 1 = current chop on breaker opening followed by reignition.

propulsion and identical drives for reverse propulsion, eight 1185-kVA dry-type transformers, and eight 630-A vacuum circuit breakers. The critical parameters are the vacuum circuit breaker, 50 ft of cable, and dry-type transformer of 30-kV BIL. Fig. 7 shows that the EMTF simulation results match the transients captured in the field with a high-speed power-quality meter (closing). The simulation shows 4.96 kV<sub>peak</sub>, which is less than 30-kV BIL; however, the oscillation frequency of 20.2 kHz exceeds an acceptable limit of  $dv/dt$ . Having verified the model, a series of current-chop cases and reignition cases were run. Fig. 8 shows the TRV leading to reignition and the TRV with a snubber installed. Reignition occurs because the TRV peak, time to crest, and rate of rise of recovery voltage exceed IEEE ANSI C37.06 limits.

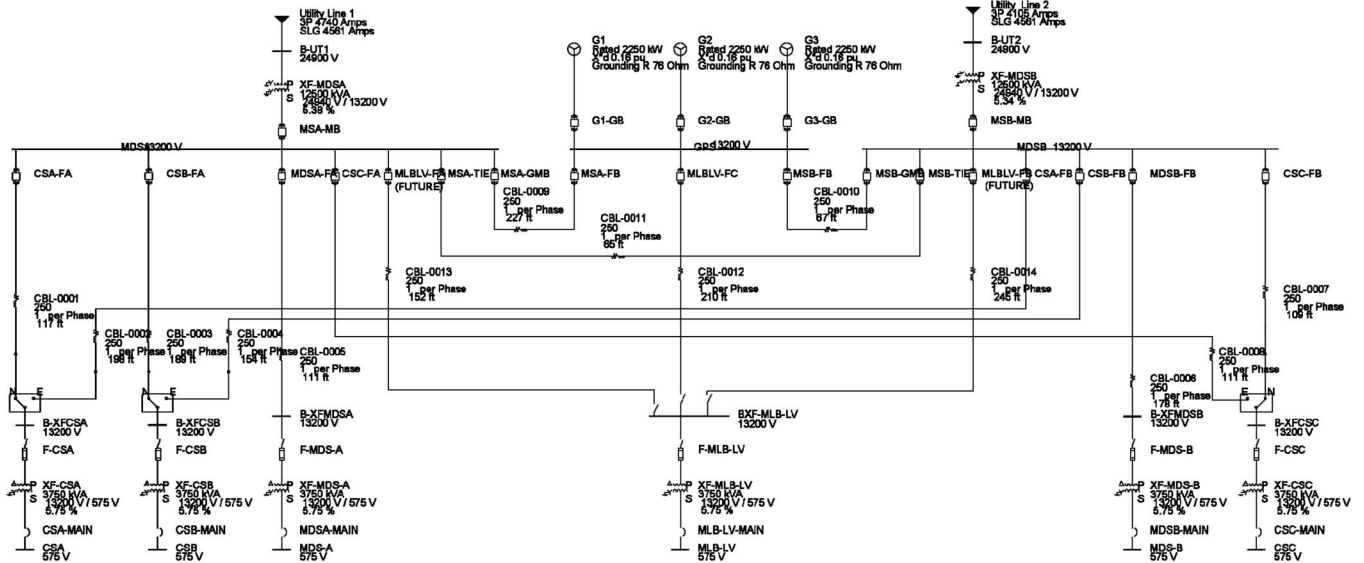

Fig. 9. Simplified electrical distribution system for Tier III data center.

The snubber reduces the TRV below the IEEE/ANSI limits for general-purpose vacuum breakers [3] and for generator breakers [4]. Table III summarizes the reignition cases and the current-chop cases. In all cases, the snubber is effective in reducing the transient voltage.

D. Borderline Case

It is important to note that not all applications involving primary switching of transformers using vacuum breakers require snubbers. The large majority of applications do not require snubbers. Switching transient studies are conducted to determine when snubbers are needed. In this paper, the cases were selected to show different situations requiring snubbers. For the system shown in Fig. 9, the results were borderline; therefore, a snubber was still applied for reliability purposes. The Fig. 9 system is a Tier III data center with two 24.9-kV incoming lines, two 12.5-MVA 25/13.2-kV transformers, a 13.2-kV ring bus, two 2250-KW generators, and six 3750-kV cast-coil transformers.

Data centers fall into the highest risk categories because of their high load density, close proximities of circuit components, highly inductive transformers (high-efficiency designs), and frequent switching. The critical parameters for the Fig. 9 system are vacuum circuit breakers, 90-kV-BIL transformers, and cable lengths ranging from 109 to 249 ft. For the cable of 109 ft, the results of opening the vacuum breaker with current chopping of 8 A are shown in Fig. 10. The TOV is as high as 123 kV<sub>peak</sub> on phase A which exceeds the transformer BIL of 95 kV. The TOV exhibits a significant dc offset because there is very little resistance in the highly inductive circuit. The oscillation frequency of 969 Hz is slightly less than the acceptable limit.

A snubber is required to reduce the peak below 95-kV BIL. The results of adding a snubber are shown in Fig. 10. Note the significant reduction in the dc offset. The resistor in the snubber provides the reduction in dc offset as well as damping. The peak is reduced to 28.6 kV and an oscillation of 215 Hz,

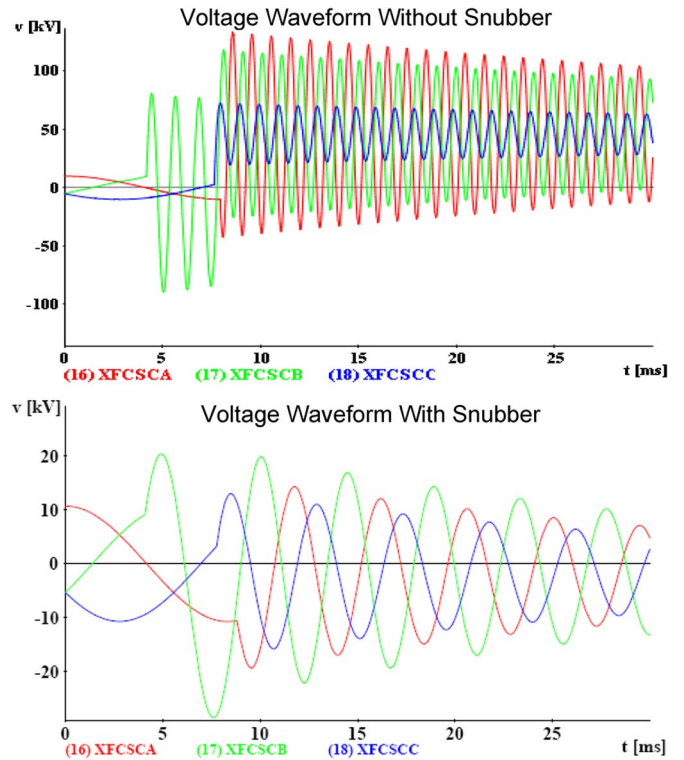

Fig. 10. TOV initiated by current chop during de-energization of cast-coil transformer with and without snubber.

both within acceptable limits. Finally, field measurements were taken after the snubber was installed to ensure that the snubbers performed as designed. The field test setup for the snubber performance measurements is discussed in Section IV. The field measurements showed that the snubber limited the TOV within acceptable limits.

E. Case of Switching a Highly Inductive Circuit

Now, consider the vacuum breaker switching of a highly inductive circuit, such as the starting current of a large grinder



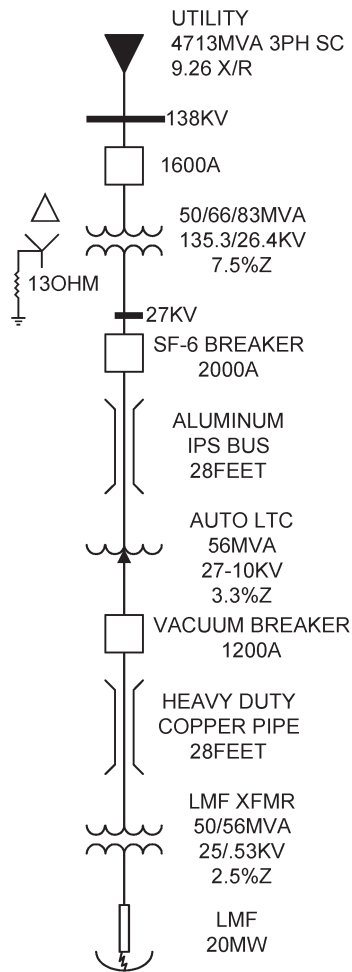

Fig. 11. Simplified electrical distribution system for LMF.

motor or an electric arc furnace. The vacuum-circuit-breaker switching of an electric arc furnace and ladle melt furnace transformers raises concern because of their high inductive currents. High-frequency transients and overvoltages result when the vacuum breaker exhibits virtual current chop and multiple reignitions. As an example, the arc furnace circuit of Fig. 11 consists of a 50-MVA power transformer, 2000-A SF-6 breaker, 56-MVA autoregulating transformer, 1200-A vacuum breaker, and 50-MVA furnace transformer. The switching of the SF-6 and vacuum breaker was studied. The vacuum breaker, because of the 28-ft bus to the furnace transformer, was the worst case. The results opening the vacuum breaker with and without snubbers are shown in Fig. 12. The TOV of 386 kV<sub>peak</sub> exceeds the transformer BIL of 200 kV, and the oscillation of 1217 Hz exceeds the acceptable limit. Application of the snubber results in a TOV of 56.4 kV<sub>peak</sub> that is below the transformer BIL, and the oscillation of 200 Hz is below the acceptable limit. The results for cases involving current chop and reignition are given in Table IV.

#### F. Concerns for the Pulp and Paper Industry

The previous examples illustrate that circuit-breaker-induced switching transients can fail transformers for specific combinations of circuit parameters and breaker characteristics.

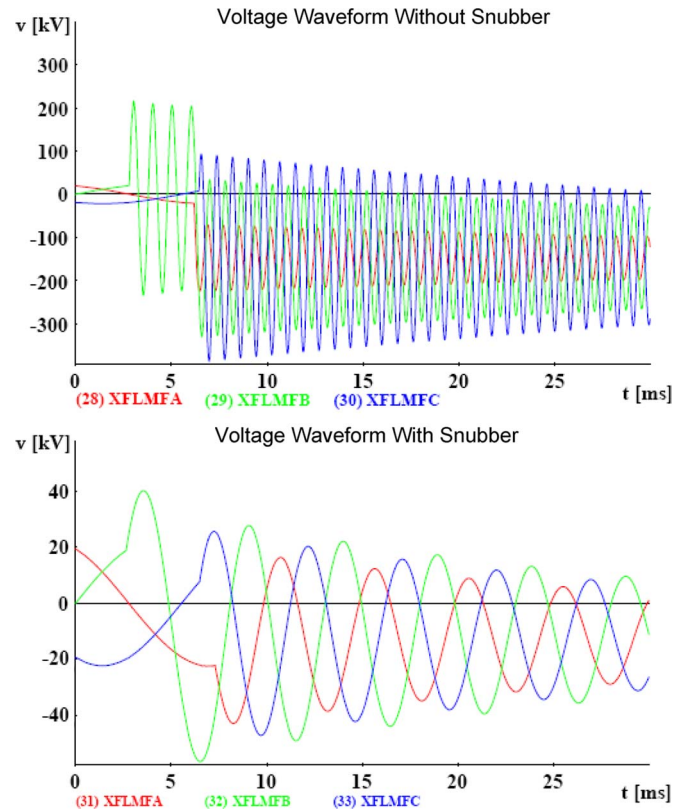

Fig. 12. TOV during de-energization of LMF transformer with and without snubber protection.

The examples show that the problem is not unique to one industry, application, vendor's breaker, or transformer design. For the pulp and paper industry, there are many situations where circuit-breaker-induced switching transients are likely to damage transformers. The following examples are some of the more common scenarios encountered in the pulp and paper industry.

- 1) *Vacuum breaker retrofit for primary load break switch in a unit substation.* In the pulp and paper industry, there are numerous unit substation installations with primary load break fused switch and no secondary main breaker. This arrangement results in arc Flash issues on the low-voltage secondary. Limited space on the low-voltage side prevents installation of a secondary main breaker to mitigate the arc Flash issues. Retrofitting a vacuum circuit breaker in the primary of the unit substation, in place of the primary load break switch, and sensing on the secondary is a solution that provides both primary and secondary fault protection [5]. Unit substations may have oil-filled or dry-type transformers. The secondaries may be solidly grounded or resistance grounded. With the vacuum breaker closely coupled to the transformer, surge arresters and snubbers are most likely needed.
- 2) *Vacuum breaker and rectifier (or isolation) transformer installation.* Rectifier transformers are installed to serve dc drives such as those needed for feed water pumps to the boilers. Also, isolation transformers are installed to serve a large VSD or groups of smaller drives. Primary voltages may be 13.8 or 2.4 kV, and secondary voltages

may be 600 or 480 V. In both situations, vacuum breakers are installed in the primary and closely coupled to the transformer through a short run of bus or cable. Often, these transformers are inside and of dry-type design.

- 3) *New unit substation with primary vacuum breaker.* Recently, a paper mill installed a new metal-enclosed vacuum switchgear and a new 13.8/2.4-kV 7500-kVA transformer for a bag house for the generator boilers to meet Environmental Protection Agency requirements. The vacuum breaker was connected to the transformer through 5 ft of bus. While doing the coordination and arc Flash studies, the switching transient issue was identified. The equipment was installed and was awaiting startup and commissioning when the studies raised the concern. Before energizing the transformer, snubbers were quickly sized, obtained, designed, and installed.

The screening criteria previously mentioned identify the aforementioned examples for potential damaging switching transient voltages due to vacuum breaker switching. The vacuum breaker, short distance to transformer, and dry-type transformer (or aged oil-filled transformer) are key variables to consider. With such short distance between breaker and transformer, most of these installations will require snubbers. One might conclude that standard snubbers could be applied. However, a switching transient study is still recommended to determine the unique characteristics of the circuit and custom design the snubber for the application. Given the limited space in each of these examples, it is unlikely that off-the-shelf standard snubbers would fit. A substantial part of the design effort includes determining how to best fit the snubbers into the new or existing unit substation or transformer enclosure.

### III. DESIGNING THE SNUBBER

The preceding analysis has shown that, in some cases, switching transients can produce overvoltages that can result in equipment insulation failure. If the results of the switching transient study indicate a risk of overvoltage greater than the BIL of the equipment and/or if the  $dv/dt$  limits are exceeded, a surge arrester and snubber should be applied. The switching transient study may also indicate that multiple locations require surge arresters and snubbers to protect the generator, transformer, or large motor. Additionally, the study specifies the necessary protective components and determines how close the protection must be placed to provide effective protection.

#### A. Design Requirements

At this point, custom engineering design determines how to best provide the protection needed for the equipment. The following questions must be answered to ensure that the snubber design meets all criteria and specifications.

- 1) Is the switching transient protection cost effective?
- 2) What is the value of the equipment being protected?
- 3) What is the cost of lost production if the equipment fails from switching transients?
- 4) Can the protection be installed within existing equipment enclosures?

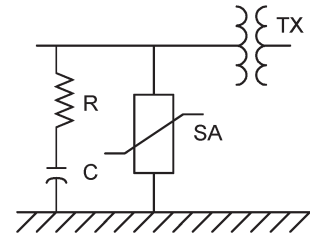

Fig. 13. Typical snubber and arrester arrangement for transformer protection.

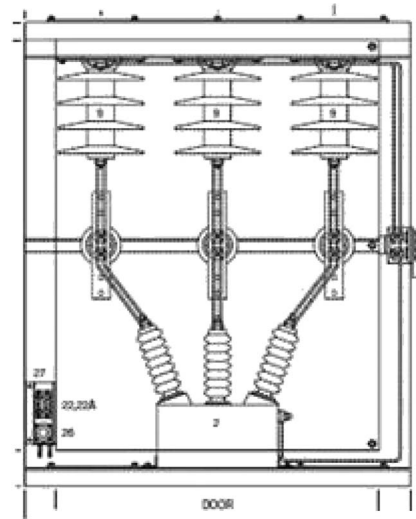

Fig. 14. Example of standard snubber package for transformer.

- 5) Will equipment modification void equipment warranties?
- 6) Are there standard equipment packages that can accomplish the switching transient protection?
- 7) Is the application an indoor or outdoor application?
- 8) Is there available space to mount the protective equipment in an external enclosure?
- 9) How can it be verified if the switching transient protection components are working effectively?
- 10) What alarms are necessary if the protective equipment components fail?

#### B. Custom Engineering Design

Fig. 13 shows the typical snubber arrangement for transformer protection. A noninductive ceramic resistor and a surge capacitor are the basic components of a snubber design. Resistance values typically range from 25 to 50  $\Omega$ . Standard capacitor ratings that range from 0.15 to 0.35  $\mu\text{F}$  are the basis of the design.

Fig. 14 shows a standard 15-kV surge protection package. The arresters are mounted on the top of the enclosure. A three-phase surge capacitor is mounted on the bottom. Insulators and bus are located in the center. The cables can enter from top or bottom. A ground bus is located on the center right. If space heaters are required for outdoor locations, they are located on the lower left.

Fig. 15 shows one phase of a custom snubber circuit. The custom design was required because there was not enough room in the transformer for the snubber components. The enclosure



TABLE IV  
CURRENT CHOP AND REIGNITION CASES FOR LMF TRANSFORMER SWITCHING

Case	Vacuum Breaker	SF6 Breaker	Current Chop (A)	RC	TOV (kV)	Freq (Hz)	Transf BIL	Note
1	Close	NC	6	N	386.5	1,217	200	U
2	Close	NC	6	Y	56.4	200	200	A
3	NO	Open	6	N	N/A	N/A	200	A
4	NO	Open	6	Y	N/A	N/A	200	A

Case	Vacuum Breaker	SF6 Breaker	Current Chop Note1 (A)	RC	Transient Recovery Voltage	IEEE ANSI C37.06 Limit	Note
5	Reignition	NC	6	N	E2 (kV)	217.7	71
					T2 ( $\mu$ sec)	16	63
					RRRV (kV/ $\mu$ sec)	13.6	1.127
6	Reignition	NC	6	Y	RRRV	0.3293	1.127
					E2	29.4	136
					T2	75	106
7	NO	Reignition	6	N	RRRV	0.3923	1.127
					E2	29.4	136
					T2	75	106
8	NO	Reignition	6	Y	RRRV	0.3923	1.127
					E2	29.4	136
					T2	75	106

Notes: U = unacceptable. A = acceptable. 1 = current chop on breaker opening followed by reignition.



Fig. 15. 15-kV snubber mounted above the transformer.

had to be mounted above the transformer. The cable connections from the transformer were field installed and land on the copper bus. A 15-kV nonshielded jumper cable was used to make the connection. Each phase passed through an insulation bushing to the transformer below. Bus work was required to provide a solid support for the fragile resistors. Normally, only one resistor would be provided, but for this application, to achieve the delivery schedule, parallel resistors were designed to obtain the correct ohmic value (the correct single resistor value had long delivery).

Fig. 16(a) and (b) shows a snubber assembly mounted in medium voltage switchgear. The photo on the left shows the single-phase surge capacitors mounted vertically. The black cylinders are ceramic resistors. A variety of options are available to detect if the snubbers are functional. They range from nothing (oversized but treated like a lightning arrester) to very sophisticated loss of circuit detection. Glow tube indicators are shown at the top of Fig. 16(a), and a close-up is shown in Fig. 17(a). These glow tubes are visible through a window in the switchgear door and provide a visual indication of snubber

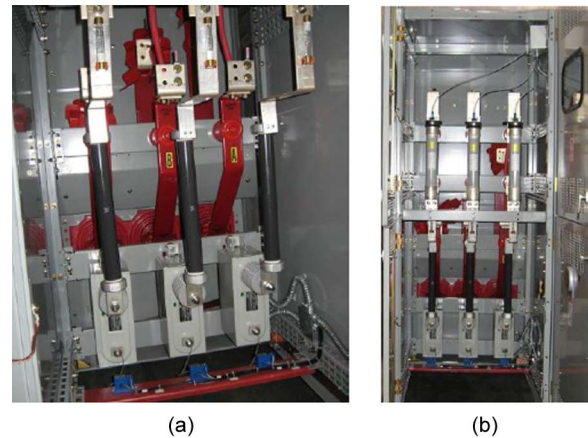

Fig. 16. 15-kV snubber mounted in switchgear with glow tubes and current sensors.

continuity. The purpose of the blue current sensors at the bottom of Fig. 16(a) is to monitor the continuity of the resistor and fuse (optional) and alarm on loss of continuity. A close-up of the current sensor is shown in Fig. 17(b). Some industries mandate fused protection. If there should be a broken resistor or a blown fuse, an alarm signal can be sent to the plant distributed control system or supervisory control and data acquisition system to alert the operating personnel that these snubber components have failed. Fig. 16(b) shows a continuation of the same snubber assembly. Three fuses are attached to the tops of the resistor. The fuses will isolate any fault that may occur in the snubber assembly and prevent loss of the breaker circuit.

### C. Special Design Considerations

The nature of high-frequency switching transients requires special design considerations. The snubber designer should

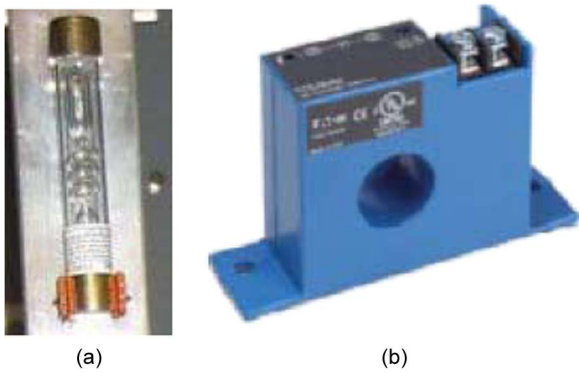

Fig. 17. 15-kV snubber visual indication (glow tubes) and continuity verification (current sensors).

consider the location of the switching transient source when developing the custom design layout of the protective equipment. Abrupt changes in the electrical path should be avoided. A low inductive reactance ground path should be designed, using non-inductive ceramic resistors and flat tin braided copper ground conductors. The minimum clearances of live parts must meet or exceed the phase-to-phase and phase-to-ground clearances of NEC Table 490.24. The enclosure should be designed to meet the requirements of IEEE Standard C37.20.2 1999. When the enclosure is mounted greater than 10 ft from the equipment to be protected, NEC tap rules may apply to the cable size required and additional circuit protective devices may be required.

#### D. Custom Designs for the Pulp and Paper Industry

As mentioned previously, given the limited space in each of the examples related to the pulp and paper industry, it is unlikely that off-the-shelf standard snubbers would fit. Instead, a substantial part of the design effort includes determining how to best fit the snubbers into the new or existing unit substation or transformer enclosure. Following are three examples of the custom design effort needed for snubber installation.

- 1) *13.8-kV Solidly Grounded System in Paper Mill.* A vacuum breaker was retrofitted into the enclosure for the primary load break switch of the unit substation with a dry-type transformer. The space for the snubber was extremely limited, as shown in Fig. 18 (left). Because the system was solidly grounded, the voltage on the surge capacitor was limited to 8 kV line to ground; therefore, it was possible to use a three-phase surge capacitor. The tight clearance required the use of glastic to insulate the components at line potential from ground.
- 2) *13.8-kV Resistance Grounded System in Paper Mill.* Another example of retrofitting a vacuum breaker for a primary load break switch with a 30-year-old oil-filled transformer. Because this snubber was needed immediately, the only available resistors had to be paralleled to obtain the desired resistance, as shown in Fig. 18 (right). Again, glastic was used for insulation and to support the resistors.
- 3) *13.8-kV Low Resistance Grounded System.* Snubbers were provided for a new metal-enclosed vacuum switchgear and a new 13.8/2.4-kV 7500-kVA transformer

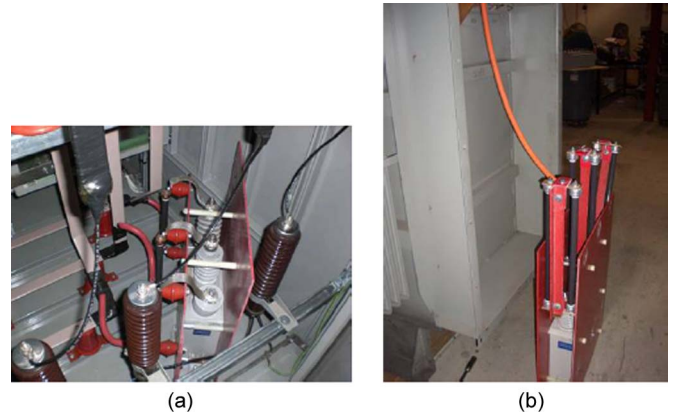

Fig. 18. Snubber with (left) three-phase and (right) single-phase surge capacitors for 13.8-kV paper mill application.



Fig. 19. Snubber for metal-enclosed 13.8-kV vacuum breaker.

for a bag house. Single-phase surge capacitors were used. Single resistors of the right ohmic value were available. Adequate clearance did not require the use of glastic as shown in Fig. 19.

#### IV. MEASUREMENTS TO VERIFY SNUBBER PERFORMANCE

Following the installation of the snubbers, power quality measurements may be taken to ensure the proper operation of the snubbers. A high-speed scope or power quality disturbance analyzer should be used to measure the TOV waveforms at the transformer primary produced during switching of the primary vacuum circuit breaker. The measurements are used to verify that the waveforms do not exhibit excessive high-frequency transients (magnitude, rate of rise, and frequency).

The test measurement setup generally consists of voltage dividers and a transient recording device. The voltage dividers should be made of capacitive and resistive components with a bandwidth of 10 MHz. The scope or power quality meter should be capable of transient voltage wave shape sampling,

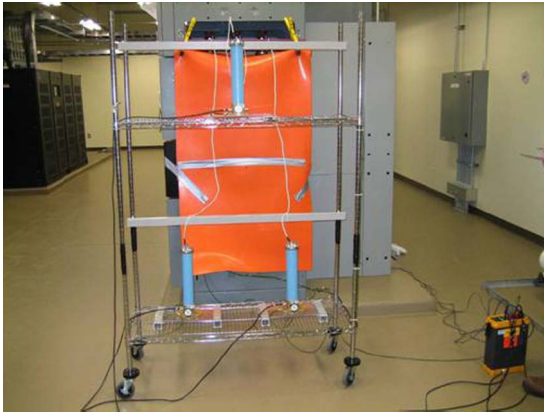

Fig. 20. Snubber performance measurement setup for 15-kV transformer using high bandwidth voltage dividers.



Fig. 21. Voltage divider connections at 18-kV surge arrester on transformer primary bushing.

8000-V<sub>peak</sub> full scale, and 200-ns sample resolution (5-MHz sampling).

An outage and lockout/tagout are needed to install the voltage dividers, make connections to each of the three phases at transformer primary bushing, and make secondary connections to the transient recorder. Fig. 20 shows the test measurement setup for a typical cast-coil transformer. Voltage divider connections to the transformer primary were made, as shown in Fig. 21.

Additionally, for tests requiring load at a transformer, a portable load bank may be connected to the transformer secondary. A resistive load bank configurable to different load levels (300 or 100 kW) prevents destructive testing.

## V. CONCLUSION

This paper has reviewed recent transformer failures due to primary circuit-breaker switching transients to show the severity of damage caused by the voltage surge and discuss common contributing factors. Next, switching transient simulations in EMTP were presented to illustrate how breaker characteristics of current chopping and restrike combine with critical circuit characteristics to cause transformer failure in unique situations. In these limited instances, mitigation of the transients is accomplished with snubbers custom designed to match the specific circuit characteristics. Design and installation considerations were addressed, particularly the challenges of retrofitting a

snubber to an existing facility with limited space. Finally, the performance of the snubbers is verified with field measurements at the medium-voltage primary winding of the transformer.

## REFERENCES

- [1] ANSI/IEEE, *A Guide to Describe the Occurrence and Mitigation of Switching Transients Induced by Transformer and Switching Device Interaction*, C57.142-Draft.
- [2] D. Shipp and R. Hoerauf, "Characteristics and applications of various arc interrupting methods," *IEEE Trans. Ind. Appl.*, vol. 27, no. 5, pp. 849–861, Sep./Oct. 1991.
- [3] *Standard for AC High-Voltage Generator Circuit Breakers on a Symmetrical Current Basis*, C37.013-1997, 1997.
- [4] *Application Guide for Transient Recovery Voltage for AC High-Voltage Circuit Breakers*, C37.011-2005, 2005.
- [5] D. Durocher, "Considerations in unit substation design to optimize reliability and electrical workplace safety," presented at the IEEE IAS Electrical Safety Workshop, Memphis, TN, 2010, Paper ESW2010-3.



**David D. Shipp** (S'72–M'72–SM'92–F'02) received the B.S.E.E. degree from Oregon State University, Corvallis, in 1972.

He is a Principal Engineer with the Electrical Services and Systems Division, Eaton Corporation, Warrendale, PA. He is a distinguished scholar in power system analysis and has worked in a wide variety of industries. He has spent many years performing the engineering work associated with his present-day responsibilities, which include a wide range of services covering consulting, design, power quality, arc flash, and power systems analysis topics. Over the last few years, he has pioneered the design and application of arc-flash solutions, modifying power systems to greatly reduce incident energy exposure. He has written over 80 technical papers on power systems analysis topics. More than 12 technical papers have been published in IEEE Industry Applications Society (IAS) national publications and two in *EC&M*. He spent ten years as a professional instructor, teaching full time. He occasionally serves as a legal expert witness.

Mr. Shipp is currently the Chair for the IEEE Industrial and Commercial Power Systems-sponsored Working Group on generator grounding. He has received an IEEE IAS Prize Paper Award for one of his papers and conference prize paper awards for six others. He is very active in IEEE at the national level and helps write the IEEE Color Book series standards.



**Thomas J. Dionise** (S'79–M'82–SM'87) received the B.S.E.E. degree from The Pennsylvania State University, University Park, in 1978, and the M.S.E.E. degree with the Power Option from Carnegie Mellon University, Pittsburgh, PA, in 1984.

He is currently a Senior Power Systems Engineer with the Power System Engineering Department, Eaton Corporation, Warrendale, PA. He has over 27 years of power system experience involving analytical studies and power quality investigations of industrial and commercial power systems. In the metal industry, he has specialized in power quality investigations, harmonic analysis and harmonic filter design for electric arc furnaces, rectifiers, and variable-frequency drive applications.

Mr. Dionise is the Chair of the Metal Industry Committee and a member of the Generator Grounding Working Group. He has served in local IEEE positions and had an active role in the committee that planned the Industry Applications Society 2002 Annual Meeting in Pittsburgh, PA. He is a Licensed Professional Engineer in Pennsylvania.





**Visuth Lorch** received the B.S.E.E. degree from Chulalongkorn University, Bangkok, Thailand, in 1973, and the M.S. degree in electric power engineering from Oregon State University, Corvallis, in 1976, where he was also a Ph.D. candidate and was inducted as a member of the Phi Kappa Phi Honor Society. During his Ph.D. studies, he developed the Short Circuit, Load Flow, and Two-Machine Transient Stability programs. The Load Flow program has been used in the undergraduate power system analysis class. He also prepared a Ph.D. thesis on the

Load Flow program using the third-order Taylor's series iterative method.

In 1981, he joined Westinghouse Electric Corporation, Pittsburgh, PA. He was responsible for conduction power system studies, including short circuit, protective device coordination, load flow, motor starting, harmonic analysis, switching transient, and transient stability studies. He also developed the Protective Device Evaluation program on the main frame Control Data Corporation supercomputer. In 1984, he joined the Bangkok Oil Refinery, Thailand, where his primary responsibility was to design the plant electrical distribution system as well as the protection scheme for the steam turbine cogeneration facility. He was also responsible for designing the plant automation, including the digital control system for the plant control room. In 1986, he rejoined Westinghouse Electric Corporation. He performed power system studies and developed the Short Circuit and Protective Device Evaluation programs for the personal computer. In 1998, he joined the Electrical Services and Systems Division, Eaton Corporation, Warrendale, PA, where he is currently a Senior Power Systems Engineer in the Power Systems Engineering Department. He performs a variety of power system studies, including switching transient studies using the electromagnetic transients program for vacuum breaker/snubber circuit applications. He continues to develop Excel spreadsheets for quick calculation for short circuit, harmonic analysis, soft starting of motors, capacitor switching transients, dc fault calculation, etc.



**Bill G. MacFarlane** (S'70–M'72) received the B.S.E.E. degree from The Pennsylvania State University, University Park, in 1972.

He began his career in 1972 with Dravo Corporation, Pittsburgh, PA, as a Power System Design Engineer supporting this engineering/construction company with expertise in the design and construction of material handling systems, chemical plants, pulp and paper mills, steel facilities, ore beneficiation, mine design, and computer automation systems. He provided full electrical design services in heavy industrial applications, primarily in the steelmaking and coal-preparation-related sectors. His responsibilities included client and vendor liaison and supervision of engineers, designers, and drafters. From 1978 to 2003, he was a principal Process Controls Systems Engineer with Bayer Corporation, Pittsburgh. He provided design and specification of instrumentation and control systems for chemical processes. He configured programmable logic controller and distributed control systems. He was a Corporate Technical Consultant for power distribution systems. He had been the principal Electrical Engineer on many major projects with Bayer Corporation. He joined the Electrical Services and Systems Division, Eaton Corporation, Warrendale, PA, in 2004. At Eaton, he has been involved in a 230-kV substation design, ground grid design for substations, as well as in short circuit, protective device coordination, load flow, and arc-flash hazard analysis studies. He has also done power factor correction and harmonics studies to resolve power quality issues.

He provided full electrical design services in heavy industrial applications, primarily in the steelmaking and coal-preparation-related sectors. His responsibilities included client and vendor liaison and supervision of engineers, designers, and drafters. From 1978 to 2003, he was a principal Process Controls Systems Engineer with Bayer Corporation, Pittsburgh. He provided design and specification of instrumentation and control systems for chemical processes. He configured programmable logic controller and distributed control systems. He was a Corporate Technical Consultant for power distribution systems. He had been the principal Electrical Engineer on many major projects with Bayer Corporation. He joined the Electrical Services and Systems Division, Eaton Corporation, Warrendale, PA, in 2004. At Eaton, he has been involved in a 230-kV substation design, ground grid design for substations, as well as in short circuit, protective device coordination, load flow, and arc-flash hazard analysis studies. He has also done power factor correction and harmonics studies to resolve power quality issues.

# Medium-Voltage Switching Transient-Induced Potential Transformer Failures: Prediction, Measurement, and Practical Solutions

Daniel C. McDermit, David D. Shipp, *Fellow, IEEE*, Thomas J. Dionise, *Senior Member, IEEE*, and Visuth Lorch

**Abstract**—During commissioning of a large data center, while switching medium-voltage circuit breakers without any appreciable load, several potential transformers failed catastrophically. A detailed investigation, including a computer simulation, was performed. Ferroresonance produced by switching transients associated with opening and closing the vacuum breakers was determined to be the cause. The analysis also determined that the close-coupled power transformers were also in jeopardy. Field inspections involving grounding improvements coupled with solution simulations were made. High-speed switching transient measurements were performed to verify the analysis and the surge protective device solution (arresters and snubbers). This paper walks the reader through problem recognition, simulation, field measurements, and solution implementation. Special focus will be made on the field measurement verification.

**Index Terms**—Electromagnetic Transients Program (EMTP) simulations, ferroresonance, potential transformers (PTs), RC snubbers, surge arresters, switching transients, vacuum breakers.

## I. INTRODUCTION

### A. Facility Description

The ultimate build out of this facility strategically located in the Midwest is approximately 400 000 ft<sup>2</sup> of a colocation (CoLo) data center white space and containers that will be supported by 250 000 ft<sup>2</sup> of Central Utility Building and approximately 25 000 ft<sup>2</sup> of office and support space. The data center will ultimately support approximately 59.4 MW of critical load.

The first completed phase of the facility, Phase I, is approximately 200 000 ft<sup>2</sup> of data center space, which consists of 95 000 ft<sup>2</sup> of standard CoLo-type white space and 96 000 ft<sup>2</sup> of container-based data facility, as well as 125 000 ft<sup>2</sup> of utility/mechanical plant space. The utility/mechanical plant

Manuscript received January 31, 2012; accepted May 24, 2012. Date of publication April 16, 2013; date of current version July 15, 2013. Paper 2012-PSEC-027, presented at the 2012 IEEE/IAS Industrial and Commercial Power Systems Technical Conference, Louisville, KY, USA May 20–24, and approved for publication in the IEEE TRANSACTIONS ON INDUSTRY APPLICATIONS by the Industrial and Commercial Power Systems Committee of the IEEE Industry Applications Society.

D. C. McDermit was with Turner Construction Company, Chicago, IL 60603 USA. He is now with the Data Center Development Division, Microsoft, Chicago, IL 60601 USA (e-mail: [chicago.dan@hotmail.com](mailto:chicago.dan@hotmail.com)).

D. D. Shipp and T. J. Dionise are with the Power Systems Engineering Department, Eaton Electrical Group, Warrendale, PA 15086 USA (e-mail: [DavidDShipp@eaton.com](mailto:DavidDShipp@eaton.com); [tom.dionise@ieee.org](mailto:tom.dionise@ieee.org)).

V. Lorch, retired, was with the Power Systems Engineering Department, Eaton Electrical Group, Warrendale, PA 15086 USA (e-mail: [visuthlorch@gmail.com](mailto:visuthlorch@gmail.com)).

Color versions of one or more of the figures in this paper are available online at <http://ieeexplore.ieee.org>.

Digital Object Identifier 10.1109/TIA.2013.2258453

consists of: 1) 12 chillers and cooling towers and associated equipment; 2) thermal storage tanks; 3) air handlers; and 4) critical electrical support equipment, including 12 generators, uninterruptible power supplies, and power distribution units. This equipment supports four CoLo rooms of data center white space. The mechanical and electrical infrastructure also supports the equivalent of seven CoLo rooms of critical load in approximately 50–60 containers (each container is capable of supporting 350 kW of critical load).

### B. Commissioning History

On February 18, 2009, the construction team, commissioning team, testing engineers, and contractors were performing manual open-transition testing from one of the data centers' three main utility feeds to generator power. The Appendix gives an excerpt from sequence of operation testing that was being performed when the first unit substation (USS) had an event where a potential transformer (PT) failed. The Appendix describes each step in detail.

The technician performing the aforementioned sequence of operations, specifically Step #32, noticed that there was an issue with the generator kilowatt reading on the digital feeder protection relay, which caused him to stop and investigate with the normal main–primary unit supply (NM1) closed, the generator main (GM) open, and the water-cooled load banks at 600 kW. During his investigation in the USS room, smoke began to appear from the bus PT truck, i.e., Phase A. The PT was easily de-energized by opening NM1 in manual mode. A quick investigation indicated that there were no primary or secondary fuses blown on the PT.

A similar incident occurred two days later while the technician was setting up to perform the same testing sequences on another USS. The technician had the generator tags cleared and started the associated USS generator to verify parameters. In manual mode, the technician open-transitioned the source back to Utility A. Within a matter of minutes, the technician heard something “pop” and then noticed smoke appearing through the vents in the NM1 (Utility A) section. Upon investigation of the USS, it was noted that there was a PT failure in NM1.

### C. Recognition of a Problem

The project team experienced a series of PT failures that occurred while the commissioning team and equipment vendors were performing open-transition sequence testing while utilizing the feed from UTS-A and the feed from UTS-C. The stress



Fig. 1. Damage to PT but fuses remained intact.

on the project team became heightened, and everyone from the end user down to the technicians working on the equipment was driven to discover the reason for the PT failures. The question arose: Had anyone on the project experienced such an event or had knowledge of similar events? A few of the team members recalled similar events while working on their last data center project that reminded them of the PT failures experienced here. In summary, on the previous data center project, the authors performed an engineering analysis at their facility to simulate the problem observed at the present jobsite.

In the previous report, the authors stated “We are very much aware of how vacuum breaker induced switching transients can cause transformer failure. We have been doing many computer simulated switching transient studies recently to quantify the problem and to verify the solution. A key element to the failure mechanism is short cables between the vacuum breaker and the transformer.” This immediately sent up a red flag to the team electrical manager and others on the team since all of the PT failures occurred around the time of open-transition (switching) operations. Additionally, the distance between the NM1 breakers and the primary side of the transformers is relatively short (contained within the substation itself). We discovered that this facility was potentially experiencing a phenomenon called “transient voltage restriking.” In transient voltage restriking, the combination of variables that can cause transformer failures usually involves a vacuum circuit breaker interrupting inductive loads that are supplied by cast resin power class transformers.

#### D. Failures of PTs During Vacuum Breaker Switching

Fig. 1 shows the PTs that failed during vacuum breaker switching. The photo shows that the PT sustained the damage.

The fuses did not blow and remained intact. Typically, a PT may have on the order of 8000 turns per winding. Close examination of the PT shows that the damage consisted of a series arc. Such damage is indicative of ferroresonance. When the breaker opens, a dc charge is trapped on the stray capacitance of the cable, which is imposed on the primary winding of the PT. The dc trapped charge saturates the iron of the PT, which fatigues the winding insulation. The frequency of the PT ferroresonance observed at this facility was about 20 Hz. In this special case of ferroresonance called PT saturation, the PT may draw only 0.1 A, which is not enough to blow the fuse on the PT primary. Consequently, the series arc could last for hours or up to weeks until the insulation breaks down, at which point ionized gasses are produced, and a complete fault occurs blowing the fuse. In the worst case, the ionized gasses contained in this confined space develop an arc phase-to-phase-to-phase, i.e., a three-phase fault. This three-phase fault would cause significant damage to the switchgear. Such a failure would result in significant downtime, reducing the reliability of the power delivered to the mission critical loads.

Fortunately, the PT failure mode at this facility was not catastrophic. Instead, after vacuum breaker switching, the following was observed on two separate occasions: 1) The fuse did not blow, but smoke came out of the PT compartment; and 2) the fuses blew before the ionized gasses could take out the entire cell.

#### E. End User Response

Although the PT failures did not result in massive failure, the end user was concerned the PT failure could have escalated into severe damage of the switchgear. The end users’ response was to investigate the event, to develop a test procedure to investigate the root cause of the failed PTs, and to ultimately recommend a solidly engineered correction to the sequence of operation or a re-engineering of the electrical gear itself.

## II. SWITCHING TRANSIENT THEORY

### A. Decision to Do a Study

Fig. 2 summarizes the PT failures at substations USS1B and USS8B on the line and load sides of the 1200-A vacuum circuit breakers. At USS1B, there were both line- and load-side PT failures. At USS8B, there was one line-side PT failure and three load-side PT failures. The figure calls attention to the following issues: 1) a large number of PT failures at two different substations; 2) the failures involved both line- and load-side failures; and 3) the failures occurred with regularity during switching of the 13.2-kV feeders when transitioning from utility to generator. For these reasons, it was decided to create a model of the power system and conduct a switching transients study to determine the root cause of the PT failures. The decision to conduct a switching transients study permitted simulation of a variety of switching events, determination of sensitivity of parameters contributing to the failures, and demonstration of the effectiveness of proposed solutions. Further field testing was placed on hold until the study was completed and the system response was understood.

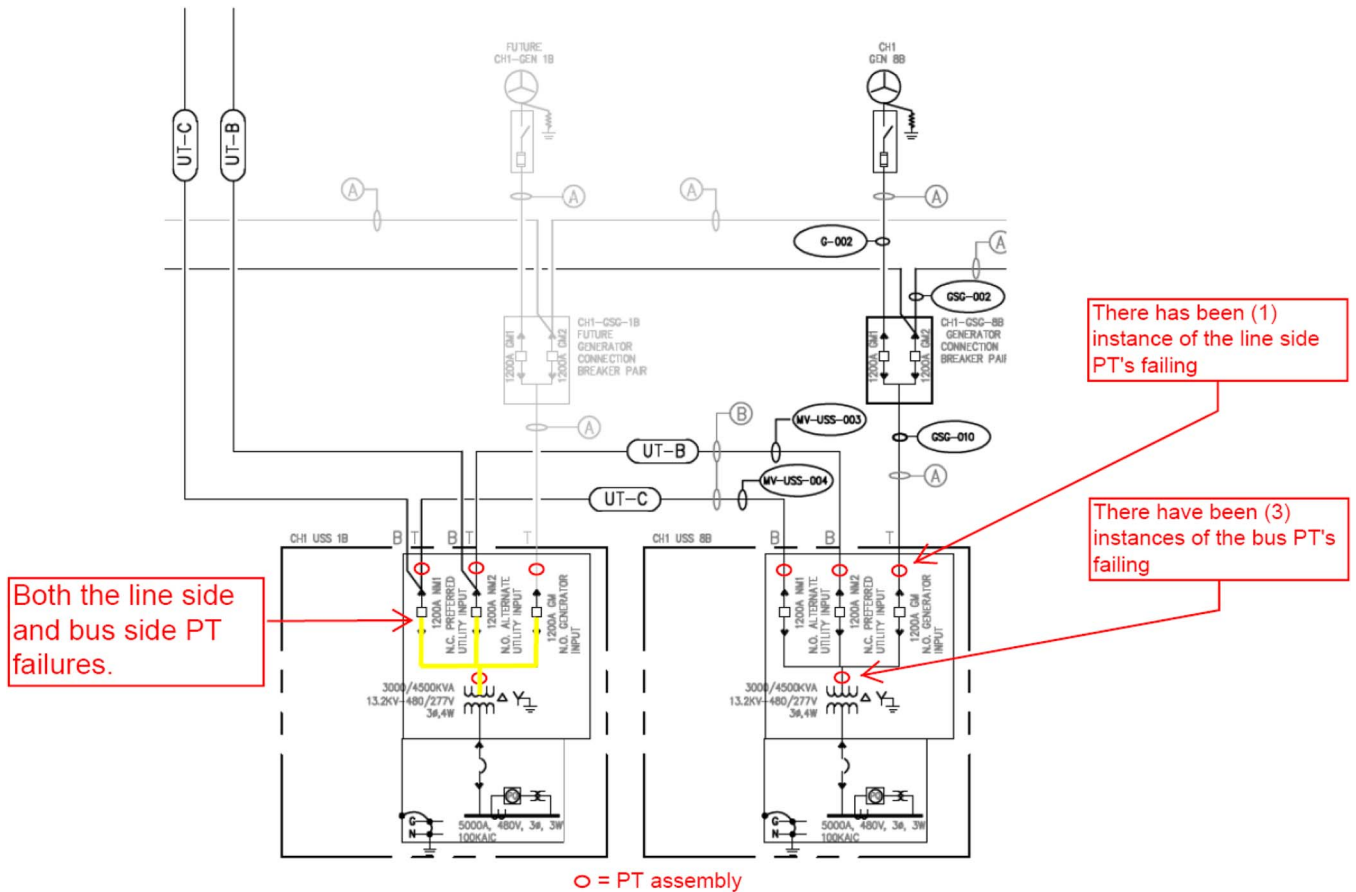

Fig. 2. Summary of PT failures at USS1B and USS8B.

### B. Background on Ferroresonance

The primary focus of this paper was ferroresonance. ANSI/IEEE Std 100-1984 defines ferroresonance as “a phenomenon usually characterized by overvoltages and irregular wave shapes and associated with the excitation of one or more saturable inductors through capacitance in series with the inductor.” The key elements are saturable inductors in series with capacitance. Nonlinear inductance  $X_L$  is usually associated with the core of a transformer. The transformer core will saturate with flux as voltage increases. The transformer has a saturation curve, which gives flux as a function of voltage.  $X_L$  has a high value for nonsaturation, and  $X_L$  has a low value when the core saturates. The saturation curve has a “knee” where the change takes place. Transformers are designed to operate near the “knee.” In the ferroresonant circuit, capacitance  $X_C$  can be the capacitance of cable, overhead line, or stray capacitance of transformer windings or bushings.

Under normal operation,  $X_C$  is smaller than  $X_L$ . However, if some switching event causes the voltage to increase, then the transformer core may be pushed into saturation and  $X_L$  is lowered. It is possible at some higher voltage that this lower saturated value of  $X_L$  may be equal to  $X_C$ , forming a series resonant circuit called ferroresonance. As in the normal series resonant circuit, source voltage  $V_S$  does not change much, but the voltage for nonlinear inductance  $V_L$  and voltage for stray capacitance  $V_C$  increase and oppose each other. Since  $Z_L$  is nonlinear, voltages  $V_L$  and  $V_C$  become distorted or irregular.

Some type of system disturbance is needed to “jolt” the transformer  $X_L$  into a lower saturated value equal to system capacitance  $X_C$ . This “jolt” allows  $X_L = X_C$  and ferroresonance to start. Ferroresonance can continue for a long time (minutes, hours, or even days) since little resistance  $R$  is in the circuit to damp the oscillations.

In the case of this medium-voltage distribution system, the nonlinear inductance is either the 14400/120 V PT or 13.2/0.48 kV, 3000/4500 kVA power transformers. The capacitance is dominated by the stray capacitance of the cables. The “jolt” needed to initiate the ferroresonance is the opening of the vacuum circuit breaker that feeds downstream PTs and the power transformer.

### C. Modeling Ferroresonance

In modeling this medium-voltage distribution system for such ferroresonance analysis, it was important to accurately represent the opening of the primary vacuum breakers, stray capacitance of the cable, and nonlinear inductance of the transformer being switched, i.e., transformer saturation. The authors modeled these critical circuit components in the Electromagnetic Transients Program (EMTP).

The authors’ study approach was to first model the steady-state conditions with the transformer (PT or power transformer) energized. This way, it was possible to show the normal excitation current drawn by the transformer to magnetize the



nonlinear inductance. Next, the authors simulated the actual switching conditions, which produced ferroresonance during transition from utility source to generator source. These opening conditions produced ferroresonance, as evidenced by erratic voltage and current waveforms shown later in this paper. Finally, the authors added mitigation in the form of  $RC$  snubbers to provide damping and mitigate the PT ferroresonance.

The actual switching conditions consisted of opening the 13.2-kV utility feeder to USS8B and closing the 13.2-kV generator feeder breaker. The worst case for ferroresonance occurs with an unloaded transformer. Either a PT or power transformer may experience ferroresonance. On this basis, Eaton examined the electrical distribution system and selected the worst case conditions to check for PT and power transformer ferroresonance. Snubbers sized for this worst case will protect the PT and power transformers during less severe switching operations.

#### D. Computer Simulations of Actual Conditions

Switching transients simulations were conducted in the EMTF to investigate the possible failure of the PT due to transient overvoltages (TOVs) during circuit switching of the vacuum circuit breakers. The circuit model developed in EMTF consisted of the source, breaker, cable, PT, and transformer T-8B. The cable was represented by a Pi model consisting of the series impedance and half of the cable charging at each end. (In some cases, multiple Pi models are used to represent the cable.) The vacuum breaker was represented by a switch with different models for opening (current chop of 5A), restrike [excessive magnitude of transient recovery voltage (TRV)], re-ignition (excessive frequency of TRV), and closing (prestrike). The three-phase transformer model consisted of the leakage impedance, magnetizing branch, and winding capacitance values from high-to-ground and low-to-ground. The PT model included saturation effects. Actual switching scenarios that resulted in PT failures were simulated, and the results of these simulations are described below.

1) *Open Utility-Side 13.2-kV Feeder to USS8B Followed by Closing Generator-Side Feeder (Open Transition to Generator)*: Case N6 simulates the actual case during testing although the transition time in the simulation is much shorter than the actual time. Case N7 is the same as Case N6 but with a snubber installed. Fig. 3 compares the study results for cases N6 and N7 for the primary voltage at the 3000-kVA dry-type transformer T-8B. The application of the snubber circuit (Case N7) greatly reduced the TOV magnitude at the 13.2-kV bus and the oscillation frequency. The oscillation frequency of roughly 22 000 Hz (Case N6) can be reduced to 2000 Hz (Case N7), and the resistor in the snubber circuit will damp the oscillation within 3 ms.

A closer examination of the TOV is given in Fig. 4. Fig. 4 compares the study results for cases N6 and N7 for the primary voltage at the 3000-kVA dry-type transformer T-8B zoomed from 0 to 30 ms. The figure illustrates the opening of the utility-side circuit breaker.

The application of the snubber circuit (Case N7) reduced the TOV from 170-kV peak with an oscillation frequency of

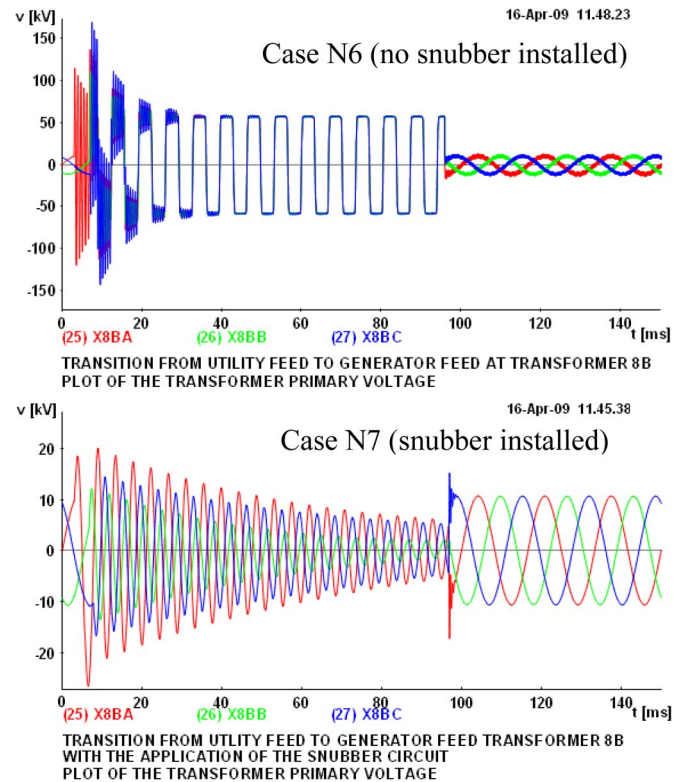

Fig. 3. TOV at USS8B during transition from utility to generator with and without snubber protection.

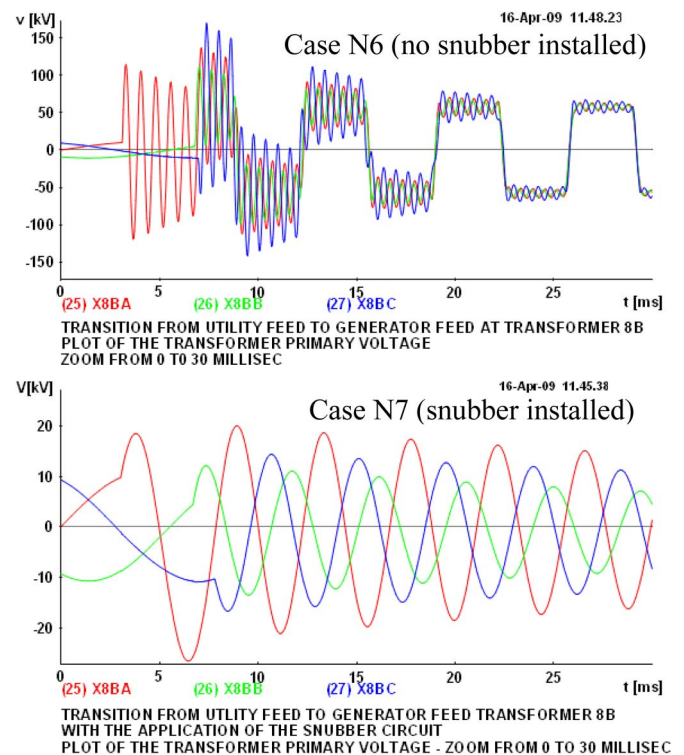

Fig. 4. TOV at USS8B during transition from utility to generator with and without snubber protection (zoom of utility-side breaker opening).

1594 Hz to 26.6-kV peak with an oscillation frequency of 215 Hz. The study also shows a high dc offset for Case N6 due to the energy transfer between the stray capacitor and



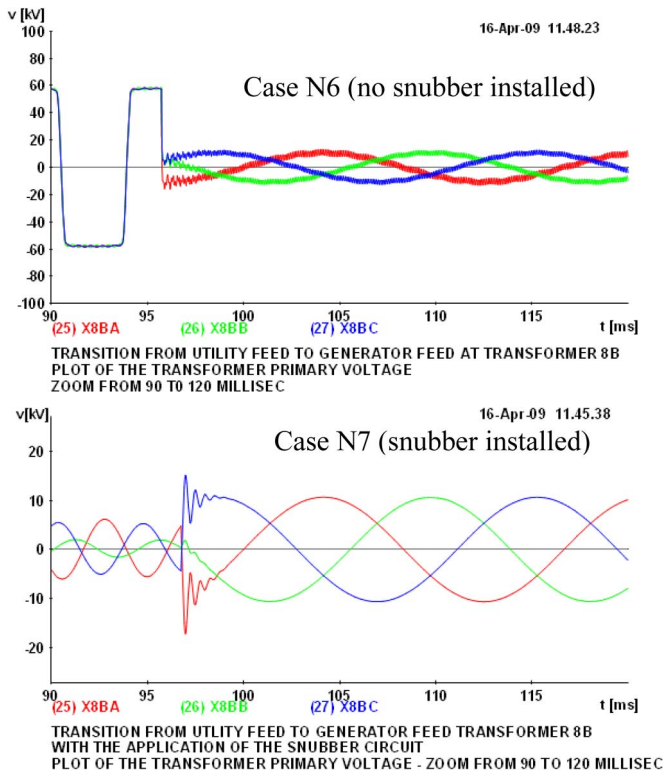

Fig. 5. TOV at USS8B during transition from utility to generator with and without snubber protection (zoom of generator feeder breaker closing).

inductance in transformer T-8B and PT. The magnitude of the TOV may be smaller due to the operation of the surge arrester; however, the oscillation frequency will remain the same.

Similarly, Fig. 5 compares the study results for cases N6 and N7 for the primary voltage at the 3000-kVA dry-type transformer T-8B zoomed from 90 to 120 ms. The figure illustrates closing of the generator-side circuit breaker. The application of the snubber circuit (Case N7) reduced the oscillation frequency from 20 000 Hz (Case N6) to 2000 Hz (Case N7), and the period of transient was reduced from oscillatory down to 3 ms. The oscillatory condition may cause the PT failure over a long period.

2) *Close Generator-Side 13.2-kV Feeder to USS8B (Enhanced Model of Open Transition to Generator)*: Case N8 simulates closing the generator-side feeder breaker with an enhanced model of open transition. Case N9 is the same as Case N8 but with the snubber installed. Fig. 6 compares the study results for cases N8 and N9 for the primary voltage at the 3000-kVA dry-type transformer T-8B. The application of the snubber circuit (Case N9) reduced the oscillation frequency from 22 700 Hz (Case N8) to 1486 Hz (Case N9), and the resistor in the snubber circuit will damp the oscillation within 3 ms. Again, the oscillatory condition may cause the PT failure over a long period.

Fig. 7 illustrates the study results for Case N8 for the primary voltage at the 3000-kVA dry-type transformer T-8B. The figure was zoomed from 5 to 10 ms, and the resonance condition is clearly illustrated in the figure. The simulated ferroresonance condition in Fig. 7 is a near match for the ferroresonance

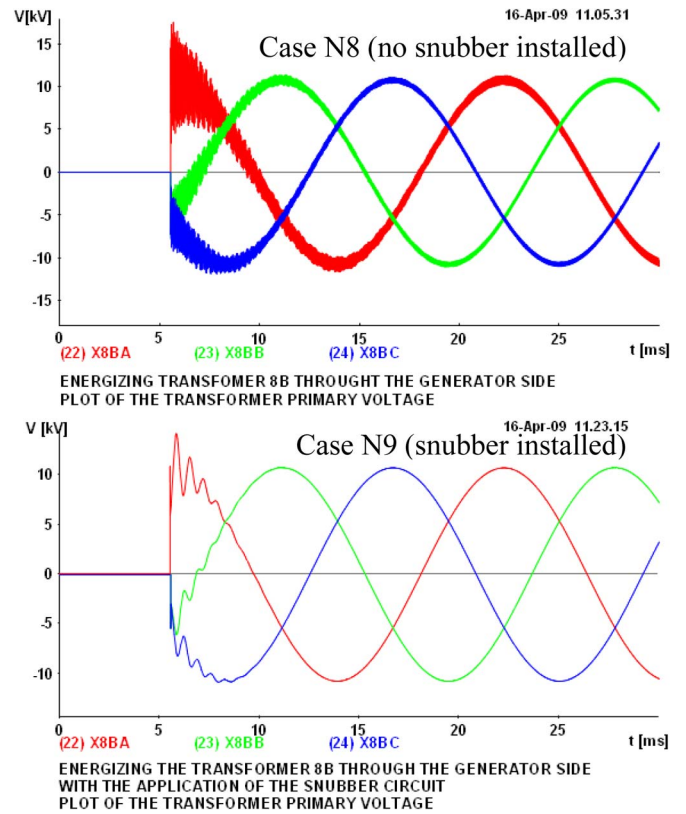

Fig. 6. TOV at USS8B during energization of transformer T-8B from the generator with and without snubber protection.

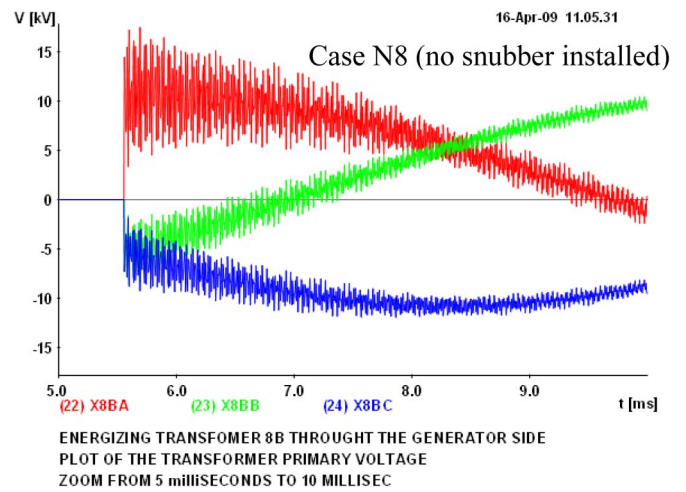

Fig. 7. TOV at USS8B during energization of transformer T-8B from the generator with and without snubber protection (zoom of ferroresonance).

condition captured with the high-speed power quality meter in Fig. 9.

Fig. 8 compares the study results for cases N8 and N9 for the bus voltage at USS1B. Since this location is only 10 ft from bus USS8B, the results will be similar to the primary voltage at the 3000-kVA dry-type transformer T-8B. The application of the snubber circuit (Case N9) reduced the oscillation frequency from 22 700 Hz (Case N8) to 1485 Hz (Case N9), and the resistor in the snubber circuit will damp the oscillation within

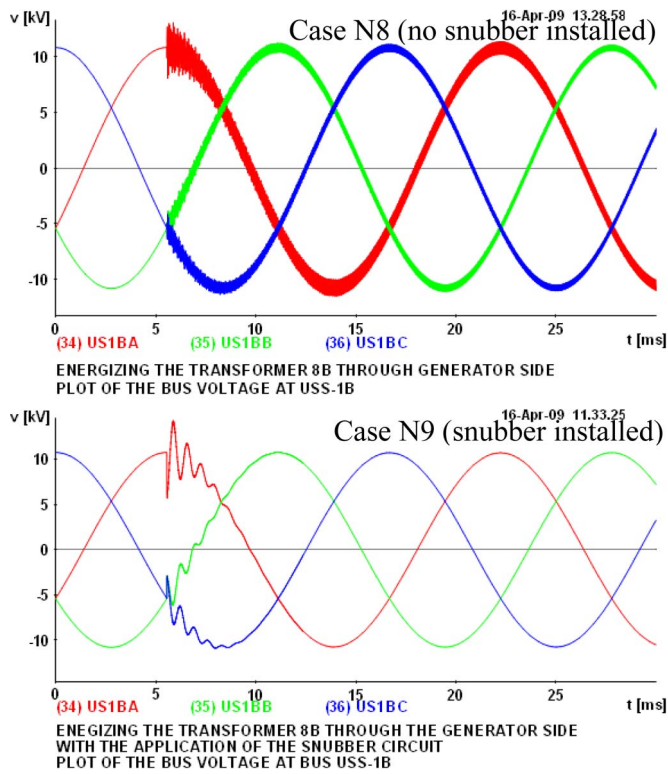

Fig. 8. TOV at USS1B during energization of transformer T-8B from the generator with and without snubber protection.

3 ms. Again, the oscillatory condition may cause the PT failure over a long period.

3) *Comparison of PT Connections—Open Utility-Side 13.2-kV Feeder to USS8B*: The PTs that failed were connected wye-grounded–wye-grounded ( $Y_g - Y_g$ ). The analysis was expanded to consider the benefit, if any, of the open-delta PT connection. In Case T3, there is a nominal load of 100 kW with 0.97 lagging power factor on transformer T-8B. The 13.2-kV circuit breaker is opened on the utility-side feeding transformer T-8B. First, the  $Y_g - Y_g$  PT connection was considered with no snubber. Fig. 9(a) shows the transformer T-8B primary voltage. After breaker opening, the TOV was as high as 103.61 kV with an oscillation frequency of 1378 Hz. Such a TOV will result in re-ignition of the breaker and a higher TOV.

Next, in Case T4, the  $Y_g - Y_g$  PT connection with a snubber was considered. Fig. 9(b) shows the transformer T-8B primary voltage. After breaker opening, the TOV was reduced from 103.61 kV (Case T3) to 17.413 kV (Case T4). The oscillation frequency was reduced from 1378 Hz (Case T3) to 214 Hz (Case T4). However, the PT ferroresonance is not eliminated due to the PT connection of  $Y_g - Y_g$  in the temporarily ungrounded circuit during open transition.

Finally, in Case T5, the open-delta PT connection with a snubber was considered. Fig. 9(c) shows transformer T-8B primary voltage. After breaker opening, the TOV was reduced from 103.61 kV (Case T3) to 17.416 kV (Case T5). The oscillation frequency was reduced from 1378 Hz (Case T3) to 214 Hz (Case T5). With the PT-connected open delta, the PT ferroresonance is eliminated. Adding a resistor to the PT equal to 50% of the burden will assist in damping the ferroresonance.

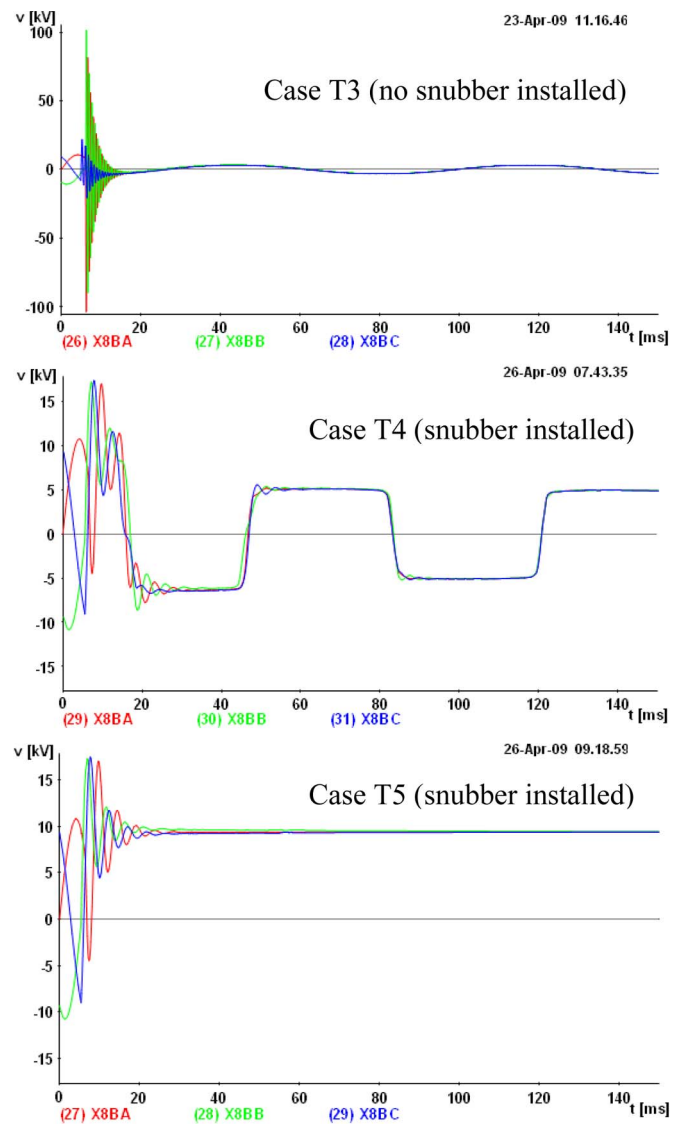

Fig. 9. Open utility-side 13.2-kV feeder to USS8B with (a)  $Y_g - Y_g$  PT, (b)  $Y_g - Y_g$  PT with snubber, and (c) open-delta PT with snubber.

### E. Solutions Involving Snubbers, Grounding, and Ferroresonance Elimination

1) *Snubbers*: Once the need for snubbers was determined, the surge capacitor was selected. The surge capacitor was selected based on system voltage. Years of experience have shown the industry that certain values work well for given applications. For example, a 0.25- $\mu$ F surge capacitor works well for most 15-kV-class applications. This value does a good job of slowing down fast transients to be within the  $dV/dt$  rating of 15-kV-class transformers, switchgear, motors, generators, etc. The capacitor industry makes these surge caps with standard available values. Alternatively, one could carefully evaluate the ring waves and fine tune the natural frequency to meet a special value, but such a fine-tuned approach generally requires a custom build, i.e., special capacitance values with long delivery times. Such custom values are not required, and the long lead times did not meet the schedule of the project. Once the need for snubbers was determined, the first attempt was to use standard available surge caps for that voltage level.

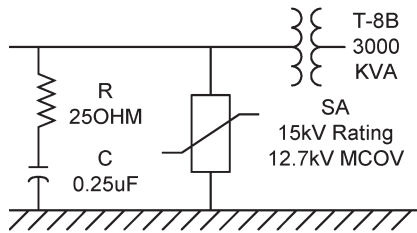

Fig. 10. Snubber specifications and surge arrester arrangement for the transformer protection.

First, the resistor was sized to match the surge impedance of the source cable feeding the circuit. In this case, two cables were addressed. The surge impedance of the utility source cables was about  $30 \Omega$ , whereas that of the generator cables was about  $20 \Omega$ . Since the snubber must take care of both conditions,  $25 \Omega$  was selected as a compromise. The authors have found that a perfect match is not required, but rather a few ohms difference is effective. By matching the resistor to the cable surge impedance, the high-frequency waveform impinging on the circuit will not double due to reflection. The resistor cancels the reflection and provides damping, particularly for the dc offset voltage, that causes ferroresonance.

Next, the snubber values were entered into the computer model in EMTP. (EMTP is recognized worldwide as the premier tool for transient analysis of power systems.) In EMTP, the switching transients were simulated to ensure that the selected snubber components actually accomplished their objective. The discharge current through the resistor was evaluated for three criteria: 1) the joule (or equivalent watt rating) must be well within thermal ratings; 2) the switching transient voltages must be well below basic impulse insulation level; and 3) the  $dV/dt$  must be well below transformer limits. All three criteria must be satisfied. For 15-kV transformers, if the ring wave frequency can be reduced to between 250 and 1000 Hz, then there will be no problem. This final simulation also proves that the natural frequency is not too low to cause other problems. Once the surge capacitor was added, its capacitance dominated over the other capacitance values in the entire circuit and reduced the oscillation frequency to an acceptable value.

The specifications for the  $RC$  snubber circuit are given in Fig. 10. The resistor average power rating is 750 W at  $40^\circ\text{C}$ , and the peak energy rating is 16 000 J. This snubber was applied at other locations in the system. Although cable surge impedance varies somewhat from location to location, this snubber circuit provides adequate mitigation of the voltage transients produced by the vacuum breaker at this location. Selection of one set of  $RC$  snubber values simplifies the design and installation, i.e., only one type of resistor and capacitor must be used. The 13.2-kV  $RC$  snubber circuit is required at every 13.2/0.48 kV transformer.

2) *Grounding*: The wiring methods and grounding means for the 13.2-kV system were inspected. The evaluation included the method of grounding; effectiveness of all connections; presence of ground loops; and compliance with the NEC, FIPS 94, and other applicable standards. The evaluation determined both the utility substation and the generation plant had well-designed ground mats that provided effective grounding for their respec-

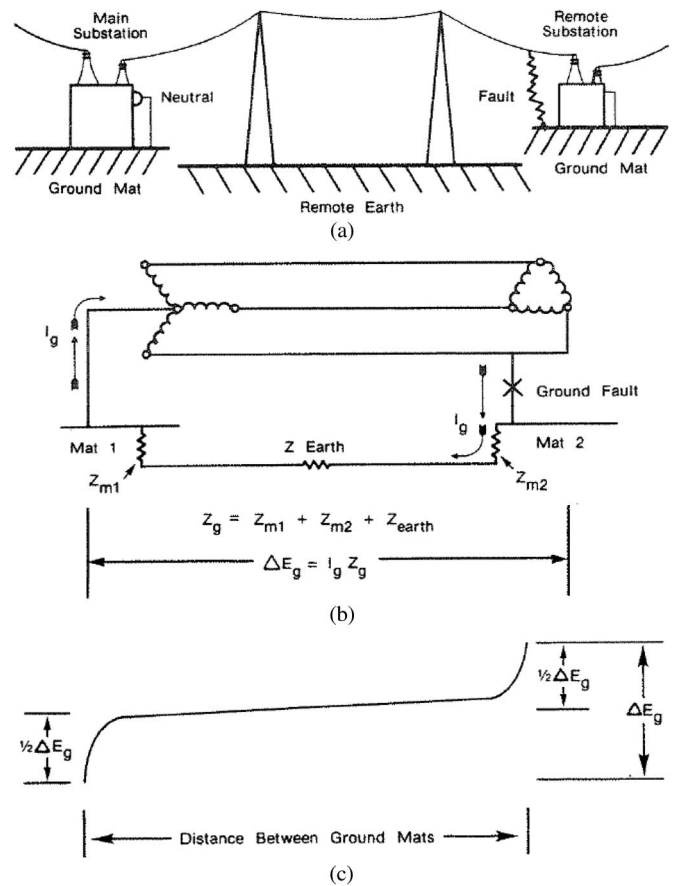

Fig. 11. Transferred earth potentials. (a) Typical substation. (b) Fault current path. (c) Fall of potential distribution.

tive electrical equipment. However, it was noted that the ground mats were not tied together. Conduit was relied upon to make this connection, but the use of polyvinyl chloride in several locations broke the continuity.

As a result, ground mats would be exposed to transferred earth potentials during switching and lightning, imposing a potential difference on such components as surge arresters, cable shields, and  $Y_g - Y_g$  PTs. Transferred earth potentials refer to the phenomena of the earth potential of one location appearing at another location where there is a contrasting earth potential. The transfer of potentials may occur over conductors that have been purposely placed between the two locations. For example, consider the situation in Fig. 11. A ground fault occurs at the remote substation between the primary transformer busing and its respective ground mat. The return path for the ground fault current is through the earth back to the main substation ground mat and its respective system ground.

This earth return path will have a finite amount of impedance  $Z_g = R_g + jX_g$ , where  $R_g$  is the earth resistance and  $X_g$  is the earth reactance between the two substation ground mats. The potential difference between the mats is given by

$$\Delta E_g = I_g Z_g. \quad (1)$$

Any electrical conductors, which may extend from within one substation to within the other, may be subject to this potential difference  $\Delta E_g$ . When  $\Delta E_g$  is high, due to excessively



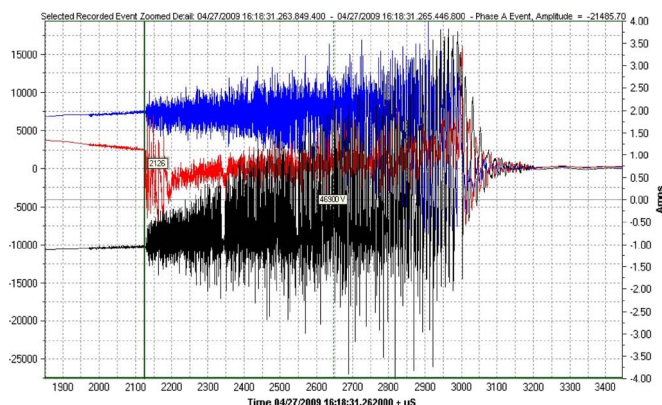

Fig. 12. Switching transient capture at PT.

high ground fault currents or excessive earth impedance  $Z_g$ , serious voltage stresses may be imposed upon various system components never designed to withstand them. For this facility with independent ground mats, high-frequency impulses on vacuum circuit breaker closing may cause momentary voltage differences between the ground mats. This imposes a potential difference on the PTs well above the rated line-to-ground voltage, forcing the PT into saturation.

### III. MEASUREMENTS

#### A. Before Solutions

Prior to the installation of the snubbers, several transients were captured on one of the USSs. One of these is shown in Fig. 12. It was noted that the lower load levels resulted in higher overpotential and higher  $dV/dt$  signals being developed from the breaker operations. Before installing snubbers, the captured screen shot in Fig. 12 was obtained when utility feeder NM1 was opened at 300 kW showing a high level of  $dV/dt$  signal. It was noted that the duration and peak voltage of the transient had increased from previous test sequences at higher load levels. The peak voltage measured was 49.6 kV, and the duration was 876  $\mu s$ .

#### B. Test Equipment Selection

The system under test consisted of a 4.5-MVA dry transformer connected delta-wye with PTs connected  $Y_g - Y_g$ . The medium-voltage power transfers were performed by vacuum breakers. Three 13.2-kV sources power the substation: 1) utility source UTS-A to the NM1 breaker; 2) UTS-C to NM2; and 3) GEN11B through the generator output breaker (GM1) to the substation breaker GM. Test probes were installed on each phase of the line side of each substation breaker and one set at the line side of the transformer. Each test set consisted of a laptop, a power quality meter, three voltage divider (100/1 ratio) probes, and connecting wires, as shown in Fig. 13 and described further in Table I.

#### C. Personnel Safety Issues at 13.2 kV

To perform this test, the specialized test equipment was installed at USS11B. The installation of these devices sig-

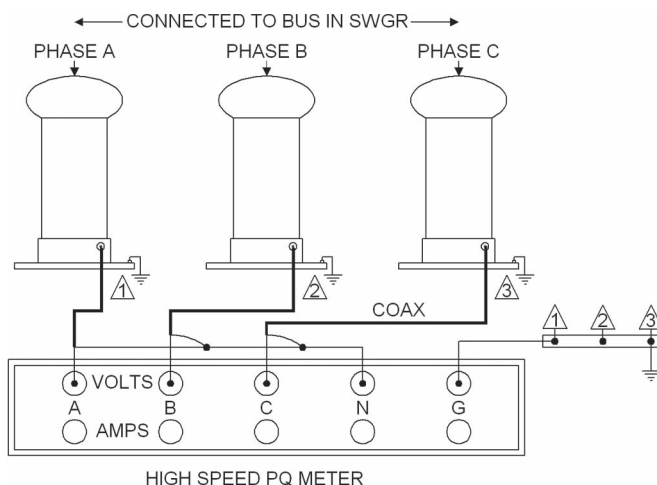

Fig. 13. Voltage dividers and PQ meter for high-speed transient capture.

TABLE I  
EQUIPMENT FOR SWITCHING TRANSIENTS MEASUREMENTS

Test Equipment	Quantity
3000 kW Resistive Load Bank with Step Capability	1
Power Quality Meter	4
Medium Voltage Probe assemblies	4
Laptop PC (Minimum)	2
UPS back power to Power Quality Meters	4 outlets

TABLE II  
TEST PREREQUISITES AND PRECAUTIONS

Step	Description
1	Review the Emergency Action Plan and Job-Hazard-Analysis with all affected personnel.
2	Verify there is no work in progress that will de-energize the lighting panel UP-11A., this panel supplies the outlets used for test equipment.
3	Place circulating fans or smoke detectors in corridor to alleviate smoke in the event of a discharge. Do not turn them on, a quiet airspace is required to detect imminent PT failure.
4	Secure two CRU in USS-11B room to ease the audible detection of PT failure.
5	Install rubber matting or plastisol covers for the connections inside of the board.
6	Station electrical personnel in both the UST station and hallway outside of USS-11B room with two way radios to open the respective breaker in case of PT failure.
7	Ensure test devices are time synchronized, and recorders are powered from UPS.
8	Post the USS-11B and USS-7B with Hazard Warning signs and red tape the room to restrict entrance.
9	Inspect all barriers are in place inside of room
10	Verify all personnel are clear of USS-11B and USS-7B rooms
11	Inform Operations of test about to take place
12	Pre-brief the procedure and roles of all personnel

nificantly changed the hazard in the area. Specialized pretest briefings were implemented to verify all participants were aware of their roles, as well as the hazards of the test procedure. Additionally, steps were implemented to isolate USS11B from USS7B. This simplified the test and the model. Table II gives the most important prerequisites and precautions.

TABLE III  
SUMMARY OF TEST CONDITION SIMULATIONS

Load	PT connection	Snubber	TOV magnitude (kV)	TOV frequency (Hz)	Final offset (kV)	Ferro resonance
100kW @ 0.97PF	Yg Yg	N	103.6	1378	3.15	Y
	Yg Yg	Y	17.4	214	N/A	Y
	Open Delta	Y	17.4	214	N/A	N
300kW @ 0.97PF	Yg Yg	N	75.9	1894	5.29	Y
	Yg Yg	Y	13.5	364	N/A	Y
	Open Delta	Y	13.5	365	N/A	N
600kW @ 0.97PF	Yg Yg	N	53.7	2755	8.68	Y
	Yg Yg	Y	13.5	467	N/A	Y
	Open Delta	Y	13.5	467	N/A	N
1200kW @ 0.97PF	Yg Yg	N	44.1	3367	10.1	Y
	Yg Yg	Y	13.1	467	N/A	Y
	Open Delta	Y	13.1	467	N/A	N

#### D. Test Procedures to Assure Testing Will Not Fail the PT or 3-MVA Transformer (Sneak up on Problem)

A testing scheme was developed to create individual breaker closing and opening electrical transients at four discrete load levels on USS11B: 1200, 600, 300, and 100 kW. These events were evaluated by all parties involved, and concurrence was given to proceed to the next test step. This test was designed to approach the potentially more damaging conditions in a deliberate manner. Prior to conducting the actual tests, each test condition was simulated in EMTP. Table III summarizes the results of the simulations of the test conditions. As can be seen in the results, as the load level on the transformer was reduced, the severity of the switching TOV, ring frequency, and ferroresonance condition increased. This advance knowledge of the system response enabled careful tracking of the field test results. Should the field results depart dramatically from the predicted response, the test could be stopped. This way, it was possible to “sneak-up” on the problem.

#### E. Confirmed Problem Existed

Testing began with no snubbers and the 1200-kW load and proceeded down to the 300-kW load. The test sequences prior to the snubber installation were terminated at this point at the concurrence of the design engineers, facility operators, and the authors because the symptoms of TOVs and  $dV/dt$  were worsening with each lower load increment. Fig. 12 shows the worst of TOV captured at the PT. All parties were satisfied that the root cause of the PT failure was determined without actually failing a PT. Next, the snubbers were installed, and the captured screen shot in Fig. 14 was obtained when utility feeder

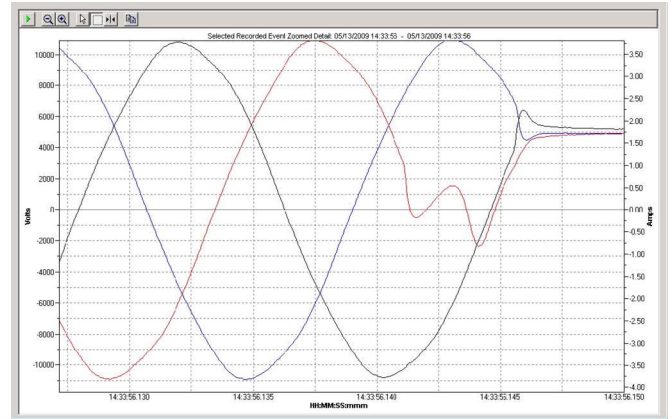

Fig. 14. Switching transient mitigated by  $RC$  snubber.

NM1 was opened at 300-kW load. The snubbers eliminated the  $dV/dt$  transient response, and no TOVs occurred at the PTs, as shown in the voltage waveforms in Fig. 14. All parties involved were satisfied that the snubber was effective in mitigating both the  $dV/dt$  and TOV problem. The client was confident that system reliability would not be compromised.

## IV. SOLUTIONS

Given that the facility was in the final stages of commissioning, a solution had to be both economical and timely. Using this criterion, three technically sound solutions were proposed and evaluated. Ultimately, two of the three proposed solutions were implemented as explained below.

#### A. Change to Different PT Connections (Rejected)

The PTs that failed were connected  $Y_g - Y_g$ . In fact, all of the PTs on the 13.2-kV circuits were of the same configuration. The analysis has shown the benefit of the open-delta PT over the  $Y_g - Y_g$  PT, even when the snubber is applied in both configurations. With the open-delta PT, the ferroresonance was completely eliminated. However, with the  $Y_g - Y_g$  PT ferroresonance of about 20 Hz persists. The authors discussed replacing the existing  $Y_g - Y_g$  PTs with open-delta PTs. However, it became apparent that this would be cost prohibitive for several reasons: 1) The relays would have to be changed; 2) metering would have to be changed; 3) commissioning would have to be repeated because commissioning was in the final stages; and 4) the project was nearly completed and such a change out would add significant delay. For these reasons, the possibility of changing to different PT connections was rejected.

#### B. Tie Ground Mats Together (Implemented)

As explained, the different ground mats, i.e., utility substation ground grid and generation plant ground grid were not tied together resulting in transferred earth potentials. Such transferred earth potentials would occur during switching and lightning, imposing a potential difference on such components as surge arresters, cable shields, and  $Y_g - Y_g$  PTs. One solution was to increase the insulation strength of the affected equipment. Another option was to tie the ground mats together. The



Fig. 15. RC snubber (typical installation for this facility).

former option would require replacement of equipment, which was undesirable for many of the same reasons mentioned in regard to changing the PT connections. The latter option required minimal investment in an equipment grounding conductor (EGC) and the labor to install the EGC. For these reasons, the authors recommended tying the ground mats together to minimize the transferred earth potential. An EGC was installed outside the conduit runs between the utility substation and the generation plant, and the EGC was bonded to the corresponding ground mats.

#### C. Add Snubbers as Paper Dictated (Implemented)

This paper showed that the application of the snubber circuit greatly reduced the TOV magnitude and oscillation frequency at the 13.2-kV PT and transformer T-8B primary winding. The resistor in the snubber circuit damped the oscillation and reduced the dc offset of the TOV to within acceptable levels. Furthermore, this paper showed that the snubber reduced the ferroresonance of the  $Y_g - Y_g$  PT by providing a source of damping that would otherwise not be present. The snubber, in combination with the existing surge arrester, provided the maximum surge protection for the PT and transformer T-8B. The snubber components were of relatively low cost and readily available. The snubbers did not require any modifications to the PT circuit, relaying, or meters. The performance of the snubbers was proved by measurements and did not require repeating the commissioning tests. For these reasons, it was decided to install the snubbers.

#### D. Prove Solution With After-the-Fact Measurements

Following installation of the snubbers, power quality measurements were taken to ensure the proper operation of the

snubbers. A high-speed power quality meter and capacitive voltage dividers were used to measure the TOV waveforms at the PT and transformer primary produced during switching of the primary vacuum circuit breaker. The voltage dividers were made of capacitive and resistive components with a bandwidth of 10 MHz. The power quality meter was capable of transient voltage wave shape sampling, 8000-V<sub>peak</sub> full scale, and 200-ns sample resolution (5-MHz sampling). This test equipment ensured accurate capture of the high-frequency transients. The measurements verified that the waveforms did not exhibit excessive high-frequency transients (magnitude, rate of rise, and frequency). The measurements also verified that the PT ferroresonance condition was damped out.

#### E. Typical Snubber Installation

Fig. 15 shows the side view of the custom snubber circuit. The custom design was required to fit the snubber at the bottom of the transition section between the No. 3 breaker section and the transformer. The snubber was field installed at the bottom of the transition section. The surge capacitor serves as the base. The resistor is bonded to the surge capacitor bushing and the bus bar, where the cables to the transformer are secured. The flanges on each end of the resistor provide a solid support for the fragile resistors. The capacitor was grounded to the ground bus through a flat-braided highly stranded strap. The snubber was treated like a lightning arrester, i.e., no fuse was installed.

## V. CONCLUSION

This paper has provided a detailed investigation of several PTs that failed catastrophically during switching medium-voltage circuit breakers to transition from utility to generator. Switching transient simulations and field measurements determined that the root cause of PT failure was ferroresonance and switching TOVs associated with opening and closing the primary vacuum breakers. The analysis determined that the close-coupled power transformers were also in jeopardy. This paper showed that the application of the snubber circuit greatly reduced the TOV magnitude and oscillation frequency at the PT and power transformer primary winding. The resistor in the snubber circuit damped the oscillation and reduced the dc offset of the TOV to within acceptable levels. Furthermore, this paper showed that the snubber reduced the ferroresonance of the  $Y_g - Y_g$  PT by providing a source of damping that would otherwise not be present. In addition, grounding improvements were made by tying together the ground mats in the utility substation and generator plant to minimize the transferred earth potentials imposed on the PT primary winding. High-speed switching transient measurements verified the analysis and proved that the surge protective device solution (arresters and snubbers) was effective.

## APPENDIX

Table IV gives an excerpt from the sequence of operation testing that was being performed when the first USS had an event where a PT had a failure. The PT failure occurred during the performance of step 32 described in the table below.



TABLE IV  
SEQUENCE OF OPERATION TESTING

Step	Description of Task
1	Loss of both Utilities
2	Loss of Preferred Utility (UT1) with Generator Selected
3	Loss of Preferred Utility (UT2) with Generator Selected
4	Automatic Return from Loss of Utility with USS on generator (Closed Transition, NM1 Preferred)
5	Automatic Return from Loss of Utility with USS on generator (Closed Transition, NM2 Preferred)
6	Open Transition Return to Utility with USS on Generator, NM1 Preferred
7	Open Transition Return to Utility with USS on Generator, NM2 Preferred
8	Manually Initiated Return to Utility (with load on generator and closed transition), NM1 Preferred
9	Manually Initiated Return to Utility (with load on generator and closed transition), NM2 Preferred
10	Loss of Preferred Utility (UT1) with Utility Selected
11	Loss of Preferred Utility (UT2) with Utility Selected
12	Automatic Return from Loss of Utility with USS on Alternate Utility (Closed Transition), NM1 Preferred.
13	Automatic Return from Loss of Utility with USS on Alternate Utility (Closed Transition), NM2 Preferred.
14	Open Transition Return to Utility with USS on Alternate Utility, NM1 Preferred.
15	Open Transition Return to Utility with USS on Alternate Utility, NM2 Preferred.
16	Manually Initiated Return to Utility (with load on alternate utility and closed transition), NM1 Preferred.
17	Manually Initiated Return to Utility (with load on alternate utility and closed transition), NM2 Preferred.
18	Manually Initiated Return to Utility (with load on Alternate Utility and open transition), NM1 Preferred
19	Manually Initiated Return to Utility (with load on Alternate Utility and open transition), NM2 Preferred
20	Power Transfer Test (Utility Unload Mode), NM1 Preferred.
21	Power Transfer Test (Utility Unload Mode), NM2 Preferred.
22	Power Transfer Test (Generator Unload Mode), NM1 Preferred.
23	Power Transfer Test (Generator Unload Mode), NM2 Preferred.
24	Utility Select from Utility A to Utility B- OPEN TRANSITION and from Utility B to Utility A.
25	Loss of Preferred Utility (UT1) with GENERATOR Selected (USS 1-7)
26	Loss of Preferred Utility (UT2) with GENERATOR Selected (USS 1-7)
27	Close Transition Return to Utility with USS on Alternate Utility, NM1 Preferred. (USS 1-7)
28	Close Transition Return to Utility with USS on Alternate Utility, NM2 Preferred. (USS 1-7)
29	Manual Mode-Loss of Preferred Utility (UT1)
30	Manual Mode-Open-Transition Transfer from Generator to UTS1
31	Manual Mode-Open Transition Transfer from Generator to UTS2
32	Manual Mode-Close-Transition Transfer from UTS1 to Generator

#### ACKNOWLEDGMENT

The authors would like to thank Turner Facilities Management Solutions and Eaton Power Systems Engineering for their collaboration in the presentation of this paper; D. Wilder, T. McConnell, and R. Hammoudeh of Turner and B. Vilcheck of Eaton; and S. Seaton.

#### REFERENCES

- [1] *IEEE Standard Dictionary of Electrical and Electronics Terms*, ANSI/IEEE Std. 100-1984, 1984.
- [2] R. H. Hopkinson, *Ferroresonant Overvoltage's Due to Open Conductors*. Fairfield, CT, USA: General Electric, 1967, pp. 3–6.
- [3] *Westinghouse Distribution Transformer Guide*, Westinghouse Electric Corp., Distribution Transformer Division, Athens, GA, USA, pp. 36–40, Jun. 1979, revised April 1986, Chapter 4 Ferroresonance.
- [4] *IEEE Guide for Application of Transformers*, ANSI/IEEE Std. C57.105-1978, 1978, Chapter 7 Ferroresonance.
- [5] *Distribution Technical Guide*, Ontario Hydro, Toronto, ON, Canada, pp. 72.1-1–72.1-10, May 1999, original issue May 1978.
- [6] A. Greenwood, *Electrical Transients in Power Systems*. Hoboken, NJ, USA: Wiley, 1971, pp. 91–93.
- [7] L. Kojovic and A. Bonner, *Ferroresonance—Culprit and Scapegoat*. Waukesha, WI, USA: Cooper Power Systems, The Line, Dec. 1998.
- [8] Shipp, Dionise, Lorch, and MacFarlane, “Transformer failure due to circuit breaker induced switching transients,” *IEEE Trans. Ind. Appl.*, vol. 47, no. 2, pp. 707–718, Apr./May 2011.
- [9] *A Guide to Describe the Occurrence and Mitigation of Switching Transients Induced by Transformer and Switching Device Interaction*, ANSI/IEEE Std. C57.142-2010, 2010.

- [10] D. Shipp and R. Hoerauf, “Characteristics and applications of various arc interrupting methods,” *IEEE Trans. Ind. Appl.*, vol. 27, no. 5, pp. 849–861, Sep./Oct. 1991.
- [11] *Standard for AC High-Voltage Generator Circuit Breakers on a Symmetrical Current Basis*, ANSI/IEEE Std. C37.013-1997, 1997.
- [12] *Application Guide for Transient Recovery Voltage for AC High-Voltage Circuit Breakers*, ANSI/IEEE Std. C37.011-2005, 2006.
- [13] D. Durocher, “Considerations in unit substation design to optimize reliability and electrical workplace safety,” in *Proc. IEEE IAS/ESW*, Memphis, TN, USA, 2010, pp. 3–16.
- [14] D. Shipp and N. Nichols, “Designing to avoid hazardous transferred earth potentials,” *IEEE Trans. Ind. Appl.*, vol. IA-18, no. 4, pp. 340–347, Jul. 1982.
- [15] Shipp, Dionise, Lorch, and MacFarlane, “Vacuum circuit breaker switching transients during switching of an LMF transformer,” *IEEE Trans. Ind. Appl.*, vol. 48, no. 1, pp. 37–44, Jan./Feb. 2012.



**Daniel C. McDermit** received the B.S.C.M. degree from Michigan State University, East Lansing, MI, USA, in 1989.

He is currently a Senior Program Manager in the Data Center Development Division, Microsoft's Global Foundation Solutions, Microsoft, Chicago, IL, USA. He has been working in the construction industry for more than 25 years and has extensive experience in construction, estimating, planning, and supervising projects. Since 1997, he has built more than 30 data centers around the USA ranging from a 10 000-ft<sup>2</sup> Tier III data center to a one-of-a-kind 700 000-ft<sup>2</sup> Tier III data center project in the Midwest. He has extensive knowledge in the technical aspects of building construction, namely, architectural, structural, electrical, mechanical, plumbing, fire protection and detection, structured cabling (LAN/WAN), telecommunications, and security systems.



**David D. Shipp** (S'72–M'72–SM'92–F'02) received the B.S.E.E. degree from Oregon State University, Corvallis, OR, USA, in 1972.

He is a Principal Engineer in the Electrical Services and Systems Division, Eaton Corporation, Warrendale, PA, USA. He is a distinguished scholar in power system analysis and has worked in a wide variety of industries. He spent ten years as a Professional Instructor, teaching full time. He occasionally serves as a legal expert witness. He has written more than 80 technical papers on power system analysis topics. More than 12 technical papers have been published in IEEE/Industry Applications Society (IAS) national magazines and two in *EC&M*. He has spent many years performing the engineering work associated with his present-day responsibilities, which include a wide range of services covering consulting, design, power quality, arc flash, and power systems analysis topics. Over the last few years, he has pioneered the design and application of arc flash solutions, modifying power systems to greatly reduce incident energy exposure.

Mr. Shipp helps write the IEEE Color Book series standards. He is currently the Chair of the IEEE I&CPS-sponsored Working Group on generator grounding. He was the recipient of the 2011 Richard Harold Kaufmann Award for improving electrical equipment and systems reliability and workplace safety in a number of industries, an IAS/IEEE Prize Paper Award for one of his papers, and conference prize paper awards for six others.



**Thomas J. Dionise** (S'79–M'82–SM'87) received the B.S.E.E. degree from The Pennsylvania State University, University Park, PA, USA, in 1978 and the M.S.E.E. degree with the power option from Carnegie Mellon University, Pittsburgh, PA, in 1984.

He is currently a Power Quality Engineering Specialist in the Power Systems Engineering Department, Eaton Corporation, Warrendale, PA. He has more than 30 years of power system experience involving analytical studies and power quality investigations of industrial and commercial power systems.

In the metals industry, he has specialized in power quality investigations, harmonic analysis, and harmonic filter design for electric arc furnaces, rectifiers, and variable-frequency-drive applications.

Mr. Dionise is a Licensed Professional Engineer in Pennsylvania. He is the Chair of the Metals Industry Committee and a member of the Generator Grounding Working Group of the IEEE Industry Applications Society (IAS). He had an active role in the committee that planned the IAS 2002 Annual Meeting in Pittsburgh. He was a recipient of the Metals Industry Committee Prize Paper Award in 2006 and 2010 for papers that he coauthored and of the Second Place in the IAS Transactions Prize Paper Award for a paper on harmonic filter design for an electric arc furnace that he coauthored.



**Visuth Lorch** received the B.S.E.E. degree in 1973 from Chulalongkorn University, Bangkok, Thailand, and the M.S. degree in electric power engineering in 1976 from Oregon State University, Corvallis, OR, USA, where he was also a Ph.D. candidate. During his Ph.D. studies, he developed the Short Circuit, Load Flow, and Two-Machine Transient Stability programs. The Load Flow program has been used in the undergraduate power system analysis class. He also prepared a Ph.D. thesis on the Load Flow program using the third-order Taylor's series iterative

method.

In 1981, he joined Westinghouse Electric Corporation, Pittsburgh, PA, USA. He was responsible for conduction power system studies, including short circuit, protective device coordination, load flow, motor starting, harmonic analysis, switching transient, and transient stability studies. He also developed the Protective Device Evaluation program on the main frame Control Data Corporation supercomputer. In 1984, he joined Bangkok Oil Refinery, Bangkok, where his primary responsibility was to design the plant electrical distribution system and the protection scheme for the steam turbine cogeneration facility. He was also responsible for designing the plant automation, including the digital control system for the plant control room. In 1986, he rejoined Westinghouse Electric Corporation. He performed power system studies and developed the Short Circuit and Protective Device Evaluation programs for the personal computer. In 1998, he joined the Electrical Services and Systems Division, Eaton Corporation, Warrendale, PA, where he was a Senior Power Systems Engineer with the Power Systems Engineering Department. He performed a variety of power system studies, including switching transient studies using the Electromagnetic Transient program for vacuum breaker/snubber circuit applications. He also developed Excel spreadsheets for quick calculation for short circuit, harmonic analysis, soft starting of motors, capacitor switching transients, dc fault calculation, etc. He retired from Eaton Corporation in January 2013.

Mr. Lorch was inducted as a member of the Phi Kappa Phi Honor Society at Oregon State University.



# Vacuum Circuit Breaker Transients During Switching of an LMF Transformer

David D. Shipp, *Fellow, IEEE*, Thomas J. Dionise, *Senior Member, IEEE*,  
Visuth Lorch, and William G. MacFarlane, *Member, IEEE*

**Abstract**—Switching transients associated with circuit breakers have been observed for many years. With the widespread application of vacuum breakers for transformer switching, recently, this phenomenon has been attributed to a significant number of transformer failures. Vacuum circuit breaker switching of electric arc furnace and ladle melt furnace (LMF) transformers raises concern because of their inductive currents. High-frequency transients and overvoltages result when the vacuum breaker exhibits virtual current chop and multiple re-ignitions. This paper will present a detailed case study of vacuum breaker switching of a new LMF transformer involving current chopping and restrike simulations using the electromagnetic transients program. A technique that involves a combination of surge arresters and snubbers will be applied to the LMF to show that the switching transients can be successfully mitigated. Additionally, some practical aspects of the physical design and installation of the snubber will be discussed.

**Index Terms**—EMTP simulations, LMF transformer, RC snubbers, SF-6 breakers, surge arresters, switching transients, vacuum breakers.

## I. INTRODUCTION

**E**LECTRIC arc furnaces (EAFs) are used widely in the steel industry in the production of carbon steel and specialty steels. The ladle melt furnace (LMF) maintains the temperature of liquid steel after tapping the EAF and facilitates changes in the alloy composition through additives. In both cases, the furnace transformer is a critical component of the furnace circuit that is exposed to severe duty. The demands of the melt cycle may result in extensive damage to the furnace transformer due to electrical failures in the transformer. With advances in technology and metallurgy, the operation of arc furnaces today is significantly different. Heats of 4 to 5 h with periods of moderate loading have been reduced to 3 to 4 h with consistently high loading. Accompanying the shorter heats of sustained loading are many more switching operations. Combined, these factors impose thermal and electrical stresses on the transformer.

Manuscript received January 22, 2011; accepted March 8, 2011. Date of publication November 9, 2011; date of current version January 20, 2012. Paper 2011-METC-008, presented at the 2010 Industry Applications Society Annual Meeting, Houston, TX, October 3–7, and approved for publication in the IEEE TRANSACTIONS ON INDUSTRY APPLICATIONS by the Metals Industry Committee of the IEEE Industry Applications Society.

The authors are with Eaton Electrical Group, Power Systems Engineering, Warrendale, PA 15086 USA (e-mail: DavidDShipp@eaton.com; tom.dionise@ieee.org; visuthlorch@eaton.com; williamtoastmaster@gmail.com).

Color versions of one or more of the figures in this paper are available online at <http://ieeexplore.ieee.org>.

Digital Object Identifier 10.1109/TIA.2011.2175430

Frequent switching operations have been enabled by the development of the vacuum switch. The vacuum switch has been designed for hundreds of operations in a day, for long life and low maintenance. With the advantages of the vacuum switch also come the disadvantages of switching transient overvoltages (TOVs). Depending on the characteristics of the vacuum switch and the power system parameters, these switching TOVs can be of significant magnitude and frequency to cause transformer failure. High-frequency transients and overvoltages result when the vacuum breaker exhibits virtual current chop and multiple re-ignitions. According to statistics compiled by one insurance company [1], the application of vacuum switches has resulted in numerous failures of arc furnace transformers. These failures rates have been reduced by the application of surge arresters, surge capacitors, and damping resistors [2]. The transients produced by the vacuum circuit breaker switching of an LMF transformer and their mitigation are the focus of this paper.

### A. LMF Circuit of Interest

Consider the new LMF circuit of Fig. 1 that consists of a 50-MVA, 135/26.4-kV power transformer, a 2000-A SF-6 breaker, a 56-MVA, 27/10-kV autoregulating transformer, a 1200-A vacuum breaker, and a 50-MVA, 25/0.53-kV furnace transformer. The SF-6 circuit breaker is separated by 53 feet from the autoregulating transformer. The vacuum circuit breaker is separated by 28 feet from the LMF transformer. The normal configuration (1) consists of the new LMF and the existing 4EAF operating in parallel. One alternate configuration (2) of the LMF circuit consists of 4OCB and 4EAF out-of-service with 4LTC in standby service. A second alternate configuration (3) of the LMF circuit consists of LMF LTC out-of-service with 4LTC switched online to source the LMF. Each of these three possible configurations of the LMF circuit was considered. Of the three, the normal configuration results in the shortest bus length between the vacuum breaker and the LMF transformer. The normal configuration also results in the shortest bus length between the SF-6 breaker and the LMF transformer.

### B. Critical Characteristics of the Furnace Circuit

The severity of the switching transient voltage; i.e., high magnitude and high frequency, and the damage caused by the TOV are determined by critical characteristics of the LMF power supply circuit:

- short distance between circuit breaker and transformer;
- BIL of the transformer;

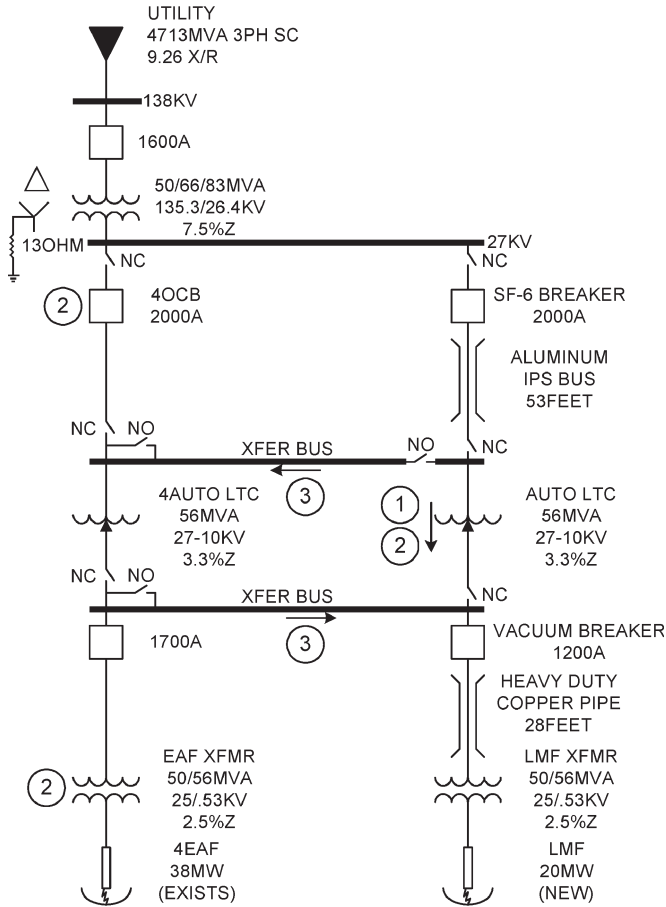

Fig. 1. Simplified electrical distribution system for new LMF.

- inductive load being switched (transformer);
- circuit breaker switching characteristics: chop (vacuum or SF-6) or restrike or re-ignition (vacuum).

In the case of the furnace circuit, the vacuum or SF-6 breaker-induced switching transients can be amplified by the short bus or cable length between the breaker and transformer. This amplification is due to the vacuum or SF-6 breaker chopped current and the system stray capacitance, particularly that of the short bus or cable. In modeling the system for such switching transient analysis, it is important to accurately represent the vacuum or SF-6 breaker chopped current, stray capacitance of the short bus or cable and inductance of the transformer being switched.

The study approach was to evaluate the normal configuration (shortest bus lengths) shown in Fig. 1 which produces the worst case TOV during vacuum and SF-6 breaker switching and size the RC snubber for this worst case. The performance of the RC snubber was proven for this worst case of the normal configuration. The RC snubber designed for the worst case will therefore reduce the less severe TOVs produced during vacuum and SF-6 breaker switching for the two alternate configurations. For breaker opening cases, the transient recovery voltage (TRV) of the breaker was evaluated.

## II. SWITCHING TRANSIENTS SIMULATIONS

Switching transient simulations were conducted in the electromagnetic transients program (EMTP) to investigate the pos-

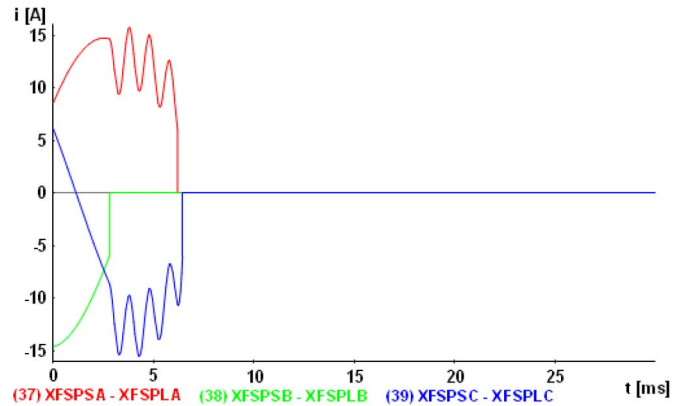

Fig. 2. Current chop for the vacuum breaker.

sible failure of the new LMF transformer due to TOVs during the circuit switching of the new vacuum and SF-6 circuit breakers. The LMF circuit model developed in EMTP consisted of the source, breaker, cable, and transformer. The cable was represented by a Pi model consisting of the series impedance and half of the cable charging at each end. In some cases, multiple Pi models are used to represent the cable. The vacuum or SF-6 breaker was represented by a switch with different models for opening (current chop), restrike (excessive magnitude of TRV), re-ignition (excessive frequency of TRV), and closing (prestrike). The three-phase transformer model consisted of the leakage impedance, magnetizing branch, winding capacitances from high to ground and low to ground. For oil-filled transformers, the oil acts like a dielectric so the high-to-low capacitance was modeled. Two worst case switching scenarios involving the 2000-A SF-6 breaker and the 1200-A vacuum breaker were simulated: 1) current chop by the breaker on de-energization of the LMF transformer and 2) re-ignition following opening of the breaker during energization of the LMF transformer. Also, the surge arrester was not modeled to show worst case.

### A. Modelling Current Chop for Vacuum and SF-6 Breakers

When a vacuum breaker opens, an arc burns in the metal vapor from the contacts which requires a high temperature at the arc roots [3]. Heat is supplied by the current flow and as the current approaches zero, the metal vapor production decreases. When the metal vapor can no longer support the arc, the arc suddenly ceases or “chops out.” This “chop out” of the arc called “current chop” stores energy in the system. If the breaker opens at a normal current zero at  $180^\circ$ , then there is no stored energy in the system. If the breaker opens chopping current at  $170^\circ$ , then energy is stored in the system. For modern breakers, current chop can range from 3 to 21 A depending on the contact material and design. Both vacuum and SF-6 interrupters current chop. Current chop is not unique to vacuum breakers. Fig. 2 shows that the LMF transformer load current at time of the vacuum circuit breaker opening is 10 A. The Phase-B pole opens first at 2.7891 ms, followed by Phase-A at 6.1875 ms, and Phase-C at 6.4377 ms. The vacuum circuit breaker was modeled with 6-A chopped current. The SF-6 breaker was modeled similarly.

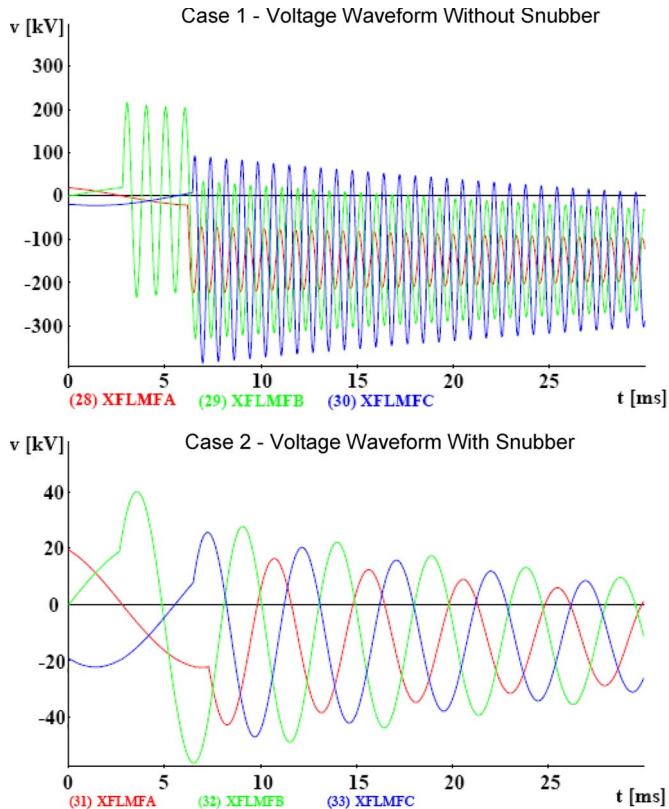

Fig. 3. TOV during de-energization of LMF transformer by the vacuum breaker with and without snubber protection.

#### B. De-Energize the LMF Transformer at Light Load by Opening the 1200-A Vacuum Breaker

In Case 1, the 1200-A vacuum breaker feeding the 56-MVA LMF transformer was opened to interrupt light load. The vacuum breaker was modeled as previously described with 6-A chopped current. This value provides a small safety margin for the vacuum breaker with an actual value of current chopping of 3 to 5 A for a vacuum breaker of this design. The results opening the vacuum breaker with and without snubbers are shown in Fig. 3. The TOV of 386 kV<sub>peak</sub> exceeds the transformer BIL of 200 kV, and the oscillation of 1217 Hz exceeds the acceptable limit. This TOV is unacceptable and indicates the need for an RC snubber in addition to a surge arrester.

An RC snubber was designed to protect the LMF transformer as explained in Section III. Section III provides the specifications for the RC snubber. In Case 2, the RC snubber was modeled with the same switching conditions of Case 1. In Case 2, application of the snubber results in a TOV of 56.4 kV<sub>peak</sub> which is well below the transformer BIL, and the oscillation of 200 Hz is below the acceptable limit as shown in Fig. 3. This TOV is acceptable and shows that the RC snubber effectively controls the TOV. In Fig. 3, notice that the resistor in the snubber reduces the dc offset of the transient voltage waveform. The resistor also provides damping of the transient voltage waveform. The vacuum breaker, because of the short distance of 28 feet of bus to the furnace transformer, produced the worst case TOV.

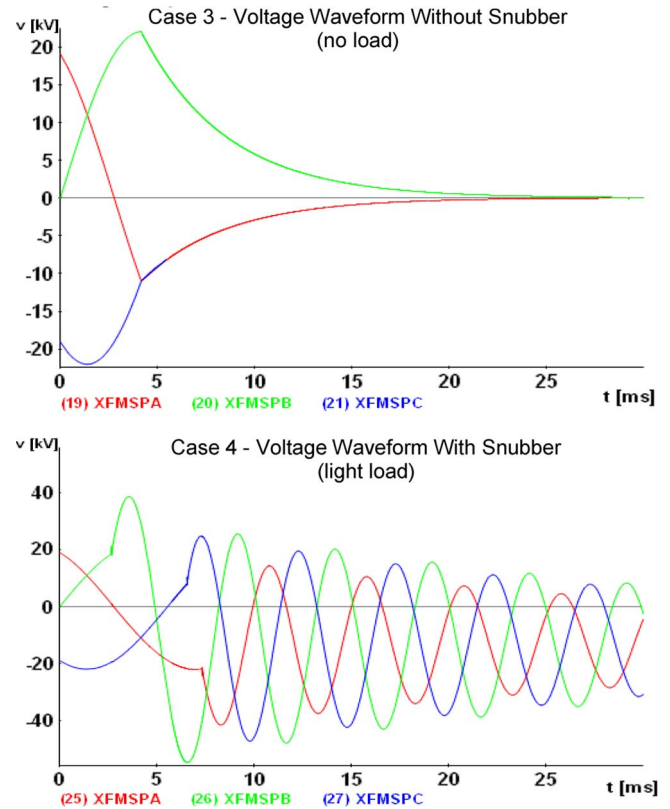

Fig. 4. TOV during de-energization of LMF transformer by the SF-6 breaker with and without snubber.

#### C. De-Energize the Autoregulating Transformer at Both No Load and Light Load by Opening the 2000-A SF-6 Breaker

In Case 3, the 2000-A SF-6 breaker feeding the 56-MVA autoregulating transformer was opened to interrupt no load. At the time, the 1200-A vacuum breaker feeding the LMF transformer was open. The SF-6 breaker was modeled with 6-A chopped current similar to that of the vacuum breaker. As with the vacuum breaker, this provides a safety margin for the manufacturer's stated actual value of current chopping of 3 to 5 A. In Case 4, the switching conditions are the same as for Case 3, except the vacuum breaker is closed, and the RC snubber circuit is applied at the primary side of the 56-MVA autoregulating transformer. Fig. 4 compares the results for Cases 3 and 4 and shows that the TOV magnitude at the primary side of the LMF transformer was negligible in both cases. A snubber is not required.

The results of the switching transient study of the LMF operation during current chop conditions are summarized in Table I. For each case, the magnitude and frequency of the TOV are given. Acceptable and unacceptable levels of TOV are noted.

#### D. Modelling Re-Ignition

Current chop, even though very small, coupled with the system capacitance and transformer inductance can impose a high-frequency TRV on the contacts. If this high-frequency TRV exceeds the rated TRV of the breaker, re-ignition occurs. Repetitive re-ignitions can occur when the contacts part just



TABLE I  
SUMMARY OF CURRENT CHOP CASES FOR LMF TRANSFORMER SWITCHING

Case	Vacuum Breaker	SF6 Breaker	Current Chop <sup>1</sup> (A)	RC	TOV (kV)	Freq (Hz)	Transf BIL	Note
1	Open	IC	6	N	386.5	1,217	200	U
2	Open	IC	6	Y	56.4	200	200	A
3	IO	Open	6	N	N/A	N/A	200	A
4	IC	Open	6	Y	54.7	197	200	A

Notes: U = unacceptable. A = acceptable. 1 = current chop on breaker opening. IO = initially open. IC = initially closed.

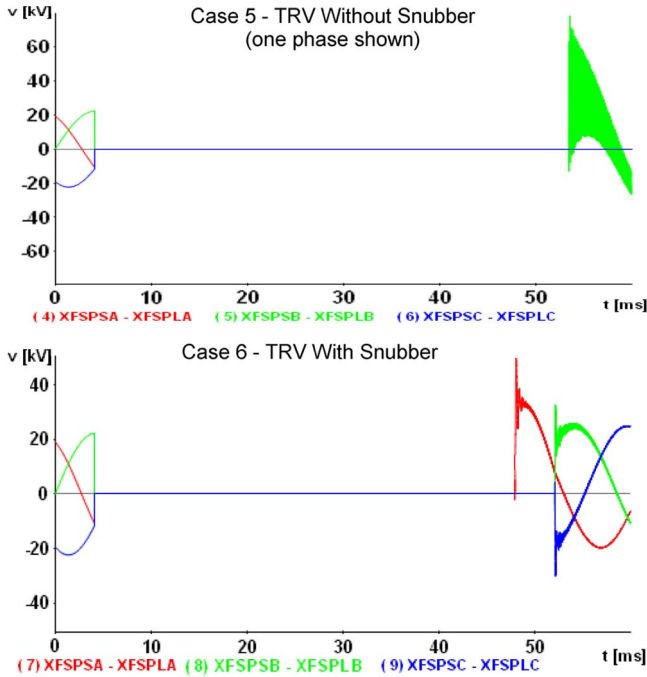

Fig. 5. TRV across vacuum breaker during interruption of LMF transformer inrush current with and without snubber protection.

before a current zero and the breaker interrupts at high-frequency zeros [4]. On each successive re-ignition, the voltage escalates. The voltage may build up and break down several times before interrupting.

#### E. Interrupt Inrush Current to LMF Transformer Followed by Re-Ignition of the Vacuum Breaker

In Case 5, after the LMF transformer was energized for about three cycles, the 1200-A vacuum breaker tripped open as shown in Fig. 5. On this initial opening, the TRV has an E2 of 62.95 kV<sub>peak</sub>, T2 of 19  $\mu$ sec, and rate of rise of the recovery voltage (RRRV) of 3.3133 kV/ $\mu$ sec. T2 and RRRV exceed the limits of [5] and [6] of 63  $\mu$ sec and 1.1270 kV/ $\mu$ sec as shown in Table II. As a result, re-ignition occurs, and the breaker opens at the next current zero. This second opening of the vacuum breaker produces a TRV with E2 of 217.67 kV<sub>peak</sub>, T2 of 16  $\mu$ sec and RRRV of 16.6044 kV/ $\mu$ sec, all exceed the limits of [5] and [6] of 71 kV, 63  $\mu$ sec, and 1.1270 kV/ $\mu$ sec, respectively as shown in Table II. The voltage escalation due to the successive re-ignitions is shown in Fig. 6. The initial TRV and subsequent TRVs due to re-ignition are unacceptable and indicate the need for an RC snubber. The conditions of Case 6 are the same as Case 5, except an RC snubber is applied at the

TABLE II  
STD C37.06 EVALUATION OF TRV FOR VACUUM BREAKER FOR CASES 5 AND 6

	CASE 5 - First Opening	CASE 5 Reignition	CASE 6 with Snubber	IEEE ANSI C37.06 Limit
E <sub>2</sub> (kV)	62.952	217.670	49.901	71
T <sub>2</sub> ( $\mu$ sec)	19	16	130	63
RRRV (kV/ $\mu$ sec)	3.3133	13.6044	0.3839	1.1270

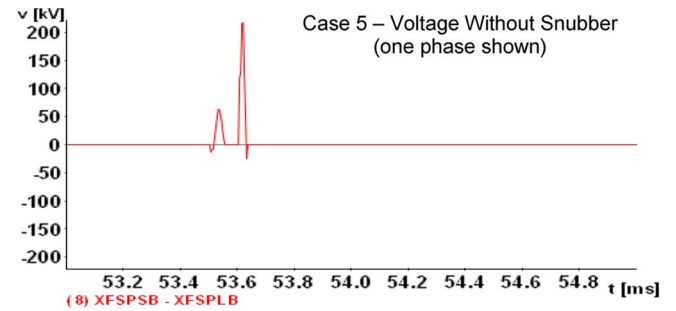

Fig. 6. Voltage escalation due to successive re-ignitions.

primary side of the 56-MVA LMF transformer. In Case 6, the vacuum breaker interrupting the inductive current of the LMF furnace transformer produces a TRV with E2 of 49.90 kV<sub>peak</sub>, T2 of 130  $\mu$ sec, and RRRV of 0.3839 kV/ $\mu$ sec that are well below the limits of [5] and [6], and re-ignition is avoided.

#### F. Interrupt Inrush Current to Autoregulating Transformer by the SF-6 Breaker

SF-6 breakers do not experience re-ignition. For illustration purposes only, the conditions leading to re-ignition of the vacuum breaker are duplicated for the SF-6 breaker. In Case 7, after the autoregulating transformer was energized for about three cycles, the 2000-A SF-6 breaker tripped open. At this time, the 1200-A vacuum breaker to the LMF transformer was open. The conditions of Case 8 were the same as Case 7, except with the application of the RC snubber circuit at the load side of the 2000-A SF-6 circuit breaker. Fig. 7 compares the results for Cases 7 and 8. For both Cases 7 and 8, the TRV across the SF-6 breaker was within the limits of [5] and [6] as shown in Table III. The TRV was not sufficient to cause re-ignition. The snubber is not required for SF-6 switching.

However, the snubber provides an additional benefit during closing of the SF-6 breaker to energize the autoregulating transformer. In Case 8, with the application of the snubber circuit, the period of the transient voltage following closing of the SF-6 breaker to energize the autoregulating transformer was reduced

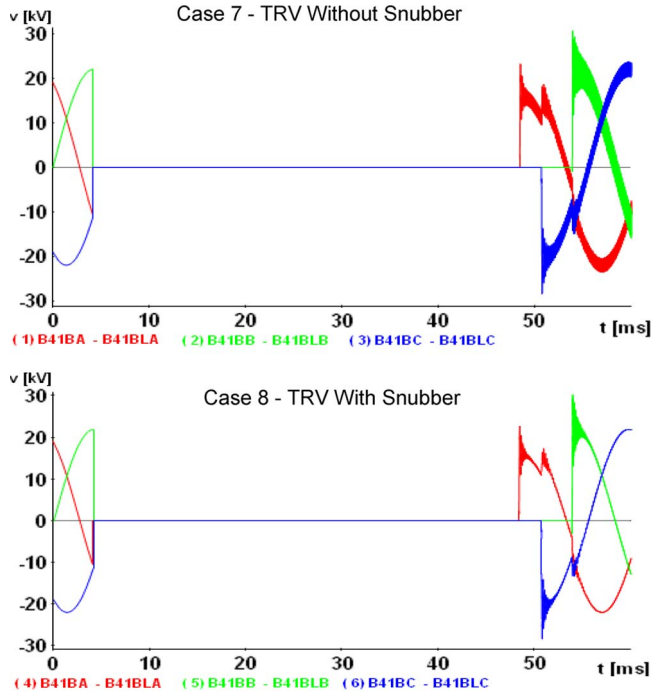

Fig. 7. TRV across SF-6 breaker during interruption of autoregulating transformer inrush current with and without snubber protection.

TABLE III  
STD C37.06 EVALUATION OF TRV FOR SF-6  
BREAKER FOR CASES 7 AND 8

	CASE 7 Reignition	CASE 8 with Snubber	IEEE ANSI C37.06 Limit
$E_2$ (kV)	29.4	29.4	136
$T_2$ ( $\mu$ sec)	75	75	106
RRRV (kV/ $\mu$ sec)	.3923	.3923	1.1270

from 1100  $\mu$ sec to 230  $\mu$ sec as shown below as shown in Fig. 8. This advantage alone does not justify the installation of an RC snubber at the primary of the autoregulating transformer. A surge arrester at the primary of the autoregulating transformer is adequate.

These results of the switching transient study of the LMF operation during re-ignition conditions are summarized in Table IV. The re-ignition was simulated for either the 1200-A vacuum breaker or 2000-A SF-5 breaker. The condition of the other circuit components for each case is described. For each case, the magnitude of the TRV ( $E_2$ ), the time to crest of the recovery voltage ( $T_2$ ) and the RRRV are given. Acceptable and unacceptable levels of TOV are noted.

### III. MITIGATING THE SWITCHING TRANSIENT

Various surge protection schemes exist to protect the transformer primary winding from vacuum breaker switching induced transients. A surge arrester provides basic overvoltage protection (magnitude only). The arrester limits the peak voltage of the transient voltage waveform. The surge arrester does not limit the rate of rise of the TOV. A surge capacitor in combination with the surge arrester slows down the rate of rise of the TOV in addition to limiting the peak voltage but does nothing

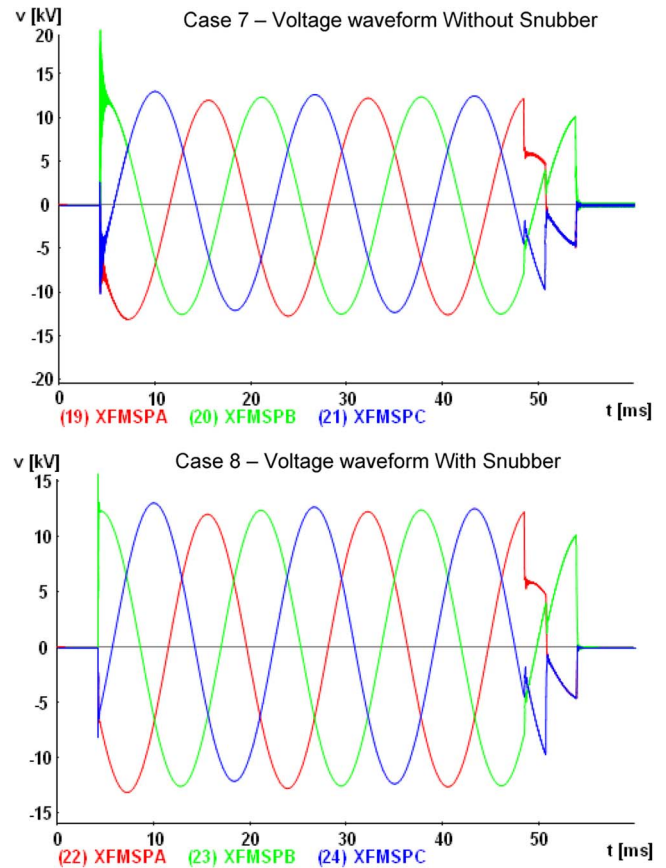

Fig. 8. Transient period of during energization of autoregulating transformer inrush current with and without snubber protection.

for the reflection or dc offset. The number of arrester operations is greatly reduced because of the slower rate of rise. There is a possibility of virtual current chopping. Finally, adding a resistor to the surge capacitor and surge arrester provides damping, reduces the dc offset of the TOV waveform, and minimizes the potential for virtual current chopping. The resistor and surge capacitor are considered an RC snubber. Selecting the values of resistance and capacitance are best determined by a switching transient analysis study, simulating the circuit effects with and without the snubber [7].

#### A. RC Snubber Ratings

The specifications for the RC snubber circuit are given in Fig. 9. The resistor average power rating at 40  $^{\circ}$ C is 1000 W and the peak energy rating is 17 500 joules. This RC snubber circuit, which has the same ratings as the one presently installed at the 3EAF, provides adequate mitigation of the voltage transients produced by either the vacuum breaker or SF-6 breaker and simplifies the inventory of spare parts, i.e. only one type of resistor and capacitor must be stocked.

#### B. Locating the Snubber to Maximize Effectiveness

To maximize effectiveness, apply the RC snubber circuit to the primary side of the 56-MVA LMF furnace transformer. Cases 1 and 2 have shown that the RC snubber circuit reduces

TABLE IV  
SUMMARY OF RE-IGNITION SWITCHING CONDITIONS AND SWITCHING TRANSIENT RESULTS

Case	Vacuum Breaker	SF6 Breaker	Current Chop <sup>1</sup>		Transient Recovery Voltage		IEEE ANSI C37.06 Limit	Note
			(A)	RC				
5	Open, Reignition	IC	6	N	E2 (kV)	217.7	71	U
					T2 (μsec)	16	63	
					RRRV (kV/μsec)	13.6	1.127	
6	Open, No Reignition	IC	6	Y	E2	32.7	71	A
					T2	99.4	63	
					RRRV	0.3293	1.127	
7	IO	Open, No Reignition	6	N	E2	29.4	136	A
					T2	75	106	
					RRRV	0.3923	1.127	
8	IO	Open, No Reignition	6	Y	E2	29.4	136	A
					T2	75	106	
					RRRV	0.3923	1.127	

Notes: U = unacceptable. A = acceptable. 1 = current chop on breaker opening. IO = Initially open. IC = initially closed.

the magnitude of the TOV during switching of the vacuum breaker to be within the BIL of the LMF furnace transformer and reduces the oscillating frequency of the TOV to be less than 1000 Hz. Cases 5 and 6 have also shown that the RC snubber reduces the TRV of the breaker, when interrupting the inductive current of the LMF transformer, to be well below limits of [5] and [6].

Applying the RC snubber at the load side of the SF-6 breaker is optional. In Cases 3 and 4 the TOV was negligible. In Cases 7 and 8, the TRV is not sufficient to cause re-ignition. The only reason for applying the RC snubber circuit at the load side of the SF-6 breaker is to reduce the transient period during energization of the LMF transformer. This advantage alone does not justify the installation of an RC snubber at the primary of the autoregulating transformer. A surge arrester at the primary of the autoregulating transformer is adequate.

### C. Custom Designing the Snubber

Given the limited space in the transformer vault, it was unlikely that off-the-shelf standard snubbers would fit. Instead, a substantial part of the design effort determined how best to fit the snubbers into the new transformer vault. Fig. 10 shows one phase of the custom RC snubber circuit. The custom design was required because of the 36-kV rating and the need to locate the snubber in close proximity to the LMF transformer terminals in a highly congested transformer vault.

The RC snubber is mounted 16 feet above the floor. The surge capacitor is mounted horizontally on an insulated stand-off bolted to the transformer vault wall. An insulator string was required to provide a solid support for the surge capacitor to counter the torque arm of the 39.5-inch, 150-lb. component. The 39.5-inch, 20-lb. resistor was also mounted horizontally, and the base was bolted to the transformer wall but did not require any additional support.

The nature of high-frequency switching transients requires special design considerations. The snubber designer should consider the location of the switching transient source when developing the custom design layout of the protective equipment. Abrupt changes in the electrical path should be avoided. A low

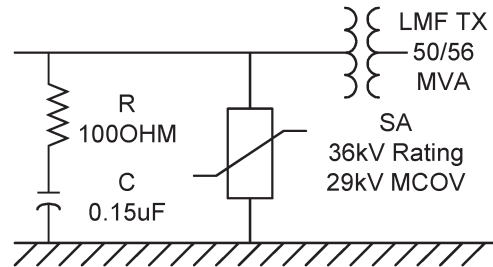

Fig. 9. Snubber specifications and surge arrester arrangement for the LMF transformer protection.

inductive reactance ground path should be designed, using non-inductive ceramic resistors and flat tin braided copper ground conductors. The minimum clearances of live parts must meet or exceed the phase-to-phase and phase-to-ground clearances of NEC Table 490.24.

The cable connections from the snubber capacitor land on the 25-kV, 1.5-inch copper bus supplying the LMF transformer as shown in Fig. 11. 35-kV nonshielded jumper cable was used to make the connection between snubber and bus. The elevation of the bus is 18 feet and that of the surge capacitor is 16 feet with the difference allowing for a gradual curve of the jumper cable. Because of the high-frequency TOVs, gradual arcs are preferred over 90° bends. Such an arrangement allows the snubbers to remain in place during the removal of the transformer should maintenance or service be required. Also, the height of the snubbers provides adequate floor space for maintenance personnel.

## IV. CONCLUSION

This paper presented the findings of a detailed case study of the vacuum breaker and SF-6 switching of an LMF furnace transformer. Through EMTF switching transient simulations, it was shown that high-frequency TOVs result when the vacuum breaker exhibits virtual current chop and multiple re-ignitions. The simulations showed the SF-6 breaker switching transients were negligible primarily due to the longer distance of bus between the breaker and transformer. It was shown that a

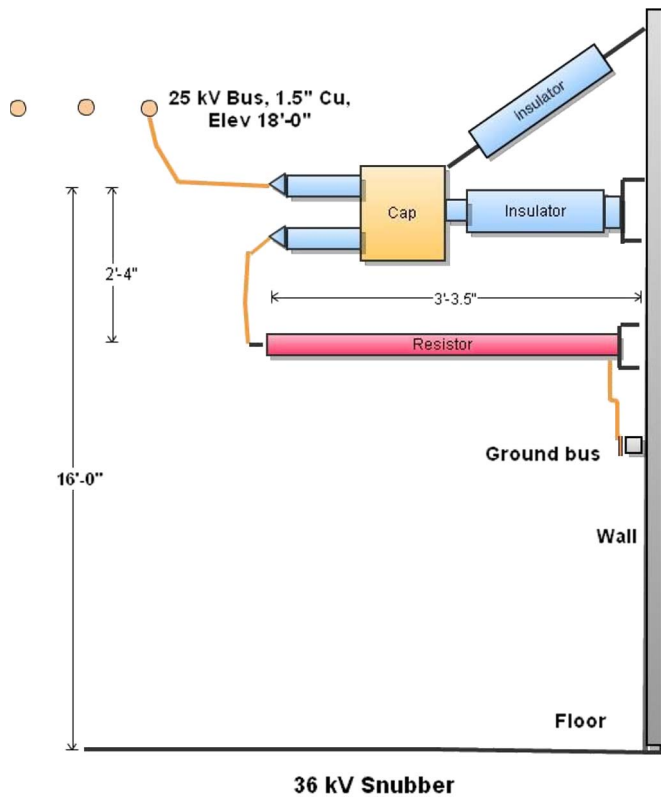

Fig. 10. 36-kV RC snubber for LMF transformer protection.

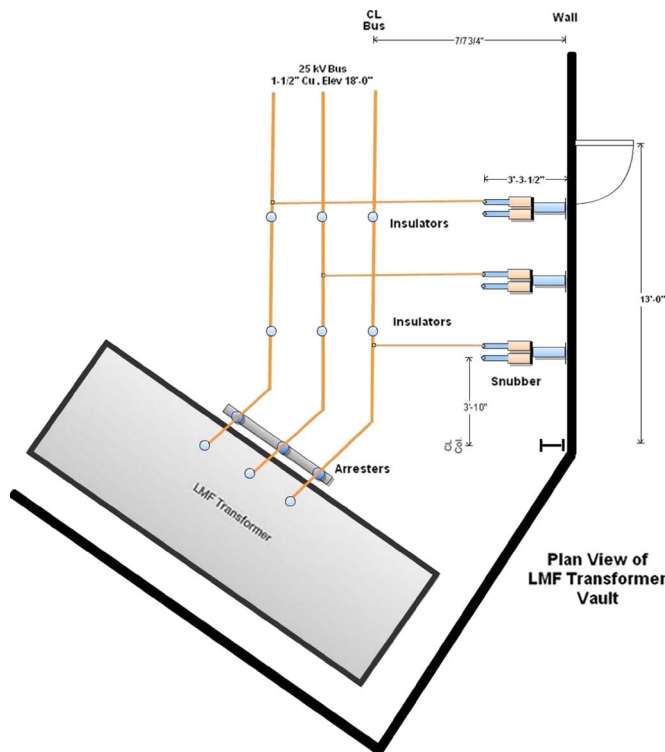

Fig. 11. Plan view of LMF transformer vault showing RC snubber.

technique that involves a combination of surge arresters and RC snubbers applied to the LMF transformer primary effectively mitigates the switching transients due to the vacuum breaker switching. Additionally, the practical aspects of the physical

design and installation were discussed including the nature of high-frequency switching transients which require the avoidance of abrupt changes in the electrical path and the use of a low inductive reactance ground path.

REFERENCES

- [1] Factory Mutual Insurance Co., "Arc furnace transformer installations," Property Loss Prevention Data Sheets, pp. 1–13, Jan. 2002.
- [2] *A Guide to Describe the Occurrence and Mitigation of Switching Transients Induced by Transformer and Switching Device Interaction*, IEEE Std. PC57.142/D6, 2009.
- [3] D. Shipp and R. Hoerauf, "Characteristics and applications of various arc interrupting methods," *IEEE Trans. Ind. Appl.*, vol. 27, no. 5, pp. 849–861, Sep./Oct. 1991.
- [4] A. Morre and T. Blalock, "Extensive field measurements support new approach to protection of arc furnace transformers against switching transients," *IEEE Trans. Power App. Syst.*, vol. PAS-94, no. 2, pp. 473–481, Mar./Apr. 1975.
- [5] *Standard for AC High-Voltage Circuit Breakers Rated on a Symmetrical Current Basis*, IEEE Std. C37.06-1997.
- [6] *Application Guide for Transient Recovery Voltage for AC High-Voltage Circuit Breakers*, IEEE Std. C37.011-2005.
- [7] D. Shipp, T. Dionise, V. Lorch, and B. MacFarlane, "Transformer failure due to circuit breaker induced switching transients," in *Conf. Rec. IEEE Pulp Paper Ind.*, San Antonio, TX, 2010, pp. 1–10.



**David D. Shipp** (S'72–M'72–SM'92–F'02) received the B.S.E.E. degree from Oregon State University, Corvallis, in 1972.

He is a Principal Engineer for Eaton Corporation's Electrical Services and Systems Division in Warrendale, PA. He is a distinguished scholar in power system analysis and has worked in a wide variety of industries. He has spent many years performing the engineering work associated with his present-day responsibilities, which include a wide range of services covering consulting, design, power

quality, arc flash, and power systems analysis topics. Over the last few years, he has pioneered the design and application of arc flash solutions, modifying power systems to greatly reduce incident energy exposure. He has written over 80 technical papers on power system analysis topics. More than 12 technical papers have been published in IEEE/IAS national magazines and two in EC&M. He spent ten years as a professional instructor, teaching full time. He occasionally serves as a legal expert witness.

Mr. Shipp is currently the Chair for the IEEE I&CPS-sponsored Working Group on generator grounding. He received the 2011 Richard Harold Kaufmann Award for improving electrical equipment and systems reliability as well as workplace safety in a number of industries. He has received an Industry Applications Society (IAS)/IEEE Prize Paper Award for one of his papers and conference prize paper awards for six others. He is very active in IEEE at the national level and helps write the IEEE Color Book series standards.



**Thomas J. Dionise** (S'79–M'82–SM'87) received the B.S.E.E. degree from The Pennsylvania State University, University Park, in 1978, and the M.S.E.E. degree with the Power Option from Carnegie Mellon University, Pittsburgh, PA, in 1984.

He is currently a Power Quality Engineering Specialist in the Power System Engineering Department, with Eaton Corporation, Warrendale, PA. He has over 27 years of power system experience involving analytical studies and power quality investigations of industrial and commercial power systems. In the

metals industry, he has specialized in power quality investigations, harmonic analysis, and harmonic filter design for electric arc furnaces, rectifiers, and variable frequency drive applications. He coauthored a paper which received the 2006 IAS Metals Industry Committee Prize Paper Award.

Mr. Dionise is the Chair of the IAS Metals Industry Committee and a member of the Generator Grounding Working Group. He has served in local IEEE positions and had an active role in the committee that planned the IAS 2002 Annual Meeting in Pittsburgh. He is a Licensed Professional Engineer in Pennsylvania.





**Visuth Lorch** received the B.S.E.E. degree from Chulalongkorn University, Bangkok, Thailand, in 1973, and the M.S. degree in electric power engineering from Oregon State University, Corvallis, in 1976, where he was also a Ph.D. candidate and was inducted as a member of the Phi Kappa Phi Honor Society. During his Ph.D. study, he developed the Short Circuit, Load Flow, and Two-Machine Transient Stability programs.

The Load Flow program has been used in the undergraduate power system analysis class. He also prepared a Ph.D. thesis on the Load Flow program using the third-order Taylor's series iterative method. In 1981, he joined Westinghouse Electric Corporation, Pittsburgh, PA. He was responsible for conduction power system studies, including short circuit, protective device coordination, load flow, motor starting, harmonic analysis, switching transient, and transient stability studies. He also developed the Protective Device Evaluation program on the main frame Control Data Corporation supercomputer. In 1984, he joined the Bangkok Oil Refinery, Thailand, where his primary responsibility was to design the plant electrical distribution system as well as the protection scheme for the steam turbine cogeneration facility. He was also responsible for designing the plant automation, including the digital control system for the plant control room. In 1986, he rejoined Westinghouse Electric Corporation. He performed power system studies and developed the Short Circuit and Protective Device Evaluation programs for the personal computer. In 1998, he joined the Electrical Services and Systems Division, Eaton Corporation, Pittsburgh, where he is currently a Senior Power Systems Engineer with the Power Systems Engineering Department. He performs a variety of power system studies, including switching transient studies using the Electromagnetic Transient program for vacuum breaker/snubber circuit applications. He continues to develop Excel spreadsheets for quick calculation for short circuit, harmonic analysis, soft starting of motors, capacitor switching transients, dc fault calculation, etc.



**William G. MacFarlane** (S'70–M'72) received the B.S.E.E. degree from The Pennsylvania State University, University Park, in 1972.

He began his career in 1972 with Dravo Corporation as a power system design engineer supporting this engineering/construction company with expertise in the design and construction of material handling systems, chemical plants, pulp and paper mills, steel facilities, ore beneficiation, mine design, and computer automation systems. He provided full electrical design services in heavy industrial applications, primarily in the steelmaking and coal preparation-related sectors. His responsibilities included client and vendor liaison and supervision of engineers, designers, and drafters. From 1978 until 2003, he was a principal process controls systems engineer at Bayer Corp. He provided design and specification of instrumentation and control systems for chemical processes. He configured programmable logic controller and distributed control systems. He was a corporate technical consultant for power distribution systems. He had been the principal electrical engineer on many major projects at Bayer Corp. He joined Eaton Electrical Services and Systems, Warrendale, PA, in 2004. At Eaton, he has been involved in a 230-kV substation design, ground grid design for substations, as well as in short circuit, protective device coordination, load flow, and arc flash hazard analysis studies. He has also done power factor correction and harmonics studies to resolve power quality issues.