

HERETICAL VIEWS of CONCEPTS in PRODUCT SAFETY

by Richard Nute
Heretical Product Safety Consultant
San Diego

HERESY

is

- any belief or theory that is strongly at variance with established beliefs, customs, etc.
- a controversial or unorthodox opinion or doctrine, as in politics, philosophy, or science.
- (the holding or teaching of) an (*especially religious*) opinion which differs from the official opinion.

Any nonconformist view within any field may be perceived as "heretical" by others within that field who are convinced that their view is "orthodox." Heresy is a value judgment and expression of a view from within an established belief system. For a heresy to exist, there must be an authoritative system of **dogma** designated as ***orthodox***.



Shabbetai Tzvi

Heretics are fascinating figures, especially in Judaism. Although easily reduced in pop culture to mere villains, heretics are actually much more subtle than that. Consider the dictionary's definition: "a *professed believer* who maintains religious opinions contrary to those accepted by his or her church." The last part of that definition is what we all know — that heretics espouse anti-establishment ideas — but it's that first part that makes them interesting. Because *heretics are believers*. You don't get to be a heretic simply by rejecting tradition — you have to believe that God wants you to do it. In other words, you have to *mean it*.

DOGMA

is

- an authoritative principle, belief, or statement of ideas or opinion, especially one considered to be absolutely true.
- a doctrine or code of beliefs accepted as authoritative.
- an authoritative principle, belief, or statement of ideas or opinion, especially one considered to be absolutely true.

Dogma is the established belief or doctrine held by a any kind of organization, thought to be authoritative and not to be disputed, doubted, or diverged from.

ORTHODOX

is

- customary or conventional, as a means or method; established.
- adhering to what is commonly accepted, customary, or traditional.

The word ***orthodox***, from the Greek *ortho* ('right', 'correct') and *doxa* ('thought', 'teaching', 'glorification'), is typically used to refer to forms of intellectual activity shared by organizations or movements, as determined by some overseeing body. People who deviate from orthodoxy by professing a doctrine considered to be false are most often called ***heretics***.

CONVENTIONAL WISDOM

is

- something that is generally believed; prudence.
- the ideas, opinions, or understanding that are considered to be generally accepted by the public.

“Conventional wisdom” is a term coined by the economist, John Kenneth Galbraith, in *The Affluent Society*, used to describe certain ideas or explanations that are generally accepted as true by the public. Despite new information to the contrary, conventional wisdom has a property that opposes the introduction of contrary belief. Conventional wisdom is made of ideas that are convenient, appealing, and deeply assumed by the public.

DOGMA:

The **Standard** is not to be disputed, doubted, or diverged from. **The Standard is... The Truth!**

ORTHODOXY:

The belief that **The Standards Writers** and **The Certifiers** are all-knowledgeable.

CONVENTIONAL WISDOM:

Understandings of what **The Standard** means.

HERESY:

Engineering- and science-based explanations that differ from *Dogma*, *Orthodoxy*, and *Conventional Wisdom*.

What is the impedance of the human body?

Dogma:

Orthodoxy:

Conventional Wisdom:

Heresy:

What is the impedance of the human body?

500 ohms
1,000
1,500
2,000
5,000
10,000
20,000
50,000
100,000
200,000
500,000

What is the impedance of the human body?

Assume body impedance is 1,500 ohms.

When 1,500 ohms is connected across a 1.5-volt battery,

$$I = \frac{E}{R} = \frac{1.5}{1,500} = 1.0 \text{ mA}$$

Can you feel this current?

Assume body impedance is 100,000 ohms.

When 100,000 ohms is connected across a 120-volt source,

$$I = \frac{E}{R} = \frac{120}{100,000} = 1.2 \text{ mA}$$

Can you feel this current?

Palm resistance -- 30 V dc

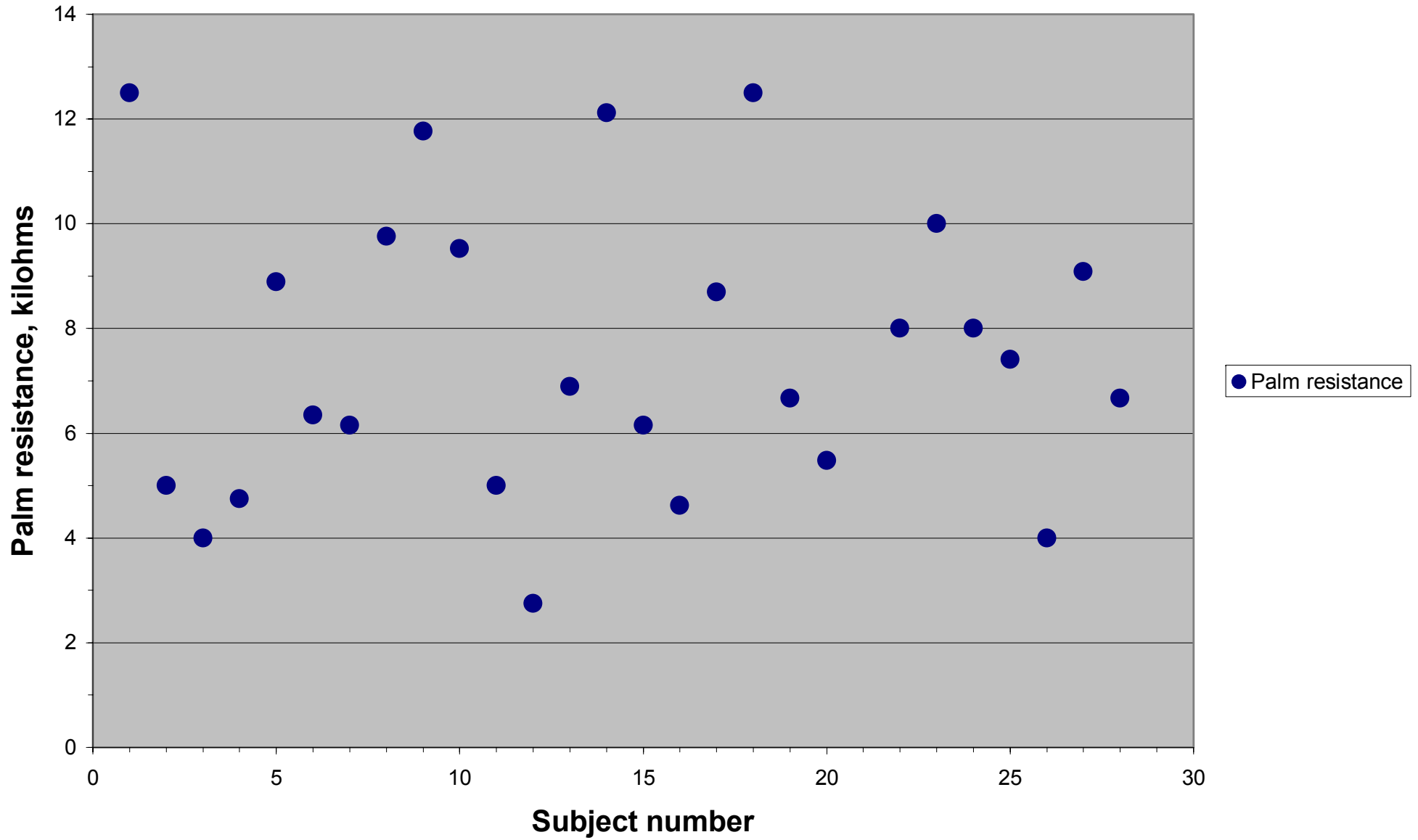

Forearm resistance -- up to 30 V dc

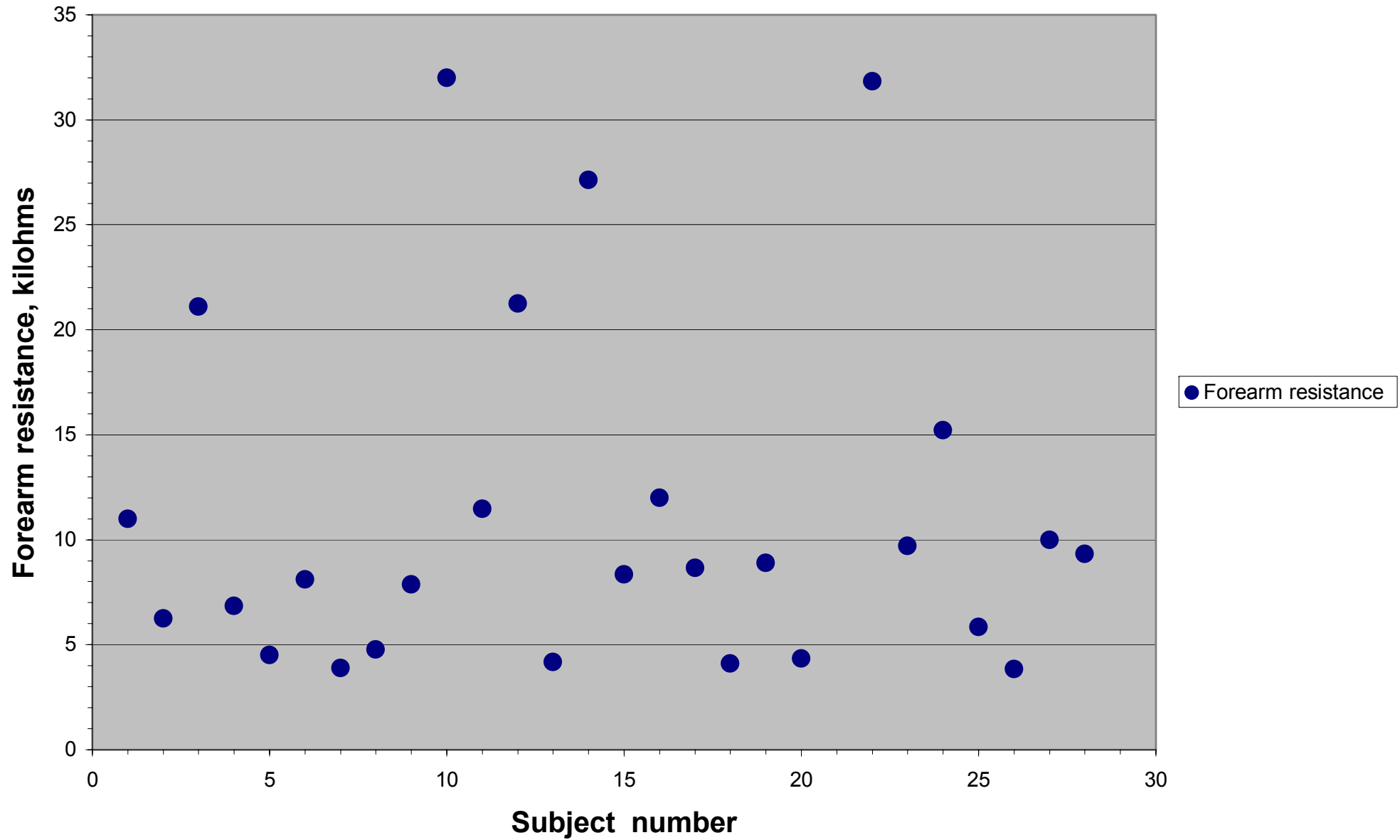

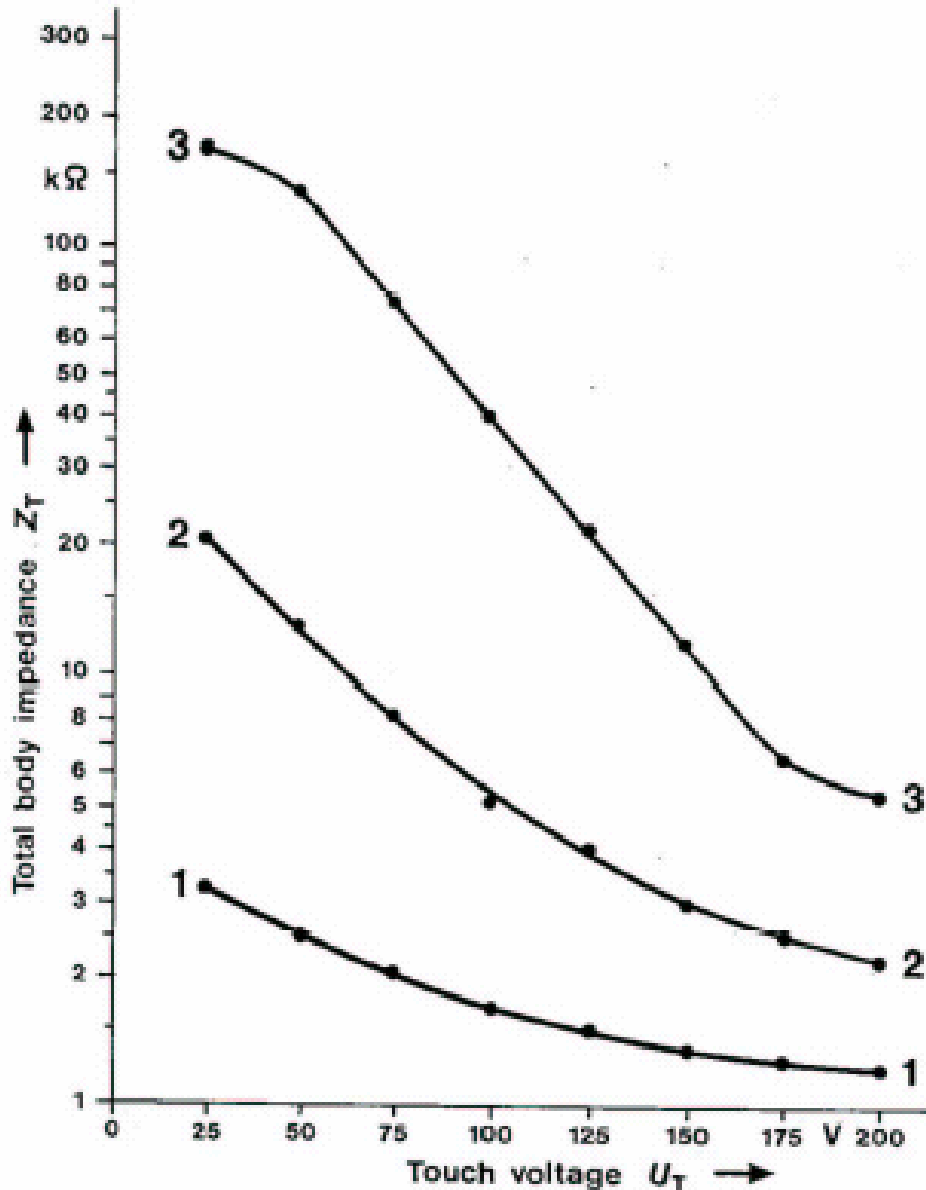

Dependence of the total body impedance Z_T on voltage and contact area (for the 50th percentile rank of the population) for **dry** condition.

$U_T = 25$ to 200 V ac, 50-60 Hz

Reference: IEC 60479-1 (64/1302/CD; fig. 7)

small surface areas of contact,
(order of magnitude 100 mm^2)

middle sized surface areas of contact,
(order of magnitude 1000 mm^2)

large surface areas of contact,
(order of magnitude $10,000 \text{ mm}^2$)

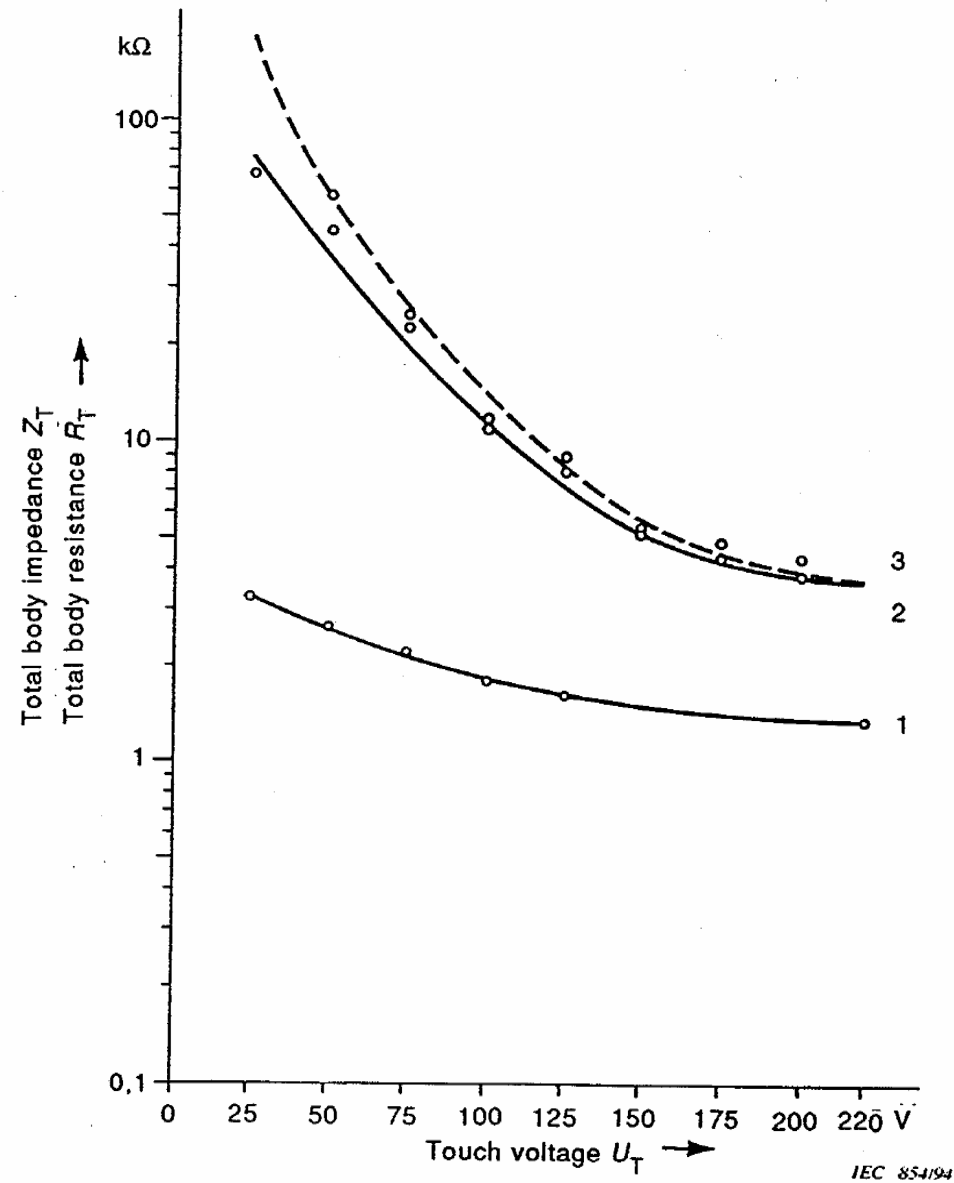

1 Total impedance of the human body for a current path hand to hand according to table 1 for a.c. 50 Hz, for a percentage of 50 % of the population for large areas of contact (approximately 8 000 mm²). For duration of current flow, see annex A.

2 Total impedance of the human body for a current path from the tips of the right to left forefinger for a.c. 50 Hz. Duration of current flow 0,02 s.

3 As 2, but for d.c.

What is the impedance of the human body?

Heresy:

Body impedance is not a constant.

Body impedance is inversely proportional to applied body voltage, body current, duration of body current, contact area, and other parameters.

“The body impedance depends... on the area of contact, moisture in the area of contact and the applied voltage and frequency.”

HERESY

**History warns us that it is the customary
fate of new truths**

to begin as heresies

and

to end as superstitions.

Thomas H. Huxley
1825-1895

superstition: the belief in magic, witchcraft and other things that cannot be explained by reason.

What is the *injury* that is the result of a clearance failure?

Dogma:

Orthodoxy:

**Conventional
Wisdom:**

Heresy:

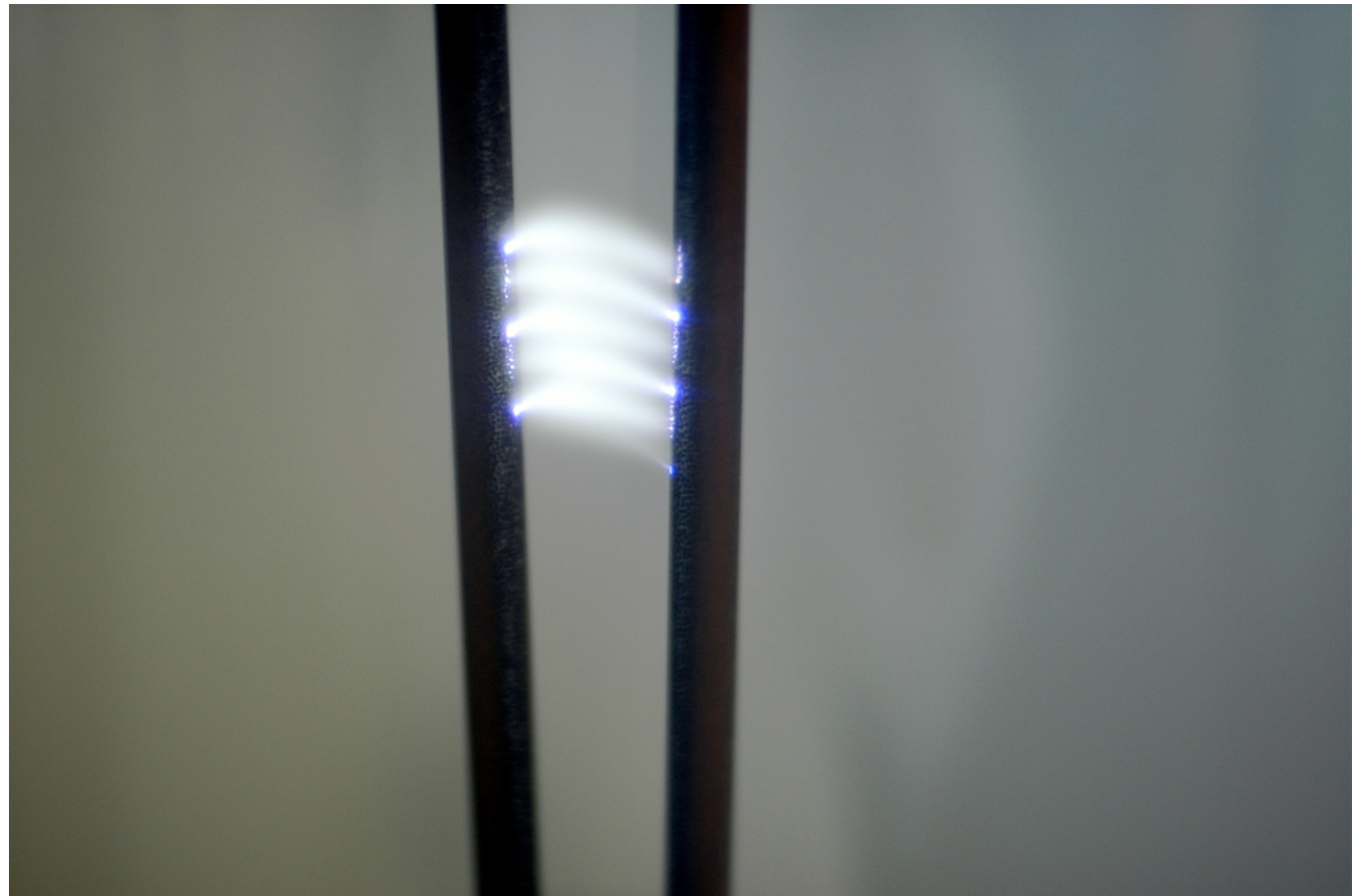

What is the *injury* that is the result of a clearance failure?

What fault is the cause of a clearance failure?

Mechanical force causes the clearance distance to become too small for the voltage.

When the clearance fails, how does the energy transfer to the body?

The air becomes conductive allowing current through the clearance.

What is the duration of a clearance fault?

The air conducts until the voltage falls below the breakdown voltage.

What is the *injury* that is the result of a clearance failure?

When a GFCI operates, what is (or should be) the clearance of the open contacts?

0.1 mm

0.5

1.0

2.0

3.0

5.0

GFCI

When the GFCI operates and the contacts open, what is, or should be, the clearance?

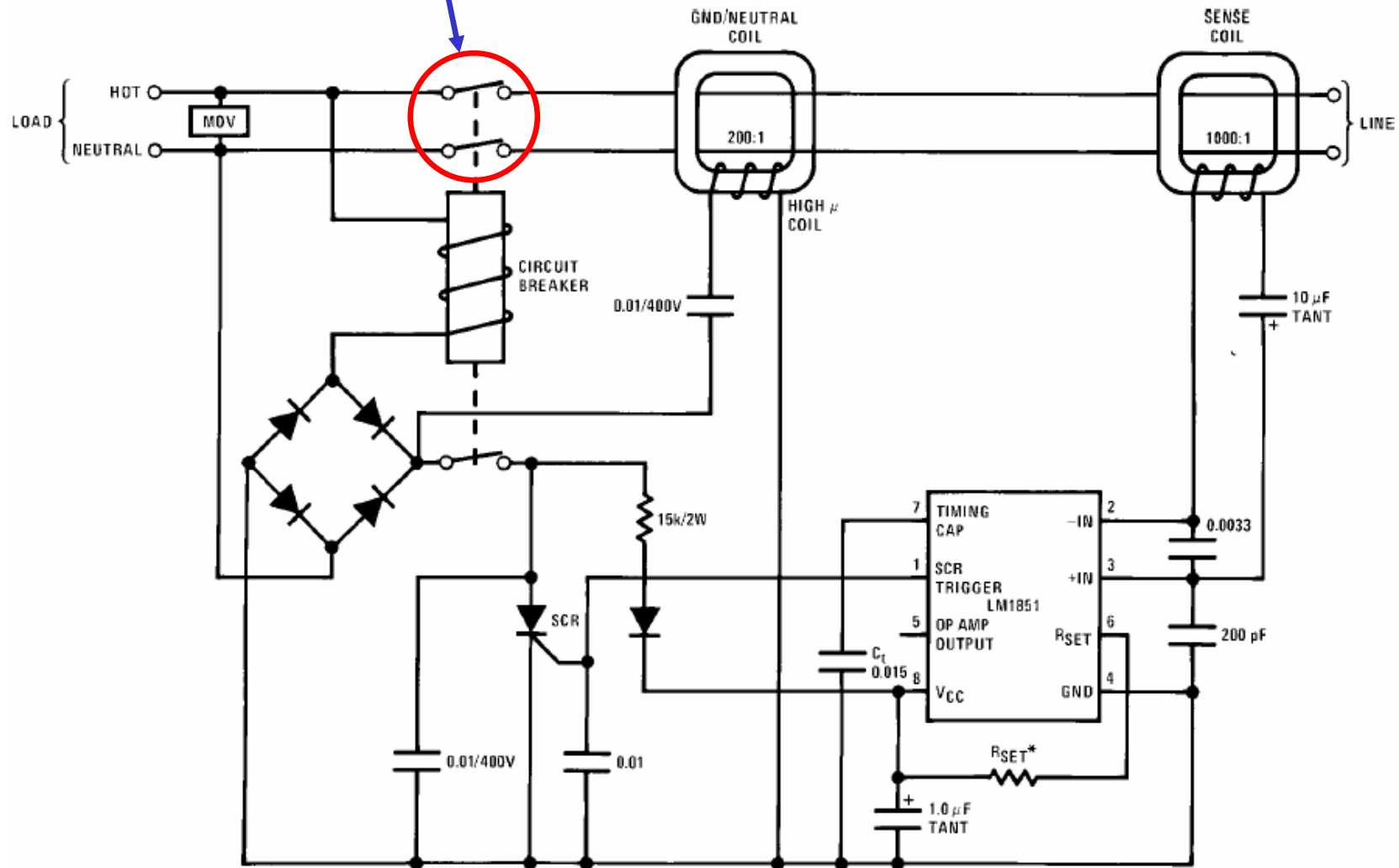

What is the *injury* that is the result of a clearance failure?

When a GFCI operates, what is (or should be) the clearance of the open contacts?

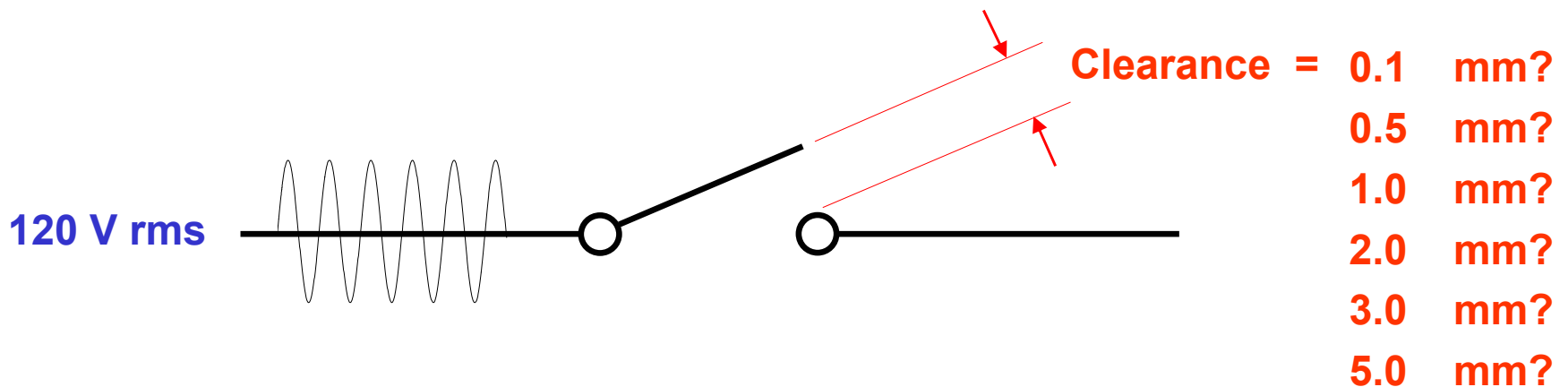

Air Breakdown ($p = 1$ atmosphere) (IEC 60664, Annex A, Table A11, homogeneous field)

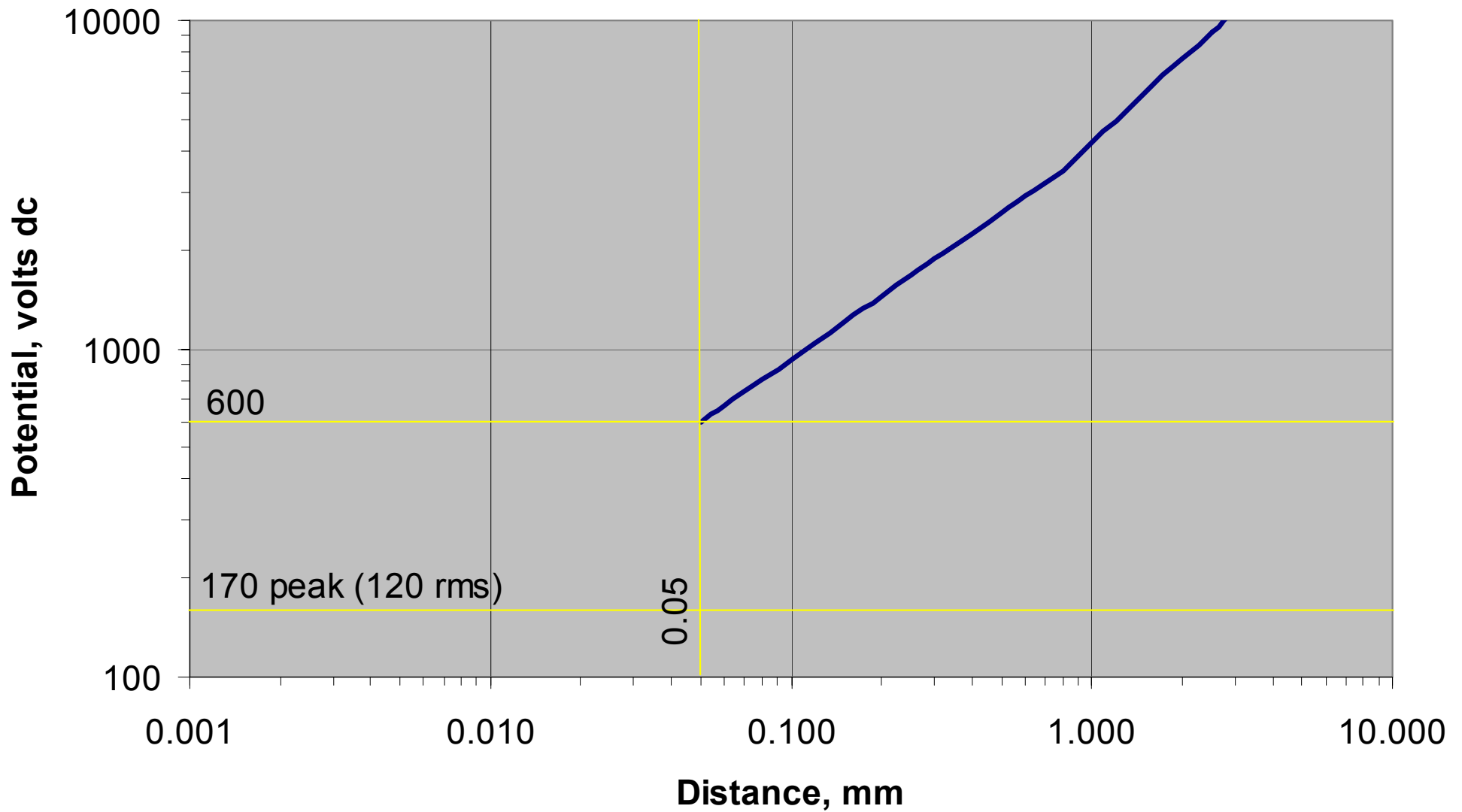

What is the *injury* that is the result of a clearance failure?

Paschen's Law: The sparking potential between two parallel plate electrodes in a gas is a function of the product of the gas density (pressure) and the distance between the electrodes.

$$V = \frac{a(pd)}{\ln(pd) + b}$$

What is the *injury* that is the result of a clearance failure?

Paschen's Law:
$$V = \frac{a(pd)}{\ln(pd) + b}$$

Where

V is the breakdown voltage in volts,
 p is the pressure in atmospheres, and
 d is the gap distance in meters.

The constants a and b depend upon the composition of the gas.

For air at 1 atmosphere (or standard pressure or 760 Torr),

$a = 43.6 \times 10^6$, and

$b = 12.8$.

Air Breakdown ($p = 1$ atmosphere) Paschen's Curve and IEC 60664

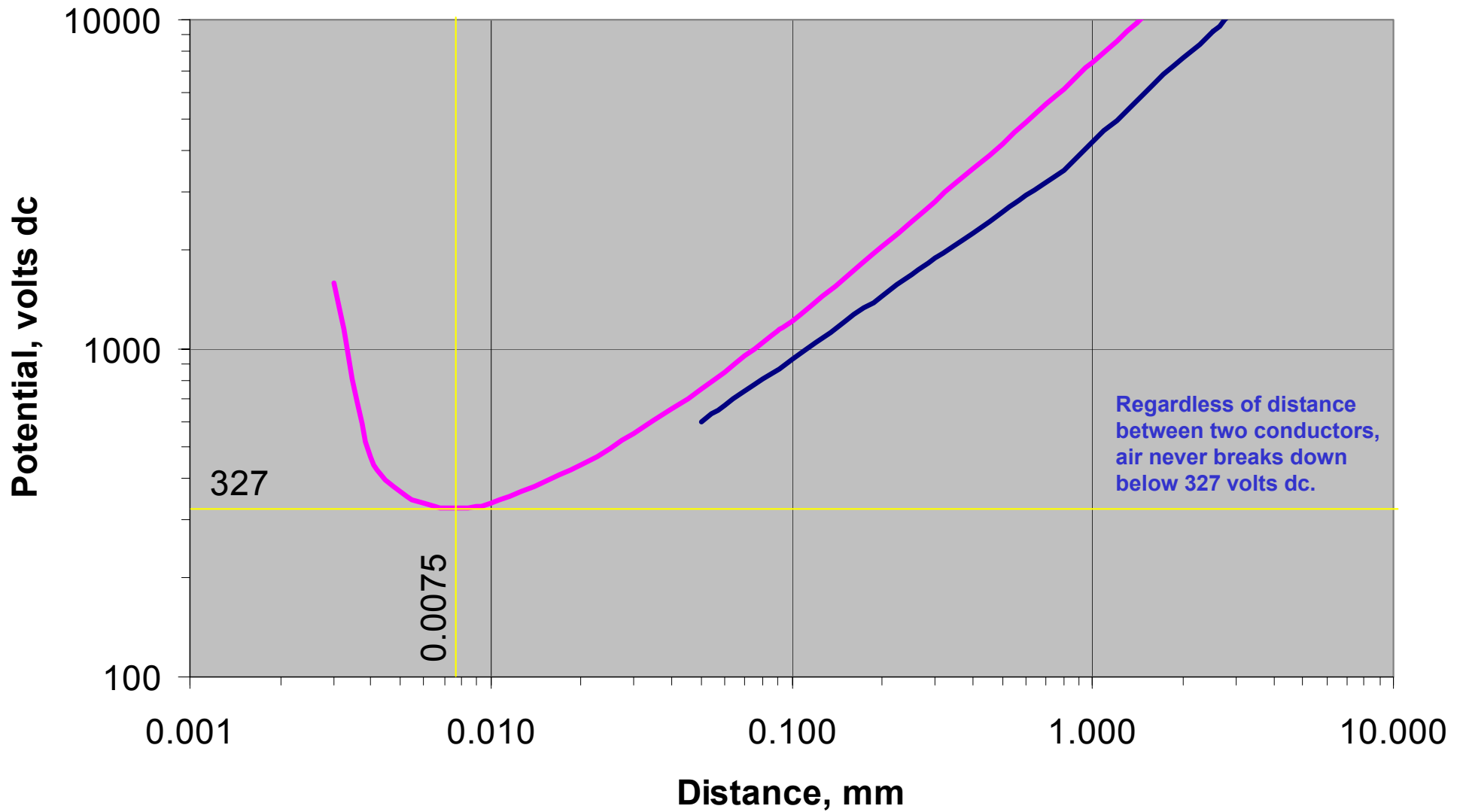

What is the *injury* that is the result of a clearance failure?

When a GFCI operates, what is (or should be) the clearance of the open contacts?

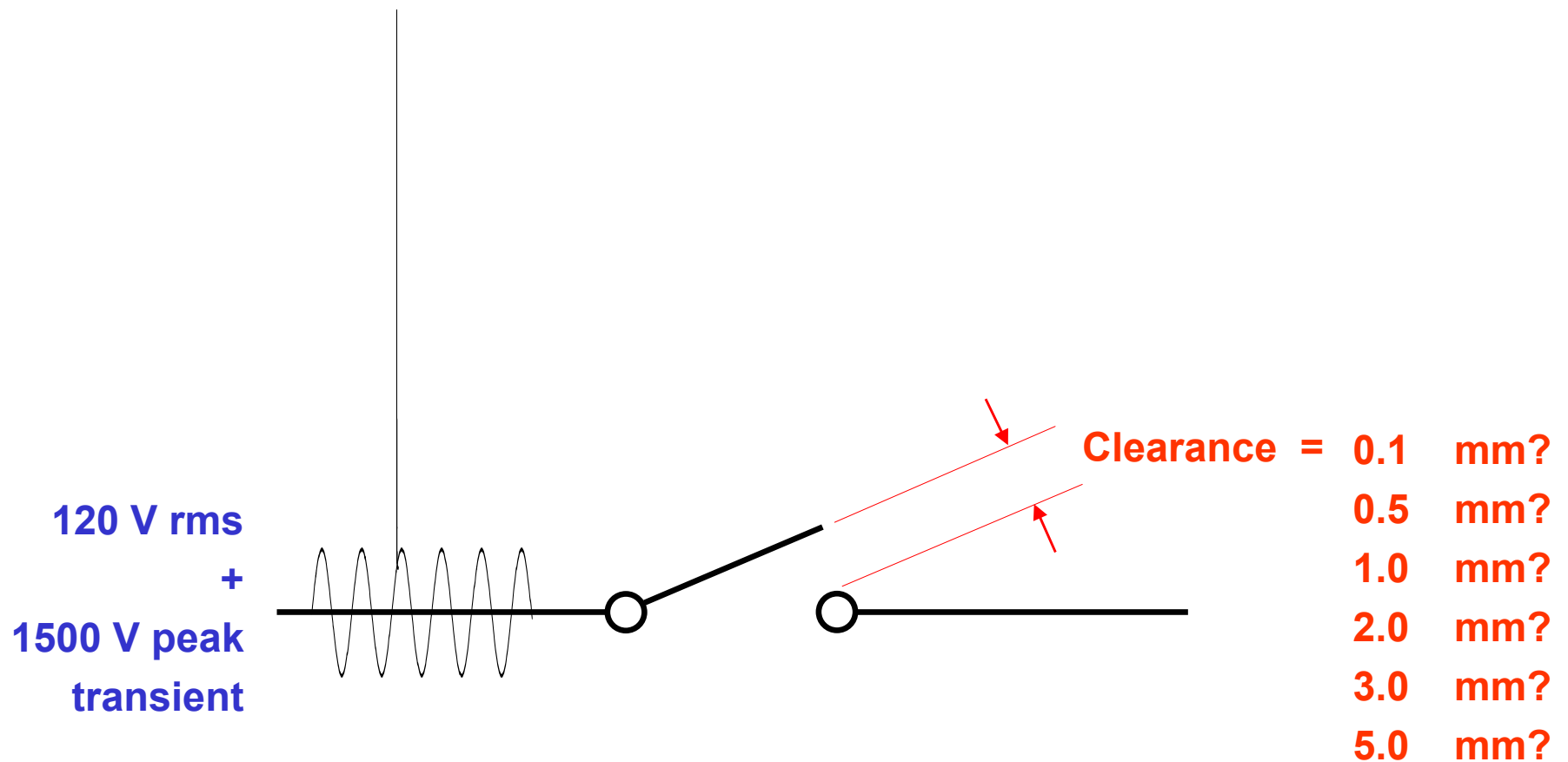

1.2x50 transient

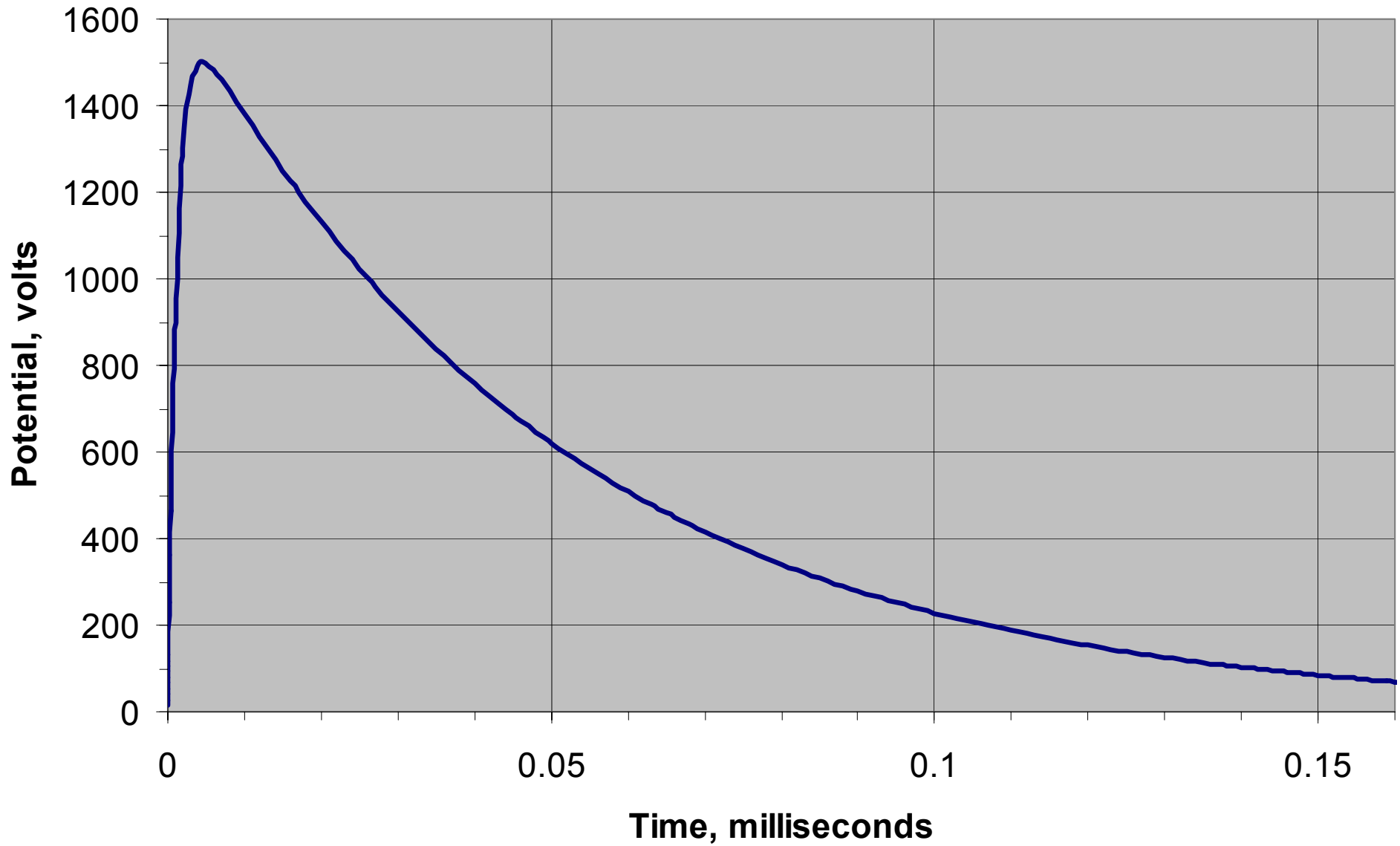

Air Breakdown ($p = 1$ atmosphere) Paschen's Curve and IEC 60664

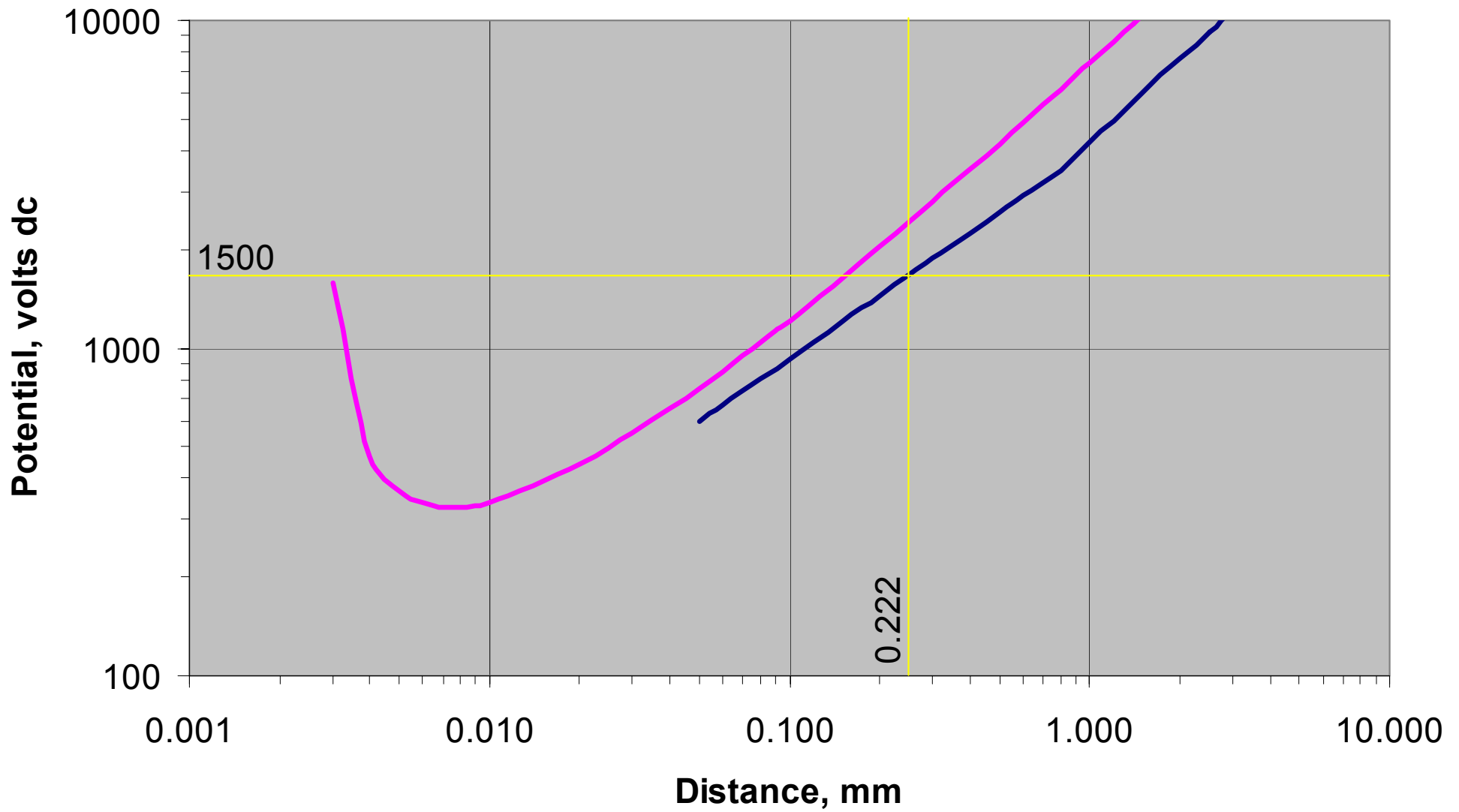

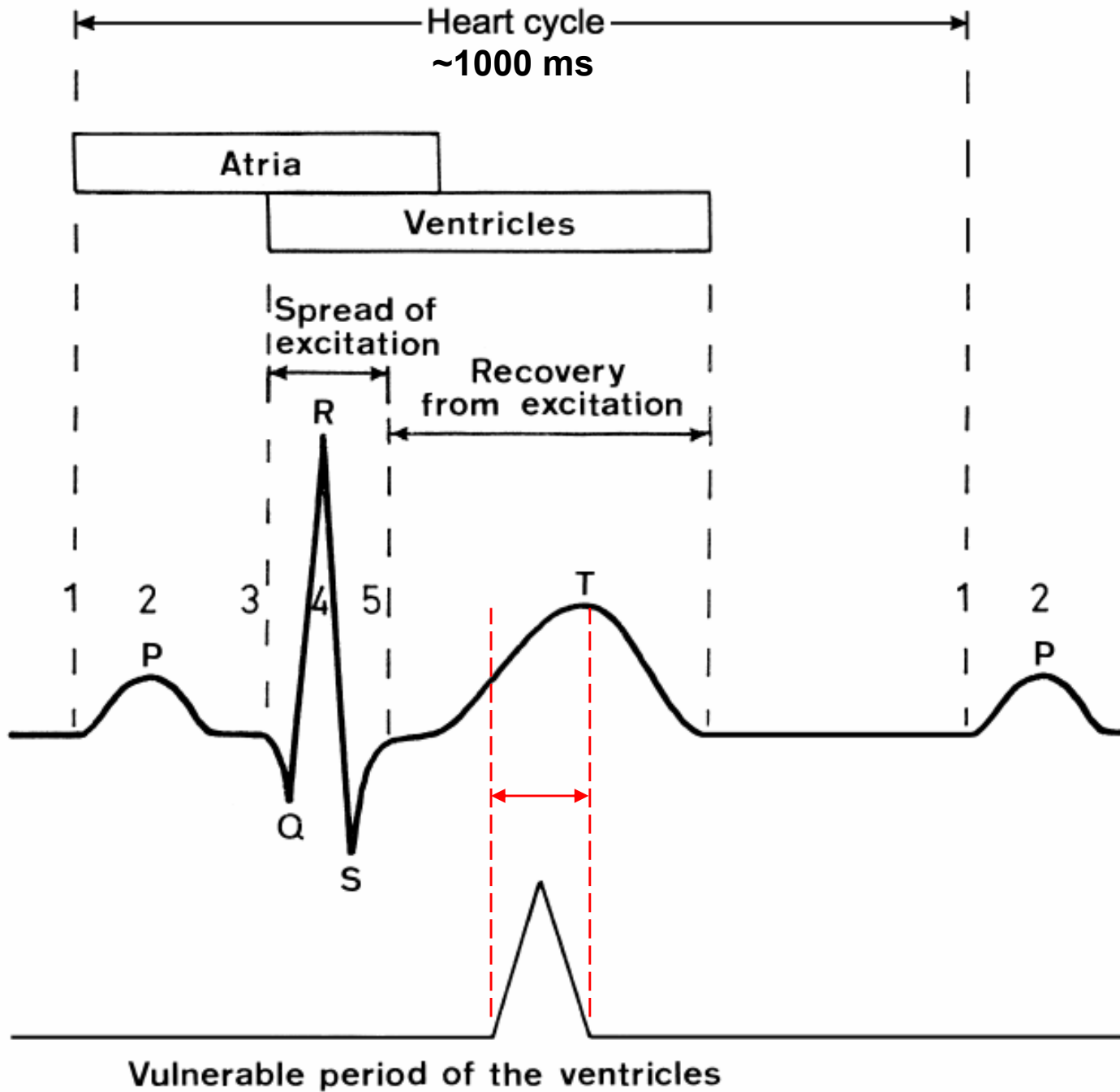

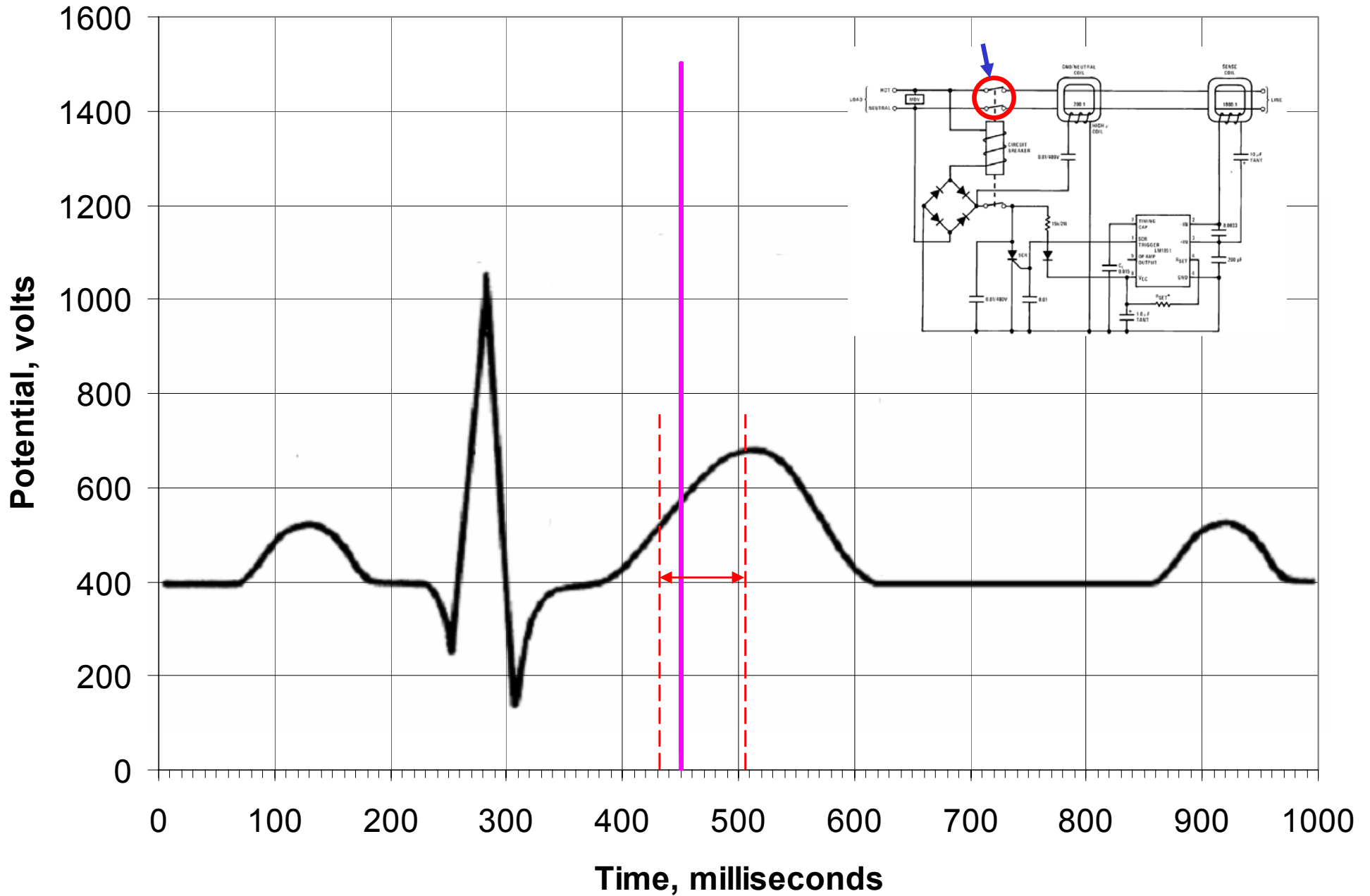

What is the *injury* that is the result of a clearance failure?

Heresy:

Air is a renewable (or self-healing) insulation. In most cases, breakdown is momentary.

Regardless of distance between two conductors, air never breaks down below 327 volts dc.

Impulses do not have sufficient duration (or energy) to cause an electric shock injury.



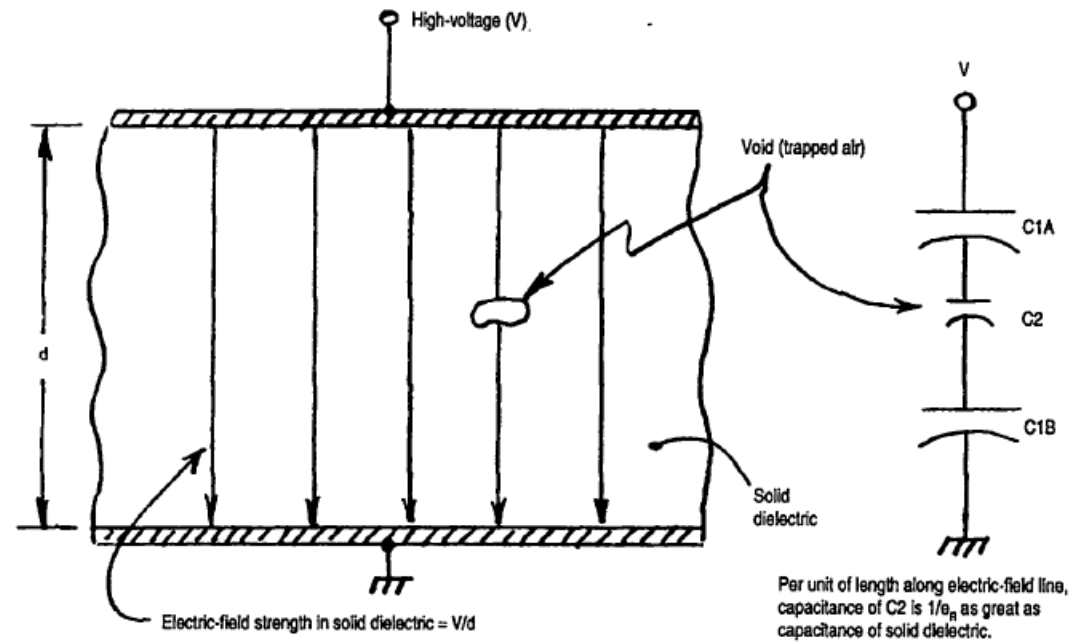

HERESY



Joan of Arc, Witch and Heretic: Powerful women had to fear the accusation of witchcraft.

Source: Jupiter Images

What is the temperature of an accessible part that will cause a burn?

Dogma:

Orthodoxy:

Conventional Wisdom:

Heresy:

What is the temperature of an accessible part that will cause a burn?

10 °C	50 °F
20	68
30	86
40	104
50	122
60	140
70	158
80	176
90	194
100	212

Dogma:

Touch temperature limits, °C			
	Metal	Glass, porcelain, and vitreous material	Plastic and rubber
Handles, knobs, grips, etc., held or touched for short periods only	60	70	85
Handles, knobs, grips, etc., continuously held in normal use	55	65	75
External surfaces of equipment that may be touched	70	80	95
Parts inside the equipment that may be touched	70	80	95

Table 4C – Touch temperature limits
IEC 60950-1, 2nd Edition Information technology equipment – Safety –Part 1: General requirements

What is the temperature of an accessible part that will cause a burn?

First-degree (superficial) burns

First-degree burns affect only the epidermis, or outer layer of skin. The burn site is red, painful, dry, and with no blisters. Mild sunburn is an example. Long-term tissue damage is rare and usually consists of an increase or decrease in the skin color.

Second-degree (partial thickness) burns

Second-degree burns involve the epidermis and part of the dermis layer of skin. The burn site appears red, blistered, and may be swollen and painful.

Third-degree (full thickness) burns

Third-degree burns destroy the epidermis and dermis. Third-degree burns may also damage the underlying bones, muscles, and tendons. The burn site appears white or charred. There is no sensation in the area since the nerve endings are destroyed.

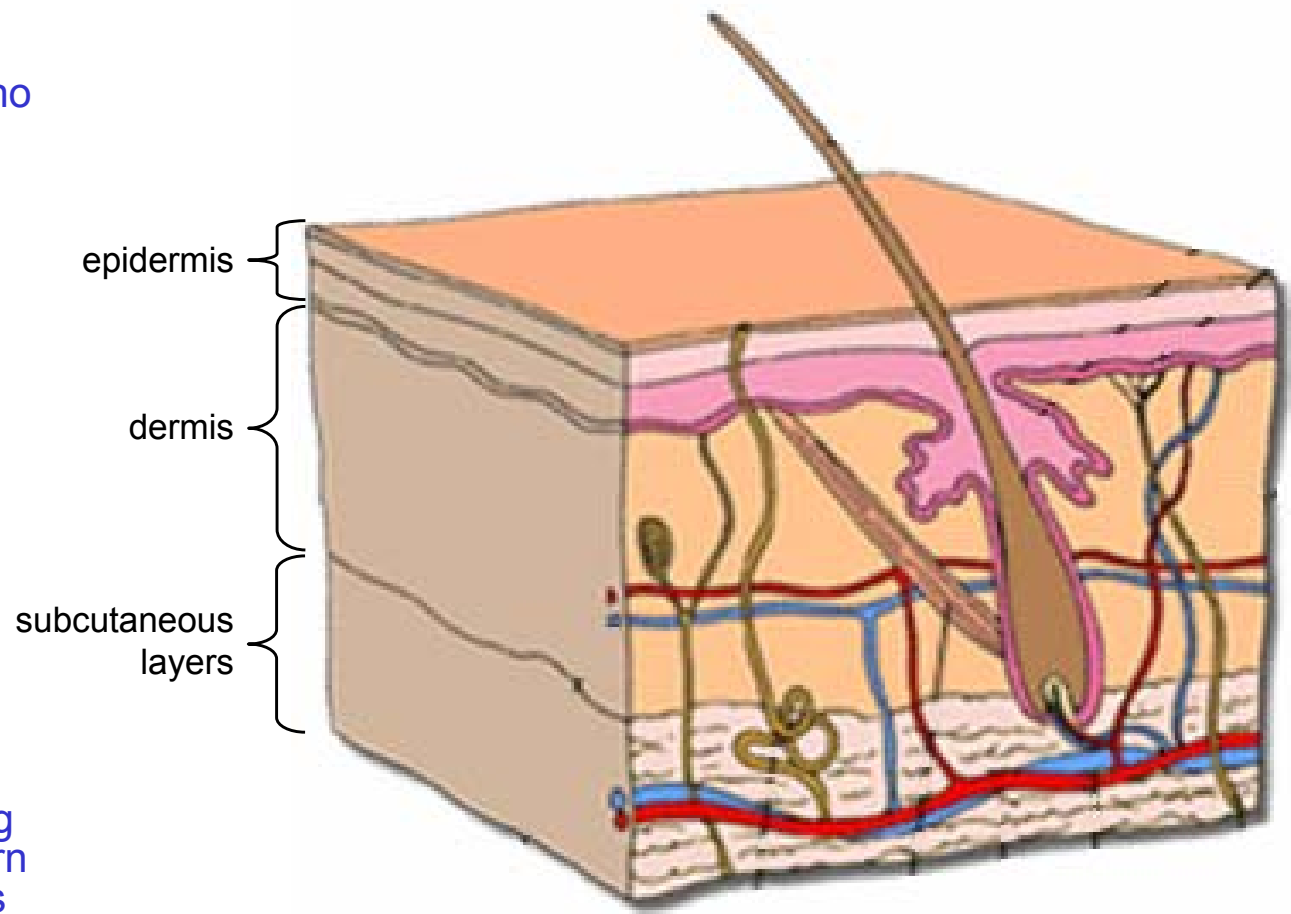

What is the temperature of an accessible part that will cause a burn?

“Eighteen patients undergoing surgery for removal of redundant skin (abdominoplasty, breast reduction) consented to the application of a temperature-controlled custom probe with four light-emitting diodes that had temperatures set randomly at the expected threshold for burn injury (42.5 degrees C, 43 degrees C, 43.5 degrees C, and 44 degrees C). The probe was left in place for 8 hours (or less if significant pain was noted). The sites covered by the probes were then checked for signs of injury. On the next day, the redundant skin was removed as a scheduled procedure, and histopathology was performed to detect the extent of burn injury. Two patients were excluded because of technical problems with the probe, one of whom had the probe turned off because of pain. The only observed sign of injury was either erythema or a superficial blister that was usually unobservable or slightly red at operation. These subtle signs of a burn were noted in one patient at 43 degrees C, four at 43.5 degrees C, and nine at 44 degrees C. No burns were noted in two patients.”

<http://www.ncbi.nlm.nih.gov/pubmed/15353932>

What is the temperature of an accessible part that will cause a burn?

Normal skin temperature is 32 - 37 °C (89.6 - 98.4 °F).

Pain is felt when the skin temperature rises to just above 44 °C (111 °F) over a depth of 0.1 millimeter.

Pain and injury continue while the temperature remains above 44 °C. Burn injuries are reversible or non reversible depending upon the degree of burn.

<http://www.nfpa.org/journalDetail.asp?categoryID=1302&itemID=30083&src=NFPAJournal>

What is the temperature of an accessible part that will cause a burn?

Effect	Description	Skin temperature
Pain	Tingling sensation, hot sensation.	44° C (111° F)
1 st degree burn	Superficial injury to outer layer; skin is reddened; painful.	44-55° C (111-131° F)
2 nd degree burn	Outer layer is burned through; the second layer is damaged; skin is moist and reddened, with blisters and mottled appearance; intense pain.	55-60° C (131-140° F)
3 rd degree burn	All layers of skin are damaged.	60° C (140° F)

Raj, Phani K., Hazardous Heat, NFPA Journal, Sep/Oct 2006, Standard Guide for Heated System Surface Conditions That Produce Contact Burn Injuries.
 Thermal conductivity and Heat Transfer of the Human Skin, J. van den Berg, Thermography Proceedings, 1st European Congress, Amsterdam, 1974.

Time-Temperature for Thermal Injury

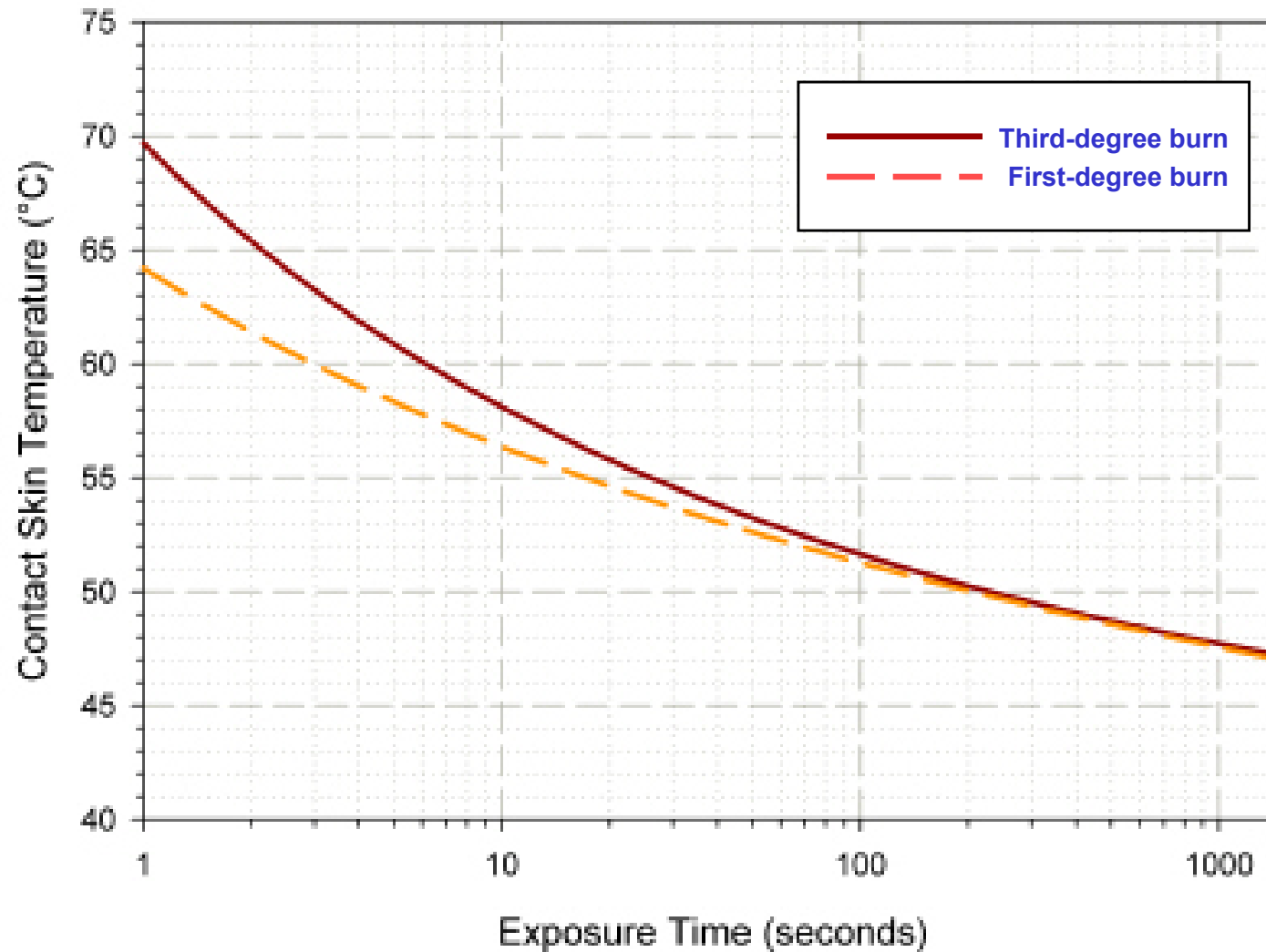

A. R. Moritz, F. C. Henriques: The Relative Importance of Time and Surface Temperature in the Causation of Cutaneous Burns. Studies of Thermal Injury II, Am. J. Path., Vol. 23, 1947, p. 659

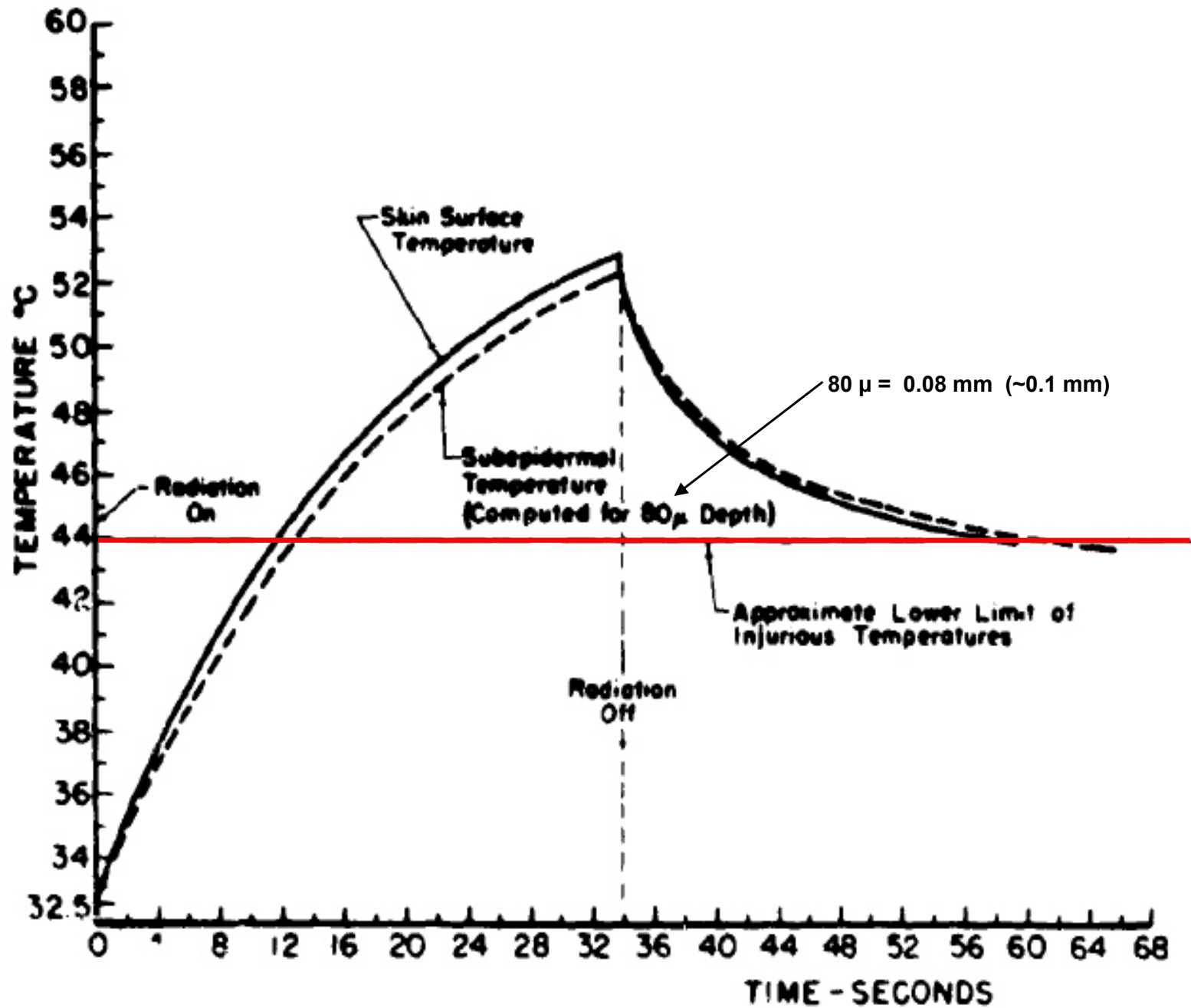

Material Temperature and Contact Time

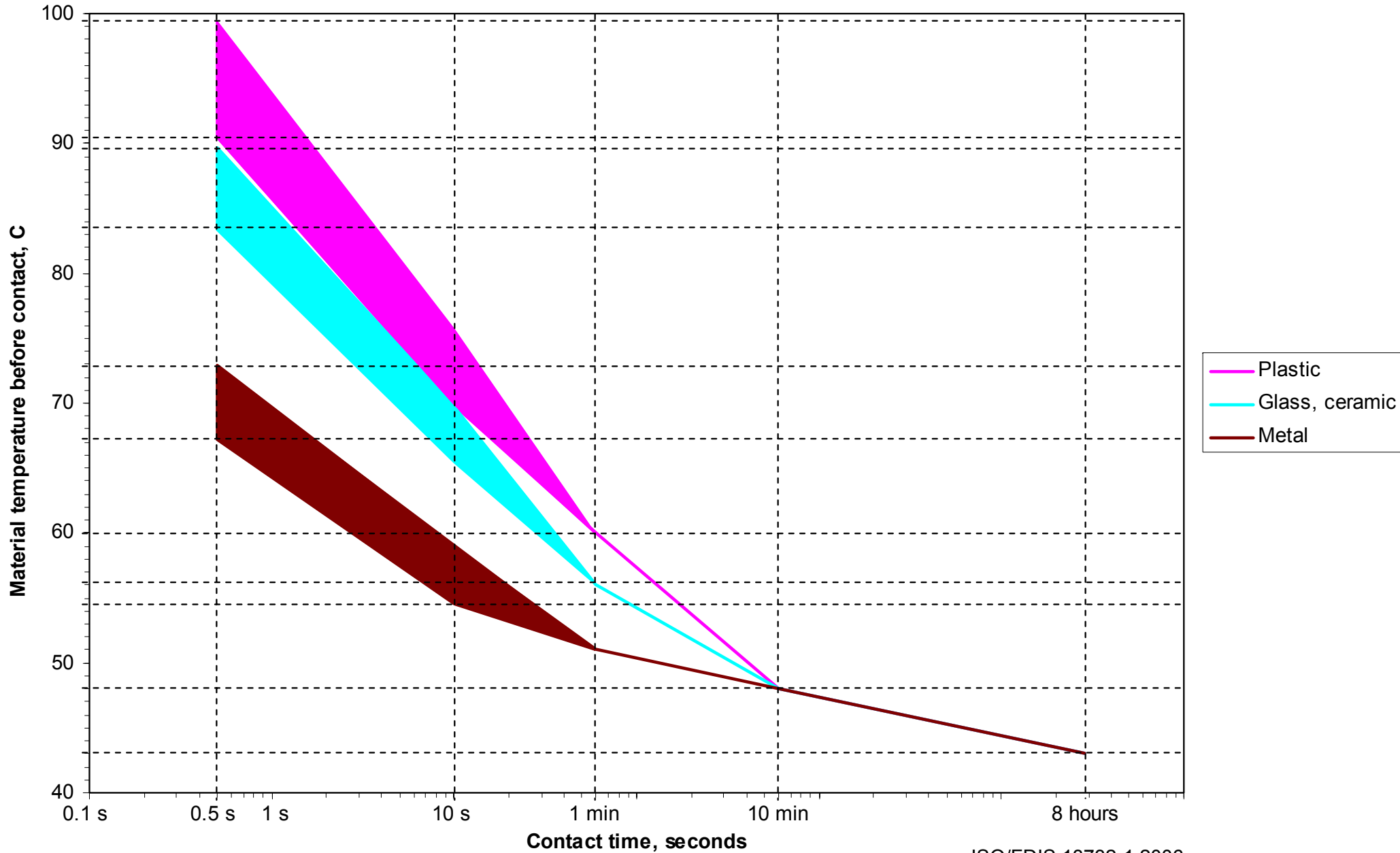

ISO/FDIS 13732-1:2006

Material Temperature and Contact Time

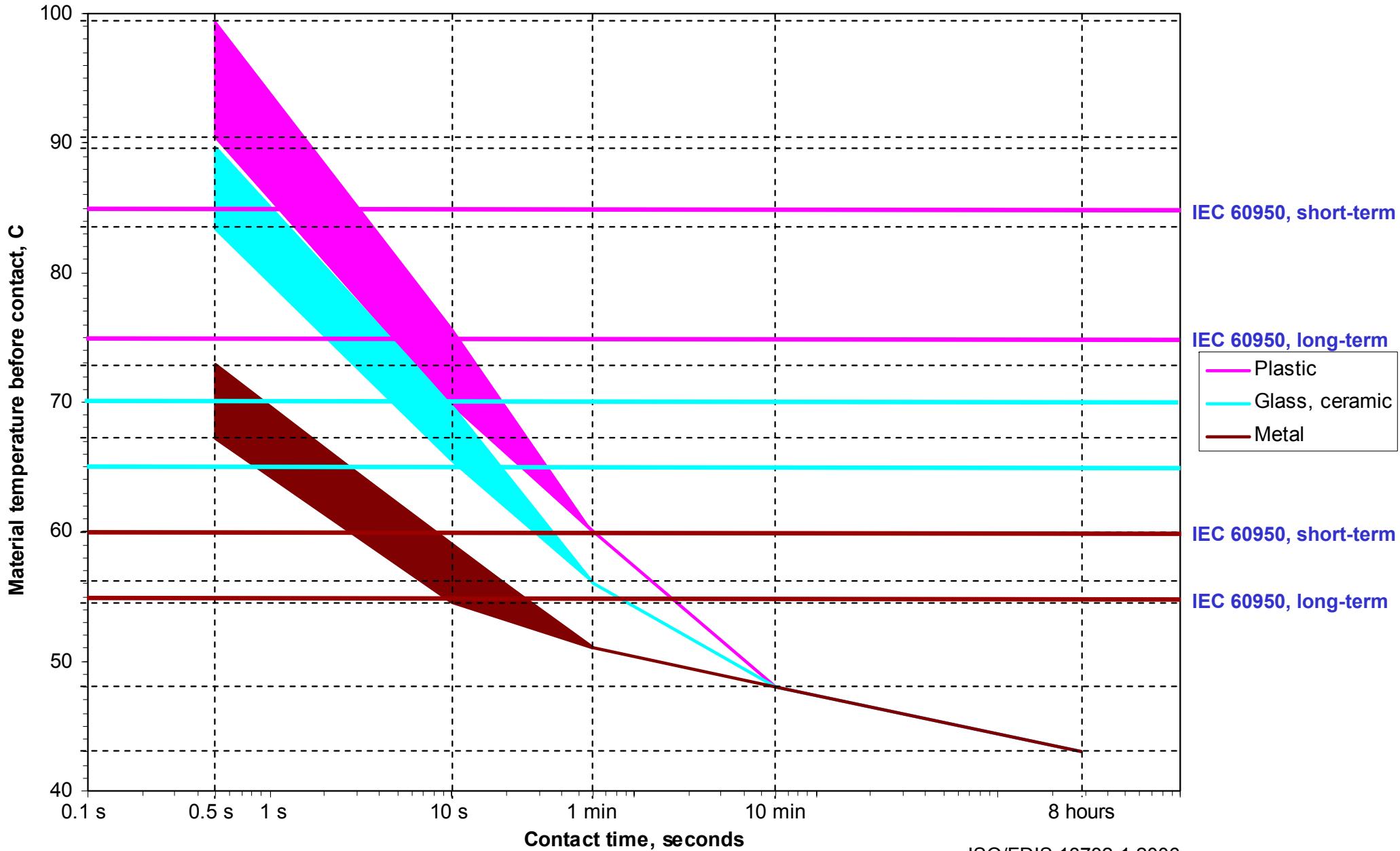

ISO/FDIS 13732-1:2006

What is the temperature of an accessible part that will cause a burn?

When touching a hot object, the skin temperature does not immediately rise to the object temperature, and the object temperature does not immediately fall to the skin temperature.

Heat will flow from the hot object to the cooler skin. The hot object will cool, and the cool skin will heat.

What is the temperature of an accessible part that will cause a burn?

When touching a hot object, the skin temperature will exponentially rise depending on

- (1) the temperature of the hot object,
- (2) the rate of heat flow from the hot object to the skin,
- (3) the heat stored in the hot object,
- (4) the time of contact with the hot object, and
- (5) the rate of heat carried away by the blood.

What is the temperature of an accessible part that will cause a burn?

Heresy:

A burn is due to the skin temperature, not the object temperature.

“The occurrence of burning depends on the temperature of the skin and on the duration of raised skin temperature. The connection between skin temperature, duration of its influence and occurrence of burning has been scientifically studied and is known (see Annex A). But it is not practicable by simple means to measure the temperature of the skin during its contact with a hot surface. Therefore, in this guide it is not the temperature values of the skin that are specified, but the temperature values of hot surfaces that, when in contact with the skin, lead to burns (the burn thresholds). The temperature of a surface is simply measurable by appropriate measuring facilities.”

ACOS: Temperatures of hot surfaces likely to be touched –
Guidance document for technical committees and manufacturers

Material Temperature and Contact Time

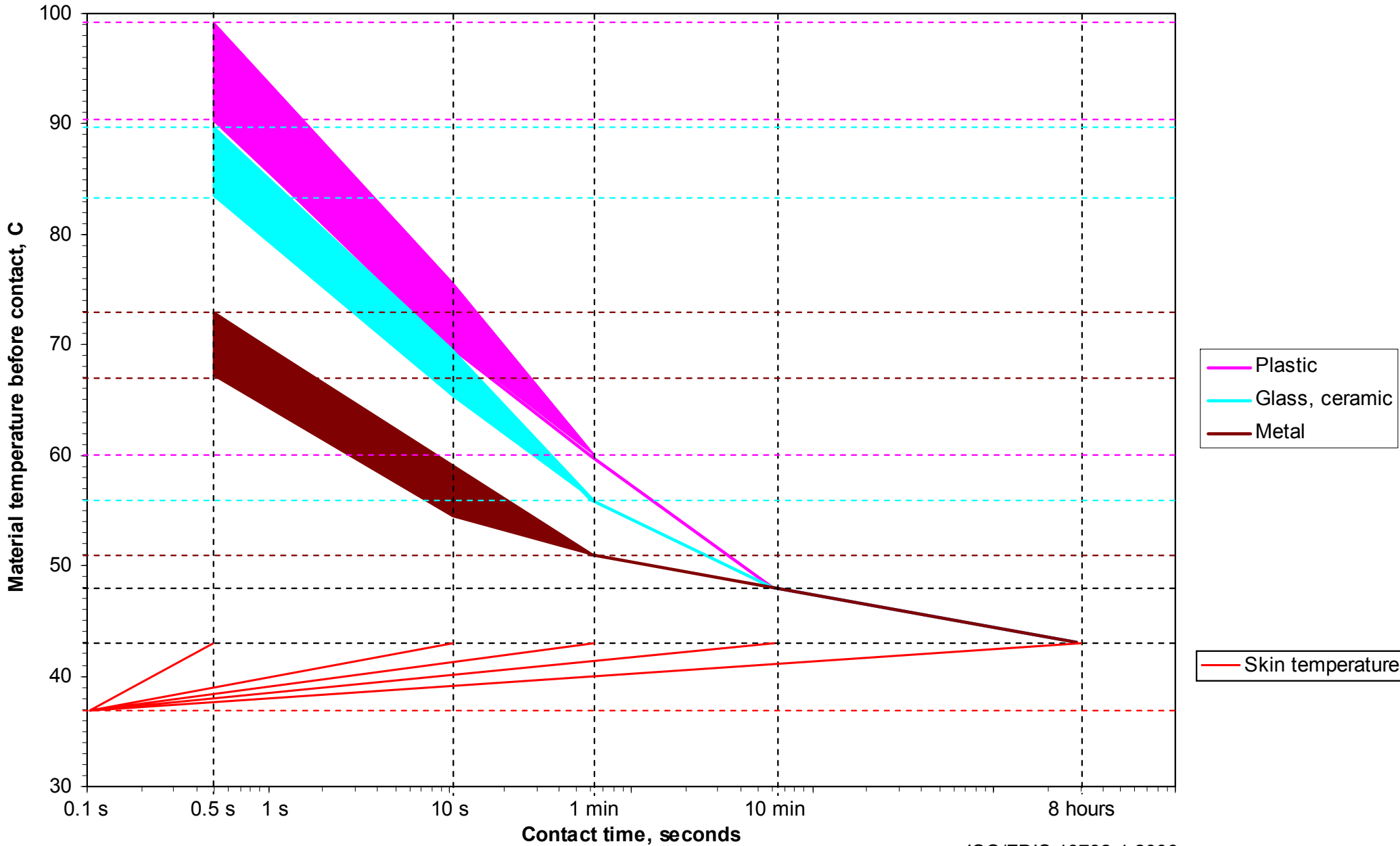

ISO/FDIS 13732-1:2006

HERESY

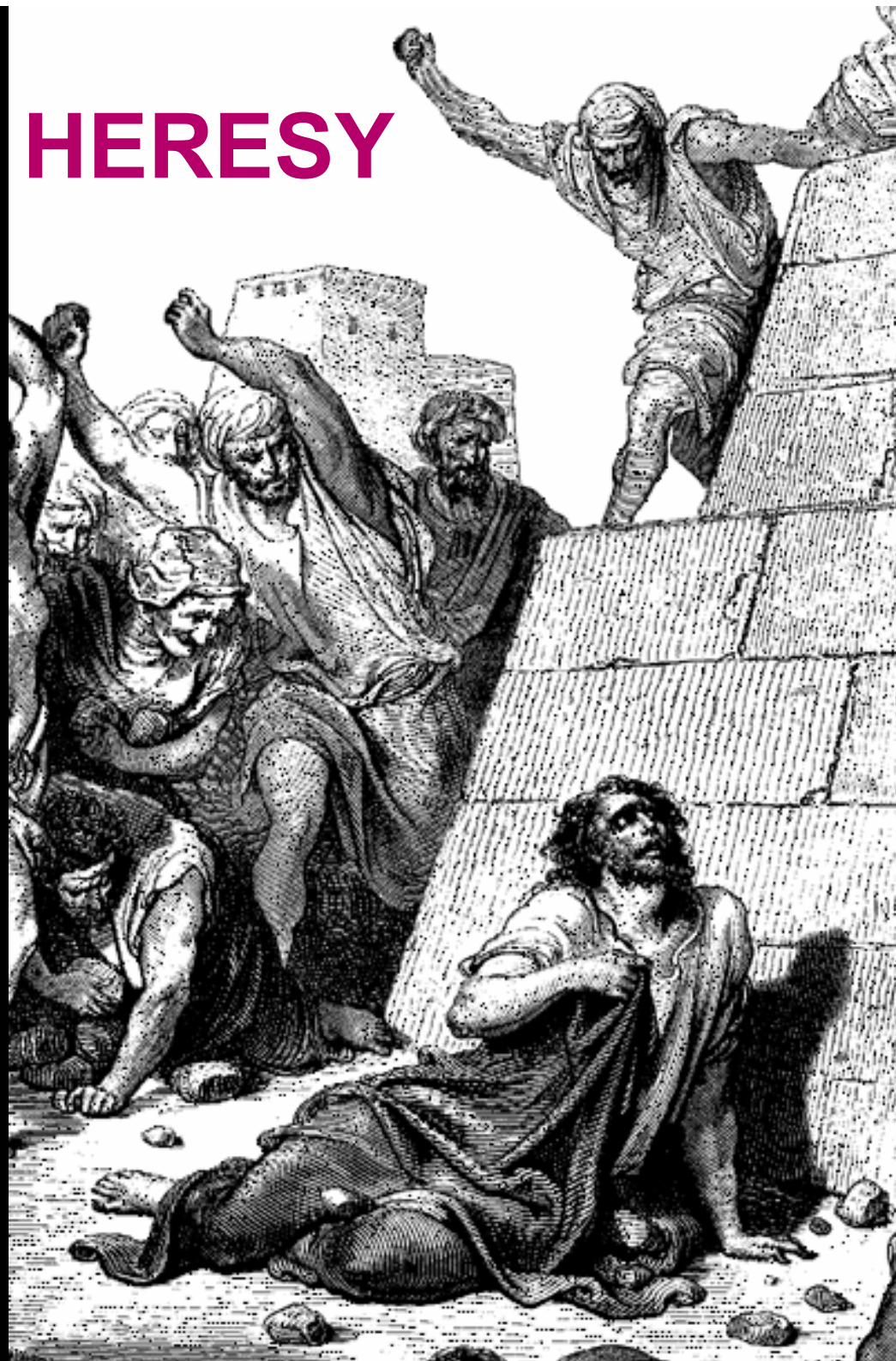

What is the injury that is prevented by making a 240 VA circuit inaccessible?

Dogma:

Orthodoxy:

Conventional Wisdom:

Heresy:

What is the injury that is prevented by making a 240 VA circuit inaccessible?

Dogma: HAZARDOUS ENERGY LEVEL

available power level of 240 VA or more, having a duration of 60 s or more, or a stored energy level of 20 J or more (for example, from one or more capacitors), at a potential of 2 V or more

What is the injury that is prevented by making a 240 VA circuit inaccessible?

Orthodoxy: There shall be no risk of injury due to an energy hazard in an OPERATOR ACCESS AREA.

a) A risk of injury due to an energy hazard exists if it is likely that two or more bare parts (one of which may be earthed) between which a HAZARDOUS ENERGY LEVEL exists, will be bridged by a metallic object.

b) The likelihood of bridging the parts under consideration is determined by means of the test finger, Figure 2A (see 2.1.1.1), in a straight position. It shall not be possible to bridge the parts with this test finger, applied without appreciable force.

What is the injury that is prevented by making a 240 VA circuit inaccessible?

Conventional Wisdom: A 240 VA circuit shall not be accessible.

What is the injury that is prevented by making a 240 VA circuit inaccessible?

Dogma: *Energy* is specified in Volt-Amperes.

Heresy: *Energy* is measured in JOULES.

1 Joule = 1 Watt-second

1 Joule = 1 Volt-Ampere-second (for dc)

What is the injury that is prevented by making a 240 VA circuit inaccessible?

HAZARDOUS ENERGY LEVEL is available power level of 240 VA or more, having a duration of 60 s or more

If

$$1 \text{ Volt-Ampere-second} = 1 \text{ Joule}$$

then

$$240 \text{ Volt-Amperes} \times 60 \text{ seconds} = \underline{\underline{14400 \text{ Joules}}}$$

What is the injury that is prevented by making a 240 VA circuit inaccessible?

4,184,000,000 J = 1 ton of TNT

14,400 J = 0.007 pounds of TNT

What is the injury that is prevented by making a 240 VA circuit inaccessible?

What is the injury likely to result from bridging 14400 Joules with a metallic object?



What is the injury that is prevented by making a 240 VA circuit inaccessible?

Subject 478

-5-

October 14, 1966

29A

Energy Hazard -- An energy hazard is considered to exist at any exposed live part of a piece of equipment if, between the exposed live part and an adjacent exposed live or dead metal part of different polarity, there exists a potential of 2 volts or more and either an available continuous power level of 240 volt-amperes (or more), or a reactive energy level of ~~10~~ ₂₀ joules (or more).

What is the injury that is prevented by making a 240 VA circuit inaccessible?

PARAGRAPH 59

36. The industry representatives said that the manufacturers of EDP equipment have found that, where low voltages are available, two hazards exist for which they recommend that the Laboratories develop appropriate requirements:

Burn Hazard -- Where high current is available at potentials down to about 2 volts, enough energy is present to melt and splatter metal from neck chains, eye-glass frames, watchbands, bracelets, rings, and other personal metal objects unintentionally put across hot bus or between such bus and ground by operators or servicemen, thereby giving rise to a severe burn hazard. One of the industry representatives reported that his company reduces this hazard in such areas by limiting the apparent power available to 240 volt-amperes and the available energy to 10 joules.

What is the injury that is prevented by making a 240 VA circuit inaccessible?

Subject 478

-14-

October 14, 1966

Fire Hazard -- Where high or low current is available at potentials between 1 and 2 volts, the contact resistance is high enough to preclude a burn hazard from splattered metal, but sparks do ignite card lint and other paper dust accumulated in the area because the lint and dust have essentially no thermal inertia.

Heresy:

Paper dust, house dust, and lint do not burn.

What is the injury that is prevented by making a 240 VA circuit inaccessible?

2 A (at 5V) is generally enough for Necklaces become hot (> 100 degC), if they are slightly tensioned

Survey report about circuit-bridging effect by metal objects.
Koichi Sato, IBM Japan Ltd.
June 2, 2003

What is the injury that is prevented by making a 240 VA circuit inaccessible?

Heresy:

No specific injury can be ascribed to 240 VA.

Overheating of jewelry occurs at very much less than 240 VA, namely 10 VA.

HERESY

The heretical tenets may be

- **ignorance of the true creed (the standard),**
- **erroneous judgment, and**
- **imperfect apprehension and comprehension of dogmas (the standard).**

What is the effect of humidity on the breakdown voltage of air?

Dogma:

Orthodoxy:

Conventional wisdom:

Heretical:

What is the effect of humidity on the breakdown voltage of air?

Conventional wisdom:

As humidity increases, the breakdown voltage decreases.

What is the effect of humidity on the breakdown voltage of air?

Under what atmospheric conditions are you most likely to experience electrostatic discharges?

Under what atmospheric conditions are you unlikely to experience electrostatic discharges?

What is the effect of humidity on the breakdown voltage of air?

Water vapor has a higher breakdown strength than air, so a mixture of water vapor and air (i.e. higher humidity) has a higher breakdown voltage.

H₂O also recombines very quickly after dissociation, which increases its breakdown strength (less likely that there are free ions floating around to support an avalanche).

However, surface resistivity decreases with increasing humidity, so leakage and flashovers are more common. Also, if there are small salt or dust particles on the surface, as the humidity increases, they get bigger (because they absorb the water vapor) and provide sites from which breakdown can start.

What is the effect of humidity on the breakdown voltage of air?

The influence of water vapour on the breakdown voltage of uniform field gaps has been investigated by Ritz. He found that the breakdown voltage of a 1-cm. uniform field gap at 760 mm. mercury pressure in air increased by 2 per cent for a change in the partial pressure of water vapour from 10 to 25 mm. mercury.

More recently, Köhrmann has published results which indicate that the presence of water vapour at 10 mm. mercury raised the breakdown voltage by 2.7 per cent above that of dry air at 760 mm. mercury.

Lewis investigated the humidity effect for sphere gaps and quoted an increase of 0.13 per cent in voltage for each mm. mercury of water vapour. This value is rather low compared with the two other results and may be due to the fact that he used a gap of 0.4 cm. between 2-cm. spheres.

Effect of Humidity on the Spark Breakdown Voltage
K. R. ALLEN & K. PHILLIPS

Research Department, Metropolitan-Vickers Electrical Co., Ltd. Trafford Park, Manchester.

What is the effect of humidity on the breakdown voltage of air?

Heresy:

Humid air increases the electric strength.

P. Ortega et al: Impulse Breakdown Voltages of Air Gaps: a New Approach to Atmospheric Correction Factors

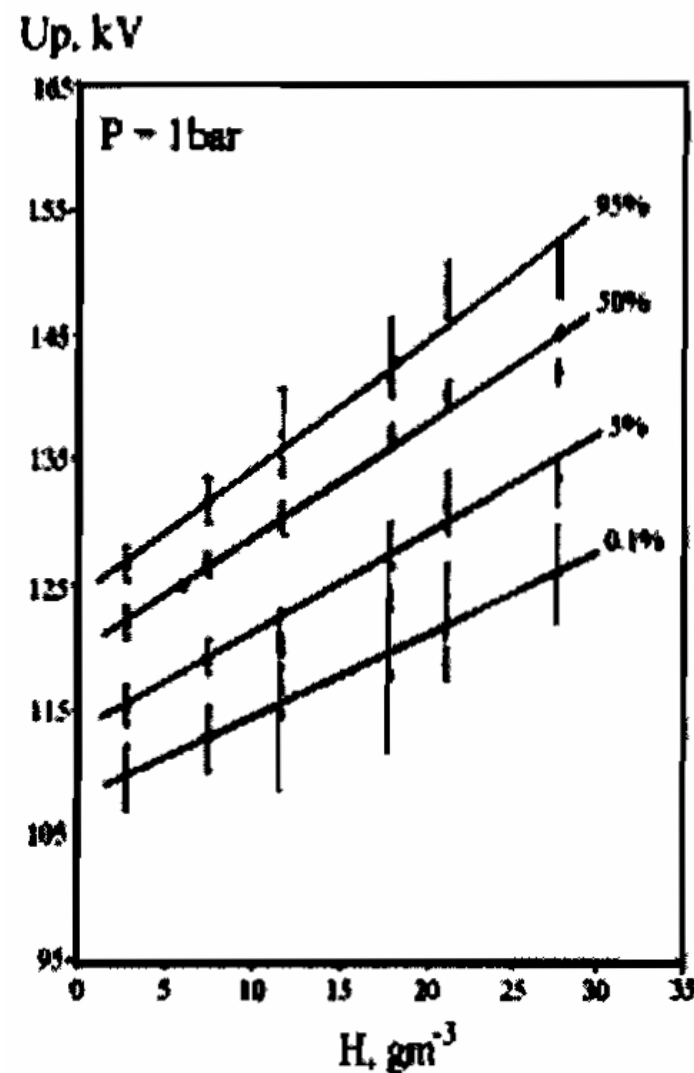

Mumpsimus

1. **One who adheres to an old habit in spite of clear evidence that it is wrong.**
2. **An old custom obstinately kept although it is known to be in error.**

Latin: sumpsimus "we have taken"

From the story of an English priest who upon being corrected for saying in the Mass "quod in ore mumpsimus" retorted "I will not change my old mumpsimus for your new sumpsimus."

Why do we measure leakage current with a touch (leakage) current meter?

Dogma:

Orthodoxy:

Conventional wisdom:

Heretical:

Why do we measure leakage current with a touch (leakage) current meter?

Dogma:

The measuring methods recommended for TOUCH CURRENT are based upon the possible effects of current flowing through a human body.

Orthodoxy:

In this standard, measurements of current through networks representing the impedance of the human body are referred to as measurements of TOUCH CURRENT.

Why do we measure leakage current with a touch (leakage) current meter?

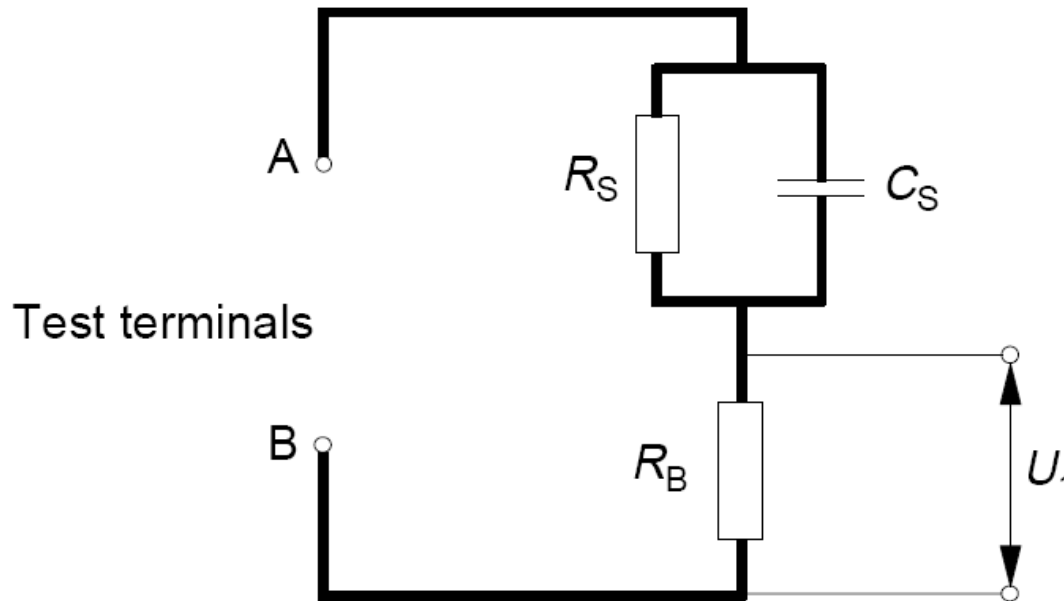

Unweighted touch current

$$= \frac{U_1}{500} \text{ (r.m.s. value)}$$

IEC 1077/99

R_S	1 500 Ω	} $R_S + R_B = 2\,000 \Omega$
R_B	500 Ω	
C_S	0,22 μF	
X_c	120.6 k Ω	

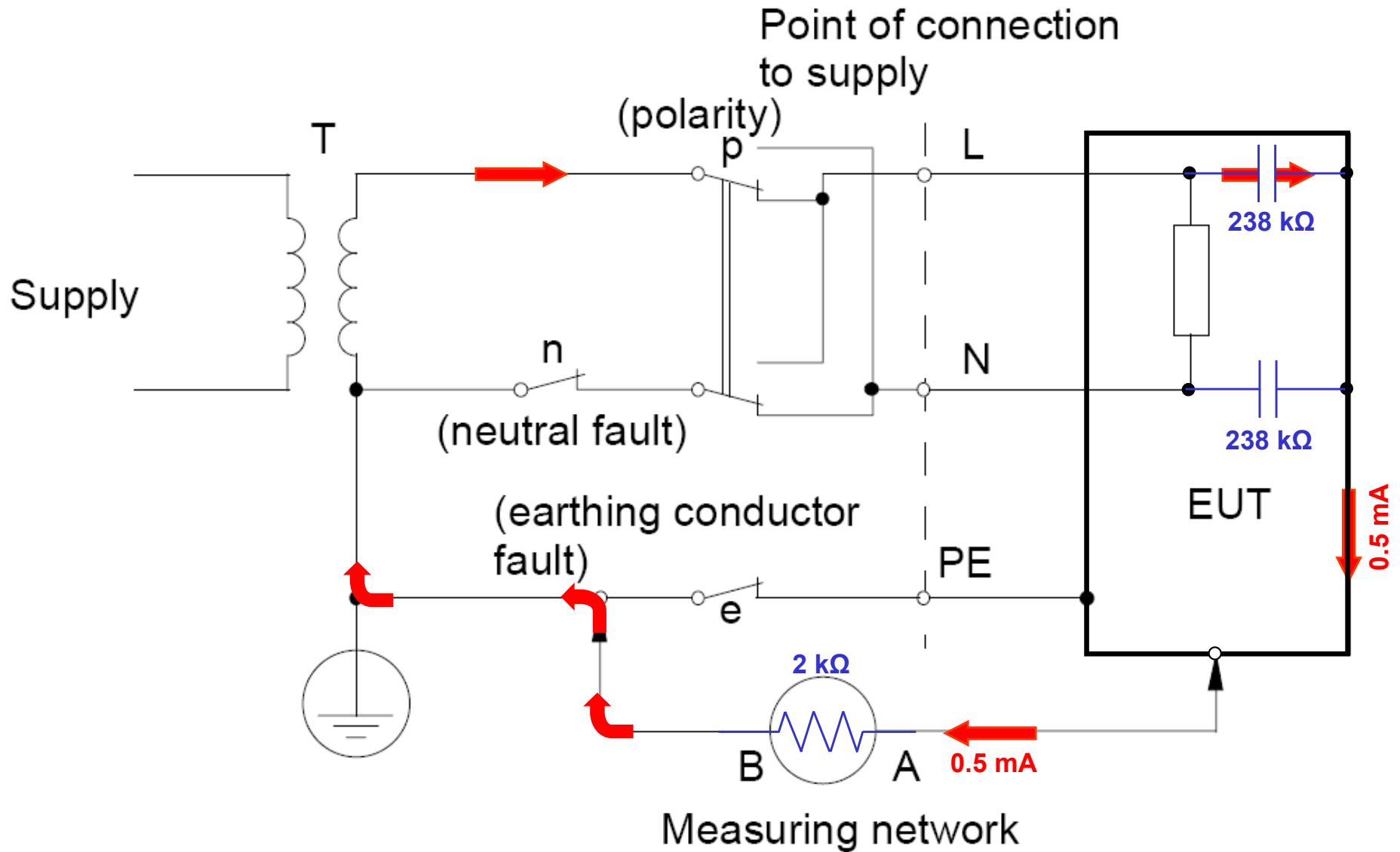

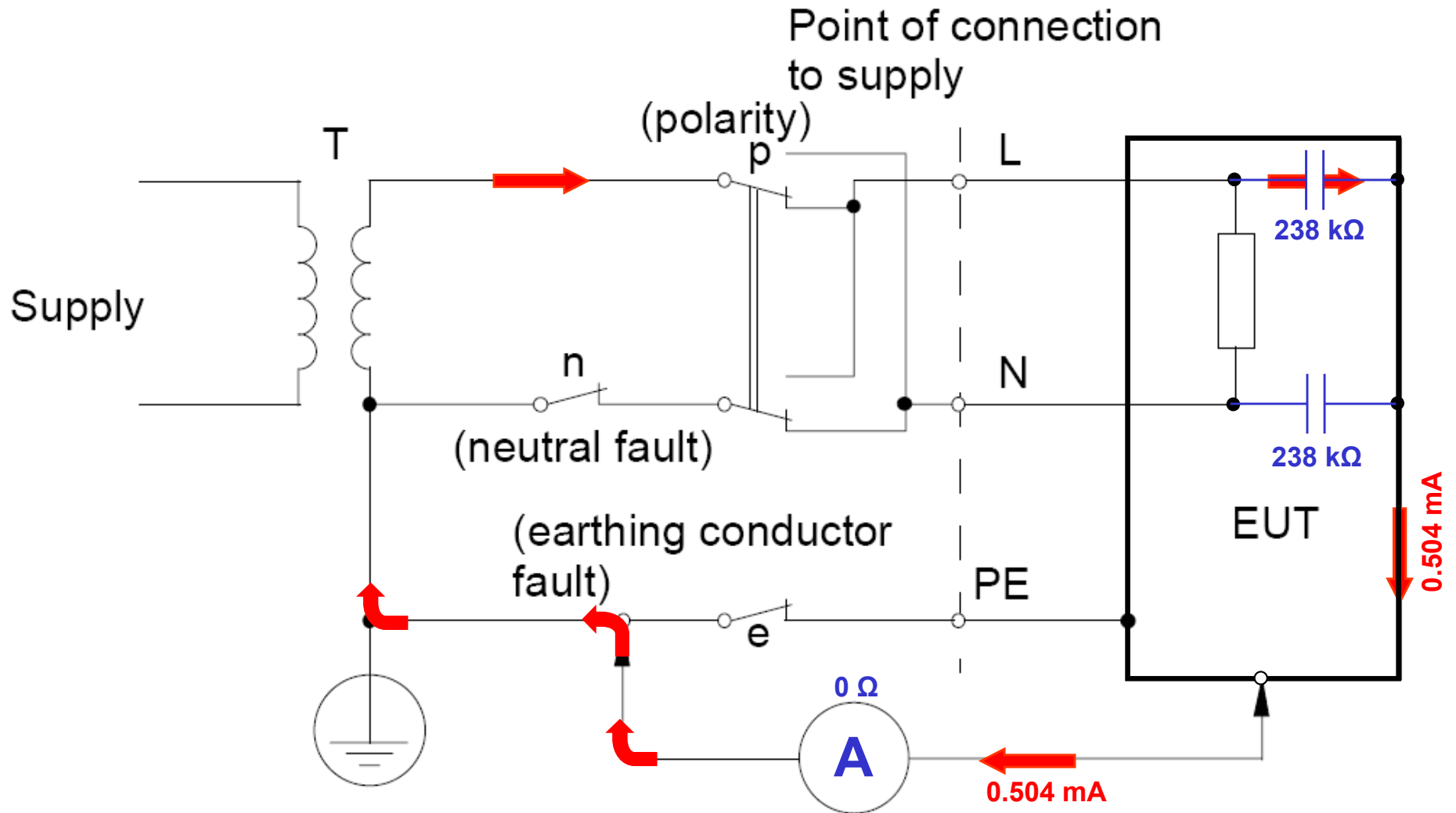

Why do we measure leakage current with a touch (leakage) current meter?

Assume the touch current meter is 2,000 ohms.

When the touch current meter indicates 0.5 mA, and the source is 120 V, then the total resistance is

$$R = \frac{E}{I} = \frac{120}{0.0005}$$

$$R = 240 \text{ k ohms}$$

$$X_c = 240 \text{ k ohms} - 2 \text{ k ohms}$$

Assume the touch current meter is an ammeter (0 ohms).

When the ammeter is connected in series with 238 k ohms, the ammeter current is

$$I = \frac{E}{R} = \frac{120}{238,000}$$

$$I = 0.504 \text{ mA}$$

Why do we measure leakage current with a touch (leakage) current meter?

Heresy:

An ordinary ammeter provides an easy and pessimistic (~ 1% error on the high side) measure of leakage current.

BAMBOOZLE

“One of the saddest lessons of history is this: If we’ve been bamboozled long enough, we tend to reject any evidence of the bamboozle. We’re no longer interested in finding out the truth. The bamboozle has captured us. It’s simply too painful to acknowledge, even to ourselves, that we’ve been taken. Once you give a charlatan power over you, you almost never get it back. So the old bamboozles tend to persist as the new ones rise.”

Dr. Carl Sagan

A Demon-Haunted World: Science as a Candle in the Dark.

What is a **CRITICAL COMPONENT**?

Why is it *critical*?

Dogma:

Orthodoxy:

Conventional wisdom:

Heretical:

What is a **CRITICAL COMPONENT**?

Why is it *critical*?

Conventional wisdom:

- A component which affects the safety of the equipment.
- Those electrical components or assemblies used in a power or safety circuit, whose proper operation is critical to the safe performance of the system or circuit.
- All components in primary circuitry.
- A component whose failure leads to “a risk of electric shock, fire, personal injury.”

What is a **CRITICAL COMPONENT**?

Why is it *critical*?

If the failure of a component leads to a likelihood of injury, then the component must be designed such that it is not subject to failure for the lifetime of the equipment.

Such a component would be a safety-critical component. And, in many cases, it would need to be certified to safety requirements applicable to the particular component, which ultimately means the component is not likely to fail when subjected to the rigors of use.

An example of such a component would be a Y1 capacitor.

What is a CRITICAL COMPONENT? Why is it *critical*?

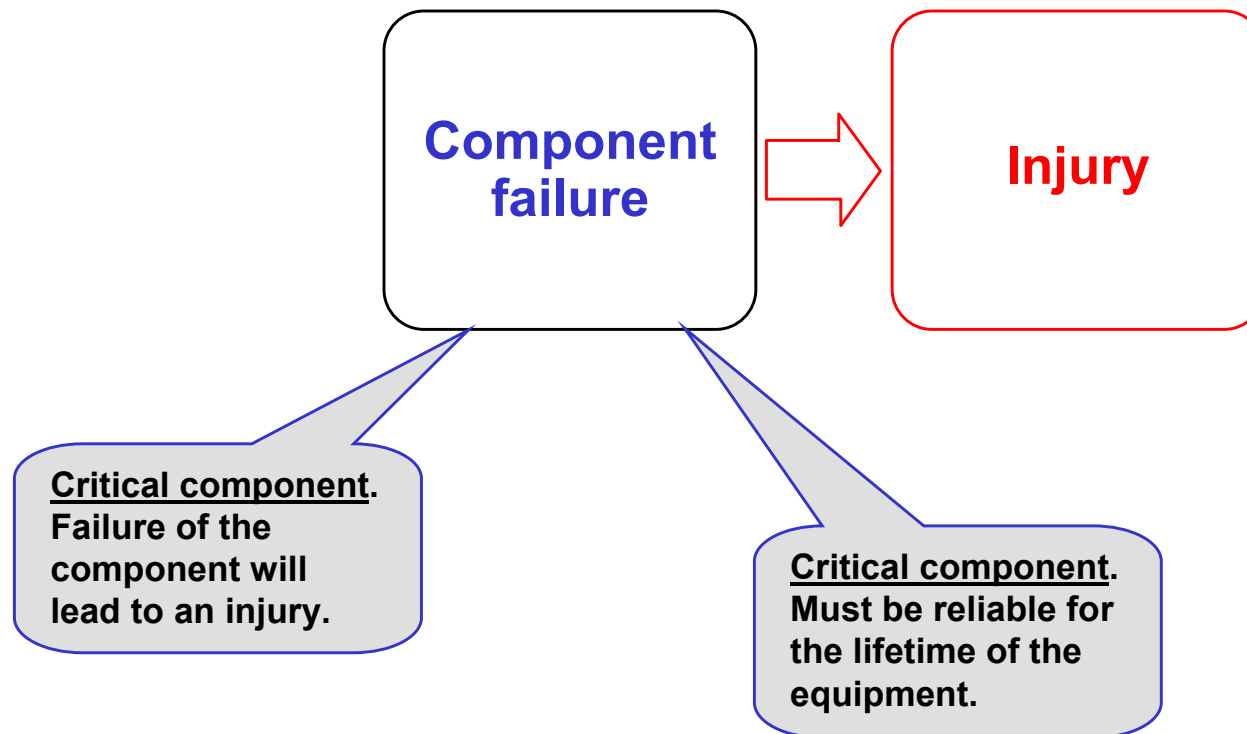

What is a **CRITICAL COMPONENT**?

Why is it *critical*?

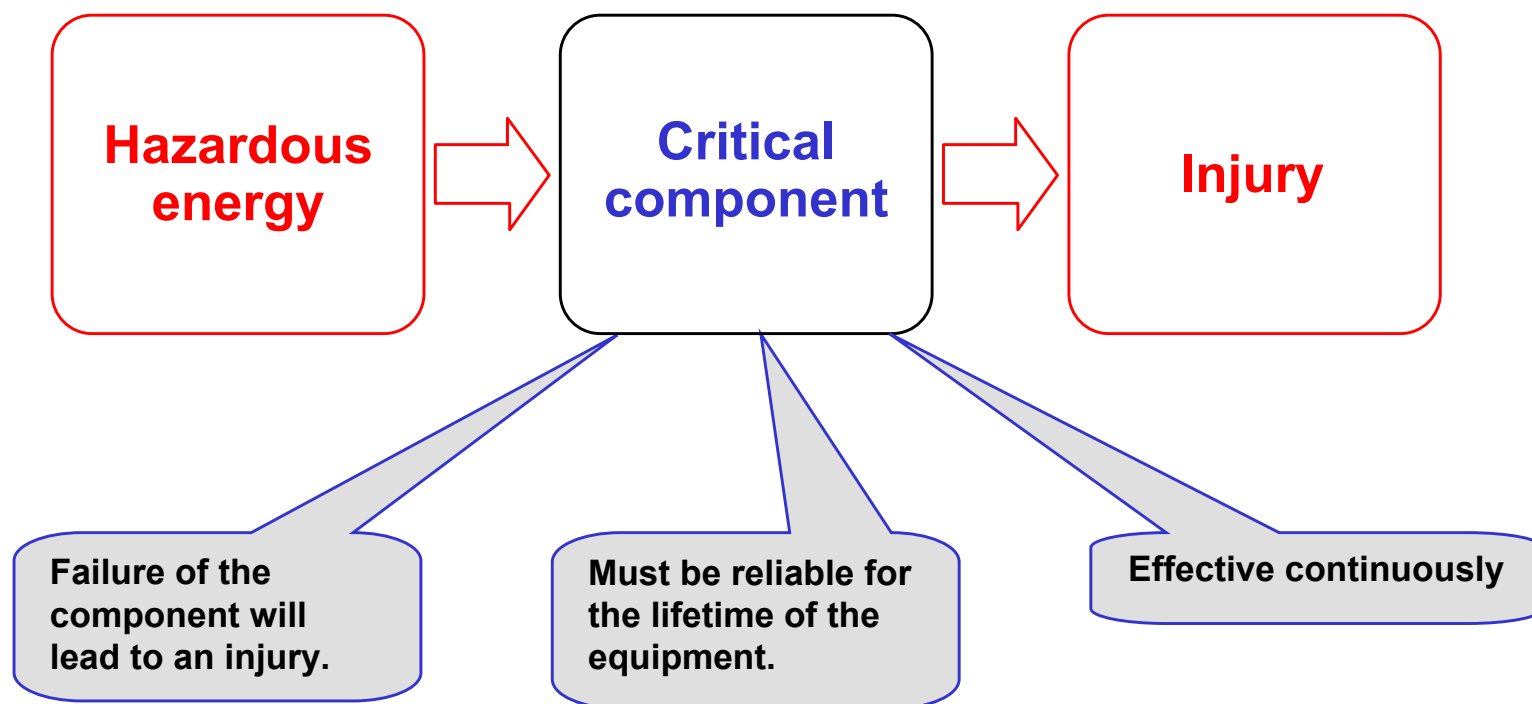

What is a **CRITICAL COMPONENT**?

Why is it *critical*?

Alternatively, if the failure of a component leads to a likelihood of injury, then a second component or safety scheme must be installed so as to mitigate the consequences of failure of the first component.

This second component or safety scheme also is a safety-critical component.

An example of such a scheme is the protective earthing scheme.

What is a CRITICAL COMPONENT? Why is it *critical*?

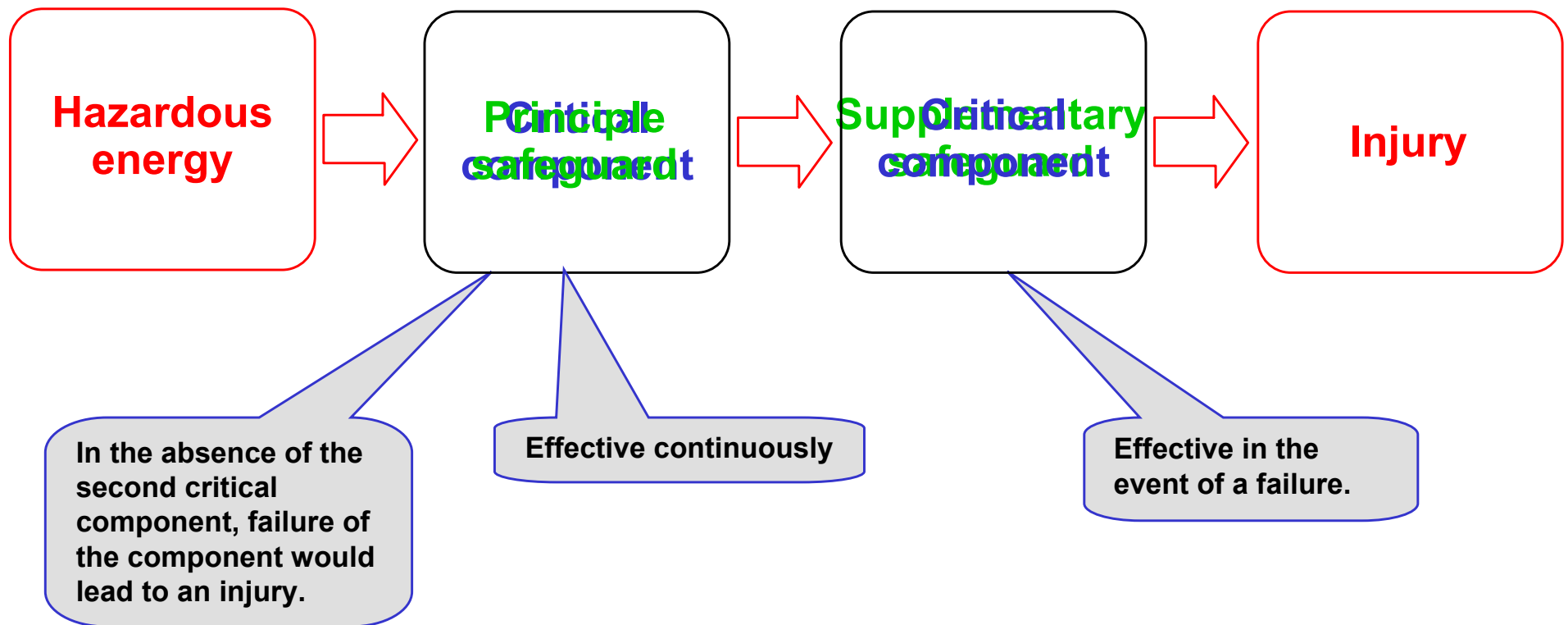

MODEL FOR INJURY

A HAZARD (or HAZARDOUS energy source) is:
an energy source that exceeds the body
susceptibility limits.

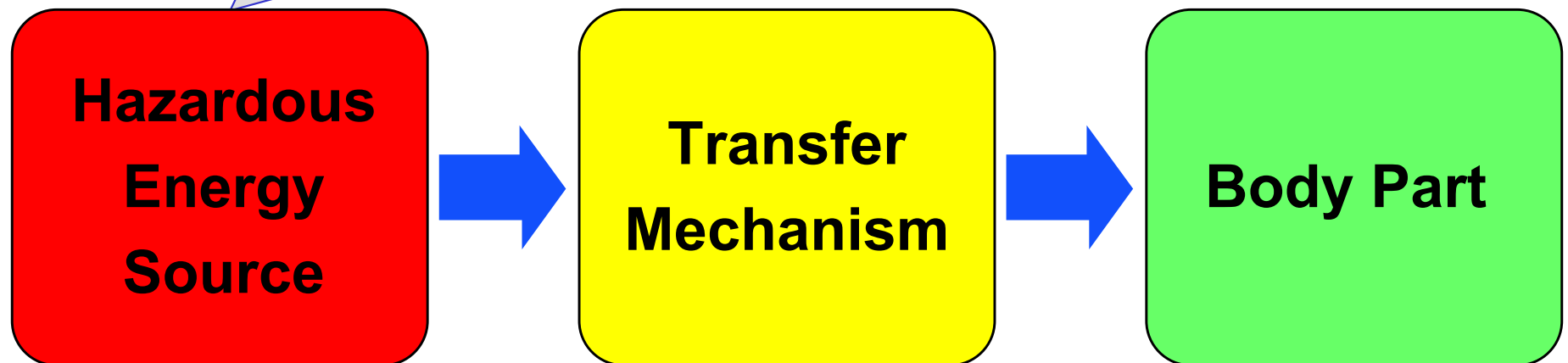

MODEL FOR SAFETY

SAFE or SAFETY is: a situation where at least one *safeguard* is interposed between the body and a hazardous energy source.

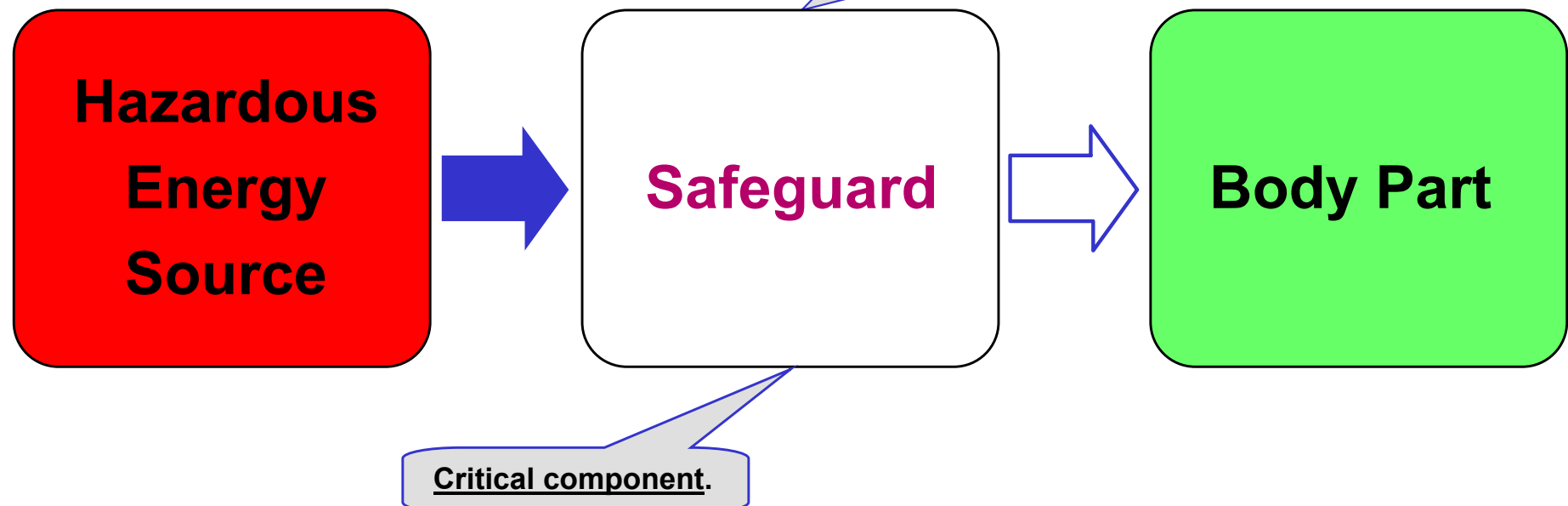

What is a CRITICAL COMPONENT? Why is it *critical*?

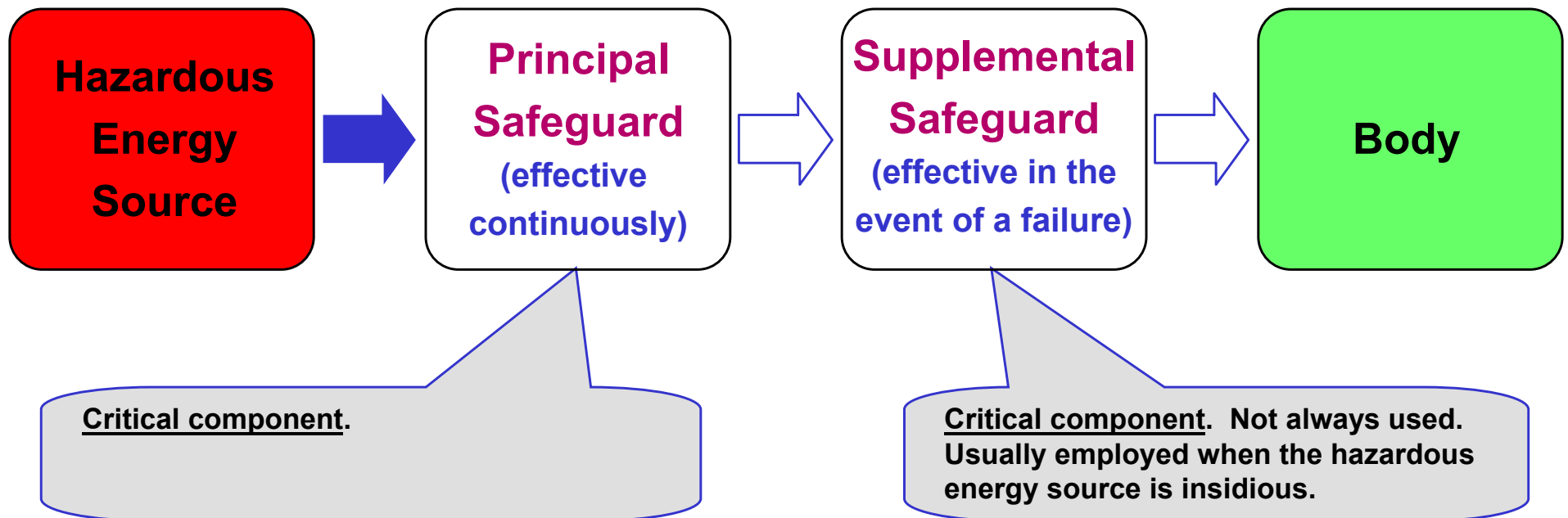

HERESY!

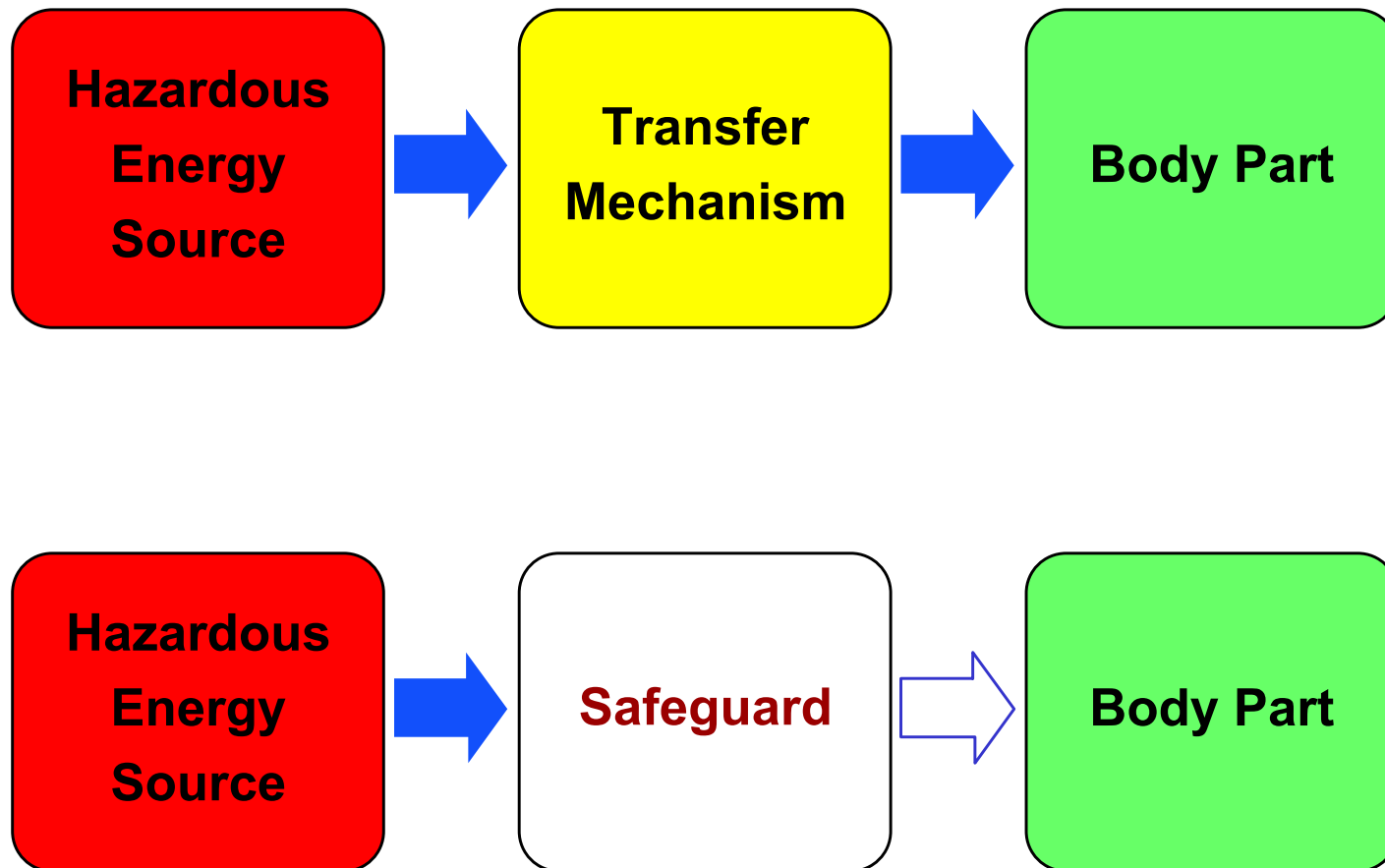

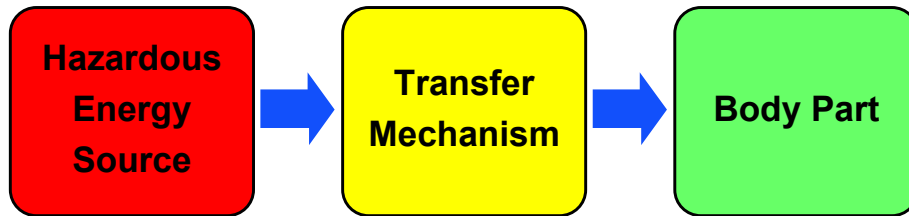

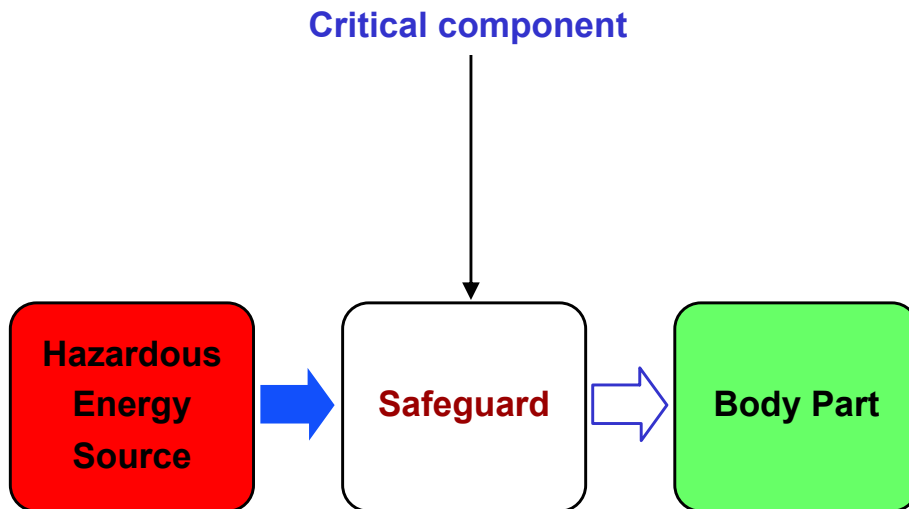
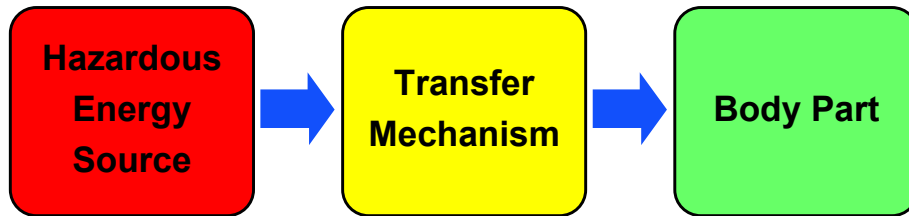

HERESY!

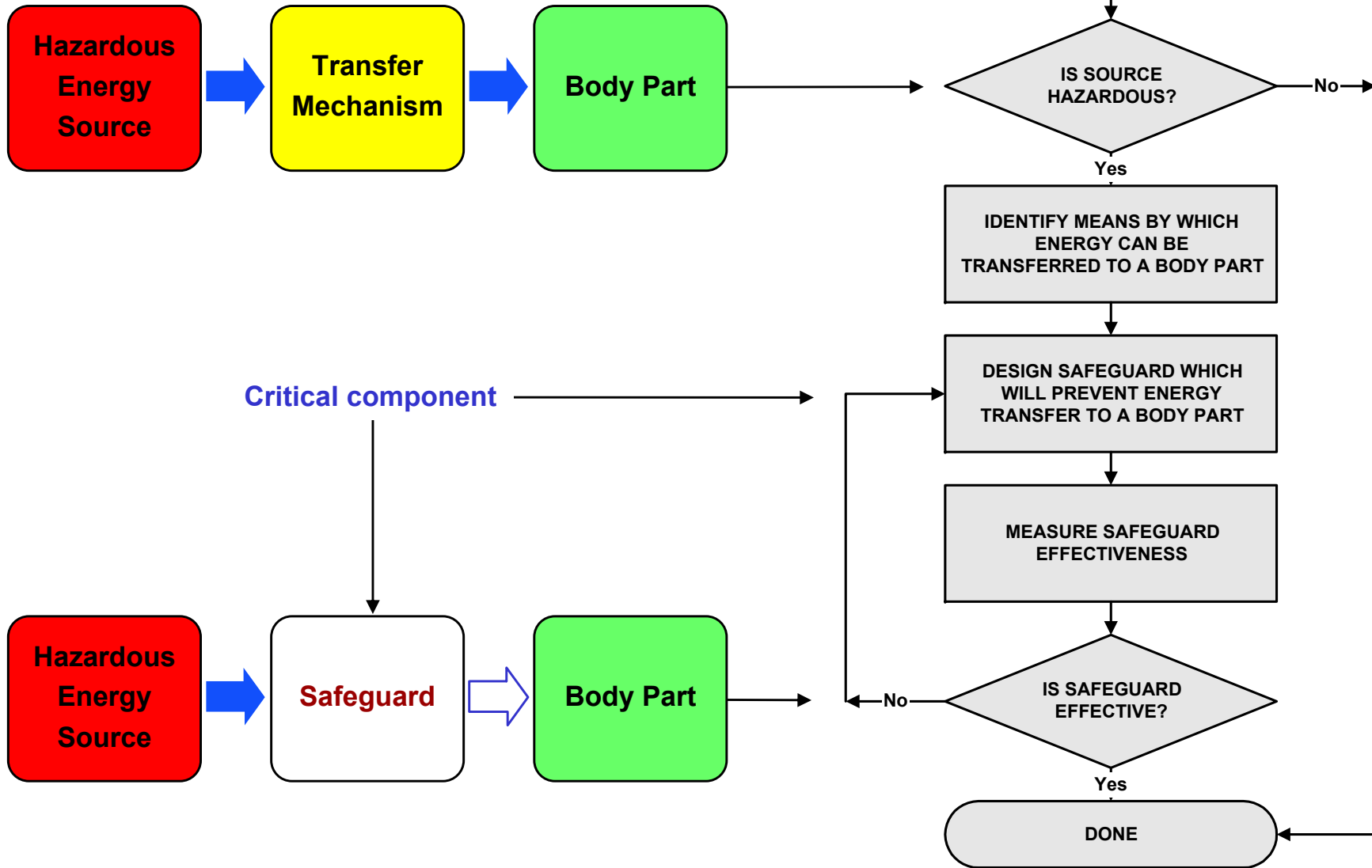





HEY HERETIC RICH,
HOW IS LIFE?



I DON'T UNDERSTAND - WHAT
IS THE BIG DEAL ABOUT
BEING A HERETIC?



HEY HERETIC RICH,
HOW IS LIFE?



I DON'T UNDERSTAND - WHAT
IS THE BIG DEAL ABOUT
BEING A HERETIC?



IF YOU DON'T WORSHIP
THE STANDARD, THE
CERTIFIERS WILL SMITE
THEE!



HEY HERETIC RICH,
HOW IS LIFE?

I DON'T UNDERSTAND - WHAT
IS THE BIG DEAL ABOUT
BEING A HERETIC?

IF YOU DON'T WORSHIP
THE STANDARD, THE
CERTIFIERS WILL SMITE
THEE!



I CONSIDER MYSELF AN
ENLIGHTENED ENGINEER. I DON'T
NEED THE PROMISE OF STANDARDS
OR THE THREAT OF CERTIFIERS.
ENGINEERING IS THE ANSWER. IT'S
THE NEW MILLENEIUM - WE DON'T
NEED STANDARDS ANY MORE.



HEY HERETIC RICH,
HOW IS LIFE?



I DON'T UNDERSTAND - WHAT
IS THE BIG DEAL ABOUT
BEING A HERETIC?



IF YOU DON'T WORSHIP
THE STANDARD, THE
CERTIFIERS WILL SMITE
THEE!

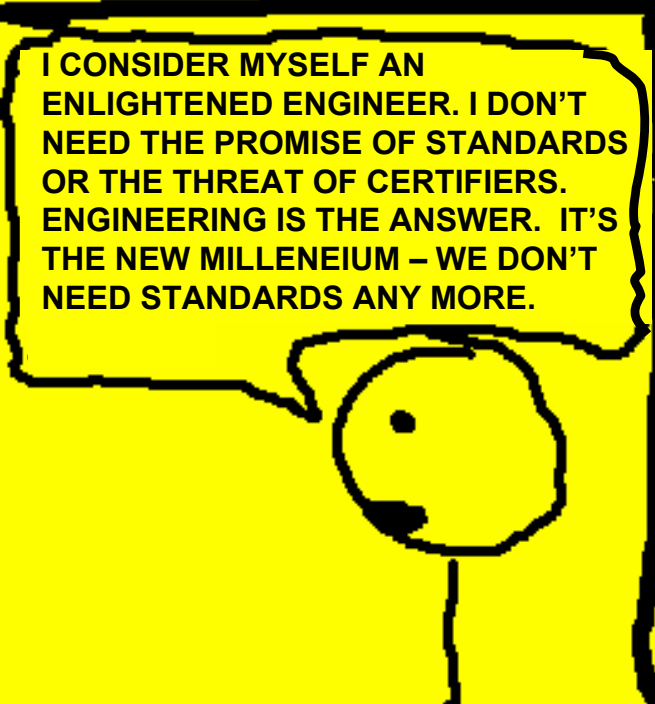

I CONSIDER MYSELF AN
ENLIGHTENED ENGINEER. I DON'T
NEED THE PROMISE OF STANDARDS
OR THE THREAT OF CERTIFIERS.
ENGINEERING IS THE ANSWER. IT'S
THE NEW MILLENEIUM - WE DON'T
NEED STANDARDS ANY MORE.



HOW CAN YOU SAY
THAT! YOUR
HERESY BLOWS MY
MIND!



HEY HERETIC RICH,
HOW IS LIFE?



I DON'T UNDERSTAND - WHAT
IS THE BIG DEAL ABOUT
BEING A HERETIC?



IF YOU DON'T WORSHIP
THE STANDARD, THE
CERTIFIERS WILL SMITE
THEE!

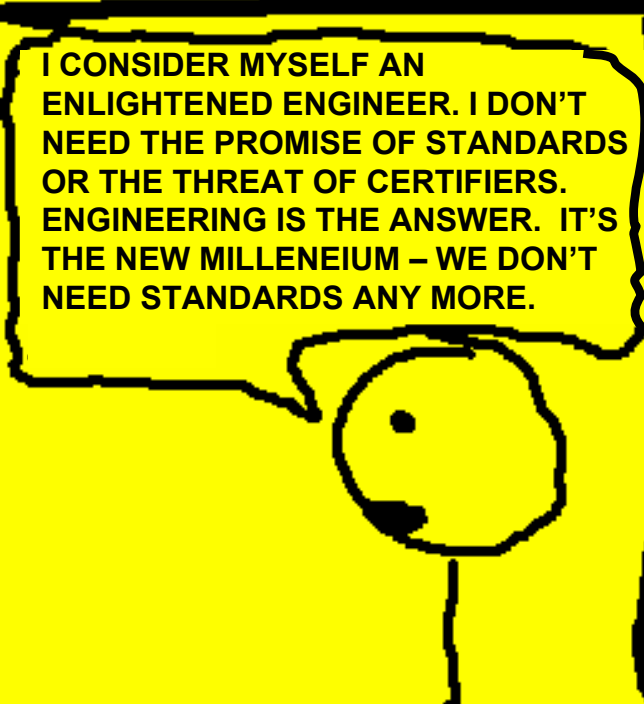

I CONSIDER MYSELF AN
ENLIGHTENED ENGINEER. I DON'T
NEED THE PROMISE OF STANDARDS
OR THE THREAT OF CERTIFIERS.
ENGINEERING IS THE ANSWER. IT'S
THE NEW MILLENEIUM - WE DON'T
NEED STANDARDS ANY MORE.

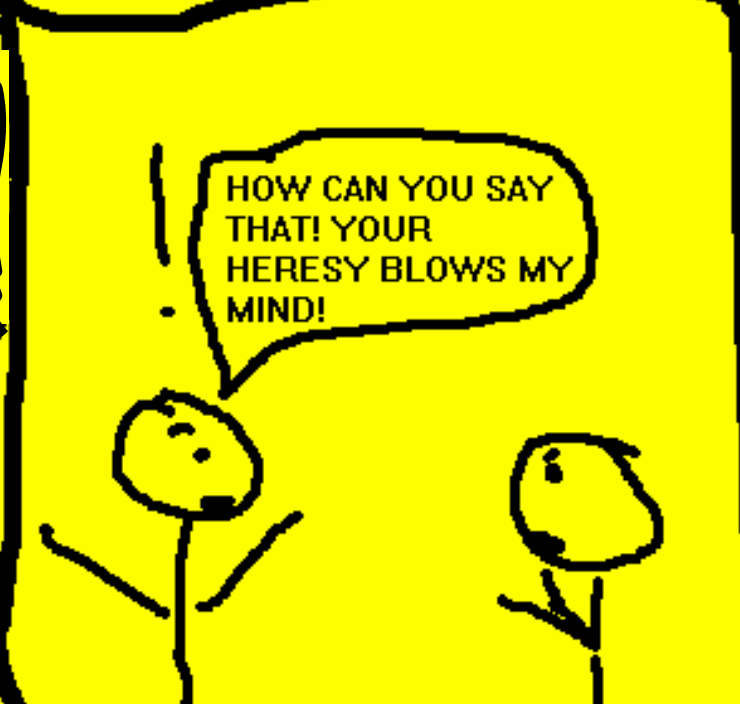

HOW CAN YOU SAY
THAT! YOUR
HERESY BLOWS MY
MIND!



LOOK! NOW YOU'VE DONE
IT! YOU'VE GONE AND MADE
THE CERTIFIERS MAD!



HERETICAL VIEWS of CONCEPTS in PRODUCT SAFETY



by Richard Nute
Heretical Product Safety Consultant
San Diego

