

Integrated Systems for a Smarter Planet (a Trillion Networked Sensors)

H. Peter Hofstee, Ph.D.
IBM Austin Research Laboratory

What this talk is and is not

- Is
 - An investigation about how we are going about instrumenting our planet
 - An investigation of scale

- Is not
 - A sales pitch ☺
 - A talk by an expert ... this is not my day job!
 - My employer's opinion ...
 - (in particular IBM is not endorsing any of the companies mentioned)

What Smarter Planet means to IBM

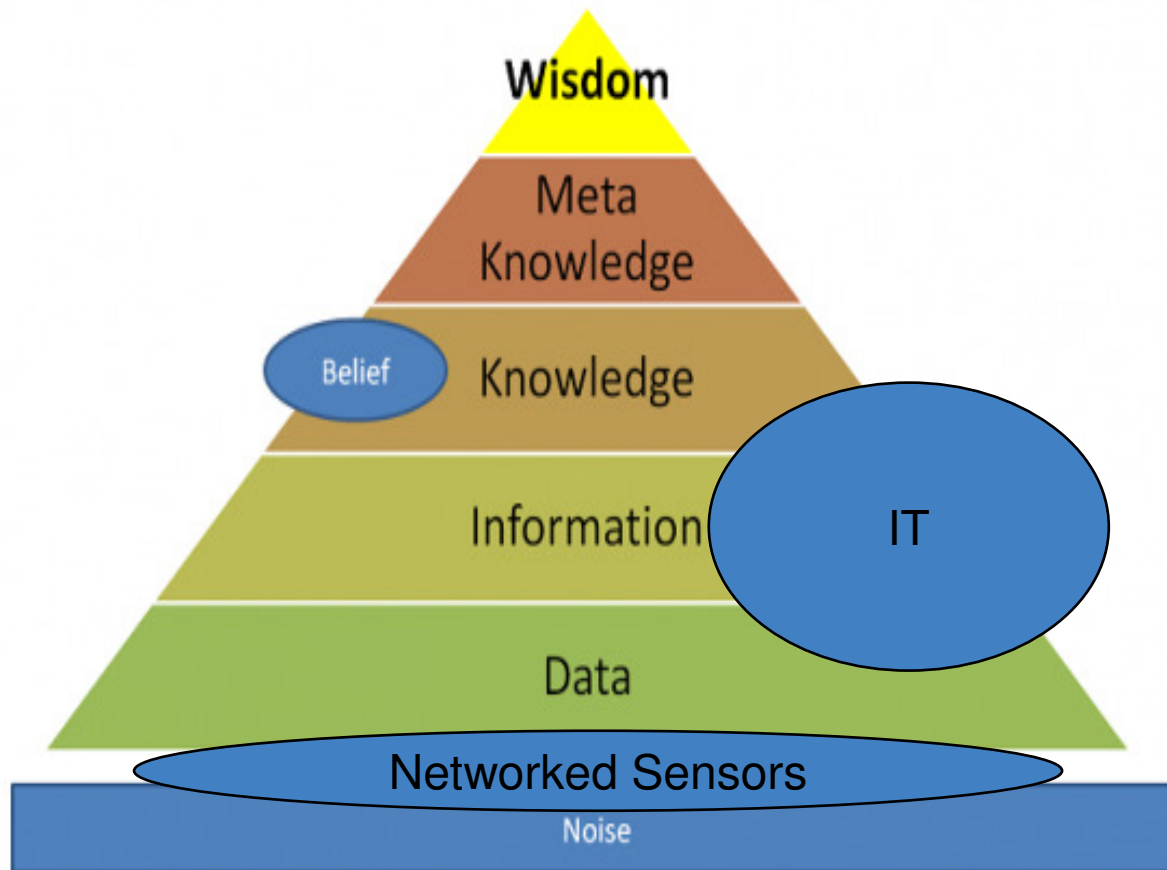

- Environment
(Water, Air, Soil)
- Energy
- Health
- Security
- Infrastructure
 - Buildings
 - Bridges
 - Roads
 - Cities
- ...

Network Connected Objects

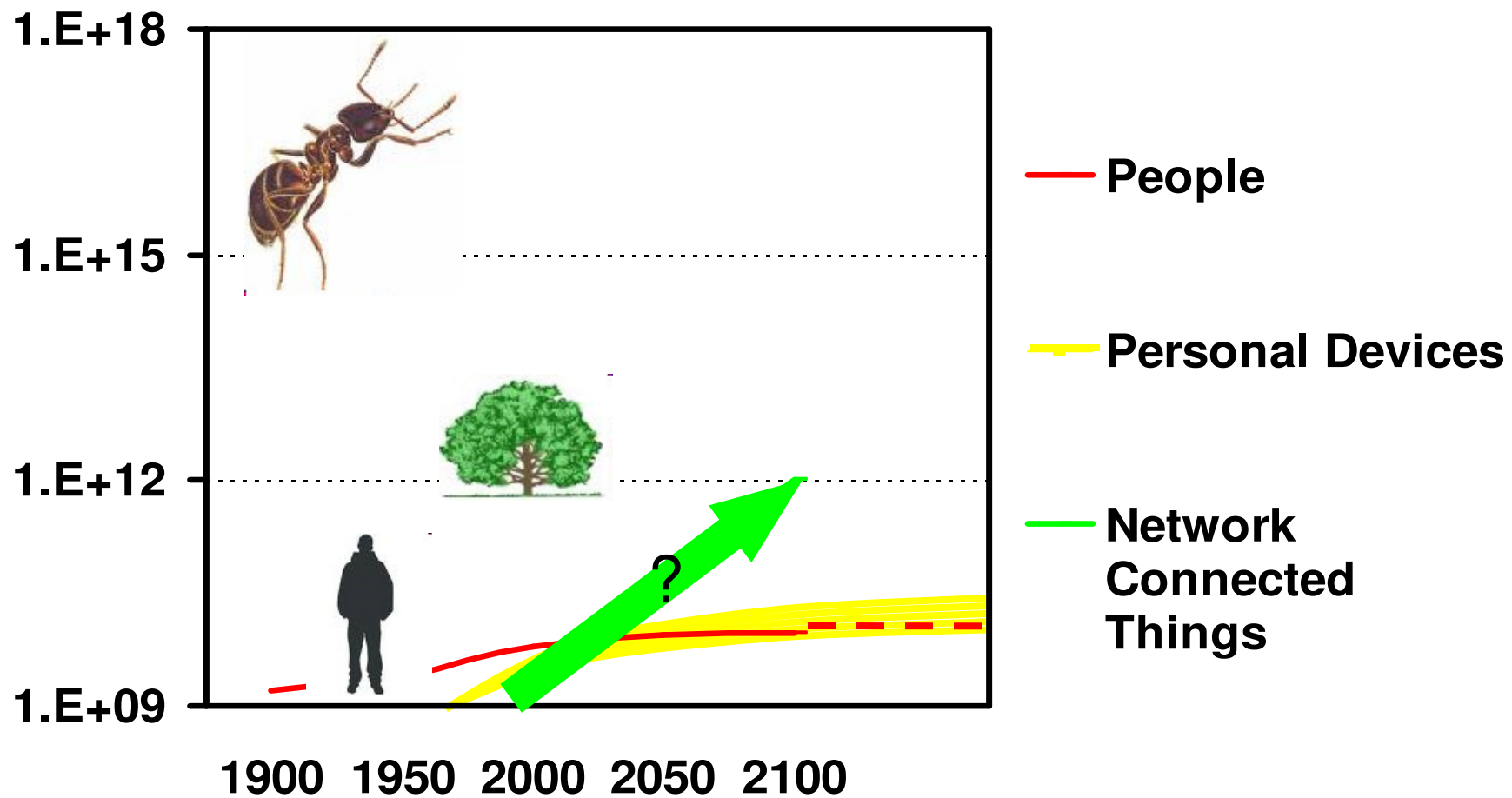

Is 50B Interconnected Sensors by 2020 Reasonable?

- 50B Connected Sensors
 - O(10) Interconnected sensors per person

- Don't have to look very far
 - Car
 - Home
 - Cell Phone

Car Sensors

- 50 sensors in mid-range car today, e.g.:
- Airbag (inertial) sensors
 - 1-5 per car
 - Also requires weight sensors
- Tire sensors
 - Introduced in 1986 (Porsche)
 - Mandatory after Ford rollover accidents
 - Wireless communication with central unit (usually same as keyless entry)
 - Unencrypted ... you can identify each tire easily (**also from outside the car!**)
- Exhaust sensors
 - Could well become mandatory
 - Oxygen, Fuel, CO, temperature ..
- 1B vehicles by 2020 @ 50 sensors per car:
 - **50B sensors by 2020 from cars alone!**
 - (But maybe not all networked)

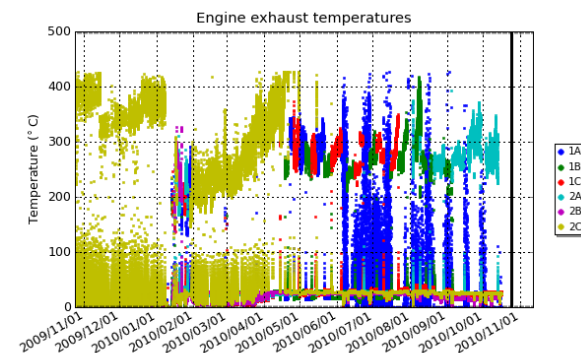
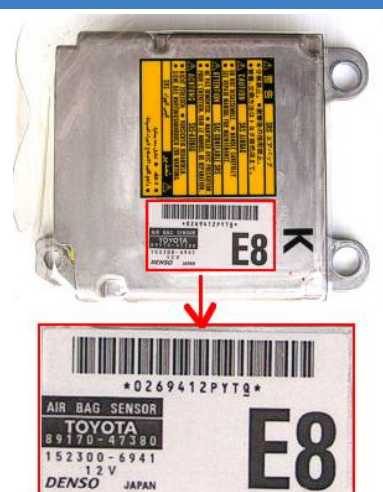

Home

- About 1.5 Billion Households
- Sensors present in most homes
 - Electricity meter
 - Gas meter
 - Water meter
 - Thermostats (several)
 - Particle sensors (fire alarms)
 - CO sensors
- Other sensors
 - Burglar alarms (many sensors)
 - Cameras
 - ...
- Home equipment with sensors
 - Washing machine
 - Dishwasher
 - Oven
 - Refrigerator
 - Microwave
 - ...
- Future scenarios
 - Humidity sensor for every potted plant
 - Power usage sensor for each device
 - Accelerometers in every TV/computer
- Sensible ways to connect them
 - Home electric network
 - Wireless

Net: 100 sensors in a home does not seem like a stretch, 1,000 does not seem impossible

Mobile Phones

- 5 Billion Active Mobile Phones in 2010 (Source: Ericsson)

- Multiple sensors per phone already

- Microphone
- Battery level
- Camera
- GPS
- RFID
- Gyro (orientation)
- Accelerometer
- Temperature (internal)
- Touch/Fingerprint

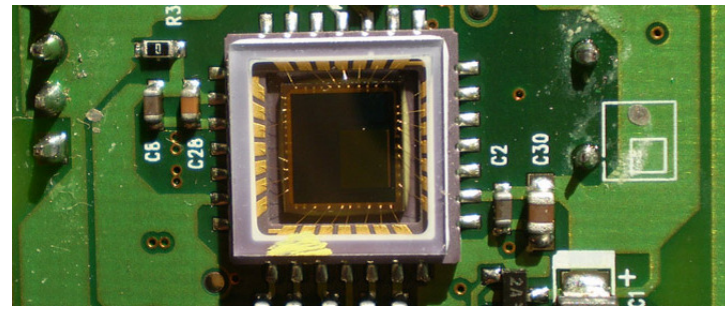

- Easy to get to 50B connected sensors by 2020 from Cell phones alone!
 - All kinds of things you can do with these ...

Use What's Out There Already ...

EMBEDDED INTERNET

All
 Articles
 Products
 Course
 TechPaper
 Webinars

HOME DESIGN FORUMS E-LEARNING PRODUCTS Login | Register Welcome, Guest

Saturday, October 23, 2010

MEMS-packed smartphones are world's biggest wireless sensor net

The ever-expanding ecosystem of smartphone apps owes a great deal to MEMS sensors. Indeed, smartphones, with their always-on Internet access and growing complement of sensor technologies, are quickly becoming the planet's premier wireless sensor network.

"The cell phone is inherently a sensor; even its microphone gives you information on what type of environment you are in, from background or perhaps traffic noise. By using sensor fusion, you can take information from all of these sensors, even the ambient-light sensor, and create apps that have never been thought of before," noted iSuppli Corp. analyst Jeremie Bouchard.

MEMS-packed smartphones double as nodes in a wireless sensor network that's fast blanketing the Earth

Sampling of sensor vendors

Manufacturer	Accelerometer	Gyroscope	Pressure	Microphone	Oscillator
Alps Electronics					
Amberg Densim					
Alibaba					
Beach Semiconductor					
Denso					
Epson-Toscan					
Discom					
Enlight					
Epson					
Freemove					
Goodix Technologies					
Rockwell-Packard (sampling)					
Terence					
Omnic					
Siemens					
Measurement Specialties					
Mitsumi					
Parasense					
Sensata Technologies					
Silicon Labs					
Sensonor Technologies					
STMicroelectronics					
VTI Technologies					

IntelliOne.com ... Traffic Congestion Maps Without Road Sensors

New technology uses cell phone positioning data to report traffic tangles

August 30, 2006 (PhysOrg.com)

In a snapshot from a single carrier's network in Tampa, Fla., blue dots represent all active mobile phones -- data sources for the IntelliOne system. Credit: IntelliOne Technologies Corporation

Engineers have developed a system for taking anonymous cell-phone location information and turning it into an illuminated traffic map that identifies congestion in real time. The system takes advantage of the steady stream of positioning cues--untraced signals all cell phones produce, whether in use or not, as they seek towers with the strongest signals. It is the first traffic-solution technology that monitors patterns on rural roads and city streets as easily as on highways.

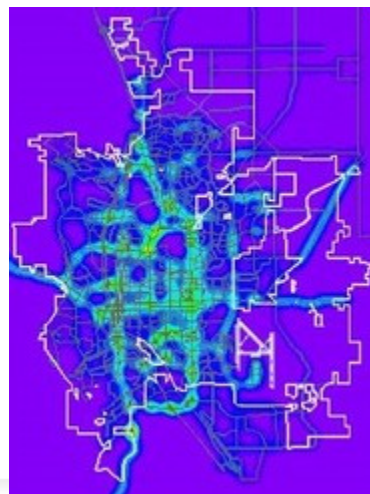
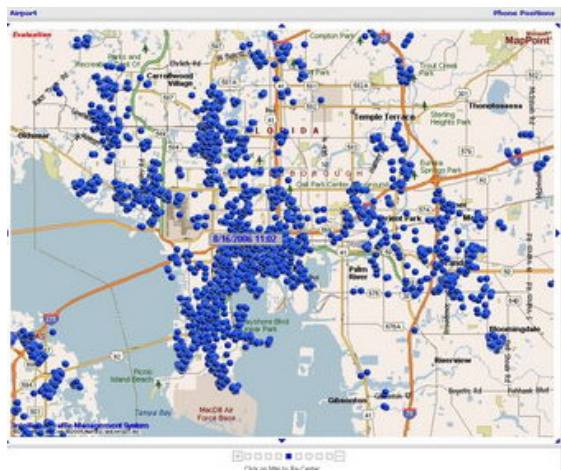

Oct. 22, 2009
Intellione launches free traffic app in Toronto

Quake Catcher Network Seismic Monitoring <http://qcn.stanford.edu/qcnalpha/>

About QCN: Laptop Network

The Seismometer Inside

Many laptops currently have a Sudden Motion Sensors or Active Protection Systems inside them. While these sensors were originally designed to help protect the computer's hard disk in case they are dropped or shaken, seismologists can use them to detect earthquakes. The Quake-Catcher Network (QCN) links participating laptops into a single coordinated network that can detect and analyze earthquakes faster and better than ever before.

The laptop network is the least expensive seismic network in the world. Because volunteers (individuals like you) donate idle CPU time on laptops with these sensors already built in, each additional sensor doesn't cost a thing!

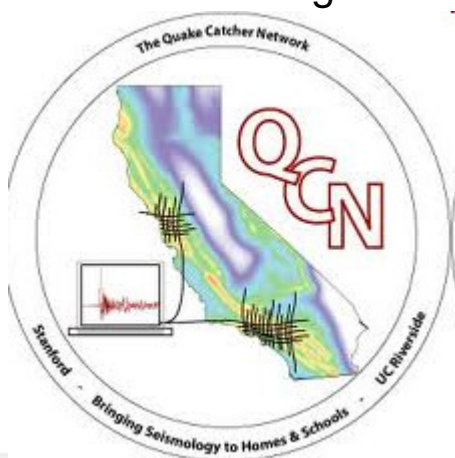
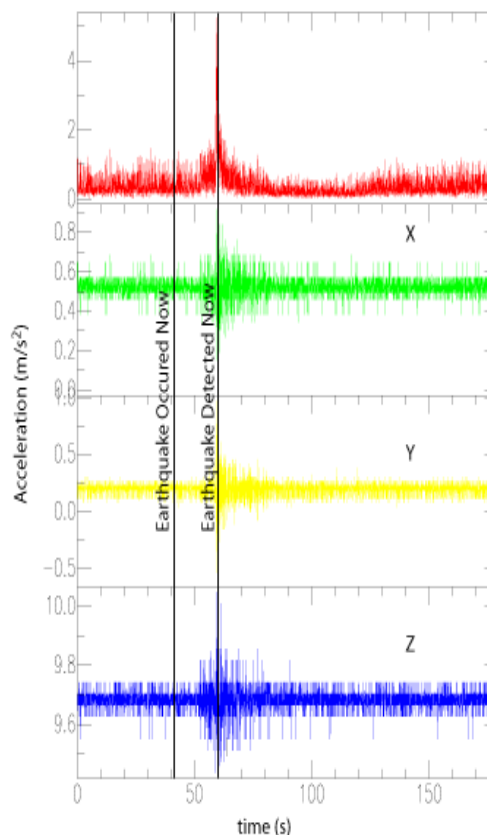

QCN Participant Detects M5.5 Quebec Earthquake Today

June 23, 2010 17:16

A QCN participant has detected the rare magnitude 5.5 earthquake in Quebec, Canada today.

Network Connected Objects

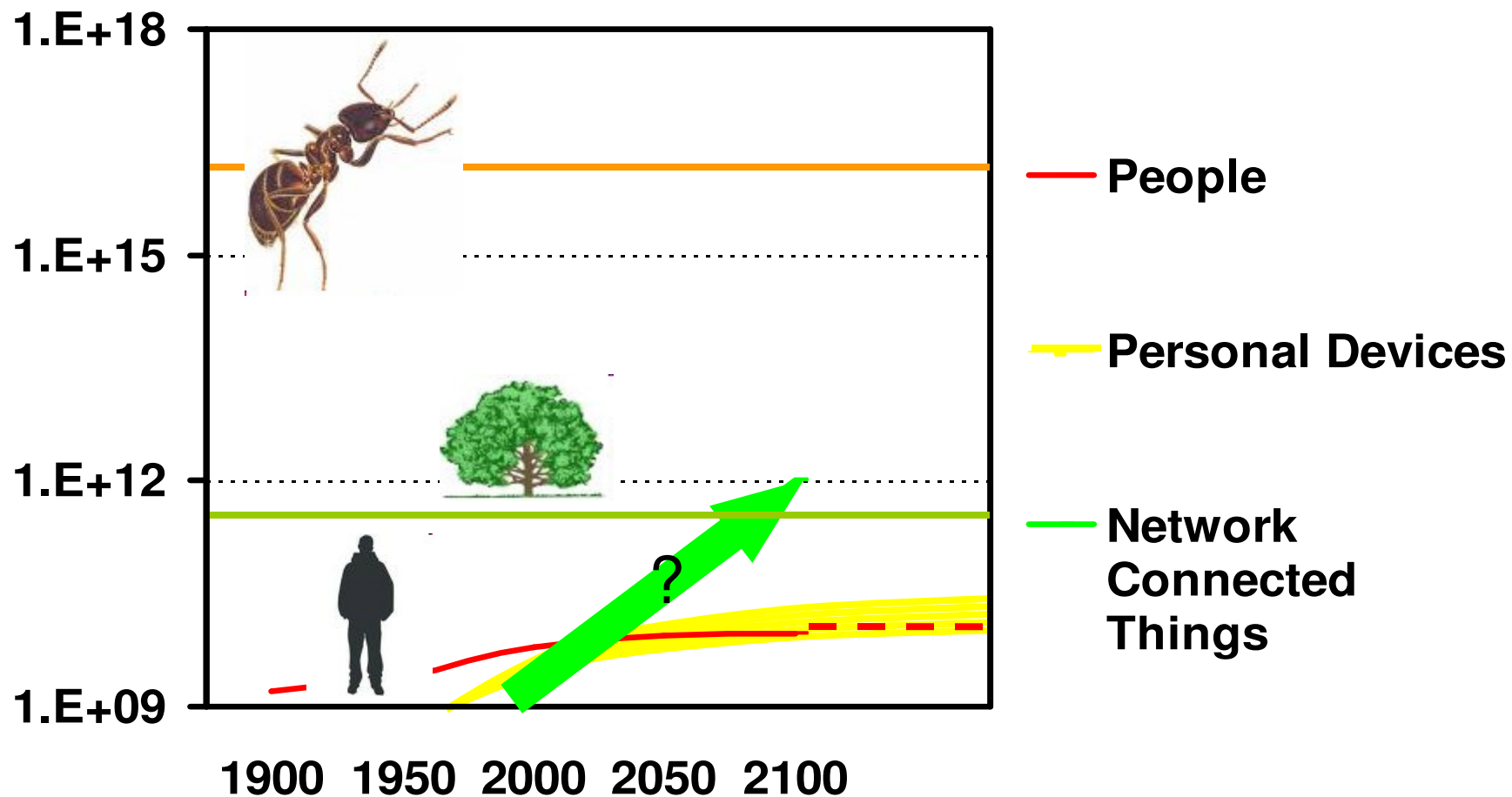

Is a Trillion Connected Objects Reasonable?

- Asymptotically 10 Billion People
 - Trillion = 100 connected objects per person
- About 400 Billion Trees
 - Trillion = 2.5 sensors per tree
- About 1.6 Quadrillion square foot of land on Earth
 - Trillion = 1 object per 1,600 square foot
- About 10 Quadrillion Ants
 - Trillion = 1 sensor per 10,000 ants

<http://www.ictinternational.com.au/talltrees.htm>

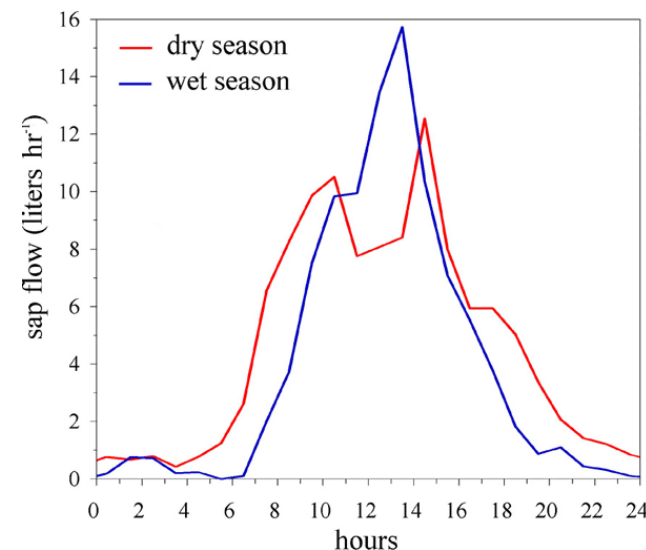
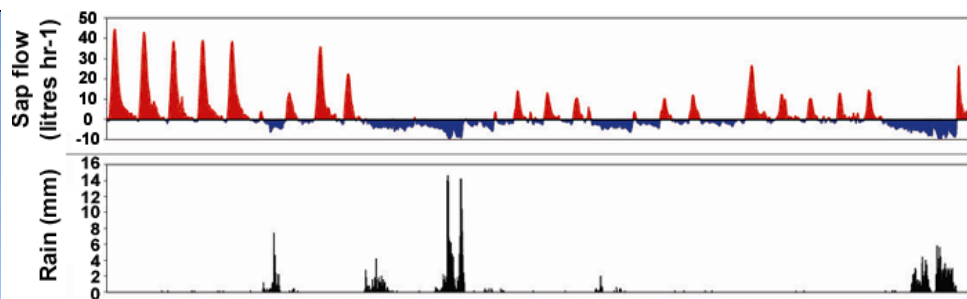
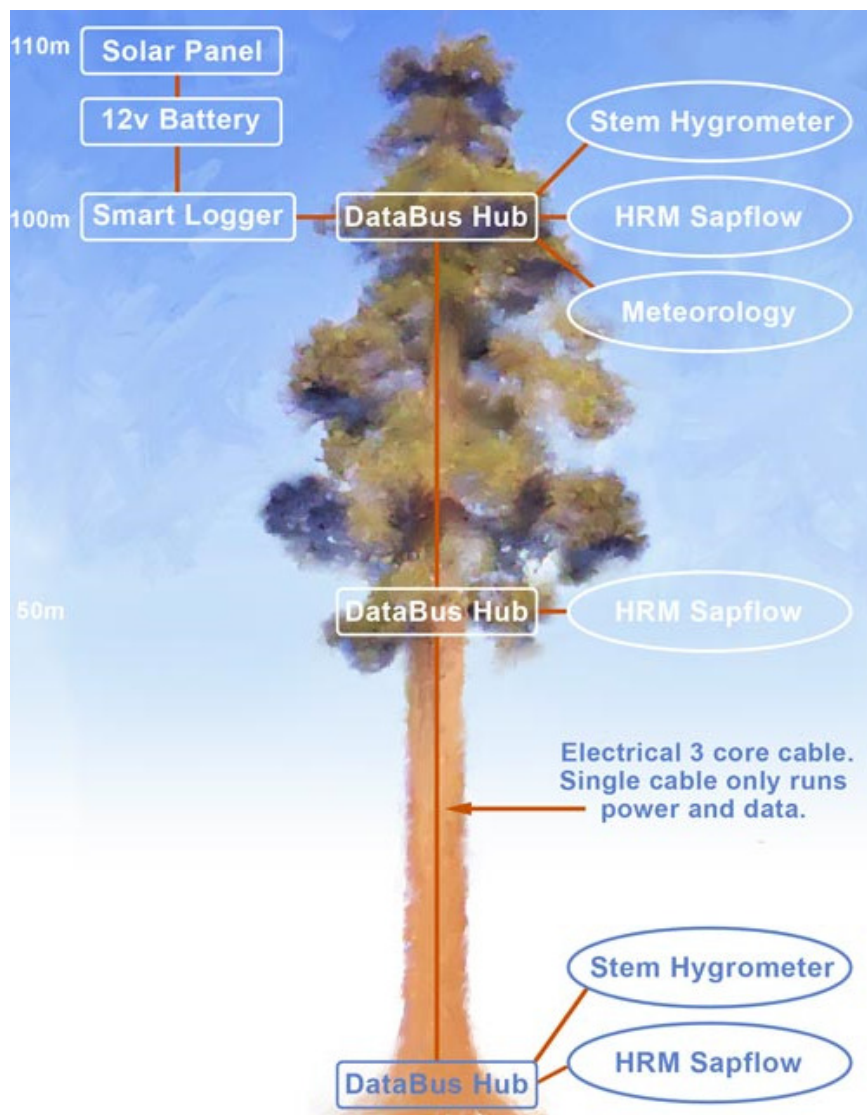

Results

Sapflow from November through February

Up to 1069 liters H₂O transpired per day

Up to 297 liters H₂O absorbed by leaves per day

Conclusions

During periods of rain, a negative sapflow was observed.

Tree Power

<http://www.sciencedaily.com/releases/2008/09/080922095435.htm>

ScienceDaily (**Sep. 23, 2008**) — MIT researchers and colleagues are working to find out whether energy from trees can power a network of sensors to prevent spreading forest fires.

What they learn also could raise the possibility of using trees as silent sentinels along the nation's borders to detect potential threats such as smuggled radioactive materials.

The U.S. Forest Service currently predicts and tracks fires with a variety of tools, including remote automated weather stations. But these stations are expensive and sparsely distributed. Additional sensors could save trees by providing better local climate data to be used in fire prediction models and earlier alerts. However, manually recharging or replacing batteries at often very hard-to-reach locations makes this impractical and costly.

The new sensor system seeks to avoid this problem by tapping into trees as a self-sustaining power supply. Each sensor is equipped with an off-the-shelf battery that can be slowly recharged using electricity generated by the tree. A single tree doesn't generate a lot of power, but over time the "trickle charge" adds up, "just like a dripping faucet can fill a bucket over time," said Shuguang Zhang, one of the researchers on the project and the associate director of MIT's Center for Biomedical Engineering (CBE).

[...]

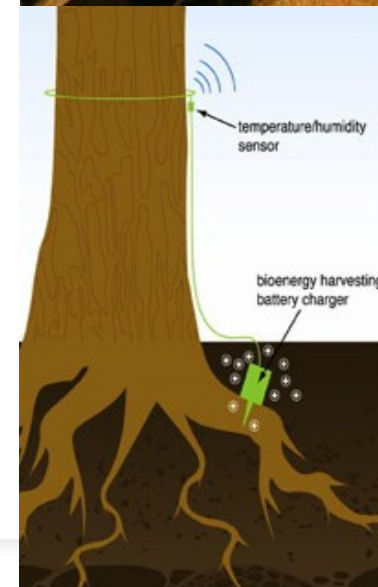

www.voltreepower.com

Bioenergy Harvester

Voltree Power's patented bioenergy harvester converts living plant metabolic energy to useable electricity, providing a unique battery replacement alternative. When coupled with our software and low-power transceiver hardware, this technology makes practical the deployment of large-scale, long-term sensor networks in a variety of previously inaccessible environments, such as under triple-canopy or in hostile terrain. Voltree Power's bioenergy harvester can be used with temperature and humidity sensors as shown below, or with a wide variety of other sensors.

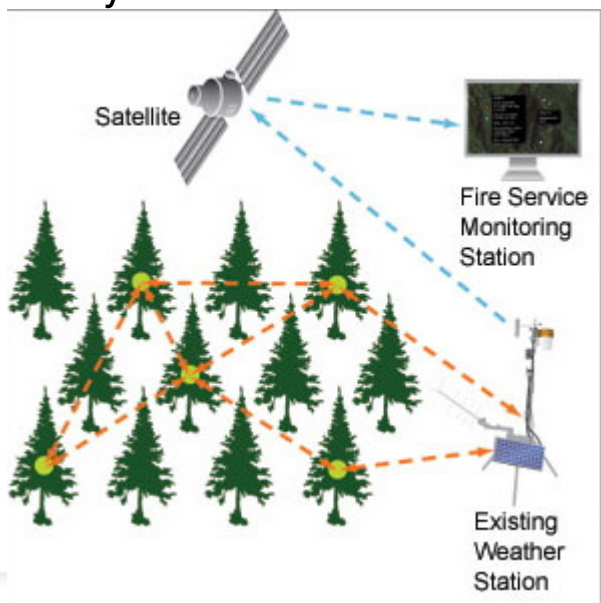
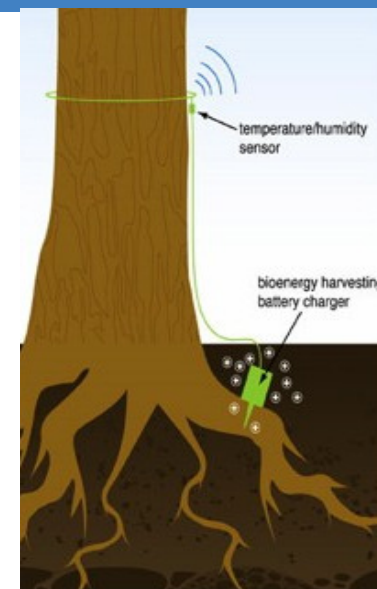

Voltree Power Completes First Installation of the Javelin Rapid Deploy System for US Forest Service
Finalizes Design, Begins Production of Modified Systems For Evaluation this Fire Season
 CANTON, Mass., March 30, 2010



Sawmill Optimization - Background

- Log is scanned via proximity measurement of reflected light and ultrasound
 - Log shape determined
 - Log knots identified

- Optimum cut is determined in realtime with policy

- Resultant data sent to warehouse

- Scan system requires multiple computers to handle log loading, scanning, cut processing, and cutting

- Computers used to do off line analysis of cut policy

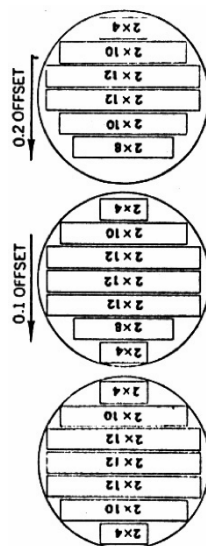
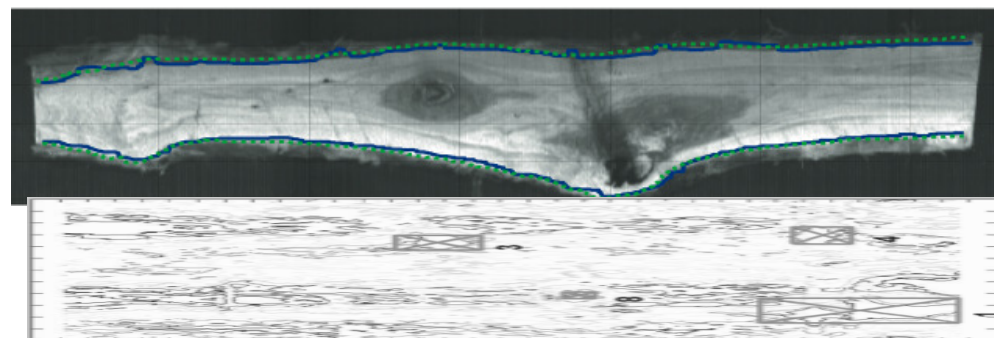
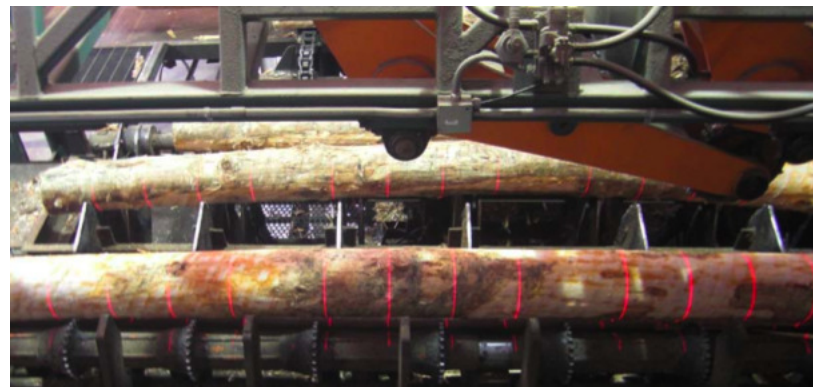

Log #4885
SYP
COMMON
8" - 10"
4" Cant

9.0" x 12.6"
Shift: 2

Log #4885 Left Side 9.0" x 12.6"

Log #4885 Right Side 9.0" x 12.6"

Log Count	Log Size	Volume
10	2x4 x 12	100
10	2x4 x 10	100
10	2x4 x 8	100
10	2x10	100
10	2x12	100
10	2x8	100

Grape Networks



Grape Networks monitors vineyards with miniature wireless sensors embedded directly next to the grape berry. The sensors operate on just two double AA batteries, and transmit data in a wireless mesh to a gateway, where the data is sent to the Internet for reception anywhere in the world. Along with temperature, humidity and solar radiation, alerts for frost and powdery mildew are sent to any Internet enabled PC or mobile phone.

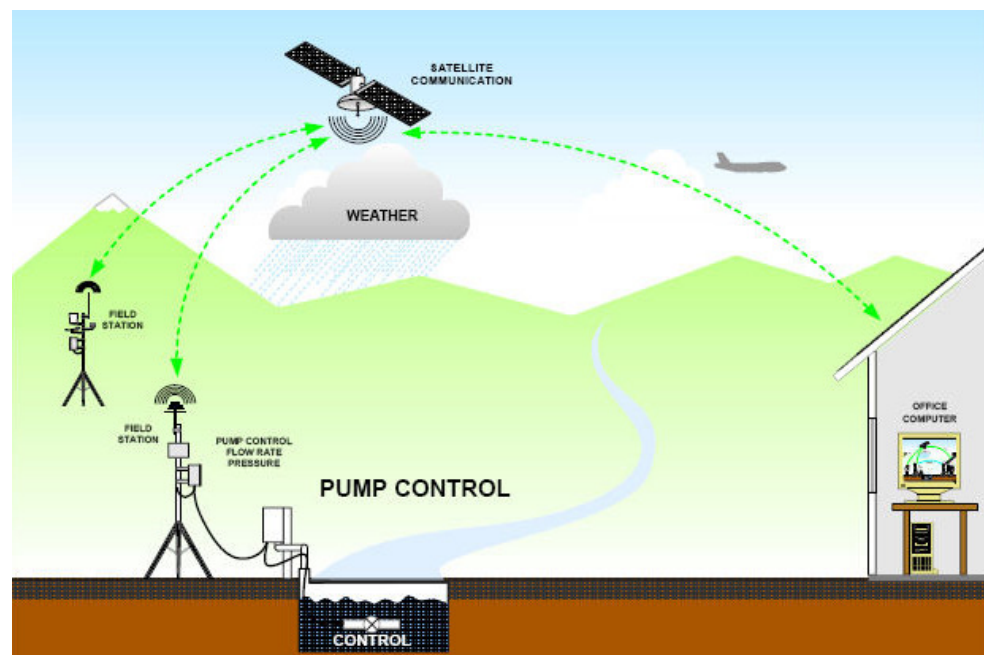

[According to WiFi Planet](#), the network, branded [Climate Genie](#), can include thousands of individual nodes (or motes) that are 10-300 meters apart and cover as much as 100 acres per network.

Individual nodes are programmed to detect humidity, temperature, soil moisture, light, metals and chemicals, among other things. They transmit data back to a gateway that is hooked up to a directional Wi-Fi antenna that broadcasts approximately five miles away to a tower.

The cost varies by terrain. A vineyard in a hilly region, such as Napa, California, may require more motes than one in a flat location, but the base price is \$150/acre with a minimum of 100 acres (or \$15,000) per vineyard. After the first year, partners are charged a subscription fee of \$75/acre to maintain the network.

Just an example ...

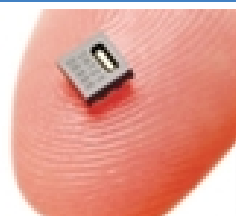

Humidity Sensor Breaks Size Record

Heralded as the world's smallest digital humidity sensor, the SHT21 is encapsulated in a DFN 3-0 package measuring 3 mm x 3 mm x 1.1 mm. The device is fully calibrated and communicates over an I²C digital interface. Power consumption is 3 mW during normal operation. Other features include an accuracy of $\pm 2\%$ RH over 20% to 80% RH and $\pm 0.3^{\circ}\text{C}$ over 25°C to 42°C plus compliance with automotive standard AEC-Q100. Additionally, the SHT21 is reflow solderable, allegedly without any degradation of sensor performance. SENSIRION INC., Westlake Village, CA. (805) 409-4900.

MORE INFO: <http://www.sensirion.com/mysht21>

Mississippi Watershed



IJKDIJK (www.ijkdijk.eu)

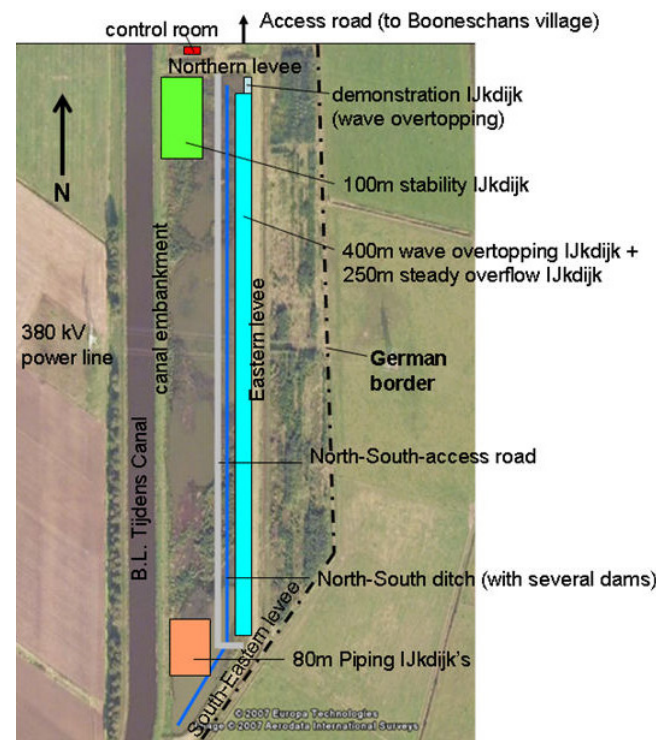

June 5, 2009

Test levee breach measurable as much as 42 hours in advance [...]

The most important conclusion of this experiment is that the sensors made it possible to predict the IJKdijk breach well in advance.

www.ijkdijk.eu



Beginning in 2010 TenCate Geosynthetics, one of the participating parties in the IJkdijk, will be concentrating on the market launch and sales of TenCate GeoDetect in North America. This monitoring system, based on geotextiles equipped with optical fibers, has already been used in Europe for a few years and was tested earlier in the IJkdijk.

The launch in North America will enable the company's global marketing efforts in the field of geotechnology to be coordinated and the continued development of the system to be intensified.

TenCate GeoDetect is the world's first intelligent geotextile. This is a system that provides early warning of deformations in soil structures. TenCate GeoDetect consists of a geotextile that incorporates optical glass fibres, as well as special instrumentation equipment and software. The slightest settlements and changes in temperature and strain in for example embankments and dykes can thus be registered at an early stage. This makes it possible to take any necessary measures and to avoid breaches. The system is built into dyke bodies during the construction of seawalls, roads and railways and the building of retaining walls, tunnels, underground structures and pipelines.

[...]

In Europe the required experience has already been gained with TenCate GeoDetect in pilot projects, including one in France for the construction of the embankment for the rails of SNCF's (French Railways) high-speed line. In The Netherlands this early warning system was used in the IJkdijk project.

LiveDijk (www.ijkdijk.eu) Oct. 10, 2009



LiveDijk: First true sea dike full of sensors in Eemshaven

The world's first true sea dike equipped with sensors is being built at Eemshaven.

This 'LiveDijk' is equipped with measurement equipment that makes it possible to remotely monitor a dike's condition on a continuous basis. This principle was previously tested under the name 'IJKdijk' in East Groningen, and has now been developed to the point that the sensors can be placed in a section of the sea dike.

A test dike was built last year and tested in a small polder to the south of Bellingwedde in East Groningen. The sensors are now being placed in an existing dike of 600 meters at Eemshaven. This dike does not form part of the direct sea barrier of the Province of Groningen, but is still in contact with the sea. That implies that there is no risk whatsoever, whilst still creating a realistic test opportunity. Water Board Noorderzijlvest has made the dike available for the test.

The IJKdijk is a test setup for new inspection and monitoring technologies for water barriers. The IJKdijk is used to look into whether these technologies can be used to improve the inspection of dikes in order to gain a clearer understanding of how they behave. The ultimate aim is to constantly monitor the strength of dikes so that a faster response is possible should that prove necessary. A lot of interest in the 'dike of the future' has been expressed from other parts of the world, including New Orleans.

The IJKdijk is an initiative of organisations including the Investment and Development Company for the North Netherlands (NOM), Deltares, the organisation of water boards STOA and TNO.

New Applications in the Small (IBM “DNA Transistor”)

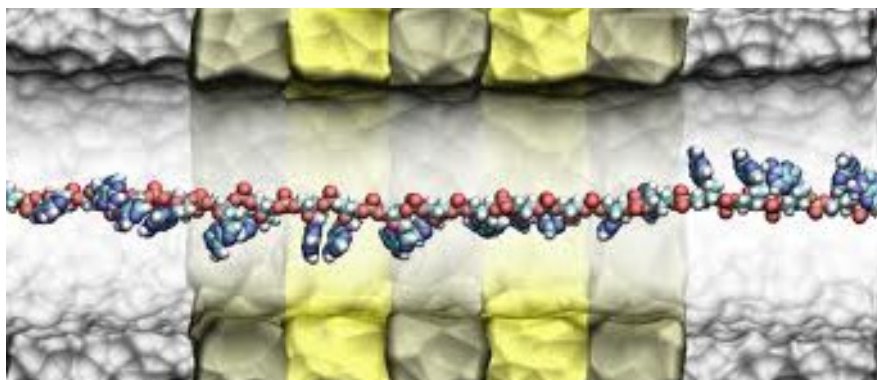
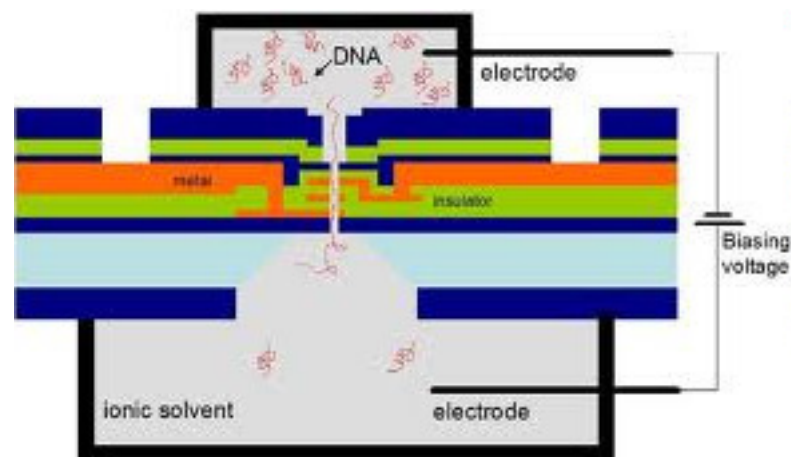

New Analytic Capabilities: IBM Watson

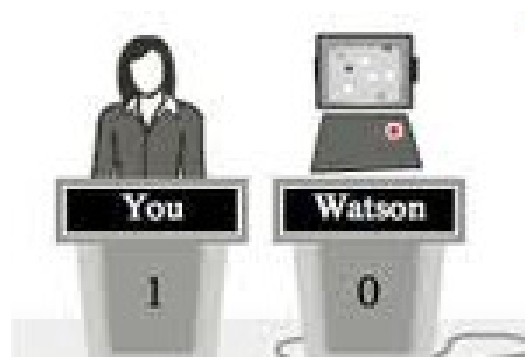

Conclusions

- We truly are instrumenting our planet on an unprecedented scale
- Lots and lots and lots of data, accessible from anywhere
- Sensors and data can be used in many ways (beyond original intent)
- An almost infinite number of opportunities to use and combine this data and optimize

The World is Changing and Becoming More...



Our world is becoming
INSTRUMENTED



Our world is becoming
INTERCONNECTED



All things becoming
INTELLIGENT

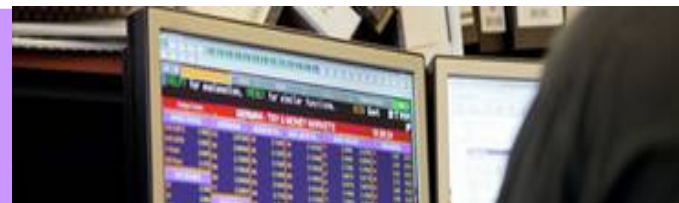

**The resulting explosion of information creates a need for
a new kind of intelligence**

...to help build a Smarter Planet