

Solar Electric

Reliable and Pollution-Free Electricity

Roger Manzolini

Power Systems Engineer at General Dynamics

Cara Humphrey

Solar Consultant at Astrum Solar

Outline

- Concept
- Plan
- Design
- Installation
 - Picture tour
- Rough estimates
- Risk
- How to proceed

Concept

- Provide your electrical needs by way of a solar power generation plant comprised of
 - Solar panels
 - Inverters
 - Distribution system
 - Monitoring system
- You can own or lease the plant
- The plant can be roof or ground mounted
- You receive on-going financial benefits:
 - ~\$0.15 per kW hour for electricity you produce and use
 - ~\$0.15 per kW hour for electricity NET sent to the electric company
 - your surplus production
 - ~\$0.20 per kW hour from the “market” for energy production via credits for SRECs

What is an SREC?

- SREC stands for Solar Renewable Energy Certificate
- An SREC is a tradable certificate that represents all the clean energy benefits of electricity generated from your solar electric system
- SREC's are issued to you regularly as your solar panels generate each 1000 kiloWatt hours
- A 5 kW system will generate almost 6 SREC Credits each year

Plan

- We wanted a system to exceed our use
 - Our use is modest and we can allocate surplus to another account
- Desired a ground mount system
 - Ease of maintenance (thought I'd own it)
 - Had plenty of room in the field
 - Just didn't want it on our roof
 - Could 'sweep' off snow if needed

Plan

Power Flow / Use



Power used = Power from Array + Power from WMECO – Power to WMECO

Notes:

1. WMECO charges for the “NET” power sent to the house (power from WMECO minus Power to WMECO)
2. Power to and power from WMECO is the same rate (~\$0.15/kWhr)
3. WMECO does not have visibility into what the house “uses”
4. Array production is metered and compensated for via SRECs (~\$0.23/kWhr)

Plan

Average Daily Power Flow / Use

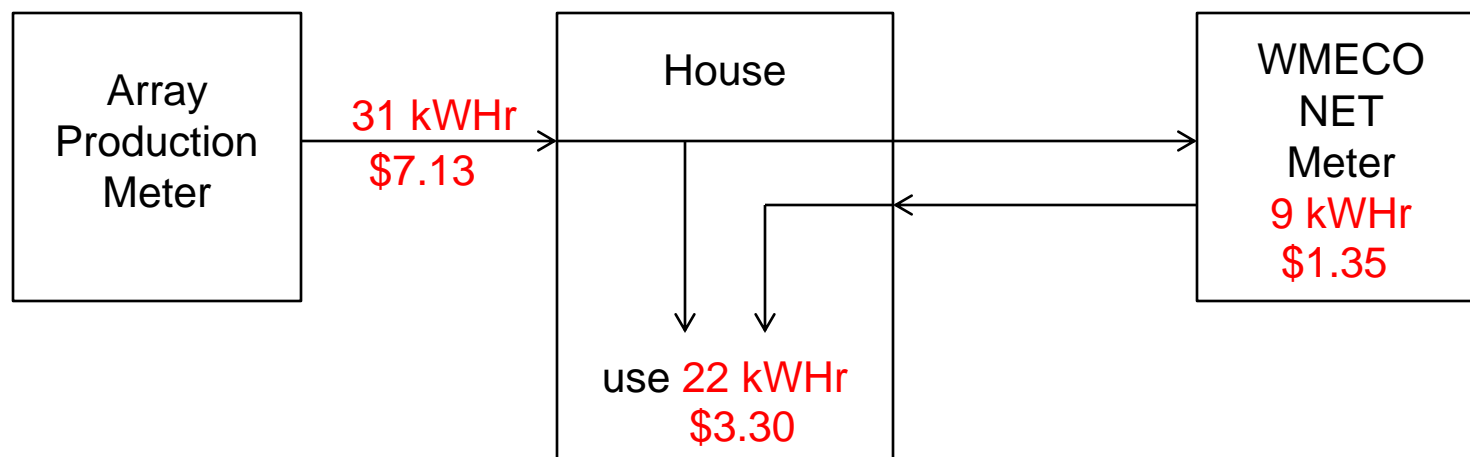

Note:

Our system was designed to produce 141% of our historical use of 22 kWhrs per day (669 monthly):

31 kWhrs per day (943 monthly)

Astrum Solar guaranteed:

29.5 kWhrs per day (897 monthly)

That should result in a savings of \$11.78/day (\$353/month)

Plan

Monthly kW Hours

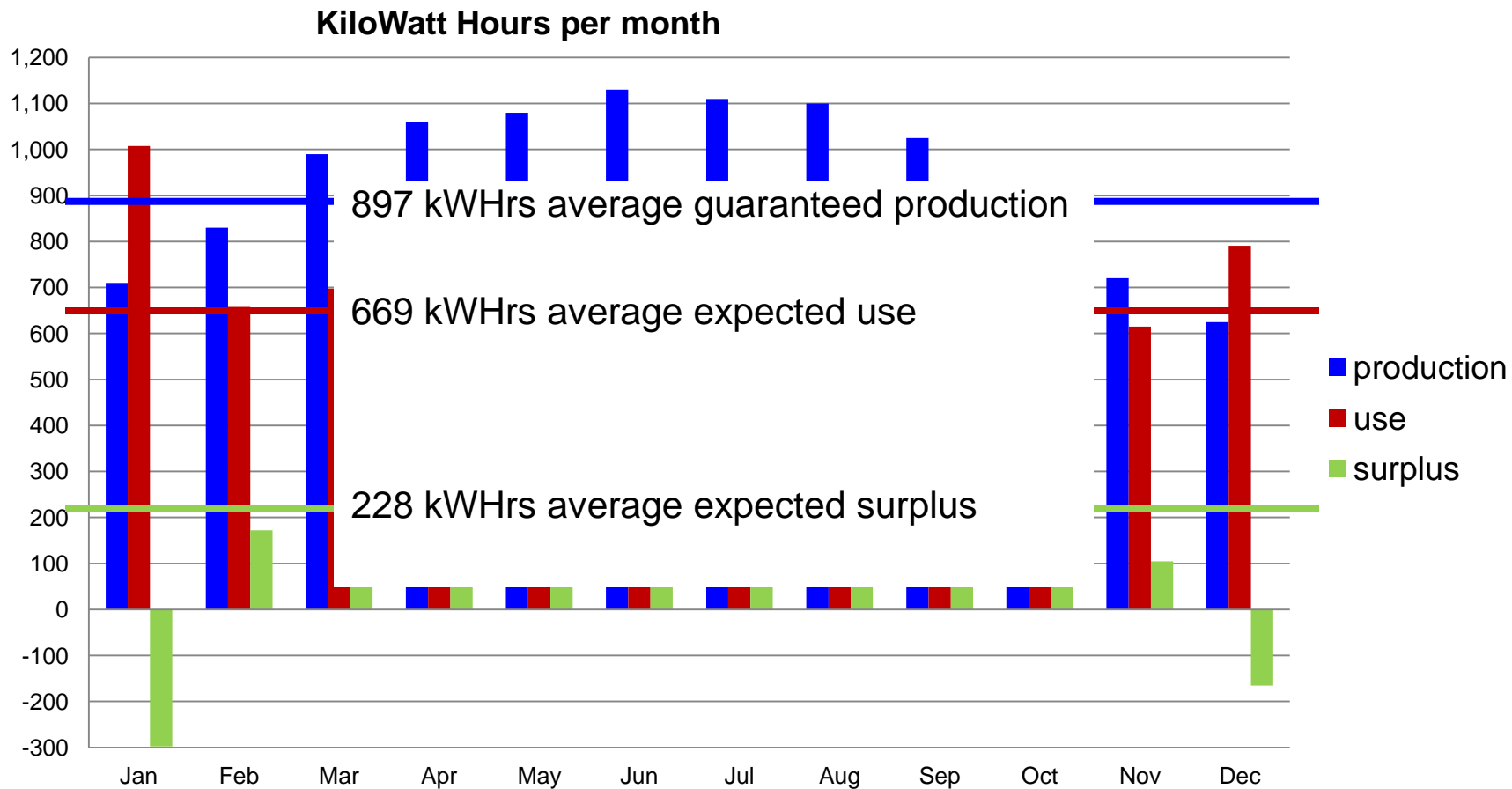



ASTRUMSOLAR®

OUR WORRY-FREE SOLAR PRODUCTION GUARANTEE



Year	Guaranteed Annual Output (kWh)	Guaranteed Cumulative System Output (kWh)*
1	10,752	10,752
2	10,699	21,451
3	10,645	32,096
4	10,592	42,688
5	10,539	53,227
6	10,486	63,714
7	10,434	74,148
8	10,382	84,529
9	10,330	94,859
10	10,278	105,137
11	10,227	115,364
12	10,176	125,540
13	10,125	135,665
14	10,074	145,739
15	10,024	155,763
16	9,974	165,736
17	9,924	175,660
18	9,874	185,534
19	9,825	195,359
20	9,776	205,135

* Our Production Guarantee for the home solar ownership option is 95% of your estimated system production, with a 0.5% per year degradation rate, for 10 years.

Design

Before:

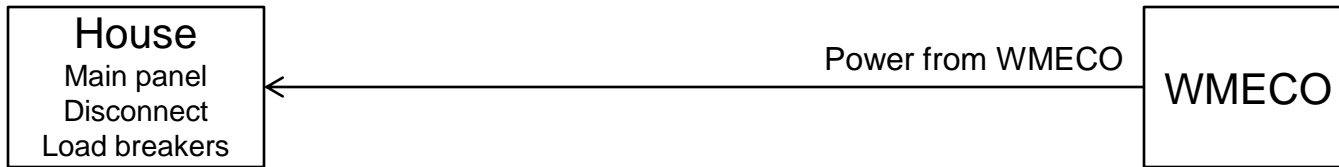

After:

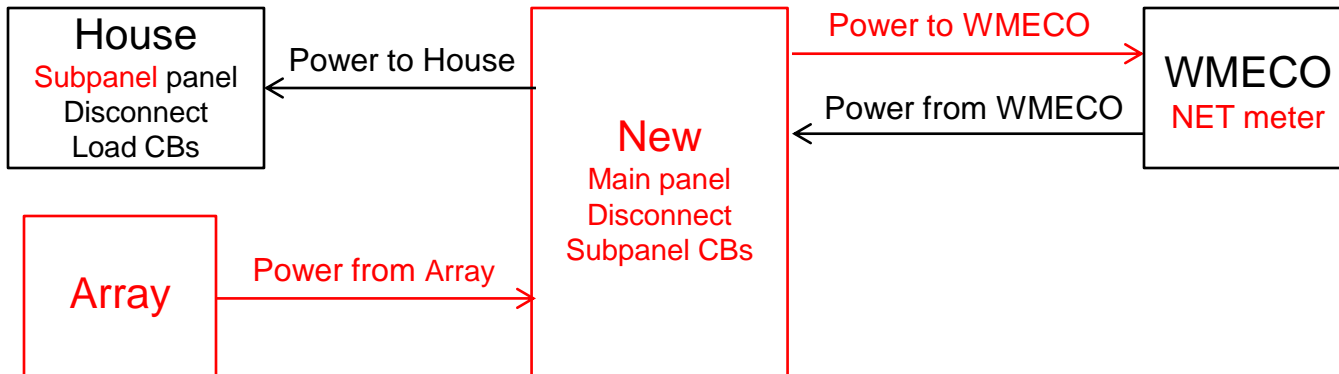

Design

- Solar panels function
 - Convert the sun's radiant energy to
 - 30 Volts direct current electrical power

Solar Panel(s) (40)

Sunmodule SW 240

- Maximum power 240 Watts
- Max operating voltage 30.6 Volts
- Max operating current 7.87 Amps
- Open circuit voltage 37.6 Volts
- Short circuit current 8.22 Amps
- Operating temperature -40°C to 85°C

- Cells per module (panel) (10x6) 60
- Cell type Mono crystalline
- Cell dimensions 6.14 in x 6.14 in

- Front Tempered glass EN 12150
- Frame Black anodized aluminum
- Size 37.44 in x 65.94 in 1.22 in
- Weight 46.7 lbs.
- Warranty 25-year
- Performance degradation 0.7% p.a.



Design

- Inverters function
 - Convert 30 Volts direct current energy to
 - 240 Volts, single phase, 60 cycle alternate current power
 - Synchronize themselves to the power grid (WMECO)
 - Provide open circuit output when grid goes down (power is lost)
 - Required by WMECO in order to get approval to connect to their grid

The solar array is not a backup system

Inverter(s) (40)

Microinverter M215

- Input power 190-270W
- Max input voltage 45V
- Peak power tracking voltage 22-36V
- Operating range 21-36V
- Min / Max start voltage 22V / 45V
- Max DC Short circuit current 15A
- Max input current 10.5A
- Max output power 215W
- Nominal output current 0.9A
- Nominal voltage / range 240V / 206-269V
- Nominal frequency / range 60.0 / 59.3-60.5 Hz
- Max units per 20A circuit 17
- Efficiency 96%
- Off power consumption 46mW
- Operating temperature -40°C to 85°C
- Size (WxHxD) 6.8" x 6.45" x 1.0"
- Weight 3.5 lbs.
- Warranty 25-year



Design

- **Distribution system function**
 - connects / disconnects
 - solar system to
 - electric company (WMECO) power grid
 - electric meter changed to a “NET-meter”
- **Distribution system components**
 - PV junction box - mounted on the Array(4)
 - PV meter - mounted outside on the garage near the array(6)
 - PV disconnect - mounted outside on the garage near the array(7)
 - PV Load Center - Subpanel mounted inside the garage(5)
 - AC Disconnect - Main panel mounted inside the house(9)
 - Net meter - mounted outside on the house

Design – satellite view



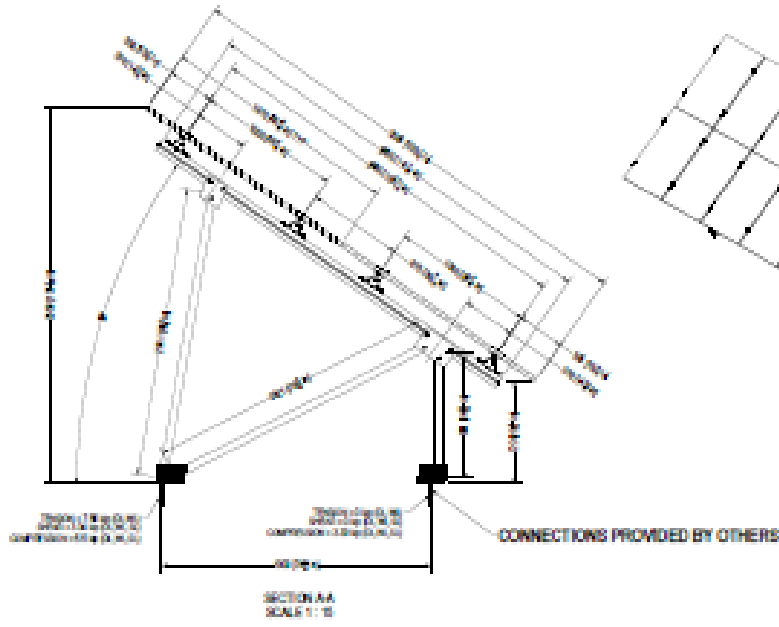
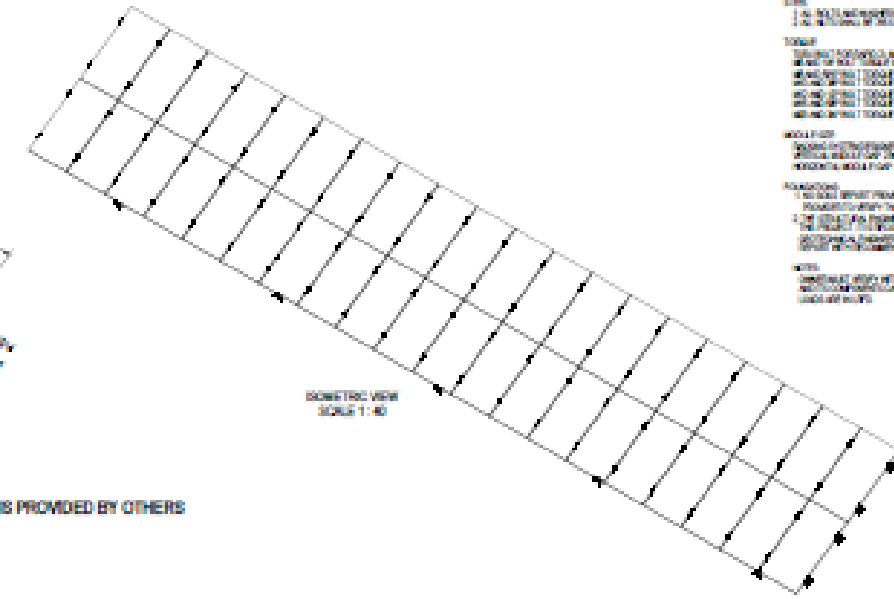
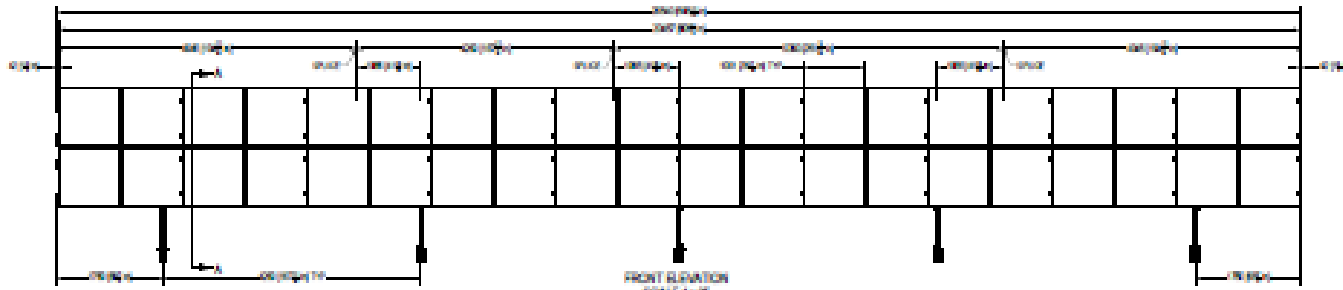

NOTES:
 1. ALL DIMENSIONS UNLESS OTHERWISE SPECIFIED ARE IN METERS.
 2. ALL DIMENSIONS UNLESS OTHERWISE SPECIFIED ARE IN METERS.
 3. ALL DIMENSIONS UNLESS OTHERWISE SPECIFIED ARE IN METERS.
 4. ALL DIMENSIONS UNLESS OTHERWISE SPECIFIED ARE IN METERS.
 5. ALL DIMENSIONS UNLESS OTHERWISE SPECIFIED ARE IN METERS.
 6. ALL DIMENSIONS UNLESS OTHERWISE SPECIFIED ARE IN METERS.
 7. ALL DIMENSIONS UNLESS OTHERWISE SPECIFIED ARE IN METERS.
 8. ALL DIMENSIONS UNLESS OTHERWISE SPECIFIED ARE IN METERS.
 9. ALL DIMENSIONS UNLESS OTHERWISE SPECIFIED ARE IN METERS.
 10. ALL DIMENSIONS UNLESS OTHERWISE SPECIFIED ARE IN METERS.

NO.	DATE	REVISION	BY	CHKD.	APPV.
1					
2					
3					
4					
5					
6					
7					
8					
9					
10					

Client:
 Astrum Solar
 15 Avenue E
 Hopkinton, MA 01748



Project: 24 x 20 30'
 Parking Structure
 Dimensions and Specifications
 DATE: 08/20/2024

Project Site:
 Marcolini
 728-Canaan Rd
 Robinson, MA 01224

Drawing Number:
v7544.01

PRELIMINARY
 UNLESS THIS DRAWING IS SIGNED AND SEALED BY A LICENSED STRUCTURAL ENGINEER, IT IS A PRELIMINARY DESIGN AND SHALL NOT BE USED FOR CONSTRUCTION.

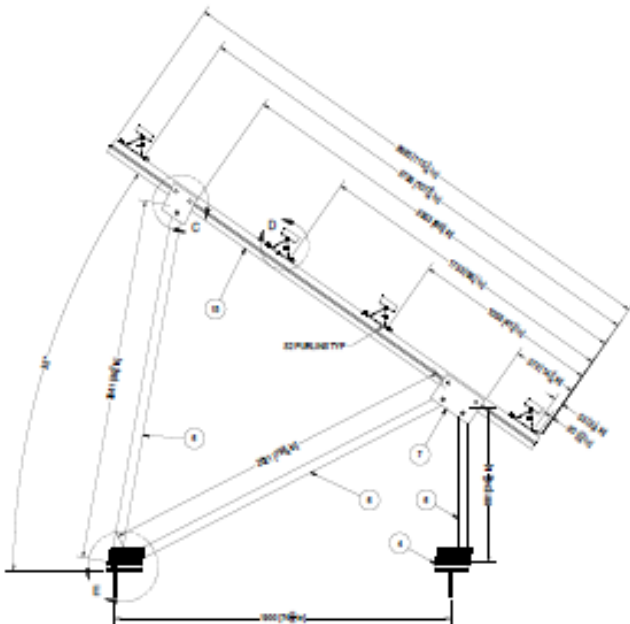

SUPPORT STRUCTURE
SCALE 1 : 12

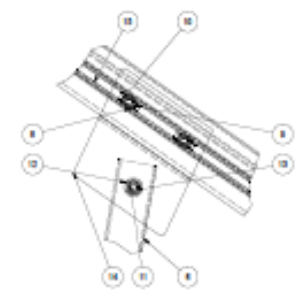

DETAIL C
SCALE 1 : 3

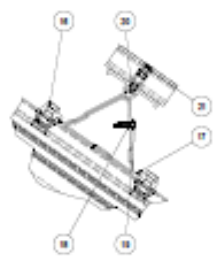

DETAIL D
SCALE 1 : 3

ITEM NO.	PART NUMBER	DESCRIPTION
1	12500-00	New Use PMA20
2	1400-130	Steel Hex Head M 20 x 100mm DIN 913 10.9
3	1500-010	SA Flange Vertical M 20 x 100mm 10.9
4	17000-011	Steel Plate 10mm Thick 100 x 100mm
5	17000-011	Steel Plate 10mm Thick 100 x 100mm
6	17000-011	Steel Plate 10mm Thick 100 x 100mm
7	17000-011	Steel Plate 10mm Thick 100 x 100mm
8	17000-011	Steel Plate 10mm Thick 100 x 100mm
9	17000-011	Steel Plate 10mm Thick 100 x 100mm
10	17000-011	Steel Plate 10mm Thick 100 x 100mm
11	17000-011	Steel Plate 10mm Thick 100 x 100mm
12	17000-011	Steel Plate 10mm Thick 100 x 100mm
13	17000-011	Steel Plate 10mm Thick 100 x 100mm
14	17000-011	Steel Plate 10mm Thick 100 x 100mm
15	17000-011	Steel Plate 10mm Thick 100 x 100mm
16	17000-011	Steel Plate 10mm Thick 100 x 100mm
17	17000-011	Steel Plate 10mm Thick 100 x 100mm
18	17000-011	Steel Plate 10mm Thick 100 x 100mm
19	17000-011	Steel Plate 10mm Thick 100 x 100mm
20	17000-011	Steel Plate 10mm Thick 100 x 100mm
21	17000-011	Steel Plate 10mm Thick 100 x 100mm
22	17000-011	Steel Plate 10mm Thick 100 x 100mm
23	17000-011	Steel Plate 10mm Thick 100 x 100mm
24	17000-011	Steel Plate 10mm Thick 100 x 100mm
25	17000-011	Steel Plate 10mm Thick 100 x 100mm
26	17000-011	Steel Plate 10mm Thick 100 x 100mm
27	17000-011	Steel Plate 10mm Thick 100 x 100mm
28	17000-011	Steel Plate 10mm Thick 100 x 100mm
29	17000-011	Steel Plate 10mm Thick 100 x 100mm
30	17000-011	Steel Plate 10mm Thick 100 x 100mm
31	17000-011	Steel Plate 10mm Thick 100 x 100mm
32	17000-011	Steel Plate 10mm Thick 100 x 100mm
33	17000-011	Steel Plate 10mm Thick 100 x 100mm
34	17000-011	Steel Plate 10mm Thick 100 x 100mm
35	17000-011	Steel Plate 10mm Thick 100 x 100mm
36	17000-011	Steel Plate 10mm Thick 100 x 100mm
37	17000-011	Steel Plate 10mm Thick 100 x 100mm
38	17000-011	Steel Plate 10mm Thick 100 x 100mm
39	17000-011	Steel Plate 10mm Thick 100 x 100mm
40	17000-011	Steel Plate 10mm Thick 100 x 100mm
41	17000-011	Steel Plate 10mm Thick 100 x 100mm
42	17000-011	Steel Plate 10mm Thick 100 x 100mm
43	17000-011	Steel Plate 10mm Thick 100 x 100mm
44	17000-011	Steel Plate 10mm Thick 100 x 100mm
45	17000-011	Steel Plate 10mm Thick 100 x 100mm
46	17000-011	Steel Plate 10mm Thick 100 x 100mm
47	17000-011	Steel Plate 10mm Thick 100 x 100mm
48	17000-011	Steel Plate 10mm Thick 100 x 100mm
49	17000-011	Steel Plate 10mm Thick 100 x 100mm
50	17000-011	Steel Plate 10mm Thick 100 x 100mm

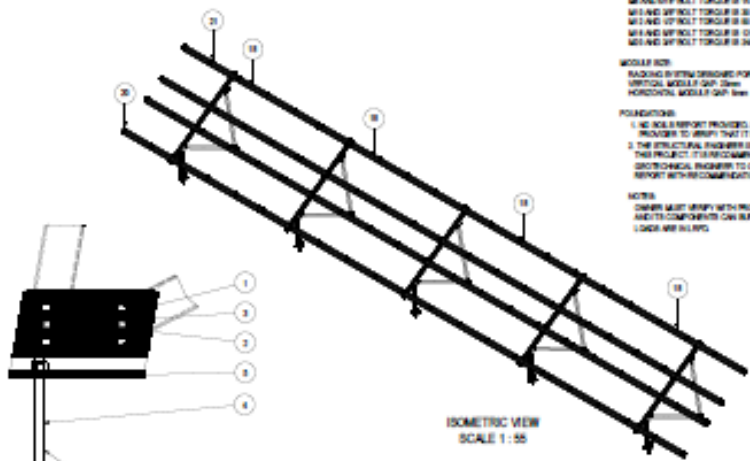

ISOMETRIC VIEW
SCALE 1 : 55

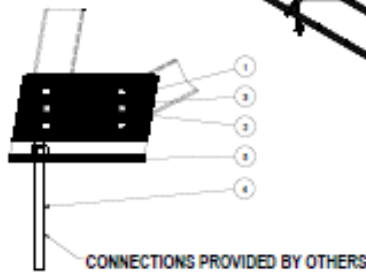

DETAIL E
SCALE 1 : 3

CONNECTIONS PROVIDED BY OTHERS

GENERAL NOTES:
THIS DRAWING IS THE PROPERTY OF THE ENGINEER. IT IS THE RESPONSIBILITY OF THE ENGINEER TO VERIFY THE LOADS AND CONDITIONS OF THE STRUCTURE. THE CONTRACTOR SHALL BE RESPONSIBLE FOR THE DESIGN AND CONSTRUCTION OF THE STRUCTURE. THE ENGINEER SHALL NOT BE RESPONSIBLE FOR ANY STRUCTURAL DEFICIENCIES OF THE STRUCTURE. THE CONTRACTOR SHALL BE RESPONSIBLE FOR THE DESIGN AND CONSTRUCTION OF THE STRUCTURE. THE ENGINEER SHALL NOT BE RESPONSIBLE FOR ANY STRUCTURAL DEFICIENCIES OF THE STRUCTURE.

LOADS:
WIND LOAD = 15.0 PSF
DEAD LOAD = 10.0 PSF
LIVE LOAD = 10.0 PSF
SEISMIC LOAD = 0.1g

WIND DESIGN:
WIND SPEED = 100 MPH
WIND DIRECTION = 0°

INSTALLATION TOLERANCES:
WIND UPLIFT TOLERANCE = ±1/8"
WIND BRACKET PLACEMENT TOLERANCE = ±1/8"
WIND BRACKET HEIGHT TOLERANCE = ±1/8"
WIND BRACKET SPACING TOLERANCE = ±1/8"

GENERAL:
1. THE STRUCTURAL CONSTRUCTION DOCUMENTS REPRESENT THE DESIGNED STRUCTURE. THE CONTRACTOR SHALL BE RESPONSIBLE FOR THE DESIGN AND CONSTRUCTION OF THE STRUCTURE. THE ENGINEER SHALL NOT BE RESPONSIBLE FOR ANY STRUCTURAL DEFICIENCIES OF THE STRUCTURE. THE CONTRACTOR SHALL BE RESPONSIBLE FOR THE DESIGN AND CONSTRUCTION OF THE STRUCTURE. THE ENGINEER SHALL NOT BE RESPONSIBLE FOR ANY STRUCTURAL DEFICIENCIES OF THE STRUCTURE.

ALUMINUM:
1. ALL ALUMINUM SHALL COMPLY WITH THE LATEST ALUMINUM DESIGN HANDBOOK.
2. ALL ALUMINUM SHALL BE 6061-T6.

STEEL:
1. ALL STEEL SHALL BE A36 STEEL.
2. ALL STEEL SHALL BE 1/4" THICK UNLESS OTHERWISE SPECIFIED.

TORQUE:
TORQUE SHALL BE AS FOLLOWS:
WIND BRACKET BOLTS: 100 FT-LBS
WIND BRACKET NUTS: 100 FT-LBS
WIND BRACKET WASHERS: 100 FT-LBS
WIND BRACKET PLATES: 100 FT-LBS
WIND BRACKET ANCHORS: 100 FT-LBS

WIND BRACKET:
WIND BRACKET SHALL BE 1/4" x 100mm x 100mm
WIND BRACKET SHALL BE 1/4" THICK
WIND BRACKET SHALL BE 100mm SPACING

FOUNDATIONS:
1. THE CONTRACTOR SHALL BE RESPONSIBLE FOR THE DESIGN AND CONSTRUCTION OF THE FOUNDATIONS. THE ENGINEER SHALL NOT BE RESPONSIBLE FOR ANY FOUNDATIONAL DEFICIENCIES OF THE STRUCTURE. THE CONTRACTOR SHALL BE RESPONSIBLE FOR THE DESIGN AND CONSTRUCTION OF THE FOUNDATIONS. THE ENGINEER SHALL NOT BE RESPONSIBLE FOR ANY FOUNDATIONAL DEFICIENCIES OF THE STRUCTURE.

NOTES:
OWNER SHALL VERIFY WITH PROFESSIONAL ENGINEER THAT THE DESIGNER'S DESIGN IS IN ACCORDANCE WITH ALL APPLICABLE CODES AND REGULATIONS. THE CONTRACTOR SHALL BE RESPONSIBLE FOR THE DESIGN AND CONSTRUCTION OF THE STRUCTURE. THE ENGINEER SHALL NOT BE RESPONSIBLE FOR ANY STRUCTURAL DEFICIENCIES OF THE STRUCTURE.

NO.	DATE	DESIGNED	CHECKED	APPROVED	REVISIONS
1	08/15/2024	J. J. J.	J. J. J.	J. J. J.	Initial Design
2	08/20/2024	J. J. J.	J. J. J.	J. J. J.	Revised Design
3	08/25/2024	J. J. J.	J. J. J.	J. J. J.	Final Design

APPROVED

Client:
Asburn Solar
15 Avenue E
Hopkinton, MA 01748



PV/M3 2V x 20 35"
Racking Structure
Details and Part List

Project Site:
Menzolini
725 Cereen Rd
Richmond, MA 01254

Drawing Number:
v7544.01

PRELIMINARY
UNLESS THIS DRAWING IS SIGNED AND SEALED BY A LICENSED STRUCTURAL ENGINEER, IT IS A PRELIMINARY DESIGN AND SHALL NOT BE USED FOR CONSTRUCTION.

Equipment Schedule

TAG	Description	Part Number	Quantity	Notes
1	PV String	N/A	3	One of 3 strings is shown; Additional strings follow same wiring to PV Load Center
2	Solar PV Module	SW 240 Poly	40	Total of 40 modules in system which are split into 3 strings. Max of 17 per string.
3	DC/AC Inverter	M215-60-2LL-S22	40	Micro-inverters are mounted under solar panels
4	Junction Box	Carlton 6 x 6 x 4 PVC	1	Junction box groups multiple strings. One is typical per continuous roof surface.
5	PV Load Center	45 Amp Subpanel	1	MLO -Solar PV load center, (1) 2-pole circuit breaker per circuit
6	PV Production Meter	Revenue Grade Meter	1	Included when applicable
7	PV Disconnect	Cuttler Hammer, C-H DG222NRB	1	Visible Break Disconnect; Minimum of 60 Amps and sized according to system output
8	Existing CB Panel	200 Amp	N/A	System will interconnected using a Load Side Tap connection in the Waterproof J-Box.
9	Utility Disconnect			Visible Break Disconnect; 200 Amps, Fused

Electrical Diagram for Manzolini

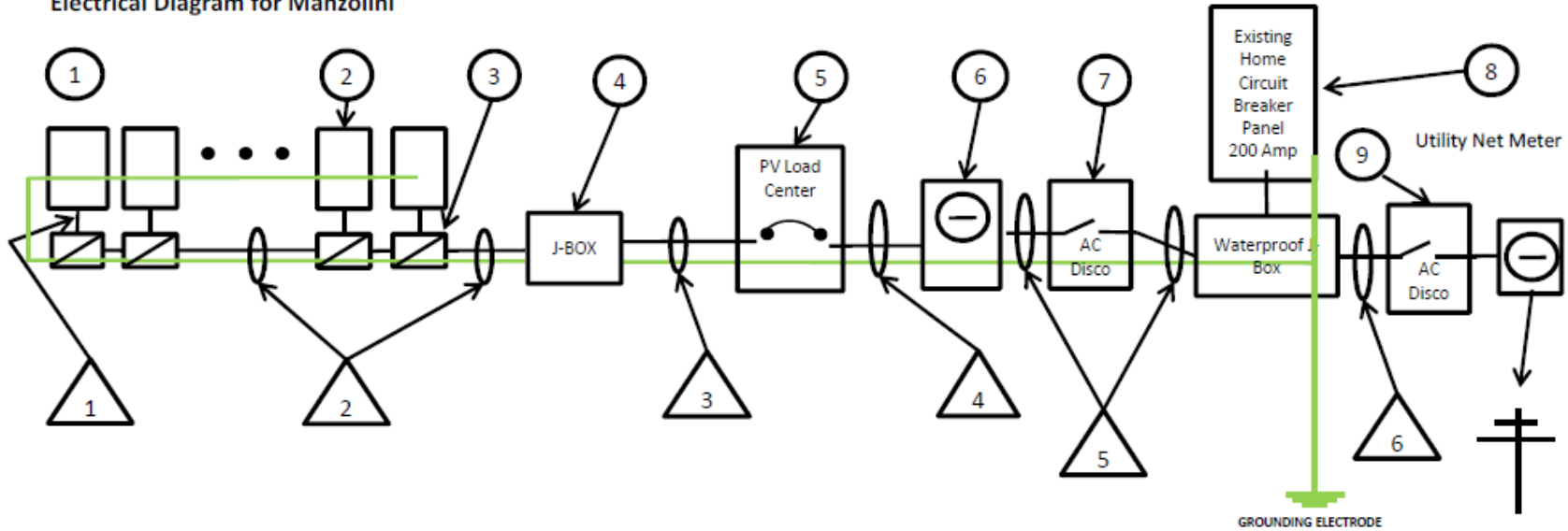

Conduit and Conductor Schedule

Tag	Description or Conductor Type	Conductor Gauge	Number of Conductors	Conduit Type	Conduit Size	Notes
1	PV Wire	12	2 (single)	N/A	N/A	Solar Panel to inverter (Typ)
2	Enphase Branch Cable	12	3	N/A	N/A	Solar Array Inverters to J-Box
	Bare Copper Eq. Ground Conductor	6	1	N/A	N/A	Array rack bonding
3	THWN-2 Insulated Copper	10	9	PVC	Min 3/4"	J-Box to Solar PV Load Center
	THWN-2 Insulated Copper Grounding	8	1			
4	4 AWG Aluminum	4	4	PVC	Min 3/4"	Solar PV Load Center Disconnect to kWh Meter
	Copper Grounding Electrode	6	1			
5	4 AWG Aluminum	4	4	PVC	Min 3/4"	Junction box to home CB panel and to meter for line-side tap.
6	SEU Utility Service Cable	4/0	3	N/A	N/A	Existing service cable to net meter

Astrum Solar, Inc.
15 Avenue E, Hopkinton MA
Hopkinton, MA 01748
Thursday, November 01, 2012



ASTRUMSOLAR®

Manzolini Residence
725 Canaan Road
Richmond, MA 01254

PD-3

Design

- Monitoring system components
 - 120 Vac 'array-sourced' outlet
 - Envoy controller / monitor
 - Collects array data over the 'power-line'
 - Wireless transmitter in garage
 - Wireless receiver in house
 - Wireless router connected to the internet
 - Web-based data collection and analysis system

Design

- Enphase Envoy Communications Gateway
 - The networking hub connecting every module and microinverter in your solar array to the internet.
 - The Envoy uses advanced powerline communications technology to connect to each microinverter without additional wiring or wireless configuration. System owners can easily check the status of their solar system using the Envoy's LCD display, or get more detailed information through the Enlighten website

Design

- Enlighten Website features
 - Measures performance of each panel
 - Panel and system power production (Watts)
 - daily, past 7 days, custom range
 - Panel and system energy production (kWHrs)
 - daily, past 7 days, month to date, lifetime, custom range
 - Reports
 - Site Energy Production
 - Site Recent Power Production
 - Monthly Energy Production
 - Environmental benefits 'data'
 - Carbon Offset

Solar Project Cost

plan and actual

- | | |
|---------------------------------------|---|
| ● System Cost | \$40,078 |
| ● Federal Credit | (\$13,824) |
| ● State Credit | (\$2,400) |
| ● Contracted amount | <u>\$23,854 - Plan</u> |
| ● Other expenses | \$ 698 (transformer, trenching) |
| ● Tier credit | (\$1,920) |
| ● Referral credit | <u>(\$ 250)</u> |
| | \$22,382 - Actual |
| ● What we'll save (plan to save) | |
| ➤ \$1,700 | Electric bill(s) reduction (annually) |
| ➤ \$2,600 | Solar Renewable Energy Credits (annually) |
| ● 5.2 year pay back period | |
| ● After that, continue annual savings | |

Solar Installation

Picture Tour

System layout for the footings

Footprint 8' by 68'

Footings are ten galvanized screws



Solar Installation

Picture Tour

Galvanized screws - 6' 10" long



Foundation Supports – in place





Foundation Supports – in place

Solar Installation

Picture Tour



Close-up of screws

Aluminum supports

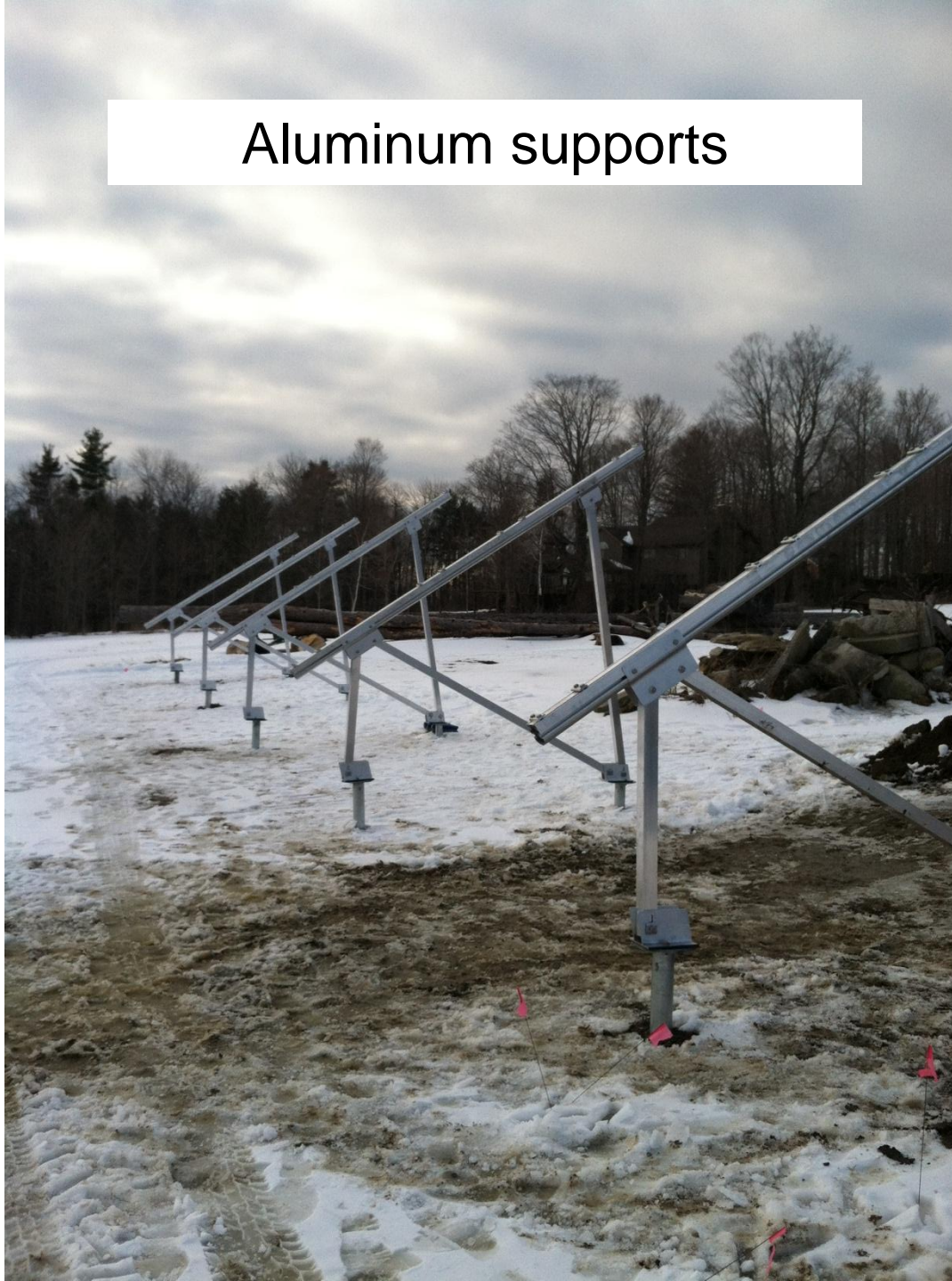



Installation in process



Installation complete - looking north



Installation complete – looking west



Installation complete – looking south



Panel

Panel Fastener



Panel Fastener



Inverter



PV junction panel

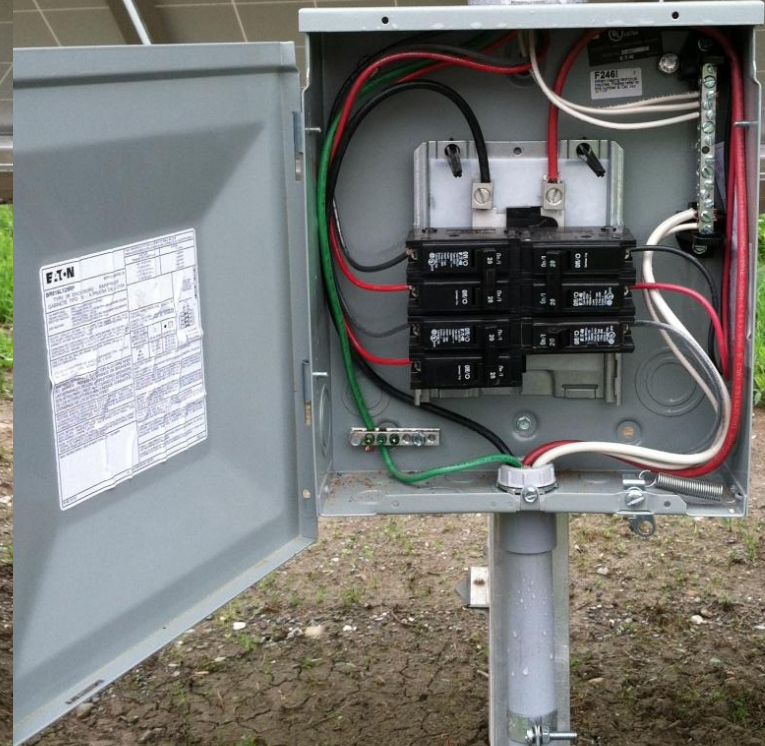



Production meter

PV disconnect switch



Sub Panel in Garage





Envoy Communications Gateway in Garage

New Main Panel in cellar



'new' WMECO NET meter

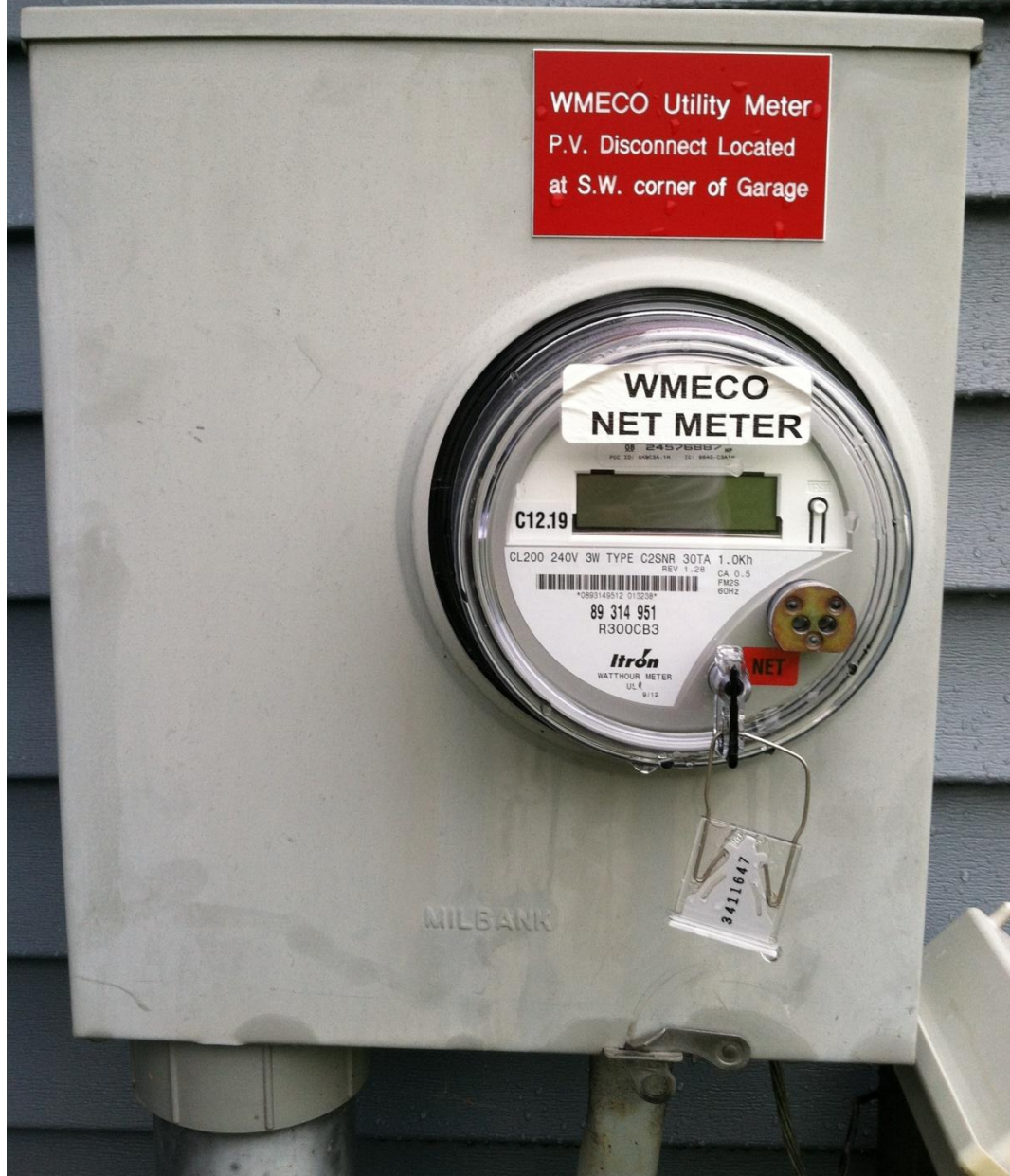

'old' WMECO meter



So How's it doing?

Production results to date

System turned on March 25th

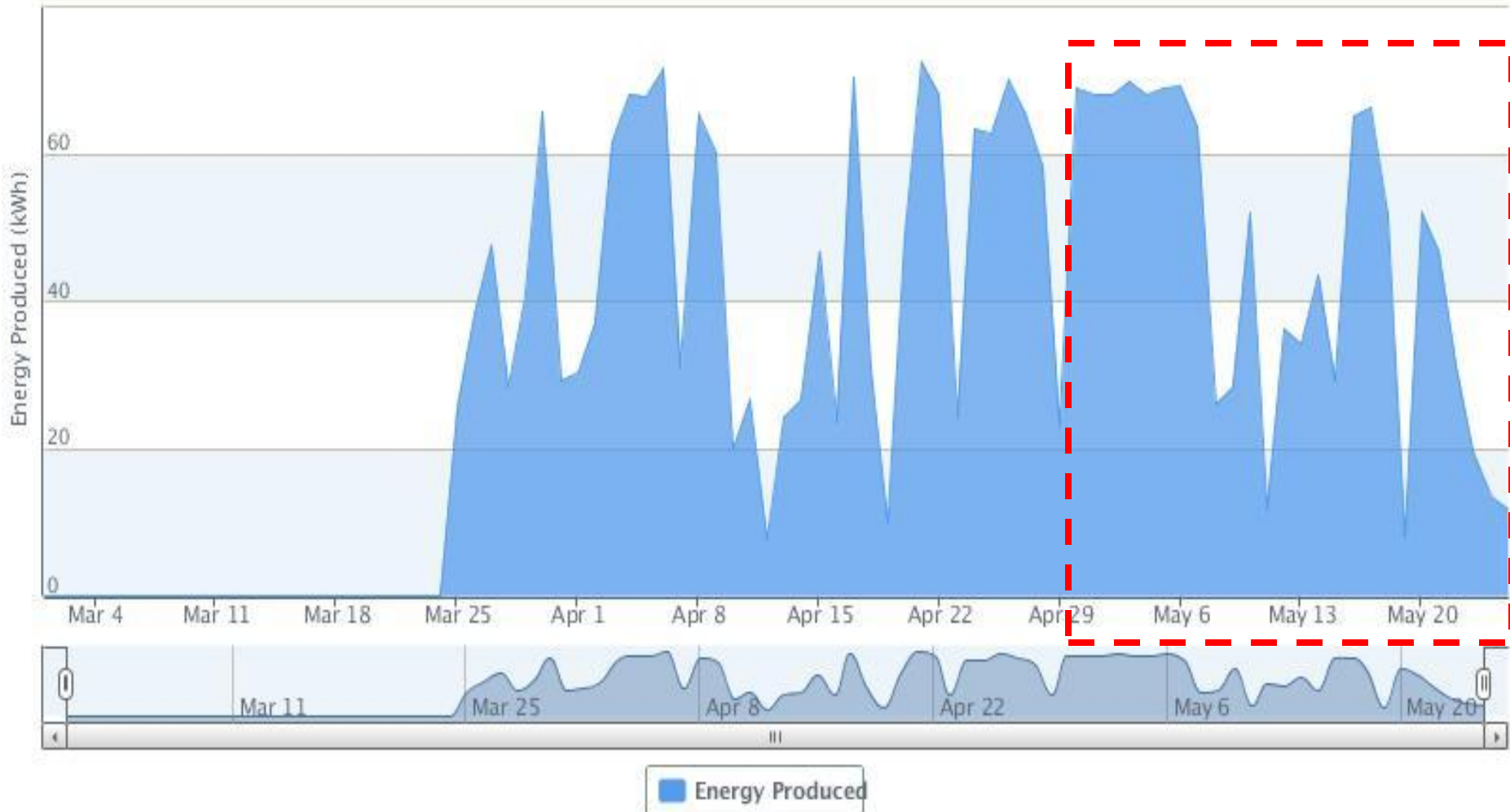

Daily energy production (kWHrs) May 2 – May 22

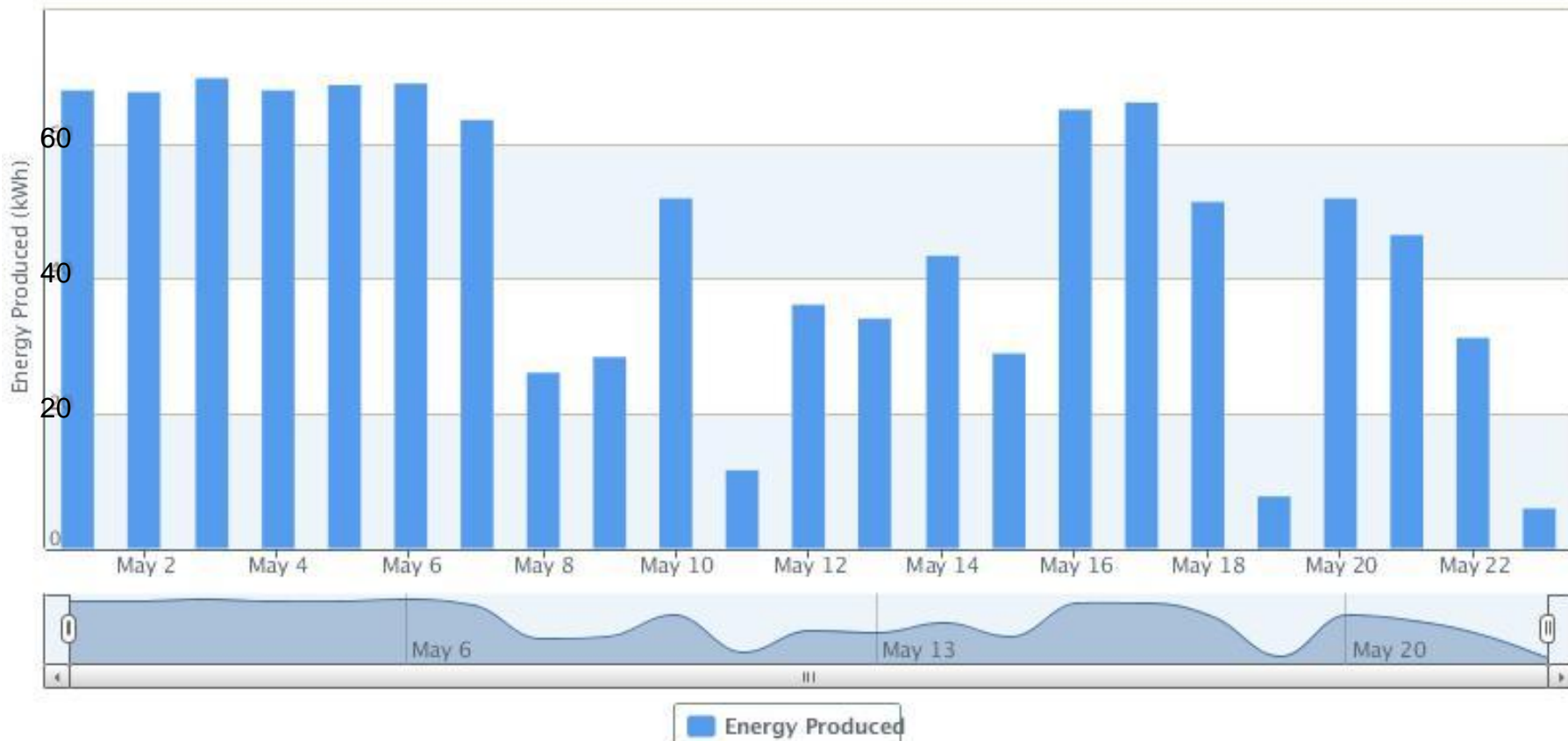

Daily energy production (kWHrs) May 2 – May 22

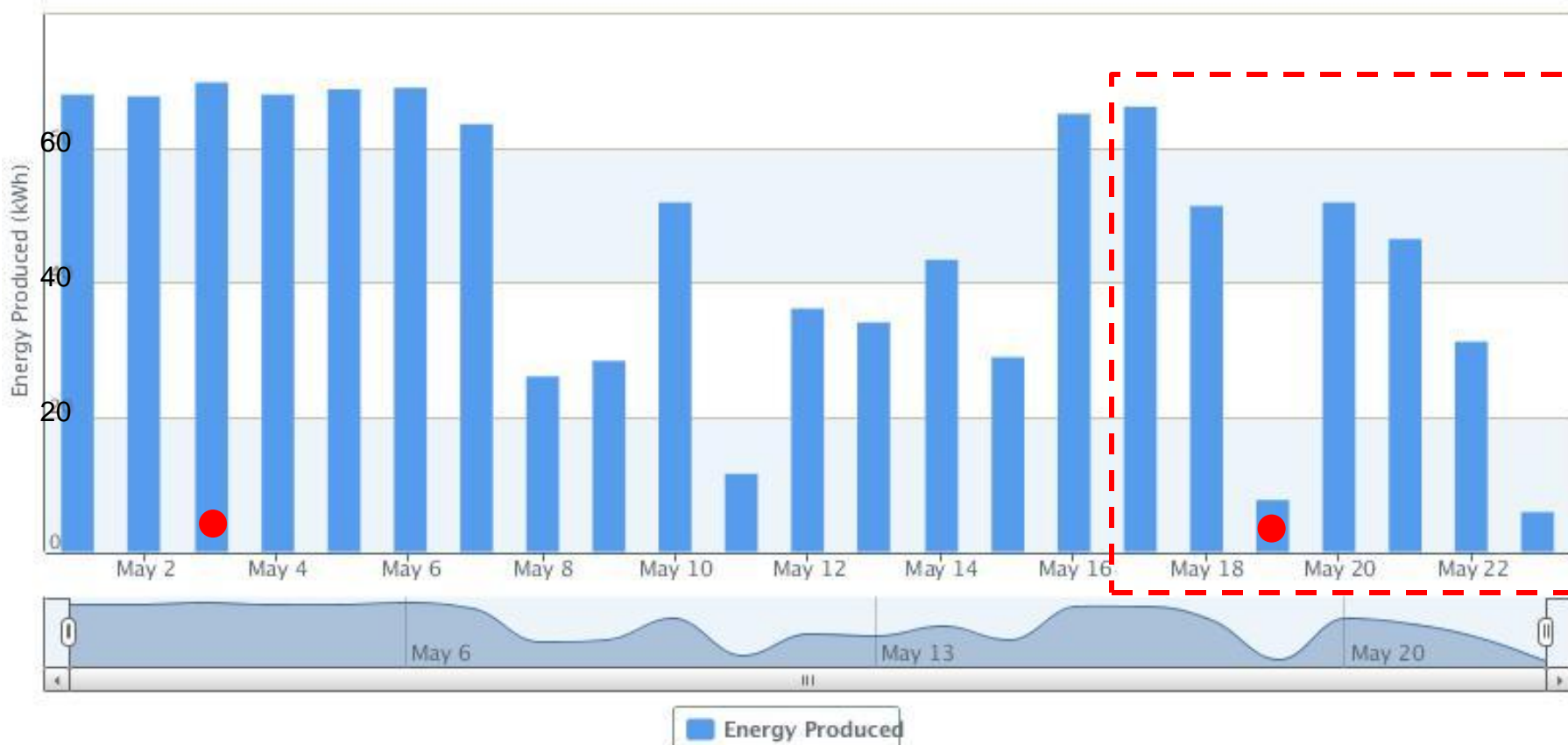

Power production (Watts)

May 17 – May 22



Power production (Watts)

May 3rd & May 19th

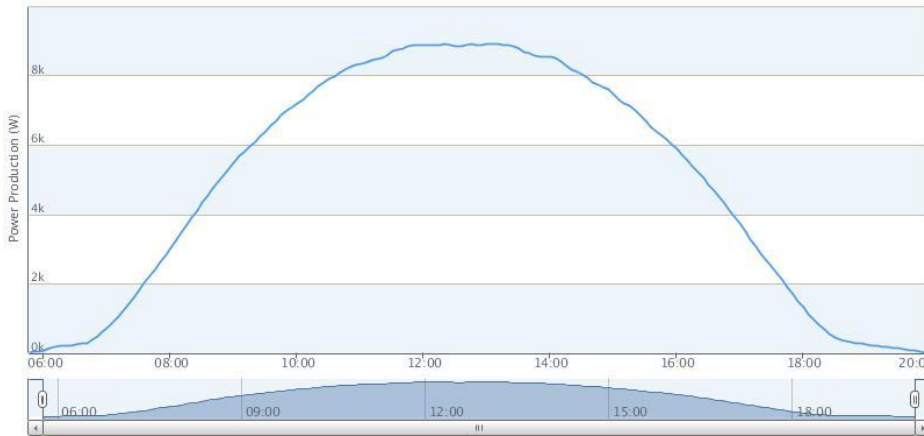

May 3rd
A real good sunny day
70 kWhrs

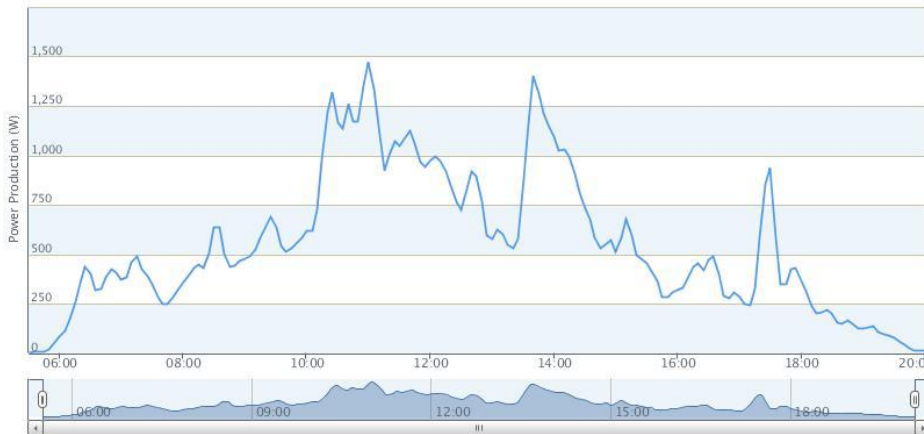

May 19th
A cloudy overcast day
8 kWhrs

Production results to date

System turned on March 25th

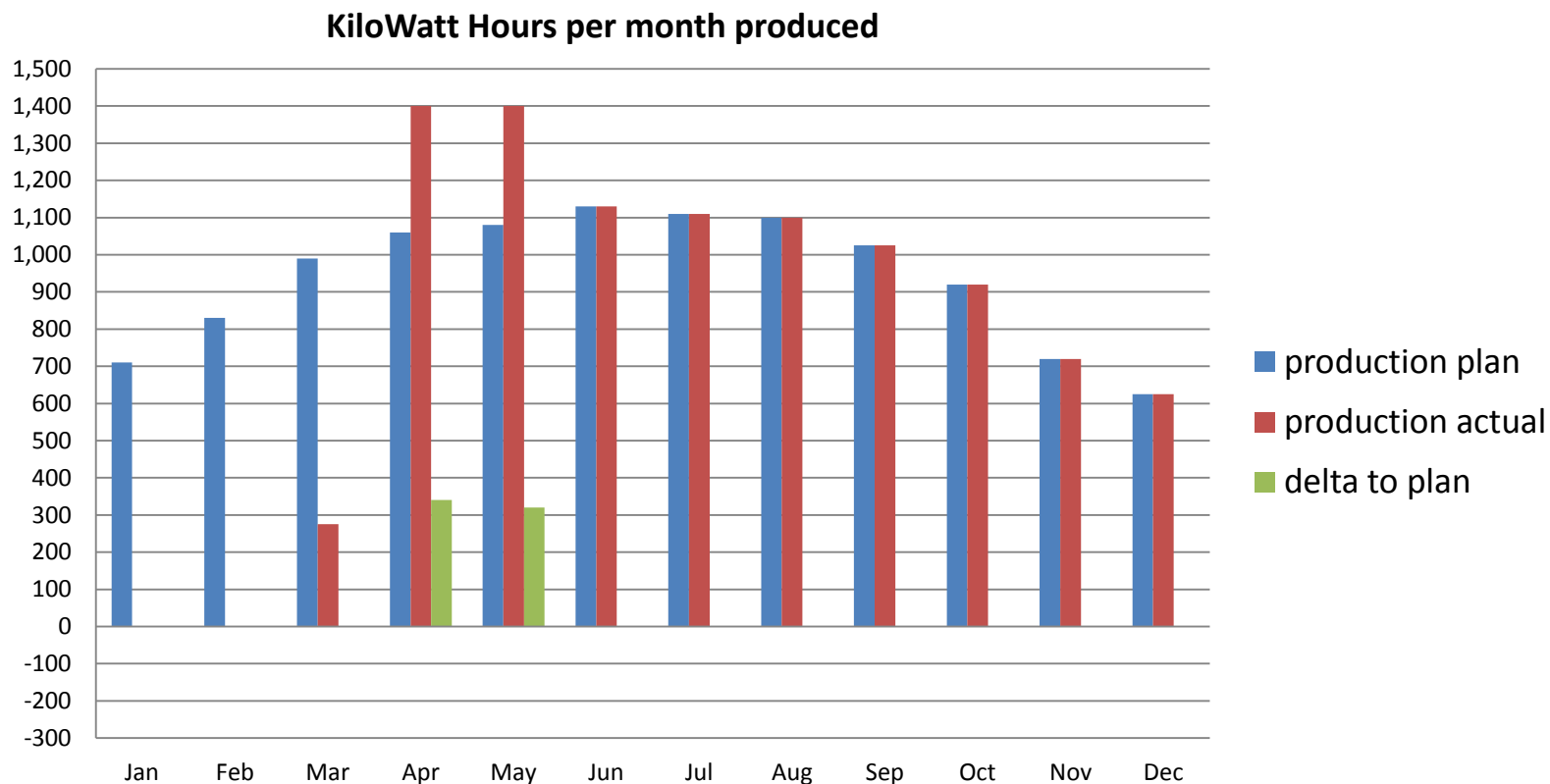

To date, actual production exceeds guaranteed production by more than 30%
My brother enjoys similar results with his system

Results to date (through May 16th)

Average Daily Power Flow / Use

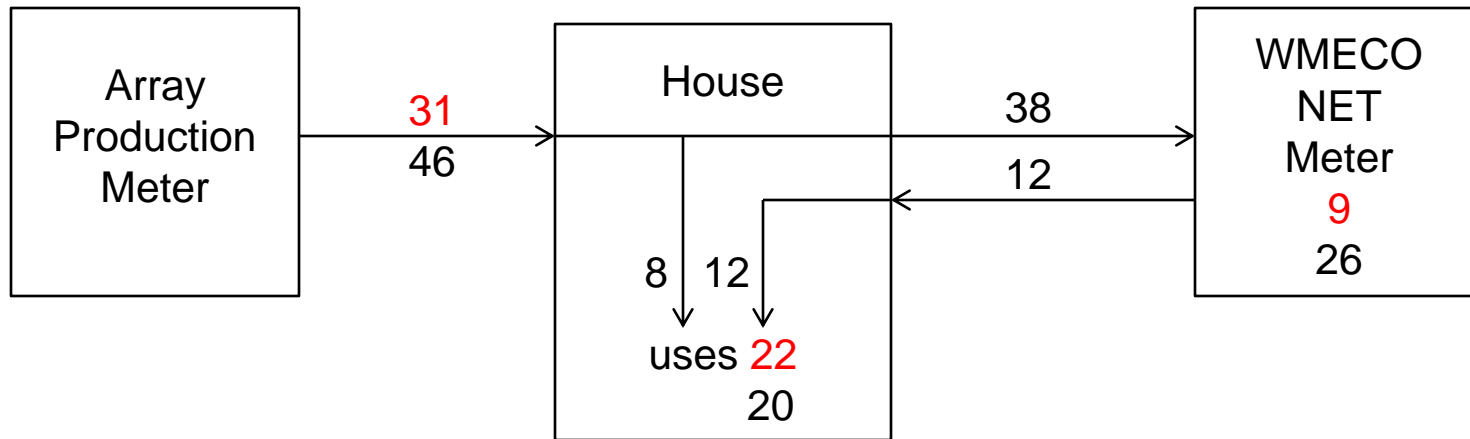

Average numbers as of June 5th:

1. Array produced 46 kWHrs / day
38 kWHrs sent to WMECO
8 kWHrs consumed by House
2. House used 20 kWHrs / day
8 kWHrs from Array during the day
12 kWHrs from WMECO at night
3. NET to WMECO was 26 kWHrs / day

red numbers – plan
black numbers - actual

Results to date (through May 16th)

Average Daily Benefit (\$)

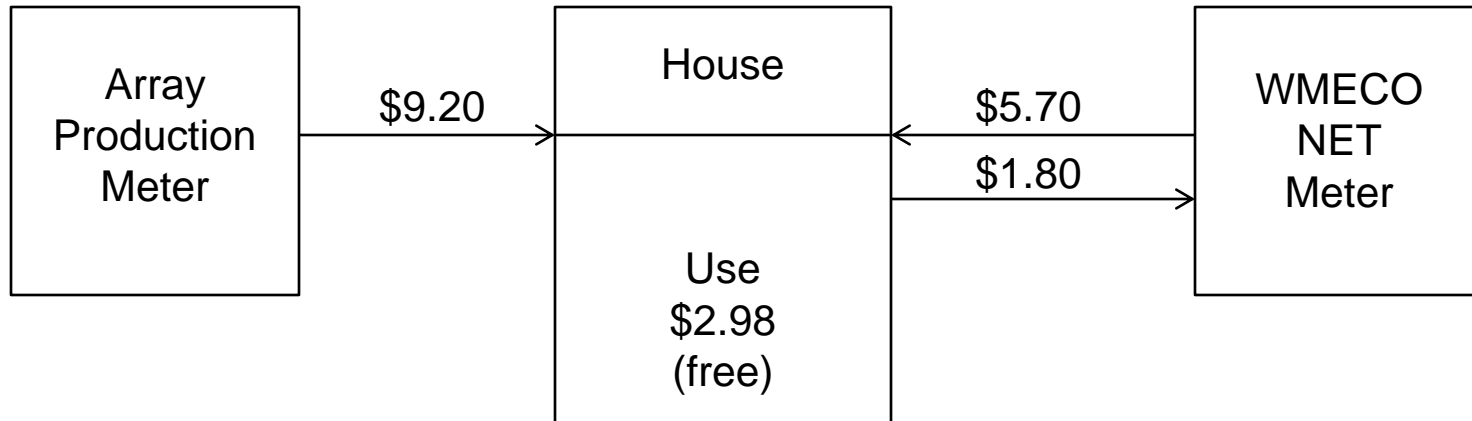

Average savings as of May 16th:

1. Didn't pay about \$3 per day for electrical use
2. Received about \$4 per day NET credit from WMECO
3. Will receive about \$9 per day from SREC revenue (~0.20/kWhr)
4. Results in about \$16 per day (\$780 in 46 days)

0802706

**Western Massachusetts
Electric**

A Northeast Utilities Company

ROGER MANZOLINI

Statement date: May 16, 2013

Customer name key: MANZ

Account number:

Due Date	Total Amount Due
Jun 10, 2013	- \$163.60

Contact Information

Emergency: 1-877-659-6326 (anytime)

Web Site: www.wmeco.comEmail: WMECOCustomerService@wmeco.com
Residential customers:

Customer Service: 1-877-659-6326

413-781-4300 Springfield area

(M-F 7-7 & Sat 10-3:30 pm)

Business customers:

Customer Service: 1-888-783-6610

413-504-8020 (local)

(M-F 8-5)

Simplify your life
Use eBill and ePay at www.wmeco.com

Or Pay by Phone 1-888-783-6618

Electricity Supplier

Western Massachusetts Electric

P.O. Box 150494

Hartford, CT 06115-0494

1-877-659-6326

Your account summary

Amount due on Apr 12	- \$38.99
Balance Forward	- \$38.99
New Charges/Credits	
Delivery Services	- \$124.61
Electricity Supply Services	\$0.00
Total new charges	- \$124.61
Credit Balance	- \$163.60

Detail for Service at:

725 CANAAN RD , RICHMOND MA 01254-5122

Service reference:

Billing cycle: 06

Your meter reading for meter :

For billing period: Apr 9 - May 10 (31 days)	Next read date on or about: Jun 10, 2013
Actual reading on May 10, 2013 purchases	665
Actual reading on Apr 9 , 2013 purchases	- 298
Billed usage	= 367

Your meter reading for meter :

For billing period: Apr 9 - May 10 (31 days)	Next read date on or about: Jun 10, 2013
Actual reading on May 10, 2013 sales	1828
Actual reading on Apr 9 , 2013 sales	- 585
Billed usage	= 1,243

Account number:

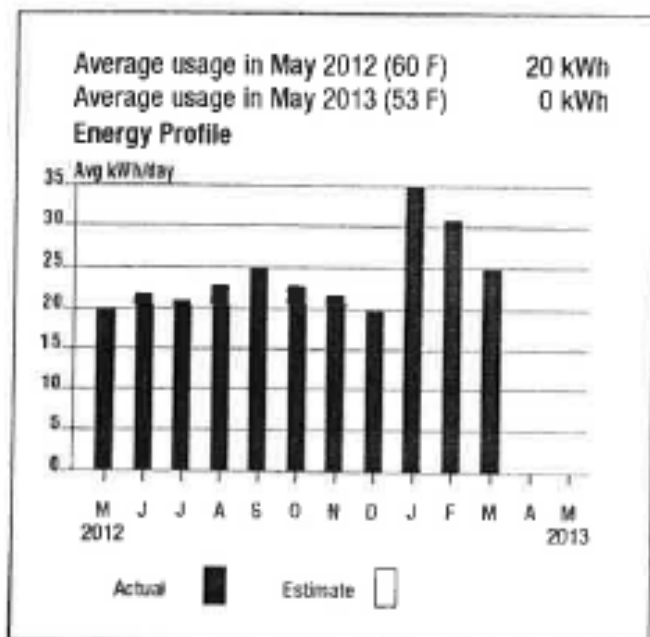
**WMECO Delivery Services Detail RATE R1**

Customer Chrg			\$6.00
Net Generation Credit	876.00KWH	x - \$0.149100	- \$130.61
Subtotal			- \$124.61

Electricity Supply Detail RATE R1 - BASIC FIXED**Account messages****IMPORTANT!**

Effective May 13, we are changing our address for mailing payments. Beginning with this bill, please send payments to:

WMECO
 P O Box 650851
 Dallas, TX 75265-0851

Business customers: Please update your records with the new address now to avoid any delays in processing payments. You will find the new address at the bottom of your bill. If you have questions or concerns, call 1-888-783-6610 (business customers) or 1-877-659-6326 (residential customers). We would be happy to help you.

Scan this with your smartphone! It will simplify your life.
 Go to your app store to get a list of barcode reader apps for your mobile device.

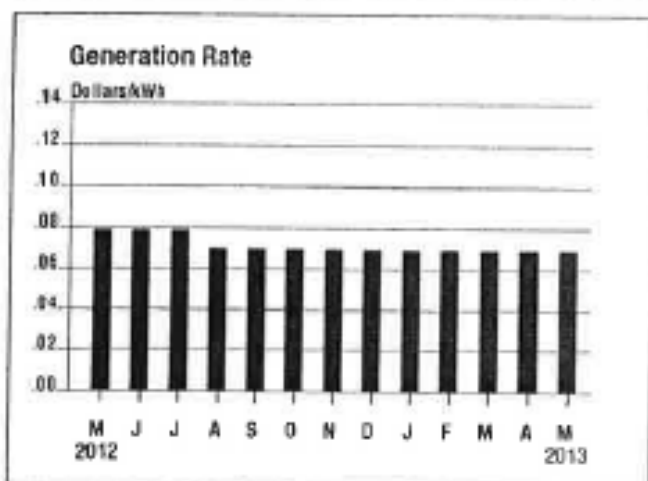

Other Interesting stuff

Manzolini, Roger

Energy: Month to Date May 1, 2013 – May 17, 2013



20.3 20.8 20.3 20.4 20.1 20.2 20.9 20.1 20.7 20.0 20.1 20.6 19.9 20.2 19.9 20.2 20.2 20.7 20.5 20.1

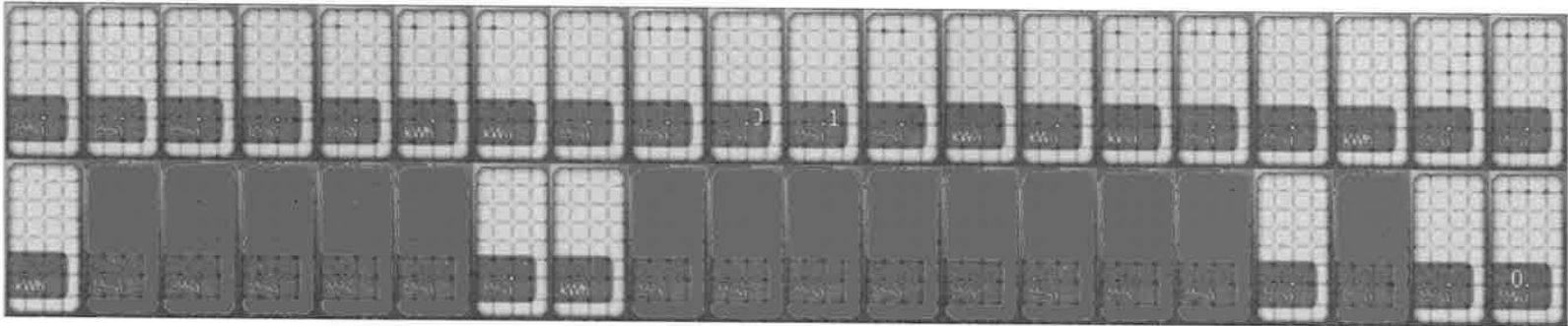

20.9 20.9 20.8 20.1 20.3 20.6 20.5 20.1 20.4 20.6 20.6 20.8 20.0 20.3 20.1 20.0 20.4 19.9 20.1 20.1

System
Energy
814 kWh

Average of 20.4 kWhr per panel

1.20 kWhr per panel per day

Manzolini, Peter

Energy: Month to Date May 1, 2013 – May 17, 2013

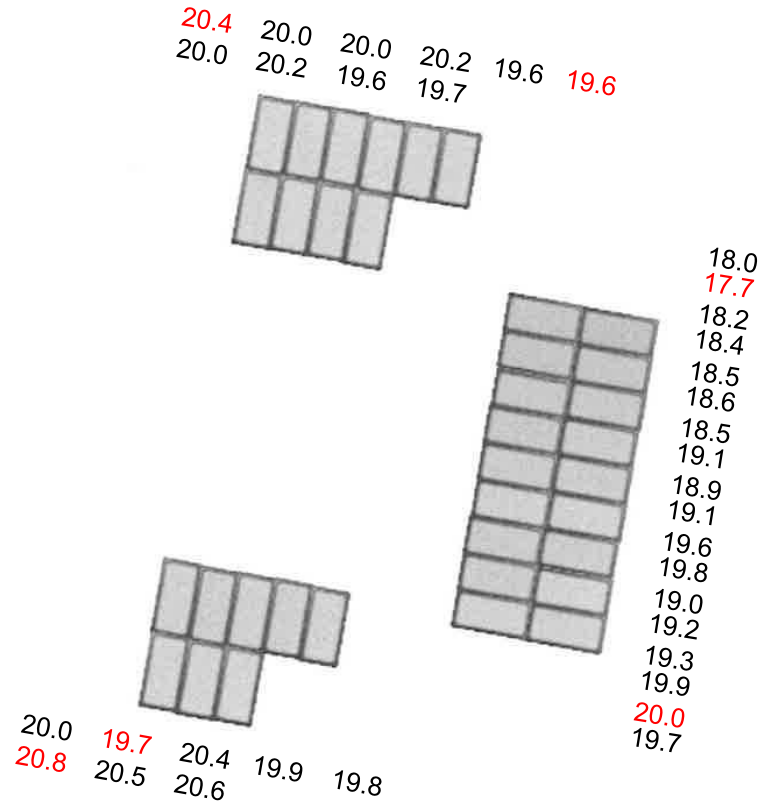

System
Energy
703 kWh

Note 4 things:

1. His south panels did the same as my south panels
2. His East panels did about (93%) as well as his south panels
3. All the 'same facing' panels do about the same
4. His total system produced 1.15 kWhr per panel per day, 96% as good as my system

Average of 19.5 kWhr per panel

1.15 kWhr per panel per day

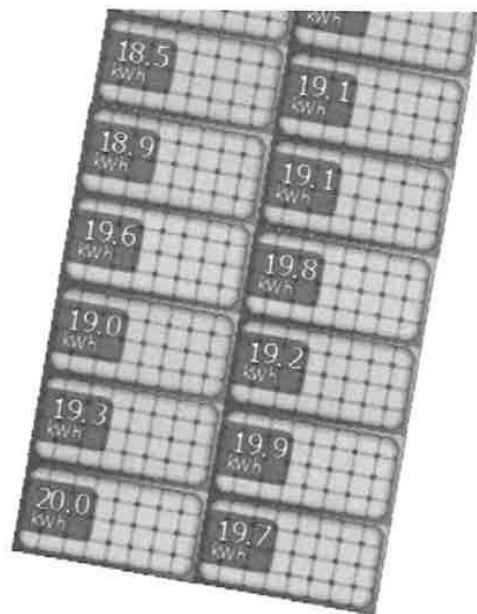
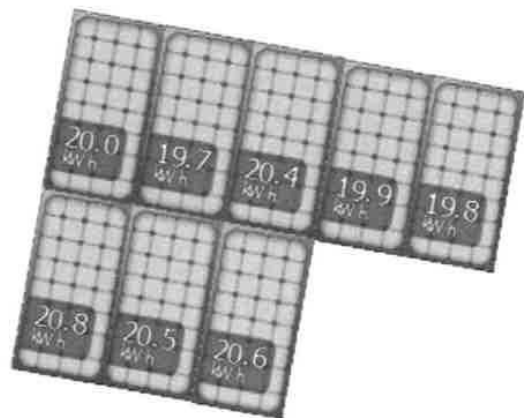

Rough conclusion

- To get the production you use, you need one 240W panel for each average daily kWhr used
 - Each 240W panel:
 - provides 225 Watts after inversion to AC
 - 15 ft² (3'x5'), 15 Watts / ft²
 - produces 1.0 to 1.2 kWhr per day
- For the national average daily use of 30 kWhrs, you need
 - 30 panels, 450 ft²
- Note:
 - my system is 40 panels, it produces 47 kWhrs / day
 - Quality factor 0.98 (all at 35° facing south)
 - Peter's system is 36 panels, it produces 36 kWhrs / day
 - Quality factor 0.89 (18 facing ~east, 18 facing ~south)

Real rough, real easy, quick estimate

- Divide your average electric bill by 5
 - That is how many 240W panels you need
 - (e.g. $150 / 5 = 30$ panels)
- Multiply your average electric bill by 3
 - That is how much surface area you need
 - (e.g. $150 \times 3 = 450$ ft²)
- Multiply your electric bill by 120
 - That is about what it would cost to own the system
 - (e.g. $150 \times 120 = \$18,000$)
 - Payback period about 6 to 8 years

WMECO Residential rates as of May 2013

	kWused	1050	35
	over 600	450	
		rate	
Distribution Energy Charge first 600	\$	0.040190	\$ 24.11
Distribution Energy Charge over 600	\$	0.050190	\$ 22.59
Transition charge	\$	0.006820	\$ 7.16
Transmission Charge	\$	0.016190	\$ 17.00
Res Assist Adj Clause	\$	0.003850	\$ 4.04
Pension/PBOP Adj Mechn PPAM	\$	0.005760	\$ 6.05
Basic Srvc Coat Adj	\$	0.000120	\$ 0.13
Net metering recovery Surcharge	\$	0.000170	\$ 0.18
Solar Program Cost Adjustment	\$	0.000300	\$ 0.32
Energy Conservation Charge	\$	0.002500	\$ 2.63
Energy Efficiency Program Charge	\$	0.007650	\$ 8.03
Renewable Energy Charge	\$	0.000500	\$ 0.53
Atty Genrl consultant exp adj	\$	0.000030	\$ 0.03
Storm recovery adjustment	\$	0.001220	\$ 1.28
Revenue Decoupling Adj	\$	(0.001270)	\$ (1.33)
Distributionsubtotal			\$ 92.73
Generation Service Charge	\$	0.073150	\$ 76.81
Cost of power			\$ 169.54
Customer charge	fixed cost		\$ 6.00
Total			\$ 175.54

Other things to ponder

- A system size (kW) about $\frac{1}{4}$ of your average daily energy use is needed to cover your entire electric bill
- Trees (peaks of other buildings?) need to be twice as far from the system as they are tall
 - E.g. a 100 foot tree is not an issue if it 200 feet away
- Most roofs can accept the added system load without modification
 - If bracing is needed that is part of the 'assessment' and Astrum Solar will do the work as part of the job
- Typical time line from now to power on is 6 months

Solar Installation

Risks

- Roof leaks are more difficult to fix
 - AS guarantees within 5" of penetrations
- Market value of SRECs may collapse
- SREC income may become taxable
- Rates from WMECO may change
- Tax benefits may disappear
- Real estate tax exemption may be eliminated
- Home insurance premiums may rise
- Warrantees might not be honored
- Astrum Solar could go out of business

Our experience with Astrum Solar

- The positives
 - Astrum Solar has taken the mystery out of solar systems
 - They do it all:
 - Design, paperwork, installation, coordination with electric company
 - They provide post installation services
 - Monitoring, SREC management, customer service
 - Employees were very accommodating, pleasant and like the company
- The negative
 - After the contract was signed, it seemed like they disappeared; however, in reality they were engaged performing detailed behind the scenes tasks and plans necessary to get the job underway
- Once started, the mechanical and electrical work was performed to very high standards
- Overall, the Manzolini's are very pleased

Solar Installation

How to proceed

- Sign up on sheet you were given
- Astrum Solar will contact you for a site survey
- You provide record of your annual electrical use
- Astrum Solar will follow up with:
 - Site assessment, concept design, guaranteed production numbers, proposal options, cost of options, estimated payback period, approximate time line for installation
- You decide to go forward with one of the options or to discontinue pursuit

Name: _____

Address of proposed system:

Phone no: _____

E-mail : _____

Deleted slides



ASTRUMSOLAR®



Quote Date: 08/29/12, Pricing Valid Until: 09/12/2012

Cara Humphrey

845-489-7403

cara.humphrey@astrumsolar.com

Version 12.8- Solarize MA_08.06.12

New Calculator 12.8-Solarize MA 8-06-12 (1).xlsx

YOUR SOLAR CALCULATOR QUOTE

Roger Manzolini
725 Canaan Road,
Richmond, MA 01254

Your Solar System Overview

9.6 kW system
40 SolarWorld 240 watt solar panels
M215 Enphase Energy microinverters
Enlighten website monitoring for system lifetime

141% of your electricity will be solar
11,318 kWh of solar electricity generated annually

[Only available for Solarize Pittsfield Lenox](#)

SEE A SUNNY DAY IN A WHOLE NEW WAY™

PERFORMANCE UNDER STANDARD TEST CONDITIONS (STC)*

SW 240	
Maximum power	240 Wp
Open circuit voltage	37.6 V
Maximum power point voltage	30.6 V
Short circuit current	8.22 A
Maximum power point current	7.87 A

*STC: 1000W/m², 25°C, AM 1.5

THERMAL CHARACTERISTICS

NOCT	48 °C
TC _{I_{sc}}	0.004 %/K
TC _{V_{oc}}	-0.30 %/K
TC P _{mpp}	-0.45 %/K
Operating temperature	-40°C to 85°C

I-V curves for SolarWorld Sunmodule Plus SW 240 mono at 25°C cell temperature

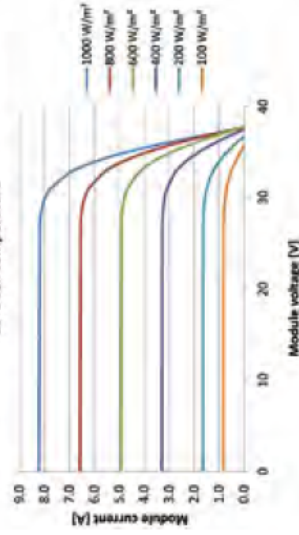

PERFORMANCE AT 800 W/m², NOCT, AM 1.5

SW 240	
Maximum power	175.4 Wp
Open circuit voltage	34.2 V
Maximum power point voltage	27.9 V
Short circuit current	6.63 A
Maximum power point current	6.30 A

Minor reduction in efficiency under partial load conditions at 25°C: at 200W/m², 95% (+/-3%) of the STC efficiency (1000 W/m²) is achieved.

COMPONENT MATERIALS

Cells per module	60
Cell type	Mono crystalline
Cell dimensions	6.14 in x 6.14 in (156 mm x 156 mm)
Front	tempered glass (EN 12150)
Frame	Black anodized aluminum
Weight	46.7 lbs (21.2 kg)

SYSTEM INTEGRATION PARAMETERS

Maximum system voltage SC II	1000 V
Max. system voltage USA NEC	600 V
Maximum reverse current	16 A
Number of bypass diodes	3
UL Design Loads*	Two rail system 113 psf downward 64 psf upward
UL Design Loads*	Three rail system 170 psf downward 64 psf upward
IEC Design Loads*	Two rail system 113 psf downward 50 psf upward

*Please refer to the Sunmodule installation instructions for the details associated with these load cases.

ADDITIONAL DATA

Power sorting ²⁾	-0 Wp / +5 Wp
J-Box	IP65
Connector	MCA
Module efficiency	14.31 %
Fire rating (UL 790)	Class C

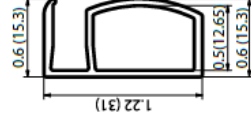

VERSION 2.0 FRAME

- Compatible with "Top-Down" mounting methods
- Grounding Locations: 4 corners of the frame

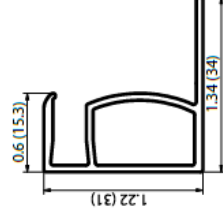

VERSION 2.5 FRAME

- Compatible with both "Top-Down" and "Bottom" mounting methods
- Grounding Locations: - 4 corners of the frame
- 4 locations along the length of the module in the extended flange¹⁾

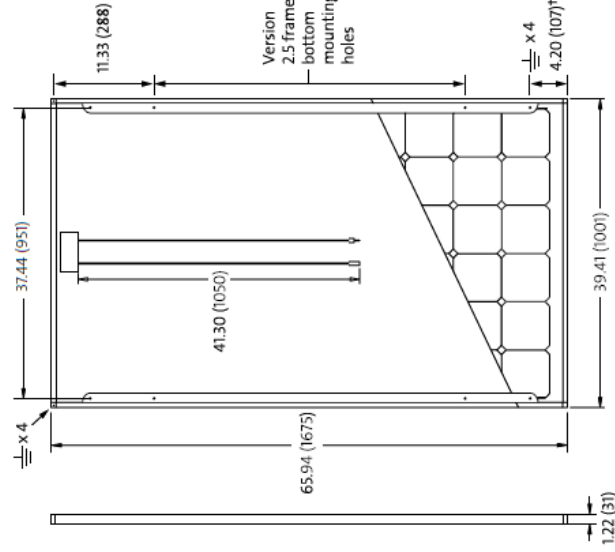

M215 — MICROINVERTER TECHNICAL DATA

Input Data (DC)

M215-60-2LL-S22/S23/S24 and M215-60-2LL-S22-NA/S23-NA (Ontario)

Recommended input power (STC)	190 - 270W
Maximum input DC voltage	45V
Peak power tracking voltage	22V - 36V
Operating range	16V - 36V
Min./Max. start voltage	22V/45V
Max. DC short circuit current	15A
Max. input current	10.5A

Output Data (AC)

@208 Vac

@240 Vac

Maximum output power	215W	215W
Nominal output current	1.0A (arms at nominal duration)	0.9A (arms at nominal duration)
Nominal voltage/range	208V/183-229V	240V/211-264V
Extended voltage/range	208V/179-232V	240V/206-269V
Nominal frequency/range	60.0/59.3-60.5 Hz	60.0/59.3-60.5 Hz
Extended frequency range	60.0/59.2-60.6 Hz	60.0/59.2-60.6 Hz
Power Factor	>0.95	>0.95
Maximum units per 20A branch circuit	25 (three phase)	17 (single phase)
Maximum output fault current	1.05 Arms, over 3 cycles; 25.2 Apeak, 1.74ms duration	

Efficiency

CEC weighted efficiency	96.0%
Peak inverter efficiency	96.3%
Static MPPT efficiency (weighted, reference EN50530)	99.6%
Dynamic MPPT efficiency (fast irradiation changes, reference EN50530)	99.3%
Night time power consumption	46mW

Mechanical Data

Ambient temperature range	-40°C to + 65°C
Operating temperature range (internal)	-40°C to + 85°C
Dimensions (WxHxD)	17.3 cm x 16.4 cm x 2.5 cm (6.8" x 6.45" x 1.0")*
Weight	1.6 kg (3.5 lbs)
Cooling	Natural convection - No fans
Enclosure environmental rating	Outdoor - NEMA 6

* without mounting bracket

Features

Compatibility	Pairs with most 60-cell PV modules
Communication	Power line
Warranty	25-year limited warranty
Monitoring	Free lifetime monitoring via Enlighten software
Compliance	UL1741/IEEE1547, FCC Part 15 Class B CAN/CSA-C22.2 NO. 0-M91, 0.4-04, and 107.1-01



ASTRUMSOLAR®

CUMULATIVE CASH FLOWS OVER 20 YEARS

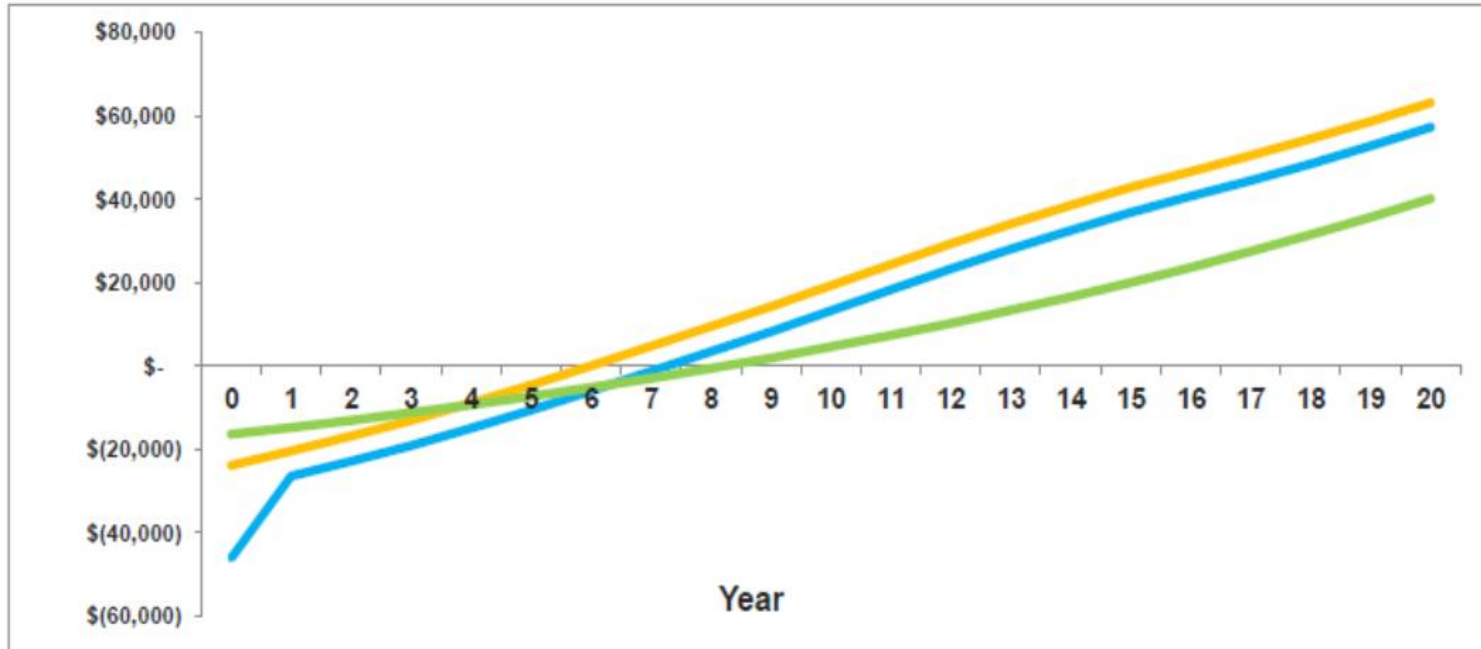

	Own	One Pay Plan - You Keep the SRECs	One Pay Plan
Initial Investment	\$ (46,080)	\$ (23,854)	\$ (16,361)
Cumulative Cash Flows	\$ 57,160	\$ 63,162	\$ 40,178

SEE A SUNNY DAY IN A WHOLE NEW WAY™

Different plans are available now



Visit our website: www.wmeco.com

For Emergency: 1-877-659-6326 24 hours a day, 7 days a week

For Customer Service: 1-877-OKWMECO (1-877-659-6326) (413-781-4300 Springfield area) Mon-Fri 7am-7pm and Sat 10am-3:30pm

Your Electric Supplier: Western Massachusetts Electric P.O. Box 150494 Hartford, CT 06115-0494 1-877-659-6326

To pay your bill electronically, please visit our website or call 1-888-783-6618

Your account summary

Table with 2 columns: Description, Amount. Rows include Previous balance on Mar 25 (\$96.27), Payment Apr 15 (-\$96.27), Balance Forward (\$0.00), New Charges/Credits (\$58.22), Delivery Services (\$47.27), Supplier Services (\$105.49), Total new charges (\$105.49), Total amount now due (\$105.49).

What you owe for this month's electricity (including solar credits).

Your account is enrolled in an electronic payment program. The payment is scheduled to be processed from your designated bank account on May 18, 2011.

For service at: [redacted]

Service reference: [redacted] Billing cycle: 18

Your meter reading for meter # [redacted]

Table with 2 columns: Description, Amount. Rows include For billing period: Mar 25 - Apr 27 (33 days), Next read date on or about: May 26, 2011, Actual reading on Apr 27, 2011 purchases (15107), Actual reading on Mar 25, 2011 purchases (-14161), Billed usage (= 946).

How much electricity from WMECO you used this month

Your meter reading for meter # [redacted]

Table with 2 columns: Description, Amount. Rows include For billing period: Mar 25 - Apr 27 (33 days), Next read date on or about: May 26, 2011, Actual reading on Apr 27, 2011 sales (3300), Actual reading on Mar 25, 2011 sales (-3030), Billed usage (= 270).

How much solar electricity you delivered to WMECO

Compare your electricity usage Average usage in Apr 2010 (48 F) 14 kWh Average usage in Apr 2011 (44 F) 20 kWh Energy Profile

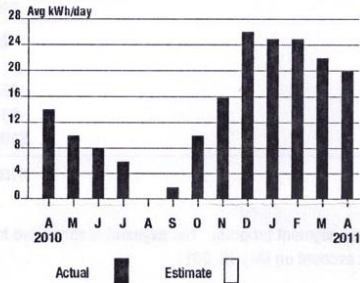

Generation Rate Dollars/kWh

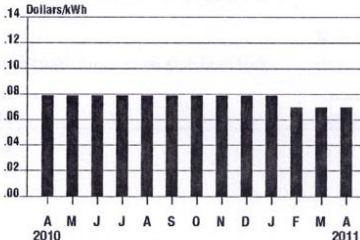

Table with 3 columns: Description, Calculation, Amount. Rows include Delivery Services Detail (Customer Chrg, Distribution Energy Charge*, Transition Chrg Per KWH, Transmission Chrg, Res Assist Adj Clause, Pension/PBOP Adj Mechn PPAM, Basic Srv Cost Adj, Net metering recovery surcharge, Solar Program Cost Adjustment, Energy Conservation Chrg, Energy Efficiency Program Chrg, Renewable Enrgy Chrg, Atty Genl consultant exp adj, Storm recovery adjustment) and Total Delivery Services (\$58.22).

WMECO charges for the electricity you used from them (946 kWh) minus the solar electricity you gave back (270 kWh) = 676 kWh

Table with 3 columns: Description, Calculation, Amount. Rows include Supplier Services Detail (Generation Srv Chrg***) and Total Supplier Services (\$47.27).

Solar Installation

Some 'very rough estimates' for early planning

240W panels needed as a function of average monthly electric bill

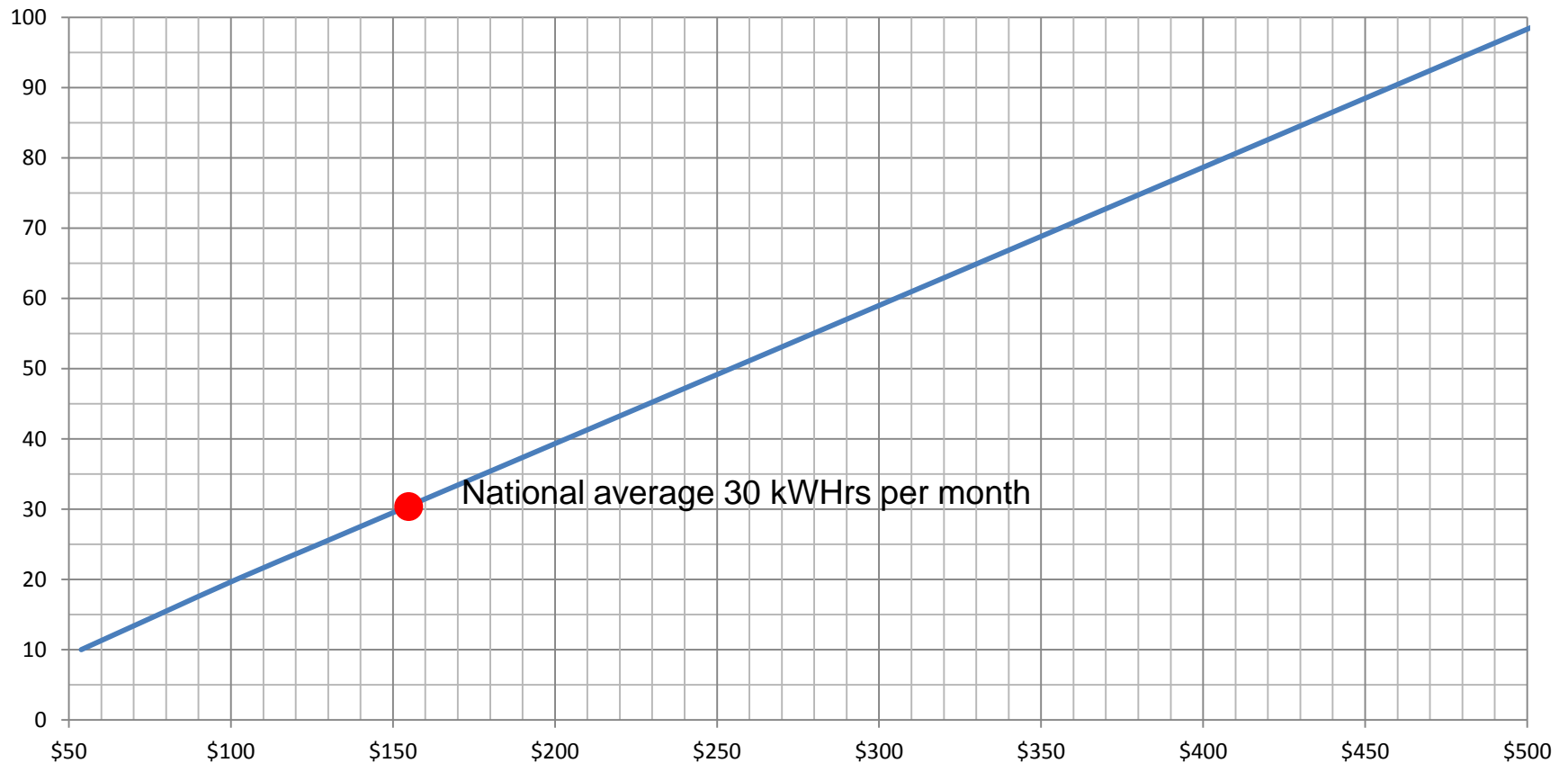

Solar Installation

Some 'very rough estimates' for early planning

roof area (sq. ft.) needed as a function of average monthly electric bill

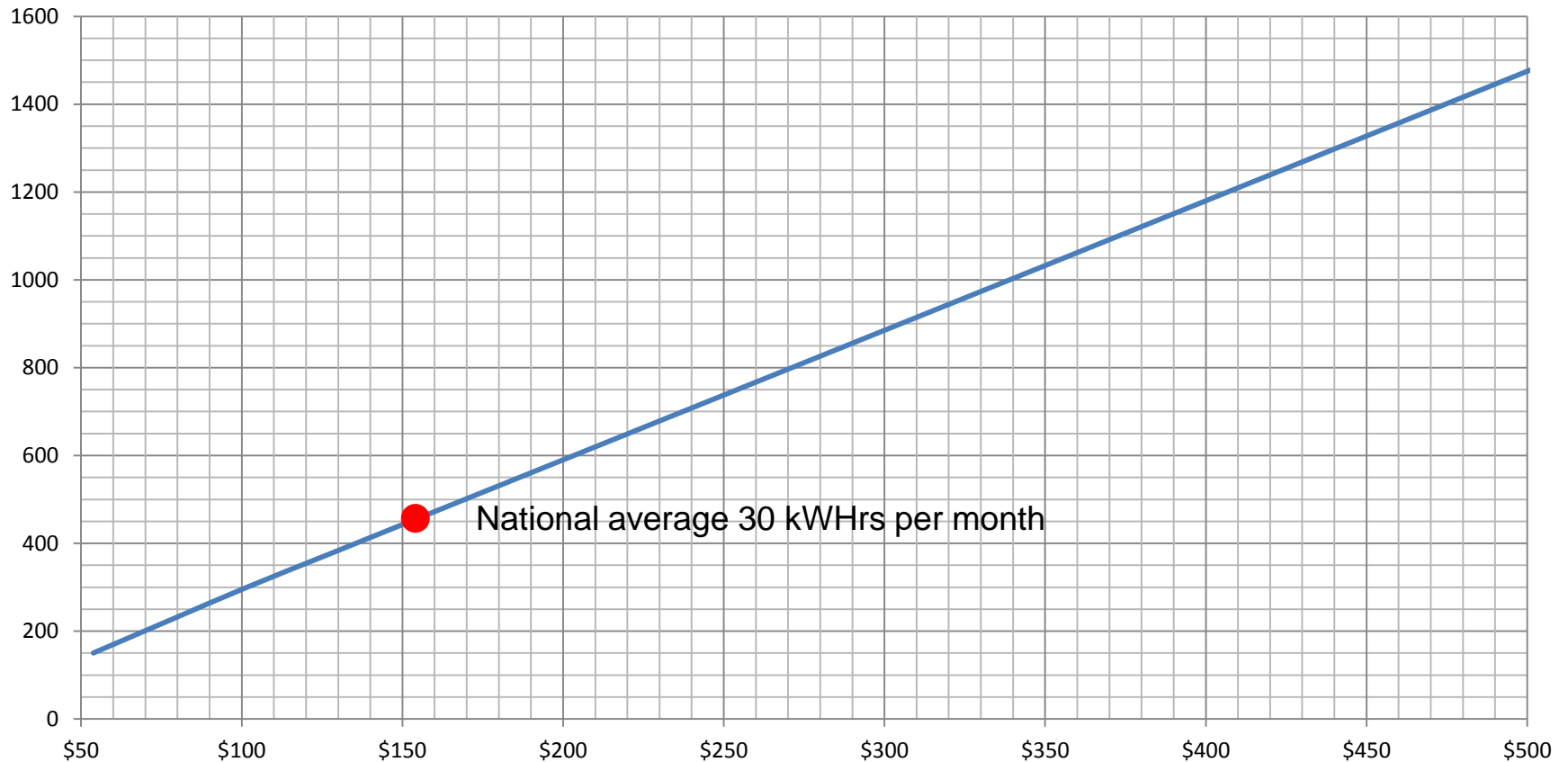

WMECO Utility Meter

P.V. Disconnect Located

at S.W. corner of Garage

Massachusetts SREC Market

- The Massachusetts Department of Energy Resources (DOER) created an SREC market which began in January 2010. Massachusetts's market is unique as it's final goal is 400MW of solar capacity. This has led to DOER to adopt a policy of setting requirements annually, based on a formula incorporating build rates and SREC data from past years. In addition to this, the state has implemented the MA Solar Credit Clearinghouse as a last resort, fixed-price auction in the last quarter of each year with a fixed price of \$300 per SREC less a 5% fee. This fixed price auction acts as a price floor mechanism with the goal of creating a sustainable SREC market. This is not a concrete price floor as compliance buyers are not required to buy all of the SRECs that are put into the auction.
- **Solar Requirement:** Set at 30MW (0.0680% or 34,164 SRECs) in 2010. Each year the requirement will increase by 30% more than the previous year's increase. It will then be adjusted by the previous year's oversupply or shortage of SRECs. The total requirement in any given year is capped at 400MW and shall never decrease.

Plan

Average Monthly kW Hours

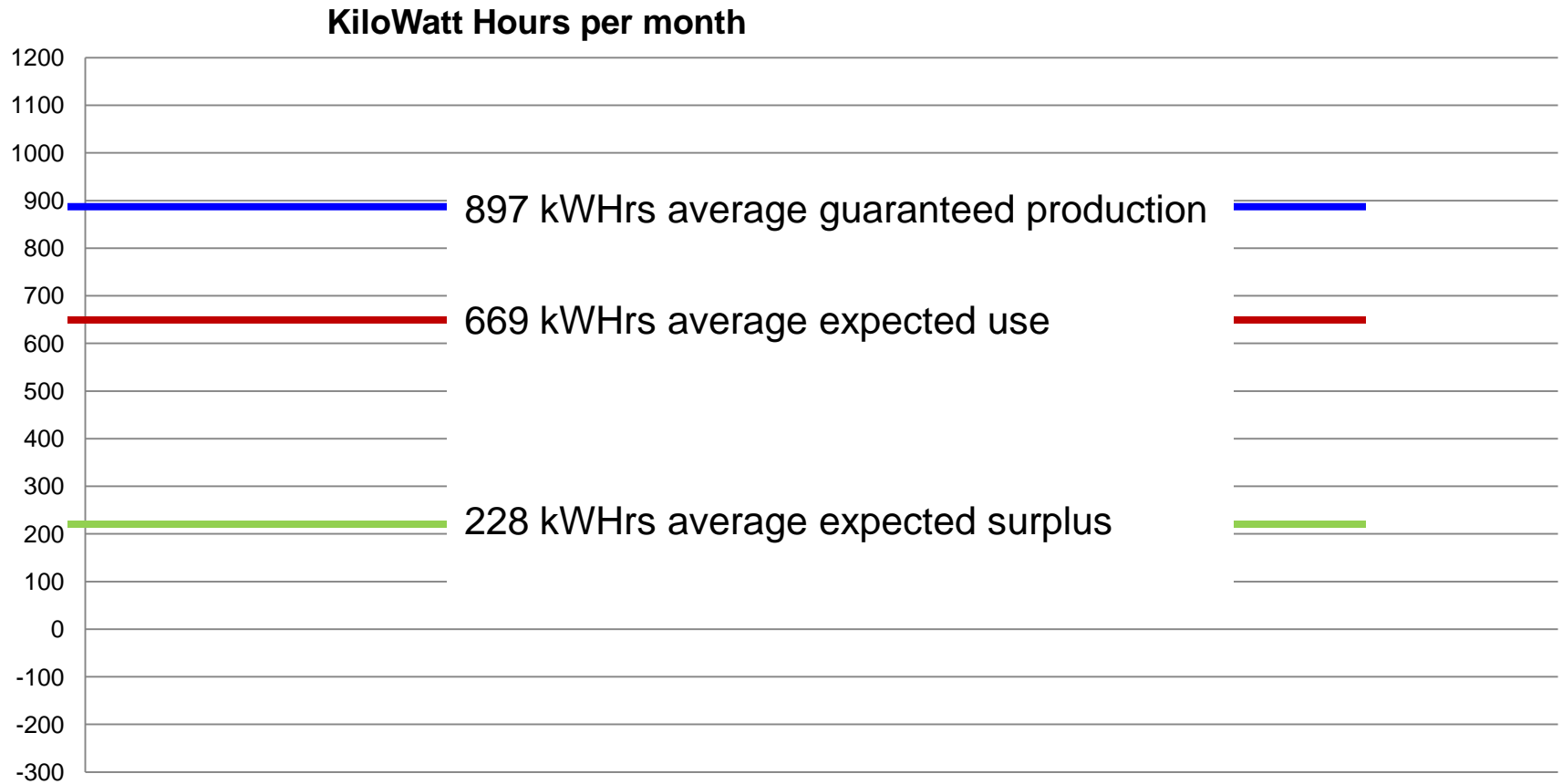

Summary of results to date

Days On	kWHrs from Array daily (F)	kWHrs from WMECO daily (4) (G)	Total kWHrs sent to house (F+G)	kWHrs to WMECO daily (10) (I)	kWHrs Used daily (F+G-I)	kWHrs used Received from Array (F-I)	kWHrs NET WMECO daily (G-I)
66	45	12	58	37	21	9	-25
	3024	928	3757	2455	1352	555	-1608
	79%	21%	100%	64%	36%		
	100%	(\$1.83)		81%	(\$3.10)	19%	\$3.69
	\$10.45	59%		\$5.52	100%	41%	