

The examination of mediating role of distributed leadership in the relationship between school structure and accountability

Mustafa Orhan^{1,*}, Tuncay Yavuz Özdemir²

¹Erzurum Directorate of National Education, Erzurum, Türkiye

²Fırat University, Faculty of Education, Department of Educational Science, Elazığ, Türkiye

ARTICLE HISTORY

Received: June. 03, 2023

Accepted: Dec. 16, 2023

Keywords:

Distributed leadership,

School structure,

Coercive bureaucracy,

Enabling bureaucracy,

Accountability.

Abstract: The aim of this study was to investigate the relationship between school structure, distributed leadership and accountability of school administrators. Relational survey design was adopted in the study. 444 elementary school teachers working in Aziziye, Palandöken and Yakutiye in Erzurum participated in the study. In sample selection, stratified sampling method was used. In data collection, the Enabling School Structure Scale, the Distributed Leadership Scale and the Accountability Behavior Scale for School Administrators were used. The data were analyzed using SPSS 23.0 for preliminary statistical analyses, LISREL 8.80 for Structural Equation Modeling (SEM), and the PROCESS macro for SPSS v3.3 for mediation analyses. In data analysis, Pearson Product-Moment Correlation Analysis, Bootstrap Analysis, and SEM were used. Furthermore, a mediation analysis was conducted to investigate whether distributed leadership played a mediating role in the relationship between school structure and accountability. The results revealed that coercive bureaucracy had a negative effect on accountability and distributed leadership while enabling bureaucracy had a positive effect on accountability and distributed leadership. Furthermore, the analysis revealed a positive effect of distributed leadership on accountability. This study revealed the mediating role of distributed leadership in the effect of coercive and enabling bureaucracy on accountability. In other words, it was found that the coercive and enabling bureaucracy had direct and indirect effects on accountability. Finally, a number of recommendations were made to educators, policy makers and researchers based on these findings.

1. INTRODUCTION

Organizational structure plays a remarkable role in decisions, communication, and performance of employees and managers. This structure enables managers to effectively allocate responsibilities, distribute decision-making authority, coordinate and control the organization's work, and ensure employees are accountable for their actions. By doing so, it supports the organization in achieving its goals. On the other hand, a poorly designed structure may lead to great waste, confusion and frustration for employees, resource providers and users (Bovée & Till, 2012, p.166). Similar to all organizations, schools also have a structure (Sinden et al., 2004,

*CONTACT: Mustafa ORHAN ✉ mustafaorhan2525@hotmail.com 📍 Erzurum Directorate of National Education, Erzurum, Türkiye

p.464). Organizational structure is the formal features or continuing functioning of a school. Structure refers to the relationship between different roles established to achieve educational goals (Miskel, 1979, p.5; Miskel et al., 1979, p.100). It is necessary to establish a harmony between elements such as purpose, environment, technology, people and technology in the organization of the school structure. Some of the school-related problems derive from inappropriate organizational structures and systems (Şişman, 2019, p.207). One of the main elements of more effective schools is that they have a school structure that enables participants to do their work more creatively, collaboratively and professionally (Hoy & Sweetland, 2007, pp.362-363).

Schools need enabling structures rather than coercive ones. In an enabling structure, the authority hierarchy, rules, and procedures serve as mechanisms to support teachers, rather than tools to increase the principal's power. In a coercive structure, teacher behavior is closely monitored and strictly regulated. Accordingly, within a coercive structure, the authority hierarchy, rules, and regulations are employed to enforce compliance, maintain control, and penalize deviations (Hoy, 2003, p.90-91). Furthermore, schools typically possess bureaucratic structures characterized by a hierarchy of authority, division of labor, objective standards, and rules and regulation (Weber, 1947; cited in Hoy & Sweetland, 2001, p.296).

Adler and Borys (1996) examined bureaucracy in two dimensions as enabling and coercive. Hoy and Sweetland (2000, pp.530-531; 2001, s.297-300) dealt with two characteristics of bureaucratic organization: formalization and centralization. Coercive formalization refers to the implementation of rules and procedures that primarily focus on punishing subordinates instead of rewarding productive practices, and it emphasizes compliance rather than fostering organizational learning. Enabling formalization is the rules and procedures that enable employees in completing their tasks and resolving issues effectively. In addition, obstructive centralization refers to a structure and management style that produces obstacles for subordinates in completing their tasks and resolving issues. On the other hand, facilitating centralization encompasses a structure and management approach that enables subordinates to remove obstacles and resolve issues in an effective way (Hoy, 2003, p.89-90). Apparently, the organizational structure guides and helps the organization leaders. Thus, it is important for the managers to lead their organizations in order to reach the goals of the organizations.

Contemporary principals, who had mostly managerial responsibilities in the past, are expected to lead their schools, increase the academic success of students and help the professional development of the staff (Hermann, 2016, p.6). The constant and increasing demands of students, parents and the environment has paved the way for school administrators to question their leadership behaviors. This query resulted in the adoptatipn of different behaviors by school administrators (Cemaloğlu, 2013, p.158). Accordingly, school administrators are required to perform to meet social demands and to lead the school community, as well as being responsible for the accountability of schools.

Accountability refers to determining responsible public officers and holding them accountable for their actions (Kondo, 2002, p.7). In other words, accountability requires a willing or compulsory report given to other people and includes having a conscientious or moral responsibility for the action of a person (Maile, 2002, p.326). In the context of education, accountability pertains to the practice of holding education systems responsible for the quality of their outcomes, including students' knowledge, skills, and behaviors (Stecher & Kirby, 2004, p.1). The most widely accepted definition of accountability consists the implementation of administrative data-driven mechanisms to improve student achievement (Figlio & Loeb, 2011, p.384). The purposes of accountability are basically threefold: First, it controls the abuse of public authority. Second, accountability provides reassurance regarding the utilization of public resources and adherence to legal and public service values. Third, it fosters and promotes a

culture of learning aimed at achieving continuous improvement in public administration. (Aucoin & Heintzman, 2000, p.45).

Traditionally, teachers have been accountable for addressing specific content outlined in the curriculum, students for learning through grading systems, administrators for monitoring student test scores, graduation rates, and other performance indicators such as student attendance in schools and districts. As accountability systems have evolved, states and communities have started to reconsider how to hold students, teachers, and administrators accountable (Stapleman, 2000, p.1). Accountability mechanisms primarily involve holding individuals in schools accountable for their actions to a person in an official authority position, either within or outside the school, through a range of formal and informal methods (Abelmann et al., 1999, p.4). According to Behn (2003a, pp.60-61), education is a shared concern among parents, legislators, governors, supervisors, civil leaders, and ultimately, everyone. Although these factors can both contribute to and detract from children's education, they are not typically held accountable. Behn argued that this is because accountability tends to be focused on others, with schools, principals, and teachers being the easiest targets. Kalman and Gedikoğlu (2014, p.117) defined accountable school administrators as individuals who understand their responsibilities, provide clear information to school stakeholders, and can answer questions regarding school issues. By exhibiting such behaviors, accountable school administrators can cultivate good relationships with teachers and establish trust, contributing to a healthy organizational climate. However, there is currently no research examining the relationship between school structure and accountability. In Türkiye, where the education system is highly centralized, school administrators have limited decision-making opportunities and autonomy (Karataş, 2022, pp.10-12). The impact of centralized school structures on the accountability of school administrators is an area of interest, given the understanding that all decision-makers should be accountable for their actions and decisions (Çiçekli, 2016, p.62). Additionally, distributed leadership may also play a role in influencing the accountability of school administrators.

Distributed leadership is a leadership practice that emerges as a result of interactions between each person contributing to school life, such as teachers, administrators, classroom assistants, support staff, parents and students (Harris, 2005, p.8). Smylie et al. (2007, p.470) explain distributed leadership as the sharing, dissemination and distribution of leadership among individuals and roles within the school. Managing and leading a school alone can be a challenging task for school administrators, especially in the current complex and changing social environment. It is suggested that leadership should be distributed and transformed into a team behavior to overcome these challenges (Beycioğlu & Aslan, 2010, p.766). To the best of the researchers' knowledge, no study has specifically examined the relationship between distributed leadership and accountability. However, these concepts are known to be closely interconnected. According to Elmore (2005, p.141), accountable leadership is synonymous with distributed leadership. As schools establish internal accountability and develop improvement practices, leadership becomes distributed based on expertise. Some teachers possess more knowledge about the teaching challenges their schools face and the solutions to those challenges. Therefore, expertise is necessary to create successful practices across the organization. In distributed leadership, decision-making and problem-solving responsibilities should be distributed according to employees' areas of expertise. The decentralized approach to accountability assumes that school principals should not act as the sole decision-makers but rather involve parents and teachers whose voices are beginning to be heard. This accountability approach requires school leaders to empower these individuals and actively encourage them to share power previously held only by the principal. School principals are expected to act as team members rather than making decisions alone (Leithwood, 2001, p.3).

It is unlikely that anyone has all the knowledge, skills, and abilities to fulfill all leadership functions without distributing them among others, given the increasing complexity of the education system (Hulpia & Devos, 2010, p.565). Distributing leadership among school staff, rather than limiting it to principals or top-level administrators, has a positive effect on student learning outcomes, an important factor in school success (Bell et al., 2003, p.3). In the age of school-based accountability, focusing the responsibility for change and transformation on a single individual, such as a principal, due to workplace pressures and complexity, is no longer effective. Therefore, distributing or sharing leadership among a large number of colleagues can be presented as a solution to excessive role overload (Woods & Gronn, 2009, p.441). However, distributed leadership allows teachers with specific expertise to contribute to the school's decision-making processes. By allowing teachers and other school leaders to contribute to decision-making processes, school principals can provide important leadership experiences to the school's future leaders (Jacobs, 2010, p.13). Additionally, distributed leadership is considered a means of understanding leadership practice in schools, promoting democracy within schools, enhancing efficiency and effectiveness, and developing human capacity (Mayrowetz, 2008). Studies examining the relationship between distributed leadership and school structure indicate a positive relationship between enabling bureaucracy and distributed leadership, while there is a negative relationship between coercive bureaucracy and distributed leadership (Oldaç & Kondakçı, 2020). This relationship suggests a mutual interaction between school structure and distributed leadership. Accordingly, an increase in coercive bureaucracy in schools negatively affects distributed leadership behaviors, while an increase in enabling bureaucracy positively affects distributed leadership behaviors.

Based on the statements and definitions above, it can be investigated whether there is a relationship between the accountability of school administrators, school structure and distributed leadership in educational institutions in Turkey, where the centralist aspect is dominant.

A brief literature review shows that numerous studies have been carried out on school structure, distributed leadership and accountability.

In this context, the school structure has been examined in terms of academic optimism (Anderson, 2012; Çalık & Tepe, 2019; Messick, 2012; Özdemir & Kılınç, 2014), school climate (Jacob, 2003; Mayerson, 2010), school effectiveness (Çalık & Tepe, 2019; Koohi et al., 2019; Mayerson, 2010), organizational support (Çokyigit, 2020), organizational citizenship (Alev, 2019; Messick, 2012), teacher professionalism (Cerit, 2012), teacher self-efficacy (Kılınç et al., 2016), teachers' career satisfaction (Koohi et al., 2019), awareness and teacher empowerment (Watts, 2009), teachers' proactive behaviors (Cerit & Akgün, 2015), student success (Anderson, 2012), organizational trust (Çokyigit, 2020), collective student trust (Koster, 2016), organizational silence (Bozkuş et al., 2019; Demirtaş et al., 2016), school principals' leadership styles (Buluç, 2009), organizational cynicism (Demirtaş, et al., 2016), organizational health (Ordu & Tanrıöğen, 2013), job satisfaction (Bozkuş et al., 2019)

In addition, distributed leadership has been examined in terms of organizational commitment (Aboudahr & Jiali, 2019; Akdemir & Ayık, 2017; Hulpia et al., 2009; Yetim, 2015), organizational trust (Adıgüzelli, 2016; Çiçek, 2018; Yılmaz, 2014), teacher motivation (Wahab et al., 2013), teacher self-efficacy (Halim & Ahmad, 2016; Kurt, 2016), organizational citizenship (Çakır, 2019; Jofreh et al., 2012), organizational support (Yılmaz, 2014), school development and mathematics achievement (Heck & Hallinger, 2009), job satisfaction (Hulpia et al., 2009), job stress (Rabindarang et al., 2014), academic optimism (Ataş Akdemir, 2016; Cansoy & Parlar, 2018; Mascall et al., 2008), school effectiveness (Atılkan, 2019), organizational climate (Çomak, 2021)

Also accountability has been examined in terms of school climate and teacher stress (Nathaniel et al., 2016), organizational justice (Kalman & Gedikoğlu, 2014), organizational silence (Karagöz, 2020), academic freedom (Doğan, 2015), management styles of school administrators (Yağ, 2019), organizational commitment (Yiğit, 2017), organizational cynicism (Argon et al., 2015), servant leadership (Kandemir & Akgün, 2019).

The primary aim of this study is to uncover the mediating role of distributed leadership in the potential relationship between school structure and school administrators' accountability behaviors, based on teacher perceptions. If the hypotheses proposed in this study are confirmed, the effects of school structure on distributed leadership and, indirectly, on accountability would be discerned. Consequently, it is anticipated that interest in the organization of school structure will increase.

There is insufficient evidence to determine whether the school structure has an impact on the distributed leadership behaviors and accountability of school administrators. This study aims to address this gap in the literature and provide potential solutions to the aforementioned issues.

The findings of this study may serve as a valuable resource for improving the school structure to enhance the accountability of school administrators. Furthermore, it may inspire researchers to explore new hypotheses and contribute to expanding the literature on this topic.

The expected outputs stated above have been the motivational elements in the realization of the study. In this study, it is aimed to reveal the predictive and intermediary relationships between the variables of coercive/enabling bureaucracy, distributed leadership and accountability. In this context, the hypotheses developed in line with the general purpose of the research are presented below:

H1: Coercive bureaucracy significantly and negatively predicts accountability.

H2: Coercive bureaucracy significantly and negatively predicts distributed leadership.

H3: Distributed leadership significantly and positively predicts accountability.

H4: Coercive bureaucracy has an indirect influence on accountability through distributed leadership.

H5: Enabling bureaucracy significantly and positively predicts accountability.

H6: Enabling bureaucracy significantly and positively predicts distributed leadership.

H7: Enabling bureaucracy has an indirect influence on accountability through distributed leadership.

The conceptual diagram of Model 1 tested in the study is presented in [Figure 1](#).

Figure 1. The conceptual diagram of Model 1.

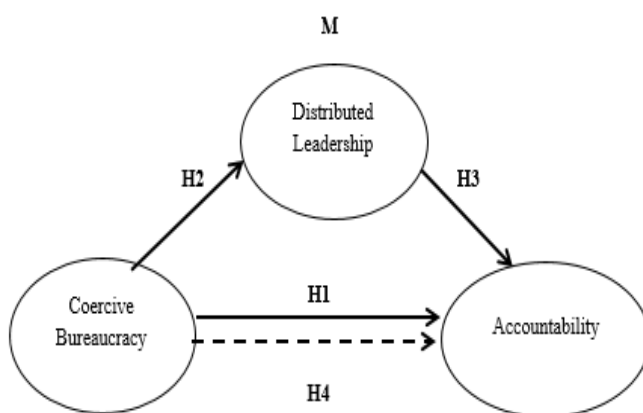

The conceptual diagram of Model 2 tested in the study is shown in [Figure 2](#).

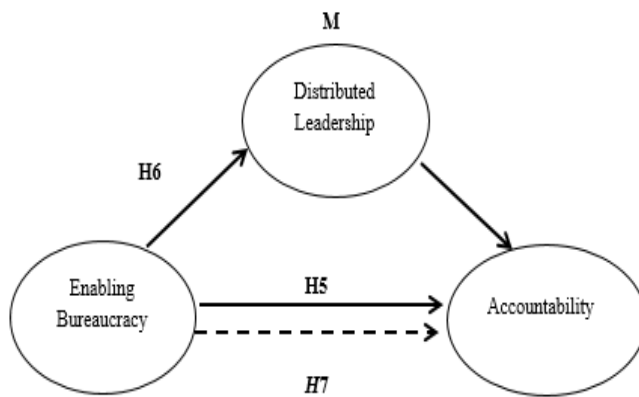
Figure 2. The conceptual diagram of Model 2.

2. METHOD

2.1. Research Model

The primary objective of this study was to explore the predictive and mediating relationships between school structure and the variables of distributed leadership and school administrators' accountability behaviors. To accomplish this, a relational survey model was utilized. The purpose of this model is to evaluate the presence or degree of change between two or more variables (Karasar, 2009, s. 81). The study utilized two models to investigate the relationship between school structure, distributed leadership, and school administrators' accountability. In the first model, coercive bureaucracy was the independent variable, while distributed leadership was both the dependent and independent variable, and accountability was the dependent variable. The second model, on the other hand, had enabling bureaucracy as the independent variable, distributed leadership as the dependent and independent variable, and accountability as the dependent variable.

2.2. Population and Sample

The population of the study consisted of 3171 teachers working in elementary schools in the central districts of Erzurum (Aziziye, Palandöken and Yakutiye) in the 2021-2022 academic year. The proportional stratified sampling method, which is a form of random sampling, was employed for sample selection. Stratified sampling ensures that the subgroups in the universe are represented in the sample with the same proportions in the population (Özen & Gül, 2007, p. 402). Accordingly, the districts of Aziziye, Palandöken and Yakutiye was considered as separate strata. In sample selection, the ratio of the total number of teachers working in elementary schools in each stratum to the total number of teachers in the population was considered. As a result, the sample consisted of 444 teachers, 34 from Aziziye, 201 from Palandöken, and 209 from Yakutiye.

The demographics of the participants are presented in Table 1. Table 1 revealed that of the participants, 273 (61.5%) were female and 171 (38.5%) were male. In addition, the participants' professional seniority was concentrated between 6-10 years (38.1%) and 11-15 years (25.0%), while their working time at the school was focused between 1-5 years (59.0%) and 6-10 years (29.3%). the greatest level of participation in the study, according to discipline, came from teachers in Turkish (17.8%), Social Studies (12.8%), Mathematics (12.6%), and Science (11.5%).

Table 1. *The demographic features of the participants.*

Demographic Characteristics		f	%
Gender	Female	273	61.5
	Male	171	38.5
Work Experience (years)	1-5	71	16.0
	6-10	169	38.1
	11-15	111	25.0
	16-20	54	12.2
	21 and above	39	8.8
Working Time at the School (years)	1-5	262	59.0
	6-10	130	29.3
	11-15	30	6.8
	16-20	16	3.6
	21 and above	6	1.4
Discipline	Turkish	79	17.8
	Mathematics	56	12.6
	Science	51	11.5
	Social Studies	57	12.8
	Religion	47	10.6
	English	45	10.1
	Information Technologies	15	3.4
	Physical Education	23	5.2
	Technology and Design	9	2.0
	Visual Arts	13	2.9
	Music	12	2.7
Arabic	11	2.5	
Guidance and Psychological Counseling	26	5.9	
Total		444	100

2.3. Data Collection Tools

Three different scales were used in data collection: Accountability Behavior Scale for School Administrators (Orhan, 2022), Enabling School Structure Scale (Özer & Dönmez, 2013), Distributed Leadership Scale (Özer & Beycioğlu, 2013). Information on data collection tools is presented below.

2.3.1. Accountability behavior scale for school administrators

The “Accountability Behavior Scale for School Administrators” developed by Orhan (2022) consists of 16 items and has four sub-dimensions: accountability behaviors towards students (5 Items), accountability behaviors towards teachers (3 Items), accountability behaviors towards parents (4 Items), accountability behaviors towards superiors (4 Items). The items were scaled from (1) never to (5) always. The Cronbach’s Alpha, which shows the internal consistency of the scale, was calculated as .922 for the total scale, .862 for the accountability behaviors towards students, .721 for the accountability behaviors towards teachers, .834 for the accountability behaviors towards the parents and .853 for the accountability behaviors towards superiors. In the present study, the Cronbach’s Alpha were found as .851 for the accountability behaviors

towards students, .704 for the accountability behaviors towards teachers, .855 for the accountability behaviors towards the parents, .850 for the accountability behaviors towards superiors, and .922 for the total scale.

2.3.2. Enabling school structure scale

The "Enabling School Structure" scale was originally developed by Hoy and Sweetland (2000) and later adapted into Turkish by Buluç (2009). Its psychometric properties were re-examined by Özer and Dönmez (2013). The scale comprises 12 items and underwent validity and reliability testing, which revealed that the Turkish version consisted of two factors: coercive bureaucracy and enabling bureaucracy. The scale utilizes a 5-Point Likert-type response format, ranging from "never" to "always." In the scale development study, the factor loadings of the items ranged between .557 and .832 for the coercive bureaucracy dimension, and between .485 and .785 for the enabling bureaucracy dimension. The items in the scale accounted for approximately 51% of the total variance. The Cronbach's Alpha values for the scale were .806 for the enabling bureaucracy dimension and .774 for the coercive bureaucracy dimension. In the present study, the internal consistency coefficients were calculated as .715 for the coercive bureaucracy dimension and .848 for the enabling bureaucracy dimension.

2.3.3. Distributed Leadership Scale

The "Distributed Leadership Scale," devised by Özer and Beycioğlu (2013), encompasses 10 items exhibiting a unidimensional structure. The scale employs a 5-Point Likert-type rating system, spanning from "never" to "always." The scale yields a minimum score of 10 and a maximum score of 50. The Cronbach's Alpha coefficient of the scale was determined to be .92, with a test-retest correlation coefficient of .82. In the context of this study, the calculated internal consistency coefficient was .900.

2.4. Data Collection

The data were collected by visiting schools during the first term of the 2021-2022 academic year. Information about the aim and scope of the study was provided, and care was taken to adhere to ethical values during the data collection process. Participation in the study was based on voluntariness. Furthermore, efforts were made to collect data in a manner that would not interrupt the educational process. The data were obtained during teachers' free periods, lunch breaks, and after school hours. Copies of research and application permission letters were provided to schools that requested them. Gratitude was expressed to the school administrators and teachers who took part in the research.

2.5. Data Analysis

The data were analyzed using SPSS 23.0, LISREL 8.80 and PROCESS macro for SPSS v3.3. Before the analyses, outliers, normality, multicollinearity problem and sample size, the prerequisites of the Structural Equation Modelling (SEM), were examined. In the first stage, outliers were examined and 11 outliers were removed from the data set (the absolute values of -3 and 3 were considered based on Z-Score).

In the second stage, the normality of the data was assessed by examining the skewness and kurtosis values. It was observed that the skewness and kurtosis values fell within the range of -1.5 to +1.5, indicating a normal distribution of the data (Tabachnick & Fidell, 2007). The skewness and kurtosis values of the variables are presented in [Table 2](#).

Table 2. The skewness and kurtosis values of the variables.

Scales	Skewness	Kurtosis
Distributed Leadership	-.739	-.234
Accountability towards students	-1.145	.606
Accountability towards teachers	-1.048	-.506
Accountability towards parents	-.650	-.615
Accountability towards superiors	-1.117	.263
Accountability	-.857	-.256
Coercive Bureaucracy	1.154	.927
Enabling Bureaucracy	-.747	.371

Table 2 indicated that the data were normally distributed since the skewness and kurtosis coefficients of the variables were between -1.5 and +1.5.

In the third stage, the multicollinearity problem was examined. The fact that the correlation value between the variables is below .90 indicates that there is no multicollinearity problem (Çokluk et al., 2010, s.210). In order to investigate whether the multivariate normality was provided, the scatter diagram matrix was examined and it was found that the variable pairs formed diagrams similar to ellipse. The findings regarding the correlation between the variables are presented in Table 3.

Table 3. Correlation values between the variables.

	1	2	3	4	5	6	7	8
(1) Distributed Leadership	1	.586	.630	.562	.527	.683	-.369	.457
(2) Accountability towards students		1	.644	.568	.595	.848	-.286	.336
(3) Accountability towards teachers			1	.584	.605	.816	-.295	.345
(4) Accountability towards parents				1	.613	.840	-.274	.293
(5) Accountability towards superiors					1	.841	-.314	.370
(6) Accountability						1	-.348	.399
(7) Coercive Bureaucracy							1	-.346
(8) Enabling Bureaucracy								1

$p < .001$

Table 3 revealed that distributed leadership had a positive and moderate relationship with accountability towards students ($r = .586$, $p < 0.01$), accountability towards teachers ($r = .630$, $p < 0.01$), accountability towards parents ($r = .562$, $p < 0.01$), accountability towards superiors ($r = .527$, $p < 0.01$), the total accountability scale ($r = .683$, $p < 0.01$) and enabling bureaucracy ($r = .457$, $p < 0.01$) and a negative and moderate relationship with coercive bureaucracy ($r = -.369$, $p < 0.01$). Accountability towards students correlated positively and moderately with accountability towards teachers ($r = .644$, $p < 0.01$), accountability towards parents ($r = .568$, $p < 0.01$), accountability towards superiors ($r = .595$, $p < 0.01$) and enabling bureaucracy ($r = .336$, $p < 0.01$), positively and strongly with the total accountability scale ($r = .848$, $p < 0.01$), and negatively and weakly with coercive bureaucracy ($r = -.286$, $p < 0.01$).

Accountability towards teachers had a positive and moderate relationship with accountability towards parents ($r = .584$, $p < 0.01$), accountability towards superiors ($r = .605$, $p < 0.01$), enabling bureaucracy ($r = .345$, $p < 0.01$), a positive and strong relationship with the total accountability scale ($r = .816$, $p < 0.01$), and negative and weak relationship with coercive bureaucracy ($r = -.295$, $p < 0.01$).

Accountability towards parents had a positive and moderate relationship with accountability towards superiors ($r=.613, p<0.01$), a positive and strong relationship with the total accountability scale ($r=.840, p<0.01$) a positive and weak relationship with enabling bureaucracy ($r=.293, p<0.01$) and a negative and weak relationship with coercive bureaucracy ($r=-.274, p<0.01$). Accountability towards superiors correlated positively and strongly with the total accountability scale ($r=.841, p<0.01$), positively and moderately with enabling bureaucracy ($r=.370, p<0.01$), and negatively and moderately with coercive bureaucracy ($r=-.314, p<0.01$). The total accountability scale had a negative and moderate relationship with coercive bureaucracy ($r=-.348, p<0.01$) and a positive and moderate relationship with enabling bureaucracy ($r=.399, p<0.01$). The coercive bureaucracy had a negative and moderate relationship with enabling bureaucracy ($r=-.346, p<0.01$).

In the fourth stage, the sufficiency of the sample size was examined. It was stated in the literature that the sample size should be at least five or even ten times the number of the items. (Bryman & Cramer, 2001; cited in Tavşancıl, 2002, p.17). Accordingly, the sample of the study, in which 444 participants were included, were sufficient since there were a total 38 items in the study.

Finally, SEM analysis was performed to test the mediating effect of distributed leadership on the effect of coercive/enabling bureaucracy on accountability. In order for the mediating effect of distributed leadership to be significant in the effect of coercive/enabling bureaucracy on accountability, the followings were required:

The effect of the independent variable of coercive/enabling bureaucracy on the mediating variable of distributed leadership (Path A) and the effect of the mediating variable of distributed leadership on accountability (Path B) should be significant. The effect of the independent variable of coercive/enabling bureaucracy on the dependent variable of accountability (Path C) should be significant.

Finally, when the model is run, the effect of the independent variable of coercive/enabling bureaucracy on the dependent variable of accountability (Path C) should lose statistical significance or there should be a significant decrease in the level of this effect (Baron & Kenny, 1986).

Paths in the model are shown in [Figure 3](#).

Figure 3. Paths in the model.

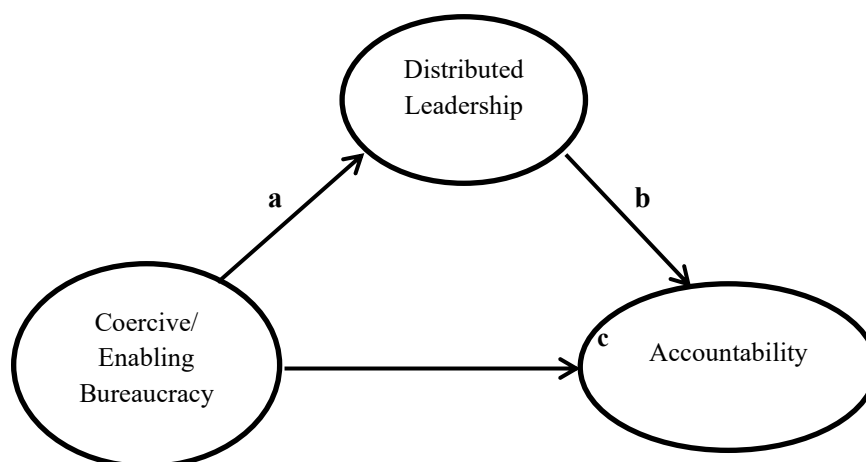

In the study, the figures presented for the structural equation model were generated using an online diagram software (diagrams.net).

2.5.1. Testing the measurement model

The measurement model for Model 1 in the study was tested (Figure 4), and the findings are presented in Table 4.

Figure 4. The measurement model for Model 1.

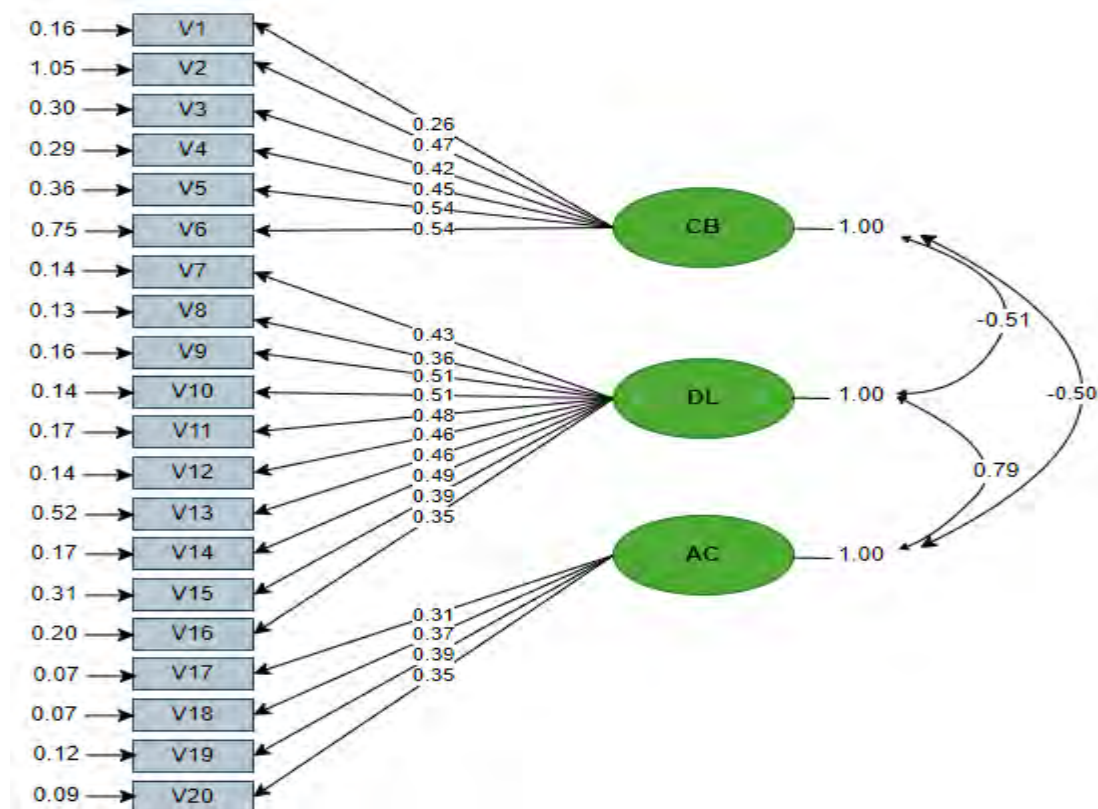

Findings on the testing Model 1 are presented in Table 4.

Table 4. Fit indices for Model 1.

χ^2/sd	AGFI	GFI	SRMR	CFI	RMSEA	NFI	NNFI
3.53	.85	.88	0.053	0.97	0.076	0.95	0.96

It was found that Model 1 in the study had acceptable fit indices (Browne & Cudeck, 1993; Meydan & Şeşen, 2011; Schermelleh-Engel et al., 2003; Sümer, 2000). Thus, in the later stage the structural equation modelling was tested.

The measurement model for Model 2 in the study was tested (Figure 5), and the findings are presented in Table 5.

Figure 5. The measurement model for Model 2.

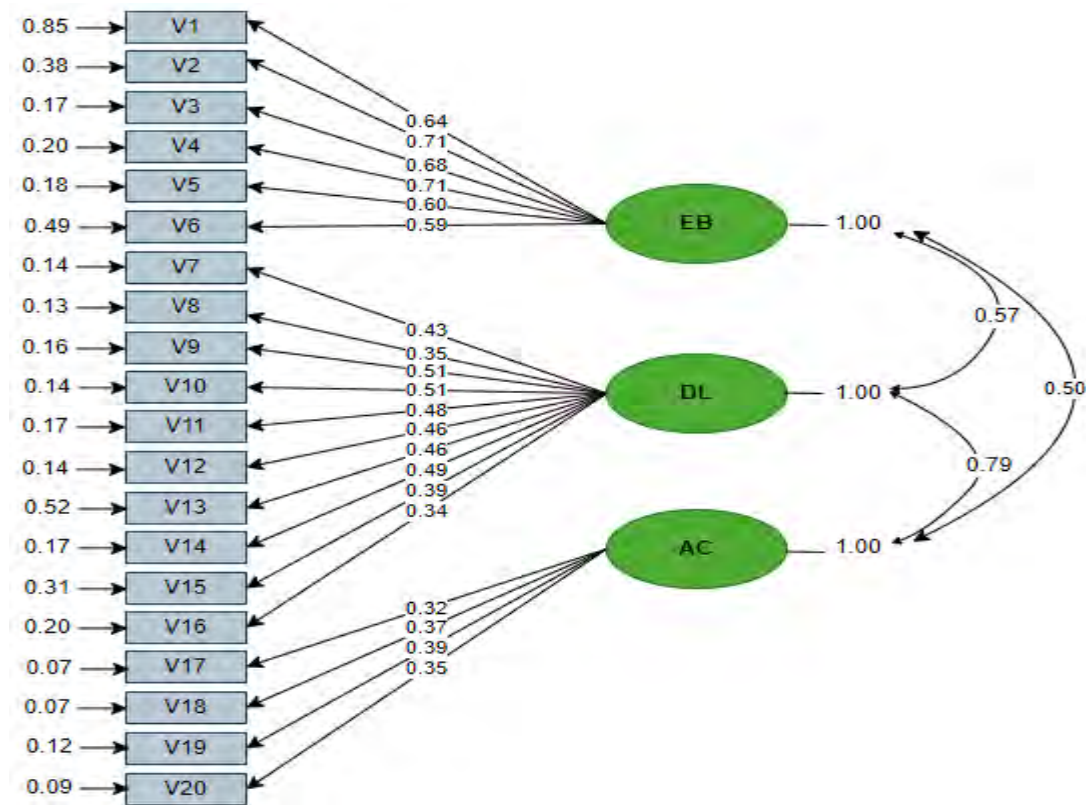

Findings on the testing the second measurement model are presented in Table 5.

Table 5. Fit indices for Model 2.

χ^2/sd	AGFI	GFI	SRMR	CFI	RMSEA	NFI	NNFI
3.70	0.85	0.88	0.052	0.97	0.078	0.96	0.97

It was found that the second measurement model in the study had acceptable fit indices (Browne & Cudeck, 1993; Meydan & Şeşen, 2011; Schermelleh-Engel et al., 2003; Sümer, 2000). Thus, in the later stage the structural equation modelling was tested.

3. FINDINGS

3.1. Findings on Model 1

3.1.1. The mediating role of distributed leadership in the relationship between coercive bureaucracy and accountability

First, it was found that the coercive bureaucracy had a negative and significant ($t=-11.68, p<0.01$) effect ($\beta=-0.69$) on accountability. Then, the coercive bureaucracy was found to have a negative and significant ($t=-9.21, p<0.01$) effect ($\beta=-0.52$) on distributed leadership. Similarly, it was found that distributed leadership had a positive and significant ($t=13.46, p<0.01$) effect ($\beta=0.80$) on accountability. These findings indicated that the model was suitable for the mediation test. Accordingly, the mediating role of distributed leadership in the relationship between coercive bureaucracy and accountability was examined. The figures presented for the structural equation model in the study were created using online diagram software (diagrams.net). Findings on Model 1 are presented in Figure 6.

Figure 6. Findings on Model 1.

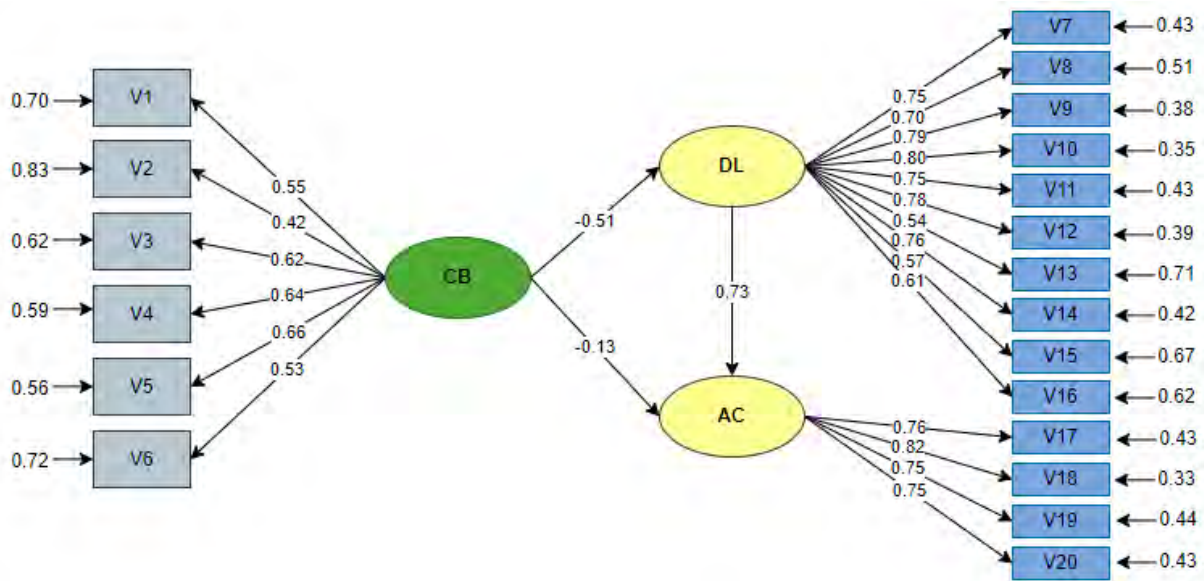
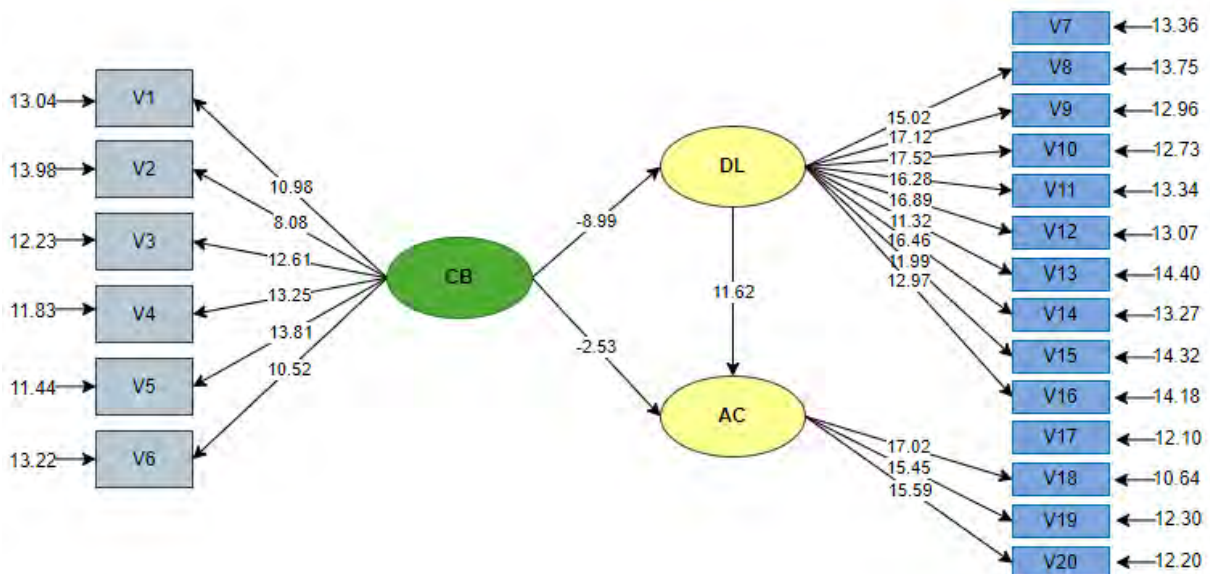

Figure 6 showed that before the model was run, there was an almost strong, negative and significant relationship between coercive bureaucracy and accountability ($\beta=-0.69, p<0.01$), and this relationship decreased after the model ($\beta=-0.13, p<0.05$); however this and other predictive relationships did not lose statistical significance. This finding revealed that distributed leadership had a mediating role in the relationship between coercive bureaucracy and accountability. Accordingly, the first four hypotheses of the study were confirmed. The fit indices of the model were found to be $\chi^2/sd = 3.53$, AGFI=0.85, GFI=0.88, SRMR=0.053, CFI=0.97, RMSEA=0.076, NFI=0.95, NNFI=0.96, which was at an acceptable level. Figure 7 shows t values of the model.

Figure 7. T-values of Model 1.



To investigate the significance of the mediating role of distributed leadership (H4) in the relationship between coercive bureaucracy and accountability, bootstrap analysis was conducted using PROCESS v3.3 Model 4. A sample size of 5,000 participants was utilized to examine the direct and indirect effects (Preacher & Hayes, 2008). The results and corresponding confidence intervals (CI) are presented in Table 6.

Table 6. Bootstrap analysis results on predictive effects in Model 1.

Paths	Prediction Coefficient	<i>t</i>	<i>p</i>	R ²	95 % CI	
					Lower	Upper
Coercive Bureaucracy ▼ Distributed Leadership	-.3283	-8.34	.0000	.14	-.4056	-.2510
Coercive Bureaucracy ▼ Accountability	-.0822	-2.98	.0030	.48	-.1364	-.0281
Distributed Leadership ▼ Accountability	.5377	17.35	.0000		.4768	.5985
Diret Effects		Effect Coefficient		95 % CI		
Coercive Bureaucracy ▼ Accountability	-.0822	-2.98	.0030		-.1364	-.0281
Indirect Effects						
C. B. ▼D. L. ▼ Accountability.	-.1765				-.2260	-.1316
Total Effect						
Coercive Bureaucracy ▼ Accountability	-.2587	-7.79	.0000		-.3240	-.1935

As shown in Table 6, coercive bureaucracy predicted distributed leadership ($\beta = -.3283$, $p < .01$) and explained 14% of the variance in distributed leadership. It was also found that coercive bureaucracy significantly predicted accountability ($\beta = -.0822$, $p < .01$), and distributed leadership predicted accountability statistically ($\beta = .5377$, $p < .01$). Coercive bureaucracy and distributed leadership explained approximately 48% of the variance in accountability.

The findings revealed that the direct effect of coercive bureaucracy on accountability ($-.0822$) was significant since the 95% confidence interval for the observed values did not encompass zero, which revealed statistical significance ($-.1364 < -.0281$, $t = -2.98$, $p > 0.01$).

The indirect effect of coercive bureaucracy on accountability through distributed leadership ($-.1765$) was significant since the 95% confidence interval for the observed values did not encompass zero ($-.2260 < -.1316$). The sum of the direct and indirect effects of the coercive bureaucracy on accountability ($-.2587$) was also significant since the 95% confidence interval for the observed values did not encompass zero ($-.3240 < -.1935$, $t = -7.79$, $p < 0.01$).

3.2. Findings on Model 2

3.2.1. The mediating role of distributed leadership in the relationship between enabling bureaucracy and accountability

First, it was found that the enabling bureaucracy had a positive and significant ($t = 9.92$, $p < 0.01$) effect ($\beta = 0.54$) on accountability. The, enabling bureaucracy was found to have a positive and significant ($t = 10.83$, $p < 0.01$) effect ($\beta = 0.57$) on distributed leadership. It was also found that distributed leadership had a positive and significant ($t = 13.46$, $p < 0.01$) effect ($\beta = 0.80$) on accountability. These findings indicated that the model was suitable for the mediation test. Accordingly, the mediating role of distributed leadership in the relationship between enabling bureaucracy and accountability was examined. The findings on Model 2 is presented in Figure 8.

Figure 8. The findings on Model 2.

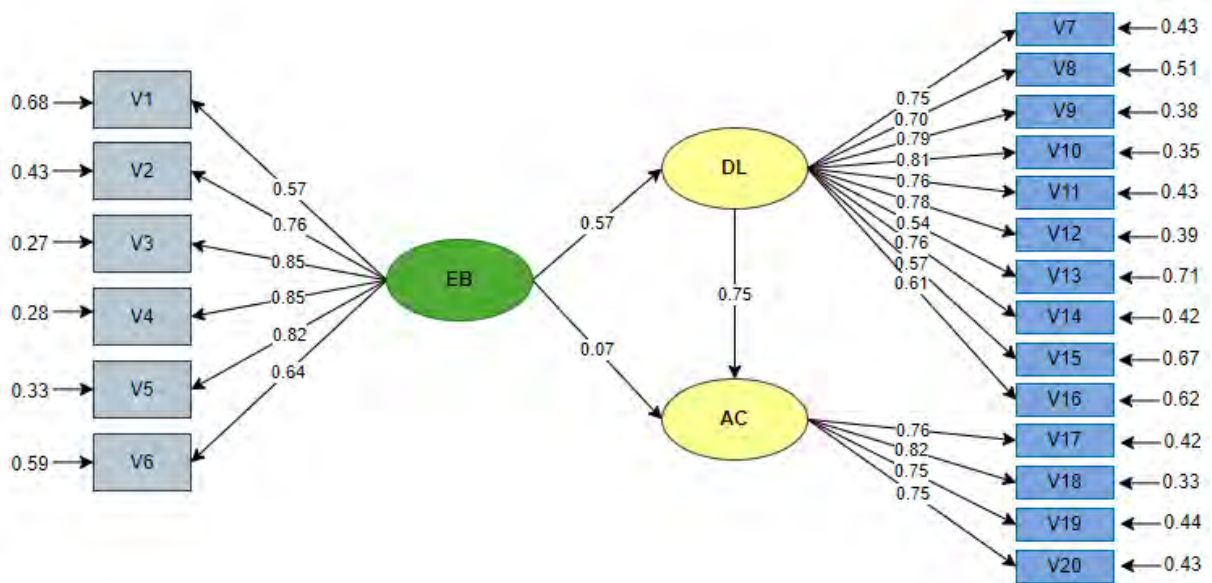
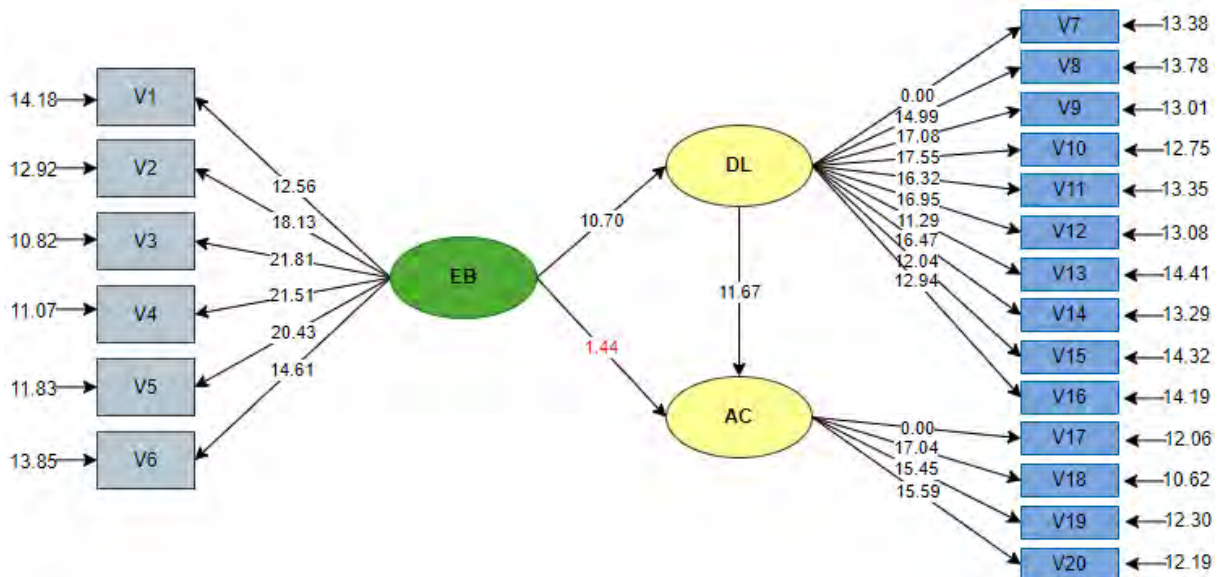

Figure 8 showed that there was a moderate, positive, and statistically significant relationship between enabling bureaucracy and accountability prior to running the model ($\beta= 0.54, p<0.01$), and this relationship lost statistical significance after the model ($\beta= 0.07, p>0.05$). Other paths related to the model maintained their significance. This finding shows that distributed leadership has a full mediating role in the relationship between enabling bureaucracy and accountability. Accordingly, the last three hypotheses of the study were also confirmed. The fit indices for the model were as follows: $\chi^2/sd=3.70$, AGFI=0.85, GFI=0.88, SRMR=0.052, CFI=0.97, RMSEA=0.078, NFI=0.96, NNFI=0.97, which was at an acceptable level. The *t* values of the Model 2 are presented in Figure 9.

Figure 9. *t*-values of Model 2.



Bootstrap analysis was performed using PROCESS v3.3 Model 4 in order to examine whether the mediating role of distributed leadership (H7) was significant in the relationship between enabling bureaucracy and accountability in a sample of 5,000 people, and to examine its direct and indirect effects (Preacher & Hayes, 2008). The findings and confidence intervals (CI) are presented in Table 7.

Table 7. Bootstrap analysis results on predictive effects in Model 2.

Paths	Prediction Coefficient	<i>t</i>	<i>p</i>	R ²	95 % CI	
					Lower	Upper
Enabling Bureaucracy ▼ Distributed Leadership	.3117	10.79	.0000	.21	2550	3684
Enabling Bureaucracy. ▼ Accountability	.0626	2.83	.0048	.48	.0192	.1061
Distributed Leadership ▼ Accountability	.5298	16.35	.0000		.4662	.5935
Direct Effects	Effect Coefficient				95 % CI	
E. B. ▼ Accountability	.0626	2.83	.0048		.0192	.1061
Indirect Effects						
E. B. ▼ D. L. ▼ Accountability.	.1651				.1271	.2064
Total Effect						
E. B. ▼ Accountability	.2278	9.15	.0000		.1789	.2767

Table 7 revealed that the enabling bureaucracy predicted the distributed leadership ($\beta = .3117$, $p < .01$), and explained 21% of the variance in the distributed leadership.

It was also found that enabling bureaucracy significantly predicted accountability ($\beta = .0626$, $p < .01$) and distributed leadership significantly predicted accountability ($\beta = .5298$, $p < .01$). Enabling bureaucracy and distributed leadership explained approximately 48% of the variance in accountability.

The findings revealed that the direct effect of enabling bureaucracy on accountability (.0626) %95 was significant since the 95% confidence interval for the observed values did not encompass zero (.0192 < .1061, $t = 2.83$, $p > .01$),

The indirect effect of enabling bureaucracy on accountability through distributed leadership (.1651) was significant since the 95% confidence interval for the observed values did not encompass zero (.1271 < .2064). The sum of the direct and indirect effects of the enabling bureaucracy on accountability (.2278) was also significant since the 95% confidence interval for the observed values did not encompass zero (.1789 < .2767, $t = 9.15$, $p < .01$).

4. DISCUSSION and CONCLUSION

In this study, the relationships between coercive/enabling bureaucracy, distributed leadership and accountability were examined and the mediating role of distributed leadership in this relationship was analyzed. The findings revealed that all 7 hypotheses proposed in the study were confirmed.

First, it was found that coercive bureaucracy had a negative effect on accountability, while enabling bureaucracy affected accountability positively. A significant negative relationship was observed between coercive bureaucracy and accountability, while a strong and statistically meaningful association was found between enabling bureaucracy and accountability. In other words, an increase in coercive bureaucracy decreased accountability, whereas an increase in enabling bureaucracy increased accountability. Although there is no study on the relationship between school structure and accountability, there are some studies investigating common variables. For example, Kim (2005), Turner (2018) and Arik (2021) reported a strong and statistically meaningful association between organizational justice and school structure. In addition, Kalman and Gedikoğlu (2014) found that there was a strong and statistically meaningful association between organizational justice and the accountability of school

administrators. These findings suggest that the increase in school structure and accountability increases organizational justice.

Another common variable between school structure and accountability is school climate. While Jacob (2003) found that there was not a significant relationship between school climate and school structure, Nathaniel et al. (2016) reported a negative relationship between school climate and exam-based accountability policies. This finding indicates that the increase in exam-based accountability policies increases negative perceptions about the school climate.

Organizational cynicism is also a common variable between school structure and accountability. Demirtaş et al. (2016) and Karaoğlan (2019) found that there was a positive association between organizational cynicism and bureaucratic school structure. However, Argon et al. (2015) reported a negative relationship between organizational cynicism and accountability practices in the Turkish National Education System. Accordingly, it can be argued that the increase in the bureaucratic school structure increases organizational cynicism, while the increase in accountability practices reduces organizational cynicism.

Furthermore, the analysis revealed that coercive bureaucracy had a negative impact on distributed leadership, while enabling bureaucracy exerted a positive influence on distributed leadership. Consequently, a negative and significant relationship between coercive bureaucracy and distributed leadership was established, along with a positive and significant relationship between enabling bureaucracy and distributed leadership. In other words, the increase in the coercive bureaucracy decreased the distributed leadership behaviors, whereas the increase in the enabling bureaucracy increased the distributed leadership behaviors. Accordingly, coercive bureaucracy had a negative effect on distributed leadership, while enabling bureaucracy affected distributed leadership positively. Similar to the present study, Oldaç and Kondakçı (2020) found a positive association between enabling bureaucracy and distributed leadership, and a negative relationship between coercive bureaucracy and distributed leadership.

While limited research exists specifically on the relationship between school structure and distributed leadership, several studies have explored these variables independently. For example, Messick (2012), Mitchell (2019) and Alev (2019) found a strong and statistically meaningful association between organizational citizenship and school structure. Furthermore, Jofreh et al. (2012) and Çakır (2019) revealed a strong and statistically meaningful association between organizational citizenship and distributed leadership. These findings indicate that the increase in school structure and distributed leadership increases organizational citizenship.

A common variable related to school structure and distributed leadership is academic optimism. McGuigan and Hoy (2006), Messick (2012), Özdemir and Kılınç (2014), Anderson et al. (2018), and Çalık and Tepe (2019) reported a positive and significant relationship between academic optimism and school structure. In addition, Mascall et al. (2008), Ataş Akdemir (2016), and Cansoy and Parlar (2018) found a strong and statistically meaningful association between academic optimism and distributed leadership. These findings reveal that the increase in school structure and distributed leadership increases academic optimism.

Job satisfaction is another common variable related to school structure and distributed leadership. In this sense, Bozkuş et al. (2019) found a weak and positive relationship between job satisfaction and enabling school structure. In addition, Ereş and Akyürek (2016) also reported a positive association between job satisfaction and distributed leadership characteristics of school principals. These findings indicate that the increase in school structure and distributed leadership increases job satisfaction.

Another common variable related to school structure and distributed leadership is organizational citizenship. In this sense, Mitchell (2019) found a strong and statistically meaningful association between organizational citizenship and enabling school structure.

However, Jofreh et al. (2012) and Çakır (2019) revealed a strong and statistically meaningful association between distributed leadership and organizational citizenship. These findings suggest that the increase in school structure and distributed leadership increases organizational citizenship.

Another common variable related to school structure and distributed leadership is teacher self-efficacy. Kılınç et al. (2016) found a strong and statistically meaningful association between teacher self-efficacy and school structure. Similarly, Kurt (2016) and Halim and Ahmad (2016) reported a strong and statistically meaningful association between teacher self-efficacy and distributed leadership. These findings show that the increase in school structure and distributed leadership increases teacher self-efficacy.

Organizational trust is another variable related to school structure and distributed leadership. In this sense, Geist (2002) and Çokyiğit (2020) found a strong and statistically meaningful association between organizational trust and school structure. In addition, Adıgüzelli (2016), Çiçek (2018) and Yılmaz (2014) revealed a strong and statistically meaningful association between organizational trust and distributed leadership. These findings indicate that the increase in school structure and distributed leadership increases organizational trust.

Organizational support is another variable related to school structure and distributed leadership. Çokyiğit (2020) found a strong and statistically meaningful association between organizational support and school structure. Similarly, Yılmaz (2014) revealed a strong and statistically meaningful association between organizational support and distributed leadership. These findings show that the increase in school structure and distributed leadership increases organizational support.

School effectiveness is another variable related to school structure and distributed leadership. In this issue, Gray (2016) and Çalık and Tepe (2019) reported a strong and statistically meaningful association between school effectiveness and school structure. Also, Atıkan (2019) found a strong and statistically meaningful association between school effectiveness and distributed leadership. These findings indicate that the increase in school structure and distributed leadership increases school effectiveness.

Who will be held accountable in schools, which issues will be accounted for, and who will be accountable have been the most debated issues. Argon (2015) found that teachers and administrators attributed the same meaning to accountability stating that everyone working in schools should be accountable. In addition, Koçak and Nartgün (2018) stated that besides teachers, school administration, parents and students should be accountable at schools. Based on these findings, it can be argued that all stakeholders should be held responsible for school accountability, which is actually related to distributed leadership. It is known that the effective performance of school leadership, which has become quite complex and difficult nowadays, is possible by distributing leadership authorities. Therefore, school administrators can distribute their authority to employees in order to spread accountability throughout the school and in turn position them as stakeholders of accountability. In other words, it can be said that it is consistent to hold the employees, who can participate in the decisions taken or take the initiative, accountable for their actions. In this sense, Behn (2003b, p.68) stated that if organizational managers do not distribute some of their authority to their assistants in managerial issues and if they want that every action should be asked to them, they cannot hold their assistants accountable.

Third, it was found that distributed leadership positively affected accountability. In other words, the increase in distributed leadership increased accountability. It was concluded in this study that there was a significant relationship between school administrators' distributed leadership behaviors and their accountability behaviors. Elmore (2005, p.141) states that accountable

leadership is actually distributed leadership and as schools are successful in ensuring internal accountability and schools have become places where leadership is distributed based on expertise, if schools ensure internal accountability and developing practices to improve it. Performance-based accountability and good management practices in schools generally require that particular individuals are held accountable for the guidance, management and ultimately performance of the organization. In this sense, administration leaders should aim primarily to develop the knowledge and skills of the people in the organization, create a culture of common expectation around the use of these skills and knowledge, keep the organization as a whole to be productive, and hold individuals accountable for contributing to the collective result (Elmore, 2000, p.15). Accordingly, school administrators should provide employees the opportunity to use their knowledge and skills in the school environment and empower them, and in turn position them as the addressee of school accountability. The decentralized approach to accountability proposes that the role of school leaders is to empower parents and teachers and encourage them to share the power previously used by the school principal (Leithwood, 2001, p.3).

Although there is no study examining the relationship between distributed leadership and accountability of school administrators, studies, in which related variables were examined, support the positive relationship between distributed leadership and accountability. In this sense, Yetim (2015), Akdemir and Ayık (2017) and Aboudahr and Jiali (2019) showed that there was a strong and statistically meaningful association between organizational commitment and distributed leadership. Besides, Yiğit (2017) found a strong and statistically meaningful association between organizational commitment and accountability. The findings unveiled a noteworthy positive association between organizational commitment and both distributed leadership and accountability, which supports the significant positive relationship between distributed leadership and accountability behaviors of school administrators.

Another variable related to distributed leadership and accountability is school improvement/academic quality and mathematics achievement. In this sense, Heck and Hallinger (2009) concluded that distributed leadership had a direct effect on the change in the academic capacity of schools and indirect effects on students' mathematical development. Furthermore, Chang's (2011) found that distributed leadership had an indirect effect on student achievement. In addition, Rockoff and Turner (2010) showed that the pressure of accountability significantly increased student achievement in English and especially mathematics courses in low-performing schools. Also, it was found in the same study that the satisfaction of the parents of the children in these schools with the academic quality increased significantly. Based on these findings, the significant relationship between school development/academic quality and mathematics achievement and distributed leadership and accountability supports the significant positive relationship between distributed leadership and accountability behaviors of school administrators.

Another variable related to distributed leadership and accountability is job stress. In this sense, Rabindarang et al. (2014) reported a significant and negative relationship between job stress and distributed leadership. Accordingly, it can be said that the increase in distributed leadership behaviors reduces job stress. In addition, Nathaniel et al. (2016) found that there was a positive association between job stress and exam-based accountability policies. Based on this finding, it can be said that the increase in exam-based accountability policies increases job stress. Similarly, Mitani's (2018) found that No Child Left Behind sanctions were positively correlated with job stress, turnover rates, and transfer rates of school principals. Based on these results, the significant and negative relationship between job stress and distributed leadership, and the significant positive relationship between job stress and accountability do not support the

significant positive relationship between distributed leadership and accountability behaviors of school administrators found in the present study.

Another variable related to distributed leadership and accountability is school climate. Harrison (2005) stated that distributed leadership led to a positive learning environment and paved the way for teachers and students to be satisfied with the school. In addition, Çomak (2021) found that there was a positive association between school climate and distributed leadership. These findings suggest that the increase in distributed leadership behaviors increases the positive perceptions of the school climate. On the other hand, Nathaniel et al. (2016) found that there was a negative relationship between school climate and exam-based accountability policies. Accordingly, it can be said that the increase in exam-based accountability policies plays a role in the negative perceptions regarding the school climate. These studies revealed that the significant positive relationship between school climate and distributed leadership, and the significant and negative relationship between school climate and accountability are not lime with the significant positive relationship between distributed leadership and accountability behaviors of school administrators.

5. LIMITATIONS and SUGGESTIONS

Based on the results of this study, the following suggestions were made to educators, policy makers and researchers:

While this study provides significant insights, it only includes a sample of teachers from a single province in eastern Turkey. Therefore, the findings cannot be generalized to other provinces or regions. It is necessary to conduct further studies in different educational contexts to support and replicate the current findings. Additionally, more research is required to clarify the relationships between the variables discussed in the study. Researchers are advised to carry out similar studies in diverse educational contexts using different quantitative methods to uncover the relationships between school structure, distributed leadership, and accountability behaviors of school administrators more precisely. Conducting comparable studies in diverse cultural settings may also help to extend or limit research findings to wider contexts. In addition, this study involved teachers, and the findings were limited to the items in the data collection tools. Another limitation of this study is its cross-sectional design, which prevents it from establishing cause-effect relationships and limits it to being purely descriptive. Therefore, longitudinal studies are needed for more reliable results. However, based on the study's findings, it is crucial for school administrations to encourage teachers to take on responsibilities beyond their classrooms, alongside their teaching roles, and operate within the limits of their expertise. Potential stumbling blocks to a more democratic, participatory and free administrative structure of schools should be removed and professional development programs should be organized for school administrators. An education policy that will encourage school administrators to distribute their duties and responsibilities with teachers based on their knowledge, experience and expertise should be implemented. A performance evaluation approach in which all school stakeholders are responsible and accountable for the success performance of schools should be adopted. In this sense, a performance evaluation approach should be adopted in which teachers can have a say in the decision-making mechanisms and take responsibility in schools. Accordingly, legal measures should be taken.

Acknowledgments

This study was produced from Mustafa Orhan's PhD thesis titled "The examination of mediating role of distributed leadership in the relationship between school structure and accountability" under the supervision of Assoc. Prof. Dr. Tuncay Yavuz Özdemir.

Declaration of Conflicting Interests and Ethics

The authors declare no conflict of interest. This research study complies with research publishing ethics. The scientific and legal responsibility for manuscripts published in IJATE belongs to the authors. **Ethics Committee Number:** Firat University, Social Sciences and Humanities Research Ethics Committee, 29/07/2019-340737.

Authorship Contribution Statement

Mustafa Orhan: Investigation, Resources, Methodology, Software, Formal Analysis, and Writing-original draft. **Tuncay Yavuz Özdemir:** Supervision, Visualization, and Validation.

Orcid

Mustafa Orhan  <https://orcid.org/0000-0002-6254-6733>

Tuncay Yavuz Özdemir  <https://orcid.org/0000-0002-5361-7261>

REFERENCES

- Abelmann, C., Elmore, R., Even, J., Kenyon, S., & Marshall, J. (1999). *When accountability knocks, will anyone answer?*. CPRE Policy Briefs.
- Aboudahr, S.M.F.M., & Jiali, L. (2019). The relationship between distributed leadership and teachers' organizational commitment in Guangzhou city, China. *J. Educ. Manage. Stud.*, 9(1), 1-5. <http://jems.science-line.com>
- Adıgüzelli, Y. (2016). Examining the relationship between distributed leadership and organizational trust according to opinions of teachers. *Education & Science*, 41(185), 269–280. <https://doi.org/10.15390/EB.2016.6218>
- Adler, P.S., & Borys, B. (1996). Two types of bureaucracy: Enabling and coercive. *Administrative Science Quarterly*, 41(1), 61-89. <http://www.jstor.org/stable/2393986>
- Akdemir, Ö.A., & Ayık, A. (2017). The impact of distributed leadership behaviors of school principals on the organizational commitment of teachers. *Universal Journal of Educational Research*, 5(12), 18–26. <https://doi.org/10.13189/ujer.2017.051402>
- Alev, S. (2019). Kolaylaştırıcı okul yapısı ve örgütsel vatandaşlık davranışları arasındaki ilişkinin incelenmesi [Examination of relationship between enabling school structure and organizational citizenship behaviors]. *Uluslararası Toplum Araştırmaları Dergisi*, 10(17), 420-443. <https://doi.org/10.26466/opus.518009>
- Anderson, K. (2012). *Examining relationships between enabling structures, academic optimism and student achievement* [Unpublished doctoral dissertation]. Auburn University.
- Anderson, K., Kochan, F., Kensler, L.A., & Reames, E.H. (2018). Academic optimism, enabling structures, and student achievement: Delving into relationships. *Journal of school leadership*, 28(4), 434-461.
- Argon, T. (2015). Teacher and administrator views on school principals' accountability. *Educational Sciences: Theory and Practice*, 15(4), 925-944. <https://doi.org/10.12738/estp.2015.4.2467>
- Argon, T., Uylas, S.D., & Yerlikaya, S. (2015). Perceptions of teachers related accountability practices in Turkish national education system and organizational cynicism. *International Online Journal of Educational Sciences*, 7(2), 204-219. <http://dx.doi.org/10.15345/iojes.2015.02.016>
- Arik, S. (2021). The predictive powers of organizational trust and justice on enabling school structure: A structural equation modelling approach. *African Educational Research Journal*, 9(2), 449-460. <https://doi.org/10.30918/AERJ.92.21.044>
- Ataş Akdemir, Ö. (2016). Öğretmen algılarına göre okul yöneticilerinin dağıtımcı liderlik davranışlarının okulların akademik iyimserlikleri ile örgütsel bağlılık ve okul başarısıyla ilişkisi [The relationship of distributed leadership behaviours of school principals with

- schools' academic optimism and organizational commitment and school achievement according to teacher perceptions*] [Unpublished doctoral thesis]. Atatürk University.
- Atılkan, N. (2019). *Okul müdürünün dağıtımci liderlik davranışları ile okulların etkililiği arasındaki ilişkinin incelenmesi* [Relationship between school principals's distributed leadership behaviors and school effectiveness] [Unpublished master thesis]. Karabük University.
- Aucoin, P., & Heintzman, R. (2000). The Dialectics of Accountability for Performance in Public Management Reform. *International Review of Administrative Sciences*, 66(1), 45–55. <https://doi.org/10.1177/0020852300661005>
- Baron, R.M., & Kenny, D.A. (1986). The moderator–mediator variable distinction in social psychological research: Conceptual, strategic, and statistical considerations. *Journal of Personality and Social Psychology*, 51(6), 1173-1182. <https://doi.org/10.1037/0022-3514.51.6.1173>
- Behn, R.D. (2003a). Rethinking accountability in education: How should who hold whom accountable for what? *International Public Management Journal*, 6(1), 43-73.
- Behn, R.D. (2003b). *Demokratik hesap verme sorumluluğu* [Rethinking democratic accountability]. (Çev: Paradigma Tercüme Ltd. Şti). Arı Yayıncılık.
- Bell, L., Bolam, R., & Cubillo, L. (2003). *A systematic review of the impact of school headteachers and principals on student outcomes*. EPPI-Centre.
- Beycioğlu, K., & Aslan, B. (2010). Öğretmen liderliği ölçeği: Geçerlik ve güvenirlik çalışması [Teacher leadership scale: A validity and reliability Study]. *İlköğretim Online*, 9(2), 764-775.
- Bové, C.L., & Till, J.V. (2012). *Business in action* (6th ed.). Pearson Education.
- Bozkuş, K., Karacabey, M.F., & Özdere, M. (2019) Okulun kolaylaştırıcı örgütsel yapısı ile örgütsel sessizlik ve iş tatmini arasındaki ilişkiler [The relationships among enabling school structure, organizational silence and job satisfaction]. *Eğitim ve İnsani Bilimler Dergisi: Teori ve Uygulama*, 10(19), 107-129.
- Browne, M.W., & Cudeck, R. (1993). Alternative ways of assessing model fit. In K.A. Bollen & J.S. Long (Eds.). *Testing structural equation models* (pp. 136–162). Sage.
- Buluç, B. (2009). İlköğretim okullarında bürokratik okul yapısı ile okul müdürlerinin liderlik stilleri arasındaki ilişki [The relationship between bureaucratic school structure and leadership styles of school principals in primary schools]. *Eğitim ve Bilim*, 34(152), 71-86.
- Cansoy, R., & Parlar, H. (2018). Examining the relationships among trust in administrator, distributed leadership and school academic optimism. *Kuram ve Uygulamada Eğitim Yönetimi*, 24(1), 1-44. <https://doi.org/10.14527/kuey.2018.001>
- Cemaloğlu, N. (2013). Liderlik [Leadership]. In S. Özdemir (Ed.), *Eğitim yönetiminde kuram ve uygulama* (p.131-183). Pegem Akademi.
- Cerit, Y. (2012). Okulun bürokratik yapısı ile sınıf öğretmenlerinin profesyonel davranışları arasındaki ilişki [The relationship between bureaucratic school structure and classroom teachers' professional behaviour]. *Kuram ve Uygulamada Eğitim Yönetimi*, 4(4), 497-521.
- Cerit, Y., & Akgün, N. (2015). Okulun örgüt yapısı ile sınıf öğretmenlerinin proaktif davranışları arasındaki ilişki [The relationship between school organizational structure and classroom teachers' proactive behaviors]. *Kastamonu Eğitim Dergisi*, 23(4), 1789-1802.
- Chang, I.H. (2011). A study of the relationships between distributed leadership, teacher academic optimism and student achievement in Taiwanese elementary schools. *School Leadership & Management*, 31(5), 491-515. <https://doi.org/10.1080/13632434.2011.614945>

- Çakır, Ç. (2019). Dağıtılmış liderlik ile örgütsel vatandaşlık davranışı arasındaki ilişkide örgütsel kimliğin rolü [The role of organizational identity on the relationship between distributed leadership and organizational citizenship behaviour]. *Turkish Studies-Educational Sciences*, 14(4), 1189-1209. <https://doi.org/10.29228/TurkishStudies.23482>
- Çalık, T., & Tepe, N. (2019). Ortaokul öğretmenlerinin algılarına göre okul etkililiği ile kolaylaştırıcı okul yapısı ve akademik iyimserlik arasındaki ilişki [The relationship between school effectiveness and enabling school structure and academic optimism according to the middle school teachers perceptions]. *Kastamonu Eğitim Dergisi*, 27(4), 1471-1480. <https://doi.org/10.24106/kefdergi.3008>
- Çiçek, E. (2018). *Eğitim kurumlarında dağıtımçı liderlik ve örgütsel güven arasındaki ilişki: Kayseri il merkezi örneği* [The relationship between distributed leadership and organizational confidence in educational institutions: Kayseri province case] [Unpublished master thesis]. Nevşehir Hacı Bektaş Veli University.
- Çiçekli, A. (2016). *Kamu yönetiminde hesap verebilirlik ve BİMER'in hesap verebilir yönetime etkisi: Van sağlık hizmetleri örneği* [Accountability in public administration, the effect of BİMER on accountable government; the example of Van health service managements] [Unpublished master thesis]. Yüzüncü Yıl University.
- Çokluk, Ö., Şekercioglu, G., & Büyüköztürk Ş. (2010). *Sosyal bilimler için çok değişkenli istatistik: SPSS ve LISREL uygulamalı* [Multivariate statistics for the social sciences: SPSS and LISREL applications]. Pegem Yayınları.
- Çokyığıt, M. (2020). *Ortaokulların bürokratik yapısının etkililiği örgütsel güven ve örgütsel destek düzeyi arasındaki ilişki* [The relationship between effectiveness of the bureaucratic structure of secondary schools organizational trust and organizational support level] [Unpublished doctoral thesis]. Gazi University.
- Çomak, M. (2021). *Okul yöneticilerinin dağıtımçı liderlik uygulama becerileri ile örgüt iklimi arasındaki ilişkiler* [Relationships between distributed leadership practice skills of school administrators and organizational climate] [Unpublished master thesis]. Kırşehir Ahi Evran University.
- Demirtaş, Z., Özdemir, T.Y., & Küçük, Ö. (2016). Okulların bürokratik yapısı, örgütsel sessizlik ve örgütsel sinizm arasındaki ilişki [Relationships between bureaucratic structure of schools, organizational silence and organizational cynicism]. *Kuram ve Uygulamada Eğitim Yönetimi Dergisi*, 22(2), 193-216. <https://doi.org/10.14527/kuey.2016.008>
- Doğan, D. (2015). *Türkiye'deki yükseköğretim kurumlarında hesap verebilirlik ve akademik özgürlük* [Accountability and academic freedom in higher education institutions in Turkey] [Unpublished doctoral thesis]. Eskişehir Osmangazi University.
- Elmore, R.F. (2000). *Building a new structure for school leadership*. Albert Shanker Institute.
- Elmore, R.F. (2005). Accountable leadership. *The Educational Forum*, 69(2), 134-142.
- Ereş, F., & Akyürek, M.İ. (2016). İlkokul müdürlerinin dağıtılmış liderlik davranışları ile öğretmenlerin iş doyumunu algıları arasındaki ilişki [Relationship levels between distributed leadership behaviors of principals and the teachers' perception of job satisfaction]. *Gazi Üniversitesi Gazi Eğitim Fakültesi Dergisi*, 36(3), 427-449.
- Figlio, D., & Loeb, S. (2011). School accountability. In Hanushek, E.A., Machin, S., & Woessmann, L. (Eds.), *Handbooks in economics: Economics of education*, (Vol. 3, pp. 383–421). Elsevier.
- Flowchart Maker Online Diagram Software. <https://www.draw.io/>
- Geist, J.R. (2002). *Predictors of faculty trust in elementary schools: Enabling bureaucracy, teacher professionalism, and academic press* [Unpublished doctoral dissertation]. The Ohio State University.

- Gray, J. (2016). Investigating the Role of Collective Trust, Collective Efficacy, and Enabling School Structures on Overall School Effectiveness. *Education Leadership Review*, 17(1), 114-128.
- Halim, R.A., & Ahmad, H. (2016). Distributed leadership, contextual factor and teachers' self-efficacy in Malaysia. *Educational Leader (Pemimpin Pendidikan)*, 4, 31-38.
- Harris, A. (2005). *Crossing boundaries and breaking barriers: Distributing leadership in schools*. Specialist Schools Trust.
- Harrison, N.L.T. (2005). *The impact of distributed leadership on teachers* [Unpublished doctoral dissertation]. Indiana University.
- Heck, R.H., & Hallinger, P. (2009). Assessing the contribution of distributed leadership to school improvement and growth in math achievement. *American Educational Research Journal*, 46(3), 659–689. <https://doi.org/10.3102/0002831209340042>
- Hermann, K.R. (2016). *The Principal's role; distributed leadership* [Unpublished doctoral dissertation]. Old Dominion University.
- Hoy, W.K. (2003). An analysis of enabling and mindful school structures: Some theoretical, research and practical considerations. *Journal of Educational Administration*, 41(1), 87-109. <https://doi.org/10.1108/09578230310457457>
- Hoy, W.K., & Sweetland, S.R. (2000). School bureaucracies that work: Enabling, not coercive. *Journal of School Leadership*, 10(6), 525-541. <https://doi.org/10.1177/105268460001000603>
- Hoy, W.K., & Sweetland, S.R. (2001). Designing better schools: The meaning and measure of enabling school structures. *Educational Administration Quarterly*, 37(3), 296–321.
- Hoy, W.K., & Sweetland, S.R. (2007). Designing better schools: The meaning and nature of enabling school structures. In W. Hoy, & M. DiPaola (Eds.), *Essential ideas for the reform of American schools* (pp. 339-366). Information Age Publishing.
- Hulpia, H., & Devos, G. (2010). How distributed leadership can make a difference in teachers' organizational commitment? A qualitative study. *Teaching and Teacher Education*, 26(3), 565–575.
- Hulpia, H., Devos, G., & Rosseel, Y. (2009). The relationship between the perception of distributed leadership in secondary schools and teachers' and teacher leaders' job satisfaction and organizational commitment. *School Effectiveness and School Improvement*, 20(3), 291-317.
- Hulpia, H., Devos, G., & Van Keer, H. (2009). The influence of distributed leadership on teachers' organizational commitment: A multilevel approach. *The Journal of Educational Research*, 103(1), 40-52.
- Jacob, J.A. (2003). *A study of school climate and enabling bureaucracy in select New York City public elementary schools* [Unpublished doctoral dissertation]. St. John's University.
- Jacobs, G.E. (2010). *The relationship between distributed leadership as practiced by principals and the organizational commitment of the teachers* [Unpublished doctoral dissertation]. Georgia Southern University.
- Jofreh, M., Mohammadi, F., & Yasini, A. (2012). Leadership distribution consequences in schools: A particular look at organizational citizenship behavior of teacher. *Australian Journal of Basic and Applied Sciences*, 6(12), 259-268.
- Kalman, M., & Gedikoğlu, T. (2014). Okul yöneticilerinin hesap verebilirliği ile örgütsel adalet arasındaki ilişkinin incelenmesi [An investigation of the relationship between school administrators' accountability and organizational justice]. *Hacettepe Üniversitesi Eğitim Fakültesi Dergisi*, 29(2), 115-128.
- Kandemir, A., & Akgün, N. (2019). Ortaokul öğretmenlerinin hesap verebilirlik algıları ile yöneticilerinin hizmetkâr liderlik davranış düzeyleri arasındaki ilişki [Relationship between the accountability perceptions of secondary school teachers and their managers']

- level of servant leadership behavior]. *Bolu Abant İzzet Baysal Üniversitesi Eğitim Fakültesi Dergisi*, 19(4), 1637-1653. <https://dx.doi.org/10.17240/aibuefd.2019.-541661>
- Karataş, İ.H. (2022). Türkiye’de okul yöneticiliğinin açmazları [The deadlocks of school management in Turkey]. *Okul Yönetimi*, 1(1), 9-18.
- Karagöz, S. (2020). *Anaokulu öğretmenlerinin hesap verebilirlik ve örgütsel sessizlik davranışları arasındaki ilişki [The relationship between accountability and organizational silence behaviors of kindergarten teachers]* [Unpublished master thesis]. İstanbul Okan University.
- Karaoğlan, Ö. (2019). *Okulların bürokratik yapısı, örgütsel sessizlik ve örgütsel sinizm arasındaki ilişki [The relationship between the bureaucratic structure of the schools, organizational silence and organizational cynicism]* [Unpublished master thesis]. Pamukkale University.
- Karasar, N. (2009). *Bilimsel araştırma yöntemi [Scientific research method]*. Nobel Yayın Dağıtım.
- Kılınç, A.Ç., Koşar, S., Er, E., & Öğdem, Z. (2016). The relationship between bureaucratic school structures and teacher self-efficacy. *McGill Journal of Education/Revue des sciences de l'éducation de McGill*, 51(1), 615-634. <https://doi.org/10.7202/1037362ar>
- Kim, H.S. (2005). *Organizational structure and internal communication as antecedents of employee organization relationships in the context of organizational justice: A multilevel analysis* [Unpublished doctoral dissertation]. University of Maryland.
- Koçak, S., & Nartgün, Ş.S. (2018). Öğretmenlerin okul hesap verebilirliğine ilişkin görüşlerini belirlemeye yönelik nitel çalışma [Qualitative study to determine teachers' views on school accountability]. In M. Koçalı (Ed.), *9. Uluslararası Eğitim Yönetimi Forumu* (p. 235-254). Türkiye: Antalya.
- Kondo, S. (2002). Fostering dialogue to strengthen good governance. *Public sector transparency and accountability: Making it happen*, 7-11.
- Koohi, A., Hashemi, A., Minaei, A., & Dehghan, A. (2019). The relation between empowering structure in schools with teachers career satisfaction and schools efficiency in elementary schools in Qarchak. *Career and Organizational Counseling*, 11(40), 99-114.
- Koster, G.L. (2016). *Relationship between school structure and collective student trust in teachers* [Unpublished doctoral dissertation]. Oklahoma State University.
- Kurt, T. (2016). Öğretmen liderliğini açıklamaya yönelik bir model: Dağıtımcı liderlik, örgütsel öğrenme ve öğretmenlerin öz yeterlik algısının öğretmen liderliğine etkisi [A model to explain teacher leadership: The effects of distributed leadership, organizational learning and teachers' sense of self-efficacy on teacher leadership]. *Eğitim ve Bilim*, 41(183), 1-28. <https://doi.org/10.15390/EB.2016.5081>
- Leithwood, K. (2001). Educational accountability and school leadership. *National College of School Leadership*. <http://citeseerx.ist.psu.edu/viewdoc/download?doi=10.1.1.495.5426&rep=rep1&type=pdf>.
- Maile, S. (2002). Accountability: An essential aspect of school governance. *South African Journal of Education*, 22(4), 326-331.
- Mascall, B., Leithwood, K., Straus, T., & Sacks, R. (2008). The relationship between distributed leadership and teachers' academic optimism. *Journal of Educational Administration*, 46(2), 214-228. <https://doi.org/10.1108/09578230810863271>
- Mayerson, D.R. (2010). *The relationship between school climate, trust, enabling structures, and perceived school effectiveness* [Unpublished doctoral dissertation]. St. John's University.
- Mayrowetz, D. (2008). Making sense of distributed leadership: Exploring the multiple usages of the concept in the field. *Educational Administration Quarterly*, 44(3), 424-435. <https://doi.org/10.1177/0013161X07309480>

- McGuigan, L., & Hoy, W.K. (2006). Principal leadership: Creating a culture of academic optimism to improve achievement for all students. *Leadership and Policy in Schools*, 5(3), 203–229. <https://doi.org/10.1080/15700760600805816>
- Messick, P.P. (2012). *Examining relationships among enabling school structures, academic optimism, and organizational citizenship behaviors* [Unpublished doctoral dissertation]. Auburn University.
- Meydan, C.H., & Şeşen, H. (2011). *Yapısal eşitlik modellemesi AMOS uygulamaları* [Structural equation modeling AMOS applications]. Detay Yayıncılık.
- Miskel, C. (1979). Demographic characteristics, faculty attitudes and school structure. *Paper presented at The Annual Meeting of The American Educational Research Association*. San Francisco, California, April 8-12.
- Miskel, C.G., Fevurly, R., & Stewart, J. (1979). Organizational Structures and Processes, Perceived School Effectiveness, Loyalty, and Job Satisfaction. *Educational Administration Quarterly*, 15(3), 97–118. <https://doi.org/10.1177/0013131X7901500308>
- Mitani, H. (2018). Principals' working conditions, job stress, and turnover behaviors under NCLB accountability pressure. *Educational Administration Quarterly*, 54(5), 822-862. <https://doi.org/10.1177/0013161X1878587>
- Mitchell, R.M. (2019). Enabling school structure & transformational school leadership: Promoting increased organizational citizenship and professional teacher behavior. *Leadership and Policy in Schools*, 18(4), 614-627. <https://doi.org/10.1080/15700763.2018.1475577>
- Nathaniel, P., Pendergast, L.L., Segool, N., Saeki, E., & Ryan, S. (2016). The influence of test-based accountability policies on school climate and teacher stress across four states. *Teaching and Teacher Education*, 59, 492-502. <https://doi.org/10.1016/j.tate.2016.07.013>
- Oldaç, Y.İ., & Kondakçı, Y. (2020). Multilevel analysis of the relationship between school-level variables and student achievement. *Educational Management, Administration & Leadership*, 48(4), 762-780. <https://doi.org/10.1177/1741143219827303>
- Ordu, A., & Tanrıöğen, A. (2013). İlköğretim okullarında örgütsel yapı ile örgüt sağlığı arasındaki ilişkiler [The relationships between organizational structure and organizational health in primary schools]. *Pamukkale Üniversitesi Eğitim Fakültesi Dergisi*, 33(33), 93-106.
- Orhan, M. (2022). *Okul yapısı ile hesap verebilirlik arasındaki ilişkide dağıtımci liderliğin aracılık rolünün incelenmesi* [The examination of mediating role of distributed leadership in the relationship between school structure and accountability] [Unpublished doctoral thesis]. Fırat University.
- Özdemir, S., & Kılınç, A.Ç. (2014). The relationship between bureaucratic school structure and teachers' level of academic optimism/Bürokratik okul yapısı ile öğretmenlerin akademik iyimserlik düzeyleri arasındaki ilişki [The relationship between bureaucratic school structure and teachers' level of academic optimism]. *Eğitimde Kuram ve Uygulama*, 10(1), 1-23.
- Özen, Y., & Gül, A. (2007). Sosyal ve eğitim bilimleri araştırmalarında evren-örneklem sorunu [Population-sampling issue on social and educational research studies]. *Atatürk Üniversitesi Kazım Karabekir Eğitim Fakültesi Dergisi*, (15), 394-422.
- Özer, N., & Beycioğlu, K. (2013). Paylaşılan liderlik ölçeğinin geliştirilmesi: Geçerlik ve güvenilirlik çalışmaları [The development, validity and reliability study of distributed leadership scale]. *İlköğretim Online*, 12(1), 77-86.
- Özer, N., & Dönmez, B. (2013). Kolaylaştırıcı okul yapısı ölçeğinin Türkçe formunun psikometrik özelliklerinin yeniden değerlendirilmesi [Reassessing the psychometric

- properties of the turkish version of enabling school structure scale]. *Pegem Eğitim ve Öğretim Dergisi*, 3(4), 57-68.
- Preacher, K.J., & Hayes, A.F. (2008). Asymptotic and resampling strategies for assessing and comparing indirect effects in multiple mediator models. *Behavior Research Methods*, 40(3), 879-891. <https://doi.org/10.3758/BRM.40.3.879>
- Rabindarang, S., Bing, K.W., & Yin, K.Y. (2014). The influence of distributed leadership on job stress in technical and vocational education. *International Journal of Academic Research in Business and Social Sciences*, 4(1), 490-499. <https://doi.org/10.6007/IJARBS/v4-i1/555>
- Rockoff, J.E., & Turner, L.J. (2010). Short-run impacts of accountability on school quality. *American Economic Journal: Economic Policy*, 2(4), 119-147.
- Schermelleh-Engel, K., Moosbrugger, H., & Müller, H. (2003). Evaluating the fit of structural equation models: Tests of significance and descriptive goodness-of-fit measures. *Methods of Psychological Research Online*, 8(2), 23-74.
- Sinden, J.E., Hoy, W.K., & Sweetland, S.R. (2004). An analysis of enabling school structure: Theoretical, empirical, and research considerations. *Journal of Educational Administration*, 42(4), 462-478. <https://doi.org/10.1108/09578230410544071>
- Smylie, M.A., Mayrowetz, D., Murphy, J., & Louis, K.S. (2007). Trust and the Development of Distributed Leadership. *Journal of School Leadership*, 17(4), 469–503.
- Stapleman, J. (2000). *Standards-based accountability systems* [policy brief]. Mid-continent Research for Education and Learning.
- Stecher, B., & Kirby, S.N. (Eds.). (2004). *Organizational improvement and accountability: Lessons for education from other sectors*. Rand Publication.
- Sümer, N. (2000). Yapısal eşitlik modelleri: Temel kavramlar ve örnek uygulamalar [Structural equation modeling: Basic concepts and applications]. *Türk Psikoloji Yazıları*, 3(6), 49-74.
- Şişman, M. (2019). *Türk eğitim sistemi ve okul yönetimi [Turkish education system and school administration]* (11. Baskı). Pegem Akademi.
- Tabachnick, B.G., & Fidell, L.S. (2007). *Using multivariate statistics* (5th Edition). Pearson Education.
- Tavşancıl, E. (2002). *Tutumların ölçülmesi ve SPSS ile veri analizi [Measurement of attitudes and data analysis with SPSS]*. Nobel Yayıncılık.
- Turner, J.B. (2018). *Organizational justice and enabling school structure as predictors of organizational citizenship behavior* [Unpublished doctoral dissertation]. The University of Alabama.
- Wahab, J.A., Hamid, A.H.A., Zainal, S., & Rafik, M.F.M. (2013). The relationship between headteachers' distributed leadership practices and teachers' motivation in national primary schools. *Asian Social Science*, 9(16), 161-167. <https://doi.org/10.5539/ass.v9n16p161>
- Watts, D.M. (2009). *Enabling school structure, mindfulness, and teacher empowerment: Test of a theory* [Unpublished doctoral dissertation]. The University of Alabama.
- Woods, P.A., & Gronn, P. (2009). Nurturing democracy: The contribution of distributed leadership to a democratic organizational landscape. *Educational Management Administration & Leadership*, 37, 430–451. <https://doi.org/10.1177/1741143209334597>
- Yağ, T. (2019). *Okul yöneticilerinin yönetim tarzları ile hesap verebilirlik yönelimleri arasındaki ilişki [The relationship between management styles of school administrators' and accountability orientations]* [Unpublished master thesis]. Kırşehir Ahi Evran University.
- Yetim, Z. (2015). *İlköğretim kurumlarında dağıtımcı liderlik ile örgütsel bağlılık arasındaki ilişki (Seydikemer örneği) [The relation between the distributed leadership and*

- organizational commitment in the elementary educational institutions (The case of Seydikemer)* [Unpublished master thesis]. İstanbul Aydın University.
- Yılmaz, D. (2014). *Dağıtılmış liderliğin örgütsel güven ile algılanan örgütsel destek ve okul başarısıyla ilişkisi [The relationship between distributed leadership, organizational trust, perceived organizational support and school success]* [Unpublished doctoral thesis]. Eskişehir Osmangazi University.
- Yiğit, B. (2017). *Yöneticilerin hesap verebilirlik uygulamalarının çalışanların örgütsel bağlılık davranışlarıyla ilişkisinin incelenmesi- Eğitim kurumları örneği [Examining the relation between accountability practices of directors and the organizational commitment behaviors of the employees: A case study on educational institutions]* [Unpublished master thesis]. Türk Hava Kurumu University.