





Modeling student's interest in mathematics: Role of history of mathematics, peer-assisted learning, and student's perception

Yarhands Dissou Arthur^{1*} , Simon Kojo Appiah² , Kwadwo Amo-Asante¹ , Bright Asare¹ 

¹ Department of Mathematics Education, Akenten Appiah-Menka University of Skills Training and Entrepreneurial Development, Kumasi, GHANA

² Department of Statistics and Actuarial Science, Kwame Nkrumah University of Science and Technology, Kumasi, GHANA

Received 24 July 2022 ▪ Accepted 09 September 2022

Abstract

The research was to ascertain the mediating effect of students' perception in the relationship between the history of mathematics, peer-assisted learning, and students' interest in mathematics. The study was based on 394 students from four selected secondary schools in the Ashanti region of Ghana. The study was a survey, adopting a structured questionnaire as the research instrument. Structural equation modelling was estimated using Amos (v.23) software, to test the hypothesized paths. History of mathematics had no direct effect on students' perception towards mathematics, thereby, students' perception acted as a full mediating variable. Peer-assisted learning had a direct effect on students' perception towards mathematics, thereby, students' perception acted as a partial mediating variable. It is recommended to the Ghana Education Service and the Ministry of Education to inculcate the use of history mathematics, as part of the courses in training mathematics teachers.

Keywords: history of mathematics, peer-assisted learning, mathematics perception, mathematics interest

INTRODUCTION

Mathematics is seen as an essential precursor to success in modern society and it is a challenge for most students (Chu et al., 2017). In Ghana, as in most African countries, mathematics is taught at the basic school, senior high school (SHS) as well as colleges of education (CoE) curricula (Ampofo, 2019). Mathematics is a compulsory subject for every learner at these levels of education and is a gateway and critical filter for further studies in the country (Ampofo, 2019). The student's ability to cope with mathematics improves one's chance of social improvement. For a student to perform well in mathematics in Ghana has been problematic (Eze, 2021). Ghanaian students' performance in mathematics has consistently been low over the years. A recent report shows that 54.11% of candidates who sat for the May/June 2021 West African Senior High School Certificate Examination (WASSCE) obtained a pass of A1-C6 in core mathematics (WAEC, 2021). These performance level in core mathematics has become a concern to those who have an interest in education and

has become a further threat to the country's science and technology industry (Ampofo, 2019). Is their performance level determined by their level of interest in mathematics? If yes, then how can their level of mathematics interest improve when studying mathematics. The present research looked at how the adoption of history of mathematics concepts and peer-assisted learning, could help to improve students' interest in mathematics.

Mathematics plays a major role in building civilization and has become an essential tool for development in the modern world (Gulnaz & Fatima, 2019). The idea of using the history of mathematics as an instructional tool is not new. In Turkey, research has shown that the history of mathematics formed part of their mathematics curriculum since 2004 (Butuner, 2020). When the history of mathematics is used in teaching and learning mathematics, it helps students understand mathematics concepts and theorems and also improves their level of interest in studying mathematics. According to Rusmini (2018), interest has to do with individual feelings, objectives, and activities. Ponce

Contribution to the literature

- The study proposed history of mathematics to have a significant positive effect on students' interest in mathematics.
- The study proposed peer-assisted learning to have a significant positive effect on students' interest in mathematics.
- The study proposed the relationship between the history of mathematics and students' interest in mathematics to be partially mediated by students' perception in mathematics. The study proposed the relationship between peer-assisted learning and students' interest in mathematics to be partially mediated by students' perception in mathematics.

Campuzano et al. (2017) pointed out that, when the history of mathematics is introduced to students it not only helps and improves their mathematical thinking but improves their growth and evaluation of ideas. Introducing the past does not mean neglecting the present future; indeed, understanding the past can be a gateway to current and future thinking.

Other studies also presented some other determinants of students' interest in mathematics. One such determinant of student interest in mathematics is peer-assisted learning. According to Santhanalakshmi and Naomi (2021), peer-assisted learning is a structured peer tutoring program. Peer-assisted learning is not designed to replace the existing classroom teaching methods and teaching curriculum but to assist students with special needs in the classroom. Peer-assisted learning is a learning strategy or concept in which students from different the same or different classrooms assist each other to learn, with the understanding that they are of the same department but not necessarily the same course of study (Elshami et al., 2020). Peer-assisted learning is also a factor that influences students' interest in learning mathematics. Peer-assisted learning is good for students with learning disabilities, and low-performing students without disabilities (Santhanalakshmi & Naomi, 2021). Building students' interest is important, as it makes them enjoy learning mathematics, rather than feeling it as a burden or a difficult task.

LITERATURE REVIEW

History of Mathematics and Students' Interest in Mathematics

This concept of history of mathematics was defined by this study as the adoption of history of mathematics activities (or as a pedagogical tool) in teaching a mathematics course, to enable students to recognize the dynamic and developing nature of mathematics, to deepen their perceptions of successful mathematicians, to show them how and why mathematics emerged, and help them to enjoy the mathematics course by experiencing the fun and interesting side of it (Butuner & Baki, 2020). The use of the history of mathematics has been accepted by many researchers in mathematics

classes (Baki & Gursoy, 2018). Sahin and Danaci (2020) found out that incorporating the use of the history of mathematics into the curriculum improves students' mathematical skills, which also enhances their mathematical performance. By developing mathematics stories during teaching, students develop interest, and it supports students' questions. History of mathematics helps students to gain a true understanding of how mathematics concepts were developed. The use of history in teaching mathematics provides the opportunity to explore the past to understand factors that have shaped the world (Baah-Duodu et al., 2021). Students' interest in learning mathematics is likely to have a positive effect on their learning process and outcome (Leyva et al., 2022). According to Rusmini (2018), interest has to do with individual feelings, objectives, and activities. One vital factor for students' success in their mathematics course is their level of interest in mathematics, which is likely to have a positive effect on their learning process and outcome (Leyva et al., 2022). Because of this, it is very necessary to create an atmosphere so that students will be eager to learn. Students with a high interest in learning mathematics are likely to perform well in their studies. Students with less interest in learning mathematics are likely to have challenges in completing mathematics (Meke et al., 2019). It was thus proposed that,

H1: History of mathematics has a direct positive effect on students' interest in mathematics.

Peer-Assisted Learning and Students' Interest in Mathematics

Peer-assisted learning demonstrates any activity where students help one another in mastering material (Havens & Williams, 2019). When students work with their peers, they are able to fully participate in the lesson, instead of being passive learners (Havens & Williams, 2019). Arthur et al. (2022) discovered peer-assisted learning as an important factor that determines student performance. Peer-assisted learning provides guidelines for students to improve their academic performance and their mathematical thinking ability. Peer-assisted learning motivates students from study groups and is more excited about their peers (Usman & Jamil, 2019). Peer-assisted learning assists students with learning

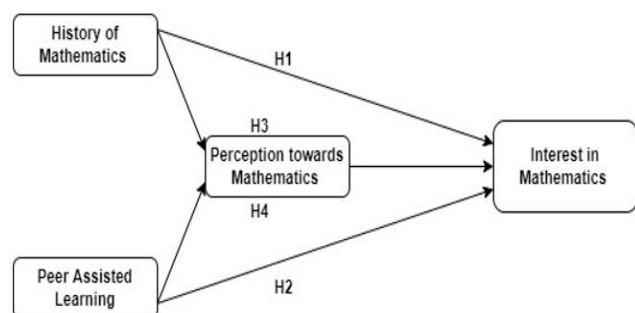

Figure 1. Conceptual framework

difficulties most especially the material used during learning and provides additional support beyond what their teacher taught them (Jessica et al., 2020). Peer-assisted learning is meant to support regular teaching and learning. Peer-assisted learning motivates students to study more as compared to regular classes and it facilitates the deep learning process (Elshami et al., 2020). In peer-assisted learning, learners construct their knowledge employing interaction with their peers, thereby enhancing their interest. It is proposed that,

H2: Peer-assisted learning has a direct positive effect on students' interest in mathematics.

Mediating Role of Student's Perception Towards Mathematics

Perception generally refers to the mental representation of something, which is influenced by past experiences, associated beliefs, attitudes and conceptions. Perceptions of mathematics as a concept is thus defined as a mental representation or view of mathematics, apparently constructed as a result of social experiences, interactions at school, or the influence of parents, teachers, peers, or mass media (Mutodi & Ngirande, 2014). Studies have suggested that the use of the history of mathematics has a positive effect on mathematics thinking (Fung et al., 2018). History of mathematics is an essential tool for teaching and learning mathematics in aid of improving students' understanding of mathematics learning. The use of the history of mathematics has a direct effect on students' perception of learning mathematics. Integrating the history of mathematics and real-life activities in teaching and learning will enable students to develop a positive attitude toward learning mathematics (Suan, 2014), which influence their interest in mathematics (Arthur et al., 2022; Ufer et al., 2017). It was thus hypothesized that,

H3: Students' perception of mathematics mediates the relationship between the history of mathematics and students' interest in mathematics.

Peer-assisted learning affects students' learning interest in mathematics (Wood et al., 2020). Peer-assisted learning helps the learner to appreciate and understands mathematical theorem and concepts when they find it difficult during teaching and learning (Santhanalakshmi & Naomi, 2021). Using peer-assisted learning will

Table 1. Demographics information

Demographics (response/option)	F (n)	P (%)
Gender		
Female	195	49.5
Male	199	50.5
Total	394	100.0
Age		
11 to 15 years	91	23.1
16 to 20 years	289	73.4
Above 20 years	14	3.6
Total	394	100.0
Course		
Agriculture/science	144	36.5
Business	161	40.9
General/visual arts	33	8.4
Home economics	56	14.2
Total	394	100.0
Form/year		
Form one	149	37.8
Form two	121	30.7
Form three	124	31.5
Total	394	100.0

Note. F: Frequency & P: Percentage

improve students' interest and attitude toward learning mathematics (Arthur et al., 2022). In view of that, Cai and Hwang (2020) found that the interest and academic success of the students are influenced by their attitude towards mathematics. It was thus hypothesized that,

H4: Students' perception of mathematics mediates the relationship between peer-assisted learning and students' interest in mathematics.

Figure 1 presents conceptual framework of the study.

MATERIALS AND METHODS

Sample and Data Collection

The study consists of secondary school students sampled from four senior high schools in the Ashanti region of Ghana. There were 100 questionnaires distributed to each secondary school, but after the data collection, 394 questionnaires were considered usable for data analysis. This gave a response rate of 98.5% $[(394/400) \times 100]$, which was considered very high enough to be accepted for the study.

Table 1 presents the demographic distributions of the study. Out of a total of 394 students, 49.5% were female students, while 50.5% were male students. The majority of the students (73.4%) were aged between 16-20 years. There were 23.1% aged between 11-15 years, while 3.6% aged above 20 years. First year students selected constituted 37.8%, second year students constituted 30.7%, and final-year students constituted 31.5%. The science/agriculture students selected constituted 36.5%, business students constituted 40.9%, home economics students constituted 14.2%, while general/visual arts students also constituted 8.4%.

Table 2. Confirmatory factor analysis

MFI: $CMIN=134.142$; $df=80$; $CMIN/df=1.677$; $GFI=0.956$; $CFI=0.976$; $TLI=0.969$; $RMR=0.050$; & $RMSEA=0.041$		SFL
History of mathematics (HIIST): $CA=0.817$; $CR=0.822$; & $AVE=0.537$		
HM1		0.683
HM2		0.678
HM3		0.796
HM4		0.766
Peer-assisted learning (PEER): $CA=0.827$; $CR=0.811$; & $AVE=0.522$		
PL1		0.801
PL2		0.821
PL3		0.609
PL4		0.634
Perception towards mathematics (PERC): $CA=0.811$; $CR=0.816$; & $AVE=0.597$		
PM1		0.823
PM2		0.708
PM3		0.782
Mathematics study interest (INT): $CA=0.799$; $CR=0.801$; & $AVE=0.503$		
IM1		0.663
IM2		0.642
IM3		0.743
IM4		0.780

Note. MFI: Model fit indices; SFL: Standard factor loading; CFI: Comparative fit index; $CMIN/df$: Chi-square/degree of freedom; TLI: Tukey-Lewis index; RMR: Root mean square residual; & RMSEA: Root mean square error of approximation

Structured questionnaire was used as the research instrument for this study. Convenience sampling technique was used is selecting students from the 4 selected secondary schools. An introductory and a cover letter were sent to the head teachers at the selected schools. After permissions were granted, questionnaires were distributed. Questionnaire administration was during class hours, and as such, further permissions were sought from the subject teachers in various classes where the questionnaires were administered.

Questionnaire and Measures

The research had four main variables, which were history of mathematics, peer-assisted learning, students' perception towards mathematics, and students' interest in mathematics. These four variables were measured on a Likert scale of 1=strongly disagree, to 5=strongly agree.

The measurement items under history of mathematics were adapted from Butuner and Baki (2020). The items were, "My mathematics teacher introduces new concepts by providing the history behind the concept", "I enjoy the history behind the mathematics concepts we study", "It is easier to understand mathematics concepts, when the history is provided", and "History of mathematics makes mathematics class meaningful".

The measurement items under peer-assisted learning and students' interest in mathematics were adapted from Arthur et al. (2022). The items were, "I understand mathematics better during peer discussions", "My course mates encourage me to learn mathematics during and after mathematics lessons", "I look for other students for help whenever I encounter

problems in working mathematics", and "I learn mathematics better during team project".

The measurement items under students' interest in mathematics were adapted from Arthur et al. (2022). The items were, "Mathematics is easy to study", "Everyone requires a basic understanding of mathematics", and "Mathematics plays a crucial role in our daily lives". Finally, the measurement items under students' perception towards mathematics were also adapted from Hagan et al. (2020). The items were, "I have interest in learning mathematics as part of my course", "Mathematics is one of the courses I enjoy learning most", "Learning mathematics is interesting", and "I love mathematics as a subject".

The study controlled for four potential demographic variables, which could potentially influence the outcome of the study. These were, gender (measured as 0=female, 1=male), age of students (measured as 1=11-15 years, 2=16-20 years, and 3=above 20 years), course or program offered by students (measured as 1=agriculture/science, 2=business, 3=general/visual arts, and 4=home economics), and form or year of student in the school (measured as 1=1st year, 2=2nd year, and 3=3rd, or final year).

Validity and Reliability Analysis

As with any other empirical study, there was the need to test for the validity and reliability of the measurement items and the dataset before the main path estimation. Confirmatory factor analysis (CFA) was thus run using Amos (v.23) software. Results of the CFA are presented in **Table 2** and **Figure 2**.

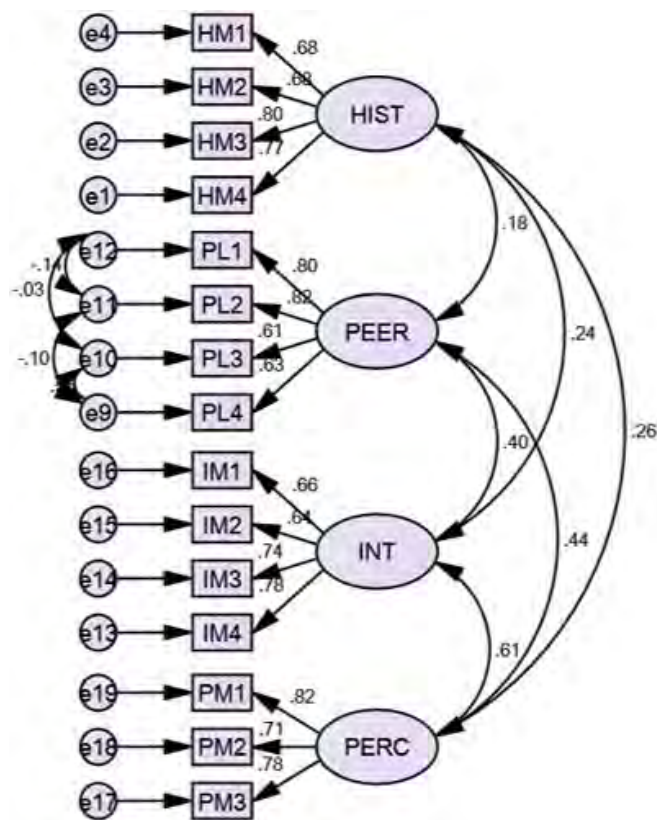

Figure 2. Confirmatory factor analysis

A minimum factor scores of 0.5 were expected to be achieved, and therefore, measurement items with factor scores of less than 0.5 were deleted (Amoako et al., 2020; Arthur et al., 2021). Using this approach, one measurement item each was deleted under peer-assisted learning, perception towards mathematics, and mathematics interest.

Internal consistency of the measurement items was assessed using Cronbach’s alpha (CA) analysis in SPSS (v.23) software. Internal reliability or consistency is said to be achieved when the alpha score is at least 0.7 (Pomegbe et al., 2020). As demonstrated in Table 2, history of mathematics had a CA of 0.817, peer-assisted learning had a CA of 0.827; perception towards mathematics had a CA of 0.811, while mathematics study interest had a CA of 0.799.

Convergent validity was assessed using average variance extracted (AVE) and composite reliability (CR).

To achieve convergent validity, Fornell and Larcker (1981) recommended an AVE score of at least 0.5 and CR score of at least 0.7. The least AVE reported in Table 2 was 0.503 (mathematics study interest), and the least CR was also 0.801 (mathematics study interest).

For the model fit indices, Hair et al. (2010) recommended CMIN/DF should be less than three, TLI and CFI should be greater than 0.9, GFI greater than 0.8, while RMSEA and RMR should be less than 0.08. Table 2 demonstrates that all the model fit indices were achieved, suggesting that the dataset appropriately fits the model.

The descriptive and discriminant validity scores were also presented in Table 3. The lowest mean score was 3.479 (peer-assisted learning). Since a 5-point Likert scale (1=strongly disagree, to 5=strongly agree) was used in this study, mean score above three is considered as in the range of ‘agree’.

This study measured descriptive validity by comparing the square-root of the AVEs (\sqrt{AVE} s) against the correlation coefficients. Discriminant validity is achieved when the least \sqrt{AVE} is larger than the highest correlation coefficient (Sarsah et al., 2020). From Table 3, the least \sqrt{AVE} was 0.709, which the highest correlation coefficient was 0.606, which suggests discriminant was achieved by this study. Since the highest correlation coefficient was also less than 0.7, it was concluded that there was no multicollinearity which could potentially cause any confounding effects in the model estimation (Dogbe et al., 2021).

RESULTS

The path coefficients were estimated using a covariance-based structural equation modelling (SEM) Amos (v.23) software. Bias-corrected (BC) percentile method of bootstrapping was used, with 5,000 bootstrap sample, and 95% confidence level.

Table 4 and Figure 3 present the results of the analysis. Results suggested that form and gender had a negative but statistically insignificant effect on students’ interest in mathematics (p-values>0.05). Course or program of study, and age also had a positive but statistically insignificant effect on students’ interest in mathematics (p-values>0.05).

Table 3. Descriptive and discriminant validity analysis

Variables	Mean	SD	Course	Gender	Age	Form	HIST	PEER	PERC	INT
Course	-	-	-	-	-	-	-	-	-	-
Gender	-	-	-0.003	-	-	-	-	-	-	-
Age	-	-	0-.073	0.073	-	-	-	-	-	-
Form	-	-	-0.018	-0.063	0.186**	-	-	-	-	-
HIST	4.122	0.922	0.038	-0.065	-0.040	0.106*	<u>0.733</u>	-	-	-
PEER	3.479	0.996	-0.074	0.149**	0.158**	0.398**	0.176**	<u>0.722</u>	-	-
PERC	4.029	1.012	-0.003	0.105*	0.013	0.077	0.257**	0.435**	<u>0.773</u>	-
INT	4.220	0.908	0.013	0.059	0.038	0.048	0.240**	0.402**	0.606**	<u>0.709</u>

Note. SD: Standard deviation; \sqrt{AVE} are **bold and underlined**; *~p-value significant at 5%; & **~p-value significant at 1%

Table 4. Direct and indirect paths

Direct paths	Un-standard estimate	Standard error	Composite reliability
HIST→PERC	0.235	0.068	3.474**
PEER→PERC	0.485	0.080	6.061**
HIST→INT	0.102	0.060	1.690
PEER→INT	0.222	0.070	3.180**
PERC→INT	0.472	0.066	7.174**
Form→INT	-0.090	0.051	-1.762
Course→INT	0.029	0.042	0.688
Gender→INT	-0.018	0.085	-0.215
Age→INT	0.054	0.088	0.607
Indirect paths	Un-standard estimate	Lower bias-corrected	Upper bias-corrected
HIST→PERC→INT	0.111	0.047	0.206
PEER→PERC→INT	0.229	0.145	0.344

Note. Bias-corrected percentile method; 5,000 bootstrap sample; 95% confidence level; & **~p-value significant at 1%

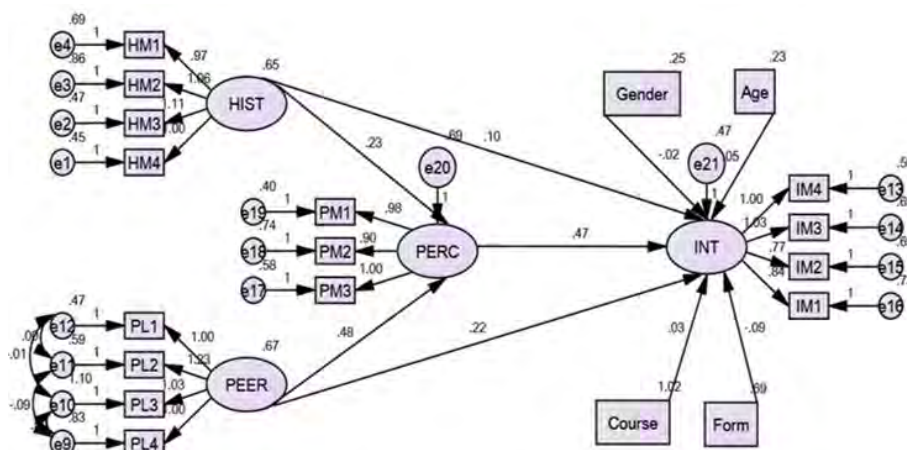

Figure 3. Structural paths

For the hypothesized paths, it was identified that history of mathematics had a positive but statistically insignificant effect on students’ interest in mathematics ($\beta=0.12$; $p>0.05$). Hypothesis **H1**: “History of mathematics has a direct positive effect on students’ interest in mathematics”, was therefore rejected by this study. Peer-assisted learning on the other hand, had a significant positive effect on students’ interest in mathematics ($\beta=0.222$; $p<0.01$). Suggesting that, as students engaged more in peer-assisted learning, their interest in mathematics is likely to be enhanced by about 22.2%, and vice versa. Hypothesis **H2**: “Peer-assisted learning has a direct positive effect on students’ interest in mathematics”, was therefore accepted by this study.

To ascertain the mediating effect students’ perception towards mathematics, in the relationship between history of mathematics and students’ interest towards mathematics, the effect of history of mathematics on students’ perception towards mathematics was first tested. Results suggest a significant positive effect of history of mathematics on students’ perception towards mathematics ($\beta=0.2352$; $p<0.01$). This indicates that, the adoption of history of mathematics as a pedagogical tool enhanced students’ perception towards mathematics by about 23.5%, and vice versa. Students’ perception

towards mathematics also had a significant positive effect on students’ interest towards mathematics ($\beta=0.472$; $p<0.01$). A more positive perception of students towards mathematics could thus increase students’ interest in mathematics by about 47.2%, and vice versa. The coefficient of the indirect effect was 0.111, which was statistically significant (because both lower and upper BCs were positive, and zero (0) cannot be found in-between them). Hypothesis **H3**: “Students’ perception towards mathematics mediates the relationship between history of mathematics and students’ interest in mathematics”, was therefore accepted by this study.

Finally, the mediating effect of students’ perception towards mathematics, in the relationship between peer-assisted learning and students’ interest towards mathematics, was ascertained. Firstly, the effect of peer-assisted learning on students’ perception towards mathematics was ascertained and found to be significant positive ($\beta=0.485$; $p<0.01$). That is, as students engaged in peer-assisted learning, they are likely to have a more positive perception towards mathematics, by a magnitude of 48.5%, and vice versa. The effect of students’ perception towards mathematics on students’ interest in mathematics has also been identified to be significant positive. The coefficient of the indirect effect

was 0.229, which was statistically significant (because both lower and upper BCs were positive, and zero (0) cannot be found in-between them). Hypothesis **H4**: “Students’ perception towards mathematics mediates the relationship between peer-assisted learning and students’ interest in mathematics”, was therefore accepted by this study.

DISCUSSION

Among the four selected senior high schools in the Ashanti region for the study, it was found that the history of mathematics had a direct positive effect on students’ interest in mathematics. That is when teachers provide the history behind mathematics concepts, students enjoyed the lesson and develop an interest in learning mathematics. Using the history of mathematics will help students to connect mathematics to real-life problems (Arthur et al., 2018). Lit et al. (2001) conducted a quasi-experiment to determine the effect of using history of mathematics in teaching Pythagoras theorem on the attitude of grade 8 students and found that using history of mathematics had a significant positive effect on attitude towards mathematics. Similarly, Costal et al. (2021) proposed that using the history of mathematics improves students’ memories of the concepts been taught. Quoting historical events and connecting to mathematics (e.g., history of π), creates interest among High school students and also easily remember concepts of mathematics. Teaching and learning must involve real historical facts (rather than an abstract concept), which creates interest and enhance participation among school children. The adoption of history of mathematics as a pedagogical tool, makes the subject of mathematics more real to students.

The use of peer tutoring in teaching and learning mathematics enhances students’ interest in mathematics (Yeh et al., 2019). The present study identifies that peer-assisted learning has a direct positive effect on students’ interest in mathematics. That is, when teachers introduce peer teaching in mathematics, it will enhance the interest of the students and will have a positive effect on their mathematical achievement. In addition, Santhanalskshmi and Naomi (2021) found that using peer-assisted learning, students with learning disabilities and those of low performance developed interest in learning mathematics. Peer-assisted learning is a way of encouraging student-centered learning, which increases high school students’ interest towards mathematics, while driving away fear of mathematics.

The study further identifies that perception of mathematics partially mediates the relationship between the history of mathematics and students’ interest in mathematics in senior high schools. The history of mathematics has a significant influence on students’ interest in learning mathematics (Clark & Schorcht, 2018). It could therefore be deduced that using the

history of mathematics in teaching will enhance students’ interest in mathematics, but students’ perception of mathematics could potentially intervene in this relationship. Integrating the history of mathematics in teaching mathematics improves students’ interest in mathematics (Mogari & Lupahala, 2013), which means that the history of mathematics has a significant effect on students’ perception of mathematics, mathematics perception of students’ also leads to students’ mathematics interest.

Finally, the study also identifies that mathematics perception partially mediates the relationship between peer-assisted learning and students’ interest in mathematics. From the path analysis estimates, it is found that peer-assisted learning has a significant positive effect on students’ mathematics interests, and also, peer-assisted learning has a significant positive effect on students’ perception of mathematics. In conclusion, peer-assisted learning has a direct effect on students’ perception of mathematics, mathematics perception also led to students’ interest in mathematics.

CONCLUSION

The study aims to determine the mediation role of students’ perceptions, in the relationship between the history of mathematics, peer-assisted learning, and student’s interest in mathematics in senior high schools. The study focused on 394 senior high students selected from four senior high schools in the Ashanti region of Ghana. After using SEM to estimate the model, it was found that the use of the history of mathematics had a significant positive effect on students’ interest in mathematics. Similarly, peer-assisted learning has a significant effect on students’ interest in mathematics. Also, the relationship between the history of mathematics and students’ interest in mathematics was partially mediated by students’ perception of mathematics. Finally, the relationship between peer-assisted learning and students’ interest in mathematics was partially mediated by students’ perception of mathematics.

Recommendations

As mathematics is a key to unlock the doors of learning other subjects, if students are good at mathematics, they are more likely to perform in other fields of study. Stakeholders should therefore pay attention to mathematics as a subject. As a managerial implication, the study recommends to the Ghana Education Service and the Ministry of Education to inculcate the use of history mathematics and peer-assisted learning, as part of the courses in training mathematics teachers in senior high schools. This will be achieved by educating teacher trainees with the use of the history of mathematics and peer-assisted learning in senior high schools in Ghana. When teachers are able to

use the history of mathematics concepts in teaching at the senior high school level, it could improve students' interest in learning mathematics. Using peer-assisted learning in schools will help students to understand and develop an interest in mathematics with the help of their peers. Also, schools which were not studied directly in this research, could also enhance their students' interest in mathematics by implementing the findings of these study.

Limitations

Firstly, the study was purely quantitative, providing no room for respondents to offer further details beyond the questionnaire. Future studies should either adopt a triangulation approach or qualitative approach, where respondents could offer their in-depth knowledge on the subject matter.

Also, the study was a cross-sectional survey, by gathering data from a specific point of time. This data was used in making predictions, through statistical methods. The data may however be inadequate to offer reliable predictions for long-term decision making. Future studies could adopt a longitudinal study, where secondary data on the subject matter could be gathered and studied over time.

Author contributions: All authors have sufficiently contributed to the study and agreed with the results and conclusions.

Funding: No funding source is reported for this study.

Declaration of interest: No conflict of interest is declared by authors.

Data sharing statement: Data supporting the findings and conclusions are available upon request from the corresponding author.

REFERENCES

- Amoako, T., Sheng, Z. H., Dogbe, C. S. K., & Pomegbe, W. W. K. (2020). Effect of internal integration on SMEs' performance: The role of external integration and ICT. *International Journal of Productivity and Performance Management*, 71(2), 643-665. <https://doi.org/10.1108/IJPPM-03-2020-0120>
- Ampofo, C. B. (2019). Relationship between pre-service teachers' mathematics self-efficacy and their mathematics achievement. *African Journal of Educational Studies in Mathematics and Sciences*, 15(1), 23-36. <https://doi.org/10.4314/ajesms.v15i1.3>
- Arthur, Y. D., Dogbe, C. S. K., & Asiedu-Addo, S. K. (2021). Modeling students' mathematics achievement and performance through teaching quality: SERVQUAL perspective. *Journal of Applied Research in Higher Education*. <https://doi.org/10.1108/JARHE-06-2021-0243>
- Arthur, Y. D., Dogbe, C. S. K., & Asiedu-Addo, S. K. (2022). Enhancing performance in mathematics through motivation, peer assisted learning, and teaching quality: The mediating role of student interest. *EURASIA Journal of Mathematics, Science and Technology Education*, 18(2), em2072. <https://doi.org/10.29333/EJMSTE/11509>
- Arthur, Y. D., Owusu, E. K., Asiedu-Addo, S., & Arhin, A. K. (2018). Connecting mathematics to real-life problems: A teaching quality that improves students' mathematics interest. *IOSR Journal of Research & Method in Education*, 8(4), 65-71.
- Baah-Duodu, S., Borbye, S., Someah-Addae, E., Cornelius Ennin, F., & Osei-Buabeng, V. (2021). Developing female pre-service teachers' mathematics self-efficacy by integrating history of mathematics into teaching during lesson study. *Social Education Research*, 3(1), 91-102. <https://doi.org/10.37256/ser.3120221011>
- Baki, A., & Gursoy, K. (2018). Does using history of mathematics make sense? The views of teacher candidates. *Journal of Pedagogical Research*, 2(2), 78-90.
- Butuner, S. O. (2020). An evaluation of activities based on the use of the history of mathematics as a tool. *Journal of Pedagogical Research*, 4(2), 139-164. <https://doi.org/10.33902/jpr.2020062216>
- Butuner, S. O., & Baki, A. (2020). The use of history of mathematics in the mathematics classroom: An action study. *International Journal of Education in Mathematics, Science and Technology*, 8(2), 92-117.
- Cai, J., & Hwang, S. (2020). Learning to teach through mathematical problems posing: Theoretical considerations, methodology, and direction for future research. *International Journal of Education Research*, 102, 101391 <https://doi.org/10.1016/j.jjeer.2019.01.001>
- Chu, H. C., Chen, J. M., & Tsai, C. L. (2017). Effects of an online formative peer-tutoring approach on students' learning behaviors, performance and cognitive load in mathematics. *Interactive Learning Environments*, 25(2), 203-219. <https://doi.org/10.1080/10494820.2016.1276085>
- Clark, K. M., & Schorcht, S. (2018). *Mathematics, education and history*. Springer. <https://doi.org/10.1007/978-3-319-73924-3>
- Dogbe, C. S. K., Bamfo, B. A., & Pomegbe, W. W. K. (2021). Market orientation and new product success relationship: The role of innovation capability, absorptive capacity, green brand positioning. *International Journal of Innovation Management*, 25(03), 2150033. <https://doi.org/10.1142/S136391962150033X>
- Duru, D. C., & Okeke, S. O. S. (2019). Predictive powers of learning styles, self-regulated learning skills and achievement motivation on secondary school students "Achievement in mathematics in Imo State". *UNIZIK Journal of STM Education*, 3(1), 82-90.

- Elshami, W., Abuzaid, M., & Abdalla, M. E. (2020). Radiography students' perceptions of peer-assisted learning. *Radiography*, 26(2), e109-e113. <https://doi.org/10.1016/j.radi.2019.12.002>
- Eze, E. (2021). Why secondary school geography students perform poorly in external examinations. *Journal of Geography*, 120(2), 51-60. <https://doi.org/10.1080/00221341.2020.1860114>
- Fornell, C., & Larcker, D. F. (1981). Evaluating structural equation models with unobservable variables and measurement error. *Journal of Marketing Research*, 18(1), 39-50. <https://doi.org/10.2307/3151312>
- Fung, F., Tan, C. Y., & Chen, G. (2018). Student engagement and mathematics achievement: Unraveling main and interactive effects. *Psychology in the Schools*, 55(7), 815-831. <https://doi.org/10.1002/pits.22139>
- Gulnaz, M., & Fatima, R. (2019). A study of finding the reasons of not choosing mathematics at senior secondary level by girls in Nawada district of Bihar. *Pedagogical Research*, 4(4), em0043. <https://doi.org/10.29333/pr/5899>
- Hagan, J. E., Amoaddai, S., Lawer, V. T., & Atteh, E. (2020). Students' perception towards mathematics and its effects on academic performance. *Asian Journal of Education and Social Studies*, 8(1), 8-14. <https://doi.org/10.9734/ajess/2020/v8i130210>
- Hair, J. F., Black, W. C., Babin, B. J., & Anderson, R. E. (2010). *Multivariate data analysis: A global perspective*. Pearson.
- Havens, P. S., & Williams, M. S. (2019). University peer-assisted learning strategies in the humanities. *Journal of College Reading and Learning*, 49(3), 160-169. <https://doi.org/10.1080/10790195.2019.1635371>
- Hoffmann, Y. T., da Costa, D. A., Nakamura, L. R., & Delizoicov Neto, D. (2019). Circulação inter e intracoletiva em grupos de pesquisa de história da educação matemática [Inter and intra-collective circulation in research groups on the history of mathematics education]. *Ciência & Educação (Bauru)* [Science & Education (Bauru)], 25(4), 1067-1080. <https://doi.org/10.1590/1516-731320190040014>
- Kucukoglu, U. (2019). *Ortaokul öğrencilerinin matematik tarihi bağlamında hazırladıkları dijital öyküler üzerine bir araştırma: Matematik nasıl doğmuştur? [A research on digital stories prepared by secondary school students in the context of mathematics history: How was mathematics born?]* [Unpublished master's thesis]. Kastamonu University.
- Leyva, E., Walkington, C., Perera, H., & Bernacki, M. (2022). Making mathematics relevant: An examination of student interest in mathematics, interest in STEM careers, and perceived relevance. *International Journal of Research in Undergraduate Mathematics Education*. <https://doi.org/10.1007/s40753-021-00159-4>
- Lit, C. K., Siu, M. K., & Wong, N. Y. (2001). The use of history in the teaching of mathematics: Theory, practice, and evaluation of effectiveness. *Education Journal*, 29(1), 17-31.
- Meke, K. D. P., Jailani, J., Wutsqa, D. U., & Alfi, H. D. (2019). Problem based learning using manipulative materials to improve student interest of mathematics learning. *Journal of Physics: Conference Series*, 1157(3), 032099. <https://doi.org/10.1088/1742-6596/1157/3/032099>
- Mogari, D., & Lupahla, N. (2013). Mapping a group of northern Namibian grade 12 learners' algebraic non-routine problem-solving skills. *African Journal of Research in Mathematics, Science and Technology Education*, 17(1-2), 94-105. <https://doi.org/10.1080/10288457.2013.826974>
- Mutodi, P., & Ngirande, H. (2014). The influence of students' perceptions on mathematics performance. A case of a selected high school in South Africa. *Mediterranean Journal of Social Sciences*, 5(3), 431. <https://doi.org/10.5901/mjss.2014.v5n3p431>
- Pomegbe, W. W. K., Li, W., Dogbe, C. S. K., & Otoo, C. O. A. (2020). Enhancing innovation performance of small and medium-sized enterprises through network embeddedness. *Journal of Competitiveness*, 12(3), 156-171. <https://doi.org/10.7441/joc.2020.03.09>
- Ponce Campuzano, J. C., Matthews, K. E., & Adams, P. (2017). On the use of history of mathematics: An introduction to Galileo's study of free-fall motion. *International Journal of Mathematical Education in Science and Technology*, 49(4), 517-529. <https://doi.org/10.1080/0020739X.2017.1377301>
- Rusmini, R. (2018). Peningkatkan minat belajar melalui layanan informasi pada siswa SMP [Increasing interest in learning through information services for middle school students]. *Jurnal Prakarsa Paedagogia [Journal of the Pedagogical Initiative]*, 1, 1. <https://doi.org/10.24176/jpp.v1i1.2609>
- Sahin, O., & Danaci, D. (2020). Investigating the effect of history-of-mathematics activities on middle-grade students' mental computation and opinions: An action research. *International Journal of Mathematical Education in Science and Technology*. <https://doi.org/10.1080/0020739X.2020.1857859>
- Santhanalakshmi, P. C., & Naomi, P. G. V. (2021). Impact of peer assisted learning strategy (PALS) for learning enhancement of students at secondary level. *Turkish Journal of Computer and Mathematics Education*, 12(10), 7333-7336.
- Sarsah, S. A., Tian, H., Dogbe, C. S. K., Bamfo, B. A., & Pomegbe, W. W. K. (2020). Effect of entrepreneurial

- orientation on radical innovation performance among manufacturing SMEs: The mediating role of absorptive capacity. *Journal of Strategy and Management*, 13(4), 551-570. <https://doi.org/10.1108/JSMA-03-2020-0053>
- Suan, J. S. (2014). Factors affecting underachievement in mathematics. *Global Summit on Education GSE 2014*, 2014(March), 4-5.
- Ufer, S., Rach, S., & Kosiol, T. (2017). Interest in mathematics=interest in mathematics? What general measures of interest reflect when the object of interest changes. *ZDM–Mathematics Education*, 49(3), 397-409. <https://doi.org/10.1007/s11858-016-0828-2>
- Varol, G. B. (2019). Sayılar ve işlemler öğrenme alanında matematik tarihi entegre edilmiş matematik öğretiminin başarıya etkisi [The effect of mathematics teaching integrated history of mathematics on the success of learning numbers and operations] [Unpublished master's thesis] Adnan Menderes University.
- WAEC. (2021). Press statement: Release of provisional results, West African Senior School Certificate Examination (WASSCE) for school candidates 2021. *West African Examinations Council*. <https://www.waecgh.org/article/167/-release-of-provisional-results-west-african-senior-school-certificate-examination-wassce-for-school-candidates-2021-/>
- Wood, T., Mazzocco, M. M. M., Calhoun, M. B., Crowe, E. C., & Connor, C. M. D. (2020). The effect of peer-assisted mathematics learning opportunities in first grade classrooms: What works for whom? *Journal of Research on Educational Effectiveness*, 13(4), 601-624. <https://doi.org/10.1080/19345747.2020.1772422>
- Yeh, C. Y. C., Cheng, H. N. H., Chen, Z. H., Liao, C. C. Y., & Chan, T. W. (2019). Enhancing achievement and interest in mathematics learning through Math-Island. *Research and Practice in Technology Enhanced Learning*, 14, 5. <https://doi.org/10.1186/s41039-019-0100-9>

<https://www.ejmste.com>