

GAMIFICATION AND A LOW-COST LABORATORY EQUIPMENT AIMED TO BOOST VAPOR COMPRESSION REFRIGERATION LEARNING

Patricia Aranguren^{1,2} , Daniel Sánchez³ , Álvaro Casi^{1,2} ,
Miguel Araiz^{1,2} , Leyre Catalán^{1,2} 

¹Engineering Department. Public University of Navarre (Spain)

²Smart Cities Institute (Spain)

³Department of Mechanical Engineering and Construction, Jaume I University (Spain)

*patricia.aranguren@unavarra.es, sanchezd@uji.es, alvaro.casi@unavarra.es,
miguel.arai@unavarra.es, leyre.catalan@unavarra.es*

Received August 2021

Accepted December 2021

Abstract

The nowadays European educational framework boosts applying the learned theoretical concepts to real situations. Hence, practice sessions are key resources to present students direct applications of the theoretical concepts shown in class. Thus, developing new educational equipment and practice sessions oriented to bringing theoretical knowledge closer to practice should be one of the objectives of teachers. The present work describes a solution proposed by lectures of two Spanish universities looking to increase the knowledge of their engineering students. Along the years, these docents have noticed the lack of connection between the theoretical and practical knowledge among their students, drastically harming their learning procedure. Thus, in order to deepen into practical learning, a teaching methodology involving low-cost prototypes of vapor compression systems and a gamification method to help the students understand the concepts is proposed. The proposed methodology is expected to make a big positive impact on the results obtained by the students, taking into account the preliminary results reached.

Keywords – Gamification, Mechanical engineering, Engagement, Higher education, Laboratory, STEM.

To cite this article:

Aranguren, P., Sánchez, D., Casi, A., Araiz, M., & Catalán, L. (2022). Gamification and a low-cost laboratory equipment aimed to boost vapor compression refrigeration learning. *Journal of Technology and Science Education*, 12(1), 204-216. <https://doi.org/10.3926/jotse.1458>

1. Introduction

Scientific literacy describes people's knowledge on science (DeBoer 2000). Dewey argued that inquiry-based learning presents real experiences using scientific ways of building knowledge or solving problems (Dewey 1904), as many authors have already studied (Lawrie, Grøndahl, Boman & Andrews 2016; Schmidt & Fulton 2016; Toma & Greca 2018; Srisawasdi & Panjaburee 2019). Thus, the actual European educational framework boosts applying the learned theoretical concepts to real situations. Hence, the teaching process should be oriented to developing skills, competences and abilities to make the

latter possible (Sarasola, Rojas & Okariz, 2015; Schmidt & Fulton 2016; Simpson, Burris & Maltese, 2017; Radloff & Capobianco 2019). Therefore, practice sessions are key resources to present students direct applications of the theoretical concepts shown in class (Starr, Hunter, Dunkin, Honig, Palomino & Leaper, 2020; Wu, Van Veen & Rau, 2020).

Practice sessions are present at most of the technical subjects at university. Nevertheless, most of the times the equipment used is very expensive and the students need to gather around machines without having the opportunity to experiment by their selves the usage of these equipment. In order to solve these inconveniences many authors have developed prototypes that could be handled by a single student due to their low cost and availability. A thermoelectric test bench used to teach thermoelectric cooling and generation was developed by Rodriguez, Astrain, Martínez, Aranguren and Pérez (2013), a vapor compression facility with glass-made heat exchangers that shows the evaporation and condensation processes by Sánchez, Patiño, Cabello, Llopis and Torrella (2015), heat and temperature experiments designed by Prima, Utari, Chandra, Hasanah and Rusdiana (2018) and a solar dryer for microalgae retrieval designed by Malheiro, Castro-Ribeiro, Silva, Caetano, Ferreira and Guedes (2015) are some examples that can be found in the literature.

The availability of prototypes during practice session is as important as developing learning methods to motivate students to acquire the knowledge. The gamification of learning is a widely used methodology that motivates engagement and participation among students (André-Ribeiro, Leal da Silva & Quadrado-Mussi, 2018; Oliveira & Bittencourt 2019, Bodnar, Anastasio, Enszer & Burkey, 2016) and much research done confirms the benefits of this methodology (Gil & Otero 2016; Huang, Ritzhaupt, Sommer, Zhu, Stephen, Valle et al., 2020). Thus, the programming of practice sessions, both methodologically and physically is vital to achieve their mission: to gather practical and theoretical knowledge.

Nowadays, the most extended technology to produce artificial production of refrigeration is vapor compression. Vapor compression systems are used to reduce, or maintain, the temperature of an enclosure or a particular area. These systems can be found at a wide variety of applications, from big supermarkets to our homes. The large scale of this sector, 1500 million domestic refrigerators worldwide and 55 million stand-alone refrigeration systems for commercial refrigeration (Clodic, Pan, Devin, Michineau & Barrault, 2013), emphasizes the necessity of successfully teaching this topic to the engineers of the future.

Thus, this manuscript presents a teaching methodology that includes a gamification process and a low-cost vapor compression system that aims to gather theoretical and practical knowledge.

2. Teaching Methodology

The lack of practical knowledge among engineering students is a common problem encountered by teachers. The impossibility of recognizing the main elements of an equipment, or the challenge of using the theoretical knowledge on the use of a real machine are very common attitudes when students face practice sessions. Thus, teachers from two universities have gathered and developed a teaching methodology specially designed to enrich refrigeration teaching. This teaching methodology employs game design elements to improve student engagement into refrigeration learning, explained during “Section 3. Gamification method”. Moreover, a low-cost vapor compression refrigeration facility (ITF CAN COOLER) is designed in order to provide students with the proper equipment to develop the practical learning. The description of the laboratory prototype can be found during “Section 4. Low-cost laboratory equipment design”, where the scientific foundation, the elements, control and measuring system, DAQ system, how to determine its performance and its cost are described.

Figure 1 includes the steps of the cyclical methodology. Firstly, a test using interactive presentation software is developed in class. Secondly, during the first lab session students are asked to identify the elements of the laboratory equipment specially design for this methodology. Besides, students need to

follow and fill a lab report to get used to the operation of the prototype. During the third step students face a challenge that needs to be fulfilled in the most efficient manner. The last step turns back to the beginning, the students are asked the same questions that were asked during the first step to see if the methodology developed successfully meets the stipulated objectives.

Finally, “Section 5. Findings” includes the obtained results when applying the described methodology, based on three subjects where the teaching methodology has been tested and more than 150 students that have experienced both, the gamification method and the low-cost laboratory prototype developed, ITF CAN COOLER.

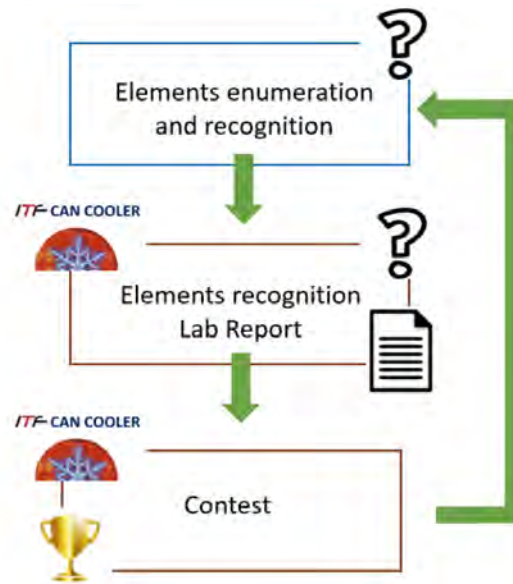

Figure 1. Methodology steps

3. Gamification Method

The steps of the teaching methodology described in the previous section have been designed applying the characteristics of game elements. Consequently, students improve in engagement, learning, knowledge retention, evaluation and productivity among others (André-Ribeiro et al. 2018).

3.1. Preparation in Class

In a class session students are asked to group in fours. Each group has to use a cell phone to join an online questionnaire (Figure 2). The questionnaire has two parts; during the first one, the students face an open question: “Enumerate the elements of a vapor compression system”. Students are supposed to work in groups, discussing the possible solutions and typing the agreed ones. At this part, students are given 5 minutes to think and type as many elements as they can recall. Right after the time is over, the results given by the students are put in common for the whole class. Time is given to read all the elements and comment any inconvenience encountered. This first part prepares students for the second part of the questionnaire.

During the second part of the questionnaire, a picture of a domestic refrigerator is shown where numbers are added near each element of the system. Students are asked to fill each number description in the same groups. The duration of this second part is 6 minutes. During this time students are encouraged to think and comment among the members of each team about the possible solutions. Additionally, answers of the test are discussed with students to reinforce the misunderstood aspects.

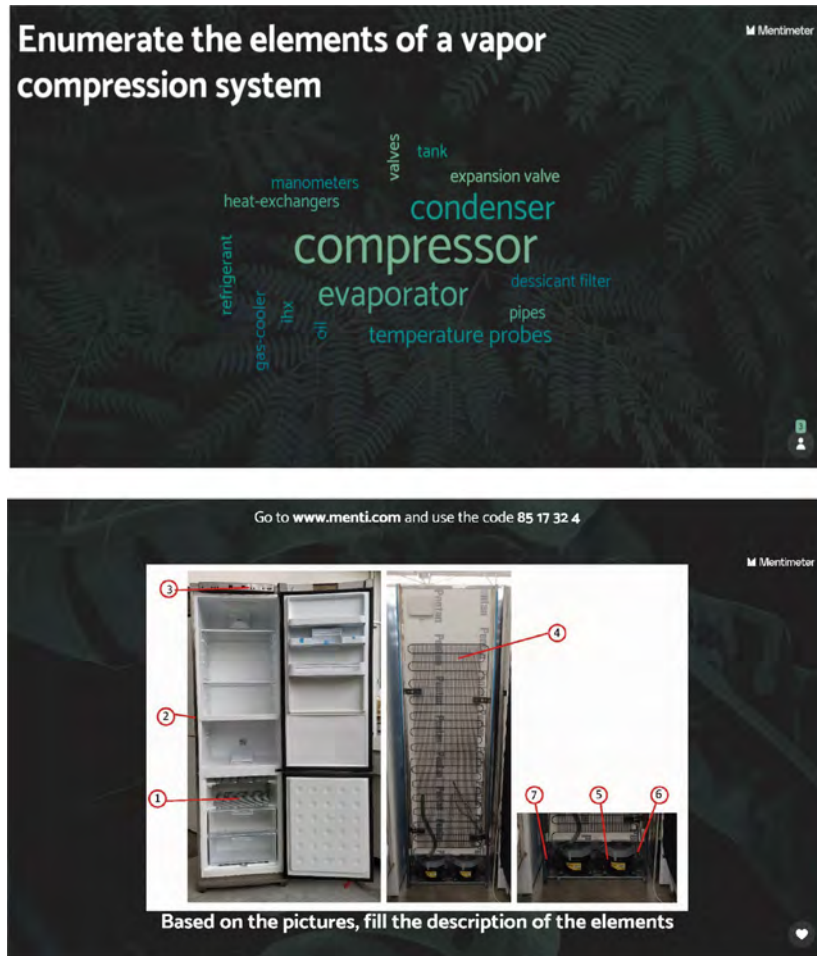

Figure 2. Two parts of the test developed by the students

3.2. Laboratory Session

The first laboratory session is used as a first approach to a real refrigeration system. For this purpose, specially tailored prototypes, as the one described along next section, are used. The low-cost of these prototypes and their easiness of construction ease the teaching methodology proposed. Besides, their design enables students to modify different parameters, such as the set point temperature and the condensation and evaporation levels.

Students are grouped in fours for this session. Each group has an ITF CAN COOLER prototype to develop this session. Firstly, each pair is asked to fill a questionnaire where they have to identify the elements of the tailored prototype and draw the schematic of the system. To that purpose, the prototypes are labeled as Figure 3 shows. Each system has a total of 10 main components labeled from A to J, including the compressor, evaporator, condenser, dryer filter, as it can be shown in Figure 3.

Revising and discussing about the answers given by the students, the real cooling facility is being introduced to the students. Hence, students are prepared for the second part of the laboratory session, the Lab Report, which can be consulted in Figure 4. The report presents two distinguished parts, during the first one they realize about the influence of modifying the evaporating level on the interior temperature and the thermal load temperature. During the second part, the condensing level influence is evaluated. Students have one hour to fulfill the report that has to be handed at the end of the session.

The objective of this report is to introduce the use of the tailored prototype to students. Fixing the set point temperature and varying the variables of the system, they gain knowledge on how the prototype behaves and besides they get to know where to consult temperatures, consumptions and how to manipulate the prototype.

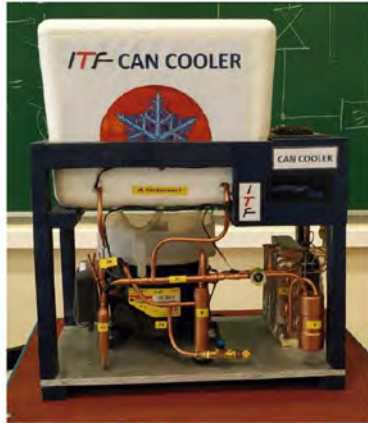

A	Evaporator	F	Gas receiver
B	Expansion system	G	Charging valve
C	Dryer filter	H	Sight-glass
D	Hermetic compressor	I	Liquid receiver
E	Internal heat exchanger	J	Condenser

Figure 3. Main elements of the prototypes



LAB REPORT: ITF CAN COOLER		
Duration: 60 minutes		
Date:		
Names:		
Fixed variables:	$T_{set_point} = 0\ ^\circ C$	
<p>Varying the voltage supplied to the fans of the evaporator, plot the air and product temperatures vs the percentage of the fans:</p> <div style="text-align: center;"> ● Air temperature ● Product temperature </div> 		
<p>Varying the voltage supplied to the fan of the condenser, plot the air and product temperatures vs the percentage of the fan:</p> <div style="text-align: center;"> ● Air temperature ● Product temperature </div> 		

Figure 4. Lab report

3.3. Contest

The second lab session corresponds with the contest. All the students are challenged to obtain a product temperature lower than 3 °C with the minimum power consumption possible. To that purpose, students are given 60 minutes to try to reach the desired point, always trying to optimize the efficiency of the system. At the end of the period, they have to communicate their power consumption and temperatures and wait for the jury verdict. If a group obtains a temperature for the thermal load higher than 3 °C, this team is directly disqualified. Among the groups that have reached the objective, the one who has a minimum electrical consumption wins. Moreover, the winning group obtains 0.5 extra points for the final evaluation.

This game helps students to engage into learning without noticing, as the idea of obtaining extra points for the final evaluation is very enticing for them. Besides, as no one is punished, everyone keeps the positive feeling of the activity, trying to learn how the winners obtained that minimal consumption.

3.4. Methodology Evaluation

The final step is to evaluate if the proposed methodology helps students to connect theoretical concepts with real devices. Hence, the first questionnaire is repeated during a class session to compare the results and obtain conclusions. Preliminary results obtained are very positive about the results, as this second test gets better results than the one developed during the first step of the methodology. “Section 5. Findings” further describes the academic results obtained by the application of the proposed gamification.

4. Low-cost Laboratory Equipment Design

The ITF CAN COOLER is the tailored prototype design to fulfill the methodology along Sections 2 and 3. This refrigeration system is a single-stage vapor compression cycle specially designed to clearly present all its elements and to be easily manipulated modifying parameters such as the set point temperature and the evaporation and condensing temperatures. The strong points of this facility are: easiness of operation and low cost, very important aspects for the teaching methodology proposed.

4.1. Theoretical Foundation

Vapor compression refrigeration is the most widely used technology for air conditioning and refrigeration. Vapor compression uses a circulating refrigerant as the medium that absorbs and removes heat from the space to be cooled and subsequently rejects heat elsewhere. To that purpose, the refrigerant that circulates along the cycle, continuously undergoes phase change. Four are the main elements of these systems: compressor, condenser, expansion valve and evaporator, as Figure 5 shows. The compressor increases the pressure of the refrigerant consuming electrical energy (\dot{W}_e), the condenser evacuates heat (\dot{Q}_k) and condenses the refrigerant, the expansion valve drastically reduces its pressure and the evaporator absorbs heat from the enclosure (\dot{Q}_o), reducing its temperature, and evaporating the refrigerant.

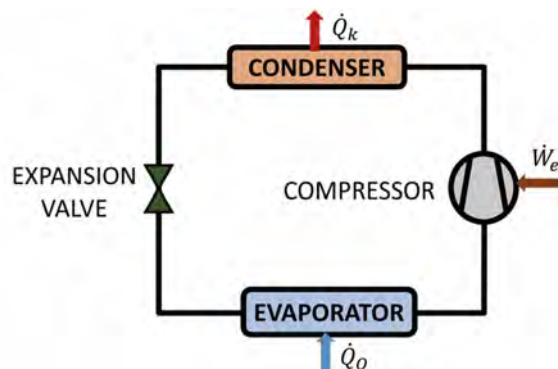

Figure 5. Schematic of the cooling system

The Coefficient of Performance (COP) of the system is the ratio of cooling provided by the system (\dot{Q}_o) to energy required (\dot{W}_e). A higher COP value corresponds to a higher efficiency of the system, as a lower energy consumption obtains the same cooling capacity. Equation (1) introduces this term.

$$COP = \frac{\dot{Q}_o}{\dot{W}_e} \quad (1)$$

4.2. System Description

The vapor compression system consists of a single-stage vapor compression cycle composed by a R600a compressor, Danfoss/SECOP TLX5.7KK.3, (1); an air-cooled condenser with a variable axial fan (2); a small liquid receiver (3); a small counter-flow internal heat exchanger (IHX) (4); a dryer filter (5) brazed to a capillary tube (6); an air evaporator (7); and an additional receiver (8) to avoid liquid at the compressor suction port. Additionally, the facility has a sight-glass (9) to let the students see the flow of refrigerant through the system. Furthermore, the facility counts with two manometers, six temperature probes, a wattmeter and a combined humidity-temperature transducer. All these measuring elements, as well as the elements that conform the cooling system, are depicted in the cycle diagram of Figure 6.

The cooling system is composed by a total of ten elements. The enclosure meant to be cooled down is a polystyrene box with external dimensions of $330 \times 260 \times 270$ mm and an average wall thickness of 22 mm. The evaporator presents 8 finned copper pipes serially connected with a total length of 1300 mm and an inner diameter of 1/4 inch. In order to let the students see the evaporator, a methacrylate film has been located above it at the bottom of the enclosure, as Figure 7 (a) presents. The air inside the enclosure is driven by four small fans that force the circulation of the air along the finned tubes of the evaporator. The velocity of these fans can be varied by the students to obtain different evaporating levels.

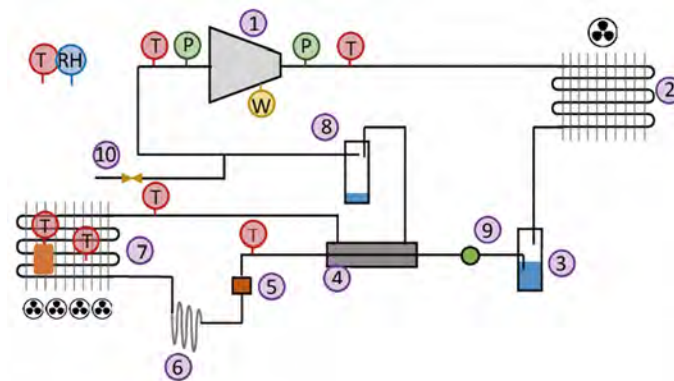

Figure 6. Schematic of the cooling system

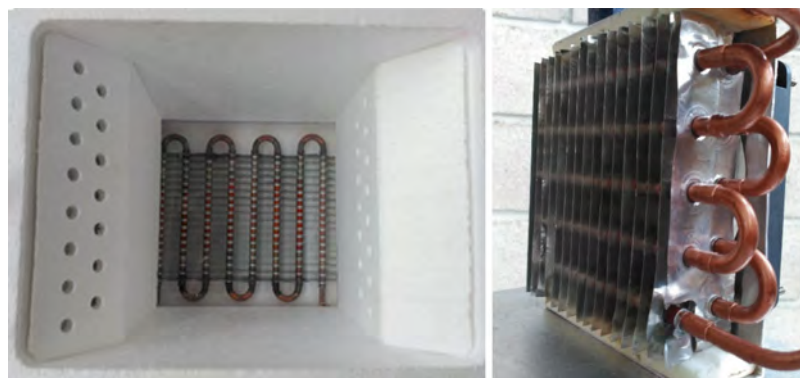

Figure 7. (a) Evaporator of the cooling system, (b) Condenser.

The compressor was recycled from a domestic refrigerator. In this case a Danfoss® hermetic reciprocating compressor (TLES5.7KK.3) designed for isobutane (R600a) with a displacement of 5.7 cm³ is used. The condenser is a finned-coil heat exchanger formed by 10 finned copper pipes serially connected with an inner diameter of 1/4 inch, a total length of 1600 mm and a fan, as Figure 7 (b) presents. The velocity of this fan can be modified obtaining different condensing levels. A liquid-receiver at the condenser exit stores and manages the refrigerant mass in the cycle ensuring the presence of liquid in the expansion device. The expansion device is made with a capillary tube calculated to allow the system working at temperatures as low as -10 °C. The internal diameter of the capillary is 0.7 mm and its length is 600 mm. Since the capillary-tube does not provide a useful superheating control, an internal heat exchanger (IHX) and a second liquid receiver were included. The length of this heat exchanger is 80 mm with inner and outer diameters of 1/4 inch and 3/8 inch, respectively. Finally, the cooling circuit has a dryer-filter located at the entry of the capillary which guarantees the absence of water in the refrigerant flow, and a sight-glass installed before entering the internal heat exchanger, which allows determining the refrigerant level in the system.

4.3. Control and Measuring System

The refrigeration system is completely monitored with several measurement devices connected to a low-cost data acquisition system (DAQ) based on Arduino® that shows in a LCD screen the experimental data in real time. Additionally, the laboratory equipment is provided with different control devices to modify the inner temperature of the enclosure and the evaporation and condensation temperatures. Figure 8 includes the front and the upper part of the ITF CAN COOLER laboratory equipment where the measurement display and the control panels are outlined. Two screens show the temperature, relative humidity and power consumption of the utility, while two selectors let the user modify the speed of the fans of the evaporator and condenser. Moreover, a temperature controller enables students to set the temperature at the interior of the enclosure with an ON/OFF control logic.

The system is equipped with six NTC temperature probes located along the cycle: in the suction and discharge lines, at the inlet of the capillary tube, outlet of the evaporator and inside the enclosure to measure the inner temperature and the temperature of the thermal load. Moreover, a combined humidity-temperature sensor has been installed on the control panel to measure the conditions of the ambient. Additionally, a power analyzer and two manometers have been installed to measure the electric parameters of the compressor, and the condensing and evaporating relative pressures of the system (barg).

The measuring and control systems provide the facility with versatility to operate the system under different working operations, giving the student the opportunity to see how the different parameters of the system influence its operation.



Figure 8. Front (a) and detail of the upper part (b)

4.4. Data acquisition System (DAQ)

Arduino is used to manage some measurement elements due to three reasons: its low cost, its simplicity of programming and implementation, and its flexibility and versatility. The board used is Arduino® ATmega2560 which has 54 digital inputs/outputs, 16 analog inputs, 256 kB internal memory, a clock speed of 16 MHz and a supply voltage necessity of 7-12 VDC.

The signal of the six thermistors and the combined humidity-temperature transducer are the inputs of the Arduino® platform which displays on a LCD screen the eight values thanks to the developed code that reads the measurements, converts them when necessary, and displays them. The Wattmeter has its own screen that displays the voltage, current, power and energy measurements. Additionally, the manometers are not connected to the DAQ system since they are mechanical, so they values are read directly.

4.5. Performance of the System

The performance of the system can be easily calculated thanks to the data acquisition system developed and the datasheet of the compressor. Equation (1) defines the COP of the system as the ratio of cooling capacity to energy consumed. The energy consumed by the compressor is directly measured by the Wattmeter that is included into the DAQ system and the cooling capacity can be obtained using equation (2). The mass flow of the refrigerant (\dot{m}_{ref}) can be approximated using the expression included in Equation (3). This expression has been obtained using the datasheet of the compressor, where T_{suc} corresponds to the suction temperature measured in °C, P_{suc} to the suction pressure, in bars, and t to the compression ratio. The maximum error of the approximated mass flow is the 0.27 %.

In order to calculate the cooling capacity of the prototype, the parameters that define the mass flow (Equation (3)) and the inlet and outlet enthalpies of the evaporator. The enthalpy at the inlet (h_{in}) of the evaporator is obtained considering isenthalpic expansion and the enthalpy at the exit of the evaporator is obtained measuring the temperature and pressure at that point (h_{out}).

$$\dot{Q}_o = \dot{m}_{ref}(h_{out} - h_{in}) \quad (2)$$

$$\dot{m}_{ref} = 2.80283 \cdot 10^{-6} \cdot T_{suc} + 0.00054175 \cdot P_{suc} - 4.28916 \cdot 10^{-6} \cdot t \quad (3)$$

The COP values of the ITF CAN COOLER prototype for an interior temperature of -10 °C, an ambient temperature of 17 °C and different velocities of the fans located at the evaporator and condenser, which can be modified using the selectors located at the control panel, can be consulted in Table 1. The highest COP value of the prototype is 2.08, and it can be seen how the COPs worsen when lower velocities of the fans are tested.

T_{int} (°C)	T_{amb} (°C)	Fans	T_{suc} (°C)	P_{suc} (bar)	t	\dot{m}_{ref}	\dot{Q}_o (W)	\dot{W}_e (W)	COP
-10	17	100 %	1.81	0.755	4.867	0.000393	121.16	58.2	2.08
-10	17	75 %	2.24	0.725	5.068	0.000377	115.89	57.6	2.01
-10	17	50 %	2.35	0.702	5.235	0.000377	112.54	57	1.97

Table 1. COP values of the ITF CAN COOLER

4.6. Cost of the Equipment

This portable laboratory equipment is designed in a low-cost format. Most of the elements used could be obtained reusing equipment from obsolete systems such as refrigerators or electronic devices, or could be purchased for a low price. Table 2 includes the approximate cost of the main systems of the cooling facility, the materials, the cooling system itself, the measuring and control systems and the DAQ system. The low-cost of the prototype assures that any higher education center could build this system to accomplish the teaching methodology proposed.

Elements	Cost
Materials for the rack (wood, nails...)	15 €
Cooling system	165 €
Measuring and control systems	60 €
DAQ system	25 €
Total	265 €

Table 2. Approximate cost of the laboratory equipment

5. Findings

This Section describes the satisfactory results obtained when applying the teaching methodology to three different groups of students of the Public University of Navarre. The methodology was firstly implemented during the 2020/2021 academic year in three subjects: *Thermal Engineering* and *Industrial Cooling* taught in the Bachelor's degree in Industrial Engineering and *Heating and Cooling Machines and Installations* taught in the Bachelor's degree in Mechanical Engineering. Table 3 includes the number of students enrolled in each subject and the number of laboratory groups in which each subject is divided. A total of 153 students, divided in 39 laboratory groups, tested for the first time the proposed methodology. Figure 9 includes some pictures of the lab sessions where students are completely immersed into the game of learning.

Subject	Type of subject	Year	Number of students	Number of laboratory groups
Thermal Engineering (TE)	Mandatory	4th	63	16
Industrial Cooling (IC)	Optative	4th	18	5
Heating and Cooling Machines and Installations (H&C)	Mandatory	3rd	72	18

Table 3. Student enrollment



Figure 9. Pictures of the laboratory sessions

Results show that the presented methodology was beneficial for the students. Figure 10 includes the marks obtained by the laboratory groups at the initial test done before the lab sessions and the results of the final test done after the laboratory sessions. The numbers that can be found on the external ring are the marks obtained by the groups, while the size of each sector stands for the number of groups that obtained that mark. Additionally, “TE” stands for Thermal Engineering, “IC” Industrial Cooling and “H&C” is Heating and Cooling Machines and Installations. During the first test, obtaining a 4 or a 6 was quite common, while obtaining 8s was more common during the final test.

The average mark obtained by all the students at the initial test was a 5 while the mark for the final test was 7.7, an improvement of 2.7 points. If the marks are studied by subjects, the average grade for TE was 5, 5.7 for IC and 4.8 for H&C at the initial test, meanwhile for the final test the marks were: 7.5; 8; and 7.8, respectively, with improvements of 2.5; 2.3 and 3, respectively. Numbers justify the new methodology implemented, as marks greatly increased after making the students use a tailored laboratory equipment within a gamification methodology.

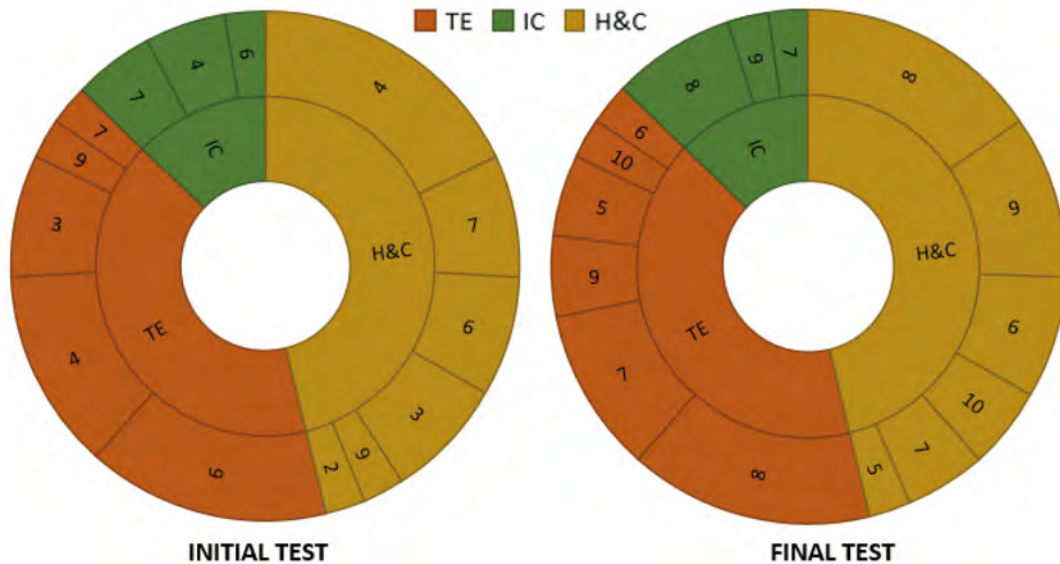

Figure 10. Marks obtained by the laboratory groups at the initial and final test

Not only marks improved after the lab sessions that were specially designed to work vapor compression systems, but also students were very satisfied with these sessions. After every subject is finished, the students have the opportunity to fill a survey to rate the teacher attitude; the gained knowledge and how classes were prepared and thought. The tailored lab sessions were mentioned in several occasions: “The practical sessions where vapor compression systems were worked were very interesting”; “Practical sessions helped me to understand theory concepts”; “I found the methodology used for the laboratory sessions very different from others”; “I would have loved to devote more time to the practical sessions”; “I liked to be able to touch a vapor compression system and see its components and how they work”; “I like the idea of using cell phones during class time”.

Consequently, it could be affirmed that the teaching methodology is a complete success. The combination of the gamification method and the tailored laboratory prototype achieves a deeper understanding of vapor compression systems, the purpose of the teaching methodology.

6. Conclusions

A teaching methodology is presented along this manuscript to make sure students relate theoretical knowledge and real machines. A gamification methodology composed by four steps is presented along with a tailored design of a cooling system prototype to accomplish the objective of the methodology. Preliminary results are very promising, as students have reacted very positively to the teaching methodology and the preliminary results show improvements on knowledge acquisition.

The teachers involved in the design of this methodology are happy to see how it works, and they definitely are going to introduce this combined methodology to other subjects where vapor compression systems are studied. Besides, these teachers encourage other docents to introduce tailored laboratory sessions using gamification methodologies to help students to acquire theoretical concepts.

Declaration of Conflicting Interests

The authors declared no potential conflicts of interest with respect to the research, authorship, and/or publication of this article.

Funding

The authors are indebted to the Spanish Ministry of Science, Innovation and Universities, and European Regional Development Fund for the economic support to this work, included in the RTI2018-093501-B-C21 and RTI2018-093501-B-C22 research projects and to the Public University of Navarre for the economic support to this work included in the PJUPNA2003 research project.

References

- André-Ribeiro, L., Leal da Silva, T., & Quadrado-Mussi, A. (2018). Gamification: a methodology to motivate engagement and participation in a higher education environment. *International Journal of Educational Research*, 6, 249-264
- Bodnar, C.A., Anastasio, D., Enszer, J.A., & Burkey, D.D. (2016). Engineers at Play: Games as Teaching Tools for Undergraduate Engineering Students. *Journal of Engineering Education*, 105, 147-200. <https://doi.org/10.1002/jee.20106>
- Clodic, D., Pan, X., Devin, E., Michineau, T., & Barrault, S. (2013) *Alternative to high GWP in refrigeration and air-conditioning applications*. ADEME, AFCE, UNICLIMA.
- DeBoer, G.E. (2000). Scientific Literacy: Another look at its historical and contemporary meanings and its relationship to science education reform. *Journal of Research in Science Teaching*, 37, 582-601. [https://doi.org/10.1002/1098-2736\(200008\)37:6<582::AID-TEA5>3.0.CO;2-L](https://doi.org/10.1002/1098-2736(200008)37:6<582::AID-TEA5>3.0.CO;2-L)
- Dewey, J. (1904). *The relationship between theory and practice in teacher education*. University of Chicago Press.
- Gil, M., & Otero, B. (2016). *Gamification-Based E-Learning Strategies for Computer Programming Education* (14-29). <https://doi.org/10.4018/978-1-5225-1034-5.ch002>
- Huang, R., Ritzhaupt, A.D., Sommer, M., Zhu, J., Stephen, A., Valle, N. et al. (2020). The impact of gamification in educational settings on student learning outcomes: a meta-analysis. *Educational Technology Research and Development*, 68, 1875-1901. <https://doi.org/10.1007/s11423-020-09807-z>
- Lawrie, G.A., Grøndahl, L., Boman, S., & Andrews, T. (2016). Wiki Laboratory Notebooks: Supporting Student Learning in Collaborative Inquiry-Based Laboratory Experiments. *Journal of Science Education and Technology*, 25, 394-409. <https://doi.org/10.1007/s10956-016-9601-0>
- Malheiro, B., Castro-Ribeiro, C., Silva, M.F., Caetano, N.S., Ferreira, P., & Guedes, P. (2015). Learning sustainability by developing a solar dryer for microalgae retrieval. *Journal of Technology and Science Education*, 5, 254-271. <https://doi.org/10.3926/jotse.206>
- Oliveira, W., & Bittencourt, I.I. (2019). *Tailored gamification to educational technologies*. Springer. <https://doi.org/10.1007/978-981-32-9812-5>
- Prima, E.C., Utari, S., Chandra, D.T., Hasanah, L. & Rusdiana, D. (2018). Heat and temperature experiment designs to support students' conception on nature of science. *Journal of Technology and Science Education*, 8, 453-472. <https://doi.org/10.3926/jotse.419>
- Radloff, J., & Capobianco, B. (2019). Investigating Elementary Teachers' Tensions and Mitigating Strategies Related to Integrating Engineering Design-Based Science Instruction. *Research in Science Education*, 51, 213-232. <https://doi.org/10.1007/s11165-019-9844-x>

- Rodríguez, A., Astrain, D., Martínez, Á., Aranguren, P., & Pérez, M.G. (2013). Development and experimental validation of a thermoelectric test bench for laboratory lessons. *Journal of Technology and Science Education*, 3(3), 113-121. <https://doi.org/10.3926/jotse.84>
- Sánchez, D., Patiño, J., Cabello, R., Llopis, R., & Torrella, E. (2015). Development and implementation of a low-cost data acquisition system based on Arduino for refrigeration facilities. In *7th International Conference on Education and New Learning Technologies* (4226)
- Sarasola, A., Rojas, J.F., & Okariz, A. (2015). Training to Use the Scientific Method in a First-Year Physics Laboratory: A Case Study. *Journal of Science Education and Technology*, 24, 595-609. <https://doi.org/10.1007/s10956-015-9551-y>
- Schmidt, M., & Fulton, L. (2016). Transforming a Traditional Inquiry-Based Science Unit into a STEM Unit for Elementary Pre-service Teachers: A View from the Trenches. *Journal of Science Education and Technology*, 25, 302-315. <https://doi.org/10.1007/s10956-015-9594-0>
- Simpson, A., Burris, A., & Maltese, A. (2017). Youth's Engagement as Scientists and Engineers in an Afterschool Making and Tinkering Program. *Research in Science Education*, 50, 1-2. <https://doi.org/10.1007/s11165-017-9678-3>
- Srisawasdi, N., & Panjaburee, P. (2019). Implementation of Game-transformed Inquiry-based Learning to Promote the Understanding of and Motivation to Learn Chemistry. *Journal of Science Education and Technology*, 28, 152-164. <https://doi.org/10.1007/s10956-018-9754-0>
- Starr, C.R., Hunter, L., Dunkin, R., Honig, S., Palomino, R., & Leaper, C. (2020). Engaging in Science Practices in Classrooms Predicts Increases in Undergraduates' STEM Motivation, Identity, and Achievement: A Short-Term Longitudinal Study. *Journal of Research in Science Teaching*, 57(7), 1093-1118. <https://doi.org/10.1002/tea.21623>
- Toma, R.B., & Greca, I.M. (2018). The effect of integrative STEM instruction on elementary students' attitudes toward science. *Eurasia Journal of Mathematics, Science and Technology Education*, 14, 1383-1395. <https://doi.org/10.29333/ejmste/83676>
- Wu, S.P.W., Van Veen, B., & Rau, M.A. (2020). How drawing prompts can increase cognitive engagement in an active learning engineering course. *Journal of Engineering Education*, 109, 723-742. <https://doi.org/10.1002/jee.20354>

Published by OmniaScience (www.omniascience.com)

Journal of Technology and Science Education, 2022 (www.jotse.org)



Article's contents are provided on an Attribution-Non Commercial 4.0 Creative commons International License.

Readers are allowed to copy, distribute and communicate article's contents, provided the author's and JOTSE journal's names are included. It must not be used for commercial purposes. To see the complete licence contents, please visit <https://creativecommons.org/licenses/by-nc/4.0/>.