

THE
THORNDIKE
ARITHMETICS



BOOK THREE

COMMON MEASURES

Length

12 inches = 1 foot (ft.)
3 feet = 1 yard (yd.)
16½ feet = 1 rod (rd.)
320 rods = 1 mile (mi.)
1720 yards = 1 mile
5280 feet = 1 mile

Area

144 sq. in. = 1 square foot (sq. ft.)
9 sq. ft. = 1 sq. yard (sq. yd.)
272¼ sq. ft. = 1 square rod (sq. rd.)
160 sq. rd. = 1 acre (A.)
640 acres = 1 square mile (sq. mi.)
A section of land = 1 sq. mi.

Capacity or Volume

1728 cu. in. = 1 cubic foot (cu. ft.)
27 cu. ft. = 1 cubic yard (cu. yd.)

Dry Measure

2 pints = 1 quart (qt.)
8 quarts = 1 peck (pk.)
4 pecks = 1 bushel (bu.)

Liquid Measure

4 gills = 1 pint (pt.)
2 pints = 1 quart (qt.)
4 quarts = 1 gallon (gal.)

Weight

16 ounces = 1 pound (lb.)
2000 pounds = 1 ton (T.)
A *long ton* = 2240 lb.

Standard Weights of 1 Bushel

Wheat = 60 lb.
Corn = 56 lb.
Oats = 32 lb.
Barley = 48 lb.
Potatoes = 60 lb.

OTHER MEASURES

A *barrel* of flour contains 196 lb.
A *perch* of stone contains 24¾ cu. ft.
A *standard gallon* contains 231 cu. in.
A *standard bushel* contains 2150.42
cu. in.

$\pi = 3.1416$ or $\frac{22}{7}$
A right angle = 90 degrees
A circumference = 360 degrees
10 mills = 1 cent

365 days = 1 year
Leap years have 366 days
Sept., Apr., June, and Nov. have
30 days
Feb. has 28 days in regular years,
29 in leap years

1 kilogram = 1000 grams
1 kilogram = 2.205 lb.
1 kilometer = 1000 meters
1 meter = 39.37 inches
1 kilowatt = 1000 watts

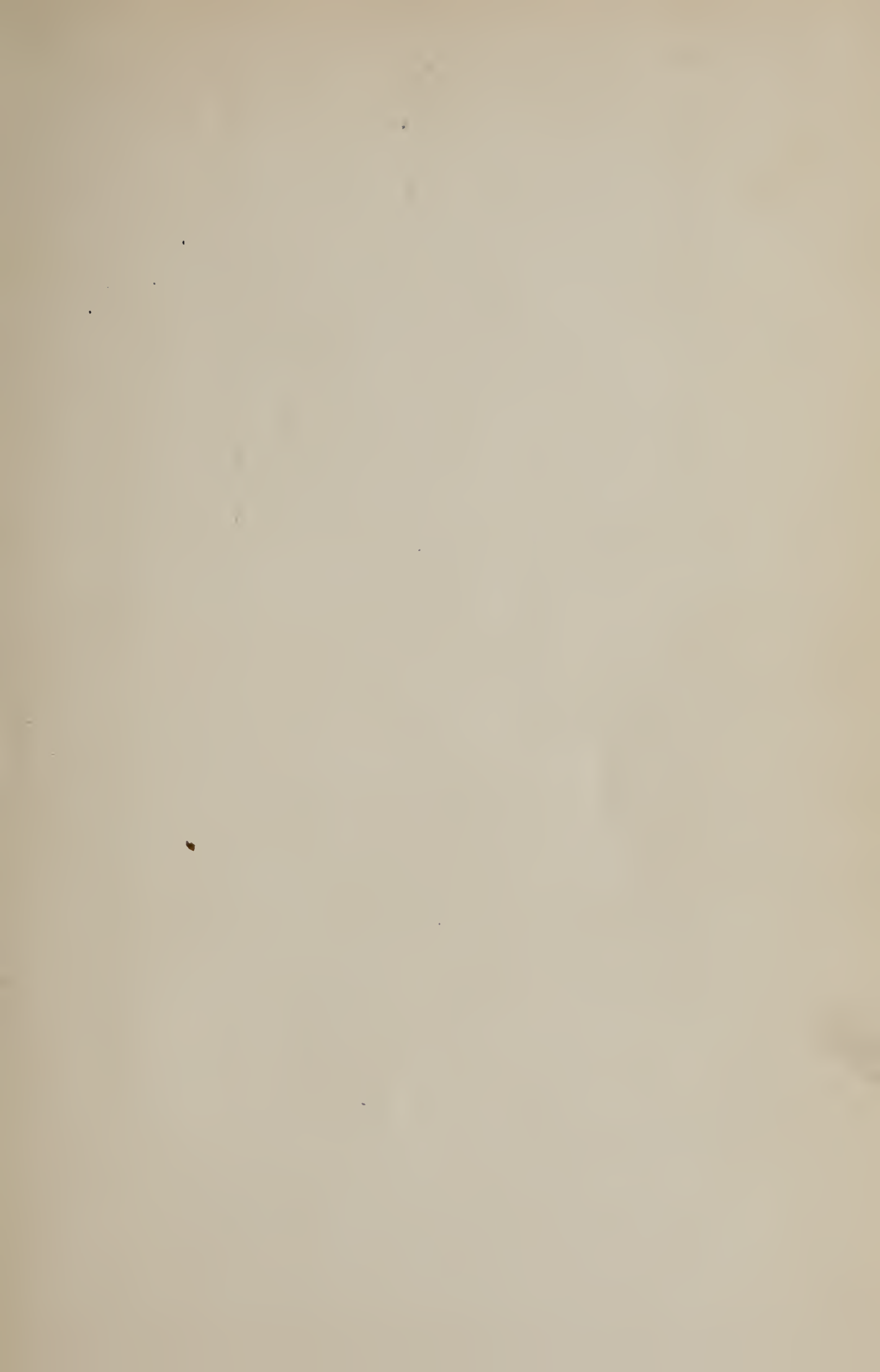

THE THORNDIKE ARITHMETICS

BOOK THREE

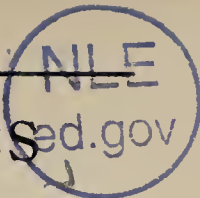

THE THORNDIKE ARITHMETICS

BOOK THREE

By

EDWARD LEE THORNDIKE
Teachers College, Columbia University

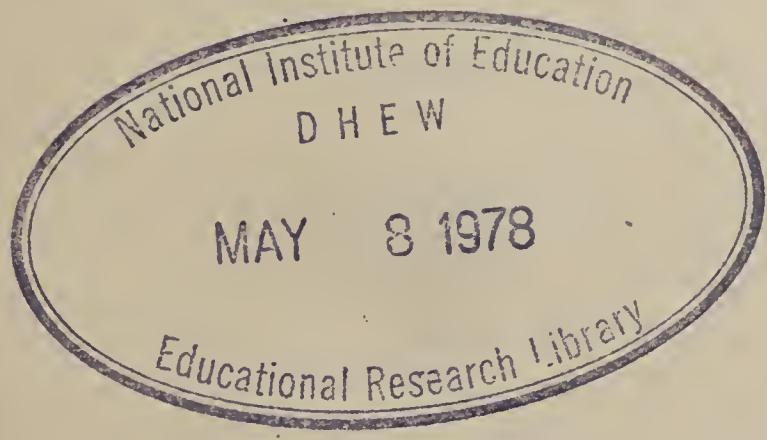

RAND McNALLY & COMPANY

CHICAGO

NEW YORK

Call Number

LT

QA

106

T4

BK 3

C.1

Date

5/8/78

78-

845949

Copyright, 1917

By EDWARD LEE THORNDIKE

LT
QA103
T4

Price 60¢



DEC 10 1917

©Cl.A479469

3862449

PREFACE

3-4-18

THESE books apply the principles discovered by the psychology of learning, by experimental education, and by the observation of successful school practice, to the teaching of arithmetic. Consequently they differ from past practice in the following respects:

Nothing is included merely for mental gymnastics. Training is obtained through content that is of intrinsic value.

The preparation given is not for the verbally described problems of examination papers, but for the actual problems of life. In particular, problems whose answers must be known to frame the problems or whose conditions are fantastic are rigorously excluded.

Reasoning is treated, not as a mythical faculty which may be called on to override or veto habits, but as the coöperation, organization, and management of habits; and the logic of proof is kept distinct from the psychology of thinking.

Interest is secured, not in pictures, athletic records, and the like, but in arithmetic itself and its desirable applications. Interest is not added as a decoration or antidote, but is inter-fused with the learning itself.

Nothing that is desirable for the education of children in quantitative thinking is omitted merely because it is hard; but the irrelevant linguistic difficulties, the unrealizable pretenses at deductive reasoning, and the unorganized computation which have burdened courses in arithmetic are omitted. The demand here is that pupils shall approximate 100 percent efficiency with thinking of which they are capable.

The formation and persistence of useful habits is not left to be a chance result of indiscriminate drill and review. Every habit is formed so as to give the maximum of aid to, and the

minimum of interference with, others. Other things being equal, no habit is formed that must be later broken; two or three habits are not formed where one will do as well; each is formed as nearly as possible in the way in which it is required to function; each is kept alive and healthy by being made to coöperate in the formation of other and higher habits in the arithmetical hierarchy. If a pupil carries through the projects in computing and problem-solving of these three books under competent supervision, he will have abundant practice for the arithmetical insight, knowledge, and skill that the elementary school is expected to provide.

E. L. T.

NOTES ON BOOK THREE

In the selection of its subject-matter this book omits or greatly reduces such information about business affairs as is of use only to rich men or bank clerks, such computation as is of use only to bookkeepers and statisticians, and such problems as the pupil will not meet in life or will solve without previous training if he does meet them.

The time thus saved is used to secure mastery of the arithmetical knowledge and skill which are valuable for an intelligent life in school itself, in the home, factory, or store, on the farm, and in the conduct of churches, schools, and public affairs. For example, elaborate computations of interest, principal, and rate, are replaced by systematic drills to secure mastery of the computations which life requires. Problems which are of interest only to sociological or fiscal experts, and problems which are nothing but disguises for practice in computation, are replaced by problems which prepare for an understanding of modern accounting, wage systems, farm management, and household economy.

One other feature of the subject-matter deserves notice. The general course, which ends on page 241, is followed by exercises in understanding and using tables and an appendix providing special training for clerical work, farm work, shop work, and further study of mathematics. Certain groups of pupils should be encouraged to study suitable parts of this material in addition to the general course.

In its arrangement of the subject-matter, this book often diverges from past practice, in order to realize two ideals. First, the knowledge and skill acquired are made available for use. The needs of life, rather than the convenience of an expositor, determine the order of topics and subtopics. For example, the formal arrangement of the applications of percentage under three abstract types of operation is abandoned in favor of an arrangement which teaches pupils to think and compute in terms of percents when and as they will need to do so. Computing interest is treated, not as some peculiar mathematical theory and technique, but as a practical adjunct of collecting bills, of saving, and of borrowing to start or extend a business. In the second place, care is taken to organize the knowledge or skill acquired into an integrated total arithmetical ability. Each important habit or insight is kept alive by being used in new ways and in coöperation with other habits and insights so that it may be a part of the pupils' active intellect, not a thing learned by itself alone and used only for examinations.

As a consequence, the organization of this book is somewhat subtle. A review, for example, is often not a mere review, but includes a new principle or element of technique or application. An arithmetical procedure will often be taught in only its simplest elements at first, be given extended practice three or four weeks later, and be systematically described and explained later still. To a superficial examination, the treatment may seem "scrappy." Ratio and proportion, for example, which deserve so much attention because of their very great importance in the arithmetic of domestic science and farm economy, may seem to be slighted and

treated only incidentally in this text. Careful and expert consideration will reveal, however, that the treatment of this, or any other important topic, is definite, thorough, and scientific. In general, the teacher may be assured that not a single paragraph of this book is where it is by haphazard. Each has a part to play in the place where it is.

A formal division into chapters is avoided. An examination of the most effective textbooks in arithmetic will prove that the real units of instruction are arranged irrespective of the division into chapters. The latter has little effect, and what little it has is mostly bad. A textbook should not be a beautifully classified museum of topics for a teacher to inspect and admire, but an instrument by which pupils are trained to understand and use arithmetic. Each section in this book contains what it does and is placed where it is, not to make a good appearance on paper in a scheme of organization, but to help children to acquire and retain a working knowledge of arithmetic.

CONTENTS*: PART ONE

I. THE GENERAL THEORY AND TECHNIQUE OF ARITHMETIC

SECTIONS	TOPIC OR ACTIVITY	ARITHMETICAL CONTENT	PAGE
1 to 7	Addition. Checking results. An addition scale. Tests for speed and accuracy.	The theory and technique of adding. Review.	1
8 to 11	Subtraction. Minuend and subtrahend. A scale for subtraction.	The theory and technique of subtracting. Review.	8
12	Comparing amounts.	Using ratios.	12
13 t 18	Multiplication. Different ways of multiplying. Canceling. Saving time in multiplying.	The theory and technique of multiplying. Canceling. The system of decimal notations. Review of aliquot parts.	13
19 to 27	Division. Placing the decimal point. Different uses of quotients.	The theory and technique of dividing. The fraction line as a sign. Zero in multiplication and division. The reciprocal rule generalized.	18
28, 29	Units of measure.	Units and multiples. Making amounts commensurate.	26

II. OWNING, BUYING, AND SELLING

30 to 33	Review. A school day. A "Percentage Race."	Sections 30 to 54 give practice in applying arithmetic, especially percentage, to problems of the owner, buyer, and seller. They also provide knowledge of certain business usages and forms.	28
34	Fixing prices.		
35	Property: inventories.		
36	Protection against loss of property by fire.		
37	Twenty-problem test.		

* The table of contents shows, in one column, the topics and activities in connection with which the learning of arithmetic is secured. In the second column are stated the main elements of the arithmetical content itself. What these are in detail and what applications of them are made to daily life can be discovered by inspection of the text. A still more summary order of topics is shown by the titles of the eleven main divisions. It should be understood, however, that the book provides for a continuous growth of arithmetical ability as an integrated whole, and that consequently each main division deals with much more than the one topic.

SECTIONS	TOPIC OR ACTIVITY	ARITHMETICAL CONTENT	PAGE
38	Insurance: rates.		
39	Insurance: valuation.		
40	Buying: sales slips, bills, and receipts.		
41	Buying by mail.		
42	Paying by mail or telegraph.		
43	Paying by check or draft.		
44	Buying: discounts for cash.		
45	Buying: trade discount.		
46	Practice in computing discounts.		
47	Buying for the home.		
48	Selling: profit and loss.		
49	Selling: profit per unit of time spent.		
50	Selling: the risk of loss.		
51, 52	Some of the expenses of selling.		
53	Selling on commission.		
54	Receiving a commission for buying.		

III. BORROWING AND LENDING: INTEREST

55	Saving money and acquiring property.	Sections 55 to 65 give ability to understand and compute simple and compound interest and to consider both saving and borrowing in an accurate and business-like way.	58
56	How money increases when interest is added to it.		
57	The Postal Savings Bank.		
58	Starting in business.		
59	Borrowing money to go into business.		
60	Borrowing money for a short time.		
61	Borrowing money for a long time.		
62	The number of days between two dates.		
63	Interest tables.		
64	Buying on the installment plan.		
65	Review.		

IV. PRACTICE FOR MASTERY

SECTIONS	TOPIC OR ACTIVITY	ARITHMETICAL CONTENT	PAGE
66 to 68	Household management. Food values. Food credits. Adapting recipes.	Sections 66 to 101 give practice in computation and problem solving, with special reference to the home and to country life.	74
69, 70, 71	Comparing numbers and quantities. Ratios.		
72 to 91	Systematic practice for self-improvement in computation.		
92 to 101	Systematic practice in solving problems.		

V. MEASUREMENTS AND EQUATIONS

102, 103, 104	Building. Board feet. Cord wood.	Board measure. Cords. Review.	108
105, 106	Exploring and surveying. The compass.	Circular measure.	111
107, 108, 109	Similar triangles. Estimating heights.	Similar triangles. Ratio.	114
110, 111, 112	Equations for gain, loss, cost per unit, distance, time, rate of motion, net price, interest, etc.	The use of symbols to represent quantities. The interpretation of simple equations.	117
113, 114	Framing equations.	Expressing quantitative relations in equations. Review of the use of parentheses.	121
115 to 118	Practice in solving problems.	Review of percentage, interest, and ratio.	123

CONTENTS: PART TWO

I. REVIEW

SECTIONS	TOPIC OR ACTIVITY	ARITHMETICAL AND COMMERCIAL CONTENT	PAGE
1, 2	Camping. Home problems.	Review of fractions, decimals, and percentage.	129
3 to 6	A "Subtraction Ladder." An "Average Ladder." Sevenths and ninths. An "Angle, Area, Volume Ladder."	Tests of achievement.	131
7 to 11	An "Equation Race." The use of money is worth money. Graded tests in division. Practice in quick thinking.	Review of percentage, interest, ratio, and the equation form. Tests of achievement.	135

II. PRIVATE BUSINESS

12, 13	Keeping a bank account.	Checks, deposits, balances; practice in computation.	139
14, 15, 16	Keeping account of money that is borrowed.	Time and demand notes, security, business problems.	142
17, 18, 19	Borrowing from a bank.	Discounting, buying, and selling notes. Losses from overdue bills.	147
20 to 23	Wages and overtime. Piece work. Payment for time saved. Commissions and bonuses.	Problems of the wage-earner.	150
24 to 27	Shares in a small business. Shares in a big business.	Stocks, real values, and par values. Buying stocks. Problems of the investor. Fractions of a percent.	153
28, 29	Dividing profits. Payments to owners of shares in the business.	Dividends. Rates. Problems of the investor.	157
30, 31, 32	Investing in real estate, stocks, bonds, notes, and mortgages.	Notes, mortgages, and bonds. The difference between stocks and bonds. Income. Review of interest. Problems of the small investor.	160

SECTIONS	TOPIC OR ACTIVITY	ARITHMETICAL AND COMMERCIAL CONTENT	PAGE
33, 34	Strength tests. Ability in arithmetic. What William and Louise did with their money.	Interpreting and making simple diagrams and curves. Expressing absolute and relative amounts. Practice in computation with percents and ratios.	164

III. PUBLIC BUSINESS

35 to 39	Levying taxes and assessments. The town or city as a business firm. How a city obtains money to pay its bills.	Taxes, assessments, licenses, water rates, etc. Assessed valuation. Problems in public finance.	167
40	Voting. Holding an election.	Majorities and pluralities.	173
41, 42	The town or city as a borrower.	Public bonds. Public property. Interest.	174
43 to 48	How a city or town spends the money obtained from taxes. Expenses for schools. Expenses for health. Expenses for good roads.	Budgets. Problems in the use of public money. Percentage and ratio. Graphs.	177
49, 50, 51	The nation's business. Expenses and receipts of the federal government. National debts.	Practice with very large numbers.	182

IV. ARITHMETIC IN THE HOME

52 to 56	Family budgets and costs. House building.	Applications of arithmetic. Elements of cost accounting.	184
57 to 61	Foods. Food values. Rations. Food costs. Grading foods.	Applications of arithmetic in domestic science. Uses of percents and ratios.	189
62	Clothes. Patterns.	Problems in the treatment of units of measure.	193
63, 64	Body temperature. Room temperature.	Interpreting curves. Interpreting a graphic distribution of frequencies.	194
65	Problems of the home.	Review.	197

V. ARITHMETIC IN THE SHOP AND FACTORY

SECTIONS	TOPIC OR ACTIVITY	ARITHMETICAL AND COMMERCIAL CONTENT	PAGE
66, 67	Squares and cubes. Square roots and cube roots.	The meaning of <i>square</i> , <i>cube</i> , <i>exponent</i> , <i>root</i> . Practice especially with decimal numbers. The use of tables.	198
68, 69	Making a right angle.	The hypotenuse rules.	201
70, 71, 72	Finding the square root of a number. Estimating cube roots.	The procedure in finding a square root. Making tables of squares.	202
73 to 77	Circles and cylinders. Wheels, wells, pipes, tanks, etc.	Finding the perimeter and area of a circle. Finding the volume of a cylinder. Finding the area of the surface of a right circular cylinder. Writing arithmetical proofs.	205
78	Finding the volume of a solid.	Understanding and using formulae. Finding the volume of cones and pyramids.	210
79, 80, 81	The use of equations or formulae.	Training in understanding and using equations. Arcs and sectors. Equations for time, distance, and rate; for interest, principal, rate, and time, for the areas of surfaces.	212
82, 83	Speeds and strengths. The Fahrenheit and Centigrade scales.	Understanding and using equations.	216
84, 85, 86	Arcs. Lengths, areas, and volumes. Longitude.	Circular measure. Longitude and time. Review.	219
87 to 91	The metric or decimal system of weights and measures. Important foreign measures.	The plan of the metric system. Equivalents of common measures. Practice with decimals.	221

VI. REVIEW

92	Factoring.	Meaning of factors. Tests of divisibility. Canceling.	226
93, 94	Arithmetical language. Business language and business problems.	Applications to private business.	227
95	Graphs and diagrams.	Representations of qualities by length, area, and volume. Common fallacies.	230

SECTIONS	TOPIC OR ACTIVITY	ARITHMETICAL AND COMMERCIAL CONTENT	PAGE
96	The relation of numbers.	Squares, cubes square roots, cube roots, ratio, proportion.	232
97	Equations.	Using equations for areas and volumes.	233
98 to 103	Problem solving. Hidden facts.	General review.	235
104	Using tables.	Practice in understanding and using tables of products, powers and roots, interest, board-feet contents, conversion of grams and ounces, and the like.	242

CONTENTS: APPENDIX

A. SPECIAL ARITHMETIC FOR CLERICAL WORK

SECTION	PAGE
1. Errorless counting and tabulating	250
2. Comparing entries	251
3. Errorless copying and adding	252
4. Computing discounts	252
5. Short methods	253
6. Checking results	256
7. Making and using tables	256
8. Practical computations	258

B. SPECIAL ARITHMETIC FOR MECHANICAL TRADES

9. Exactness in measurements	260
10. Similar figures	261
11. Shop calculations	262
12. Gear ratios	263
13. Shop equations	264
14. Using tables	265
15. Wages	266
16. Practical exercises	267

C. SPECIAL ARITHMETIC FOR AGRICULTURAL WORK

SECTION	PAGE
17. Fruit culture	269
18. Field crops	270
19. Plant foods	271
20. Estimating chances	272
21. Mixtures for spraying	272
22. Farm machinery	273
23. Farm accounts	274
24. Feeding farm animals: nutritive values	275

D. SPECIAL ARITHMETIC FOR MATHEMATICAL INSIGHT

25. Equations	277
26. Solving a problem by an equation	279
27. The use of letters to represent quantities	280
28. Addition with letters	281
29. Solving equations	282
30, 31, 32. Minus quantities and negative numbers	283

ARITHMETIC

BOOK THREE, PART ONE

1. Review. Addition

Write the sums only. Do not copy the numbers.

1.	2.	3.	4.																						
$\begin{array}{r} 4 \text{ qt. } 1 \text{ pt.} \\ 3 \text{ qt. } 1 \text{ pt.} \\ \underline{2 \text{ qt. } 1 \text{ pt.}} \end{array}$	$\begin{array}{r} 2 \text{ yd. } 1 \text{ ft.} \\ 1 \text{ yd. } 1 \text{ ft.} \\ \underline{3 \text{ yd. } 2 \text{ ft.}} \end{array}$	<table style="margin-left: auto; margin-right: auto;"> <tr> <td style="padding-right: 10px;">ft.</td> <td>in.</td> </tr> <tr> <td style="padding-right: 10px;">2</td> <td>4</td> </tr> <tr> <td style="padding-right: 10px;">3</td> <td>6</td> </tr> <tr> <td style="padding-right: 10px;">1</td> <td>10</td> </tr> <tr> <td colspan="2" style="text-align: center;"><hr/></td> </tr> </table>	ft.	in.	2	4	3	6	1	10	<hr/>		<table style="margin-left: auto; margin-right: auto;"> <tr> <td style="padding-right: 10px;">Dollars</td> <td style="padding-right: 10px;">Dimes</td> <td>Cents</td> </tr> <tr> <td style="padding-right: 10px;">2</td> <td style="padding-right: 10px;">6</td> <td>3</td> </tr> <tr> <td style="padding-right: 10px;">4</td> <td style="padding-right: 10px;">7</td> <td>1</td> </tr> <tr> <td colspan="3" style="text-align: center;"><hr/></td> </tr> </table>	Dollars	Dimes	Cents	2	6	3	4	7	1	<hr/>		
ft.	in.																								
2	4																								
3	6																								
1	10																								
<hr/>																									
Dollars	Dimes	Cents																							
2	6	3																							
4	7	1																							
<hr/>																									

5.	6.	7.	8.	9.
$\begin{array}{r} 147 \\ 298 \\ 375 \\ 869 \\ \underline{127} \end{array}$	$\begin{array}{r} 4.7 \\ 2.08 \\ 11 \\ 6.125 \\ \underline{7.5} \end{array}$	$\begin{array}{r} 1.006 \\ 1.015 \\ 2.045 \\ 1.0325 \\ \underline{1.0375} \end{array}$	$\begin{array}{r} .035 \\ .04 \\ .0275 \\ .018 \\ \underline{.0525} \end{array}$	$\begin{array}{r} 16 + 24 + 17 \\ \\ .35 + .42 + .16 \\ \\ .06 + .025 + .033 \end{array}$

State the sums:

<i>a.</i>	<i>b.</i>	<i>c.</i>	<i>d.</i>	<i>e.</i>	<i>f.</i>	<i>g.</i>	<i>h.</i>	<i>i.</i>	<i>j.</i>
$\frac{1}{2}$	$\frac{3}{4}$	$\frac{1}{5}$	$\frac{3}{8}$	$\frac{2}{3}$	$\frac{1}{6}$	$\frac{1}{4}$	$\frac{5}{12}$	$\frac{3}{16}$	$\frac{7}{24}$
$\frac{1}{2}$	$\frac{3}{4}$	$\frac{2}{5}$	$\frac{5}{8}$	$\frac{1}{3}$	$\frac{5}{6}$	$\frac{1}{4}$	$\frac{7}{12}$	$\frac{7}{16}$	$\frac{11}{24}$
$\frac{1}{2}$	$\frac{1}{4}$	$\frac{3}{5}$	$\frac{7}{8}$	$\frac{2}{3}$	$\frac{5}{6}$	$\frac{3}{4}$	$\frac{11}{12}$	$\frac{13}{16}$	$\frac{15}{24}$

Tell how you would think of the fractions in each column so as to add them:

<i>k.</i>	<i>l.</i>	<i>m.</i>	<i>n.</i>	<i>o.</i>	<i>p.</i>	<i>q.</i>	<i>r.</i>	<i>s.</i>	<i>t.</i>
$\frac{1}{2}$	$\frac{1}{8}$	$\frac{3}{4}$	$\frac{1}{8}$	$\frac{1}{6}$	$\frac{1}{4}$	$\frac{1}{2}$	$\frac{5}{16}$	$\frac{7}{8}$	$\frac{1}{3}$
$\frac{1}{4}$	$\frac{3}{4}$	$\frac{1}{2}$	$\frac{1}{4}$	$\frac{1}{3}$	$\frac{1}{2}$	$\frac{3}{4}$	$\frac{1}{4}$	$\frac{9}{16}$	$\frac{1}{2}$
$\frac{1}{2}$	$\frac{5}{8}$	$\frac{7}{8}$	$\frac{5}{8}$	$\frac{1}{2}$	$\frac{2}{3}$	$\frac{1}{3}$	$\frac{3}{8}$	$\frac{1}{2}$	$\frac{1}{4}$

Addition means finding the sum of two quantities.

The correct result in addition is the result that would be obtained by accurate counting or measuring.

We obtain the correct result in adding whole numbers or decimal numbers by—

adding ones to ones and counting 10 ones as 1 ten

adding tens to tens and counting 10 tens as 1 hundred

adding hundredths to hundredths and counting .10 hundredths as 1 tenth.

adding thousandths to thousandths and counting 10 thousandths as 1 hundredth.

1. How do you count 10 tenths in adding?

We obtain the correct result in adding fractions, all having the same number as denominator, by adding the numerators.

2. How do we count $\frac{2}{2}$ or $\frac{3}{3}$ or $\frac{4}{4}$ or $\frac{5}{5}$ or $\frac{8}{8}$?

We obtain the correct result in adding fractions with different numbers as denominators by first expressing them as fractions with the same number as denominator, or by expressing them as decimal numbers.

3. Express $\frac{7}{25}$, $\frac{9}{50}$, and $\frac{11}{20}$ as decimal numbers.

4. Express $\frac{2}{3}$, $\frac{3}{4}$, $\frac{1}{2}$, and $\frac{5}{6}$ as $\frac{\quad}{12}$ s.

5. Read, saying the right words or numbers where the dots are:

We obtain the correct result in adding quantities like 4 bu. 2 pk. 3 qt. and 1 bu. 3 pk. 7 qt. by adding qt. to . . . and counting 8 qt. as . . . pk. and by adding pk. to . . . and counting 4 pk. as . . . bu.

6. Tell how you “carry” with seconds, minutes, pints, inches, feet, and ounces.

7. Let b stand for bushels. Let p stand for pecks. Let q stand for quarts. Helen’s father bought 3 bags of nuts.

The first bag contained $2b. + 1p. + 3q.$

The second bag “ $1b. + 1p. + 2q.$

The third bag “ $2b. + 1p. + 2q.$

How much did all three bags together contain?

3. Checking Results in Addition with Integers and 3 Decimal Numbers

Take a sheet of paper. Write the sums for Ex. 1 to 6 in a line (adding upward).

Then add downward and write the sums for each column of Ex. 1 to 6 as shown for Ex. 1; and add these sums.

Then fold the paper under about 1 inch and do the same for Ex. 7 to 12.

Then fold again and do the same for Ex. 13 to 18.

If you have more than two answers wrong, repeat the whole page.

1.	2.	3.	4.	5.	6.
467	647	169	294	249	985
293	505	189	483	454	458
785	865	227	223	998	424
697	847	197	315	285	379
857	339	769	780	177	616
435	389	384	576	868	398
<u>298</u>	<u>242</u>	<u>185</u>	<u>169</u>	<u>757</u>	<u>244</u>
42					
490					
3300					
7.	8.	9.	10.	11.	12.
197	744	183	176	454	764
565	795	285	357	585	579
238	659	868	589	269	145
454	988	384	647	268	138
289	707	109	290	767	460
189	876	196	478	558	697
<u>397</u>	<u>484</u>	<u>886</u>	<u>563</u>	<u>974</u>	<u>789</u>
13.	14.	15.	16.	17.	18.
8.25	2.75	.0904	32.4	.255	.54
6.75	1.25	.0456	34.9	.284	3.45
.78	2.50	.0834	33.5	.245	1.59
.98	2.75	.0574	23.8	.295	6.78
3.75	4.25	.0728	43.0	.265	8.67
.89	1.75	.0699	47.7	.297	7.43
<u>4.93</u>	<u>1.25</u>	<u>.0812</u>	<u>46.7</u>	<u>.373</u>	<u>2.39</u>

4 4. Checking Results in Adding Common Fractions

A majority of the fractions you will have to add in business will be $\frac{1}{2}$ s (halves) and $\frac{1}{4}$ s (quarters).

You can check the results for sums of $\frac{1}{2}$ s and $\frac{1}{4}$ s in this way:

Add the $\frac{1}{2}$ s and $\frac{1}{4}$ s separately and add their sums, like this:

$8\frac{1}{4}$ The sum of the $\frac{1}{2}$ s is 2.
 $7\frac{3}{4}$ The sum of the $\frac{1}{4}$ s and
 $2\frac{1}{2}$ $\frac{3}{4}$ s is $2\frac{3}{4}$.
 $5\frac{1}{2}$
 $9\frac{3}{4}$ Write $\frac{3}{4}$. Add 4 to the ones
 $7\frac{3}{4}$ column.
 $2\frac{1}{4}$
 $3\frac{1}{2}$
 $18\frac{1}{2}$

Another way to check the results is to add the fractions like this (adding downward):

1
 $1\frac{1}{2}$
 2
 $2\frac{3}{4}$
 $3\frac{1}{2}$
 $3\frac{3}{4}$
 $4\frac{1}{4}$
 $4\frac{3}{4}$

Write the sums. You need not copy the numbers.

Check each result. If you have any wrong results, repeat the work.

1.	2.	3.	4.	5.	6.
$2\frac{1}{2}$	$3\frac{1}{4}$	$2\frac{1}{4}$	$5\frac{1}{2}$	$2\frac{1}{2}$	$2\frac{1}{4}$
$1\frac{1}{4}$	$8\frac{3}{4}$	$1\frac{1}{4}$	$6\frac{1}{4}$	$3\frac{1}{2}$	$2\frac{1}{4}$
$3\frac{1}{2}$	$1\frac{1}{4}$	$2\frac{1}{4}$	$2\frac{1}{4}$	$5\frac{1}{2}$	$3\frac{3}{4}$
$4\frac{3}{4}$	$6\frac{1}{2}$	$1\frac{1}{2}$	$4\frac{3}{4}$	$9\frac{1}{2}$	$1\frac{1}{2}$
$1\frac{3}{4}$	$5\frac{1}{4}$	$4\frac{1}{2}$	$1\frac{3}{4}$	6	$3\frac{1}{4}$
$2\frac{1}{4}$	$2\frac{1}{2}$	1	$1\frac{1}{2}$	$2\frac{3}{4}$	$2\frac{3}{4}$
<u>$5\frac{1}{4}$</u>	<u>$7\frac{1}{2}$</u>	<u>$3\frac{1}{4}$</u>	<u>$7\frac{1}{4}$</u>	<u>$2\frac{3}{4}$</u>	<u>$2\frac{1}{2}$</u>
7.	8.	9.	10.	11.	12.
$1\frac{1}{2}$	$3\frac{1}{4}$	$4\frac{1}{2}$	$5\frac{1}{4}$	$2\frac{1}{4}$	$2\frac{1}{2}$
$2\frac{1}{2}$	$3\frac{3}{4}$	4	$6\frac{3}{4}$	$1\frac{1}{4}$	$2\frac{1}{4}$
$2\frac{3}{4}$	$1\frac{1}{2}$	$6\frac{1}{4}$	$5\frac{3}{4}$	$4\frac{1}{2}$	$3\frac{3}{4}$
$3\frac{1}{4}$	$2\frac{3}{4}$	$5\frac{1}{2}$	$7\frac{1}{2}$	6	$1\frac{1}{4}$
$1\frac{1}{4}$	$3\frac{3}{4}$	$3\frac{1}{4}$	5	$7\frac{3}{4}$	2
$1\frac{1}{4}$	$3\frac{1}{2}$	$8\frac{1}{4}$	$6\frac{1}{2}$	$4\frac{3}{4}$	1
<u>$1\frac{1}{2}$</u>	<u>$1\frac{1}{4}$</u>	<u>$4\frac{1}{2}$</u>	<u>$9\frac{1}{2}$</u>	<u>$2\frac{1}{4}$</u>	<u>$2\frac{3}{4}$</u>

State the sums:

a. $\frac{1}{2} + \frac{1}{2} + \frac{1}{4}$

b. $\frac{3}{4} + \frac{3}{4} + \frac{1}{2}$

c. $\frac{3}{4} + \frac{1}{2} + \frac{1}{4} + \frac{1}{2}$

d. $\frac{3}{8} + \frac{5}{8} + \frac{7}{8}$

e. $\frac{5}{8} + \frac{7}{8} + \frac{1}{2}$

f. $\frac{1}{4} + \frac{1}{2} + \frac{3}{4} + \frac{1}{4}$

Begin at the bottom of the page. See if you can climb to the top without making a mistake. Be sure to copy the numbers correctly.

Step *a.* Add $1\frac{1}{3}$ yd., $\frac{7}{8}$ yd., $1\frac{1}{4}$ yd., $\frac{3}{4}$ yd., $\frac{7}{8}$ yd., and $1\frac{1}{2}$ yd.

6. *b.* Add $62\frac{1}{2}\text{¢}$, $66\frac{2}{3}\text{¢}$, $56\frac{1}{4}\text{¢}$, 60¢ , and $62\frac{1}{2}\text{¢}$.

c. Add $1\frac{5}{16}$, $1\frac{9}{32}$, $1\frac{3}{8}$, $1\frac{11}{32}$, and $1\frac{7}{16}$.

d. Add $1\frac{1}{3}$ yd., $1\frac{1}{4}$ yd., $1\frac{1}{2}$ yd., 2 yd., $\frac{3}{4}$ yd., and $\frac{2}{3}$ yd.

Step *a.* Add 4 ft. $6\frac{1}{2}$ in., $53\frac{1}{4}$ in., 5 ft. $\frac{1}{2}$ in., $56\frac{3}{4}$ in., and 5 ft.

5. *b.* Add 7 lb., 6 lb. 11 oz., $7\frac{1}{2}$ lb., 6 lb. $4\frac{1}{2}$ oz., and $8\frac{1}{2}$ lb.

c. Add 1 hr. 6 min. 20 sec., 58 min. 15 sec., 1 hr. 4 min., and 55 min.

d. Add 7 dollars, 13 half dollars, 21 quarters, 17 dimes, and 19 nickels.

Step *a.* Add $.05\frac{1}{2}$, $.06$, $.04\frac{3}{4}$, $.02\frac{3}{4}$, and $.05\frac{1}{4}$.

4. *b.* Add $.33\frac{1}{3}$, $.12\frac{1}{2}$, $.18$, $.16\frac{2}{3}$, $.08\frac{1}{3}$, and $.15$.

c. Add $.08\frac{1}{3}$, $.06\frac{1}{4}$, $.21$, $.03\frac{3}{4}$, and $.16\frac{2}{3}$.

d. Add $.62$, $.64\frac{1}{2}$, $.66\frac{2}{3}$, $.10\frac{1}{4}$, and $.68$.

Step *a.* Add $7\frac{1}{4}$, $6\frac{1}{2}$, $8\frac{3}{8}$, $5\frac{3}{4}$, $9\frac{5}{8}$, and $3\frac{7}{8}$.

3. *b.* Add $4\frac{5}{8}$, 12, $7\frac{1}{2}$, $8\frac{3}{4}$, 6, and $5\frac{1}{4}$.

c. Add $9\frac{3}{4}$, $5\frac{7}{8}$, $4\frac{1}{8}$, $6\frac{1}{2}$, 7, and $3\frac{5}{8}$.

d. Add 12, $8\frac{1}{2}$, $7\frac{1}{3}$, 5, $6\frac{2}{3}$, and $9\frac{1}{2}$.

Step *a.* Add 12.04, .96, 4.7, 9.625, 3.25, and 20.

2. *b.* Add .58, 6.03, .079, 4.206, 2.75, and 10.4.

c. Add 52, 29.8, 41.07, 1.913, 2.6, and 110.

d. Add 29.7, 315, 26.75, 19.004, 8.793, and 20.05.

Step *a.* Add $10\frac{3}{5}$, $11\frac{1}{5}$, $10\frac{4}{5}$, 11, $11\frac{2}{5}$, $10\frac{3}{5}$, and 11.

1. *b.* Add $7\frac{3}{8}$, $6\frac{5}{8}$, 8, $9\frac{1}{8}$, $7\frac{7}{8}$, $5\frac{3}{8}$, and $8\frac{1}{8}$.

c. Add $21\frac{1}{2}$, $18\frac{3}{4}$, $31\frac{1}{2}$, $19\frac{1}{4}$, $17\frac{1}{4}$, 22, and $16\frac{1}{2}$.

d. Add $14\frac{5}{12}$, $12\frac{7}{12}$, $9\frac{11}{12}$, $6\frac{1}{12}$, and 5.

6. Oral Speed Tests

Do Ex. 1 to 22. Then repeat, doing 22 first, then 21, etc.

1. Count by 6s to 90, beginning 0, 6, 12.
2. Count by 6s to 91, beginning 1, 7, 13.
3. Count by 6s to 95, beginning 5, 11, 17.
4. Count by 7s to 99, beginning 1, 8, 15.
5. Count by 7s to 95, beginning 4, 11, 18.
6. Count by 7s to 96, beginning 5, 12, 19.
7. Count by 8s to 96, beginning 0, 8, 16.
8. Count by 8s to 99, beginning 3, 11, 19.
9. Count by 8s to 95, beginning 7, 15, 23.
10. Count by 8s to 100, beginning 4, 12, 20.
11. Count by 9s to 99, beginning 0, 9, 18.
12. Count by 9s to 100, beginning 1, 10, 19.
13. Count by 9s to 102, beginning 3, 12, 21.
14. Count by 9s to 105, beginning 6, 15, 24.
15. Count by 4s to 100, beginning 0, 4, 8.
16. Count by 4s to 101, beginning 1, 5, 9.
17. Count by 5s to 101, beginning 1, 6, 11.
18. Count by 5s to 102, beginning 2, 7, 12.
19. Count by 3s to 100, beginning 1, 4, 7.
20. Count by 3s to 99, beginning 0, 3, 6.
21. Count by $6\frac{1}{4}$ s to 100, beginning $6\frac{1}{4}$, $12\frac{1}{2}$, $18\frac{3}{4}$.
22. Count by 12s to 144, beginning 12, 24, 36.

See how many you can do of Ex. 1 to 22 in 5 minutes without making a mistake. Then practice until you make a record that satisfies you.

A satisfactory seventh-grade record for a very fast adder is all done in 5 min. or less.

A satisfactory seventh-grade record for a fast adder is 17 done in 5 min.

A satisfactory seventh-grade record for a medium adder is 13 done in 5 min.

A satisfactory seventh-grade record for a slow adder is 10 done in 5 min.

7. Written Speed Tests

7

See how many of these you can add in 10 minutes, without making a mistake. Write only the sums. Do not copy the numbers. Check results unless you are sure that your work is correct.

1.	2.	3.	4.	5.	6.
1.25	2.40	4.13	9.60	8.91	6.70
1.45	1.63	3.75	1.49	1.12	9.10
2.63	3.66	9.60	8.28	7.56	6.21
1.45	1.24	5.18	2.63	5.22	8.28
.60	2.20	1.45	4.95	3.33	5.80
1.40	5.64	6.22	1.69	7.18	3.92
.95	4.36	4.33	9.22	6.90	7.63
1.64	1.08	1.18	6.33	9.54	6.65
1.75	3.22	1.49	5.36	9.25	4.68
<u>1.98</u>	<u>4.85</u>	<u>1.99</u>	<u>7.24</u>	<u>8.67</u>	<u>9.56</u>

7.	8.	9.	10.	11.	12.
4.28	3.66	2.11	4.29	2.30	1.98
3.56	1.27	9.92	2.54	2.48	2.33
2.38	1.83	6.22	2.15	4.65	1.18
1.49	4.92	4.33	1.22	3.54	3.45
4.18	1.44	3.54	3.33	6.56	2.25
1.25	2.60	7.50	2.42	3.33	1.42
3.42	3.65	3.49	2.40	5.24	1.95
1.54	1.64	2.25	3.27	4.36	2.54
2.70	2.18	1.00	2.65	2.75	1.49
<u>5.33</u>	<u>4.47</u>	<u>6.78</u>	<u>5.62</u>	<u>2.98</u>	<u>1.75</u>

See if you can copy all these numbers correctly and find the eight sums correctly.

13.	14.	15.	16.	17.	18.	19.	20.
.28	.85	.64	.68	.27	.22	.36	.74
.65	.36	1.17	1.50	1.79	.33	.50	.45
1.96	1.70	.63	.36	.80	.40	1.32	.10
.75	.42	.24	.45	.97	.64	.43	.72
.30	.75	.72	.97	.64	.70	.71	.22
.60	1.44	2.67	4.65	1.20	.49	1.18	.33
1.08	.56	.97	.54	.56	.42	.97	.36
<u>2.16</u>	<u>.65</u>	<u>.42</u>	<u>.78</u>	<u>.28</u>	<u>.45</u>	<u>.75</u>	<u>.75</u>

8. Oral Review. Subtraction

1. Compare the results when you subtract 16 from 28 28 38
and when you subtract 26 from 38 16 26

Compare the results when you subtract 35 from 57 57 67
and when you subtract 45 from 67 35 45

Compare the results when you subtract 28 from $40 + 4$
and when you subtract 38 from $40 + 14$

2. Does it alter the result in subtraction if you increase each number by 1 or 10 or 100 or 1000?
3. Compare the result when you subtract $1\frac{7}{8}$ from $4\frac{1}{8}$.
and when you subtract $2\frac{7}{8}$ from $4\frac{9}{8}$.
4. Subtract and state the differences. Use pencil and paper if you need to.

<i>a.</i>	<i>b.</i>	<i>c.</i>	<i>d.</i>	<i>e.</i>	<i>f.</i>	<i>g.</i>	<i>h.</i>
$5\frac{1}{4}$	$26\frac{7}{8}$	$9\frac{1}{2}$	$7\frac{5}{8}$	$5\frac{1}{3}$	$6\frac{2}{5}$	$8\frac{1}{8}$	$7\frac{1}{2}$
$2\frac{3}{4}$	$13\frac{3}{8}$	$2\frac{1}{2}$	$4\frac{7}{8}$	$3\frac{2}{3}$	$2\frac{4}{5}$	$3\frac{1}{2}$	$1\frac{1}{4}$

5. What must you add to each of these numbers to make 1?

<i>a.</i>	<i>b.</i>	<i>c.</i>	<i>d.</i>	<i>e.</i>	<i>f.</i>	<i>g.</i>	<i>h.</i>	<i>i.</i>	<i>j.</i>
$\frac{3}{4}$	$\frac{1}{2}$	$\frac{7}{8}$	$\frac{5}{8}$	$\frac{1}{4}$	$\frac{1}{3}$	$\frac{2}{5}$	$\frac{5}{6}$	$\frac{2}{3}$	$\frac{3}{8}$
<i>k.</i>	<i>l.</i>	<i>m.</i>	<i>n.</i>	<i>o.</i>	<i>p.</i>	<i>q.</i>	<i>r.</i>	<i>s.</i>	<i>t.</i>
$\frac{9}{16}$	$\frac{5}{16}$	$\frac{7}{12}$	$\frac{6}{10}$	$\frac{1}{8}$	$\frac{7}{16}$	$\frac{5}{12}$	$\frac{17}{24}$	$\frac{19}{24}$	$\frac{11}{32}$

6. How do you express each of these when you subtract it from $1\frac{5}{16}$?

<i>a.</i>	<i>b.</i>	<i>c.</i>	<i>d.</i>	<i>e.</i>	<i>f.</i>
$\frac{1}{2}$	$\frac{1}{4}$	$\frac{5}{8}$	$\frac{7}{8}$	$\frac{3}{4}$	$\frac{3}{8}$

7. How do you express these numbers in order to subtract easily and accurately?

<i>a.</i>	<i>b.</i>	<i>c.</i>	<i>d.</i>	<i>e.</i>	<i>f.</i>	<i>g.</i>	<i>h.</i>	<i>i.</i>	<i>j.</i>
$\frac{1}{2}$	$\frac{3}{8}$	$\frac{7}{8}$	$\frac{7}{8}$	$\frac{1}{2}$	$\frac{5}{6}$	$\frac{2}{3}$	$1\frac{1}{16}$	$\frac{3}{4}$	$\frac{3}{4}$
$\frac{1}{12}$	$\frac{1}{4}$	$\frac{1}{2}$	$\frac{3}{4}$	$\frac{1}{3}$	$\frac{2}{3}$	$\frac{1}{4}$	$\frac{5}{8}$	$\frac{1}{3}$	$\frac{3}{8}$

8. Subtract each of these numbers from $1\frac{1}{2}$:

$\frac{1}{8}$	$\frac{1}{3}$	$\frac{3}{4}$	$\frac{5}{6}$	$\frac{7}{8}$	$\frac{11}{16}$	$\frac{1}{2}$	$\frac{2}{3}$
---------------	---------------	---------------	---------------	---------------	-----------------	---------------	---------------

1. Subtract 4 lb. 13 oz. from 9 lb. 5 oz.
2. Subtract 5 ft. $7\frac{1}{2}$ in. from 6 ft. $1\frac{1}{4}$ in.
3. Subtract 2.873 from 28.901.

We call 4 lb. 13 oz. or 5 ft. $7\frac{1}{2}$ in. or 2.873 the **subtrahend** or quantity to be subtracted.

We call 9 lb. 5 oz. or 6 ft. $1\frac{1}{4}$ in. or 28.901 the **minuend** or quantity from which the subtrahend is to be subtracted.

To check the result in subtraction add it to the subtrahend.

Result + subtrahend should = minuend.

4. Subtract and check the results:

a. <u>251.75</u> <u>159.88</u>	b. <u>300.20</u> <u>254.43</u>	c. <u>475.69</u> <u>297.59</u>	d. <u>801.25</u> <u>421.69</u>	e. <u>473.00</u> <u>277.65</u>
f. <u>523.00</u> <u>94.23</u>	g. <u>743.10</u> <u>645.71</u>	h. <u>656.42</u> <u>597.95</u>	i. <u>438.75</u> <u>409.56</u>	j. <u>796.21</u> <u>306.78</u>
k. <u>100.00</u> <u>70.89</u>	l. <u>387.45</u> <u>96.50</u>	m. <u>800.27</u> <u>487.85</u>	n. <u>748.09</u> <u>741.79</u>	o. <u>523.04</u> <u>86.68</u>

5. Examine these results. Which do you see at once must be wrong?

	Result		Result		Result
a. 14.5 - .69	7.6	d. $2\frac{1}{4} - 1\frac{3}{4}$	$1\frac{1}{2}$	g. 4.25 - 2.25	2
b. 2 bu. - 7 pk.	1 pk.	e. $\frac{7}{12} - \frac{1}{4}$	$\frac{1}{3}$	h. 3 bu. - 2 pk.	1 pk.
c. 5 bu. - 3 pk.	2 pk.	f. $1\frac{7}{24} - \frac{7}{8}$	$1\frac{0}{24}$	i. 7.75 - 7.25	5

6. How much is left —

- a. When you take 1 bu. 9 qt. from 4 bu.?
- b. When you take 1 hr. 23 min. from 3 hr.?
- c. When you take 11 oz. from $2\frac{1}{2}$ lb.?
- d. When you take 2 lb. 5 oz. from 4 lb. 3 oz.?
- e. When you take 1 ft. 10 in. from 4 ft. 6 in.?
- f. When you take 2 hr. 50 min. from $5\frac{1}{2}$ hr.?

1. Tell what you must add to each of these numbers (a) To make 1. (b) To make $1\frac{1}{8}$ or $\frac{9}{8}$. (c) To make 2. (d) To make $\frac{7}{8}$. (e) To make $1\frac{1}{4}$ or $\frac{5}{4}$. (f) To make $1\frac{1}{2}$ or $\frac{3}{2}$ or $\frac{6}{4}$ or $\frac{12}{8}$:

$\frac{1}{8}$

$\frac{1}{4}$

$\frac{7}{8}$

$\frac{1}{2}$

$\frac{3}{4}$

$\frac{5}{8}$

$\frac{3}{8}$

2. Tell what change you should receive from \$1.00 when your purchase amounts to —

a. 49¢

d. 63¢

g. 46¢

j. 91¢

m. 18¢

b. 64¢

e. 78¢

h. 82¢

k. 26¢

n. 89¢

c. 72¢

f. 53¢

i. 37¢

l. 40¢

o. 35¢

3. Tell what the result will be if each of these (a) is reduced 10%; (b) is reduced 15%; (c) is increased $12\frac{1}{2}\%$:

I. \$2.00

II. \$1.60

III. \$1.00

IV. \$10.00

V. \$1.20

(Write the answers and any numbers that you need to write to find the answers.)

4. John is 4 ft. $10\frac{3}{4}$ in. tall. (a) How much must he grow to be 5 ft.? (b) How much must he average per year to be 5 ft. $7\frac{1}{2}$ in. in five years?
5. How much will be left of a piece of cloth $40\frac{1}{2}$ yd. long after three pieces each $2\frac{3}{4}$ yd. long have been cut from it?
6. How much less per year is the rent for a cottage costing \$16.50 per month than the rent for a cottage costing \$20 per month?
7. Three girls bought some things at an auction for \$10.86? Each girl paid \$3.62. They sold the things for \$14.61. How much was the profit for each girl?
8. Subtract one fourth of \$25.00 from \$15.00.

11. A Subtraction Ladder

On the next page is a subtraction ladder. Begin at the bottom and climb to the top. See if you can reach the top without making a single mistake. You may take time to check your results. Write your results neatly, one row for each step.

Ladder

11

Step 9. *a.* 2.16 mi. — $1\frac{3}{4}$ mi. *b.* 5.72 ft. — 5 ft. 3 in.
 c. 2 min. $10\frac{1}{2}$ sec. — 93.4 sec. *d.* 30.28 A. — $10\frac{1}{5}$ A.
 e. 10 gal. $2\frac{1}{2}$ qt. — 4.623 gal.

Step 8.	<i>a.</i>	<i>b.</i>	<i>c.</i>	<i>d.</i>	<i>e.</i>
	$25\frac{7}{12}$	$10\frac{1}{4}$	$9\frac{5}{16}$	$5\frac{7}{16}$	$4\frac{2}{3}$
	<u>$12\frac{3}{4}$</u>	<u>$7\frac{1}{3}$</u>	<u>$6\frac{3}{8}$</u>	<u>$2\frac{3}{4}$</u>	<u>$1\frac{3}{4}$</u>

Step 7.	<i>a.</i>	<i>b.</i>	<i>c.</i>	<i>d.</i>	<i>e.</i>
	$28\frac{3}{4}$	$40\frac{1}{2}$	$10\frac{1}{4}$	$24\frac{1}{3}$	$37\frac{1}{2}$
	<u>$16\frac{1}{8}$</u>	<u>$14\frac{3}{8}$</u>	<u>$6\frac{1}{2}$</u>	<u>$11\frac{1}{2}$</u>	<u>$14\frac{3}{4}$</u>

Step 6.	<i>a.</i>	<i>b.</i>	<i>c.</i>	<i>d.</i>	<i>e.</i>
	$10\frac{1}{3}$	$7\frac{1}{4}$	$15\frac{1}{8}$	$12\frac{1}{5}$	$4\frac{1}{16}$
	<u>$4\frac{2}{3}$</u>	<u>$2\frac{3}{4}$</u>	<u>$6\frac{3}{8}$</u>	<u>$11\frac{4}{5}$</u>	<u>$2\frac{7}{16}$</u>

Step 5.	<i>a.</i>	<i>b.</i>	<i>c.</i>	<i>d.</i>	<i>e.</i>
	$58\frac{4}{5}$	$66\frac{2}{3}$	$28\frac{7}{8}$	$62\frac{1}{2}$	$9\frac{7}{12}$
	<u>$52\frac{1}{5}$</u>	<u>$33\frac{1}{3}$</u>	<u>$7\frac{5}{8}$</u>	<u>$37\frac{1}{2}$</u>	<u>$4\frac{5}{12}$</u>

Step 4. *a.* 4 hr. — 2 hr. 17 min. *b.* 4 lb. 7 oz. — 2 lb. 11 oz.
 c. 1 lb. 5 oz. — 13 oz. *d.* 7 ft. — 2 ft. 8 in.
 e. 1 bu. — 1 pk.

Step 3.	<i>a.</i>	<i>b.</i>	<i>c.</i>	<i>d.</i>	<i>e.</i>
	92 mi.	6735 mi.	\$3 — 89¢	28.4 mi.	\$508.40
	<u>84.15 mi.</u>	<u>6689 mi.</u>		<u>18.04 mi.</u>	<u>208.62</u>

Step 2.	<i>a.</i>	<i>b.</i>	<i>c.</i>	<i>d.</i>	<i>e.</i>
	\$25.00	\$100.00	\$750.00	6124 sq. mi.	7846 sq. mi.
	<u>9.36</u>	<u>71.28</u>	<u>736.50</u>	<u>2494 sq. mi.</u>	<u>2789 sq. mi.</u>

Step 1.	<i>a.</i>	<i>b.</i>	<i>c.</i>	<i>d.</i>	<i>e.</i>
	\$18.64	\$25.39	\$56.70	819.4 mi.	67.55 mi.
	<u>7.40</u>	<u>13.37</u>	<u>45.60</u>	<u>209.2 mi.</u>	<u>36.14 mi.</u>

12. Comparing Amounts

Helen has \$7.50. Maud has \$2.50. Jane has \$5. Alice has \$1.50.

Tell the missing numbers:

1. Helen has . . . more than Maud.
2. Helen has . . . times as much as Maud.
3. Helen and Maud together have . . . times as much as Jane.
4. Maud has . . . less than Jane.
5. Maud has . . . more than Alice.
6. Maud has . . . as much as Jane.
7. Maud has . . . as much as Helen.
8. Jane has . . . as much as Helen.
9. Jane has . . . as much as Maud.
10. Jane has $3\frac{1}{3}$ times as much as . . .
11. Alice has $\frac{3}{5}$ as much as . . .
12. Alice needs . . . more to have as much as Maud.
13. Helen and Jane together have . . . times as much as Maud.
14. Alice has . . . as much as Helen.

If each girl gives 20% of what she has to help buy a victrola —

15. Helen will give . . .
16. Maud will give . . .
17. Jane will give . . .
18. Alice will give . . .

John has \$8.00. Dick has \$4.00. Henry has \$5.00. Tom has \$20.00.

If each boy gives \$2.00 to help buy a boat —

19. John will give . . . percent of what he has.
20. Dick will give . . . percent of what he has.
21. Henry will give . . . percent of what he has.
22. Tom will give . . . percent of what he has.
23. John's money is to . . . 's money in the ratio or proportion of 2 to 1.
24. John's money is to . . . 's money in the ratio or proportion of 8 to 5.
25. Tom's money is to John's money in the ratio or proportion of 20 to 8 or 5 to . . .

Find the missing numbers:

1. One gun weighs 8 lb. 11 oz. 8 such guns weigh...
2. One pail holds 2 gal. 2 qt. 7 such pails hold...
3. 1 trip requires 1 hr. 17 min. 4 such trips require...

Write the products. You need not copy the numbers:

4.	5.	6.	7.	8.	9.
hr. min. sec.	hr. min. sec.	Dollars Dimes Cents	Ones Tenths Hundredths Thousandths		
1 29 10 9	1 7 8 6	7 6 5 5	2 .0 8 4 8	60.209 3	79.6 7

In multiplying with integers (whole numbers) or decimal numbers we multiply the digit that means the smallest quantity first and count 10 thousandths as 1 hundredth, 10 hundredths as 1 tenth, 10 tenths as 1 one, etc.

You can check the result by multiplying in this way:

10. Find the product and check the result for

$$\begin{array}{r}
 79.6 \\
 7 \\
 \hline
 7 \times .6 = 4.2 \\
 7 \times 9 = 63 \\
 7 \times 70 = 490 \\
 \hline
 557.2
 \end{array}$$

$$\begin{array}{r}
 279.6 \\
 9 \\
 \hline
 \end{array}$$

Write the products. Check each result by multiplying separately and adding.

11.	12.	13.	14.	15.	16.
\$23.75 8	\$69.40 6	82.67 mi. 9	394.5 mi. 7	\$92.25 4	8546 5

Write the products. Check each result as shown for problem 17.

9 × 8 = 72	17.	18.	19.	20.	21.
9 × 20 = 180					
9 × 700 = 6300	728	874	356	\$92.05	\$78.50
60 × 8 = 480	<u>69</u>	<u>58</u>	<u>37</u>	<u>29</u>	<u>64</u>
60 × 20 = 1200					
60 × 700 = <u>42000</u>					

1. State another way to check results in multiplication, besides those shown on page 13.

2. State the products (without using pen or pencil) when you multiply each of these numbers by 3. By 9. By 7. By 4.

<i>a.</i>	<i>b.</i>	<i>c.</i>	<i>d.</i>	<i>e.</i>	<i>f.</i>	<i>g.</i>	<i>h.</i>	<i>i.</i>
15	21	35	18	75	24	16	57	29
<i>j.</i>	<i>k.</i>	<i>l.</i>	<i>m.</i>	<i>n.</i>	<i>o.</i>	<i>p.</i>	<i>q.</i>	
43	125	144	189	275	315	98	111	

3. What would be an easy way to find the product of 999

4

4. What would be an easy way to find the product of 14.98

6

Write the products. You need not copy the numbers.

5.	6.	7.	8.	9.	10.	11.
\$3.50	\$4.75	\$9.50	\$15.00	\$1600	.285	64.2
<u>.06</u>	<u>.20</u>	<u>30</u>	<u>.04</u>	<u>.005</u>	<u>7</u>	<u>700</u>
12.	13.	14.	15.	16.	17.	18.
42.9	7.38	650	.195	67.2	4.36	817
<u>.08</u>	<u>.09</u>	<u>60</u>	<u>8</u>	<u>.009</u>	<u>600</u>	<u>.90</u>

19. State a rule for placing the decimal point in the product.

15. Different Ways of Multiplying and Dividing

1. State the cost of —

a. 150 2-cent stamps.

e. 100 gal. oil at 13¢ per gal.

b. 36 3-cent stamps.

f. 10 baseball suits at 98¢ each.

c. 75 4-cent stamps.

g. 8 cards at 2 for a cent.

d. 25 5-cent stamps.

h. 24 cards at 3 for a cent.

“8% of” means “.08 ×”

“4½% of” means “.045 ×”

2. State the missing numbers:

8 percent of \$70 =

9% of \$600 =

6 “ “ \$500 =

4½% of \$100 =

10 “ “ \$2.50 =

5% of \$4.20 =

20 “ “ \$9 =

2½% of \$10 =

3. State the products:

$$\begin{array}{llll} a. \frac{1}{4} \times 280 & b. \frac{1}{2} \times 250 & c. \frac{1}{8} \times 400 & d. \frac{1}{6} \times 120 \\ e. \frac{1}{3} \times 375 & f. \frac{1}{5} \times 75 & g. \frac{1}{3} \times 900 & h. \frac{1}{8} \times 200 \\ i. \frac{1}{8} \times 72 & j. \frac{1}{4} \times 48 & k. \frac{1}{8} \times 144 & l. \frac{1}{10} \times 450 \end{array}$$

4. Supply the missing numbers:

a. To multiply by $\frac{1}{4}$ divide by...

b. " " " $\frac{1}{2}$ " " ...

c. " " " $\frac{1}{8}$ " " ...

5. a. What is the reciprocal of $\frac{1}{3}$? b. What is the reciprocal of $\frac{1}{5}$? c. Of $\frac{1}{8}$? d. Of $\frac{1}{4}$? e. Of $\frac{1}{10}$?

To divide by a number you may multiply by its reciprocal.

To multiply by a number you may divide by its reciprocal.

6. Write the quotients:

$$a. \frac{1}{2} \div \frac{1}{4} \quad b. \frac{3}{2} \div \frac{3}{4} \quad c. 6 \div \frac{2}{3} \quad d. 7\frac{5}{4} \div \frac{5}{4}$$

$$e. 8 \div \frac{1}{2} \quad f. 8 \div \frac{1}{4} \quad g. 8 \div \frac{1}{8} \quad h. 10\frac{1}{3} \div \frac{5}{6}$$

16. Canceling

Find the products. Use pencil when you need to.

$$\begin{array}{llll} 1. \frac{3}{4} \times 5 & 2. 10 \times \frac{1}{3} & 3. 3 \times \frac{5}{8} & 4. 11\frac{1}{8} \times 3 \\ 5. 11 \times \frac{7}{8} & 6. 9 \times \frac{3}{4} & 7. \frac{1}{4} \times 11 & 8. \frac{3}{4} \times 9 \end{array}$$

9. Read, supplying the missing numbers:

$$\left. \begin{array}{l} \frac{3}{4} \times \\ \text{or} \\ \times \frac{3}{4} \end{array} \right\} \text{means} \left\{ \begin{array}{l} \text{multiply by 3} \\ \text{and} \\ \text{divide by} \dots \end{array} \right.$$

$$\left. \begin{array}{l} \frac{9}{8} \times \\ \text{or} \\ \times \frac{9}{8} \end{array} \right\} \text{means} \left\{ \begin{array}{l} \dots \text{by} \dots \\ \text{and} \\ \dots \text{by} \dots \end{array} \right.$$

We usually express results obtained by adding, subtracting, multiplying, and dividing common fractions in lowest terms.

A fraction is in lowest terms when no integer except 1 will divide both numerator and denominator without remainder.

$$\left. \begin{array}{llll} \frac{3}{4} & \frac{5}{6} & \frac{11}{12} & 1\frac{7}{8} \\ \frac{2}{3} & \frac{1}{2} & \frac{3}{8} & \frac{9}{16} \end{array} \right\} \text{are in lowest terms.}$$

$$\left. \begin{array}{llll} \frac{6}{8} & \frac{15}{18} & \frac{55}{60} & 1\frac{21}{24} \\ \frac{8}{12} & \frac{4}{8} & \frac{9}{24} & \frac{18}{32} \end{array} \right\} \text{are not in lowest terms.}$$

10. Examine each of these. If it is in lowest terms, say, "Is in lowest terms." If it is not already in lowest terms, express it in lowest terms.

$$\begin{array}{cccccc}
 a. \frac{10}{8} & b. \frac{12}{6} & c. \frac{9}{4} & d. \frac{1}{4} & e. 1\frac{5}{8} & f. \frac{14}{12} & g. \frac{4 \times 3}{2} \\
 h. \frac{3}{8} & i. \frac{9 \times 2}{6} & j. \frac{6}{8} & k. \frac{5}{6} & l. \frac{6}{9} & m. \frac{8}{12} & n. \frac{9}{16} \\
 o. \frac{21}{24} & p. \frac{11}{12} & q. \frac{15}{18} & r. \frac{55}{60} & & &
 \end{array}$$

To find the product of a fraction and an integer, cancel if you can. Multiply the integer and numerator. Divide by the denominator.

To find the product of a fraction and a fraction, cancel if you can.

Write the product of the numerators as the numerator of the result; write the product of the denominators as the denominator of the result.

Cancel and express the result in lowest terms:

11. $\frac{3}{2} \times \frac{5}{6}$	12. $1\frac{5}{8} \times \frac{3}{5}$	13. $\frac{5}{4} \times 1\frac{2}{5}$	14. $\frac{9}{8} \times \frac{2}{3}$
15. $8 \times \frac{3}{4}$	16. $12 \times \frac{2}{3}$	17. $\frac{3}{4} \times 18$	18. $\frac{5}{8} \times 22$
19. $\frac{7 \times 5 \times 9}{3 \times 2 \times 2}$	20. $\frac{8 \times 9 \times 3}{3 \times 4 \times 2}$	21. $1\frac{0}{16} \times 20$	22. $\frac{3}{4} \times 28$

17. Multiplying by .001, .01, .1, 10, 100, and 1000

1. Is it allowable to think of these numbers
6381, 21.94, 361.7, 945, and 2.87
as 6381.0000, 21.94000, 361.700, 945.000, and 002.87000?
2. Multiply each of the five numbers above by 10 and state the result.
3. Multiply each of the five numbers above by 100 and state the result.
4. Multiply each of the five numbers above by 1000 and state the result.
5. Multiply each of the five numbers above by .1 and state the result.

6. Multiply each of the five numbers above by .01 and state the result.
7. Find 10% of each of the five numbers and state the result.
8. State rules for multiplying by 1000, 100, 10, .1, .01, and .001 by moving the decimal point and annexing or prefixing 0, 00, 000, etc.
9. State rules for *dividing* by 1000, and 100.
10. State rules for *dividing* by 10, 1, .1 and .01.

18. Saving Time in Multiplying

1. Which of these ways would you use to find the product of $144 \times 16\frac{2}{3}$, *a*, or *b*, or *c*, or *d*?

a.

$$\begin{array}{r} 16\frac{2}{3} \\ 144 \\ \hline 64 \\ 64 \\ 16 \\ \hline 96 \\ \hline 2400 \end{array} \quad 144 \times \frac{48}{3} = 96$$

b.

$$\begin{array}{r} 144 \\ 16\frac{2}{3} \\ \hline 96 \\ 864 \\ \hline 144 \\ \hline 2400 \end{array}$$

c.

$$144 \times \frac{24}{6} \times 100 = 2400$$

d.

$$\begin{array}{r} 2400 \\ 6 \overline{)14400} \end{array}$$

2. Supply the missing numbers. Learn these rules if you do not know them already.

To multiply by $12\frac{1}{2}$, multiply by 100 and divide by...

To multiply by $16\frac{2}{3}$, multiply by 100 and divide by...

To multiply by 25, multiply by 100 and divide by...

To multiply by $33\frac{1}{3}$, multiply by... and divide by...

To find $12\frac{1}{2}\%$ of a number or to multiply by $.12\frac{1}{2}$, divide by..

To find $16\frac{2}{3}\%$ of a number or to multiply by $.16\frac{2}{3}$, divide by..

To find 25% of a number or to multiply by .25, divide by..

To find $33\frac{1}{3}\%$ of a number or to multiply by $.33\frac{1}{3}$, divide by..

3. Find the products:

- a.* 25×924 *b.* $33\frac{1}{3} \times 750$ *c.* $48 \times 12\frac{1}{2}\text{¢}$ *d.* $36 \times 16\frac{2}{3}\text{¢}$
e. $33\frac{1}{3} \times 240$ *f.* $24 \times 12\frac{1}{2}\text{¢}$ *g.* $18 \times 25\text{¢}$ *h.* 144×25
i. $16\frac{2}{3}\%$ of \$30 *j.* $12\frac{1}{2}\%$ of \$200 *k.* 25% of \$1500
l. $33\frac{1}{3}\%$ of \$7.50 *m.* 25% of \$144 *n.* $12\frac{1}{2}\%$ of \$3000

Saving Time in Multiplying

4. Which of these ways would you use to find the cost of 258 carfares at 5¢ each, *a* or *b*?

<i>a.</i>	<i>b.</i>
5	258
<u>258</u>	<u>5</u>
40	1290
25	
<u>10</u>	\$12.90
1290	
\$12.90	

5. Find the number of miles walked in a year by a girl who averages 7 miles per day.
6. Find the cost of traveling 2142 miles at $2\frac{1}{2}$ ¢ per mile.
7. Find the total cost of a meal for 2130 men at 20¢ per man.

19. Division: Review

In division we find:

I. How many times one quantity is contained in another quantity, or

II. How large each part will be when a certain quantity is divided into a certain number of equal parts.

1. State two problems requiring division of the first sort.
2. State two problems requiring division of the second sort.
3. Read, supplying the missing numbers:

<p><i>a.</i> 32 ft. = . . . times 8 ft.</p> <p><i>b.</i> 42 ft. = 7 parts each . . . ft.</p> <p><i>c.</i> 27 mi. = 9 parts each . . . mi.</p> <p><i>d.</i> 54¢ will buy . . . 9-cent articles.</p> <p><i>e.</i> \$7.50 = . . . × \$2.50.</p> <p><i>f.</i> \$18.00 = 6 × . . .</p>	<p><i>g.</i> A 500-gallon tank contains . . . × 50 gallons.</p> <p><i>h.</i> 48 min. is . . . times as long as 6 min.</p> <p><i>i.</i> $72 \div 9 = \dots$</p> <p><i>j.</i> $72 = \dots \times 12.$</p>
---	---

In dividing with integers or decimal numbers, you estimate what the quotient will be, one digit at a time.

4. What do you estimate will be the first digit in the quotient in each of these?
- | | |
|-----------------------------------|--------------------------------------|
| <i>a.</i> $15 \overline{)7082}$ | How do you know that 5 is too large? |
| <i>b.</i> $21 \overline{)8519}$ | How do you know that 3 is too small? |
| <i>c.</i> $117 \overline{)34152}$ | How do you know that 3 is too large? |

In dividing with integers and decimal numbers, your result will be correct, if —

- I. You make sure that each estimate is right before going on to the next.
- II. You multiply the divisor correctly by each quotient digit and write each product in the right place.
- III. You subtract correctly and “bring down” the right digit or digits from the dividend.
- IV. You put the decimal point in the right place.

Unless you are a very accurate worker, it is best to check every result in long division by multiplying the quotient by the divisor.

Find the quotients. Check your results in 1 to 10. If you make any mistakes, find out what they are and correct them. If you have all ten correct the first time, you need not check your results in 11 to 21.

Do not extend the division to any decimal places.

1.
$$32 \overline{)15000}$$

2.
$$3500 = 144 \times \dots$$

3.
$$\frac{2913}{140}$$

4.
$$66 \overline{)7500}$$

5.
$$3204 = 89 \times \dots$$

6.
$$\frac{1000}{15}$$

7.
$$16 \overline{)2800}$$

8.
$$500 = 18 \times \dots$$

9.
$$\frac{1600}{33}$$

10.
$$75 \overline{)18750}$$

11.
$$968 \div 22 =$$

12.
$$\frac{1800}{27}$$

13.
$$44 \overline{)10000}$$

14.
$$640 \div 107 =$$

15.
$$\frac{1000}{203}$$

16.
$$15 \overline{)2250}$$

17.
$$1575 \div 45 =$$

18.
$$\frac{2000}{506}$$

19.
$$225 \overline{)9000}$$

20.
$$5000 \div 130 =$$

21.
$$\frac{6400}{217}$$

21. Oral Review

Practice with these until you can give all the quotients in 3 min.

A.

a. $10 = \dots \times 2$

b. $10 = \dots \times 3\frac{1}{3}$

c. $12 = \dots \times 2$

d. $12 = \dots \times 3$

e. $12 = 1\frac{1}{2} \times \dots$

f. $15 = \dots \times 5$

g. $15 = 2 \times \dots$

h. $15 = \frac{1}{3} \times \dots$

B.

i. $15 = \frac{1}{4} \times \dots$

j. $15 = \frac{1}{2}$ of \dots

k. $15 = 3 \times \dots$

l. $16 = \dots \times 2$

m. $18 = \dots \times 2$

n. $18 = \dots \times 3$

o. $20 = 2 \times \dots$

p. $20 = 5 \times \dots$

C.

q. $20 = \frac{4}{5}$ of \dots

r. $20 = \frac{5}{6}$ of \dots

s. $20 = \frac{2}{3}$ of \dots

t. $24 = 2 \times \dots$

u. $24 = 1\frac{1}{2} \times \dots$

v. $24 = 3 \times \dots$

w. $24 = 50\%$ of \dots

x. $24 = 10\%$ of \dots

D.

$32 = \frac{1}{2}$ of \dots

$32 = \frac{1}{4}$ of \dots

$32 = \frac{2}{3}$ of \dots

$32 = 50\%$ of \dots

$32 = 10\%$ of \dots

E.

$16 = \dots$ of 24

$16 = \dots$ of 48

$16 = \dots$ of 32

$16 = \dots$ of 160

$16 = \dots\%$ of 200

F.

$6 = \dots$ of 9

$6 = \dots$ of 10

$6 = \dots$ of 11

$6 = \dots$ of 12

$6 = \dots$ of 15

22. Zero in Multiplication and Division

0 or zero means *not any* or *no*

In 60, 0 means no ones; in 604, 0 means no tens; 0 alone by itself means just not any of the thing under discussion.

I. Read, supplying the missing numbers:

A. $0 \div 7 =$

B. $0 + 6 =$

C. $0 \times 0 =$

D. $0 \times 9 =$

$0 + 4 =$

$8 \times 0 =$

$0 \div 6.1 =$

$8 - 0 =$

$0 \times 3 =$

$0 \div 8 =$

$0 \div .085 =$

$0 \times 1.94 =$

$7 - 0 =$

$0 \div .27 =$

$0 \times .62 =$

$0 - 0 =$

(With pencil.)

II. Find the products:

1. 208×304

2. 609×720

3. 10.05×6.07

4. 210×790

5. 8×400.50

6. 60% of \$10.50

7. $305 \times \$20.03$

8. 105% of \$40

9. 202×202

III. Find the quotients:

10. $16 \overline{)32096}$

11. $24 \overline{)720025}$

12. $.75 \overline{)225075}$

13. $9 \overline{)90387}$

Divisor \times Quotient must = Dividend

The number of decimal places in the divisor plus the number of decimal places in the quotient must equal the number of decimal places in the dividend.

1. Using this rule, tell where the decimal point should be placed in each of these. Prefix or annex 0 or 00 if necessary.

a.

$$21.4 \overline{)69.764} \quad \begin{array}{r} 326 \\ \hline \end{array}$$

b.

$$.214 \overline{)6.9764} \quad \begin{array}{r} 326 \\ \hline \end{array}$$

c.

$$2.14 \overline{)697.64} \quad \begin{array}{r} 326 \\ \hline \end{array}$$

d.

$$214 \overline{)697.64} \quad \begin{array}{r} 326 \\ \hline \end{array}$$

e.

$$525 \overline{)588.00} \quad \begin{array}{r} 112 \\ \hline \end{array}$$

f.

$$5.25 \overline{)58.800} \quad \begin{array}{r} 112 \\ \hline \end{array}$$

g.

$$5.25 \overline{).058800} \quad \begin{array}{r} 112 \\ \hline \end{array}$$

h.

$$.525 \overline{)588.000} \quad \begin{array}{r} 112 \\ \hline \end{array}$$

2. Supply the missing words in this rule:

Rule I

If the divisor is an integer, the number of decimal places in the quotient should be.....the number of decimal places in the dividend.

If the divisor is a decimal number, use Rule II or Rule III.

Rule II

Multiply both divisor and dividend by 10 or 100 or 1000, etc., to make the divisor an integer, and use Rule I.

Rule III

Make a mark in the dividend as many decimal places to the right of the decimal point as there are decimal places in the divisor. Place the decimal point in the quotient above this mark.

Use Rule II or Rule III as your teacher directs.

Whichever rule you use, check your result by making sure that Divisor \times Quotient = Dividend.

3. Find the quotients to the second decimal place:

a. $1.6 \overline{)35}$

b. $.15 \overline{)5.35}$

c. $.225 \overline{)9.5}$

d. $1.04 \overline{)6.5}$

e. $.35 \overline{)10}$

f. $1.06 \overline{)8.5966}$

g. $3.1 \overline{).73}$

h. $.345 \overline{)25}$

22 24. Multiplying and Dividing by .01, .1, 10, 100, etc.

1. State the missing numbers:

A.

$$\begin{aligned} 10 \times \$1.25 &= \\ 100 \times \$2.50 &= \\ 10 \times 49¢ &= \\ 10\% \text{ of } \$4.50 &= \\ 1\% \text{ of } \$300 &= \end{aligned}$$

B.

$$\begin{aligned} .01 \times \$65 &= \\ .10 \times \$8.20 &= \\ .05 \times \$40 &= \\ 5\% \text{ of } \$600 &= \\ 1000 \times \$23 &= \end{aligned}$$

C.

$$\begin{aligned} 90 \text{ mi. } \div 10 &= \dots \text{ mi.} \\ 90 \text{ mi. } \div 100 &= \dots \text{ mi.} \\ \frac{1}{10} \text{ of } 365 &= \dots \\ \$65.50 \div 10 &= \dots \\ 10\% \text{ of } 70¢ &= \dots \end{aligned}$$

2. State the missing words and numbers:

a. To multiply by 10 move the decimal point...place to the
.... Annex 0 if necessary.

b. To multiply by 100, move the decimal point...places to
the.... Annex 0 or 00 if necessary.

c. To divide by 10 or to multiply by .1 or .10, move the
decimal point... place to the... Prefix...if necessary.

d. To divide by 100 or to multiply by .01, move the decimal
point... places to the.... Prefix...if necessary.

3. State a rule for multiplying by 1000. 4. For dividing by 1000.

5. State a rule for multiplying by .001.

6. State a rule for multiplying by 10% (remember that "10%
of" means ".10 ×").

7. State a rule for multiplying by 1%.

8. What is the exact cost of one article at \$1.50 per hundred?

9. What is the exact cost of one article at 10 for 50¢? 10. At
2 for a cent?

11. What is the exact cost of one article at 30 cents a dozen?

12. Tops can be made in lots of 1000 at \$.0064 each. What is
the total cost for a thousand?

13. An automobile used 92 gallons of gasoline in going 1000 miles.
How much was used per mile?

14. The expenses of the East Side School baseball team will be
\$75.00. How much must each person pay if the cost is
shared equally (a) By 25 people? (b) By 50 people?
(c) By 75 people? (d) By 100 people?

15. Tell, or show, how you multiply by 20 or 30 or 40 or 50.

16. Tell, or show, how you find 20 or 30 or 40 or 50 percent of a
number.

17. State the products and quotients:

- | | | | |
|-------------------------|---------------------------|------------------------------|-----------------------------|
| $a. 60 \times 21$ | $e. 80 \overline{)5600}$ | $i. 70\% \text{ of } \$1.50$ | $m. 90\% \text{ of } \$120$ |
| $b. 90 \overline{)720}$ | $f. 60 \overline{)42}$ | $j. 60\% \text{ of } \$300$ | $n. .40 \times \$6.10$ |
| $c. 70 \overline{)63}$ | $g. 90\% \text{ of } 400$ | $k. 90 \overline{)5400}$ | $o. .30 \times 25$ |
| $d. .80 \times 250$ | $h. 70 \times 70$ | $l. 80 \overline{)24}$ | $p. 80 \times .500$ |

25. Problems

Cast Steel Music Wire for All Purposes
Requiring Great Strength and
Resiliency

Number	Diameter in Inches	Feet per Pound	Price per Pound
1	.010	3700	\$2.30
3	.012	2540	1.55
5	.014	2000	1.10
7	.018	1130	.85
9	.022	767	.60
15	.034	322	.40
20	.044	192	.35

1. Read this table saying, "No. 1 wire is 10 thousandths of an inch in diameter. There are 3,700 feet of it in 1 pound. It costs two dollars and thirty cents a pound. No. 3 wire is 12 thousandths of an inch in diameter. There are 2540 feet of it in a pound. It costs \$1.55 a pound," and so on.

- How much larger is the diameter of No. 3 wire than that of No. 1?
- How much larger is the diameter of No. 20 than that of No. 15?
- Which sort of wire has about 20 times as many feet per pound as No. 20?
- Which sort has about 4 times as many feet per pound as No. 20?
- How much does 1000 feet of each sort of wire weigh?
- How much does 1000 ft. of each sort of wire cost?
- What length of wire of each sort would there be in $2\frac{1}{2}$ lb.?
- What would be the cost of $\frac{1}{4}$ lb. of No. 1 wire, $\frac{1}{2}$ lb. of No. 5 wire, 2 lb. of No. 7, and 10 lb. of No. 20?
- How many feet of No. 9 wire should you get for \$1.00?
- How many feet of No. 15 wire should you get for \$1.00?

26. The Reciprocal Rule

In dividing with common fractions as divisors, dividends, or both, use this rule:

To divide by a number, multiply by its reciprocal.

1. State the missing numbers:

A.	B.	C.
$8 \div 8 =$	In 12 there are...6s	$12 = \dots \times \frac{1}{4}$
$8 \div 4 =$	In 12 there are...4s	$12 = \dots \times \frac{3}{4}$
$8 \div 2 =$	In 12 there are...3s	$12 = \dots \times \frac{1}{3}$
$8 \div 1 =$	In 12 there are... $\frac{1}{2}$ s	$12 = \dots \times \frac{2}{3}$
$8 \div \frac{1}{2} =$	In 12 there are... $\frac{1}{3}$ s	$12 = \dots \times \frac{1}{2}$
$8 \div \frac{1}{4} =$	In 12 there are... $\frac{1}{4}$ s	$12 = \dots \times 1\frac{1}{2}$ or $\frac{3}{2}$
$8 \div \frac{1}{8} =$	In 12 there are... $\frac{1}{6}$ s	$12 = \dots \times 1\frac{1}{3}$ or $\frac{4}{3}$

2. How many pieces of wire, each $3\frac{3}{4}$ ft. long, can be cut from a piece 150 ft. long?
3. At $62\frac{1}{2}$ ¢ or $\$ \frac{5}{8}$ per hour, how long will it take a man to earn $\$3.87\frac{1}{2}$ or $\$3\frac{7}{8}$?
4. A certain coin is worth $16\frac{2}{3}$ ¢. How many of them will it take to make a dollar and a half?

Supply the missing numbers:

5. $4\frac{1}{2} = \dots$ times as much as $1\frac{1}{2}$.
6. $25 = \dots$ times as much as $16\frac{2}{3}$.
7. $6\frac{1}{4} = \dots$ times as much as $\frac{5}{8}$.
8. $33\frac{1}{3} = \dots$ times as much as $8\frac{1}{3}$.

You may use this rule:

To divide by a number, multiply by its reciprocal
with any number if you can gain accuracy and speed by using it.

For example, if you had to divide many numbers by 3.1416, it would save time to find the reciprocal of 3.1416 (it is .318) and multiply by .318 instead of dividing by 3.1416.

9. Divide each of the numbers in *a* to *j* by .03125 by multiplying by the reciprocal of .03125.

First find the reciprocal by $.03125 \overline{)1.00000}$

a.	b.	c.	d.	e.	f.	g.	h.	i.	j.
3	5	8.1	100	10.04	17	90	1.3	3.1	50.2

Some cases where you would use the reciprocal rule are:

To divide by $6\frac{1}{4}$, multiply by .16. To divide by $.06\frac{1}{4}$, multiply by 16.

To divide by $8\frac{1}{3}$, multiply by .12. To divide by $.08\frac{1}{3}$, multiply by 12.

To divide by $12\frac{1}{2}$, multiply by .08. To divide by $.12\frac{1}{2}$, multiply by 8.

10. Describe any other cases where you would use this rule.

27. Different Uses of Quotients

1. Find the average number of miles per hour for the Overland Express which went 742 miles in 13.3 hr. Find the result to the second decimal place.
2. A cow gave 29,512 lb. milk in 365 days. Find the number of pounds per day (to the second decimal place).
3. What is the exact average of \$1.25, \$1.50, and \$1.10?
4. Express $\frac{3}{16}$ as a decimal, finding the exact result.

Often you do not wish to find the exact quotient, but the quotient and remainder. For example, solve these problems:

5. How many 15-ft. lengths can be cut from 1000 ft. of rope, and how much will be left over?
6. How many trips, each requiring 22 minutes, can an automobile make in 3 hours?
7. How many aprons, each requiring 1.25 yd., can be made from a remnant 7 yd. long? How much cloth will be left?

Sometimes the answer to a problem will be the next whole number above the quotient, not the exact quotient. For example, solve these problems:

8. A ferry boat carries 14 men per trip. How many trips must be made to carry 110 men?
9. If each carriage holds only 4 people, how many carriages are required to take 30 people to a picnic?
10. Thirty-three children share equally the cost of a \$6.50 picture for the school. What does each child pay?

Whatever quantity is called 1 is the unit of measure.

1. Read. Supply the missing words as is shown in the first two lines.
 - a. A half mile is $\frac{1}{2}$ if we are using *a mile* as the unit of measure.
 - b. A half mile is 160 if we are using *a rod* as the unit of measure.
 - c. A half mile is 880 if we are using . . . as the unit of measure.
 - d. A half mile is 2640 if we are using . . . as the unit of measure.
 - e. This square is 2×2 if we use an . . . as the unit of length.
 - f. This square is $\frac{1}{6} \times \frac{1}{6}$ if we use a . . . as the unit of length.
 - g. An hour is 1 if we use an . . . as the unit of measure.
 - h. An hour is $\frac{1}{24}$ if we use . . . as the unit of measure.
 - i. An hour is 60 if we use . . . as the unit of measure.

Any quantity is a multiple of some unit.

Thus 9 mi. is 9×1 mi., $10\frac{1}{2}$ mi. is $10\frac{1}{2} \times 1$ mi., $3\frac{3}{4}$ lb. is $3\frac{3}{4} \times 1$ lb.

In using the dimensions of any surface to find its area, express both dimensions as multiples of the same unit. Choose a convenient unit.

2. Supply the missing words:

- a. Length of a rectangle in \times width in = area in sq. in.
- b. Length of a rectangle in \times = area in sq. ft.
- c. Length of a rectangle in yards \times = area in
- d. Base of a parallelogram in inches \times altitude in = area in
- e. Base of a parallelogram in miles \times altitude in = area in

- f. Base of a triangle in feet $\times \frac{1}{2}$ of = sq. ft.
- g. Average of two parallel sides of a trapezoid \times altitude = area. If dimensions are in inches, area is in If dimensions are in feet, area is in If dimensions are in miles, area is in

(With pencil.)

3. How many square feet are there in a road 2.4 miles long and 18 ft. wide, counting the road as perfectly straight?
4. How many square yards of material are there in a big flag 5 yards long and 10 ft. wide?
5. What fraction of a square mile is the area of this park?



In using the dimensions of any box or bin or solid to find its capacity or volume, express all dimensions in the same unit.

6. How many cubic feet will a rectangular trough contain that is 10 ft. long, 2 ft. 6 in. wide, and 18 in. deep?
7. A rectangular pile of wood $4 \times 4 \times 8$ ft. equals 1 cord of 4-ft. wood. How many cords of 4-ft. wood are there in a pile 4 ft. wide, 4 ft. high, and 24 yards long?
8. How many cubic yards are excavated in digging a hole 40 ft. by 24 ft. by 8 ft.?

In solving any problem, think what the units of measure mean.

9. The Merchants' Express goes 220 miles in 4 hr. 24 min. The Continental goes at the rate of a mile in 80 seconds. Which goes faster? Prove that your answer is right.
10. Helen can add 100 two-place numbers in 248 seconds. Alice can add the numbers at the rate of 30 a minute. Which girl adds more rapidly? Prove that your answer is right.

29. Units of Measure in Division

1. Read, supplying the missing words:

To find how many times a certain amount of money is contained in another amount of money, express both as cents or express both as; then divide.

To find how many times a certain area is contained in another area, express both as multiples of the same unit (both as sq. in., or both as, or both as, or both as, or both as); then divide.

In every case, to find how many times as large as another one quantity is, express both quantities as multiples of the same unit. Then divide.

(With pencil.)

2. How many 15-cent toys can be bought for \$3.75?
3. How many gal. of water will a square can $16 \times 16 \times 16$ in. hold? (1 gal. = 231 cu. in.)
4. How many sheets, each 1 ft. by $1\frac{1}{2}$ ft., can be cut from a roll of paper 2 ft. wide and 10 yd. long?
5. How many feet equal 28 percent of a mile and a half?
6. How many square feet are there in a floor 4 yd. long and $3\frac{1}{2}$ yd. wide?

30. Percents. Oral Review

We may express a quantity in one of three ways:

As a number of units. For example, 25 cents.

As a common fraction of some other quantity. For example, a quarter of a dollar.

As so many hundredths or percent of some other quantity. For example, $12\frac{1}{2}\%$ of \$2.00.

1. Express these as percents of \$5.00:

\$1.00	\$1.50	\$1.75	\$2.40	\$4.50	\$6.00
\$10.00	\$25.00	$\frac{1}{8}$ of \$5.00	$\frac{1}{6}$ of \$5.00		
$\frac{1}{5}$ of \$5.00	$\frac{1}{4}$ of \$5.00	$\frac{1}{3}$ of \$5.00	$\frac{1}{2}$ of \$5.00		

2. Supply the missing numbers:

A.	B.	C.
4% of \$60 = ...	\$15 = 5% of \$...	40 = ... $\%$ of 50
12% of \$2.00 = ...	\$20 = 5% of \$...	35 = ... $\%$ of 50
18 = ... $\%$ of 20	15% of \$6 = ...	8 = 4% of ...
18 = ... $\%$ of 30	10% of \$1.50 = ...¢	150% of 140 = ...

3. Would arithmetic be easier if people said, "*The team won .62 \times the games it played,*" instead of, "*The team won 62% of the games it played,*" and if they said, "*The bank pays .035 \times the money you leave there for a year,*" instead of, "*The bank pays $3\frac{1}{2}\%$ on the money you leave there for a year*"?

4. Give reasons for your answer to Ex. 3.

You will avoid many mistakes if you always remember that "Percent of" means "Hundredths times." "4% of" means ".04 \times ."
"What percent of" means "How many hundredths of."
"24 \div 30 = .80" means "24 is 80% of 30."

5. Express as decimals:

A.	B.	C.
24%	8%	7%
18%	5%	225%
$4\frac{1}{2}\%$	104%	120%
125%	$3\frac{3}{4}\%$	60%
106%	$2\frac{1}{2}\%$	$\frac{1}{2}\%$

6. Express as common fractions as shown in the first column.

D.	E.	F.
$6\frac{1}{4}\% = \frac{1}{16}$	25%	$66\frac{2}{3}\%$
$8\frac{1}{3}\% = \frac{1}{12}$	$33\frac{1}{3}\%$	75%
$12\frac{1}{2}\% = \frac{1}{8}$	$37\frac{1}{2}\%$	40%
$16\frac{2}{3}\% = \frac{1}{6}$	50%	60%
$20\% = \frac{1}{5}$	$62\frac{1}{2}\%$	$87\frac{1}{2}\%$

7. Express as percents:

G.	H.	I.	J.	K.	L.	M.	N.
.06	2.15	$\frac{1}{2}$	$\frac{1}{5}$	$\frac{2}{3}$	$\frac{5}{8}$.035	$1.04\frac{1}{2}$
.24	$.66\frac{2}{3}$	$\frac{1}{3}$	$\frac{1}{6}$	$\frac{3}{4}$	$\frac{7}{8}$.005	1.46
.045	.0425	$\frac{1}{4}$	$\frac{1}{8}$	$\frac{3}{8}$	$\frac{3}{5}$.00125	$.00\frac{3}{4}$

In working with percents be careful in changing from hundredths with the decimal point to percents without the decimal point.

31. A Picture of a School Day

This is a diagram and table Kate made to show how she usually spends the 24 hours of a school day. W. D. means getting washed and dressed. M.1, M.2, and M.3 mean the three meals.

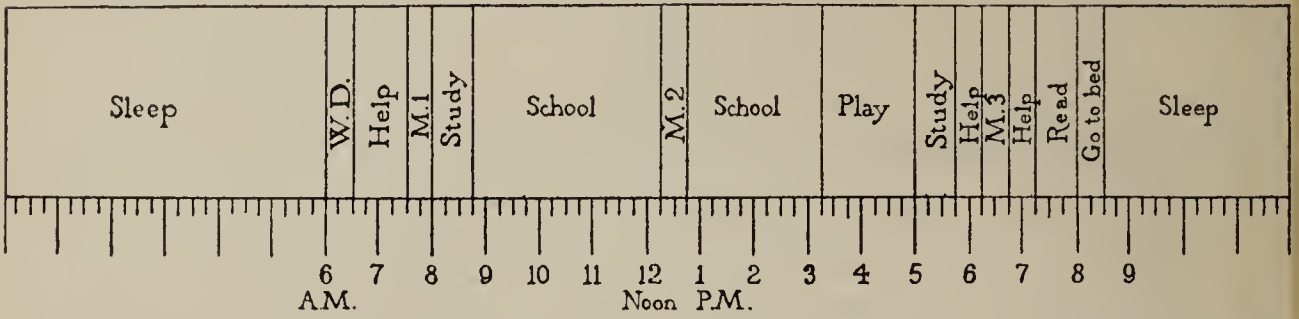

	Hours Spent	Percent of 24 Hours Spent
Sleep	9½	39.6
W. D.	½	2.1
Helping
Meals
Home study
School, including coming and going
Play, reading, games, and going to bed

- Find the correct amounts of time and percents of the 24 hours to put in the table as Kate has done for the first two lines.
- Draw a diagram to show how a child spends a day who spends 37½% of it in sleep, 6¼% in W. D., 6¼% in helping, 6¼% in meals, 25% in school, including coming and going, and the rest in play and reading (in her grade they have no home work). Let a length of ½ inch represent 1 hour.
- How many hours and tenths of an hour per day does each of these persons sleep?
 - A baby who sleeps 70% of the time.
 - A sick person who sleeps only 15% of the time.
 - A little child who sleeps 50% of the time.
- The school session at Kate's school lasts 300 min. 15% of the time is spent on Arithmetic, 25% on English, 6% on Spelling, and 10% on Geography. How many minutes are spent on Arithmetic? On English? On Spelling? On Geography?

Each row is one team. The teacher gives out typewritten problems, or uses those on this page, or writes problems on the blackboard. All start together and write the missing numbers or answers as quickly as they can without making a mistake. At the end of 10 minutes all stop. The pupils interchange papers, mark with a cross each wrong result, and count the number of correct results. A pupil's score is the number of right answers with 2 off for each one wrong. The scores for each row are averaged. The row with the highest average wins. Each pupil who makes any mistakes corrects them at home or during the study hour. Practice with this page until you can make a good score.

1. 15% of \$1.50 = ...
2. 12% of \$2.15 = ...
3. 20% of 80¢ = ...
4. 4% of \$300 = ...
5. $3\frac{1}{2}\%$ of \$46 = ...
6. $\frac{1}{2}\%$ of \$400 = ...
7. 105% of \$90 = ...
8. \$14 = ... % of \$20.
9. 39 = ... % of 70.
10. 56 = ... % of 60.
11. 16 = ... % of 25.
12. 5 = ... % of 7.
13. 8 = ... % of 9.
14. 16 = 20% of ...
15. \$30 = 4% of \$...
16. \$75 = 5% of \$...
17. \$5 = 10% of \$...
18. \$12 = 6% of \$...
19. 6% of \$2000 = ...
20. $4\frac{1}{4}\%$ of \$24.50 = ...
21. $1\frac{1}{2}\%$ of \$6000 = ...
22. 76 = ... % of 380.
23. 22% of 25 mi. = ...
24. 4 = ... % of 11.
25. $\frac{1}{2}\%$ of 600 = ...
26. 3% of 16 mi. = ...
27. 15% of 8 hr. = ...
28. \$25 = ... % of \$130.
29. $\$32\frac{1}{3}$ = ... % of \$40.
30. 15 = 75% of ...
31. $2\frac{1}{2}\%$ of \$450 = ...
32. $\frac{3}{4}\%$ of \$760 = ...
33. 45 = ... % of 80.
34. 72 = ... % of 80.
35. 140 = ... % of 215.
36. 122% of \$64.50 = ...
37. 18 = ... % of 40.
38. $\frac{1}{8}\%$ of \$1000 = ...
39. 21 = ... % of 40.
40. 21 = ... % of 15.
41. 21 = ... % of 10.
42. 57 = ... % of 15.
43. 28 = ... % of 50.
44. 28 = ... % of 15.
45. \$28 = ... % of \$25.
46. \$210 = ... % of \$150.
47. \$217 = ... % of \$200.
48. \$3 = ... % of \$7.
49. 35% of \$16.50 = ...
50. 135% of 68 = ...
51. What % of \$60 is \$42.60?
52. What % of \$80 is \$32.40?
53. \$24 is 4% of what amount?
54. \$24 is 6% of what amount?
55. \$24 is what % of \$75?
56. 24% of \$62 is how much?
57. $\$7.50 + 10\%$ (of 7.50) =
58. $\$7.50 - 10\%$ (of 7.50) =
59. 10% of \$65 + 8% of \$40 =
60. What % of \$600 is \$27?
61. \$3.00 is what % of \$200?
62. 6% of \$1840 =
63. $12\frac{1}{2}\%$ of \$250 =
64. $2\frac{1}{2}\%$ of \$842 =
65. 3 right out of 5 is what % right?
66. 17 right out of 20 is what % right?
67. \$4.75 less 15% (of 4.75) =
68. \$3.60 is what % of \$60?
69. $\frac{1}{8}\%$ of \$2000 = what amount?
70. 4% of \$2000 = what % of \$1000?
71. 63% of 208 = ...
72. 50 = 25% of what amount?
73. 50 = 10% of what amount?
74. 4% of \$132 + 2% of \$61 =
75. $18 \times (15\%$ of \$1.40) =

33. The Use of Percents

1. The Star baseball team won 23 games out of 34 played. The Crescent baseball team won 17 games out of 28 played. Which was the better record, supposing that Stars and Crescents played against equally good teams?
2. Compare these records of Alice, Bertha, and Clara for accuracy in arithmetic, supposing that the problems they attempted were of equal difficulty. Alice attempted 38 problems and had 32 right. Bertha attempted 24 and had 21 right. Clara attempted 29 and had 24 right.
3. The Ames School has 411 boys and 419 girls. The Fulton School has 628 boys and 652 girls. The Roberts School has 204 boys and 218 girls.
 - (a) Which school has the largest percentage of boys?
 - (b) Which has the next largest?
4. Dick bought a dog for 2 dollars and sold it for \$2.50. Joe bought a dog for 5 dollars and sold it for \$6.00. Who made the larger gain per dollar spent?
5. Nell has \$46 in the Empire Bank for which she receives \$1.61 per year as interest. Lucy has \$23 in the Dime Savings Bank for which she receives 92¢ per year as interest. Which bank pays the higher rate of interest?
6. Which of these cows gives the largest number of pounds of butter-fat per year? Which gives the next largest? Which is third? Which stands lowest for pounds of butter-fat?

Glen Rose II	13,060 lb. milk, of which 4.78% is butter-fat.
Glen Lucy	12,021 lb. milk, of which 5.11% is butter-fat.
Duchess Louise	16,208 lb. milk, of which 4.16% is butter-fat.
Dolly of the Vale	20,142 lb. milk, of which 3.41% is butter-fat.
7. Mr. Dow sold \$21,050 worth of goods at an average gain of $18\frac{1}{2}\%$ after paying for the expenses of running his store. Mr. Evans sold \$30,620 worth of goods at an average gain of $10\frac{1}{2}\%$ after paying for the expenses of running his store. Which merchant made more money, Mr. Dow or Mr. Evans? How much more?

Ruth's father, Mr. Dale, buys vegetables, chickens, and eggs from the farmers and sells them to the people in the city. Here is the way he has Ruth fix the prices. She adds 30 percent to what the products cost him and then changes the result a little if necessary to make a convenient price. See how Ruth has fixed the prices for New Potatoes and Golden Bantam Corn.

	Cost Price	Cost Price + 30%	Convenient Selling Price
New Potatoes	30¢ per pk.	39¢	40¢
Golden Bantam Corn	12¢ per doz.	15.6¢	16¢

Find the cost price + 30% and choose a convenient selling price for each of these as Ruth does. If you cannot decide between two convenient prices, put both down.

	Cost Price Mr. Dale Pays	Cost Price + 30%	Convenient Selling Price
1. Refugee Beans	25¢ per pk.
2. Golden Wax Beans	27¢ per pk.
3. Beets	4¢ a bunch
4. Peas	35¢ a pk.
5. Chickens	17¢ a lb.
6. Fresh Eggs	22¢ a doz.
7. Raspberries	7¢ per box
8. Blueberries	11¢ per box
9. Blackberries	10¢ per box
10.	On July 8 Mr. Dale pays \$10.50 for vegetables and sells them at an average advance of 32%. How much does he receive in return for his time and labor and expense that day? That is, how much more does he receive for the vegetables than he pays for them?		
11.	If the expense for the team he uses in collecting and delivering the vegetables is counted as \$1.10, how much does he receive for his time and labor that day?		
12.	How much will a man receive for his time and labor if he buys fruit for \$10.00, pays \$1.25 for a team to use in selling the fruit, and sells the fruit at an advance of 30%?		

35. Property: Inventories

Write the missing numbers:

1. Arthur Dean is 14 years old. He has earned money since he was 10 years old. Last year he earned \$112. This year he expects to earn 15% more than that or.....
2. He has \$215 in the savings bank now. In six months he will receive 2% interest on the \$215 or.....
3. The largest amount of money he ever made in one month was last summer when he bought a broken-down Ford automobile from a man for \$50, paid \$14.25 for repairs on it, and sold it for \$110. His profit was.....
4. The largest amount of money he ever lost in a month was two months later when he bought a second-hand motorcycle for \$30. He had to sell it for 40% less than he paid, so that he lost.....

On Dec. 31 each year he writes out an inventory and appraisal of the important things which he owns. This is what he wrote this year:

PROPERTY OWNED BY ARTHUR DEAN

Inventory or List	Appraisal or Valuation
Money in Empire Savings Bank	\$215.00
Henhouse, wire fence, etc.	40.00
Hens (21 at \$1.80)	37.80
Bicycle	16.00
Work bench and tools	15.00
Watch	6.00

5. What is the total value of Arthur's property?
6. What percent of the total is money in the bank?
7. Make out an inventory and appraisal for Arthur for next year, supposing that his bank account increases 45 percent, the value of the henhouse, etc., decreases 5% by wear and tear, the value of the hens remains the same, the value of the bicycle decreases 20% by wear and tear, the old tools are kept in perfect condition and new tools worth \$4.85 are bought, and the old watch is replaced by a new one worth 1½ times as much.

36. Protection against Loss of Property by Fire 35

Arthur spends 25 cents a year to insure his henhouse against fire. If it burns up Arthur will get \$40 to use in building another.

1. Do you pay anything for insurance against loss by fire?
2. Does your father?
3. If you know something useful about life insurance, fire insurance, accident insurance, insurance against theft, or insurance against sickness, be ready to tell it to the class clearly.
4. Play "INSURANCE" in this way:

One pupil is the "*Insurance Company*." One pupil is "*Fire*." The property to be insured is the written work of the test printed on pages 36 to 38. Each pupil does the work of the test and puts his paper in a pile on the teacher's desk. "*Fire*" comes to the desk with his eyes shut and destroys one of the test papers. If that pupil is *not* insured, he has to do the 20 problems all over again after school. If he *is* insured, "*Insurance Company*" has to give him 20 problems all solved to use in place of the test paper. The pupil whose paper is lost gives these 20 problems to the teacher and does not have to do the test problems again. To be insured a pupil has to solve one of the extra problems and give it to "*Insurance Company*." If you are willing to run the risk of having to do all 20 problems over again, you do not have to do an extra one to buy insurance. If you wish to be insured against the chance that "*Fire*" will happen to destroy your test paper, do one of the extra problems to pay for the insurance. "*Insurance Company*" uses the problems he receives from the other pupils to pay for the losses caused by "*Fire*."

With the help of the other pupils, "*Insurance Company*" writes out for each pupil who pays him a problem an agreement like this:

Policy No.—	Premium, 1 problem. 10 A.M.
The Seventh-Grade Insurance Company agrees to insure..... to the amount of 20 problems against the loss of his test paper by fire within 5 hours from date.	
(Signed)	

An insurance agreement like the one at the bottom of page 35 is called a **Policy**.

The amount that the Insurance Company may have to pay is called the **Face**.

The amount that the pupil who is insured pays is called the **Premium**.

The length of time during which the pupil is insured is called the **Term**.

5. What is the face of this policy?
6. What is the premium?
7. What is the term?
8. Read this description again so that you will know what to do in the game if you are "*Insurance Company*," "*Fire*," or an "*Insured person*."

37. Twenty-Problem Test

1. The Davis family plan to save for an automobile. They found that they spent 80 cents a week in going to the motion pictures last year. They decided to spend only half as much. How much will they save in a year by this?

2. Last year they spent for clothes as follows:

Mr. Davis, \$110.50	Helen, \$115.30
Mrs. Davis, 175.25	Arthur, 70.10

They plan to reduce these expenses for clothes —

20% in the case of Mr. Davis
 35% in the case of Mrs. Davis
 35% in the case of Helen
 15% in the case of Arthur

How much will they save in a year if they do so?

3. Mrs. Davis had a maid at \$18 a month and paid \$1.35 per week for a woman to do the washing. She plans to do her own work; and Helen and Arthur promise to do the washing. Counting the cost of food for the maid as \$2.25 per week, how much will they save in a year by doing the housework and washing themselves?

4. Mr. Davis and Arthur built a garage for the automobile. They paid \$69.25 for the lumber, shingles, etc., and \$7.65 for nails and hardware, and used 5 bags of cement at 45¢ per bag. They had allowed \$75 for the materials for the garage. How much more did they spend than they had allowed?
5. What is the average height of the girls on this basket-ball team?

	Height	Weight	Age
Kate Ahearn	5 ft. 3½ in.	116	16 yr. 2 mo.
Nora Burns	5 ft. 5 in.	124	15 yr. 7 mo.
Bertha Davis	5 ft. 1½ in.	108	14 yr. 9 mo.
Margaret Fox	5 ft. 4½ in.	121	15 yr. 1 mo.
Helen Wells	5 ft. 7½ in.	126	16 yr. 5 mo.

6. What is the average weight?
7. What is the average age?
8. This team won 9 games out of 13 played. What percent did it win?
9. In five tests, each of 40 words to spell, Ruth had —
 33 correct in 1 test,
 34 correct in each of 3 tests,
 38 correct in 1 test.
 How many words did she have correct in all 5 tests together?
10. How many words did she have correct on the average out of 40?
11. What was her average percent correct?

In fifteen trials with a 10-minute speed test, Alice had —
 20 problems right in 1 trial,
 19 problems right in each of 3 trials,
 18 problems right in each of 7 trials,
 17 problems right in each of 3 trials,
 16 problems right in 1 trial.

12. How many problems did Alice do correctly in the entire 150 minutes?
13. How many problems did Alice do correctly on the average in 10 minutes?
14. She attempted 300 problems in all. What percent of those that she attempted did she have correct?

15. Find the cost of 8 bags of coffee of 130 lb. each, at $8\frac{3}{4}\text{¢}$ per lb.
16. V. D. pencils are sold at \$1.70 per gross less 20% discount. Climax pencils are sold at \$1.80 per gross less 25% discount. Which are cheaper?
17. How much cheaper?
18. Each $\frac{1}{8}$ inch on a map in Lucy's book stands for or represents 10 miles. What is the length represented by $1\frac{3}{4}$ inches on the map?
19. What is the area represented on this map by a rectangle $1\frac{3}{4}$ by $1\frac{1}{4}$ inches?
20. Louis puts \$28 in the savings bank. At the end of a year the bank pays back the \$28 with interest at $3\frac{1}{2}\%$. How much does Louis receive back in all?

Extra Problems

- I. How many gallons of gasoline will be used in a 500-mile run if five gallons are enough on the average for $62\frac{1}{2}$ miles?
- II. A tablecloth of Dover Special linen $2\frac{1}{2}$ by $2\frac{1}{2}$ yd. costs \$3.50. What would you expect to pay for a tablecloth of the same material $2\frac{1}{2}$ by $3\frac{1}{2}$ yd.?
- III. How long will a 50-gallon barrel of oil last if $3\frac{1}{4}$ quarts are used each day?
- IV. Dick walked from his home to his grandfather's, a distance of 8 miles. He started at 10:25 A.M. and arrived at 1:10 P.M. How many miles per hour was his average rate?
- V. A man bought 28 barrels of apples for \$58.80, and paid \$22.25 for the expenses of selling and delivering them. He sold 20 barrels at \$3.25 per barrel and 8 barrels at \$3.00 per barrel. How much money did he gain?
- VI. Mary reckons that she makes a profit of \$.0132 on every egg she sells. (a) What is her profit on a dozen eggs? (b) On a hundred eggs?
- VII. Anne kept account of how long she studied outside of school for 25 days. It was 28.4 hours in all. What was the average per day?

(Without pencil.)

- Plan a game of Marine Insurance in which pupils can be insured against having a composition destroyed by "Storm" or "Fire at Sea" and having to rewrite another by paying "Insurance Company" an extra sentence correctly punctuated or an extra exercise in language.
- For which would an insurance company charge more:
 - To insure you against fire for 1 yr. or to insure you for 2 years?
 - To agree to pay you \$2000 if your house burned down, or to agree to pay you \$3000?
 - To insure you against the loss of an automobile by theft, accident, or fire, or to insure you against the loss of an automobile by fire alone?

*The larger the **face**, or amount to be paid
 by the company,*
*The longer the **term**, or time during
 which the company takes the risk,*
*The greater the **risk**,*

} *the larger the **premium**.*

- Which would the insurance company charge more for: \$5000 insurance on a steel and brick building in a city with a very good fire department, or \$5000 insurance on a wooden house in a village with a very poor fire department?
- If a building were used as a garage or a powder factory would the rate for fire insurance be high or low?
- (a) Which of these mean the same rate of insurance as \$1.50 per \$1000? (b) Which mean the same rate as $1\frac{1}{2}$ percent?

.15 per 100	1.50 per 100	.0015	.015	$\frac{3}{20}$ of 1%
$1\frac{5}{100}\%$ = 15 hundredths of a cent on a dollar				$1\frac{1}{2}\text{¢}$ on a dollar.
- At $22\frac{1}{2}$ cents per \$100 what is the premium or cost (a) For \$200 of insurance? (b) For \$2000 of insurance?
- At 20¢ per \$100, what is the premium or cost for \$1500 of insurance?
- At $\frac{1}{4}\%$, what is the premium or cost for \$2000 of insurance?

9. What will it cost to insure a house for \$4000 for a year, at the rate of \$2 per thousand?
10. What will it cost to insure a school building for \$20,000 for 5 years at the rate of \$1.40 per thousand for a year?
11. It costs Mr. Dunn \$12 a year to insure his house for \$6000 and \$4.00 a year to insure his garage for \$1000. The rate of insurance per thousand on his garage is how many times as high as the rate per thousand on his house?

39. Insurance: Valuation

1. If you were an insurance company and a man with a house worth \$4000 wished you to agree to pay \$8000 if it burned down, what would you do?

Sometimes a building is insured for its full value. That is, the face of the policy, or the amount the insurance company agrees to pay, is the same as the full value of the building. Sometimes a building is insured for only $\frac{3}{4}$ or 85% or 70% of its full value. For example, a house worth \$2500 may be insured for only \$2000. If it burned down the company would have to pay only \$2000.

2. Read, supplying the missing numbers:

- a. Mr. Ames's house, worth \$5000, is insured for $\frac{4}{5}$ of its value or
- b. Mr. Bates's house, worth \$5000, is insured for 70% of its value or
- c. Mr. Clark's house, worth \$2400, is insured for $\frac{5}{6}$ of its value, or
- d. Mr. Dow's house, worth \$8000, is insured for \$6000 or % of its value.

(Write out the computations for Ex. 3.)

3. What must be paid as premium or cost of insurance—
 - (a) For a building valued at \$24,000 if it is insured for 75% of its value, at a rate of \$.14 per \$100?
 - (b) For a building valued at \$15,000, insured for $\frac{4}{5}$ of its value, at a rate of \$.16 $\frac{1}{2}$ per \$100?

40. Buying: Sales Slips and Bills and Receipts 41

If you bought 5 cents' worth of candy or a ticket for the motion pictures or a magazine, you would not ask the seller to give you any written account of it, but if you bought five tons of coal you would probably be glad to have a written account of what you had bought, when you bought it, and whether you paid for it. You certainly would, if you were buying for some one else and had to give him an account of how you spent his money.

Sales slips, bills, statements, checks returned from the bank after being cashed, receipted bills, and receipts are written accounts that tell a buyer what he has bought, when he bought it, how much it cost, whether he has paid in full or in part, and how much he still has to pay.

1. Bring sales slips, bills, statements, checks returned from the bank after being cashed, receipts, and receipted bills to school and be ready to tell what the words and numbers on them mean, so far as you can find out.
2. Arthur goes to Pond's store for Mrs. Vail and buys some bananas, Uneeda biscuit, etc., and pays for them. He brings back this sales slip with the groceries. What does this sales slip tell Mrs. Vail?

<i>W. R. Vail</i>	<i>Dec. 2 1916</i>								
.....									
Bought of	B. AND C. R. POND GROCERIES AND PROVISIONS Tel. 214 74 Broadway								
<table style="width: 100%; border-collapse: collapse;"> <tr> <td style="border-right: 1px solid black; padding: 5px;"><i>1/2 doz. bananas 13, 2 Uneeda 10</i></td> <td style="padding: 5px; text-align: right;">23</td> </tr> <tr> <td style="border-right: 1px solid black; padding: 5px;"><i>3/4 cheese 21, 1/2 chocolate 19</i></td> <td style="padding: 5px; text-align: right;">40</td> </tr> <tr> <td style="border-right: 1px solid black; padding: 5px;"><i>2 bread 10, 1/2 salt pork 33</i></td> <td style="padding: 5px; text-align: right;">43</td> </tr> <tr> <td style="border-right: 1px solid black; padding: 5px;"></td> <td style="padding: 5px;"></td> </tr> </table>	<i>1/2 doz. bananas 13, 2 Uneeda 10</i>	23	<i>3/4 cheese 21, 1/2 chocolate 19</i>	40	<i>2 bread 10, 1/2 salt pork 33</i>	43			<i>Paid</i> <i>C. R. P.</i>
<i>1/2 doz. bananas 13, 2 Uneeda 10</i>	23								
<i>3/4 cheese 21, 1/2 chocolate 19</i>	40								
<i>2 bread 10, 1/2 salt pork 33</i>	43								

3. Make out sales slips for orders as given by pupils in the class, using prices set by other pupils.

C. N. Dorr 65 Locust St.		Portland, Me. Aug. 1, 1916	
To		DRAKE & CO.	
Tel. Main 68		Dr. 900 Main St.	
July	7	2 bathing suits 2.75	5 50
		8 1/2 b. serge .35	2 98
		2 pr. tennis 1.00	2
		10 48	
<p>PAID Aug. 4, 1916 DRAKE & Co. <i>E. R. D.</i></p>			

4. What does this bill tell Mrs. Dorr?
5. Act as bookkeeper for Drake & Co. and make out a receipted bill to Mrs. Venn, supposing that she buys on Nov. 20 of this year 6 chairs at \$5.75 each, a table at \$22.50, and 18 yd. carpet at 90¢ a yard, and pays for them all less 2% discount for cash.

Henry Orr, treasurer of the Dayton School Athletic Association, has printed some receipts like this:

Dayton, Ohio,..... 191....
Received of.....for subscription to Dayton School Athletic Association, 191....Treas.

6. How does he fill in the blanks in making out a receipt to Robert Tyler for 50 cents subscription for the year 1916, paid May 4, 1916?

Many of the large city stores send catalogues of the goods they have to sell and slips of paper arranged for customers to write their orders. If you can find some at home that your parents do not need, bring them to school. Examine the order slips. In writing mail orders:

1. Why is the exact copying of numbers important?
2. Why is an exact measurement of size important?
3. Why is correct multiplication important?
4. Why is correct addition important?

A mail order slip usually contains spaces like this:

Catalogue Number of the Article	Quantity Desired	Name of Article	Size	Price of Each or per Dozen		Extend Totals Here and Add	
37 D 8815	6 yd.	Syracuse Linoleum	7½ ft. wide	1	25	7	50

5. Find the “*extension*” or product for each of these:
 - a. 8 doz. at 98¢ per doz.
 - b. 4¾ yd. at 43¢.
 - c. 3 at \$2.45.
 - d. 1⅓ yd. at \$2.15.
 - e. 6 at \$2.85.
 - f. ⅞ yd. at \$1.95.
6. Copy as many of these as you can in 3 minutes without making a mistake. Look at each number long enough to remember it while you are writing it, so that you will not have to take a second look.

I.	II.	III.	IV.	V.	VI.
9240	6461	6958	58742	26390	61524
7316	5332	1734	94183	13280	46253
1258	9245	8323	35689	51046	73637
9408	4120	4927	52060	49157	90878
5637	5138	5210	17140	92647	14989
7549	7760	8915	72693	87385	52010
7. Find the sums for I, II, III, IV, V, and VI, using the copy you made. Check your result by laying a slip of paper under the columns in the book and adding with them.

42. Paying by Mail or Telegraph

1. Why is it not safe to send money in a letter?

You can pay a person by sending a Post Office money order or by sending an Express Company money order.

You obtain a Postal money order by giving the money to your Post Office. The person to whom you send the money order obtains the money by giving the money order to his Post Office.

You obtain an Express money order by giving the money to your Express Office. The person to whom you send the money order obtains the money by giving the money order to the Express Office where he is.

You pay a small amount to the Post Office or Express Company for transacting the business.

The rates for this extra payment for postal money orders are:

For an order of \$2.50 or less	3¢	For \$30.01 to \$40.00	15¢
For an order of \$2.51 to \$5.00	5¢	For \$40.01 to \$50.00	18¢
For an order of \$5.01 to \$10.00	8¢	For \$50.01 to \$60.00	20¢
For an order of \$10.01 to \$20.00	10¢	For \$60.01 to \$75.00	25¢
For an order of \$20.01 to \$30.00	12¢	For \$75.01 to \$100.00	30¢

2. What percent of the amount of the order do you pay the Post Office for its work — (a) When the order is for \$2.00? (b) When the order is for \$4.00? (c) When it is for \$10.00? (d) When it is for \$100.00?
3. How many times as much does it cost to send 10 separate orders for \$6 each as it costs to send one single order for \$60?
4. How many times as much does it cost to send 10 separate orders for \$3.50 each as it costs to send one order for \$35?

You can also pay a person by sending money through the telegraph company. You give the telegraph company the money and a small amount for transacting the business and sending the telegram. The person to whom you send the money obtains it from the telegraph company where he is.

5. What is the advantage of sending money by telegraph?

43. Paying by Check or Draft

45

You can also pay a person by sending a check, which is an order to a bank where you have money to pay a certain person a certain amount of money.



Chicago, Dec. 27 1916 No. 2165

Illinois Trust & Savings Bank
2-16

Pay to the order of Marian F. Howard \$ 13.25

Thirteen and $\frac{25}{100}$ Dollars

Edward Baldwin

Spokane Bank Note Co. Chicago

1. Who sends this check?
2. Who receives the money?
3. Tell how the person who receives the check obtains the money, if you know.
4. Every month Mr. Davis receives a check for \$75. What is his salary per year?
5. If a man's salary is \$1500 a year, what should be the amount on his monthly check for salary?
6. On Jan. 1, Apr. 1, July 1, and Oct. 1, Mr. Rocco sends a check for \$37.50 to his parents. How much does he send per year?

You can also pay a person at a distance by sending a draft, which you can get at a bank. You do not need to learn about sending money by drafts until you have a bank account of your own. Then you can find out anything you need to know about them from the men in the bank.*

* TO THE TEACHER.— If it is desirable to have the pupils understand the details of these business forms and arrangements, have them act as post office, express company, telegraph company, bankers, senders, and recipients. Make out the actual forms, and pay with play money, using one corner of the room as New York, one as Chicago, one as New Orleans, and one as San Francisco.

44. Buying: Discounts for Cash

(Without pencil.)

1. When you have bought things at stores you have perhaps always paid the money when you bought the article, but people often pay only a part "cash down" and the rest at a later date.

For example, Mary sold her old violin to Helen for \$8.00, 25% cash at the time of the sale, 30% to be paid in 30 days, and the rest to be paid in 60 days. (a) How much money did Helen pay at the time of sale? (b) How much should she pay 30 days later? (c) How much should she pay 60 days later?

2. When Frank moved away from Denver he offered his pony to Edward for \$80, to be paid in one month, or for 5% less than \$80 for cash at the time of sale. Edward's father offered to pay \$70 cash at time of sale. How much less was that than Frank's offer?

3. Mr. Fox, who runs a printing press, makes a reduction of 2% for cash on all orders. What do you really pay him on a \$5 order if you pay cash?

4. Joe wished to rent a piece of land from Mr. Gray. Mr. Gray asked \$4 at first, but reduced his price to \$3 when Joe agreed to pay in advance. What percent reduction was that from his first price?

5. How much does a customer really pay —

- (a) When the price is \$10.00 less 2% for cash?
- (b) When the price is \$15.00 less 1% for cash?
- (c) When the price is \$10.00 less $2\frac{1}{2}\%$ for cash?
- (d) When the price is \$8.00 less 3% for cash?

6. Mr. Ellis sells berry plants at 10¢ each, 80¢ a dozen, \$6.00 a hundred. (a) How much less does it cost for a dozen bought together than for a dozen bought one at a time? (b) What would a thousand plants cost at 20% discount from the price for ten separate orders of a hundred each?

7. Make up two problems about discount, one about discount for cash, and one about discount for buying a large quantity.

Some firms never sell goods at the prices printed in their catalogues but always give a discount from the list price. The catalogue price or list price less the discount states the net price, or what the customer really pays.

I. Tell what a customer really pays for each of these articles:

Catalogue Number	List Price	Rate of Discount	Customer Pays	Catalogue Number	List Price	Rate of Discount	Customer Pays
A W 22	\$60.00	33 $\frac{1}{3}$ %	D T 9	\$1.80	40%
A N 28	\$70.00	40 %	F C 14	\$2.00	35%
C B 2	\$ 8.00	40 %	F C 18	\$4.00	35%

II. Write what a customer really pays for each of these articles:

Catalogue Number	List Price	Rate of Discount	Catalogue Number	List Price	Rate of Discount
2461	\$38.00	45%	3142	\$146.00	$\frac{1}{4}$
2469	46.00	45%	3149	118.00	$\frac{1}{4}$
2811	3.60	45%	4260	17.00	35%

Sometimes firms give two discounts. For example, if they really charge \$25.50 for an article, they may make the catalogue price \$40.00 and give a discount of 25% of \$40.00, reducing the price to \$30.00, and a second discount of 15% of \$30.00, reducing the price to \$25.50.

III. What does a customer really pay for an article listed at \$60.00 if two discounts of 25% and 15% are made in this way?

IV. Supply the missing numbers as shown in the first line.

List Price	Discount		
"\$4.00, less $\frac{1}{5}$, 10%"		means "From \$4.00 take \$.80.	From \$3.20 take \$.32"
"\$3.00, less 20%, 5%"		means "From \$3.00 take	From \$2.40 take \$.12"
"\$4.00, less 25%, 5%"		means "From \$4.00 take	From \$3.00 take . ."
"\$6.00, less $\frac{1}{4}$, 10%"		means "From \$6.00 take	From \$4.50 take . ."
"\$6.00, less 15%, 10%"		means "From \$6.00 take	From \$5.10 take . ."
"\$6.00, less 30%, 5%"		means "From \$6.00 take	From \$4.20 take . ."

V. (a) At "\$8 less 30%, 5%," what does a customer really pay?
 (b) At "\$40 less 15%, 10%," what is the net price?

46. Practice in Computing Discounts

I. What does a customer really pay for each of these articles? Write your results neatly in a table like this:

Catalogue Number	Price after Discounts	Catalogue Number	Price after Discounts
C 47	R 13
D 11	R 16
M 12	S 19
Etc.		Etc.	

Catalogue Number	List Price	Discounts	Catalogue Number	List Price	Discounts
C 47	\$3.80	$\frac{1}{4}$ 10%	R 13	\$ 1.20	10% 5%
D 11	\$4.10	15% 5%	R 16	\$ 9.60	10% 5%
M 12	\$7.25	20% 10%	S 19	\$28.00	12% 5%
M 18	\$.90	20% 10%	S 28	\$16.00	12% 5%
N 19	\$4.05	40% 15%	V 4	\$ 3.40	$\frac{1}{5}$
N 23	\$3.20	40%	V 19	\$ 5.75	$\frac{2}{5}$ 5%

II. Mr. Roberts finds these prices for five articles that he wishes to buy for his house:

Article	In a Special Firm's Catalogue		In a Mail Order Catalogue	
	List Price	Discounts	List Price	Discounts
K 21	\$40	40% 15%	\$18.60	ALL PRICES
O 26	\$22	$\frac{1}{5}$ 10%	\$14.25	NET
P 9	\$60	40% 10%	\$29.90	CASH
P 41	\$14	$\frac{1}{4}$	\$ 9.75	IN ADVANCE
T 3B	\$ 8	40%	\$ 3.90	

He reckons that he will save \$7.54 on the whole order, by buying from the mail order house, and sends them the money.

He finds later that the special firm would have given him 2% discount for cash and would have paid the freight. The freight on the five articles cost him \$4.80. How much did he really save by buying from the mail order house?

III. Show that \$5 less 20%, 10% gives the same result as \$5 less 10%, 20%.

IV. Is there any difference between the results when you subtract discounts of 40%, 10% and when you subtract discounts of 10%, 40%?

V. How did you decide about the answer to Ex. IV?

1. The Locke family live in the city. They expect to earn at least \$1200 next year. They plan to use the \$1200 as follows:

Rent and Carfare	Food	Clothing	Operating Expenses	Higher Life (Books, Music, Church, etc.)	Savings and Insurance
16%	32%	18%	14%	10%	10%
or	or	or	or	or	or
\$192

Find the missing numbers in the line above.

2. If they earn any more than \$1200, they plan to use the extra amount or balance as follows: to put half of it in the savings bank, to use $\frac{1}{6}$ of it for furniture and books, and to use the rest for special vacation expenses. If they earn \$1420 next year, how much will they have for special vacation expenses?
3. Mrs. Locke finds that by planning meals for a week ahead she can reduce grocery and meat bills from \$5.65 per week to \$5.20. What per cent reduction does she make?
4. How much does she save per can by buying canned goods at \$1.15 per dozen, instead of one can at a time for 12¢?
5. How much more does an angel cake requiring 6 eggs cost when eggs are 45¢ per doz. than when they are 25¢ per doz.?
6. On May 10th oranges were 16 for 25¢ and strawberries were 28¢ per box. On June 10th the same sort of oranges were 30¢ a dozen and strawberries were two boxes for a quarter. How much is saved by buying 16 oranges on May 10th and 2 boxes of strawberries on June 10th, instead of buying the berries on May 10th and the oranges on June 10th?
7. How much less per pound does coffee at 25 lb. for \$4.60 cost than coffee at 28¢ per lb.?
8. Find out what you can about buying things cheaply without obtaining poor quality, and about reducing the cost of living or getting a better living at the same cost by using things economically. Be ready to tell the class anything useful that you know about wise buying and avoiding waste.

48. Selling: Profit and Loss

(Use pencil when you need to.)

When a man receives more for an article than he paid for it, the reason may be that he, as seller, saves the buyer some labor or trouble or expense.

1. Eggs were on sale at Cedar Farm for 28¢ a dozen and Mrs. Fox knew it. Dick Allen bought 3 dozen of these eggs at the farm and sold them to Mrs. Fox in the city for 32¢ a dozen. How much did he receive for saving Mrs. Allen the trouble of going to Cedar Farm for the eggs?
2. A whole codfish can be bought at the wharf in the early morning for 8¢ a pound. Tell some reasons why Mr. Rogers receives 14¢ a pound for codfish when he sells it at his fish store.

Sometimes a man receives more for an article than he paid for it because he uses specially good judgment in knowing what to buy and when to buy.

3. Mr. A. thought that a trolley line would be built to South Harbor and bought 100 acres of land along the road for \$6000. The line was begun and he sold the land after a year for \$13,000. How much more did he receive than he would have received by putting his \$6000 in the bank for a year at 4% interest?
4. Mr. B. thought a trolley line would be built to North Harbor and bought 100 acres of land along that road for \$9000. It was decided not to build the line there and he sold the land after a year for \$5000. How much less did he receive than he would have received if he had put his money in the bank for a year at 4% interest?

Men in business do not make profits simply by buying and selling. Unless they have intelligence or industry or politeness or all three, they are more liable to lose than gain.

5. A man kept a store. He paid \$1180 for rent, heat, light, telephone, etc., and hired two clerks to do the work at \$50 a month each. In a year he bought goods for \$7460 and

sold them for \$9270. (a) How much better off would he have been if he had done nothing instead of keeping the store? (b) How much better off would he have been if he had worked for somebody for \$75 a month?

The increase of what you receive over what you pay does not tell the whole story of how well you are doing in business. The time and labor you spend on the business must be taken account of also.

6. Frank bought a dog one day for \$2.50, and spent an hour a day for nine days trying to sell it. Food for the dog cost him 25 cents, and he spent 4 hours in cleaning and caring for the dog. He sold the dog for \$3.75. How much did he receive per hour for the time spent on the whole transaction?
7. Dick saw a dog for sale, bought it for \$2.50, and sold it to Mr. Jackson for 50% more than he paid for it. It was exactly two hours from the time he first saw the dog until he returned home with the money from Mr. Jackson. How much did he get per hour for the time spent on the transaction?
8. Did Dick make 8 times as much per hour as Frank?

49. Selling: Profit per Unit of Time Spent

(Use pencil only when you need to.)

How much money did each of these children make per hour of time spent?

1. Alice bought goods for \$1.50, and sold them for 33 $\frac{1}{3}$ % advance, spending ten hours in planning, and in buying, arranging, and selling them.
2. Alfred bought goods for \$2.00, and sold them for 20% advance, spending four hours in transacting the business.

	Cost of Goods	Increase of Selling Price Over Cost of Goods	Time Spent in the Business
3. Clara	\$3.00	20%	10 hr.
4. Dick	\$3.00	25%	5 hr.
5. Fred	\$3.00	20%	12 hr.

6. George bought goods for \$3.00, and sold them for 25% advance, spending 30¢ in fares and 9 hours of time.
7. Grace bought goods for \$3.00, and sold them for 25% advance, spending 30¢ in fares and 20¢ in sending letters, and 15 hours of time.

	Cost of Goods	Increase of Selling Price Over Cost of Goods	Expenses of Selling the Goods	Time Spent in the Business
8. Harriet	\$4.00	25%	\$.70	10 hr.
9. Henry	\$4.00	25%	\$.70	2 hr.
10. Louis	\$4.00	15%	\$.10	2 hr.

11. Nathan bought goods for \$4.00 and sold three fourths of them at $33\frac{1}{3}\%$ advance. The rest he could not sell and had to throw them away. He spent 10 hours in the business.

50. Selling: The Risk of Loss

(Solve these problems without using pencil if you can.)

1. Carl bought 6 dozen eggs from his grandfather for 25¢ per dozen. How much does he lose (besides his time spent)—
 - (a) If he drops the boxes and breaks all the eggs?
 - (b) If he sells $\frac{2}{3}$ of the eggs at 32¢ per dozen and then breaks all the rest?
 - (c) If he sells 2 doz. at 30¢, 2 doz. at 25¢, and receives only 20¢ a dozen for the rest?

2. Arthur bought 4 gal. ice cream for \$1.15 per gal. and cones for 40¢ to sell at the ball game.

What percent of the money invested in ice cream does he lose (besides the time spent) —

- (a) If he sells only 20 ice cream cones at 5¢ each and has to give away or throw away all the rest?
- (b) If he sells 20 cones at 5¢ each, 10 at 4¢ each, and 20 at 3¢ each and has to give away or throw away all the rest?
- (c) If it rains so that he cannot sell any, but he induces the man from whom he bought to take the goods back at 80% of their cost?

1. Mr. Venn keeps a store. He pays \$240 a year rent, \$2.50 a month for telephone, and an average of \$4.60 a month for heat, light, insurance on his goods, etc. He pays \$7 a week to Anna Brown, who helps him wait on customers, make out bills, etc. How much does it cost him per year to run the store and sell the goods?
2. If during the year he buys goods for \$4850 and sells them for \$6975.60, how much has he left for himself after paying all the expenses of selling the goods?
3. Mr. Venn does not reckon that way. He knows that he could earn \$100 a month by working in some one else's store. So he pays himself a salary of \$100 a month and calls that salary part of the cost of running the store or selling the \$6975.60 worth of goods. (a) Counting his salary in this way, what is the total cost of selling the goods? (b) How much does it cost him to sell \$100 worth of goods? (c) To sell one dollar's worth of goods? (d) How much does Mr. Venn receive for the year's work over and above the salary he pays himself?
4. If another man owned the store, paid all the expenses, including Mr. Venn's salary, and kept the balance as his income or gain from the business — (a) What percent would this \$236.40 income or gain be of the cost of the goods alone? (b) What percent would the \$236.40 be of the cost of the goods plus the cost of selling them?
5. A man who could earn \$2000 a year by working for a dry goods company keeps a store of his own instead. Last year he bought goods for \$11,510 and sold them for \$14,970. He paid \$1760 for the expenses of running the store, not counting in any salary for himself. How much less did he receive for his own services than he would have received if he had worked for some one else at a salary of \$2000 a year?

The price at which the seller sells an article is called the **selling price**.

The price at which the seller bought it plus what money he spends in order to sell it may be called the **total cost to the seller**.

1. What percent of the selling price were the expenses of selling in each of these transactions?

	Price Paid by the Seller for the Goods	Expenses Paid by the Seller in Order to Sell the Goods	Selling Price of the Goods
Transaction I.	\$1000	\$210	\$1400
Transaction II.	1000	490	1650
Transaction III.	1000	30	985
Transaction IV.	1000	324	1250
Transaction V.	1000	5	1035

2. What percent of the price at which the seller bought the goods was the selling price in each?
3. What percent of the total cost to the seller was the selling price in each?
4. In which case was the selling price less than the price at which the seller bought the goods?
5. In which cases was the selling price less than the total cost to the seller?

53. Selling on Commission

(Without pencil.)

1. Have you ever solicited subscriptions for a magazine, receiving so much per subscription, or sold tickets, receiving so much per ticket sold, or sold anything on a commission?
If you have, be ready to tell the class whom you sold the goods for, and how much commission you received.
2. Dora and Ruth pick berries. Henry sells the berries for them. They pay him 10% commission. Tell how much his commission amounts to on each of these days, and how much money is left for the girls:
 - a. July 2, Henry sells 12 qt. at 2 qt. for 25¢. He keeps . . . and gives the girls . . .

- b. July 3, Henry sells 20 qt. at 15¢ per qt. He keeps . . . and gives the girls . . .
- c. July 6, Henry sells 5 qt. at 15¢ per qt. and 10 qt. at 2 qt. for 25¢. He keeps . . . and gives the girls . . .

(With pencil.)

3. Fred drives a wagon into town every day and sells vegetables for his father and some of the neighbors. He receives 20% commission. How much money does he make for himself on each of these days, counting \$1.30 off per day for the expense of the horse and wagon?
- a. July 16, Fred sells \$12.50 worth of vegetables.
- b. July 17, Fred sells \$9.30 worth of vegetables.
- c. July 18, Fred sells \$10.40 worth of vegetables, and makes 20¢ by errands.

4. Mrs. Peters had her furniture sold at auction.

The parlor set was sold for	\$41.50
The dining-room set was sold for	27.25
One bedroom set was sold for	39.75
The other bedroom set was sold for	31.00
The kitchen furniture was sold for	17.45
The carpet and rugs were sold for	52.50

The auctioneer received 2% commission on the total amount of the sales. How much did Mrs. Peters pay him?

5. A farmer sends 30 crates of tomatoes to a commission merchant to be sold. The commission merchant sells 18 crates at \$1.20 per crate and the rest at \$1.15 per crate. He charges 7½% commission and pays a freight bill amounting to \$9.10 for the farmer. He makes out a check to the farmer for the balance of the money received for the tomatoes. For what amount should he make the check?
6. Helen tried to earn money last summer by selling special flat-irons on commission. The set of irons sold for \$2.50 and she received 40% commission. The first week she sold seven sets and spent \$4.05 for carfares; the second week she sold nine sets, but spent \$6.40 for carfares and a team. How much money did she make in the two weeks?

7. Last year Mr. Otis had \$1610 of bills owing to him. He gave the job of collecting them to a man at 8% commission. The man collected \$650.23 and left the job. Then Mr. Otis gave the job of collecting to an agency, at 15% commission. They collected \$805.00. The remaining bills Mr. Otis gave to his son Fred, telling Fred that he could have all that he could collect. Fred succeeded in collecting all but \$82.10, which never was collected.
- How much money did the first collector receive as commission?
 - How much money did the agency receive as commission?
 - How much money did Fred receive as commission?
 - How much money did Mr. Otis receive after paying the commissions?
 - What percent of the money never was collected?
8. Mary solicits subscriptions for two magazines. One costs \$1.50 a year, the other costs \$2.50 a year. She receives 25 cents on a dollar from the first magazine and 35 cents on a dollar from the second magazine. Last summer she secured 78 subscriptions to the first magazine and 23 to the second magazine. (a) How much did she make in all? (b) How much did she make per hour, if she spent 324 hours in all?
9. Fred's brother is a salesman. He receives \$60 a month and a commission as follows:
- 0 on the first \$200 sales he makes each month.
 - 10% on the second \$200 sales he makes each month.
 - 12½% on the third \$200 sales he makes each month.
 - 15% on all sales over \$600 per month.
- He pays his own expenses for carfare, etc.
How much money did he make in each of these months?
- | | Total Sales | Expenses |
|---------------|-------------|----------|
| a. Oct., 1915 | \$385.00 | \$4.80 |
| b. Nov., 1915 | 427.00 | 5.15 |
| c. Dec., 1915 | 490.00 | 6.30 |

(Write the answers. Do not write any other numbers unless you need to.)

A person may receive a commission for buying goods for somebody as well as for selling goods for somebody.

1. Mrs. Norris is a rich lady who has poor taste in buying clothes. So she hires a professional shopper to buy for her. She tells this lady what she needs and pays her 5% for buying it. How much does this professional shopper receive as commission for buying \$15 worth of goods?
2. When Mrs. Norris used to do her own shopping, she spent \$610 a year for clothes. Now she spends \$520 plus the commission. How much less does she spend per year now?
3. A graduate of the Washington School earns her living by planning meals and buying meats and groceries for ladies who do not like to do it themselves. From one family she receives \$8 a month and $\frac{1}{3}$ of every dollar less than \$80 per month that the family has to spend for food. How much does this family pay her for a month when their food costs them only \$62.00?

*Certain men who buy or sell on commission are called **brokers**; the commission they receive is called **brokerage**.*

4. What is the commission or brokerage on —

a. \$5000 at $1\frac{1}{2}\%$?	b. \$3000 at $\frac{3}{4}\%$?
c. \$10,000 at $\frac{1}{8}\%$?	d. \$24,000 at $\frac{1}{8}\%$?

Supply the missing numbers:

5. To receive \$10 at $\frac{1}{4}\%$ commission, a broker must receive the commission on
6. To receive \$10 at $\frac{1}{8}\%$ commission, a broker must receive the commission on
7. A broker who receives $\frac{1}{8}\%$ commission has expenses of \$40 per week. To pay the expenses he must receive commission on
8. \$5 is the commission on at 1%.
9. \$5 is the commission on at 5%.
10. \$5 is the commission on at $\frac{1}{8}\%$.

State the missing numbers:

1. Last year Kate saved \$22. This year she hopes to save 50% more than that or
2. Each year Ralph puts 60% of what he earns in the savings bank. If he earns \$20 he puts . . . in the bank. If he earns \$70 he puts . . . in the bank.
3. Ralph's grandfather, Mr. Evans, saved money when he was young. Now he has \$3000 in the Decatur Savings Bank. Every six months the bank pays him 2% of \$3000 as interest. How much does he receive each year as interest from this bank?
4. He has \$2000 in another bank, the Seaman's Savings Bank. Every year this bank pays him $3\frac{1}{2}\%$ interest. How much does he receive each year as interest from this bank?
5. He owns a building that he rents to Fox & Co. They pay him \$1600 a year for rent. He has to pay \$675 a year for the expenses of owning and repairing the building and \$25 for insurance. How much does he have left for himself from the rent of the building?

(With pencil.)

Write the missing numbers:

6. The first year that he went to work, Will saved \$30. He put it in the Empire Savings Bank Jan. 1, 1910. The bank pays $3\frac{1}{2}\%$ interest on money that is left with it for a year. So on Jan. 1, 1911, instead of \$30 Will had He also had saved \$45 during the year. He put this in the bank Jan 1, 1911, making in all.
7. From Jan. 1, 1911, to Jan. 1, 1912, he saved \$65 and put it in the bank; the year's interest on \$76.05 at $3\frac{1}{2}\%$ amounted to (use $.035 \times \$76$. The bank does not pay interest on the 5 cents). On Jan. 1, 1912, Will had in all. The next year he was sick over a month and could not save anything, but he increased his property by 4% of \$143 or (the bank paid him 4% interest that year).

56. How Money Increases When Interest is Added to It 59

1. Some one gave Will a card like this showing how money increases if it is left in the savings bank to draw interest, and the interest is left to draw more interest.

Table I

At 4%, interest being added annually: \$100 left one year becomes \$104 The \$104 in the second year becomes \$108.16 The \$108.16 in the third year becomes \$112.48 The \$112.48 in the fourth year becomes \$116.98 The \$116.98 in the fifth year becomes \$121.66 The \$121.66 in the sixth year becomes \$126.53 The in the seventh year becomes The in the eighth year becomes

Find the numbers to complete the table through the seventh and eighth years.

2. Will showed this table to the man at the savings bank and asked him if it was correct. The man said, "The arithmetic of it is correct, but we reckon our interest differently. In your table, interest is compounded annually. We compound it every six months or semiannually. Your table is made by multiplying the number of dollars and cents by .04. We reckon interest on only the number of dollars. Our table would be like this":

Table II

At 4%, interest being added semiannually:

1st year	{	\$100 left 6 mo. becomes \$102 (the interest being $.02 \times \$100$) \$102 in 6 mo. becomes \$104.04 (the interest being $.02 \times \$102$)
2d year	{	\$104.04 in 6 mo. becomes \$106.12 (the interest being $.02 \times \$104$) \$106.12 in 6 mo. becomes \$108.24 (the interest being $.02 \times \$106$)
3d year	{	\$108.24 in 6 mo. becomes \$110.40 (the interest being $.02 \times \$108$) in 6 mo. becomes

- (a) Complete this table up to the end of the fifth year.
 (b) Make a table like it for \$100 at 3%, interest being added semiannually. Make this table for 3 years only.

3. When money is left in the bank to draw interest and the interest is added to it and left to draw the interest also, the money is said to draw **compound interest** or the interest is said to be **compounded**. When the interest money for a year is added every year as in Table I, interest is said to be **compounded annually**. When the interest money for 6 months is added every 6 months as in Table II, interest is said to be **compounded semiannually**. Which is more, the interest on \$50 for two years at 4% per year compounded annually or the interest on \$50 for two years at 4% compounded semiannually? How much more?
4. How much will \$20 amount to in three years if left to draw interest in the bank at 4% compounded semiannually?
5. How much will \$75 amount to in three years if left to draw interest in a bank that pays 3% compounded semiannually?

57. The Safest Place to Put Money

In most states a savings bank is a very safe place to leave your money, but the Postal Savings Bank is still safer. The government of the United States guarantees that any money you put in will be paid back to you, and that if you leave it in for a year beginning the first day of the month following the date when you put the money in, you will receive 2 percent interest also.

1. How much interest is paid by the Postal Savings Bank for 1 yr. on each of these deposits:

\$10 \$20 \$50 \$200 \$300

2. Helen had \$25 in the Postal Savings Bank. A woman whom she knew offered to pay 7% interest if Helen would withdraw the money from the Postal Savings Bank and lend it to her. How much more money than the Postal Bank pays did the woman offer to pay as interest?
3. Helen refused her offer. What do you suppose was the reason? What should you know about a person to whom you lend money?

1. Dick studied in evening school at the Y. M. C. A. and learned how to run an automobile. He worked in a garage for 6 months at \$5 a week, 6 months at \$7 a week, 6 mo. at \$8 a week, and 6 mo. at \$9 a week. He saved one third of all that he earned. How much did he save?
2. He borrows enough more money to spend \$75 for a garage, \$375 for a second-hand automobile, and \$10 on robes, tools, etc. (a) How much does he borrow? (b) At 6% interest per year, how much interest must he pay each year until he pays back what he has borrowed?
3. He plans that the first year he will pay \$27.50 for insurance on the garage and auto, \$100.00 toward a savings fund for a new auto when this one wears out, and \$112.00 for interest and for paying back part of what he borrowed. How much will he have left if he does this, supposing that he receives \$920.00 from fares and spends \$115.00 for gasoline, oil, supplies, and repairs?

Dick's rates for passengers are:

	1 Mile or Less	Extra for Each $\frac{1}{4}$ of a Mile over 1 Mi.
For 1 passenger	30¢	5¢
For 2 passengers	40¢	6¢
For 3 or 4 passengers	50¢	7½¢

4. How much does he charge for a trip for 2 passengers when his speedometer reads 110.2 mi. when they get in and 113.7 mi. when they get out?
5. How much does he charge a trip for 3 passengers when his speedometer reads 116.3 mi. when they get in and 118.0 mi. when they get out? (.6 mi. or .7 mi. is counted as $\frac{3}{4}$ mi.)
6. How much does he charge for a trip for four passengers when his speedometer reads 149.4 mi. when they get in and 151.9 mi. when they get out?
7. For a trip of 12 miles with a single passenger Dick received his regular rate less 30%. How much did the passenger pay him for this trip?

59. Borrowing Money to Go into Business

(Use pencil only when you need to.)

1. John wishes to start in business for himself. He has saved \$350. (a) How much must he borrow to pay \$750 for the stock and fixtures of a store? (b) How much must he pay a year for the use of the money at 6%?
2. He borrows \$200 more from his father to buy new stock. He pays it back in 3 months with interest at 4% per year. (a) How much money does he give his father in all then? (b) How many dollars of it are payment for interest on the loan?

The principal of a loan is the number of dollars borrowed.

The rate of interest per year is the percent of the principal that is paid for using it for one year.

When the word "rate" is used alone it means rate per year.

3. What is the interest on \$200 for $\frac{1}{2}$ year at the rate of 6%?
4. What is the interest on \$200 for $\frac{1}{2}$ year at the rate of 5%?
5. What is the interest on \$200 for 3 mo. at the rate of 6%?
6. What is the interest on \$500 for 3 mo. at the rate of 4%?
7. What is the interest on \$500 for 3 mo. at the rate of 6%?
8. What is the interest on \$500 for 1 year at the rate of 4%?
9. What is the interest on \$500 for 1 year at the rate of 5%?
10. What is the interest on \$1000 for 1 year at the rate of $4\frac{1}{2}$ %?

"Interest at 4%" means "interest at the rate of 4% per year."

"Interest at 5%" means "interest at the rate of 5% per year."

"Interest at 6%" means "interest at the rate of 6% per year."

Supply the missing numbers:

11. Interest at 6% on \$300 for 6 mo. = ... For 2 mo. it would be ...
12. Interest at 4% on \$300 for 6 mo. = ... For 3 mo. it would be ...
13. Interest at 5% on \$800 for 6 mo. = ... For 2 yr. it would be ...
14. Interest at $4\frac{1}{2}$ % on \$1000 for 1 yr. = ... For 6 mo. it would be ...

(Use pencil when you need to.)

1. Mr. John Baker needs \$500 to pay cash for a large order of fireworks, which he will sell within a month. If he takes \$500 out of the savings bank, he loses the interest on \$500 for six months at $3\frac{1}{2}\%$. If he borrows \$500 for 1 month at 6% (a) How much interest does he have to pay? (b) How much less is this than the interest he would lose by taking his money from the savings bank?
2. If he buys the fireworks on credit and does not pay for them until he himself has sold them, they will cost him \$10 more than the cost if he pays cash. How much does he save by borrowing money for a month and paying cash?

He decides to borrow from his brother. His brother gives him \$500. He gives his brother a "Note" for \$500 due in 30 days with interest at 6% .

St. Paul, Minn., <u>June 6</u> 19 <u>16</u>
<u>Thirty days</u> after date, for value received, I promise
to pay to <u>Henry F. Baker</u> or order,
<u>five hundred</u> dollars
<u>with interest at 6%</u>
at the First National Bank, Minneapolis, Minn.
<u>John T. Baker</u>

3. Why do you suppose this is called a *promissory* note?
4. Why do you suppose this is said to be a *time* note?

To save trouble, banks count 30 da., 60 da., and 90 da. as $\frac{1}{12}$ yr., $\frac{2}{12}$ yr., and $\frac{3}{12}$ yr. in computing interest on notes.

Unless your bank tells you differently, you will count 30 days as $\frac{1}{12}$ yr., 60 days as $\frac{1}{6}$ year, and 90 days as $\frac{1}{4}$ year.

5. How much is the interest on \$100 for 30 days (a) At $5\frac{1}{2}\%$?
 (b) At 6% ? (c) At $4\frac{1}{2}\%$? (d) At 8% ?

You may think: “.055 $\times \frac{1}{12} \times 100$ ” and cancel.

Or you may think: “.055 $\times 100 = \$5.50$ $12 \overline{) \$5.50}$.”

6. How much is the interest on \$500 for 60 days (a) At 5% ?
 (b) At 6% ? (c) At $4\frac{1}{2}\%$? (d) At $5\frac{1}{2}\%$?
 7. How much is the interest on \$225 for 90 days at 5% ?
 8. How much is the interest on \$160 for 60 days at $4\frac{1}{2}\%$?
 9. How much is the interest on \$325 for 30 days at 6% ?

Years ago, when people could not send money quickly, by mail or telegraph, it was the custom to give *3 days of grace*. That is, the maker of a 30-day note did not have to pay it until 33 days had passed. The maker of a 60-day note did not have to pay it until after 63 days, etc. Interest was charged on the days of grace. In some states this is still allowed. If it is done in your state, your teacher will give you practice in finding interest for 33, 63, and 93 days.

61. Borrowing Money for a Long Time

1. Mr. Knox bought a house and lot for \$4200. He paid \$1200 cash and arranged to pay the rest in 5 years with interest at $5\frac{1}{2}\%$ payable annually. How much must he pay as interest each year?
2. Mr. Foster bought a house and lot for \$6500. He paid \$2500 cash and arranged to pay the rest in 3 years with interest at 5% , payable semiannually. How much must he pay as interest every six months?

Usually when people borrow money for a long time, they pay the interest every year or oftener, but sometimes for special reasons they do not.

3. Alice Lent wishes to go to college and be a teacher. Her uncle, Mr. Roberts, says, “I will loan you \$1500 for 10 years at 4% . Then you will know that you have money enough to see you through. You are to pay me the interest

for the first six years, six years from now; after that you will pay me interest every year." How much must Alice pay as interest six years from now?

4. At the end of 6 years, what Alice does is to pay Mr. Roberts the interest due him for six years' use of his money, and also \$300 of the \$1500. How much interest shall she pay the next year on the money she still owes?
5. Each year after that, she pays the interest that she owes Mr. Roberts and \$300 of the original loan or *principal*. Fill out this account to show what she owes each year.

ACCOUNT OF INDEBTEDNESS OF ALICE LENT TO C. F. ROBERTS

	For Principal of Loan	For Interest
Due at the end of 7th year	\$1200.00	\$48.00
Paid at the end of 7th year	300.00	48.00
Due at the end of 8th year
Paid at the end of 8th year
Due at the end of 9th year
Paid at the end of 9th year
Due at the end of 10th year
Paid at the end of 10th year

62. The Number of Days between Two Dates

Remember that April, June, Sept., and Nov. have 30 days, February has 28 days except in 1912, 1916, 1920, etc.

(Write all answers. Write any other numbers you need to write to find the answers. Jan. 5 to Jan. 25 counts as 20 days. July 10 to Aug. 10 counts as 31 days. July 10 to Aug. 24 counts as 45 days.)

1. Mr. A. borrowed \$1000 on Jan. 1, 1915, and paid it back Aug. 8, 1915. How many days did he have it?
2. Find how many days each of these men had the money that they borrowed:
 - Mr. B. borrowed on Sept. 1, 1914, and paid on Jan. 20, 1915.
 - Mr. C. borrowed on Jan. 10, 1916, and paid on Aug. 25, 1916.
 - Mr. D. borrowed on Mar. 9, 1916, and paid on July 14, 1917.
 - Mr. E. borrowed on Oct. 8 and pays on Jan. 6 of the next year.
 - Mr. F. borrowed on Apr. 12 and pays on June 3 of the same year.

A business man who has to find the number of days between two dates procures or makes a table like this:

Jan.	Day of Year	Feb.	Day of Year	Mar.	Day of Year	Apr.	Day of Year
1	= 1	1	= 32	1	= 60	1	= 91
2	= 2	2	= 33	2	= 61	2	= 92
3	= 3	3	= 34	3	= 62	3	= 93
4	= 4	4	= 35	4	= 63	4	= 94
Etc.							

3. Is this table for a regular year or a leap year?
4. What day of the year will May 1 be in this table?
5. What day of the year will June 1 be in this table?
6. Answer the same question for July 1, Aug. 1, Sept. 1, Oct. 1, Nov. 1, Dec. 1, Dec. 6, Dec. 15, Dec. 31.
7. Using the piece of the table printed above, tell how many days there are (a) From Jan. 2, 1917, to Mar. 3, 1917. (b) From Jan. 4, 1918, to Apr. 1, 1918. (c) From Feb. 2, 1919, to Apr. 4, 1919. (d) From Feb. 3, 1911, to Apr. 4, 1911.

To find the number of days between a date in one year and a date in the next year a business man uses a table that starts with 1 for Jan. 1 of the first year and goes to 730 for Dec. 31 of the next year. A part of such a table when both years are regular years is shown here.

8. Use it to find the number of days from —

	Nov.	Dec.	Day of Month	Jan.	Feb.	Mar.
a. Nov. 9, 1909, to Jan. 3, 1910.						
b. Nov. 9, 1913, to Feb. 8, 1914.						
c. Nov. 6, 1917, to Mar. 1, 1918.	305	335	1	366	397	425
d. Nov. 6, 1919, to Mar. 1, 1920. (1920 is a leap year.)	306	336	2	367	398	426
	307	337	3	368	399	427
	308	338	4	369	400	428
e. Dec. 10, 1923, to Feb. 6, 1924.	309	339	5	370	401	429
f. Dec. 8, 1917, to Mar. 4, 1918.	310	340	6	371	402	430
	311	341	7	372	403	431
g. Nov. 3, 1919, to Mar. 4, 1920.	312	342	8	373	404	432
	313	343	9	374	405	433
h. Dec. 5, 1918, to Jan. 9, 1919.	314	344	10	375	406	434

9. The interest on \$100 for 60 days at 6% is \$1.00. How much is the interest on the same amount at the same rate for 15 days? 10. For 30 days? 11. For 45 days?

To find the interest on a sum of money borrowed for 17 days, or 46 days, or 28 days, or any other number of days, the business man procures or makes tables somewhat like the table below at the right.

1. Examine the interest table below. Tell what the numbers should be in the table for 9 months. For 3 years. For 4 years. For 90 days or 3 months. For 6 mo. or $\frac{1}{2}$ yr.
2. Read the last two lines of the table as it would be for \$400 instead of \$100. Read them as the table would be for \$25.
3. What would a line for 18 days be? (Use $1\frac{18}{360} \times \$3$, $1\frac{18}{360} \times \$4$, etc., since a year is counted as 360 days.)
4. What would a line for 36 days be?

5. Use this table to find the interest —

	Days	INTEREST ON \$100			
		At 3%	At 4%	At 5%	At 6%
(a) On \$200 for 90 days at 6%	1	.008	.011	.014	.017
(b) On \$300 for 60 days at 4%	2	.017	.022	.028	.033
(c) On \$500 for a year and six months at 5%	3	.025	.033	.042	.05
(d) On \$100 for 60 days at $4\frac{1}{2}\%$	4	.033	.044	.055	.067
(e) On \$100 for 6 months at $5\frac{1}{2}\%$	5	.042	.056	.069	.083
(f) On \$1000 for 7 days at 5%	Etc.				
(g) On \$800 for $1\frac{1}{2}$ yr. at 4%	30	.25	.33	.42	.50
(h) On \$50 for 3 yr. at $5\frac{1}{2}\%$	60	.50	.67	.83	1.00
(i) On \$100 for 2 yr. 4 mo. 7 days at 6%	90

Months	At 3%	At 4%	At 5%	At 6%
4	1.00	1.33	1.67	2.00
5	1.25	1.67	2.08	2.50
6
7

Years	At 3%	At 4%	At 5%	At 6%
1	3.00	4.00	5.00	6.00
2	6.00	8.00	10.00	12.00
3
4
Etc.				

6. Make up four easy questions and four hard questions for the class to answer with the help of this table. Write out the answers to the hard questions and be ready to explain how to obtain them by using the table.

64. Buying on the Installment Plan

I. Grace Edwards wishes to buy a piano. She has \$50 saved and can save a little over \$20 each month. Estimate which of these offers is the best, supposing that the pianos are equally good and that she can borrow money of her father at 6%, paying him what she can every 6 months if she accepts offer C. Then find out what each offer really means and compare them, finding which is best and which is worst.

A.

A Reliable Piano. The Famous D. C. K. Upright. You pay \$50 cash down and \$21 a month for only a year and a half. *No interest* to pay. We ask you to pay only for the piano and allow you plenty of time.

B.

We offer the well-known D. C. K. Piano for \$390. \$50 cash and \$20 a month thereafter. Regular interest at 6%. The interest soon is reduced to less than \$1 a month.

C.

The D. C. K. Piano. Special Offer, \$375, cash. Compare our prices with those of any reliable firm.

The comparison will be clearest if you arrange your results for offers A, B, and C neatly in this form:

WHAT GRACE MUST PAY ACCORDING TO

	Offer A	Offer B	Offer C
At date of purchase	\$50	\$50	\$50
1 mo. later	21	20 + 1.70	(paid to her
2	21	20 + 1.60	father)
3 +	
4 +	
5 +	
6 +	\$125 + 9.75
7 +	(paid to her
8 +	father)
9 +	
10 +	
11 +	
12 + +
13 +	
14 +	
15 +	
16 +	
17 +	
18 + +
Total cost	By Offer A	By Offer B	By Offer C

II. Write a clear and exact statement to show how much Alfred will save by accepting Mr. Jones' offer instead of Mr. Sharp's, supposing the two boats to be equally good.

Mr. Jones says: "You may have this boat for \$110, paying me \$30 now and \$20 every 3 months with interest at 5%, if your father will guarantee that you pay."

Mr. Sharp says: "You need not say anything to your father about it. You pay me \$30 now and \$1.75 a week for a year and I won't charge you a cent for interest."

III. Mr. Ames buys a house and lot for \$4500, paying \$500 cash and the remainder in monthly payments of \$50 with interest at 5%. (a) How much must he pay at the end of the first month? (b) At the end of the second month? (c) At the end of the third month? (d) How much does his monthly payment for interest alone decrease each month? (e) How much will he still owe on the house at the end of a year? (f) When will he have the home entirely paid for, if he keeps up his payments regularly?

65. Review

I. Think of what you know about each of these and be ready to tell about them or write about them:

- a. Inventories and appraisals of property.
- b. Insurance against loss of property.
- c. The expenses of carrying on business.
- d. Taking risks in business.
- e. Gaining money in business by selling for yourself at an advance.
- f. Selling for other people at a salary.
- g. Selling for other people on commission.
- h. Selling for other people at a salary plus a commission.
- i. Discounts to the buyer for cash.
- j. Trade discounts from list prices.
- k. Paying by mail order, express order, or telegraph.
- l. Increasing your money by leaving it in a savings bank.
- m. Borrowing money to go into business.

II. Make up four problems such as a boy or girl going into business might have to solve in order to know how he was getting along. Make the first an easy one to solve, make the second a little harder, make the third hard, and make the fourth very hard. Bring them to class and be ready to put them on the blackboard for the class to solve.

Practice with problems 1–29, following, so that you will do well with the problems that the other pupils make up. Write the answers and any computations that you cannot do in your head.

1. Henry sells vegetables. One day his first customers all bought corn and none of them bought beans. So he raised the price of the corn 10 percent and lowered the price of the beans 10 percent. The first prices were 20¢ per dozen for corn and 30¢ per pk. for beans. What were his prices after the advance and discount?
2. Another day he began selling corn at 15¢ a dozen. After selling 3 dozen ears he advanced the price $33\frac{1}{3}\%$. After selling 6 dozen ears at the new price he reduced the price to 18¢ per dozen and sold 11 dozen. How much did he receive in all for corn that day?
3. Louis receives \$12 per week. He plans to spend 55% of it for room, board, and laundry, and to save 25% of it. How much money does he have left for clothes, books, church, amusements, etc.?
4. The expenses for maintaining and operating Mr. Daly's store in 1915 were \$2140. He plans to reduce them by 15%. How much will they be if he does so?
5. How much do you save by buying a book listed at \$1.50 through a friend who can get you 20% discount, instead of buying it at your local book store for \$1.35? Take account of the fact that you have to pay 2¢ for a stamp and 3¢ for a money order to the friend.
6. How much does a dealer pay for a dozen locks listed at \$4.80 less 25%, 10%?

7. A plumber and his helper leave the shop at 8:20 A.M. to repair a faucet and pipe. They return at 11:15 A.M. Make out a bill for the job, counting 60¢ an hour for the time the plumber is gone from the shop, half as much for his helper, and 85¢ for materials used. Make the date to-day. Use any names you choose.
8. A girl earns \$8 a week. She pays \$3.25 per week for room, board, and laundry, and puts \$5 in the postal savings bank every month. How much has she left to spend for clothes, amusements, etc., during the year?
9. The employees of the A. T. and S. Railroad received a raise of 8% in wages. What is the new wage (a) For a man who received \$2.50 per day before? (b) For a man who received \$3.25 before? (c) For a man who received \$3.50 before?
10. How much will an agent receive if he collects 85% of a lot of old debts amounting to \$640, at 5% commission?
11. Which is the larger discount, a single discount of $33\frac{1}{3}\%$ or 30%, 5%?
12. How large a single discount equals a discount of 25%, 20%?
13. A boy's pay is raised from \$6 per week to \$7.50. By what fraction is it increased? By what percent is it increased?
14. How much does each of these girls save per week?
 Ellen earns \$6 per week and saves $12\frac{1}{2}\%$ of it.
 Grace earns \$7 per week and saves 15% of it.
 Helen earns \$7.50 per week and saves 20% of it.
 Laura earns \$9.00 per week and saves 25% of it.
15. How much interest does each of these persons have to pay every 6 months?
 Mr. A., who borrows \$400 at 5%, interest to be paid semi-annually.
 Mr. B., who borrows \$300 at 5%, interest to be paid semi-annually.
 Mr. C., who borrows \$1000 at $4\frac{1}{2}\%$, interest to be paid semi-annually.

16. What percent of his yearly income does each of these boys put in the bank?

Fred, whose yearly income is \$312, puts \$62 in the bank.

George, whose yearly income is \$442, puts \$75 in the bank.

Henry, whose yearly income is \$260, puts \$60 in the bank.

Thomas, whose yearly income is \$480, puts \$80 in the bank.

17. Alice's father makes it a rule to put \$50 of his earnings in the bank every year and also to put in 10% of anything he earns between \$1000 and \$1250 and 30% of anything he earns over \$1250. If he follows this rule—

a. How much does he put in the bank in a year when he earns \$1150?

b. How much does he put in the bank in a year when he earns \$1425?

c. How much does he put in the bank in a year when he earns \$1540?

18. At \$.16 per \$100, what does it cost to insure a house for \$5000?

19. What percent of the money that he invests does each of these persons gain per year?

Mr. A. invests \$5000 and receives \$5356 a year later.

Mr. B. invests \$9000 and receives \$9500 a year later.

Mr. C. invests \$13,000 and receives \$13,125 a year later.

Mr. D. invests \$2000 and receives \$2080.80 a year later.

20. How many dollars does each of these persons receive for the time and trouble and risk that he takes in investing his money so as to increase it?

Mr. E. invests his \$5000 in a piece of land which he sells after a year for \$6000. He pays \$240 for taxes, advertisements, etc.

Mr. F. invests his \$5000 by buying a $\frac{1}{10}$ share of a ship. At the end of a year he receives \$520 from the ship's earnings during the year and sells his share of the ship for \$5250.

Mr. G. leaves his \$5000 for a year in savings banks at 4% interest compounded semiannually.

Mr. H. invests his \$5000 in a mine, which he sells at the end of a year for \$5200. He pays \$180 for taxes and other expenses of the investment.

21. List price is \$3.50; discount is 15%; what is the net price?
22. How much do you save per pound by buying flour at \$6.75 per barrel instead of at 15 lb. for 50¢?
23. If you have \$50 in the savings bank, and interest at 4% per year is added to it every 6 mo., how much money will you have in the bank in a year and a half?
24. Dick made 30 toy boats. He sold 14 of them at 25¢ each, 8 at 20¢, and the rest at \$1.15 for the lot. How much did he receive in all?
25. The materials for the boats cost him \$1.30; he spent 32 hours in making them and 15 hours in selling them. How much did he receive per hour? (Find the result to the nearest thousandth of a dollar or tenth of a cent).
26. How much money must you have in a bank at 4% interest to receive \$100 each year as interest?
27. Arthur, Henry, and Louis each borrowed \$600 to go into business. Arthur pays the bank \$18 every six months. Henry pays his uncle \$7.50 every three months. Louis pays his father \$2 each month. Which one pays at the rate of 4%? Which one pays 5%? Which one pays 6%?
28. What is the rate of interest when a bank pays you \$7 interest every six months on a deposit of \$400?
29. If you leave \$500 in a savings bank to draw interest at 3½%, the interest being added to the principal every six months, how much should the bank pay you after a year and a half?

III. Make up easy problems using each of these expressions correctly. You may use two or more of the expressions in one problem if you wish.

interest compounded annually
interest compounded semiannually
discount from list price
face of an insurance policy

net price
premium (in the case of insurance)
rate of interest
rate of insurance

66. Household Management

(Write all results. Do as much of the computation mentally as you can.)

Some foods are more nourishing than others.

- 1 lb. sugar contains 1 lb. of real nourishment
- 1 lb. potatoes contains 0.1 lb. real nourishment
- 1 lb. pickles contains 0.02 lb. real nourishment
- 1 lb. tapioca contains .95 lb. real nourishment

1. How many times as much nourishment is there in a pound of sugar as in a pound of pickles?
2. How many times as much nourishment is there in a pound of tapioca as in a pound of potatoes?
3. How many pounds of real nourishment will you obtain for a dollar (a) If you buy 18 lb. sugar for \$1.00? (b) If you buy 7 lb. tapioca for \$1.00? (c) If you buy 5 jars of pickles containing $10\frac{1}{2}$ lb. for \$1.00? (d) If you buy 60 lb. potatoes for 75¢?
4. Copy. Use your results in Ex. 3 to help you to supply the missing numbers.
 - a. \$1.00 buys . . . lb. of real nourishment, if you buy sugar.
 - b. \$1.00 buys . . . lb. of real nourishment, if you buy tapioca.
 - c. \$1.00 buys . . . lb. of real nourishment, if you buy potatoes.
 - d. \$1.00 buys . . . lb. of real nourishment, if you buy pickles.
5. How many times as much real nourishment do you obtain for a dollar spent on potatoes as for a dollar spent on pickles?
6. The high-school class in cookery found that 3 lb. cheese contained 1.8 lb. of real nourishment and cost 72¢.
3 lb. sirloin steak contained .99 lb. of real nourishment and cost 84¢.

Using these facts, supply the missing numbers:

- a. 1 lb. cheese costs . . . and contains . . . lb. of real nourishment.
- b. For \$1.00 you obtain . . . lb. cheese and so obtain . . . lb. of real nourishment.
- c. 1 lb. steak costs . . . and contains . . . lb. of real nourishment.
- d. For \$1.00 you obtain . . . lb. steak and so obtain . . . lb. of real nourishment.

Mrs. Lewis has made this scale of food credits.

1 means "very poor"; 2 means "poor"; 3 means "fair"; 4 means "good"; 5 means "very good."

	N	H	T	E
	Credit for Nourishment or Food Value per Dollar Spent	Credit for Health- fulness	Credit for Taste and Value in Making the Rest of the Meal Attractive	Credit for Ease of Prep- aration
Apples	3	5	4	5
Bacon	3½	3	4½	4
Bananas	4	4	5	5
Beans	5	3	2	3
Beef	3½	3	4	3
Bread	5	4½	3	3
Butter	2	3	5	5
Celery	1	4	5	4
Cheese	4	3	4	5
Cocoa	3	4	5	3½
Coffee	0	1	5	3

She finds the total credit by taking (3 times the number in the N column) + (2 times the number in the H column) + (the numbers in the T and E columns). That is, she counts nourishment as 3 times as important as taste or ease of preparation, and healthfulness as twice as important.

1. Copy the list of foods and write after each food the total credit that she gives to it. Use your results for Ex. 1 in solving 2, 3, 4, etc.
2. How many times as much total credit does she give to *bread* as to *coffee*?
3. How many times as much total credit does she give to *bananas* as to *celery*?
4. How many times as much total credit does she give to *bacon* as to *coffee*?
5. Which food has $1\frac{1}{5}$ times as much total credit as *celery*?
6. Which food has $1\frac{1}{4}$ times as much total credit as *celery*?
7. Which food has $\frac{5}{6}$ as much total credit as *bread*?
8. Which food has $\frac{1}{3}$ as much total credit as *bread*?

68. Using Recipes to Make Larger or Smaller Quantities

I. State how much you would use of each material in the following recipes: (a) To make double the quantity. (b) To make half the quantity. (c) To make $1\frac{1}{2}$ times the quantity. You may use pencil and paper when you cannot find the right amount mentally.

1. PEANUT PENUCHE

1 tablespoon butter
2 cups brown sugar
 $\frac{1}{3}$ cup milk or cream
 $\frac{3}{4}$ cup chopped peanuts
 $\frac{1}{3}$ teaspoon salt

2. MOLASSES CANDY

$\frac{1}{2}$ cup butter
2 cups sugar
1 cup molasses
 $1\frac{1}{2}$ cups boiling water

3. RAISIN OPERA CARAMELS

2 cups light brown sugar
 $\frac{7}{8}$ cup thin cream
 $\frac{1}{2}$ cup raisins

4. WALNUT MOLASSES SQUARES

2 tablespoons butter
1 cup molasses
 $\frac{1}{3}$ cup sugar
 $\frac{1}{2}$ cup walnut meats

5. RECEPTION ROLLS

1 cup scalded milk
 $1\frac{1}{2}$ tablespoons sugar
1 teaspoon salt
 $\frac{1}{4}$ cup lard
1 yeast cake
 $\frac{1}{4}$ cup lukewarm water
white of 1 egg
 $3\frac{1}{2}$ cups flour

6. GRAHAM RAISED LOAF

2 cups milk
6 tablespoons molasses
 $1\frac{1}{2}$ teaspoons salt
 $\frac{1}{3}$ yeast cake
 $\frac{1}{4}$ cup luke warm water
2 cups sifted Graham flour
 $\frac{1}{2}$ cup Graham bran
 $\frac{3}{4}$ cup flour (to knead)

II. How much would you use of each material in the following recipes: (a) To make $\frac{2}{3}$ as large a quantity? (b) To make $1\frac{1}{3}$ times as much? (c) To make $2\frac{1}{2}$ times as much?

7. ENGLISH DUMPLINGS

$\frac{1}{2}$ pound beef suet
 $1\frac{1}{4}$ cups flour
3 teaspoons baking powder
1 teaspoon salt
 $\frac{1}{2}$ teaspoon pepper
1 teaspoon minced parsley
 $\frac{1}{4}$ cup cold water

8. WHITE MOUNTAIN ANGEL CAKE

$1\frac{1}{2}$ cups egg whites
 $1\frac{1}{2}$ cups sugar
1 teaspoon cream of tartar
1 cup bread flour
 $\frac{1}{4}$ teaspoon salt
1 teaspoon vanilla

III. Examine this recipe:

Fudge: 3 cups sugar, $\frac{3}{4}$ cup top milk, $2\frac{1}{2}$ ounces chocolate.

9. Increase the quantity for this recipe by increasing the sugar to 4 cups. Increase the other materials in the same proportion.
10. Increase the quantity by increasing the sugar to 5 cups, increasing the other materials in the same proportion.
11. Increase the quantity by increasing the sugar to 6 cups, increasing the other materials in the same proportion.

IV. Mrs. A. increases the quantity made by the following recipe by using 8 cups of flour instead of 6, and by increasing the other materials in the same proportion.

Mrs. B. decreases the quantity by using 4 cups of flour instead of 6, and by decreasing the other materials in the same proportion.

Copy and supply the missing numbers to show the recipes as used by Mrs. A. and Mrs. B.

Standard Recipe		12. Recipe as Used by Mrs. A.	13. Recipe as Used by Mrs. B.
sifted flour	6 cups	8 cups	4 cups
lard	1 tablespoon
butter	1 tablespoon
salt	2 teaspoons
boiling water	$1\frac{3}{4}$ cups
lukewarm water	$\frac{1}{4}$ cup
condensed milk	$\frac{1}{4}$ cup
yeast cake	1

When the quantity of flour in a recipe is two times the quantity of water people say that flour and water are mixed "*in the ratio of 2 to 1*" or "*in the proportions, 2 parts of flour to 1 part of water.*"

14. What is the ratio of the amount (number of cups) of flour to the amount (number of cups) of water used in the standard recipe,— 2 to 1, or 3 to 1, or 4 to 1?
15. What is the ratio of the amount of flour used in Mrs. A.'s recipe to the amount used in Mrs. B.'s recipe?
16. What does this mean? "*To make paste, mix water and flour in the ratio of 3 to 1.*"

69. Ratio and Proportion

(Do as many of these exercises mentally as you can.)

1. Think of the answers to Problems 14, 15, and 16 on page 77 again.

Supply the missing numbers:

2. When people mix cement and sand, using $2\frac{1}{2}$ times as much sand as cement, they say that the ratio of the amount of sand to the amount of cement is $2\frac{1}{2}$ to or 5 to
3. What is the ratio of the amount of sand to the amount of cement when you use 3 times as much sand as cement?
4. (a) What is the ratio of corn meal to flour when you use two cups of corn meal to 1 cup of flour? (b) What is the ratio of the amount of flour to the amount of corn meal?
5. The children of the Lee School were raising money to improve the playground. Mr. Adams said, "I will give in the ratio of 3 to 2 that you give." The children in grade 7 figured that he meant that he would give \$1.50 for every dollar that they gave. Were they right?
6. In making a gargle, Helen mixes peroxide with hot water in the ratio of 1 to 4. How many tablespoons of water does she put with 3 tablespoons of peroxide?
7. (a) In which of these schools is the ratio of the number of men teachers to the number of women teachers exactly 1 to 5? (b) In which is it exactly or very nearly 1 to 4? (c) In which is it exactly 1 to 3? (d) In which is it exactly 2 to 5?

School	Number of Men Teachers	Number of Women Teachers
A	4	12
B	2	6
C	2	10
D	3	12
E	4	16
F	4	10
G	10	41
H	2	8
I	6	15
J	4	20
K	3	9

8. When people mix cement, sand, and gravel so as to have 2 times as much sand as cement and three times as much gravel as cement, they say that they mix cement, sand, and gravel "in the proportions: 1; 2; 3," or that they use "2 parts of sand and 3 parts of gravel to 1 part of cement."
 (a) How many shovelfuls of sand would be used with 4 shovelfuls of cement in this 1; 2; 3 mixture? (b) How many shovelfuls of gravel would be used?

70. Oral Practice in Comparing Numbers and Quantities

Examine these pairs of numbers:

- In which is the second number 2 times as large as the first?
- In which is the second number $2\frac{1}{2}$ times as large as the first?
- In which is the second number $\frac{3}{4}$ times as large as the first?

a. 2	1	h. 4	3	o. 2	4	v. 4	6	C. 10	6
b. 3	2	i. 5	3	p. 10	5	w. 22	55	D. 4	8
c. 4	2	j. 6	3	q. $2\frac{1}{2}$	5	x. 3	6	E. 6	8
d. 5	2	k. 3	4	r. $7\frac{1}{2}$	5	y. 8	6	F. 12	8
e. 6	2	l. 6	4	s. 15	5	z. 9	6	G. 20	8
f. 1	2	m. 8	4	t. $12\frac{1}{2}$	5	A. 12	6	H. 24	8
g. 2	3	n. 4	10	u. 20	5	B. 15	6	I. 16	8

- Read each pair, telling how many times as large as the first number the second number is. Say, "1 is $\frac{1}{2}$ as large as 2, 2 is $\frac{2}{3}$ as large as 3, 2 is $\frac{1}{2}$ as large as 4, 2 is $\frac{2}{5}$ as large as 5," etc.

- Examine these pairs of quantities. Read each pair, telling how many times as large as the first quantity the second quantity is.

a. 6 in.	1 ft.	h. 8 oz.	2 oz.	o. A plot 6×8 ft.	A plot 9×8 ft.
b. 6 in.	1 yd.	i. 2 ft.	1 yd.	p. A plot 6×8 ft.	A plot 3×4 ft.
c. 6 in.	3 in.	j. 2 ft.	$1\frac{1}{2}$ yd.	q. A plot 6×8 ft.	A plot 9×4 ft.
d. 6 in.	2 in.	k. 1 ft.	$\frac{1}{4}$ yd.	r. A plot 5×5 ft.	A plot 10×10 ft.
e. 8 oz.	1 lb.	l. 100 lb.	$\frac{1}{2}$ ton	s. 18 eggs	3 doz. eggs
f. 8 oz.	$1\frac{1}{2}$ lb.	m. $33\frac{1}{3}$ ¢	\$1	t. $1\frac{1}{2}$ yr.	3 mo.
g. 8 oz.	$\frac{1}{4}$ lb.	n. 40¢	\$2	u. 60 da.	3 mo.

80 **71. Comparing Numbers and Quantities as an
Aid in Solving Problems**

(Do as many of these exercises mentally as you can.)

1. How many times as much will it cost —
 - (a) For 12 gallons of gasoline as for 8 gallons of gasoline?
 - (b) For a workman for 18 days as for a workman for 15 days?
 - (c) For fares for 15 people (all adults) as for fares for 6 people (all adults)?

2. How many times as long will it take to travel —
 - (a) 25 miles as to travel 20 at the same rate?
 - (b) 10 miles as to travel 6 at the same rate?
 - (c) 30 miles as to travel 20 at the same rate?

3. How many times as many cars (all of the same capacity) will be required to hold —
 - (a) 16,000 tons as to hold 12,000 tons?
 - (b) 24,000 tons as to hold 12,000 tons?
 - (c) 8,000 tons as to hold 16,000 tons?

4. A farmer examines his wood-lot and finds 30 diseased trees in 4 acres. How many trees are probably diseased in the entire wood-lot of 24 acres?

5. A merchant examined 20 boxes of berries out of a lot of 240 boxes. 7 of the 20 were not fit to sell. How many of the 240 boxes were probably not fit to sell?

6. Four teams can haul 10 tons of coal from the station to Dale's mill in a day. (a) How many teams will be required to haul 50 tons to the mill in a day? (b) How many days will it take one team to haul 10 tons to the mill? (c) How many days will it take two teams to haul 30 tons to the mill?

7. Supply the missing numbers:

8 = . . . times 2	10 = . . . times 2	12 = . . . × 15
8 = . . . times 3	10 = . . . times 3	12 = . . . × 8
8 = . . . times 4	10 = . . . times 4	12 = . . . × 16
8 = . . . times 5	10 = . . . times 5	12 = . . . × 20
8 = . . . times 6	10 = . . . times 6	12 = . . . × 5

$9 = \dots \text{ times } 2$

$11 = \dots \text{ times } 2$

$12 = \dots \times 4$

$9 = \dots \text{ times } 3$

$11 = \dots \text{ times } 3$

$12 = \dots \times 18$

$9 = \dots \text{ times } 4$

$11 = \dots \text{ times } 4$

$20 = \dots \times 6$

$9 = \dots \text{ times } 5$

$11 = \dots \text{ times } 5$

$20 = \dots \times 8$

$9 = \dots \text{ times } 6$

$11 = \dots \text{ times } 6$

$20 = \dots \times 12$

$9 = \dots \text{ times } 8$

$11 = \dots \text{ times } 8$

$20 = \dots \times 15$

72. Practice for Mastery*

It is necessary to obtain the correct result.

It is desirable to obtain it quickly.

When you are working with numbers,

Think of the numbers and what you are to do with them.

Make no mistakes in copying the numbers.

Write each figure clearly.

Write each figure in the right place.

Check each result unless you are sure that it is right.

Work as fast as you can without making mistakes.

On page 82 is the first of ten practice tests for written work. Keep score of your work in these ten tests in a diagram like the one shown here for Ruth Evans, who scored 11 in the first test, 12 in the second, 15 in the third, 16 in the fourth, and 17 in the fifth. If you practice you can improve your score, no matter how high it is.

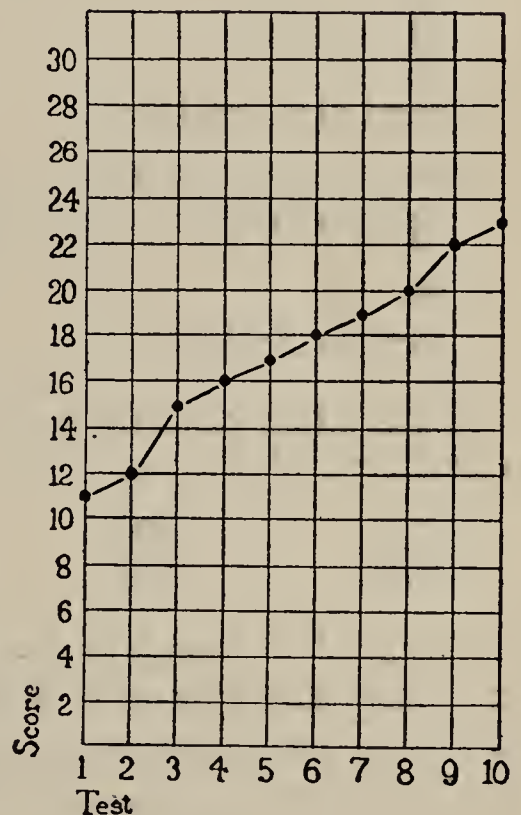

* TO THE TEACHER.—Sections 72 to 91, which will give final command of the computations needed in daily life, may be distributed in any desired way through the school year and repeated as often as necessary.

Find as many correct results as you can in 20 minutes. If you finish before 20 minutes, go back and check any results of which you are not sure, or do some of the exercises in the next test. Arrange your work neatly.

	1.	2.	3.	4.	5.
Multiply \$24.90 by .045	.06	.25	77	.60	

	6.	7.	8.	9.	10.
Divide \$200 by	35	.75	52	106	18

Do not extend any quotient beyond the second decimal place.

Subtract each of the results in 11, 12, 13, 14, and 15 from $30\frac{1}{4}$.

11.	12.	13.	14.
$5\frac{1}{2} + 4\frac{3}{4} + 1\frac{5}{8}$	$1\frac{1}{2} + 1\frac{2}{3} + 2\frac{1}{3}$	$7\frac{1}{4} + 8\frac{1}{2} + 5\frac{3}{4}$	$\frac{7}{8} + \frac{3}{4} + \frac{5}{8}$

15.
 $1\frac{1}{2} + 1\frac{1}{3} + \frac{2}{3}$

Find the products:

16.	17.	18.	19.
$4\frac{1}{2}\%$ of \$650	6% of \$275	46% of 95 mi.	$\frac{1}{4}\%$ of \$3000

20.
 15% of \$4.50

Find what percent of 284 each of these is. Find results to the nearest tenth of 1 percent.

21.	22.	23.	24.	25.
100	400	211	169	137

26. Copy the numbers marked A and find the sum.

27. Copy the numbers marked B and find the sum.

28. Copy the numbers marked C and find the sum.

29. Copy the numbers marked D and find the sum.

30. Copy the numbers marked E and find the sum.

D 925	C 620	B 125	E 935	A 718
C 610	E 644	B 450	A 150	C 825
B 500	A 500	C 440	D 500	D 890
A 849	B 625	A 356	C 643	E 716
B 625	E 475	D 125	E 278	D 942

Find as many correct results as you can in 20 minutes. If you finish before the 20 minutes, go back and check any results of which you are not sure, or do some of the exercises in the next test. Arrange your work neatly.

	1.	2.	3.	4.	5.
Multiply \$16.75 by 46		$.16\frac{2}{3}$.04	70	.15

	6.	7.	8.	9.	10.
Divide \$30 by	203	19	45	.04	75

Do not extend any quotient beyond the second decimal place.

Subtract each of the results in 11, 12, 13, 14, and 15 from \$5.00.

11.	12.	13.	14.	15.
$4\frac{1}{2} \times 35¢$	$7\frac{3}{4} \times 25¢$	$1\frac{5}{8} \times 32¢$	$2\frac{3}{8} \times 40¢$	$10\frac{3}{4} \times 30¢$

Find the products:

16.	17.	18.	19.
37% of 104 mi.	$3\frac{1}{2}\%$ of \$850	5% of \$900	60% of \$10.75

20.
 $\frac{1}{8}\%$ of \$5000.

Find what percent of 360 each of these is. Find the results to the nearest tenth of 1 percent.

21.	22.	23.	24.	25.
300	500	33	93	100

26. Copy the numbers marked A and find the sum.

27. Copy the numbers marked B and find the sum.

28. Copy the numbers marked C and find the sum.

29. Copy the numbers marked D and find the sum.

30. Copy the numbers marked E and find the sum.

A 475	D 125	A 500	B 625	E 650
B 741	E 567	E 939	D 411	C 408
C 635	C 448	A 689	C 638	A 506
E 730	D 840	B 942	D 375	B 298
A 125	B 500	E 675	C 709	D 837

Find as many correct results as you can in 20 minutes. If you finish before 20 minutes, go back and check any results of which you are not sure, or do some of the exercises in the next test. Arrange your work neatly.

	1.	2.	3.	4.	5.
Multiply 38.32 mi. by 40		.35	39	.09	$.12\frac{1}{2}$

	6.	7.	8.	9.	10.
Divide \$75 by	16	95	53	308	.05

Do not extend any quotient beyond the second decimal place.

Subtract each of the results in 11, 12, 13, 14, and 15 from \$175.

11.	12.	13.	14.	15.
15% of \$175	37% of \$240	8% of \$175	$4\frac{1}{4}$ % of \$580	6% of \$425

Find the products:

16.	17.	18.	19.	20.
28% of 620	4% of \$180	$33\frac{1}{3}$ % of \$14	$2\frac{1}{2}$ % of \$900	$\frac{1}{2}$ % of \$9000

Find what percent of 10.5 mi. each of these is. Find the results to the nearest tenth of 1 percent.

21.	22.	23.	24.	25.
6.2 mi.	3.4 mi.	8.9 mi.	15.75 mi.	10.1 mi.

26. Copy the numbers marked A and find the sum.

27. Copy the numbers marked B and find the sum.

28. Copy the numbers marked C and find the sum.

29. Copy the numbers marked D and find the sum.

30. Copy the numbers marked E and find the sum.

A 125	B 931	B 379	C 470	D 580
C 98	A 125	B 872	E 782	C 950
B 460	A 298	D 280	D 625	C 500
E 725	C 450	A 475	B 681	A 875
D 130	E 371	D 160	E 473	E 683

Find as many correct results as you can in 20 minutes. If you finish before 20 minutes, go back and check any results of which you are not sure, or do some of the exercises in the next test. Arrange your work neatly.

	1.	2.	3.	4.	5.
Multiply \$59.25 by	.07	$.33\frac{1}{3}$	90	.18	28

	6.	7.	8.	9.	10.
Divide 144 by	.08	15	109	65	.75

Do not extend any quotient beyond the second decimal place.

Subtract each of the results in 11, 12, 13, 14, and 15 from 50.

11.	12.	13.	14.	15.
$30 \times .16\frac{2}{3}$	$20 \times .12\frac{1}{2}$	$18 \times .37\frac{1}{2}$	$24 \times .87\frac{1}{2}$	$15 \times .75$

Find the products.

16.	17.	18.	19.
2% of \$37	52% of 300 min.	$\frac{1}{8}\%$ of \$8000	$5\frac{1}{2}\%$ of \$2700

20.
40% of \$6.75.

Find what percent of \$750 each of these is. Find the results to the nearest tenth of 1 percent.

21.	22.	23.	24.	25.
\$108.50	\$225	\$71.20	\$416.38	\$89.50

26. Copy the numbers marked A and find the sum.

27. Copy the numbers marked B and find the sum.

28. Copy the numbers marked C and find the sum.

29. Copy the numbers marked D and find the sum.

30. Copy the numbers marked E and find the sum.

B 875	C 125	A 432	D 850	E 498
D 525	B 489	A 289	A 500	D 189
C 689	B 961	E 690	E 633	D 175
A 98	D 175	B 677	C 378	B 416
E 976	A 674	E 425	A 762	A 98

Find as many correct results as you can in 20 minutes. If you finish before 20 minutes, go back and check any results of which you are not sure, or do some of the exercises in the next test. Arrange your work neatly.

	1.	2.	3.	4.	5.
Multiply 85.08 mi. by .16	25	.08	57	80	

	6.	7.	8.	9.	10.
Divide \$16.50 by	85	74	14	204	.04

Do not extend any quotient beyond the second decimal place.

Subtract each of the results in 11, 12, 13, 14, and 15 from 10 ft.

11.	12.	13.
3 ft. 8 in. + 4 ft. 10 in.	4 ft. 11 in. + 2 ft. 5 in.	82 in. + 23 in.

14.	15.
4 ft. 6 in. + 3 ft. 8 in.	5 ft. 10 in. + 3 ft. 2 in.

Find the products:

16.	17.	18.	19.
65% of 280 days	12½% of \$22	3½% of \$1600	⅛% of \$15000

20.
3% of \$56

Find what percent of 459 each of these is. Find results to the nearest tenth of 1 percent.

21.	22.	23.	24.	25.
400	800	247	368	195

26. Copy the numbers marked A and find the sum.

27. Copy the numbers marked B and find the sum.

28. Copy the numbers marked C and find the sum.

29. Copy the numbers marked D and find the sum.

30. Copy the numbers marked E and find the sum.

D 496	E 289	D 125	E 875	E 825
E 875	C 125	A 500	B 989	A 450
B 984	A 425	B 685	D 634	C 792
C 625	B 675	D 763	E 349	D 946
A 810	A 686	B 620	C 664	C 687

Find as many correct results as you can in 20 minutes. If you finish before 20 minutes, go back and check any results of which you are not sure, or do some of the exercises in the next test. Arrange your work neatly.

	1.	2.	3.	4.	5.
Multiply \$43.06 by	66	.05	30	.055	$33\frac{1}{3}$

	6.	7.	8.	9.	10.
Divide 82.4 mi. by	46	55	.32	15	305

Do not extend any quotient beyond the second decimal place.

Subtract each of the results in 11, 12, 13, 14, and 15 from 100 ft.

11.	12.	13.	14.
9×8 ft. 2 in.	7×9 ft. 4 in.	8×4 ft. 4 in.	6×10 ft. 7 in.

15.
 5×14 ft. 10 in.

Find the products:

16.	17.	18.	19.
70% of \$9.50	$4\frac{1}{2}\%$ of \$425	$\frac{3}{4}\%$ of \$6000	73% of 2640 ft.

20.
6% of \$175

Find what percent of \$6000 each of these is. Find results to the nearest tenth of one percent.

21.	22.	23.	24.	25.
\$260	\$348	\$2174	\$210	\$750

26. Copy the numbers marked A and find the sum.
 27. Copy the numbers marked B and find the sum.
 28. Copy the numbers marked C and find the sum.
 29. Copy the numbers marked D and find the sum.
 30. Copy the numbers marked E and find the sum.

E 175	A 689	B 488	A 650	A 540
A 288	D 225	E 125	C 790	B 891
C 400	B 630	C 450	E 425	D 436
D .75	C 135	E 365	A 500	E 965
B 650	B 751	C 500	D 700	D 892

Find as many correct results as you can in 20 minutes. If you finish before 20 minutes, go back and check any result of which you are not sure, or do some of the exercises in the next test. Arrange your work neatly.

	1.	2.	3.	4.	5.
Multiply \$72.40 by	.03	$16\frac{2}{3}$	72	80	.24

	6.	7.	8.	9.	10.
Divide 92,400 sq. ft. by	24	64	16	420	.18

Do not extend any quotient beyond the second decimal place.

Subtract each of the results in 11, 12, 13, 14, and 15 from \$15.00.

11.	12.	13.	14.	15.
$.25 \times \$15$	$.12\frac{1}{2} \times \$20$	$.33\frac{1}{3} \times \$15$	$.62\frac{1}{2} \times \$20$	$.66\frac{2}{3} \times \$7.50$

Find the products:

16.	17.	18.	19.	20.
$2\frac{1}{2}\%$ of \$850	27% of 95 mi.	$1\frac{1}{2}\%$ of \$2900	2% of \$86	25% of \$35

Find what percent of \$825 each of these is. Find results to the nearest tenth of 1 percent.

21.	22.	23.	24.	25.
\$150	\$218	\$74.60	\$33	\$95.20

26. Copy the numbers marked A and find the sum.

27. Copy the numbers marked B and find the sum.

28. Copy the numbers marked C and find the sum.

29. Copy the numbers marked D and find the sum.

30. Copy the numbers marked E and find the sum.

A 489	C 945	B 455	E 760	D 587
E 150	A 865	A 500	C 685	E 560
B 511	B 457	D 125	A 625	D 500
C 125	E 250	D 683	B 570	E 894
D 135	C 579	C 375	A 475	B 647

Find as many correct results as you can in 20 minutes. If you finish before 20 minutes, go back and check any result of which you are not sure, or do some of the exercises in the next test. Arrange your work neatly.

	1.	2.	3.	4.	5.
Multiply \$97.10 by 70	70	84	.035	$12\frac{1}{2}$.04

	6.	7.	8.	9.	10.
Divide \$10.40 by .06	.06	17	34	75	118

Do not extend any quotient beyond the second decimal.

Subtract each of the results in 11, 12, 13, 14, and 15 from \$760.

11.	12.	13.	14.	15.
16% of \$760	45% of \$760	4% of \$825	$3\frac{1}{2}$ % of \$240	5% of \$1040

Find the products:

16.	17.	18.	19.
19% of 6200	80% of \$7.50	3% of \$86	$7\frac{1}{2}$ % of \$94.50
20.			
68% of 350 days			

Find what percent of 9.7 mi. each of these is. Find results to the nearest tenth of 1 percent.

21.	22.	23.	24.	25.
4.5 mi.	7.8 mi.	2.2 mi.	5 mi.	3.4 mi.

26. Copy the numbers marked A and find the sum.
27. Copy the numbers marked B and find the sum.
28. Copy the numbers marked C and find the sum.
29. Copy the numbers marked D and find the sum.
30. Copy the numbers marked E and find the sum.

E 725	A 275	D 959	E 358	A 260
A 450	D 489	E 625	C 169	D 500
B 500	B 875	B 245	B 514	A 370
C 348	C 125	C 113	C 250	D 175
A 647	E 512	B 535	D 450	E 460

Find as many correct results as you can in 20 minutes. If you finish before 20 minutes, go back and check any results of which you are not sure, or do some of the exercises in the next test. Arrange your work neatly.

	1.	2.	3.	4.	5.
Multiply \$61.50 by 93		.20	.37 $\frac{1}{2}$.06	60

	6.	7.	8.	9.	10.
Divide \$400 by	14	60	503	.05	44

Do not extend any quotient beyond the second decimal place.

Subtract each of the results in 11, 12, 13, 14, and 15 from 48.

11.	12.	13.	14.	15.
$3\frac{1}{2} \times 2\frac{1}{2}$	$5\frac{1}{4} \times 4\frac{1}{2}$	$6 \times 3\frac{3}{4} \times 2$	$12 \times 1\frac{3}{4} \times 1\frac{1}{2}$	$2\frac{3}{4} \times 1\frac{1}{4}$

Find the products:

16.	17.	18.	19.
$1\frac{1}{2}\%$ of \$3000	4% of \$79	82% of 15.4 mi.	75% of \$38

20.
 $1\frac{1}{2}\%$ of \$4750

Find what percent of \$4500, each of these is. Find results to the nearest tenth of 1 percent.

21.	22.	23.	24.	25.
\$2140	\$1690	\$730	\$586	\$1395

26. Copy the numbers marked A and find the sum.

27. Copy the numbers marked B and find the sum.

28. Copy the numbers marked C and find the sum.

29. Copy the numbers marked D and find the sum.

30. Copy the numbers marked E and find the sum.

D 580	C 760	B 968	A 208	B 675
C 450	E 515	A 125	B 816	E 706
B 490	B 805	C 646	A 725	D 517
E 656	A 489	D 198	C 125	E 947
A 500	C 557	D 467	E 309	D 480

Find as many correct results as you can in 20 minutes. If you finish before 20 minutes, go back and check any result of which you are not sure, or do some of the exercises in the next test. Arrange your work neatly.

	1.	2.	3.	4.	5.
Multiply 89.6 mi. by	47	.75	.60	8	$2\frac{1}{2}$

	6.	7.	8.	9.	10.
Divide 708.2 mi. by	13	48	.12	24	20.5

Do not extend any quotient beyond the second decimal place.

Subtract each of the results in 11, 12, 13, 14, and 15 from $18\frac{1}{2}$.

11.	12.	13.	14.	15.
$1\frac{1}{3} + 1\frac{1}{3} + \frac{2}{3}$	$3\frac{7}{8} + 4\frac{3}{4} + 5\frac{1}{2}$	$1\frac{1}{8} + 1\frac{1}{2}$	$\frac{2}{3} + \frac{3}{4} + \frac{2}{3}$	$\frac{7}{8} + \frac{3}{4} + 1\frac{3}{8}$

Find the products.

16.	17.	18.	19.
5% of \$7000	$\frac{1}{8}$ % of \$2500	$4\frac{1}{2}$ % of \$6250	90% of \$28

20.
35% of \$1680

Find what percent of 360 each of these is. Find results to the nearest tenth of 1 percent.

21.	22.	23.	24.	25.
219	154	322	63	17

26. Copy the numbers marked A and find the sum.

27. Copy the numbers marked B and find the sum.

28. Copy the numbers marked C and find the sum.

29. Copy the numbers marked D and find the sum.

30. Copy the numbers marked E and find the sum.

E 295	B 970	B 125	E 952	E 853
C 461	E 493	C 498	D 454	C 575
B 150	A 325	B 618	A 125	D 498
D 694	A 855	E 896	D 690	C 690
A 719	C 680	D 675	A 997	B 725

82. Practice

Practice with these until you can find all the results correctly in 3 minutes or less. Do the work "in your head" first. Then check the result by using pencil and paper if you need to. Find the cost of each of these orders:

A.	B.	C.
4½ lb. at 20¢ per lb.	2½ yd. at 26¢ per yd.	12 articles at 6 for 25¢
9 lb. at 15¢ per lb.	5½ yd. at 18¢ per yd.	9 articles at 3 for 10¢
5¼ lb. at 16¢ per lb.	9 yd. at 17¢ per yd.	32 articles at 16 for 25¢
6 lb. at 18¢ per lb.	7 yd. at 25¢ per yd.	6 articles at 2 for 5¢
3¾ lb. at 20¢ per lb.	3½ yd. at 22¢ per yd.	6 articles at 2 for 1¢
7 lb. at 21¢ per lb.	8 yd. at 35¢ per yd.	6 articles at 2 for 25¢
8½ lb. at 30¢ per lb.	6¼ yd. at 12¢ per yd.	6 articles at 4 for 10¢
¾ lb. at 25¢ per lb.	4½ yd. at 14¢ per yd.	9 articles at 3 for 5¢
1½ lb. at 42¢ per lb.	12 yd. at 9¢ per yd.	18 articles at 30¢ per dozen
4 lb. at 43¢ per lb.	7 yd. at 23¢ per yd.	6 articles at 28¢ per dozen

83. Practice

Practice with these until you can find all the results correctly in 4 minutes or less. Do the work "in your head" first. Then check the result by using pencil and paper if you need to. Find the net price (or what the buyer really pays) when the list price and discount are as shown below:

A.	B.	C.	D.
\$8.00 less 40%	\$7.00 less 30%	\$9.00 less 20%	\$10.00 less 15%
\$6.00 less 33⅓%	\$2.50 less 30%	\$12.00 less ⅙	\$1.60 less 10%
\$5.00 less ¼	\$4.00 less ⅕	\$4.80 less 10%	90¢ less ⅕
\$2.50 less ⅕	\$3.00 less 15%	\$1.50 less ⅓	\$12.00 less ⅕
\$2.00 less 25%	\$1.20 less ⅛	\$16.00 less 20%	\$2.40 less ¼
\$6.00 less 20%	\$7.00 less 15%	\$4.00 less 40%	\$3.20 less 5%
\$15.00 less 6%	80¢ less 5%	\$8.00 less 25%	\$9.00 less 25%
\$5.00 less 40%	\$10.00 less 12½%	\$45.00 less ⅕	\$2.50 less ⅔
\$1.25 less 20%	\$18.00 less 10%	\$2.00 less 35%	\$1.80 less 33⅓%
\$4.00 less ⅓	\$3.00 less 30%	\$7.50 less 2%	\$21.00 less 10%

Practice with these until you can find all the results correctly in 5 minutes or less. Do the work "in your head" if you can. Then check the result by using pencil and paper if you need to.

a. $\frac{1}{2} \times \frac{1}{4}$

b. $\frac{3}{2} \times \frac{5}{2}$

c. $\frac{1}{3} \times \frac{3}{8}$

d. $1\frac{1}{2} \times 1\frac{1}{2}$

e. $2 \times \frac{3}{4} \times 1\frac{1}{2}$

f. $2\frac{1}{2} \times 1\frac{1}{2}$

g. $3\frac{1}{4} \times 8$

h. $6 \times 8\frac{1}{3}$

i. $\frac{4 \times 12}{3 \times 4}$

j. $\frac{8 \times 15}{10 \times 3}$

k. $\frac{12 \times 15}{9 \times 50}$

l. $\frac{6 \times 9}{8 \times 12}$

m. $9 \times \frac{5}{8}$

n. $\frac{7}{8} \times 4$

o. $4\frac{1}{2} \times \frac{2}{3}$

p. $\frac{5}{6} \times 12$

q. $\frac{1}{4}$ of 15

r. $\frac{1}{3}$ of 25

s. $\frac{3}{8} \times 40$

t. $\frac{1}{3}$ of 100

85. Practice

Practice with these until you can find all the results correctly in 8 minutes or less. Do the work "in your head" if you can. Then check the result by using pencil and paper if you need to.

A.

$\frac{7}{8}$ of \$1

$\frac{1}{6}$ of \$1

$\frac{1}{8}$ of \$3

$\frac{3}{4}$ of \$2.50

$\frac{5}{8}$ of \$40

$\frac{1}{4} \times 15$

$\frac{1}{8} \times \$150$

$\frac{2}{3} \times 20$

B.

$\frac{2}{3}$ of \$1

$\frac{5}{8}$ of \$1

$\frac{1}{4}$ of \$5

$\frac{3}{8}$ of \$4

$\frac{2}{3}$ of \$5

$\frac{1}{3} \times \$2.25$

$\frac{3}{8} \times 8$

$\frac{7}{8} \times \$2.50$

C.

$\frac{5}{6}$ of \$1

$\frac{3}{4}$ of \$1

$\frac{1}{3}$ of \$4

$\frac{3}{4}$ of \$1.50

$\frac{7}{8}$ of \$6

$\frac{1}{5} \times \$625$

$\frac{5}{8} \times 6$

$\frac{1}{2} \times \$11.50$

D.

$\frac{5}{8} \times \$1$

$\frac{1}{3} \times \$1$

$\frac{1}{8} \times \$2$

$\frac{1}{3} \times \$7$

$\frac{1}{6} \times \$10$

$\frac{3}{4} \times \$12$

$\frac{1}{6} \times \$4$

$\frac{7}{8} \times \$20$

Supply the missing fractions:

E.

$12\frac{1}{2}\text{¢} = \dots$ of \$1

$33\frac{1}{3}\text{¢} = \dots$ of \$1

$62\frac{1}{2}\text{¢} = \dots$ of \$1

$66\frac{2}{3}\text{¢} = \dots$ of \$1

F.

$16\frac{2}{3}\text{¢} = \dots$ of \$1

$37\frac{1}{2}\text{¢} = \dots$ of \$1

$75\text{¢} = \dots$ of \$1

$60\text{¢} = \dots$ of \$1

G.

$20\text{¢} = \dots$ of \$1

$40\text{¢} = \dots$ of \$1

$87\frac{1}{2}\text{¢} = \dots$ of \$1

$6\frac{1}{4}\text{¢} = \dots$ of \$1

86. Practice

Practice with these until you can state all the results correctly in 8 minutes or less. Do the work "in your head" first. Then check the result by using paper and pencil if you need to.

State what the interest for one year will be on —

- | | | |
|----------------|----------------|----------------|
| A. \$200 at 4% | B. \$250 at 6% | C. \$900 at 5% |
| \$200 at 4½% | \$200 at 3½% | \$51 at 4% |
| \$42 at 3% | \$25 at 4% | \$20 at 3½% |
| \$900 at 6% | \$500 at 4½% | \$8000 at 4½% |
| \$75 at 4% | \$3500 at 6% | \$2500 at 6% |
| \$400 at 4½% | \$2000 at 4½% | \$45 at 4% |

State what the interest for 6 mo. will be on —

- | | | |
|----------------|----------------|----------------|
| D. \$300 at 4% | E. \$700 at 6% | F. \$800 at 5% |
| \$400 at 5½% | \$150 at 6% | \$300 at 5% |

State what the interest for 60 days or $\frac{1}{6}$ yr. will be on —

- | | | |
|----------------|----------------|----------------|
| G. \$100 at 6% | H. \$125 at 6% | I. \$600 at 6% |
| \$300 at 6% | \$310 at 6% | \$600 at 5% |
| \$300 at 4% | \$ 75 at 6% | \$1200 at 5% |

87. Practice

Practice with these until you can state all the results correctly in 8 minutes or less. Do the work "in your head" first. Then check the results by using pencil and paper if you need to. State the quotients and remainders. Say "45 = seven 6s and 3 remainder, 60 = eight 7s and 4 remainder," etc.

- | | | | | |
|-------------------|---------------------|---------------------|---------------------|---------------------|
| A. | B. | C. | D. | E. |
| $6\overline{)45}$ | $20\overline{)175}$ | $9\overline{)70}$ | $16\overline{)70}$ | $8\overline{)75}$ |
| $7\overline{)60}$ | $12\overline{)75}$ | $8\overline{)65}$ | $13\overline{)45}$ | $42\overline{)100}$ |
| $9\overline{)50}$ | $15\overline{)95}$ | $11\overline{)90}$ | $7\overline{)52}$ | $32\overline{)140}$ |
| $8\overline{)30}$ | $14\overline{)45}$ | $17\overline{)40}$ | $6\overline{)38}$ | $9\overline{)80}$ |
| $4\overline{)25}$ | $16\overline{)50}$ | $15\overline{)125}$ | $40\overline{)350}$ | $7\overline{)65}$ |
| $7\overline{)44}$ | $13\overline{)40}$ | $14\overline{)73}$ | $80\overline{)575}$ | $6\overline{)51}$ |
| $9\overline{)60}$ | $30\overline{)250}$ | $18\overline{)50}$ | $25\overline{)230}$ | $80\overline{)500}$ |
| $6\overline{)58}$ | $70\overline{)510}$ | $21\overline{)85}$ | $35\overline{)75}$ | $24\overline{)100}$ |

Practice with these until you can state all the results correctly in 10 minutes or less. Do the work "in your head" first. Then check the result by using pencil and paper if you need to.

State the products:

A.	B.	C.	D.	E.
2×65	4×25	6×25	2×75	8×16
4×32	7×13	3×55	7×16	3×75
8×14	9×15	9×80	9×25	2×37
5×75	3×28	2×86	3×19	9×18
6×24	6×75	5×13	5×45	7×75
3×35	8×31	7×25	6×81	6×32
7×15	4×75	8×45	4×18	4×150
9×12	2×125	4×43	8×52	5×14

State what the interest for one year will be on —

F.	G.	H.
\$1000 at $3\frac{1}{2}\%$	\$250 at 5%	\$6000 at $4\frac{1}{2}\%$
\$650 at 5%	\$85 at 4%	\$3500 at 5%
\$25 at 3%	\$54 at 3%	\$65 at 4%
\$31 at 4%	\$104 at 4%	\$45 at 3%

State what the interest for 90 days or $\frac{1}{4}$ yr. will be on —

I.	J.	K.
\$200 at 4%	\$200 at 6%	\$225 at 4%
\$400 at 6%	\$350 at 4%	\$500 at 6%
\$100 at 5%	\$1000 at 6%	\$200 at 5%

89. Practice

Express each of these in lowest terms:

A.	$\frac{4}{12}$	$\frac{12}{8}$	$\frac{6}{4}$	$\frac{12}{6}$	$\frac{8}{8}$	$\frac{4}{6}$	$\frac{10}{8}$	$\frac{9}{6}$	$\frac{8}{4}$	$\frac{10}{12}$
B.	$\frac{6}{10}$	$\frac{4}{4}$	$\frac{16}{12}$	$\frac{6}{8}$	$\frac{8}{12}$	$\frac{10}{6}$	$\frac{14}{8}$	$\frac{8}{6}$	$\frac{9}{12}$	$\frac{6}{12}$
C.	$\frac{3}{12}$	$\frac{15}{12}$	$\frac{2}{6}$	$\frac{14}{8}$	$\frac{16}{24}$	$\frac{10}{6}$	$\frac{18}{12}$	$\frac{15}{24}$	$\frac{10}{4}$	$\frac{20}{16}$

A knowledge of arithmetic helps boys and girls and men and women to solve the problems which they meet in the home, the store, the office, the workshop, the farm, the camp, and the playground.

To solve a problem you need to **know what to do** and to **be able to do it correctly**. When the problem is stated in words, the first thing is to **understand what the words mean**. For example, solve this problem, first asking the meaning of any words or phrases that you do not know:

If you leave \$1000 in the savings bank at 4% for 2 years, is it more profitable for you to be paid the interest semiannually or annually? How much more profitable is it?

The next thing is to **know whether you need to use any facts besides those stated in the problem**. For example, would your answer to the problem which you just solved be the same if savings banks paid only *simple interest*, that is interest only on the money deposited, not on the interest added to it?

What do you need to know besides the facts stated in this problem, *What is the total weight of 110 bushels of corn and 65 bushels of oats?* in order to solve it?

Solve this problem: *How many garden plots, each 36 ft. by 20 ft., can be made from two acres?* What do you need to know besides the facts stated here, in order to solve it?

The best way to learn to solve the problems which you will meet in life is to practice, just as you have done in school, especially with problems that people really have to solve. When you fail to solve a problem by yourself, observe the correct solution. Then, after a day or two, try it again. Do so with the Graded Test on the next page, and with all the problems you have to solve later. In sections 93 to 103 write all answers. Write any work that you cannot do more conveniently and accurately mentally.

93. A Graded Test in Problem Solving

Begin with No. 1 and see if you can solve all twelve correctly.

1. How much change should I expect from \$5.00, after paying for 5 pounds of coffee at 38 cents a pound?
2. A baseball team played 160 games during the season and won 100 of them. What part of the whole number of games did the team win?
3. If \$1991 a day is paid to 724 men who each earn the same wages, how much does each man receive?
4. The children of a school made badges. Five hundred fifty were needed. In 4 days grades 3 to 7 made 20, 25, 63, 132, and 144 badges. The eighth grade agreed to make the rest. How many did the eighth grade have to make?
5. A man has a salary of \$125 a month. He saves 20 percent of his salary. How much will he save in a year?
6. A store takes in the following sums: \$1250.50, \$300, \$175, \$16.25, \$120.50, \$32.75, \$68.50. It pays out: \$600, \$360, \$166.67, \$33.33, \$240. How much remains?
7. Mr. Marshall receives a salary of \$2500 a year. His rent costs him $\frac{1}{5}$ of this and his other expenses are \$1500. He saves the rest. What percent of his salary does he save?
8. A grocer had a tank holding $44\frac{3}{16}$ gallons of oil. One day he drew out $15\frac{3}{4}$ gallons and the next day $9\frac{1}{8}$ gallons. How many gallons were left in the tank?
9. How much will Mr. Fox receive for $8\frac{3}{4}$ dozen pencils at the rate of 6 for 25¢?
10. John is 4 ft. 9 in. How tall will he be in two years if he grows $3\frac{1}{4}\%$ of his present height the first year, and $3\frac{1}{4}\%$ of his height a year from now the second year?
11. Mrs. A., Mrs. B., and Mrs. C. bought a box of prunes. Mrs. A. paid \$1.75, Mrs. B. paid \$1.25, Mrs. C. paid 75¢. The prunes weighed 24 lb. How many pounds should each of the ladies have?
12. Mr. A. has 150 tons of coal to haul from a mine. With 3 teams at work for 2 days, 30 tons were hauled. How many days will it take to haul the rest of the coal if 8 teams are used?

An employer to whom you apply for a position may give you a problem to solve that has a "catch" in it so as to discover whether you are a keen thinker who can see what the "catch" is and not be caught. Or he may give you a problem that is tangled up so as to discover whether you can think out what it means.

Each of these problems has a little catch, or is a little complicated, but if you think just what each word means they won't catch you or mix you up.

1. Dick started from his house, walked two miles north, then two miles west, then two miles south. How far away from his house was he then?
2. What number must you multiply 8 by to get 16 as the product?
3. A girl divides a number by 5 and the correct answer is 15. What is the number?
4. How many times must you add $1\frac{1}{2}$ to 6 to have 15 as the result?
5. How much is 5 times $\frac{1}{3}$ of 36 times 5?
6. The sum of two numbers is 40. One of the numbers is 14. What is the other number?
7. What number multiplied by 7 gives a product of 28?
8. What number subtracted 12 times from 30 will leave a remainder of 6?
9. If a train travels half a mile in a minute, what is its rate per hour?
10. What number minus 16 equals 20?
11. What number doubled equals 2 times 3?
12. If 7 multiplied by some number equals 63, what is the number?
13. Is $2 \times 2 \times 2 \times 2 \times 2$ more than 2×12 ?
14. If a man gets \$2.50 per day, what is his wage per week?
15. Half of what number equals $\frac{1}{3}$ of 21?
16. What number doubled is half of eight?
17. What must you divide 48 by to get twice as much as half of eight?
18. How many quarters of a quarter equal half of a half?

95. Problems of a Dairy Farmer

1. (a) How many lb. of butter-fat were produced in each month by each of these cows? (b) How many pounds in the entire year?

Do you multiply 1626 by 3.81 or by .0381?

Do you multiply 1604 by 3.85 or by .0385?

	A VERY VALUABLE COW			A GOOD COW		
	Pounds of Milk	Percent of Butter-Fat	Pounds of Butter-Fat	Pounds of Milk	Percent of Butter-Fat	Pounds of Butter-Fat
1st month	1626	3.81	821	3.90
2d month	1604	3.85	793	3.74
3d month	1580	3.90	760	3.78
4th month	1471	3.91	741	3.80
5th month	1409	3.92	688	3.71
6th month	1400	3.84	670	3.74
7th month	1361	3.98	609	3.81
8th month	1305	4.01	602	3.85
9th month	1261	4.14	543	3.92
10th month	1040	4.21	510	4.01
11th month	801	4.20	470	4.05
12th month	106	4.61	213	4.30
	Total for year			Total for year		

2. What is the percentage of butter-fat in the milk when 11,240 lb. give 568 lb. butter-fat?
3. What is the percentage of butter-fat in milk when 20,710 lb. give 697 lb. butter-fat?
4. Mr. Fay reckons that, counting all expenses (food, labor, interest on money invested in his farm, and a fair salary for himself, etc.), he could take 40 cows as boarders (giving the owner of the cows the milk or butter-fat they produced) for \$120 per year per cow. How many lb. butter-fat at 36¢ per pound must a cow produce per year to earn her board at Mr. Fay's farm?
5. If a cow produces 10,000 lb. milk sold at the farm for $1\frac{3}{8}$ ¢ per lb., how much more does she earn than her board?
6. Mr. Allen has his own cows. He keeps account of what each cow produces, and sells those that do not bring in at least \$120 per year. Last year his 5 least profitable cows showed these records:

		Other Products Valued at	Total Value of Product for the Year
No. 104	340 lb. butter-fat at 34¢;	\$45
No. 111	296 lb. butter-fat at 34¢;	\$40
No. 119	288 lb. butter-fat at 34¢;	\$36
No. 126	249 lb. butter-fat at 34¢;	\$28
No. 127	207 lb. butter-fat at 34¢;	\$20

How much did each cow earn?

- On the average his 40 cows earned \$141.70. Leaving out No. 119, No. 126, and No. 127 what did the other 37 cows earn on the average?
- If No. 119, No. 126, and No. 127 are replaced by three cows earning \$130 apiece, and the other 37 cows do as well as before, what will the average earnings per cow be next year?
- In five years Mr. Allen has raised the average yearly earnings of his herd from \$78.20 to \$141.70. By what percent of what they were 5 years ago has he increased the earnings?
- Mr. Allen sold eleven calves last year for \$2850. What was the average price per calf?
- The highest price ever paid for a single cow is \$40,600, paid for the 8th Duchess of Geneva. How many ordinary cows at \$80 each could be bought for the amount received for the Duchess?

96. Some of a Farmer's Enemies

On the average 1 purslane plant has 69,000 seeds.

On the average 1 ragweed plant has 23,100 seeds.

On the average 1 crab-grass plant has 89,600 seeds.

- If a farmer leaves six purslanes to grow up to seed on a farm and one tenth of one percent of their seeds grow next year, how many purslane plants would there be for the farmer to fight next year?
- If every seed from a single tumbleweed plant with 14,000 seeds grew and produced on an average 14,000 seeds, and each of these did the same the next season, how many great-grandchildren of that single tumbleweed would there be?

3. Supposing that every seed grew to be a plant, how many square feet of land would the great-grandchildren of the ragweed plant cover, counting 4 plants to a square foot?
4. How many acres would they cover?

Mixtures sold as food for cattle often contain many weed seeds. In 10 specimens examined at the Connecticut Agricultural Experiment Station, the number of weed seeds per lb. of the mixture was as follows:

- No. 1, the purest, had 7800 weed seeds per lb.
- No. 2, the next purest, had 8160 weed seeds per lb.
- No. 3, the next purest, had 8574 weed seeds per lb.
- No. 4, the next purest, had 10,360 weed seeds per lb.
- No. 5, the next purest, had 11,528 weed seeds per lb.
- No. 6, the next purest, had 22,224 weed seeds per lb.
- No. 7, the next purest, had 27,100 weed seeds per lb.
- No. 8, the next purest, had 29,324 weed seeds per lb.
- No. 9, the next purest, had 48,663 weed seeds per lb.
- No. 10, the worst, had 86,000 weed seeds per lb.

5. What is the average number of weed seeds per lb. in what you buy, if you buy a pound of each of these cattle feeds?
6. Counting that on an average 20,000 weed seeds weigh an ounce, what percent of the food that you pay for is weed seeds (a) When you buy No. 6 feed? (b) When you buy No. 7? (c) When you buy No. 8? (d) When you buy No. 9?
7. If 23% of a feed mixture is made of grain screenings, and $\frac{3}{4}$ of the grain screenings are weed seeds, what percent of the feed mixture will be weed seeds?
8. Last year Mr. Lord had 26 cattle, each of which ate 30 lb. per week of Mixture No. 7 for 28 weeks. He reckoned the number of weed seeds that he had fed his cattle that year. What was the correct result?
9. He estimated that to balance the harm done to his farm by his using that feed that year would require at least 30 days' labor of a man and a horse. How much would that be, if the man received \$2 a day and the work of the horse is counted at 65¢ per day?

Some problems can be solved more easily by indicating what you are going to do before you do it, and by using pairs of parentheses to help show what you are to do. For example:

Total amount to be earned = $\$15 + (\frac{1}{2} \times \$15) + (\frac{1}{3} \times \$15)$
tells what you are to do to solve problem 1.

1. Ruth, Mary, and Nell were planning to earn money for a trip to the country. Ruth promised to earn \$15. Mary promised to earn half as much as Ruth. Nell promised to earn one third as much as Ruth. What was the total amount to be earned by all three together?

Pairs of parentheses are used to help indicate operations.

$(4 + 7) \times 9$ means, "Add 4 and 7, then multiply the sum by 9."

$4 + (7 \times 9)$ means, "Add 4 to the product of 7 and 9."

$(4 + 7) \times (9 - 5)$ means, "Add 4 and 7. Multiply the sum by 4 (5 less than 9)."

$4 + (7 \times 9) - 5$ means, "Add 4 and 63. Then subtract 5."

Indicate what you are going to do in problems 2 and 3. Then do it. You may indicate what you are going to do in problems 4 and 5, if you wish. Or you may just do what is necessary to find the right answer.

2. It is estimated that for 25 days in the year, when canker worms are crawling about the trees, a chickadee eats 30 of the worms a day. Supposing that a worm would do on the average $\frac{3}{4}$ of a cent's worth of damage, how much does a chickadee save the farmer in the 25 days?
3. Of the food that a robin eats, about 42% is made up of insects and bugs. About 47% is wild fruits. What percent of his food may be made up of cultivated fruits, etc.?
4. 258 red-tailed hawks were killed and the contents of their stomachs showed that they had recently eaten in all 350 field mice, and 2 young chickens. Counting the harm done by eating the chickens as $16\frac{2}{3}$ cents' worth for each, and the good done by eating the field mice at $1\frac{3}{4}$ ¢ per field mouse, compare the good and the harm.

5. Compare the good and the harm done to man by a hawk, supposing that a hawk kills 3 chickens worth $16\frac{1}{3}\text{¢}$ each and 750 mice that would each do $1\frac{3}{4}\text{¢}$ worth of harm.

98. The Use of Parentheses

You will learn later about the way in which indicating operations by parentheses helps business men and other workers. In performing operations with numbers inclosed in parentheses, follow this rule:

Find the result of the operation indicated within each pair of parentheses and write the result in place of the pair of parentheses and their contents. Then do what remains to be done.

*Thus, to solve $(9 - 7) \times (8 - 5)$,
first write or think 2×3*

*To solve $(6 \times 8) + (4 \times 7)$,
first think or write $48 + 28$*

Find the missing numbers:

- a. $(4 \times \$8) + (5\% \text{ of } \$600) = \$ \dots$
- b. $(\frac{1}{5} \text{ of } \$6) + (\frac{1}{4} \text{ of } \$10) = \$ \dots$
- c. $(2 \times 18 \text{ mi.}) + (1\frac{1}{2} \times 20 \text{ mi.}) = \dots \text{ mi.}$
- d. $(7 \times 4) = \dots\%$ of 50.
- e. $(2\frac{1}{2} + 1\frac{3}{4} + 1\frac{1}{4} + 1\frac{1}{2}) \div 4 = \dots$
- f. $(9 \times 11) + (8 \times 3) = \dots$
- g. $(6 \times \$10.50) + (3\% \text{ of } \$800) = \$ \dots$
- h. $.04 \times (\$28 + \$10 - \$3) = \dots$
- i. $10 \times (\$18 - \$3.60) = \$ \dots$
- j. $(70\% \text{ of } \$9) - (75\% \text{ of } \$8) = \$ \dots$
- k. $(4 \times 3 \times 5) \div (2 \times 1\frac{1}{2} \times 1) = \dots$
- l. $(4 + 6 + 5 + 1) \div 4 = \dots$
- m. $(3 \times 22 \text{ mi.}) - (4 \times 15 \text{ mi.}) = \dots \text{ mi.}$
- n. $6 \times (5\frac{3}{8} + 2\frac{1}{8}) = \dots$
- o. $.66\frac{2}{3} \times (75\% \text{ of } \$200) = \$ \dots$
- p. $87\frac{1}{2}\%$ of $(80\% \text{ of } \$200) = \$ \dots$
- q. $(\frac{3}{8} \text{ of } \$100) + (\frac{1}{4} \text{ of } \$50) = \$ \dots$

The world's record for quantity of corn produced on one acre is, or was until recently, $232\frac{5}{7}$ bu. of corn. It was grown by a boy, W. L. Dunson.

1. How many bushels would 10 acres produce at that rate?
2. What was the value of the crop at 60¢ per bushel (to the nearest cent)?

The corn crop for the United States in 1915 was 3,054,535,000 bu. grown on 108,321,000 acres, and valued at \$1,755,859,000.

3. How many bushels were grown per acre on the average?
4. What was the average value of the crop per bushel?
5. What was the average value of the crop per acre?
6. How many times as much corn per acre did Dunson grow as the average for the United States? (*Find the result to the nearest integer.*)
7. Dunson used \$26.70 worth of fertilizer on his acre. What would be the cost for fertilizer for a 24-acre field at this rate?
8. Mr. Vance tried raising tobacco on a 10-acre field for three years. He made a profit of \$120 one year, a profit of \$30 one year, and a loss of \$20 one year. Then he tried raising garden truck and made profits of \$105, \$345, and \$560 in three years. How many times as much profit did he make by raising garden truck as by raising tobacco?

The average value per acre for certain crops in this country was as follows some years ago:

Onions	\$178	Vegetables and truck	\$54
Sugar cane	87	Tobacco	52
Small fruits	81	Sweet potatoes	37
Hops	73	White potatoes	33

9. What will the value be in each case if, by better methods of farming, it is increased 10%?
10. If it is increased 13.4%?

These are standard mixtures of fertilizers or plant foods. Different sorts of crops need different mixtures.

P stands for acid phosphate.

C stands for a fertilizer containing nitrogen.

K stands for a fertilizer containing potash.

I. 40 lb. P, 50 lb. C, and 10 lb. K.

II. 45 lb. P, 40 lb. C, and 15 lb. K.

III. 800 lb. P, 1000 lb. C, and 200 lb. K.

IV. 880 lb. P, 960 lb. C, and 160 lb. K.

V. 44 lb. P, 48 lb. C, and 8 lb. K.

VI. 200 lb. P, 250 lb. C, and 50 lb. K.

VII. 22 lb. P, 24 lb. C, and 4 lb. K.

VIII. 90 lb. P, 80 lb. C, and 30 lb. K.

1. Which of these mixtures are in the proportion of 4 of P, 5 of C, and 1 of K?
2. Which of these mixtures are in the proportion of 9 of P, 8 of C, and 3 of K?
3. Which of these mixtures are in the proportion of 11 of P, 12 of C, and 2 of K?
4. How many pounds of each shall I buy to make 600 lb. of a mixture of P, C, and K in the proportions 11, 12, and 2? If you can find the correct result without any help, do so. There are several different ways, all correct. If you cannot think of a way to find the correct result by yourself, find the missing numbers in the next lines. Then try again.

$$11 + 12 + 2 = \dots \qquad .44 \times 600 \text{ lb.} = \dots \text{ lb.}$$

$$11 = \dots \times 25 \qquad .48 \times 600 \text{ lb.} = \dots \text{ lb.}$$

$$12 = \dots \times 25 \qquad .08 \times 600 \text{ lb.} = \dots \text{ lb.}$$

$$2 = \dots \times 25$$

5. Check your result by finding whether the sum is 600.
6. How many pounds of each shall I buy to make 400 lb. of a mixture of P, C, and K in the proportions: 9 : 8 : 3. Find the result in any correct way that you can think of. If you need help, think of $9 + 8 + 3$, $20 \overline{)9}$, $20 \overline{)8}$, and $20 \overline{)3}$; and then think of how to use your quotients.
7. Check your result.

8. A standard mixture for corn consists of 4 parts of acid phosphate, 3 parts of fish scrap, and 1 part kainit. How many pounds of each would you buy (a) To make 1000 lb. of the mixture? (b) To make a ton of the mixture? (c) To make 1200 lb. of the mixture?
9. $12\frac{1}{2}\%$ of kainit is potash. How many pounds of potash are there in 250 lb. kainit?
10. $8\frac{1}{4}\%$ of fish scrap is nitrogen. How many pounds of nitrogen are there in 750 lb. fish scrap?

101. What Plants Need to Drink

1. 75% of green grass is water and 25% is dry matter. How much will a ton of green grass weigh when it is perfectly dry?
2. To make a ton of perfectly dry hay how much green grass must be cut?
3. For every ton of dry matter in clover hay, the plants drank 310 tons of water, while they were growing. At $62\frac{1}{2}$ lb. per cubic foot, how many cubic feet of water are there in 310 tons of water?
4. For every pound of dry matter in oats the plants drank 376 lb. of water while they were growing. How many cubic feet of water are used by the plants in making 100 lb. of dry matter?
5. An **acre-foot** of water means water enough to cover 1 acre 1 foot deep. How many cubic feet of water = 1 acre-foot of water?
6. How many acre-feet of water are there in a reservoir holding 100,000,000 cu. ft.?
7. When a pint of water evaporates from each square foot of soil in a day (a) How many pints will evaporate from an acre in a day? (b) How many gallons will evaporate? How many cu. ft., counting $7\frac{1}{2}$ gallons to a cubic foot? (c) How many cu. ft. evaporate from an acre in a day when the amount of evaporation is decreased 40% by proper plowing and cultivation?

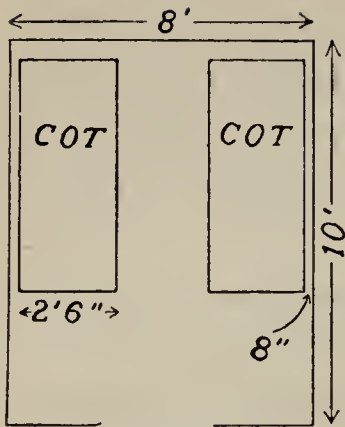

FIG. 1

2. On these sills are placed 2" by 6" floor beams 8' long as shown in Fig. 3.

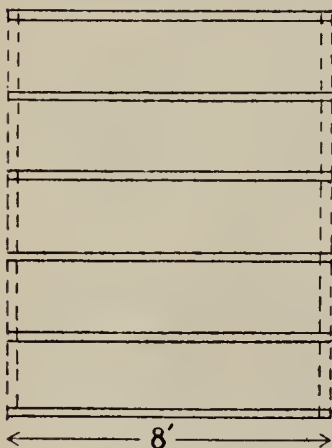

FIG. 3

Fig. 1 is the plan for the floors of huts which some girls built at a summer camp. 8' means 8 ft. 8" means 8 in.

1. In building the huts two sills each 3" \times 6" and 10' long are placed on the foundation with inside edges 7' 6" apart as shown in Fig. 2. How far apart are their outside edges?

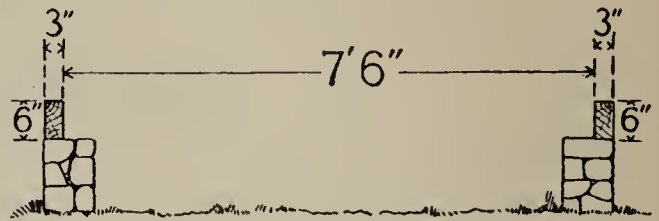

FIG. 2

Counting that 1 board foot means as much lumber as there is in a piece 1 ft. long, 1 ft. wide, and 1 inch thick, how many board feet are there (a) In one of these floor beams? (b) In one of the two sills?

3. On the floor beams, boards 10' by 6" by $\frac{7}{8}$ " are nailed. How many boards are required for the floor?

In counting board feet, any piece of wood less than 1 inch thick is counted as 1 inch thick.

4. How many board feet are there (a) In one of these boards?
(b) In 16 of the boards?
5. How many board feet are there in the two sills, the 6 floor beams, and the 16 boards all together?
6. How many board feet are there in 40 beams each 12' \times 3" \times 6"?
7. How many board feet are there in 100 pieces each 16' \times 2" \times 4"?
8. In 50 pieces each 18' \times 2" \times 10"?

To find the number of board feet in a piece of lumber that is more than 1 inch thick,

Express two of the dimensions in feet and one dimension in inches.

Then multiply. Cancel if you can.

Find the number of board feet in each of these pieces or lots of lumber. Arrange your work neatly as shown in the first two.

1. A 2" \times 10" beam 18 ft. long. $18 \times \frac{1}{6} \times 10$
2. 30, 2" \times 4" joists each 16 ft. long. $30 \times 16 \times \frac{1}{6} \times 4$
3. 20, 2" \times 4" joists each 12 ft. long.
4. 4 sills each 4" \times 6" and 26 ft. long.
5. 16, 3" \times 8" beams each 14 ft. long.
6. A 6" \times 8" beam 30 ft. long.

To find the number of board feet in a board less than 1 inch thick,

Multiply the length in ft. by the width in ft.

Find the number of board feet in each of these lots of boards:

7. 9 pieces, 6" \times $\frac{3}{4}$ ", 10' long.
8. 20 pieces, 3" \times $\frac{3}{4}$ ", 16' long.
9. 40 pieces, 3" \times $\frac{3}{4}$ ", 14' long.
10. 28 pieces, 3" \times $\frac{3}{4}$ ", 12' long.
11. 80 pieces, 9" \times $\frac{7}{8}$ ", 16' long.

Carpenters and lumber dealers often write M for 1000 when writing about board feet.

12. What is the cost of 4M N.C. pine at \$45 per M?
13. What is the cost of 2½M maple flooring at \$80 per M?

Find how many board feet there are in each of these lots, and find the cost of each lot at \$38 per M:

14. 4 pieces, 6" \times 8", 16' long.
15. 36 pieces, 2" \times 10", 14' long.
16. 24 pieces, 2" \times 8", 16' long.
17. 50 pieces, 2" \times 4", 10' long.
18. 22 pieces, 2" \times 4", 12' long.
19. 4 pieces, 4" \times 6", 30' long.
20. 18 pieces, 2" \times 10", 18' long.
21. 60 pieces, 2" \times 4", 12' long.
22. 6 pieces, 3" \times 8", 16' long.
23. 30 pieces, 2" \times 6", 16' long.

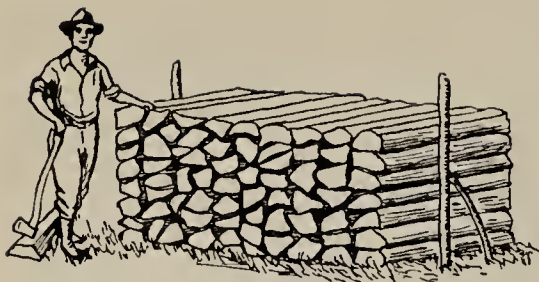

Wood cut as shown in the picture is called cord wood. One cord of wood is a pile 8 ft. long and 4 ft. high. It may be of different widths.

(Without pencil.)

1. If the wood is cut in 4-ft. lengths, a cord occupies 128 cu. ft.
 - (a) How many cubic feet does a cord of wood cut in 2-ft. lengths occupy?
 - (b) A cord of wood cut in 18-inch lengths?
2. How many cords are there in a pile 80 ft. long, 4 ft. wide, and 4 ft. high?
3. A log 32 ft. long is sawed into 4-ft. lengths.
 - (a) How many will there be?
 - (b) In how many places must it be sawed?
4. Wood cut into 4-ft. lengths is put in a pile 4 ft. high. How long must the pile be to make a cord and a half?
5. Supply the missing numbers:
 - a. A cord of 4-ft. wood contains . . . times as much as a cord of 2-ft. wood.
 - b. A cord of 4-ft. wood contains . . . times as much as a cord of 18-inch wood.
 - c. Three cords of 4-ft. wood contain . . . times as much as two cords of 18-inch wood.

(Use pencil if you need to.)

6. At Hale's brick yard, 115 cords of 4-ft. wood are used per year. How long a pile would that make
 - (a) If the wood is placed in a pile 4 ft. wide and 4 ft. high?
 - (b) If the wood is placed in a pile 8 ft. wide and 4 ft. high?
7. How many times as much wood is there in a pile $8 \times 5 \times 8$ ft. as there is in a pile $4 \times 4 \times 10$ ft.?
8. At \$5.50 per cord, what is the total value of three piles of 4-ft. wood, each 4 ft. wide and 4 ft. high, if one pile is 17 ft. long, another 20 ft. long, and the third is 19 ft. long?
9. Is a cord of 4-ft. wood five times as large as a cubic yard? Prove that your answer is right.

Mr. Smith bought an old farm on a lake in the woods. Alice and Dan and Fred went there for the summer. The boys wished to explore the farm and lake and make a map to show where every interesting thing was. They had a book that told them how to do it, but they could not understand what the book meant when it spoke of the "compass," "an angle of 17 degrees," "8 degrees west of north," "similar triangles," "a protractor," and other things. So their older sister gave them these lessons.

(Without pencil.)

1. Which of these angles are right angles?
2. Which of them are smaller angles than a right angle?
3. Which of them are larger than a right angle?

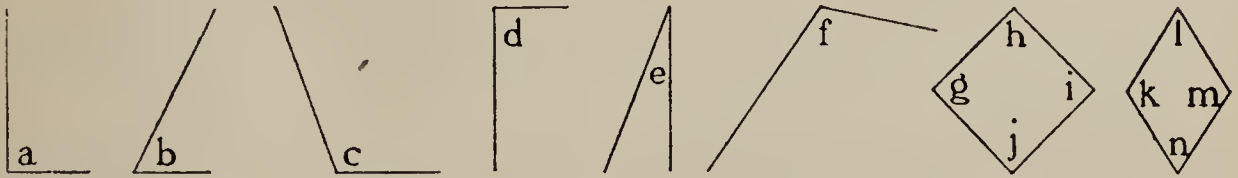

We measure angles in degrees. 1 right angle = 90 degrees or 90°

4. Which of these right angles is divided into halves?

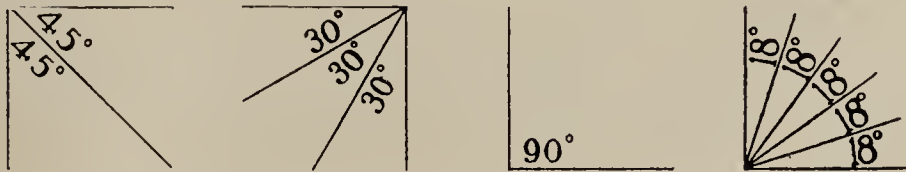

5. Which of these right angles is divided into thirds?
6. Which of these right angles is divided into fifths?
7. How many degrees = half a right angle?
8. How many degrees = $\frac{1}{3}$ of a right angle?
9. How many degrees = $\frac{1}{5}$ of a right angle?
10. Which of these lines makes an angle of about 10° with the dotted line?
11. Which makes an angle of about 70° with the dotted line?



12. Draw two lines making an angle of 90° . Mark the angle.
13. Draw two lines making an angle of 60° . Mark the angle.
14. Draw two lines making an angle of 20° . Mark the angle.

15. (a) Which of these angles is about 100° ?
 (b) Which is about 135° ?
 (c) Which is about 170° ?



16. Which spoke makes an angle of 45° with spoke A?
 17. Which spoke makes an angle of 135° with spoke A?
 18. Which spoke makes an angle of 90° with spoke A?
 19. Which spoke makes an angle of 180° with spoke A?

Spoke F makes an angle of 215° with spoke A counting in the direction A B C D E.

20. What angle does spoke G make with spoke A, counting in the direction A B C D E F?

*When the wheel turns all the way around once so that spoke A moves all the way around and back to its first position, the wheel makes one turn or one **revolution**.*

21. Using a foot rule as if it were the spoke of a wheel, show
 (a) one turn or revolution; (b) 2 turns or revolutions; (c) one half revolution or half turn; (d) a quarter revolution or quarter turn; (e) a turn of 45° ; (f) a turn of 90° ; (g) a turn of 180° ; (h) a turn of 225° ; (i) a turn of 360° or 4 right angles.

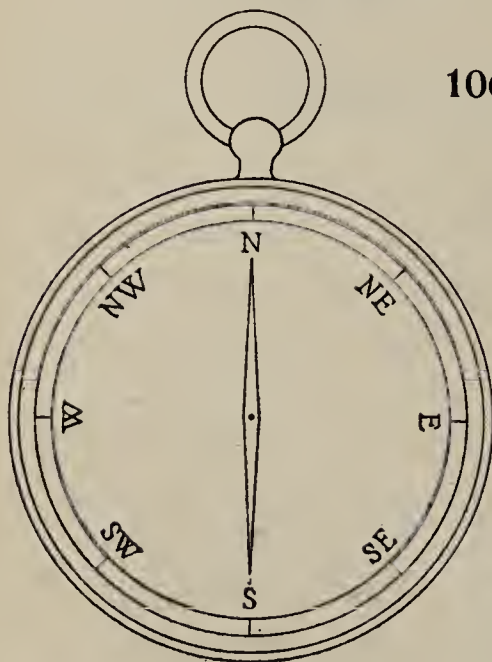

106. The Compass

Examine the picture of a compass, and the rough map on the opposite page.

1. Name something that is due north (exactly north) of the camp.
2. Name something that is due east (exactly east) of the camp.
3. Name something that is due south (exactly south) of the camp.
4. (a) Name something that is about 10° west of north. (b) Name something

that is about 50° east of north. (c) Something about 10° south of east. (d) Something about 30° south of east.



N means north, **E** means east, **S** means south, **W** means west.

Line *CA* runs from the camp in the direction 15° E. of N.

Line *CB* runs from the camp in the direction 40° W. of N.

Line *CD* runs from the camp in the direction 30° E. of S.

Line *CE* runs from the camp in the direction 5° E. of S.

5. How many degrees apart are lines *CA* and *CB*? Line *CA* and *CD*? *CA* and *CE*? *CB* and *CD*? *CB* and *CE*? *CD* and *CE*?
6. How many degrees east of north is a line that runs 10° N. of E.?
7. How many degrees west of north is a line that runs 12° N. of W.?

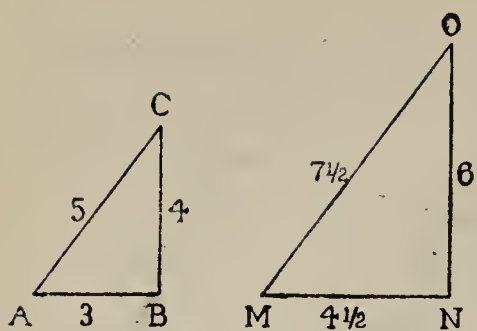

Triangles which are of exactly the same shape are called similar triangles. The lengths of corresponding lines in similar triangles are in the same proportions.

1. Supply the missing numbers:

Triangle *ABC* and triangle *MNO* are similar triangles; for line *MN* is . . . times as long as line *AB*; line *NO* is . . . as long as line *BC*; line *MO* is . . . as long as line *AC*. 3 and 4 and 5 are in the same proportion as . . . and . . . and . . .

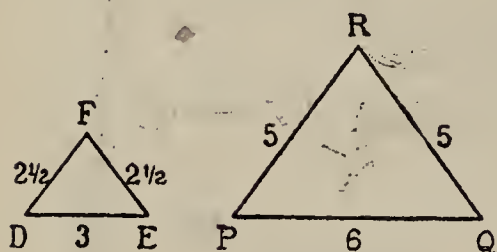

2. Which of these triangles are similar to triangle *ABC*?
3. Which of these triangles are similar to triangle *DEF*?
4. Which of these triangles is similar to triangle *GHI*?

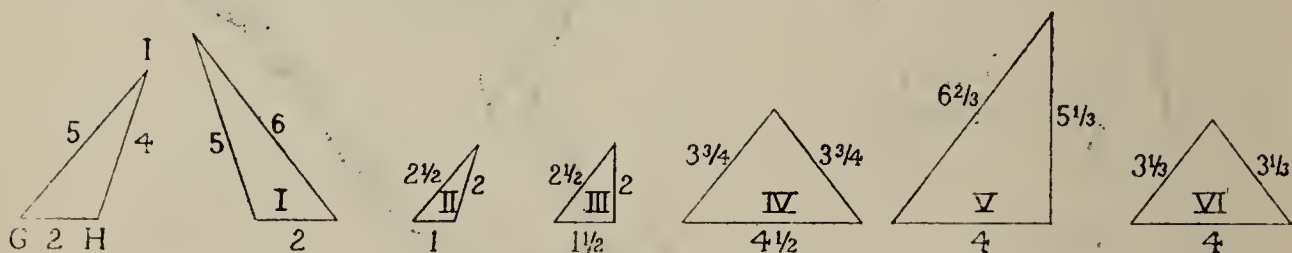

5. In which of these triangles are the lengths of the three sides in the proportions 1, $2\frac{1}{2}$, and 3?
6. In which are the lengths in the proportions 2, 4, and 5?
7. In which are the lengths of the three sides in the proportions 3, 4, and 5?

8. Hold a foot rule and a yard stick in the sunlight and compare the lengths of their shadows. Think of a way to find how tall this monument is without measuring it, when you know how tall the pole is and how long its shadow is.

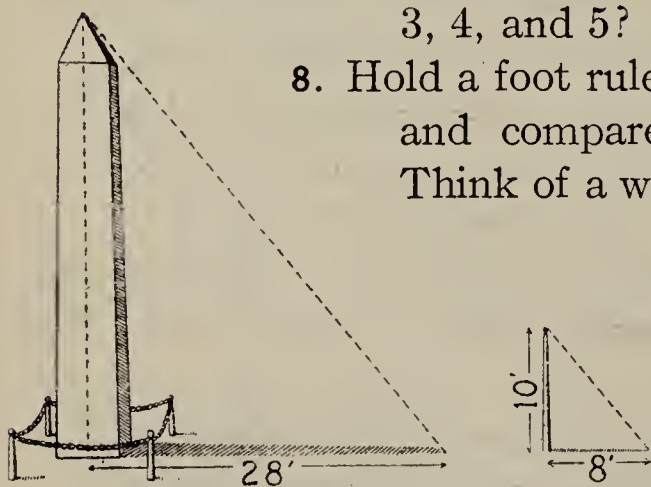

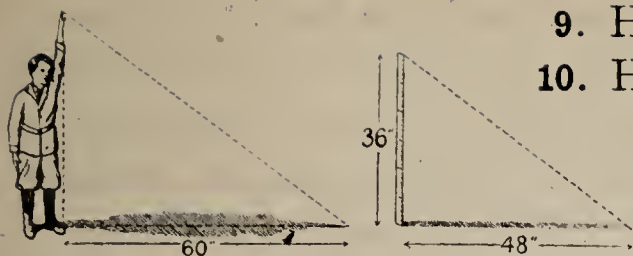

9. How high is the boy reaching?

10. How tall is a monument that casts a shadow 200 ft. long when a telegraph pole 28 ft. high casts a shadow 14 ft. long?

11. Edward's shadow is $\frac{2}{3}$ as long as Dick's shadow. How many times as long is Dick's shadow as Edward's shadow?

12. How many times as tall as Edward is Dick? (Make a drawing.)

13. Using paper ruled in $\frac{1}{4}$ -inch squares, draw one triangle the same as MNO and another triangle similar to MNO , but with sides twice as long.

14. Draw a triangle similar to MNO , but with sides $\frac{2}{3}$ as long.

15. Cut these triangles out. Compare the corresponding angles.

Complete this sentence: In similar triangles, the ... are proportional and the angles are ...

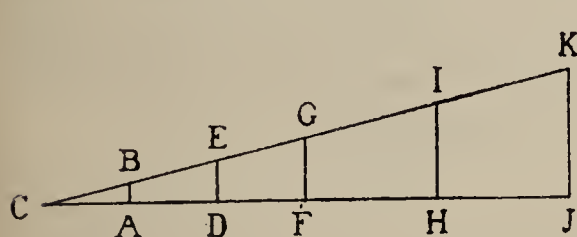

16. Tell the lengths of lines DE , FG , HI , and JK in this diagram. BA is 6"; $CA = 2'$; $CD = 4'$; $CF = 6'$; $CH = 9'$; $CJ = 12'$.

17. Suppose that the line CJ represents a horizontal line and that the line CK represents the slope of a road. What fraction of a foot does the road rise per foot of horizontal length?

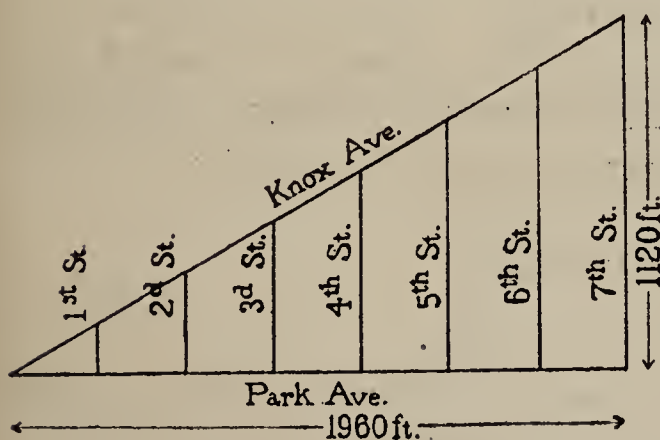

18. How far is it from Knox Ave. to Park Ave. at 3d St.? At 4th St.? At 6th St.? These streets are all parallel, so that the triangles formed by them with Knox Ave. and Park Ave. are all similar. 2d street is 280 ft. from 1st St., 3d St. is 280

ft. from 2d St., and so on. (Use pencil for any necessary computation.)

116 108. Estimating Heights by Similar Triangles

At the camp Fred and Dan measured the height of trees in this way: They made a triangle of two perfectly straight pieces of wood each 2 ft. long with a tin tube to look through for the long side. They made the BC piece of wood perpendicular to AC .

Frank would hold the triangle so that AC was exactly horizontal. Dan would look through the tube. They would find the place where they could just see the top of the tree through AB .

(Use pencil and paper for any drawing and computing that you need to do.)

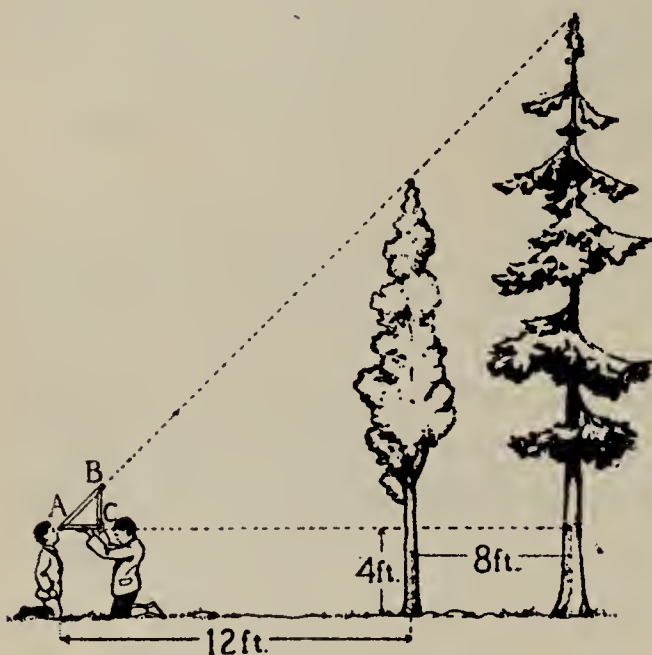

1. Study the picture and think out how this helped them to estimate the height of the trees.

2. How tall was the cedar tree?
3. How tall was the larger tree?
4. If convenient, use this method to estimate the heights of trees or buildings. What happens if you do not hold the triangle with its base exactly horizontal?
5. The real height of a house was 32 ft. Mary estimated it as 27 ft. Nell estimated it as 36 ft. Henry estimated it as 30 ft. (a) What was their average estimate? (b) How far was their average estimate from the real height?

109. Oral Review

1. How many degrees equal 4 right angles?
2. Through how many degrees does the minute hand of a clock turn (a) In 5 minutes? (b) In 25 min.? (c) In half an hour? (d) In one complete revolution?

3. How large an angle is there between two roads, one running 20 degrees east of north and one running 15 degrees east of south?
4. How large an angle is there between two adjacent spokes (i.e., between the center line of any spoke and the center

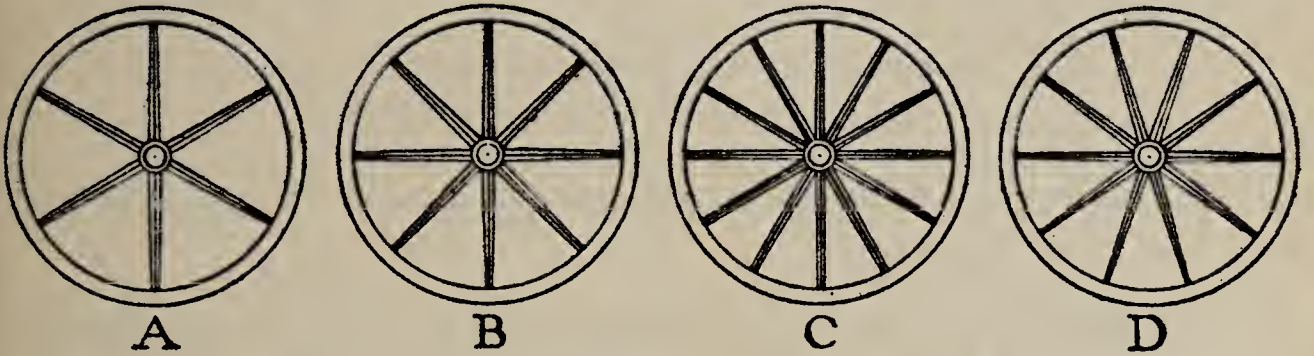

line of the next one to it) of wheel A? Of wheel B? Of wheel C? Of wheel D?

5. How many degrees equal (a) $\frac{1}{5}$ of a right angle? (b) $\frac{1}{6}$ of a right angle? (c) $\frac{1}{3}$ of a right angle? (d) $\frac{5}{6}$ of a right angle?
6. If a tree casts a shadow 95 ft. long when a stick 8 ft. high casts a shadow $9\frac{1}{2}$ ft. long, how high is the tree?
7. How tall will a tent be that is of the same proportions as this tent but is 6 ft. wider? Draw a diagram of it.

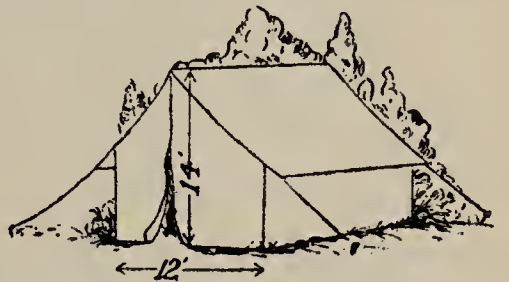

110. Equations

An equation is a statement that one quantity is equal to another quantity.

I. Supply the missing numbers to make these correct equations:

- | | |
|---|---|
| A. | B. |
| $(9 \times 12) = \dots$ | $12 + 18 + 6 = \dots \times 6$ |
| $\dots = (5 \times 15) - 20$ | $\dots \times 5 = \frac{1}{2} \text{ of } 70$ |
| $40 \text{ in.} = \dots \text{ ft. and } \dots \text{ in.}$ | $24 - 10 = \dots \times 7$ |
| $6\% \text{ of } \$200 = \dots$ | $\dots \times 7 = 42$ |
| $\dots = (2 \times 8) + (4 \times 5)$ | $\dots = 9 + 8 + (\frac{1}{4} \times 20)$ |

It is sometimes useful to state a problem as an equation and find the answer by finding the missing number.

For example, we may state this problem, "*John bought ten dozen rockets for 40¢ a dozen and sold them for 5¢ each. How much was his gain?*"

in this way:

$$\text{Gain} = (\text{what he received}) - (\text{what he paid})$$

$$\text{Gain} = (10 \times 12 \times 5¢) - (10 \times 40¢)$$

II. Express each of these problems as a written equation and find the missing number.

1. It is $8\frac{1}{2}$ miles from Dick's house to his uncle's farm. He rode there and back in 90 min. How many miles per hour did he travel?
2. A meter is 39.37 in. A kilometer equals 1000 meters. How many feet long is a kilometer?
3. From a piece of cloth $38\frac{1}{2}$ yd. long there are cut three pieces each $4\frac{1}{4}$ yd. long. How many yards are left?
4. Mr. Lane earns \$1200 per year and spends \$240 a year for rent and \$60 a year for fuel. What fraction of his earnings does he spend for rent and fuel together?
5. Mrs. Fisk estimates 30 minutes three times a day for cleaning up and washing the table dishes, and 7 hours per week for washing the cooking dishes. By her estimate how many hours does she spend per year in dish washing?

111.

Supply the missing words and signs in each of these equations:

If no reduction is made for buying a large quantity —

1. Cost per quart = (cost per bushel) \div ...
2. Cost per quart = (*total cost*) ... (number of quarts).
3. Cost per quart = $\frac{\text{cost per } \dots}{8}$

8

4. Cost for 20 articles = 20 ... (the cost per article).
5. Cost for 8 articles = 8 ... (the cost per article).

If we let n stand for the number of articles bought,

6. Cost for n articles = $n \dots$ (the... .. article).

In a RECTANGLE, area = $l \times w$.

7. Area in sq. in. = (length in in.) \times (...).

8. Perimeter in inches = $(2 \times \text{length in inches}) \dots (2 \times \text{width in inches})$ or

Perimeter = sum of the lengths of the four sides.

In a PARALLELOGRAM, area = $b \times a$.

9. Area in sq. in. = (base in inches) \dots (altitude in inches).

10. Perimeter = \dots of the lengths of the...

In a TRIANGLE,

11. Area in sq. in. = (base in inches) $\dots \frac{1}{2}$ (... in inches).

12. Perimeter = sum of \dots of \dots

13. Distance traveled in miles = (time in hours) \dots (miles per hour).

14. Time required in hours = (distance traveled in miles) \dots (miles per hour).

If we remember to use hours, minutes, and seconds, and miles, rods, yards, and feet correctly, we may think:

15. Distance = time \dots rate of motion.

16. Time = distance \dots rate of motion.

17. Rate of motion = distance \dots time.

18. Money remaining = (money had at first) \dots (money spent).

19. Net price = (list price) \dots (amount of discount).

20. Amount of discount = (rate of discount in hundredths) \dots list price.

21. Number of dollars to be paid as interest = (interest on 1 dollar) \dots (number of dollars borrowed), or

22. Number of dollars to be paid as interest = (rate of interest) \times (time in years) \dots (number of dollars borrowed).

23. Profit from selling = (money received from sales) \dots (money spent for goods + money spent for expenses).

24. Rate of interest = (number of dollars paid as interest) \dots (number of dollars borrowed).

To save time, we may use a letter, like x or y or z , for “the number of dollars” or “the number of square feet of area” or “the sum of money paid as interest” or “the percent which the cost price was of the selling price.”

1. Read these equations. Read the right number where x or ... is.

Take time to be sure that you know what to say in place of x or ...

- | | |
|---|---|
| I. ... = $\frac{2}{3}$ of 24. | X. $x + 7 = 2 \times 9$. |
| II. $x = \frac{3}{4}$ of 12. | XI. ... = $\frac{9 \times 6 \times 4}{30}$ |
| III. $4 \times 9 = 30 + x$. | XII. $x = \frac{3 \times 3 \times 10}{45}$ |
| IV. $7 \times 9 = \dots + 3$. | XIII. $\frac{1}{2}$ of ... = 7. |
| V. $10 + x = 2 \times 6$. | XIV. $\frac{1}{3}$ of $x = 8$. |
| VI. ... + 10 = 4×8 . | XV. ... - 4 = 30. |
| VII. $\$x = 12\%$ of \$50. | XVI. $x - 20 = 5$. |
| VIII. $\$8 = \dots\%$ of \$200. | XVII. $x = (\frac{10}{2} + \frac{12}{3})$. |
| IX. $8 (7 \text{ ft.} + 4 \text{ ft.}) = x \text{ ft.}$ | XVIII. $4 \times x = 12 + 8$. |

2. Examine equations I to XVIII again and tell the right number for x or the dotted space. Say, “In equation I, the missing number is 16; in equation II, $x = 9$; in equation III, $x = 6$,” etc.

3. Read these equations, supplying the right numbers and words in place of x or ...:

- | | |
|--|---|
| a. $5 = \dots \times 2$. | m. $\$100 - x = \85 . |
| b. $12 = x \times 3$. | n. $\$30 + x = \36 . |
| c. ... = 40 qt. $\div 5$. | o. $16 = \frac{1}{2}$ of ... |
| d. $x = 9 \times 1\frac{1}{2}$ yd. | p. $8 = \frac{1}{3}$ of x . |
| e. $x = (2 \times 30 \text{ ft.}) + (2 \times 20 \text{ ft.})$ | q. $\frac{1}{4}$ of $x = 2 \text{ ft.}$ |
| f. ... = $(30 \div 3) + (60 \div 12)$. | r. $3 \times \dots = 24$. |
| g. $8 + \dots = (3 \times 7)$. | s. $4 \times x = 36 \text{ min.}$ |
| h. $20 + x = (6 \times 8)$. | t. $\frac{1}{2}$ of ... = 4×6 . |
| i. $\$18 = \dots\%$ of \$300. | u. 20% of \$60 = $3 \times x$. |
| j. $\$20 = x\%$ of \$400. | v. $\frac{16 \times 8 \times 9}{2 \times 8 \times 3} = x$. |
| k. $\$8 = 4\%$ of ... | w. $x = 1\frac{1}{2} \text{ hr.} + 40 \text{ min.}$ |
| l. $24 = 4\%$ of x . | |

Let x = the area of a rectangle expressed in square feet.

Let l = the length of the rectangle expressed in feet.

Let w = the width of the rectangle expressed in feet.

$$\text{Then } x = l \times w$$

1. What is the value of x (that is, the number of square feet)
 (a) When $l = 8$ and $w = 5$? (b) When $l = 11$ and $w = 9$? (c) When $l = 12$ and $w = 10$?

Let y = the number of miles a train moves per hour.

Let d = the total distance (in miles) the train goes.

Let t = the total time (in hours) the train is in motion while going that distance.

2. What is the value of y (a) When $d = 200$ and $t = 5$?
 (b) When $d = 270$ and $t = 9$? (c) When $d = 105$ and $t = 3$?
 3. Which of these are correct equations?

$$y = d \times t \quad y = d + t \quad y = d \div t \quad y = d - t$$

$$y = \frac{d}{t} \quad y = 2d + 3t \quad y \times d = t \quad y \times t = d$$

$$d \div y = t \quad \frac{d}{y} = t \quad y \times t = d \quad t \div y = d$$

The sum of the three angles of any triangle is 180 degrees.

Let a equal the number of degrees in one angle of a triangle.

Let b equal the number of degrees in the second angle of that triangle.

Let z equal the number of degrees in the third angle of that triangle.

Then

$$z + a + b = 180^\circ$$

and

$$z = 180^\circ - (a + b)$$

4. What is the value of z in each of these triangles?

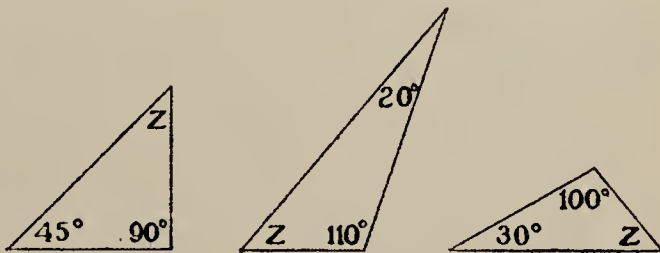

5. Express this rule, "The area of a triangle = ($\frac{1}{2}$ the altitude) \times (base)" in an equation, letting

x = the area of a triangle in square inches.

a = the altitude of that triangle in inches.

b = the base of that triangle in inches.

6. Supply the missing words and express this rule in an equation:

$$\text{Interest} = \text{Principal} \times \text{Rate} \times \text{Time.}$$

(“Principal” means the number of dollars borrowed.)

Let y = the number of dollars paid for interest.

Let p =

Let r =

Let t =

7. What is the value of y , when $p = \$200$, $r = 6\%$ or $.06$, and $t = 3$ years?

114. Written Practice

Let w = the regular weekly salary of a salesman in dollars.

Let c = the rate of his commission on sales.

Let s = the total sum of his sales for the year in dollars.

Let e = his total earnings for the year in dollars.

- Write an equation to use in computing e .
- What is e if $w = 12$, $c = 7\frac{1}{2}\%$, and $s = 8950$?
- What is e if $w = 15$, $c = 10\frac{1}{2}\%$, and $s = 12,740$?
- What is c if $e = 1156$, $w = 10$, and $s = 10,600$?
- What is w if $e = 1346.40$, $c = 2\%$, and $s = 15,320$?
- Why is $e = (52 \times w) + (c \times s)$ a better way to write the equation than $e = 52 \times w + c \times s$?

In writing equations and replacing the letters in an equation, use parentheses when necessary to show what operations are to be performed.

To show that the sum of 29 and 15 is to be subtracted from 149, write $149 - (\quad)$, putting $29 + 15$ inside the parentheses.

To show that the product of 13×108 is to be added to the product of $.04 \times 16,000$, write $(.04 \times 16,000) + (13 \times 108)$.

- What do you write for $x = a + b + c$ when $a = (19 \times 40)$, $b = 760 \div 4$, and $c = 286 - 197$?
- What do you write for $x = d \times g$ when $d = 46 + 87$ and $g = 725 - 286$?
- What do you write for $y = d \div t$ when $d = 98 + 110 + 64$ and $t = 2\frac{1}{2} + 2\frac{3}{4} + 1\frac{3}{4}$?

Solve these problems. Read each problem carefully until you know what it means, what the question to be answered is, what numbers you are to use, and what you are to do with them. Then do the work. Use any method that gives the right result and is convenient. Examine each result and make sure that it is correct.

1. Lucy is shopping. It is 10 minutes of 4. Lucy's train goes at quarter past 5. It will take her 8 min. to walk to the station, and she has promised to do an errand that will require 20 minutes. How much longer may she shop?
2. It is 7 o'clock. Bedtime is at 8:30. If Kate plays two games of crokinole taking 10 minutes each, and studies her geography lesson for half an hour, how much time will she have left to read before bedtime?
3. In the Jefferson School all children who have been in attendance 95% of the sessions or more receive an honor card. There are 400 sessions. From the beginning of school in September to the first Monday in May, Anna had been absent 15 sessions. (a) How many more sessions may she be absent and still receive an honor card for the year?
(b) Answer the same question for each of these girls:
Bertha, who had been absent 18.
Ellen, who had been absent 11.
Norah, who had been absent 14.
(c) Find what percent of the sessions each of these girls will be absent for the year if each of them is absent 2 sessions in May and 3 sessions in June.
4. Dick stayed under water for $3\frac{4}{5}$ seconds. Fred stayed under water for $5\frac{3}{5}$ sec. Fred claimed that he stayed under water $1\frac{1}{2}$ times as long as Dick. Was he right or wrong? Prove that your answer is correct.
5. The Pittsburg team has won 37 games and lost 18. How many must it win out of the next 25 games to make its percent of games won 75?

Lucy kept this record of the number of eggs she obtained each month from 50 hens:

Jan. 361	Apr. 962	July 702	Oct. 92
Feb. 390	May 938	Aug. 426	Nov. 126
Mar. 674	June 845	Sept. 315	Dec. 271

1. What was the average number per month for the 50 hens?
2. What percent was the lowest month's record of the average month's record?
3. What was the average number of eggs per year per hen?
4. One hen (No. 26A) produced 245 eggs in the year. This was . . . percent more than the average hen produced.
5. At an average of $21\frac{1}{2}\text{¢}$ per dozen, what will Lucy's receipts be for the year from the sale of the eggs?
6. Counting her expenses at \$86.80 and her labor at 2 hours a day, how much did she receive per hour for her labor?
7. (a) What percent of a 1:2:3 mixture of cement, sand, and gravel is cement? (b) What % is sand?
8. Answer the same questions for a 1:2:4 mixture.
9. Answer the same questions for a 1:3:5 mixture.
10. Answer the same questions for a 1:1½:3 mixture.
11. To make 1 cu. yd. of concrete of a 1:2:3 mixture, builders use 1.74 bbl. cement, .52 cu. yd. sand, and .77 cu. yd. gravel. How much of each will be required for a concrete pier 10 ft. by 6 ft. by 20 ft.?

A good mixture of foods for a cow consists of

Cowpea hay	15 lb.
Corn stover	10 lb.
Corn ensilage	30 lb.
Cottonseed meal	2 lb.

12. (a) What percent of the mixture is cowpea hay? (b) What percent is corn stover? (c) What percent is corn ensilage?
13. Mr. Drake uses a mixture of 100 lb. hay, 65 lb. corn stover, 200 lb. corn ensilage, and 20 lb. cottonseed meal. Is the percent of ensilage larger or smaller in his mixture than in the 15:10:30:2 mixture?

(Mental work.)

1. How much did the customer suggest that he could afford to pay or wished to pay in each of these cases? Check your results for *c* and *d*.
 - a. The salesman showed an overcoat for \$30. The customer said, "I cannot pay more than $\frac{2}{3}$ as much as that."
 - b. The salesman showed a suit for \$25. The customer said, "That is \$5 more than I wish to pay."
 - c. The salesman showed velvet at \$2 per yard. The customer said, "That is a third more than I wish to pay."
 - d. The salesman showed a dress at \$25. The customer said, "That is 25% higher than the price I can afford to pay."
 - e. The salesman showed a motorcycle at \$75. The customer said, "Show me something 20 percent cheaper."

(Written work.)

2. (a) Which is greater, a single discount of 40% or a discount of 25%, 15%?
 - (b) How much does the difference amount to on \$100 worth of goods?
 - (c) How much does the difference amount to on \$800 worth of goods? (Solve by an easy way.)
3. An agent sold a 160-acre farm for \$225 per acre. What was his commission at the rate of $2\frac{1}{2}\%$ on \$32,000 and 15% on anything over \$32,000?
4. How many dollars' worth must a salesman sell per year to earn \$1200, if his commission is $2\frac{1}{2}\%$?
5. Mr. Dean pays \$35 every 3 years for insurance on his house, \$60 every 3 years for insurance on the building his store is in, and pays at the rate of \$1.15 per year per \$100 on stock valued at \$12,000. How much does he pay in all per year for insurance?
6. Which costs more, an article whose catalogue price is \$36 less a discount of 40% sent freight prepaid, or an article sold at \$20.89 with no discount and freight charges of \$1.20? How much more?

7. A man owes \$6000. He pays interest semiannually at 5% on \$2500, at $5\frac{1}{2}\%$ on \$2000, and at 6% on the remainder. How much does he have to pay in all as interest every six months?
8. On Jan. 1, Mr. Roberts borrows \$2400, one third of it for 3 months, one third of it for 6 months, and one third of it for a year. Interest is at 5% on the first note, $5\frac{1}{2}\%$ on the second, and 6% on the third. How much must he pay on Apr. 1? On July 1? On Jan. 1 of the next year?
9. On Mar. 1, Grace buys a piano for \$250, paying \$50 cash and \$20 at the end of each month with interest at 6%. How much must she pay at the end of March? At the end of April? At the end of May?
10. Which will amount to more when he is 21 years old, \$100 which Fred saved and put in the savings bank when he was 14, or \$120 which he saved and put in when he was 19? Interest is at 4% per year and is added to the principal every 6 months. Prove that your answer is right. Try to find it and prove it with very little multiplying.
11. A man owns a house which is valued at \$3500. He pays $1\frac{3}{4}\%$ of its value each year as a tax to the city, \$2.75 per \$100 every three years for insurance. His bills for painting, papering, repair, etc., for the last 5 years amount to \$496. Counting in also interest on \$3500 at 5%, what does it cost per year for his house?
12. Louise wishes to buy a violin that costs \$60. She earns \$9 a week in an office and \$3 every Sunday by singing. She has saved \$12. How many weeks will it take her to save enough more to pay for the violin (a) If she saves 20% of her earnings? (b) If she saves 25% of her earnings? (c) If she saves $33\frac{1}{3}\%$ of her earnings?
13. The receipts from the church fair were \$472.40. They were divided among the building fund, the music fund, and the library fund in these proportions: 5, 3, and 1. How much money did each fund receive?

(Use pencil when you need to.)

1. A can $6'' \times 6'' \times 9''$ weighs 1 lb. 10 oz. When filled with soil that seemed dry it weighed 22 lb. 2 oz. What was the weight of the soil?
2. What would a cubic foot of the same soil weigh?
3. When the can full of soil was really dry by baking, it weighed only 19 lb. 10 oz. What was the weight of the soil when dry?
4. How many pounds of moisture did the soil lose by being baked?
15 carats fine means that of $\frac{15}{24}$ the article is pure gold.
16 carats fine means that $\frac{16}{24}$ of the article is pure gold.
17 carats fine means that $\frac{17}{24}$ of the article is pure gold, etc.
5. How much pure gold is there in a chain that weighs 4 oz. and is 18 carats fine?
6. What percent of an 18-carat article is pure gold?
7. What percent of an 12-carat article is pure gold?
8. How many tons of hay will a space 40 ft. \times 20 ft. \times 10 ft. hold, counting 400 cu. ft. per ton?
9. How much coal is used per hour by a boat that uses 133.4 tons on a 48-hour trip?
10. 2 teams require 12 days in hauling 300 tons of coal from the railroad to Fisher's factory. How many days should it take 8 teams to haul 300 tons of coal from the railroad to the factory?
11. An enlarged photograph is made of this plan, changing the total length from 2 in. to 3 in. and the total width from $1\frac{1}{2}$ in. to $2\frac{1}{4}$ in. What fraction of an inch will represent 50 ft. on the enlarged plan? What will represent the length of the tennis court? What does $\frac{1}{4}$ in. represent on the enlarged plan?

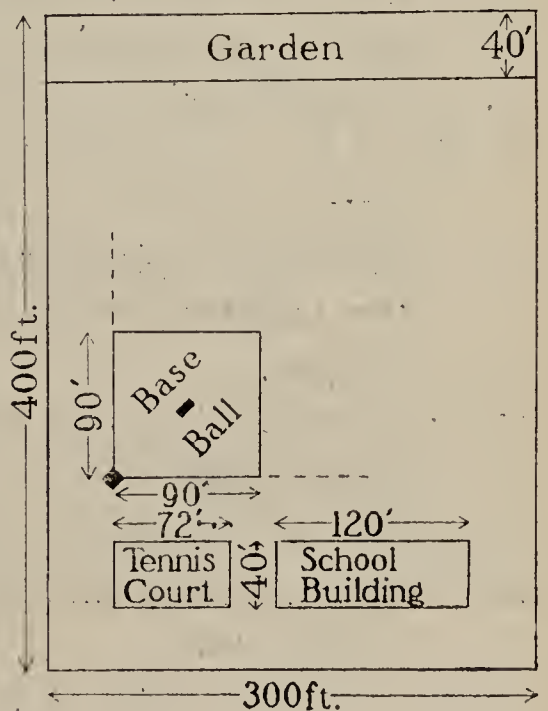

12. Which of these houses has more floor space on the first floor?
How much more?

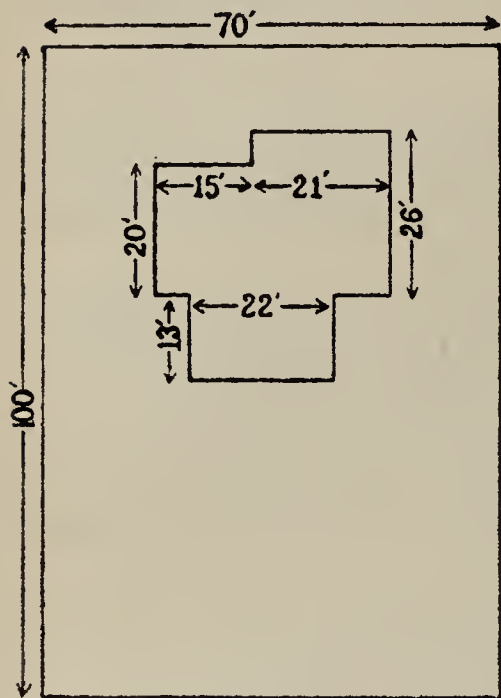

A

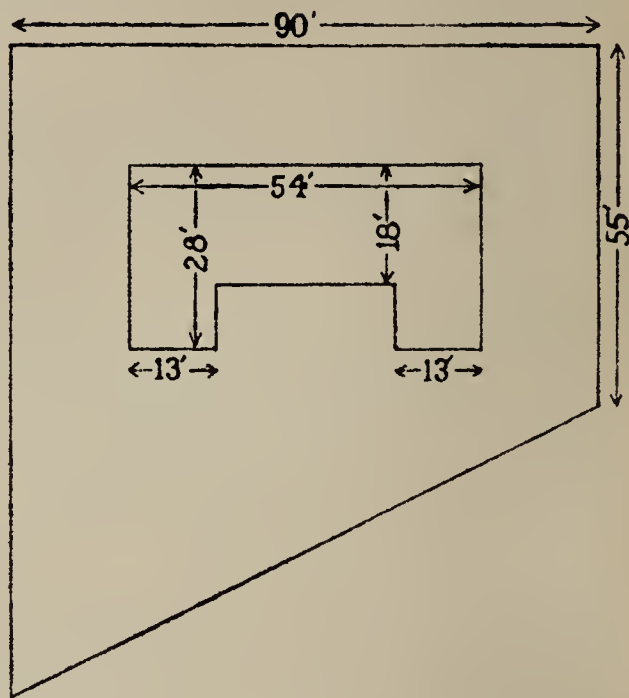

B

13. Which of these lots is larger? How much larger?
14. One of the steepest railroads in the world goes up 5400 ft. in 15,150 ft. of track. (a) How many feet does it go up on the average in every mile of track?
(b) The train on it goes 3 ft. a second. How long does it take to make the trip?
15. Compare the speed of this train with that of a regular train going 30 miles an hour.
16. At 10 A.M. a messenger on a horse going 16 ft. per second starts after a regiment of soldiers marching at 4.3 ft. per second who left the place at 9:20 A.M. Will the messenger overtake the soldiers before 10:20 A.M.? Prove that your answer is right.
17. How much does one square inch represent on a map drawn to this scale?
0-----20-----40-----60-----80 mi. 1 in. = 80 mi.
18. How much does one square inch represent on a map drawn to this scale?
0-----5-----10 mi. 1 in. = 10 mi.

ARITHMETIC

BOOK THREE, PART TWO

In this part, directions will not be given about what is to be done in writing and what is to be done without writing. Unless the teacher gives special directions, use your judgment, choosing the method that is best for accuracy, economy of time, and improvement in arithmetic.

1. Camping

1. Mr. Howard took John with him on a camping trip. They bought a tent for \$9.15, a fly to put over it for \$4.30, and poles and stakes for \$1.25. What was the total cost?
2. The floor space of the tent is 7 ft. by 7 ft. How much will a ground cloth for it cost at 7¢ per sq. ft.?
3. (a) They went on a train 367 miles, taking from 9 A.M. to 10 P.M. How many miles per hour did they go while on the train?
(b) The next morning they went in a canoe 13 miles to the first carry. This took them 4 hours. How many miles per hour did they go while in the canoe?
4. They planned to buy provisions for 12 days. They expected to use: 3.2 lb. flour per day, 1.16 lb. bacon per day, .18 lb. coffee per day, .075 lb. salt per day, and .225 lb. sugar per day.
How much would the supply of flour for 12 days weigh?
5. They had 40 lb. flour. How much more was this than they expected to use?
6. How much would (a) the bacon for 12 days weigh? (b) The coffee for 12 days? (c) The sugar for 12 days?
7. They took 15 lb. bacon, $2\frac{1}{2}$ lb. coffee, 1 lb. salt, and 3 lb. sugar. How much more of each did they take than they expected to use?

2. Home Problems

1. (a) State what quantities to use to make twice as much as these recipes make. (b) Tell what quantities to use to make half as much as these recipes. (c) To make $1\frac{1}{2}$ times as much.

Russell Buns

$1\frac{1}{4}$ cups scalded milk
 1 yeast cake
 $\frac{1}{4}$ cup lukewarm water
 $3\frac{3}{4}$ cups flour
 $\frac{1}{2}$ cup sugar
 1 teaspoon cinnamon
 1 teaspoon salt
 2 eggs
 1 tablespoon butter
 1 tablespoon lard
 $\frac{1}{2}$ cup currants

Cheese Biscuits

1 cup bread flour
 $2\frac{1}{2}$ teaspoons baking powder
 $\frac{1}{2}$ teaspoon salt
 $1\frac{1}{2}$ tablespoon butter
 $\frac{3}{8}$ cup milk and water
 $\frac{1}{2}$ cup grated cheese

Cream Bread Fingers

$\frac{1}{2}$ cup of heavy cream
 2 tablespoons sugar
 $\frac{1}{4}$ tablespoon salt
 1 yeast cake
 $\frac{1}{4}$ cup lukewarm water
 $1\frac{1}{2}$ cups flour

2. How much vinegar do you use with 6 tablespoons of oil in making salad dressing, when the recipe tells you to "Use 2 parts of oil to 1 part of vinegar"?
3. The regular price of B. and N. velvet is \$2 per yard. A remnant $\frac{3}{4}$ of a yard long is offered at 90¢. What percent reduction is made?
4. At 80¢ per bushel, what quantity will be a dollar's worth?
5. At 15¢ per lb., what quantity will be 50 cents' worth?
6. A boy does $\frac{2}{3}$ of a job in 8 hours. How long should it take him to finish it?
7. How many times as long will it take to save \$100 if you save 40¢ a week as it will take if you save \$1 a week?
8. A baseball team played 12 games. The team won 6 games and lost 4 games. 2 were tie games. What fraction of the games did the team win? What fraction did it lose? What fraction were tie games?
9. A chimney casts a shadow 120 ft. long when a post 4 ft. high casts a shadow 6 ft. long. How tall is the chimney?

Begin with **Step 1**. Climb to the top without making a mistake. Be sure to copy the numbers correctly. Express any common fractions or mixed numbers in your results in lowest terms.

Step 8. a. Subtract 15% of \$74.25 and $33\frac{1}{3}\%$ of \$81.50 from \$100.

b. Subtract 18% of \$19.60 from \$19.60.

c. Subtract 30% of \$3.75 from \$3.75 and subtract 10% from the remainder.

d. Subtract $6 \times \$9.75$ from the sum of \$14.62 and \$68.49.

e. How much must be added to $269\frac{1}{2}$ qt. to make 80 gal.?

Step 7. a. $4\frac{3}{4}$ mi. — 2.68 mi. b. 6.83 ft. — 4 ft. 9 in.

c. 4 sq. mi. — 1000 acres. d. 10.4 sq. yd. — 16.5 sq. ft. e. $31\frac{1}{2}$ gal. — 19.63 gal.

Step 6. a. $15\frac{1}{12}$ b. $5\frac{1}{4}$ c. $8\frac{7}{16}$ d. $6\frac{1}{3}$ e. $9\frac{5}{12}$
 $10\frac{3}{4}$ $2\frac{1}{3}$ $6\frac{5}{8}$ $3\frac{3}{4}$ $4\frac{1}{4}$

Step 5. a. $38\frac{1}{4}$ b. $30\frac{1}{2}$ c. $20\frac{1}{3}$ d. $37\frac{3}{8}$ e. $18\frac{1}{2}$
 $15\frac{5}{8}$ $14\frac{7}{8}$ $15\frac{1}{2}$ $19\frac{3}{4}$ $16\frac{3}{8}$

Step 4. a. $51\frac{3}{5}$ b. $10\frac{11}{12}$ c. $6\frac{1}{3}$ d. $5\frac{5}{16}$ e. $13\frac{1}{8}$
 $49\frac{1}{5}$ $8\frac{5}{12}$ $2\frac{2}{3}$ $2\frac{7}{16}$ $9\frac{5}{8}$

Step 3. a. How much longer is 5 hr. than 3 hr. 28 min.?
 b. How much longer is $2\frac{1}{4}$ hr. than 1 hr. 30 min.?
 c. How much heavier is 1 lb. 7 oz. than 14 oz.?
 d. How much heavier is 2 lb. 1 oz. than 1 lb. 2 oz.?
 e. How much more is 1 cu. yd. than 5 cu. ft.?

Step 2. a. 82 mi. — 75.16 mi. b. 9624 — 6578. c. \$4 — $66\frac{2}{3}\text{¢}$
 d. 38.8 sq. mi. — 28.08 sq. mi. e. \$709.20 — \$309.73

Step 1. a. \$30.00 b. \$50.00 c. \$100.00 d. 6125 ft. e. 6275
 8.28 14.76 91.53 3495 ft. 3987

4. An Average Ladder

Find the average of the quantities on each line. Begin with **Step 1**. Climb to the top without making a mistake. Be sure to copy the numbers correctly. Extend the division to two decimal places if necessary.

- Step 6.** a. $2\frac{2}{3}$, $1\frac{7}{8}$, $2\frac{3}{4}$, $4\frac{1}{4}$, $3\frac{5}{8}$, $3\frac{1}{2}$
 b. $62\frac{1}{2}\text{¢}$, $66\frac{2}{3}\text{¢}$, 40¢ , $83\frac{1}{3}\text{¢}$, $\$1.75$, $\$2.25$
 c. $3\frac{11}{16}$, $3\frac{9}{32}$, $3\frac{3}{8}$, $3\frac{17}{32}$, $3\frac{7}{16}$
 d. $.17$, $.19$, $.16\frac{2}{3}$, $.15\frac{1}{2}$, $.23\frac{1}{4}$, $.18$

- Step 5.** a. 5 ft. $3\frac{1}{2}$ in., $61\frac{1}{4}$ in., $58\frac{3}{4}$ in., 4 ft. 11 in.
 b. 6 lb. 9 oz., 6 lb. 11 oz., $7\frac{1}{4}$ lb., $7\frac{3}{8}$ lb.
 c. 1 hr. 4 min. 40 sec., 58 min. 35 sec., $1\frac{1}{4}$ hr.
 d. 2.8 miles, $3\frac{1}{2}$ miles, 2.72 miles.

- Step 4.** a. $.03\frac{1}{2}$, $.06$, $.04\frac{3}{4}$, $.05\frac{1}{2}$, $.05\frac{1}{4}$
 b. $.043$, $.045$, $.049$, $.047$, $.046$, $.045$
 c. 2.20 , $.87\frac{1}{2}$, 1.18 , $.93\frac{3}{4}$, 1.2925 , $.80$
 d. $.14\frac{1}{2}$, $.12\frac{1}{2}$, $.33\frac{1}{3}$, $.16\frac{2}{3}$, $.15$, $.17$

- Step 3.** a. $5\frac{1}{4}$, $4\frac{1}{2}$, $8\frac{3}{8}$, $7\frac{3}{4}$, $6\frac{5}{8}$, $9\frac{3}{8}$
 b. $9\frac{5}{8}$, 12 , $8\frac{1}{2}$, $8\frac{3}{4}$, 6 , $5\frac{1}{4}$, 9
 c. $9\frac{3}{8}$, $5\frac{3}{4}$, $4\frac{1}{8}$, $7\frac{1}{2}$, 6
 d. 11 , $9\frac{1}{2}$, $10\frac{1}{3}$, 13 , $16\frac{2}{3}$, $9\frac{1}{2}$

- Step 2.** a. 13.05 , $.97$, 4.8 , 10.625 , 3.37
 b. 1.48 , 7.02 , $.93$, 5.307 , 4.1 , 7 , 10.4
 c. 68 , 71.4 , 59.8 , 112 , 96.1 , 79.8
 d. 2.079 , 3.908 , 4.165 , 2.74

- Step 1.** a. 4 , $9\frac{1}{2}$, 6 , 5 , $7\frac{1}{2}$, 8 , 10 , 9
 b. 6 , 5 , 3.9 , 7.1 , 8
 c. 1086 , 1141 , 1059 , 1302 , 1284
 d. $\$100.82$, $\$206.49$, $\$317.25$, $\$244.73$

- State what it costs for one thing when you get —

2 for 5¢	7 for 25¢	4 for 25¢	6 for a cent
3 for 10¢	8 for 25¢	7 for 10¢	7 for a cent
4 for 15¢	3 for 25¢	3 for 50¢	8 for a cent
6 for 25¢	2 for 25¢	7 for 50¢	9 for a cent
- A seventh of a cent or an eighth of a cent or a ninth of a cent may seem too small to care about. But suppose some one gave you $\frac{1}{9}$ of a cent each second. How much would you get in 9 seconds? How much would you get in 90 sec. or $1\frac{1}{2}$ min.? In 3 min.? In 30 min.? In an hour?
- Some of the men who make the most money get only $\frac{1}{8}$ of a cent for every dollar's worth of goods they sell. How many dollars' worth do they have to sell to make one cent? To make 10 cents? To make a dollar? To make a hundred dollars?
- Suppose you pulled weeds out of a garden at the rate of 14 weeds a minute. If you were paid $\frac{1}{7}$ cent for each weed, how much would you make in a minute? In an hour?
- State the missing numbers:

A.	B.	C.	D.
$\frac{1}{7}$ of 42 =	$\frac{1}{9} \times 45 =$	$\frac{3}{7} \times 20 =$	$\frac{1}{9} \times 30 =$
$\frac{1}{7}$ of 45 =	$\frac{1}{9} \times 50 =$	$\frac{4}{9} \times 15 =$	$\frac{5}{7} \times 40 =$
$\frac{1}{7}$ of 25 =	$\frac{2}{9} \times 50 =$	$\frac{5}{9} \times 100 =$	$\frac{3}{7} \times 100 =$

6. An Angle, Area, Volume Test

Begin with **Step 1**. See how much you can do in 30 minutes, without making a mistake. Express any common fractions or mixed numbers in your results in lowest terms.

Step 1. Find the number of degrees in the upper angle of each of these triangles. Remember that the sum of the three angles of a triangle = 180° .

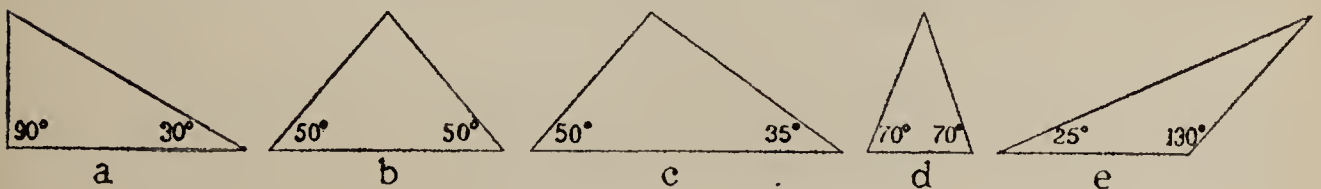

Step 2. Find the area

- Of a rectangle 3.2 in. by 10.4 in.
- Of a rectangle 3.58 ft. by 16.5 ft.
- Of a rectangle 6 ft. by 4.19 ft.
- Of a rectangle 7.4 mi. by 2.63 mi.
- Of a rectangle 2 yd. 9 in. by 3 yd. 4 in.

Step 3. Find the areas of these triangles. (Remember that the area of a triangle = $\frac{1}{2}$ altitude \times base.) The numbers on the dimension lines stand for miles.

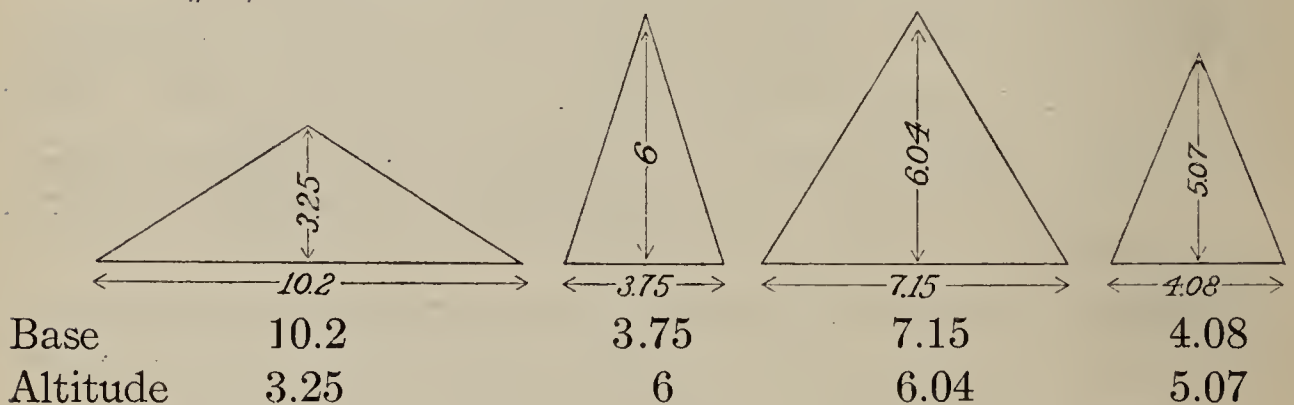

Step 4. Find the volume in cubic feet of each of these boxes:

- Box A is $3\frac{1}{2}' \times 4\frac{1}{2}' \times 5'$ Box B is $2.4' \times 4.9' \times 2.1'$
 Box C is $2\frac{3}{4}' \times 4\frac{1}{2}' \times 1\frac{1}{2}'$ Box D is $\frac{3}{4}' \times \frac{3}{4}' \times \frac{3}{4}'$
 Box E is $2\frac{2}{3}' \times 2\frac{1}{4}' \times 2\frac{1}{2}'$

Step 5. Find the areas of these surfaces:

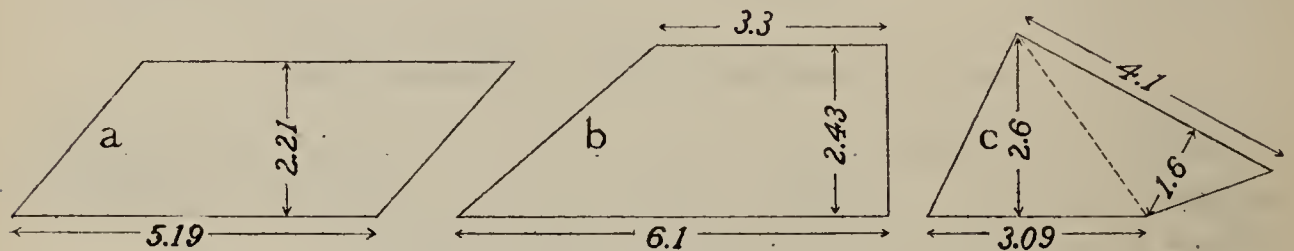

Step 6. Through how many degrees does the hour hand of a clock turn (a) In 3 hrs.?

(b) In $4\frac{1}{2}$ hrs.? (c) In 15 min.?

(d) How many degrees apart are line x and line y ?

(e) How many degrees apart are line y and line u ?

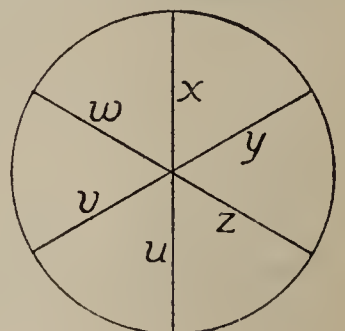

See how quickly you can give the right number for q or r or s or t or u or w or x or y or . . . in these equations. Practice until you can state all correctly in 3 minutes. Use pencil at first if you need to.

$2x$ means $2 \times x$

$7q = 7 \times q$

$3w = 3 \times w$, etc.

If $2x = 18$, $x = 9$

If $7q = 49$, $q = 7$

If $3w = 18$, $w = 6$

A.	B.	C.	D.
$q = 3\frac{2}{3} + 2\frac{1}{3}$	$7q = 49$	$3q = 21$	$6r = 54$
$x = 4\%$ of \$75	$z = \frac{1}{5}$ of $2\frac{1}{2}$	$w = 3\%$ of \$25	$7 + w = 25$
$x = \frac{2}{3}$ of \$4.50	$20 - x = 14$	$7 \times x = 42$	$64 \div t = 8$
$9 + y = 16$	$72 = \dots\%$ of 200	$18 = 2\%$ of y	$x \times 7 = 77$
$z + 8 = 20$	$u - 15 = 20$	$18 \div \dots = 3$	$x + 1\frac{1}{4} = 2$
$p = 6\%$ of \$4000	$x + 25 = 100$	$60 = y \times 15$	$z \div 5 = 9$
$24 = x\%$ of 60	$s = 4\frac{1}{4}\%$ of \$60	$q = 1\frac{1}{2} + 3\frac{1}{4}$	$19 = u + 4$
$12 \times \dots = 96$	$20 = x + 4$	$p = \frac{5}{8}$ of \$200	$7x = 28$
$\dots = \frac{3}{8}$ of \$400	$32 = q + 12$	$8 = z \div 6$	$9z = 63$
$3w = 18$	$5t = 55$	$8p = 72$	$4y = 19 + 5$

8. The Use of Money Is Worth Money

I. When the use of \$100 for a year is worth \$6, what is the worth of the use (a) of \$200 for a year? (b) Of \$50 for a year? (c) Of \$300 for 2 yr.? (d) Of \$400 for 3 mo.? (e) Of \$100 for 2 mo.? (f) Of \$800 for 2 mo.?

II. When the use of \$100 for a year is worth \$4, what is the worth of the use (a) of \$300 for 6 mo.? (b) Of \$75 for 1 yr.? (c) Of \$1000 for 3 mo.? (d) Of \$700 for $1\frac{1}{2}$ yr.? (e) Of \$250 for 3 mo.? (f) Of \$3000 for 2 mo.?

III. When the use of \$100 for a year is worth $\$4\frac{1}{2}$, what is the worth of the use (a) of \$500 for a year? (b) Of \$100 for 6 mo.? (c) Of \$800 for 2 yr. (d) Of \$50 for 1 year? (e) Of \$100 for $1\frac{1}{2}$ yr.?

IV. What is the use of \$200 for a year worth (a) at 6%? (b) At 3%? (c) At 5%?

V. What is the use of \$600 for 30 days worth (a) at 6% per year? (b) At 4% per year? (c) At $4\frac{1}{2}\%$ per year? (d) At 8% per year?

The exercises under III are easy. Those under II are of medium difficulty. Those under I are as hard as you will probably ever have to do in life. Examine them. Try those under I. If you cannot do them correctly, try those under II. If you cannot even do them, try those under III. If you do those in I all correctly, you need not do any under II or III.

I

Find the quotients to the third decimal place:

1.	2.	3.	4.
$17 \overline{)520.8}$	$24 \overline{)9800}$	$45 \overline{)270.375}$	$32 \overline{)10000}$
5.	6.	7.	8.
$3.26 \overline{)10.60}$	$44 \overline{)75.25}$	$14 \overline{)579.09}$	$9.5 \overline{)750}$

Find the missing numbers:

9. $\$10 = \dots \times 62\frac{1}{2}\text{¢}$	10. $\$5.75 = \dots \times 66\frac{2}{3}\text{¢}$
11. $\$50 = \dots \times \1.375	12. $\$25 = \dots \times 83\frac{1}{3}\text{¢}$
13. $\$38.75 = \dots \times \2.25	14. $\$100 = \dots \times \15
15. $\$19.71 = \dots \times \3.15	

Express the quotients in lowest terms:

16. $8\frac{1}{2} \div \frac{7}{8}$ 17. $4\frac{3}{4} \div \frac{4}{9}$ 18. $10 \div \frac{4}{7}$ 19. $3\frac{5}{7} \div 3\frac{1}{2}$ 20. $6\frac{3}{4} \div \frac{7}{8}$

II

Find the quotients to the third decimal place:

1.	2.	3.	4.	
$35 \overline{)2800}$	$108 \overline{)3.9}$	$47 \overline{)1000}$	$175 \overline{)60}$	
5.	6.	7.	8.	9.
$1020 \overline{)48.45}$	$91 \overline{)27.54}$	$382 \overline{)4156}$	$19 \overline{)392}$	$700 \overline{)5000}$

Find the missing numbers:

10. $\$10 = \dots \times 33\frac{1}{3}\text{¢}$	11. $\$6.00 = \dots \times 75\text{¢}$
12. $\$25 = \dots \times \1.50	13. $\$45 = \dots \times \2.25
14. $\$5.00 = \dots \times 12\frac{1}{2}\text{¢}$	15. $\$60 = \dots \times \2.50

Express the quotients in lowest terms:

16.	17.	18.	19.	20.
$9\frac{3}{4} \div \frac{3}{4}$	$\frac{3}{4} \div \frac{3}{8}$	$17\frac{1}{2} \div \frac{7}{8}$	$2\frac{3}{4} \div \frac{1}{2}$	$\frac{7}{8} \div \frac{1}{8}$

III

Find the quotients to the second decimal place:

- | | | | |
|------------------------|------------------------|-------------------------|-------------------------|
| 1. | 2. | 3. | 4. |
| $36 \overline{)1000}$ | $15 \overline{)725}$ | $181 \overline{)41.50}$ | $312 \overline{)85}$ |
| 5. | 6. | 7. | 8. |
| $13 \overline{)5.612}$ | $28 \overline{)88.15}$ | $75 \overline{)36}$ | $92 \overline{)150.05}$ |

Find the missing numbers:

- | | |
|------------------------------|--|
| 9. \$1.50 = ... \times 25¢ | 10. \$10.00 = ... \$1.25 |
| 11. \$5 = ... \times 28¢ | 12. \$2.00 = ... \times 66 $\frac{2}{3}$ ¢ |
| 13. \$7.00 = ... 20¢ | 14. \$3 = ... \times 12 $\frac{1}{2}$ ¢ |
| 15. \$10 = ... \times 40¢ | |

Express the quotients in lowest terms:

- | | | | | |
|---------------------------------|---------------------------------|------------------------|---------------------------------|-----------------------------------|
| 16. | 17. | 18. | 19. | 20. |
| $4\frac{1}{2} \div \frac{1}{2}$ | $3\frac{3}{4} \div \frac{3}{4}$ | $15 \div 2\frac{1}{2}$ | $3\frac{1}{3} \div \frac{5}{8}$ | $10\frac{1}{2} \div 1\frac{1}{2}$ |

10. Practice in Observing Numbers

1. Which of these mixtures are in the same proportions as a 1:2:3 mixture? Which are in the same proportions as a 1:2:4 mixture? Which are in the same proportions as a 1:3:5 mixture?
- | | | | |
|------------|---------------------------------------|--|---------------------------------------|
| a. 2:6:10 | g. 4:8:12 | m. 5:15:25 | s. 10:20:30 |
| b. 2:4:8 | h. 4:12:20 | n. 5:10:15 | t. 10:20:40 |
| c. 3:9:15 | i. 2 $\frac{1}{2}$:5:10 | o. $\frac{1}{2}$:1 $\frac{1}{2}$:2 $\frac{1}{2}$ | u. 7:14:21 |
| d. 3:6:9 | j. 1 $\frac{1}{2}$:3:4 $\frac{1}{2}$ | p. $\frac{1}{2}$:1:2 | v. 10:30:50 |
| e. 3:6:12 | k. 4:8:16 | q. 6:12:24 | w. 2 $\frac{1}{2}$:5:7 $\frac{1}{2}$ |
| f. 7:14:28 | l. 7:21:35 | r. $\frac{1}{3}$: $\frac{2}{3}$:1 | x. 15:30:60 |
2. Which of these are in the same proportions as 2:3:5?
Which of these are in the same proportions as 3:5:8?
Which of these are in the same proportions as 1:2:3?
- | | | | |
|------------|-------------|---------------------------------------|-------------|
| a. 6:9:15 | d. 12:24:36 | g. 1:1 $\frac{1}{2}$:2 $\frac{1}{2}$ | j. 24:40:64 |
| b. 6:12:18 | e. 12:20:32 | h. 2:4:6 | k. 24:36:60 |
| c. 6:10:16 | f. 12:18:30 | i. 10:15:25 | l. 24:48:72 |

11. A Game for Practice in Quick Thinking

The game is called "*Keep the Ball Rolling.*" It is played in this way:

One boy or girl begins, "15 is $2\frac{1}{2} \times \dots$ "

The next boy or girl says, "6, which is $\frac{2}{3}$ of \dots "

The next boy or girl says, "9, which is $1\frac{4}{5} \times \dots$ "

The next boy or girl says, "5, which is 10% of \dots ," and so on.

Each pupil scores himself 1 for every correct answer he gives and takes off one for every wrong answer, or failure to answer in 10 sec. The class calls "*Wrong*" when an answer is wrong. You are allowed to use only fractions, mixed numbers, or percents after the "*which is.*" The answer should be a whole number. If the answer is not a whole number, the class calls "*Result not a whole number*"; 1 is scored against the pupil who gave the question, and he has to give another.

I. Practice by writing as many problems and answers like this as you can in 15 minutes without making a mistake:

10 is $\frac{2}{3}$ of 15, which is $\frac{3}{4}$ of 20, which is $66\frac{2}{3}\%$ of 30, which is $2\frac{1}{2} \times 12$, which is 200% of 6, which is $\frac{1}{3}$ of 18, which is $\frac{1}{2}$ of 36, which is 150% of 24, which is $\frac{3}{4}$ of 32, which is 400% of 8, which is 8% of 100, which is $\frac{2}{3}$ of 150, which is 200% of 75, which is $1\frac{1}{2} \times 50$, which is $2\frac{1}{2} \times 20$, which is $1\frac{2}{3} \times 12$, etc.

II. Practice also with these:

- a. 6 is $\frac{2}{3}$ of \dots or $\frac{3}{4}$ of \dots or $1\frac{1}{2} \times \dots$ or $1\frac{1}{5} \times \dots$
- b. 7 is $3\frac{1}{2} \times \dots$ or $2\frac{1}{3} \times \dots$ or $1\frac{3}{4} \times \dots$ or $\frac{1}{4}$ of \dots
- c. 8 is $\frac{2}{3}$ of \dots or 4% of \dots or $1\frac{1}{3} \times \dots$ or 80% of \dots
- d. 9 is $\frac{9}{10}$ of \dots or $2\frac{1}{4} \times \dots$ or $\frac{3}{4}$ of \dots or 3% of \dots
- e. 10 is 200% of \dots or $\frac{2}{3}$ of \dots or $\frac{2}{5}$ of \dots or 50% of \dots
- f. 11 is $2\frac{1}{5} \times \dots$ or $2\frac{3}{4} \times \dots$ or $3\frac{2}{3} \times \dots$ or $33\frac{1}{3}\%$ of \dots
- g. 12 is $\frac{3}{4} \times \dots$ or $\frac{2}{3} \times \dots$ or 4% of \dots or $\frac{3}{5}$ of \dots
- h. 13 is $\frac{1}{2}$ of \dots or $\frac{1}{3}$ of \dots or $1\frac{3}{10} \times \dots$ or $6\frac{1}{2}\%$ of \dots
- i. 14 is 7% of \dots or 70% of \dots or 140% of \dots or 14% of \dots
- j. 15 is $1\frac{1}{2} \times \dots$ or $2\frac{1}{2} \times \dots$ or 75% of \dots or $\frac{3}{5}$ of \dots
- k. 16 is $\frac{4}{5}$ of \dots or $2\frac{2}{3} \times \dots$ or 32% of \dots or $\frac{1}{3}$ of \dots

III. Make up others for 17, 18, 19, 20, etc., if you have time.

1. Have you ever been given a check on a bank instead of money? If so, be ready to tell what the check was. If you know somebody in a bank who will give you a check book, bring it to school so that the class may examine it.
2. Examine this check or order to a bank to pay somebody money.

No. <u>311</u>	Chicago, Ill. <u>Oct 5</u>	19 <u>17</u>
MERCHANTS' NATIONAL BANK		
Pay to <u>R. F. Dale</u>		or order
<u>Fourteen and $\frac{75}{100}$</u>		dollars
\$ <u>14.75</u>	<u>B. J. Vail</u>	

3. What bank is ordered to pay out money?
4. To whom are the officers of the bank told to pay it?
5. How much are they ordered to pay?
6. By whom are they ordered to pay the money?
7. If a foolish boy wrote a check ordering a bank where he had no money deposited to pay you \$5.00, would the bank pay it to you? If he had \$25.00 deposited in a bank and wrote a check ordering the bank to pay somebody \$100.00, would the bank pay the \$100.00?
8. *It is convenient for anybody to have money deposited in a bank and write checks or orders to the bank to pay money. It is very, very convenient for a man or woman in business. Think of reasons why this is true and be ready to tell about them.*

A check book is a book containing checks in convenient form and stubs on which you write an account of how much of your money you have ordered the bank to pay, to whom the bank is to pay the money, what the money is paid for, when you ordered it to be paid, and anything else you wish.

9. Examine this sample page, and a real check book, if possible.

No.	No. St. Louis, Mo. _____ 19__
Date.	SECOND NATIONAL BANK
To	Pay to _____ or order
For	_____ dollars
Amt.	\$ _____

Sometimes several stubs are printed together and a place is arranged to keep account of deposits.

10. What would you write on the checks themselves and what would you write on the stubs if you had \$86.23 in the First National Bank on the morning of Nov. 18, and on that day wrote orders

	AMOUNTS DRAWN
No. _____ DATE _____ 191__ PAY TO _____ FOR _____	
No. _____ DATE _____ 191__ PAY TO _____ FOR _____	
No. _____ DATE _____ 191__ PAY TO _____ FOR _____	
<i>TOTAL CHECKS DRAWN</i>	

<i>DATE 191__ DEPOSITS</i> <i>BALANCE BROUGHT FORWARD</i>	
<i>TOTAL DEPOSITS</i>	
<i>DEDUCT CHECKS DRAWN, Nos. _____</i>	
<i>BALANCE FORWARD</i>	

to that bank to pay John Doe \$2.75 (for a pair of shoes), Richard Roe \$2.00 (to repay him for \$2.00 he lent you the day before), \$3.00 to your mother (for a week's board), and \$6.85 to Montgomery, Ward & Co. (for Christmas presents)?

11. How much money will you have left in the bank when these checks have been paid?
12. Ought anybody to keep account of how much money he deposits in a bank? Of what else should he keep account?

13. Keeping a Checking Account

You do not usually receive any interest on money that you deposit in the bank to be paid out at your order (except from some banks on large deposits or for special reasons). So the money you have left in the bank at the end of a month or year equals the money you had at the beginning, plus the money you have put in, minus the money the bank has paid out on your checks.

New Balance = Old Balance + Deposits – Checks.

1. John's balance on Oct. 1, 1917, was \$61.24. He deposited \$12 on Oct. 3, \$14 on Oct. 10, \$15 on Oct. 17, \$15 on Oct. 24, and \$50 on Oct. 26. He drew checks during October for \$5.25, \$3.50, \$8.00, \$1.50, and \$24.00. What was his balance on Nov. 1?

If a man in business has a chance to buy goods cheaply and has not enough balance in the bank to pay for the goods, he borrows money from his bank. When he sells the goods he pays back the money.

2. How much interest must he pay on \$100 at 6% for 6 mo.? For 3 mo. or 90 days? For 2 mo. or 60 days? For 1 mo. or 30 days?
3. How much interest must he pay on \$100 at 5% for 6 mo.? For 90 days? For 30 days?
4. How much interest must he pay on \$350 at 6% for 60 days?
5. How much interest must he pay on \$400 at 6% for 90 days?
6. How much interest must he pay on \$50 at 6% for 60 days?
7. How much interest must he pay on \$200 at 6% for 30 days?
8. Mr. A's balance on Nov. 1, 1917, was \$83.69. He deposited \$32.50 on Nov. 7. He drew checks during November for \$3.75, \$16.00, and \$9.28. What was his balance on Dec. 1?

142 14. Keeping Account of Money That Is Borrowed

Anybody who borrows money should make out a written promise to pay and give it to the lender as an account of the transaction.

In Henry's school, when a boy borrows a dollar from another boy he makes out a note like this:

Jan. 10, 1916

Jack Dean
I. O. U. \$1.00 and will pay Feb. 9.
Henry Finch

1. It is a rule of the boys in that school to pay a cent a month interest on every dollar borrowed. At what rate is that per year?

Business men would make out an interest-bearing note more carefully, like this:

\$ 1.00 Boston, Mass. Jan. 10 1916
Thirty days after date for value received I promise to
pay to Jack Dean or order,
One and $\frac{no}{100}$ dollars,
with interest at 12% at the Dover School Study Hall.
Henry Finch

In this note who promises to pay?

How much does he promise to pay?

When is it to be paid?

What do you think "for value received" means?

2. What do you think "or order" means?

Anybody who borrows money should keep account of —
each amount that he owes,
the date when it is to be paid,
how much interest he has to pay, and
the date when interest is to be paid.

3. On Oct. 1, 1915, Mr. Roe borrowed \$3000 on a mortgage for 5 years at $5\frac{1}{2}\%$, interest payable annually. On Nov. 5, 1915, he borrowed \$200 on a note for 90 days with interest at 6% . On Dec. 20, 1915, he borrowed \$250 for 30 days with interest at 5% .

Supply the missing dates and numbers:

F. Roe: Payments to be made on loans

	Principal	Interest	Total
Jan.....1916	250
Feb.....1916	200
Oct.....1916

Remember, "30 days have September, April, June, and November. All the rest have 31, save February alone." February has 28 in regular years and 29 in leap years.

4. Find the date at which the notes, I, II, III, IV, and V below, must be paid and the amount to be paid for principal and interest. Count 30 days as $\frac{1}{12}$ yr., 60 days as $\frac{1}{6}$ yr., and 90 days as $\frac{1}{4}$ yr.

- I. June 9, 1916, Ninety days after date, \$400, with interest at 6% .
- II. July 10, 1916, Sixty days after date, \$350, with interest at 5% .
- III. Sept. 15, 1916, Thirty days after date, \$140, with interest at 6% .
- IV. Sept. 20, 1916, Sixty days after date, \$175, with interest at 6% .
- V. Aug. 10, 1916, Ninety days after date, \$210, with interest at 5% .

15. Borrowing Money to Use in Business

1. Recall what you have learned about borrowing money and about writing out promises to pay or **promissory notes**.
 (a) Write a promise to pay \$5 to your father or to any one whom he chooses, three months from now. (b) Write also a promise just like it except that you add *with interest at 6%*.
2. Which promise is worth more? Why?

A note or promissory note may be a promise to pay a sum of money, or a promise to pay a sum of money plus interest.

3. Write a promise to pay \$5 to your father or to any one whom he chooses *on demand* (that is, whenever he asks for it) with interest at 6%.
4. A piece of paper money is simply a promise of the United States government or of some national bank to pay. Examine a dollar bill or two-dollar bill or five-dollar bill.
5. Is it a promise to pay on demand or at a certain date? Is it a promise to pay any particular person or to pay the bearer (that is, whoever holds the note)?

People in business are just as willing to have 10 dollars in United States paper money as to have 10 dollars in gold *because they know that they can obtain 10 dollars in gold for 10 dollars of our paper money* whenever they choose. They know that the United States will pay on demand.

6. If a stranger should make out a note promising to pay the bank \$1000 in 60 days with interest at 6%, and offer it to the bank, would the bank give him a thousand dollars for it? Why not?

When a man borrows money he usually gives **security** to the lender that he will pay. Sometimes the borrower gives the lender the right to sell the borrower's house if he does not pay. Sometimes the borrower leaves stocks or bonds with the lender and gives the lender the right to sell these if the money is not paid. For a small loan the borrower sometimes leaves his watch or other jewelry or his overcoat with the lender as security.

Sometimes the lender is so sure that the borrower will pay that he does not require security.

7. Mr. A. borrowed \$4000 to use in buying some land. He deposited as security 20 shares of stock in the New York Central R. R. worth \$104½ per share and 20 shares of General Electric Co. stock worth \$168¾ per share at the time. (a) How much more was the value of the securities he deposited than the value of the loan? (b) If the value of the securities should fall 20%, would they still be worth more than \$4000?

In the business world, when anybody borrows money — He gives his note or written promise to pay.

His note is usually a time note for 30, 60, or 90 days, or longer.

If he does not pay it when it falls due, he **renews** the loan by making a new note and giving it in place of the old one.

His note may be a promise to pay the money alone, or it may be a promise to pay the money plus interest.

16. Promissory Notes

\$ <u>500.00</u>	San Francisco <u>July 1</u> 19 <u>16</u>
Six months after date, for value received, I promise to	
pay to <u>Samuel Lane</u>	or order,
<u>Five hundred</u>	dollars,
with interest at <u>6%</u> at the Second National Bank.	
<u>Edward Peters</u>	

1. Is this a **Time Note** or a **Demand Note**?
2. When was this \$500 borrowed? 3. When must it be paid?
4. Is any interest to be paid on it? If so, how much?
5. On Nov. 1, Mr. Lane wishes to obtain some cash and sells this note to a bank for about \$510. Why is it worth more than \$500 (supposing that Mr. Peters will surely pay it)?

\$ 500.00 San Francisco July 1 1920

Six months after date, for value received, I promise to
 pay to Joseph Lee or order,
Five hundred dollars
 at the Second National Bank.

Edward Peters

6. Is this a Time Note or a Demand Note?
7. When was this \$500 borrowed? 8. When must it be paid?
9. Is any interest to be paid on it? If so, how much?
10. On Nov. 1, Mr. Lee sells this note to a bank for \$495. Why is it worth less than \$500 (supposing that Mr. Peters will surely pay it)?
11. The amount of money said to be borrowed in a note is called the "face" of the note, or the **principal**. What is the face of each of the notes shown on this page and page 145?
 A "non-interest-bearing note" (that is, a note on which no interest is paid) is worth *less* than its "face" until the day it is paid. The farther off the date of payment is, the less it is worth. When anybody sells a note not bearing interest, he has to make a reduction or discount.
12. Make out a non-interest-bearing note for \$8000, due 90 days from to-day, and have the other children estimate approximately what reduction they would wish to have, counting that the note will surely be paid and that the use of the money is worth 6% per year. See who estimates correctly.
13. At the Washington School, Cora estimated \$150, Frank estimated \$300, Fred estimated \$50, and Laura estimated about \$49.50, for a \$5000 non-interest-bearing note due in 60 da. Fred was right according to the way banks do discount notes; and Laura was right according to a way that they might use. What do you think was Frank's mistake?

The banker would find, for the first note of Ex. 12,
 $.06 \times \frac{1}{4} \times \8000 , and use \$120 as the discount.

For the second note of Ex. 13, the banker would find
 $.06 \times \frac{1}{6} \times \5000 , and use \$50 as the discount.

When anybody borrows money from a bank he may make out a non-interest-bearing note, usually for 30 or 60 or 90 days, and give it to the bank. The bank *subtracts the interest* and gives the person an amount of money equal to the face of the note *less the interest or bank discount*. You may think of the discount that the bank makes as interest that the borrower pays in advance.

14. You give the bank a non-interest-bearing note for \$1000 payable in 90 days. How many dollars does the bank discount for interest at 6% and how much does it give you?

17. Banker and Borrower

I. Play Banker and Borrower in this way with eight banks:

Choose 8 boys and girls to be the First 7th Grade Bank, the Second 7th Grade Bank, etc. Let the others be borrowers. Begin with an interest or discount of 6%. Each borrower makes out a non-interest-bearing note for a certain sum payable to the First 7th Grade Bank, 30, 60, or 90 days from date, and takes it to that bank. The banker computes the discount, deducts it from the face, and gives the borrower the "proceeds" in play money. The borrower computes the bank discount so as to be sure that he receives the right amount of money as the "proceeds" of his note. When the teacher announces that the interest or discount rate is changed to 5% the bankers must use this new rate. When the teacher announces that the rate of discount is changed to 4½% the bankers must use that rate.

At the end of the game destroy all notes and checks. They are not real obligations, but it is best to destroy any make-believe notes or checks. Do the same in the case of all bills, receipts, notes, checks, drafts, etc., that you make.

II. Make out a table like this to use in playing the game of *Banker and Borrower*, putting in the missing numbers.

Interest or Discount on \$100

	at 4%	at 4¼%	at 4½%	at 4¾%	at 5%	at 5½%	at 6%
For 30 days. .33
60 days. .67
90 days. ...	1.06

III. Practice with these exercises so that you will not make mistakes in the game. Use the table which you made in Ex. II to help you in finding the answers quickly.

In exercises *a* to *e*, *n.i.b.* means “*non-interest-bearing.*”

- a.* How much does the bank deduct and how much does the borrower receive for a *n.i.b.* note payable in 60 days discounted at 5%?
- b.* For a *n.i.b.* note for \$50, payable in 90 days, discounted at 6%?
- c.* For a *n.i.b.* note for \$300, payable in 30 days, discounted at 4½%?
- d.* For a *n.i.b.* note for \$470, payable in 60 days, discounted at 5%?
- e.* For a *n.i.b.* note for \$75, payable in 90 days, discounted at 4%?

18. Selling Notes

Banks often sell the notes that they have taken to other banks, especially to the large Reserve Banks in New York, Philadelphia, Chicago, San Francisco, New Orleans, and other big business centers.

1. A *n.i.b.* note for \$1000 is dated June 1, payable in 90 days from date (that is, on Aug. 30). The First National Bank of Albany takes it from the borrower on June 1, giving the borrower \$985. Two months later the New York Reserve Bank takes it from the Albany bank. Should the New York bank give the Albany bank more or less than \$985 for the note? Why?

2. On Oct. 1, you make a note for \$200 payable in 30 days, but do not take it to the bank till Oct. 10. Is the discount more or less than it would have been on Oct. 1?

The bank's discount on a non-interest-bearing note is reckoned on the time from the day the bank takes the note to the day it is payable. The day or date when a note is payable is called the day when it is **due**, or the date when it is due, or the date of **maturity**.

3. Find the discount at 6% on a *n.i.b.* note for \$3000, payable Oct. 30, (a) If the note is discounted Oct. 15. (b) If it is discounted Sept. 30. (c) If it is discounted Aug. 30.

19. The Use of Money Is Worth Money

One of the most important causes of success in business is the ability to collect bills due you at the date when they are due or very soon after. There are two reasons for this. One is that the longer you let a customer go without paying the bill the less likely he is to pay it at all. The other is that the longer you let a customer go without paying the bill, the longer you lose the use of that money.

1. When the use of \$100 is worth \$6 a year, or 50 cents a month, how much does a business man lose by letting a bill for \$50 go unpaid for 6 mo. after it is due? How much does he lose by letting bills for \$800 go unpaid for 2 months after they are due?
2. How much does a business man lose by letting bills for \$6400 go unpaid for an average of a month after they are due?
3. Compare these two businesses, A and B, counting that the use of money is worth 6% per year.

A sold \$21,400 worth of goods. \$1300 of the money was never paid. The rest was paid on the average 2 months after it was due.

B also sold \$21,400 worth of goods. \$600 of the money was never paid. The rest was paid on the average 15 days after it was due.

- a. Find the wages due J. Lynch for the week.
 - b. Find the wages due P. Lynch for the week.
 - c. Find the wages due S. Marks for the week.
 - d. Find the wages due A. Owen for the week.
 - e. How many times as much did J. Lynch receive as S. Marks?
4. During the first week that Dan worked at his new job, he made \$.90 for overtime. The second week, he made \$1.20 for overtime. During the next 8 weeks, he averaged \$1.30 per week for overtime. During the rest of the year he made 30¢ per week on overtime in 9 weeks, 60¢ per week in 3 weeks, 75¢ per week in 5 weeks, 90¢ per week in 7 weeks, \$1.05 per week in 11 weeks, \$1.20 per week in 4 weeks, \$1.35 per week in 3 weeks.
- a. How much did he average per week for overtime?
 - b. How far wrong would he have been if he had estimated the whole year by the first two weeks?
 - c. For his regular-time work, he received \$10.00 per week for 9 hours M., Tu., W., Th., and F., and 5 hours on Saturday. At what rate per hour was he paid?

21. Piece Work

The A. T. and M. Co. has to pay a high rent for its work room. So it pays well for rapid work. It pays as follows:

For making article C7: 4¢ each up to 30 articles a day, 5¢ each for the next 10 made per day, and 6¢ each for any over 40 made per day. The worker gets no pay for an article that she spoils in making, and her pay is "docked" 2 cents (that is, 2 cents is subtracted from her pay) for the waste of materials.

1. How much does a worker for the A. T. and M. Co. receive in a day when she makes 38 of C7 that are O.K. and spoils 3? (O.K. means "all right.")
2. In a day when she makes 44 of C7 that are O.K. and spoils 1?
3. In a day when she makes 44 of C7 that are O.K. and spoils none?

Piece Work (continued)

4. For article N4, the rate of payment is: 2¢ each for the first 60 a day, $2\frac{1}{4}$ ¢ each for the next 10, $2\frac{1}{2}$ ¢ each for the next 10, $2\frac{3}{4}$ ¢ each for the next 10, and 3¢ each for any over 90 a day. No pay is given for a spoiled article, and 1¢ is deducted from the boy's earnings for each spoiled article. In the five days of the week, one boy made 90, 91, 91, 94, and 96 of N4, without spoiling any. What did he earn per day on the average?
5. What is the payment for 75 of N4 made in a day, none being spoiled?
6. What is the payment for 86 of N4 in a day, two being spoiled?
7. What is the payment for 105 of N4 in a day, 3 being spoiled?

22. Payment for Time Saved

The G. C. and K. Co. pays the employees in its factory as follows: It sets a fair time in which each job must be done. If the worker finishes the job in less time than the time allowed, she receives regular pay at 16¢ per hour for the time she spent on it and 9¢ per hour for the difference between the time she actually spent and the time allowed.

1. A quick worker in one day made this record: Supply the missing numbers in the last three lines.

Job 117a, time allowed, 4 hr., actual time spent 2 hr. 10 min.

Job 9c, time allowed, $2\frac{1}{2}$ hr., actual time spent 1 hr. 20 min.

Job 23v, time allowed, $3\frac{1}{2}$ hr., actual time spent 2 hr. 15 min.

Job 24v, time allowed, $3\frac{1}{2}$ hr., actual time spent 2 hr. 15 min.

Total time allowed = . . . hr. Total actual time = . . .

Difference = . . . hr. Day's earnings = (regular pay for 8 hr. at . . . per hr.) + ($5\frac{1}{2} \times \dots$). Day's earnings =

2. Find the day's earnings for a girl who made this record:

Job 11c, time allowed, $3\frac{1}{2}$ hr., time actually spent, 2 hr. 15 min.
 Job 12c, time allowed, $3\frac{1}{2}$ hr., time actually spent, 2 hr. 10 min.
 Job 13c, time allowed, $3\frac{1}{2}$ hr., time actually spent, 1 hr. 55 min.
 Job 14c, time allowed, $3\frac{1}{2}$ hr., time actually spent, 1 hr. 50 min.
3. Find the week's earning for a girl who in 48 hours of actual time spent did jobs for which 71 hours' time was allowed.

The D. R. and V. Co. pays its salesmen as follows:

\$6 a week for fares, etc., and

4% commission on the first \$300 worth of goods sold each week,

6% commission on the sales of over \$300 per week up to \$400 per week,

8% commission on sales over \$400 up to \$500 per week,

10% commission on sales over \$500 per week.

1. How much does a salesman receive in a week when the total of his sales is \$340? 2. When it is \$425? 3. When it is \$460? 4. When it is \$530?

The N. F. and T. Co. pays its women clerks as follows:

\$7 per week and lunch during the first year, which is a trial year; \$9 per week and lunch after the trial year, with a bonus or present of \$150 at the end of the third year; a bonus or present of \$150 at the end of the fifth year; a bonus of \$500 at the end of the tenth year; and a bonus of \$150 at the end of each year after the tenth.

5. Counting the value of the lunch at 20¢ per day, how much does a girl average per week if she works for the N. F. and T. Co. for three years?
6. How much does she average per week for the next two years if she stays at work for the N. F. and T. Co.? (Count the lunch at 20¢ per day in Ex. 6, 7, and 8.)
7. How much does she average per week for the next 5 years if she stays for 10 years in all?
8. How much does she average a week each year after the tenth?

24. Shares in a Small Business

John, Dick, and Tom buy a motor-boat together. John pays

This certifies that John Drake owns ten shares of the motor-boat Fly Away

June 6, 1916

*John Drake
Richard Getz
T. Eaton*

\$70, Dick pays \$20, Tom pays \$10. They write ten slips like this. By a "share" they mean a hundredth.

1. How many of these slips or certificates should they give John?
2. How many should they give Dick?
3. How many should they give Tom?
4. Into how many "shares" is the ownership of the boat divided?
5. They plan to let some other boys own shares in the boat as soon as they save money to pay for them. In two weeks, Dick's cousin, George Finch, has his money ready, and buys 10 shares from Dick. Dick makes George pay \$1.05 for each share. How much does George pay in all?
6. What would you do to show that 10 of Dick's shares now belong to George Finch?
7. Later John sells 10 shares to Arthur Dean, 10 shares to Robert Ladd, and 10 shares to Will Foster. Tell the number of shares owned now:

By John Drake	By Arthur Dean
By Richard Getz	By Robert Ladd
By Thomas Eaton	By Will Foster
By George Finch	
8. By this time other boys are very eager to own shares in the motor-boat. So John sells 10 shares to Alfred Jones for \$1.10 per share and 10 shares to Fred Knox for \$1.12½ per share. How much more does he receive for these 20 shares than he paid for them?
9. Henry Peters wishes very much to own part of the boat. He offers John first \$1.16, then \$1.16½. Finally John sells him 10 shares at \$1.17½. Calling the *par value* of a share \$1.00, how many cents *above par value* were paid for each share bought —
 - (a) By Alfred Jones (see Ex. 8)?
 - (b) By Fred Knox (see Ex. 8)?
 - (c) By Henry Peters?
10. John tells his brother that he will sell him 5 shares at 75 cents each. How much *below par* is that?

The value of the Pennsylvania Railroad is over \$500,000,000. The value of the Union Pacific Railroad is over \$300,000,000. The value of the American Telephone & Telegraph Co. is over \$400,000,000. The value of the United States Steel Corporation is over \$700,000,000.

1. Do you think that any one man owns all of the Pennsylvania Railroad or all of the American Telephone & Telegraph Co.?
2. The ownership of the Pennsylvania Railroad's property is divided into ten million shares. What is the value of one share in this company if the entire ten million shares are worth \$550,000,000?
3. If the ten million shares of the Pennsylvania R. R. are owned by 101,714 different persons, what is the average number of shares owned per person?
4. Mr. W. bought 10 shares of the United States Steel Corporation, paying \$806.25, and sold them the very same day at \$82 $\frac{1}{4}$ each. How much was his profit?
5. The ownership of Sears, Roebuck & Co. consists of 680,000 shares of stock. Mr. Vane owns 250 shares. What fraction of the whole corporation does he own?
6. The ownership of the Butterick Company consists of 150,000 shares. Mr. M. owns 100 shares, Mr. N. owns 25 shares, and Mr. O. owns 75 shares. What percent of the whole stock do these three stockholders together own?
7. The Dixville Land Company owns property worth \$31,200. The ownership is divided into 2500 equal shares. What is the value of one share?
8. The ownership of the Dale Motor Corporation is divided into 500 shares, worth \$114.50 per share. What will it cost to buy 15 shares at this rate?
9. The ownership of the Roper Bicycle Company is divided into 5000 shares worth \$12 each. Mr. Sam Roper owns $\frac{5}{8}$ of the shares. How much is his stock worth?

26. Buying Shares or Stock in a Business

Anybody who has the money can become owner of part of a business by buying one or more shares in the business if somebody is willing to sell them to him. When he buys the shares he receives a certificate stating that he is the owner of so many shares.

1. What will it cost for each of these, counting that you pay $12\frac{1}{2}$ cents or $\$ \frac{1}{8}$ per share in addition for commission or brokerage to the man who obtains them for you?

10 shares of the Pennsylvania R. R. at $\$56\frac{1}{4}$ each

15 shares of the Union Pacific R. R. at $\$131\frac{5}{8}$ each

25 shares of the Am. Tel. & Teleg. Co. at $\$124\frac{1}{2}$ each

5 shares of the General Electric Co. at $\$160\frac{1}{8}$ each

5 shares of the Butterick Co. at $\$31\frac{7}{8}$ each

2. What will it cost to buy 1 share of each of the five sorts, counting that you also pay 25 cents per share as a commission to the broker who buys them for you?

3. How much does each of these men pay in all?

Mr. A. buys 10 shares of the Northern Pacific R. R. at $\$111\frac{3}{8}$ per share and pays $12\frac{1}{2}\text{¢}$ or $\$ \frac{1}{8}$ per share as commission or brokerage to the broker who obtains the shares for him.

Mr. B. buys 35 shares of the National Biscuit Co. at $\$123\frac{1}{2}$ per share and pays $\$4.38$ as commission or brokerage.

27. Par Value

When the ownership of a business is divided into many shares, each share is called a share of **stock** in the business.

For example, Sears, Roebuck & Company is not owned by Mr. Sears and Mr. Roebuck as partners. It is a corporation with 680,000 shares of stock owned by over a thousand different people. If a person wished to own half of Sears, Roebuck & Company he would have to buy 340,000 shares of its stock. Any owner of one or more shares is called a **stockholder** of Sears, Roebuck & Company. A stockholder in a store or railroad or gas company is a person who owns part of the store or railroad or company.

When a corporation like the Curtis Publishing Co. or the General Electric Company is formed, a certain value is often set on each share of its stock, called the **par value**.

1. The par value of one share of stock in the motor-boat *Flyaway* was \$1.00. What was the par value of the entire 100 shares?
2. The par value of the entire stock of the National Cloak & Suit Co. is \$17,000,000. The stock is divided into 170,000 shares. What is the par value of one share?
3. The par value of the entire stock of a corporation is \$5,000,000. The par value of one share is \$50. Mr. A. owns 1000 shares. What fraction of the entire stock does he own?

The par value of a share in a corporation may be set at any amount — 25¢ or \$1 or \$10 or \$20 or \$50 or \$100. The par value of a share of stock need not have anything to do with the real value, the price you have to pay to buy a share, or the price you receive when you sell a share.

4. What fraction of the par value is the cost price in the case of each of these shares?

	Par Value per Share	Cost Price per Share
Missouri Pacific	\$100	\$ 5
N. Y. N. H. & H.	\$100	\$62½

28. Dividends

1. The boys who owned stock in the motor-boat *Flyaway* used the boat all summer to carry passengers and packages to different places on the lake. The boys took turns in running the boat. During the summer of 1915 they received \$49.25 from passenger fares and \$41.50 for delivering packages, trunks, etc. They spent \$29.35 for gasoline, oil, and repairs. They did not pay any wages to the boys who ran the boat because each boy was glad to run it as often as he could. How much money did they have at the end of the summer as profits?

2. They put \$20 in the savings bank toward a fund with which to buy a new boat when the *Flyaway* wears out. They set aside \$21.40 as a fund to be used to pay for storage of the boat, insurance, painting, etc., if necessary. The remainder of the \$61.40 of profits was divided among the stockholders or boys who owned the 100 shares. (a) How much did a boy receive who held 10 shares? (b) How much did a boy receive per share?
3. In the *Flyaway* corporation there were 100 shares of par value \$1.00 each. \$20 was distributed to the stockholders at the end of the summer. Did a boy receive 10% or 15% or 20% or 25% of the par value of his stock when they distributed the \$20?

In the business world this \$20 which was distributed to the stockholders would be called a **dividend** at the rate of 20%.

Money paid by a corporation to its stockholders (that is, to the owners of shares of the corporation) is called a **dividend** or **dividends**.

The amount of a dividend is often described by the **percent which it is of the par value of the stock**.

4. Tell the missing numbers:

A dividend of 6% means \$6 on each share, if the par value of a share is \$100.

- a. A dividend of 6% means . . . on each share, if the par value of a share is \$50.
- b. A dividend of 6% means . . . on each share, if the par value of a share is \$10.
- c. A dividend of 6% means . . . on each share, if the par value of a share is \$25.
- d. A dividend of 7% means . . . on each share, if the par value of a share is \$50.
- e. A dividend of 7% means . . . on each share, if the par value of a share is \$100.
- f. A dividend of 7% means . . . on each share, if the par value of a share is \$1.

Find the total amount received as dividends and from the final sales of the shares of stock in each of these investments of \$500.

1. With her \$500, Mrs. A. bought 4 shares, par value \$100 per share. She received dividends as follows: 1st year, 8%; 2d year, 7%; 3d year, 7%; 4th year, 6%; 5th year, 6%. She then sold the four shares, receiving \$116½ per share.
2. With her \$500, Mrs. B. bought 10 shares, par value \$50 per share. She received dividends as follows: 1st year, 6%; 2d year, 6%; 3d year, 6%; 4th year, 6%; 5th year, 7%. She then sold the 10 shares, receiving \$57¼ per share.
3. With her \$500, Mrs. C. bought 2000 shares of par value \$1 per share that she saw advertised at 25¢ per share. She received a dividend of 8% the first year and never received any more. After 5 years she sold the shares at 2 cents a share.
4. With her \$500, Mrs. D. bought one share in each of eight railroads, par value \$100 per share in each case. She received dividends and sold the stock as follows:

		1 yr.	2 yr.	3 yr.	4 yr.	5 yr.	Selling Price
Share	I.	4	4	4	6	6	\$104½
Share	II.	0	0	0	4	4	71¼
Share	III.	0	0	0	0	0	18¾
Share	IV.	0	4	4	4	4	69½
Share	V.	5	5	5	6	6	102¼
Share	VI.	4	4	0	0	0	20¾
Share	VII.	0	0	0	4	4	56½
Share	VIII.	5	5	4	4	4	83¼

- (a) What percent of the \$500 which she invested did Mrs. D. receive as dividends the first year? (b) The second year? (c) The third year? (d) The fourth year? (e) In which years was the money she received from dividends less than she would have received as interest from a savings bank paying 4%?

A man or woman who has saved money may invest it in many ways.

- For example, Lewis had saved \$520. He left it for two years in the savings bank where it drew interest at 4% compounded semiannually. At the end of 6 mo., he had $\$520 + (.02 \times 520)$ or \$530.40. At the end of 1 yr., he had $\$530.40 + (.02 \times 530)$ or \$541. (a) How much did he have at the end of 1½ yr.? (b) At the end of two years?

He may buy real estate. Real estate means land and buildings.

- For example, when Edward was 21 years old, he had \$1300 in the savings bank. With this money he bought the three lots on Oak Street shown in the map. After two years he sold Lot A for \$525, Lot B for \$575, and Lot C for \$450. His expenses for taxes, commissions paid, etc., were \$120.

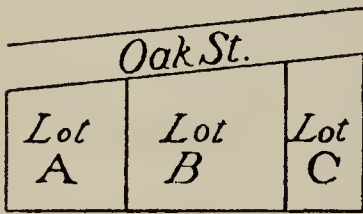

Compare what he had at the end of the two years as a result of this investment with what he would have had if the money had been left in the savings bank, to draw interest at 4% compounded semiannually.

He may buy shares of stock, becoming part owner of some railroad, mine, gas company, store, or factory.

- For example, Helen's aunt gave Helen about \$3000. Helen's father invested it for her as follows:

Cost	Par Value	Rate Per- cent of Annual Dividend	Yearly Income
\$242.00 for 2 shares Am. Telephone & Telegraph	\$100	8	\$16.00
481.25 for 5 shares A. T. & Santa Fe (common)	100	6
100.00 for 1 share A. T. & Santa Fe (preferred)	100	5
168.50 for 2 shares Baltimore & Ohio (common)	100	5
150.50 for 2 shares Baltimore & Ohio (preferred)	100	4
530.00 for 10 shares Pennsylvania	50	6
800.00 for 5 shares Sears Roebuck (common)	100	7
517.50 for 5 shares U. S. Steel (preferred)	100	7

- a. What was the total cost, including expenses of \$8.75 for commissions, sending telegrams, etc.?
- b. At the rate percent shown in the table, how much will Helen receive in dividends from the entire 32 shares of stock?
- c. If you think you know what the words "*common*" and "*preferred*" mean, as used in the table, be ready to tell the class.

31. Investing in Mortgages and Bonds

A person may lend his money to somebody and receive interest.

1. For example, Anna had saved \$800 when she was 22 years old. She lent it to Mr. Dorr. Mr. Dorr made a written promise to pay her 6% interest each year and to pay back the principal (that is, the \$800) in 5 years. A written agreement was also made in which Mr. Dorr stated that if he did not pay the interest at the end of each year or did not pay back the \$800 at the end of the 5 years, Anna had the right to make Mr. Dorr sell his farm and pay her out of the money received for the farm. The land alone of Mr. Dorr's farm is worth 50% more than \$800. This agreement is called a mortgage on Mr. Dorr's farm given by him to Anna.
 - (a) In this transaction who is the lender? (b) Who is the borrower? (c) How much is lent? (d) How many dollars are to be received each year as interest? (e) What security does the lender have that the interest and principal will be paid? (f) Which of the written agreements is called a promissory note? (g) Which is called a mortgage?
2. Think what this means and supply the missing numbers: After two years Anna wishes money to start a millinery store. So she sells the note and mortgage that Mr. Dorr gave her to Mr. Fox. Mr. Fox gives her \$790. She gives him the right to receive . . . interest each year from Mr. Dorr and to receive the . . . at the end of three years.

3. Certain promises to pay money can be bought and sold just like a bar of soap or a share of stock. Mr. Fox, who paid Anna \$790 for her \$800 mortgage, sold it in three days to Mr. Adams for \$815. How much did he receive for his time, the use of the \$790 for three days, and his judgment in buying from Anna?
4. In November, 1915, anybody who had the money could buy:
- The promise of the New York Central to pay \$1000 in 1935 with interest at 6%.
 - The promise or bond of the New York Central to pay \$1000 in 1931 with interest at 4%.

The price for one of these was \$1120, the price for the other was \$800.

- Which promise or bond do you suppose cost \$1120?
 - How much did it cost Mrs. Lawrence to buy both promises, including \$1.25 commission on each paid to the broker?
5. What percent of \$1922.50 is \$100?

Arthur has saved \$1000. He does not know of anybody in his town to whom he would care to lend money, so he buys two **bonds**. A **bond** is the *promise of some person or corporation to pay the owner of the bond a certain sum of money at a certain time with interest at a certain rate payable at specified dates.*

6. The first of Arthur's bonds is a promise of the B. & O. R. R. to pay the owner of the bond \$11.25 on Jan. 1 and July 1, every year until July 1, 1940, when the last \$11.25 of interest and the \$500 principal are to be paid. (a) What is the rate of interest paid on \$500 in this bond?
- (b) Arthur bought this bond for \$450. What percent of the \$450 is the \$22.50 that he receives each year?
7. The second bond that Arthur buys is a promise to pay \$500 in 1995 with interest on the \$500 at 4%. (a) How much money does he receive each year as interest on this bond or as his income on this bond? (b) He paid \$427.50 for this bond. What percent of \$427.50 is his income from this bond?

When a bond is a promise to pay \$100, the par value of the bond is \$100.

When a bond is a promise to pay \$500, the par value of the bond is \$500.

When a bond is a promise to pay \$1000, the par value of the bond is \$1000.

The dividend on a share of stock is reckoned as a certain percent of the par value of the share of stock.

The interest on a bond is reckoned as a certain percent of the par value of the bond.

1. Read, supplying the missing words:

The real value of a bond may be . . . or . . . than its par value. If the interest is at a high rate and you are sure that the interest and principal will be paid the real value is probably than the par value.

If you have good reason to fear that the interest or principal or both may not be paid or if, though sure to be paid, the interest is low, the real value is probably than the par value.

When you buy a bond you are buying somebody's to pay you money at some time with at a certain rate.

2. The number of dollars a person receives per year as interest or dividends on money invested in a bank, real estate, stocks, mortgages, bonds, etc., may be called the **income** from his investments.

Find:

- (a) What the annual income is from each of these investments.
- (b) What percent of the number of dollars invested the annual income is in each case.

I. \$600 used to buy 6 bonds, par value \$100 each. Three of them pay 4% interest. Three of them pay 4½% interest.

II. \$600 used to buy 5 shares of stock, par value \$100 each. Three of them pay 7% dividends, one pays 6%, one pays no dividend.

III. \$600 used to buy a mortgage for \$550, paying 6% interest.

When you grow up and have any money to invest, consult some banker whom you know and can trust, or put the money in the savings bank.

164 33. Expressing and Comparing Quantities by Diagrams or Graphs

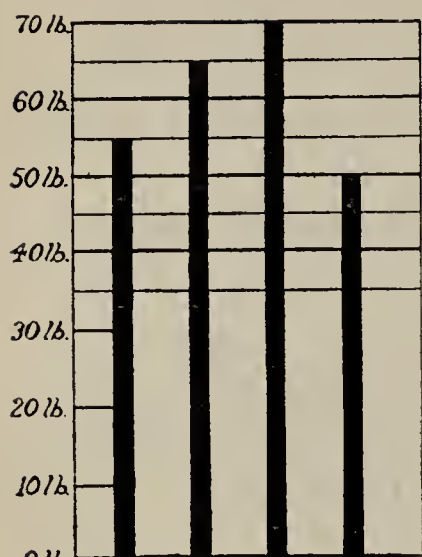

Charles Dick Fred Tom
Left-arm lift

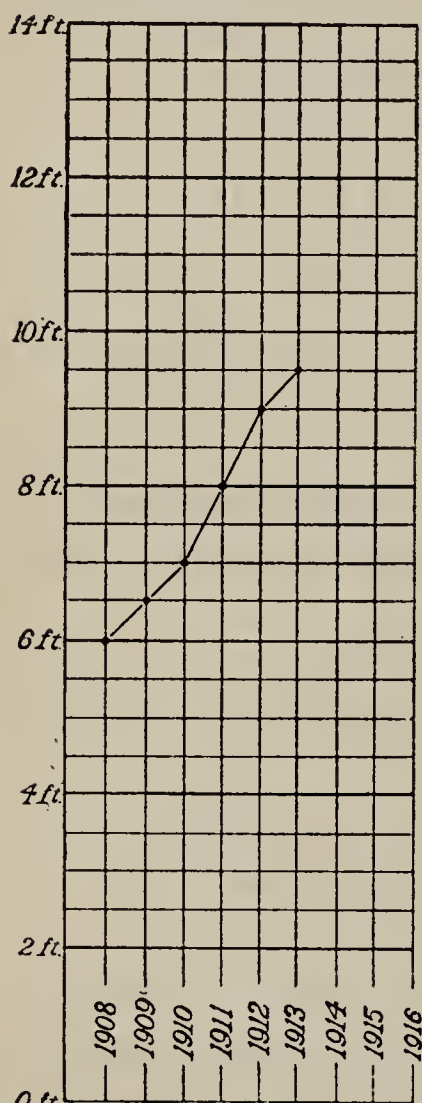

Records of Dick Allen
in the broad jump

1. According to the diagram how many pounds can Charles lift? How many can Dick lift? Fred? Tom?

2. Draw a diagram to show how many of the exercises in the arithmetic practice on page 165 each of these children did correctly, in 5 min.

Alice, who had 30 correct

Anna, who had 19 correct

Nell, who had 24 correct

Sarah, who had 36 correct

Let $\frac{1}{8}$ in. of distance up and down equal 1 exercise correct, 1 in. equal 8 exercises correct, etc.

3. Using thin paper trace and complete this diagram or graph, which tells how Dick Allen improved in the broad jump. His records were 8 ft. in 1911, 9 ft. in 1912, 9 ft. 6 in. in 1913, 10 ft. 6 in. in 1914, 13 ft. in 1915, and 13 ft. 6 in. in 1916.

4. Draw a diagram or graph to show how Elsie improved in repeated trials with the practice test on page 165.

Her scores in the 10 successive weeks were 17, 17, 19, 23, 22, 23, 24, 25, 24, 26.

5. Do the practice of page 165 twice a day for five days. Draw a graph showing how well you did in each trial and how much you improved.

Write the Sums

1.	2.	3.	4.	5.	6.	7.
392	587	463	566	475	839	972
939	634	132	999	130	423	402
349	549	94	294	120	732	919
756	865	147	295	146	598	303
<u>478</u>	<u>367</u>	<u>95</u>	<u>656</u>	<u>74</u>	<u>147</u>	<u>468</u>

8.	9.	10.	11.	12.	13.	14.
118	105	404	700	89	17	36
66	920	526	533	757	68	59
129	725	843	645	96	248	617
157	632	339	800	74	75	68
<u>87</u>	<u>408</u>	<u>932</u>	<u>446</u>	<u>935</u>	<u>226</u>	<u>824</u>

15.	16.	17.	18.	19.	20.	21.
450	748	954	856	490	364	411
475	796	842	888	225	412	532
425	736	830	708	635	448	545
400	672	948	750	545	576	533
<u>450</u>	<u>760</u>	<u>918</u>	<u>925</u>	<u>620</u>	<u>256</u>	<u>766</u>

Write the Products

22.	23.	24.	25.	26.	27.	28.
368	916	524	745	819	275	197
<u>57</u>	<u>38</u>	<u>76</u>	<u>63</u>	<u>112</u>	<u>308</u>	<u>72</u>

29.	30.	31.	32.	33.	34.	35.
\$4.08	\$2.59	\$2.40	\$3.00	\$9.75	\$1.75	\$2.88
<u>214</u>	<u>306</u>	<u>336</u>	<u>85</u>	<u>144</u>	<u>456</u>	<u>75</u>

36.	37.	38.	39.	40.	41.	42.
\$3.75	\$6.48	\$8.25	\$792	\$4.08	\$2.50	\$8.75
<u>230</u>	<u>76</u>	<u>105</u>	<u>54</u>	<u>200</u>	<u>108</u>	<u>90</u>

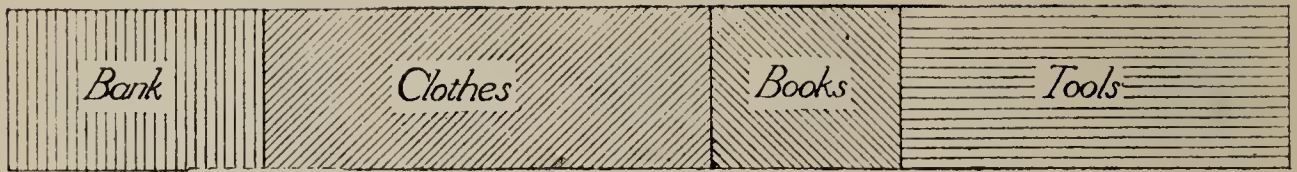

What William did with his earnings

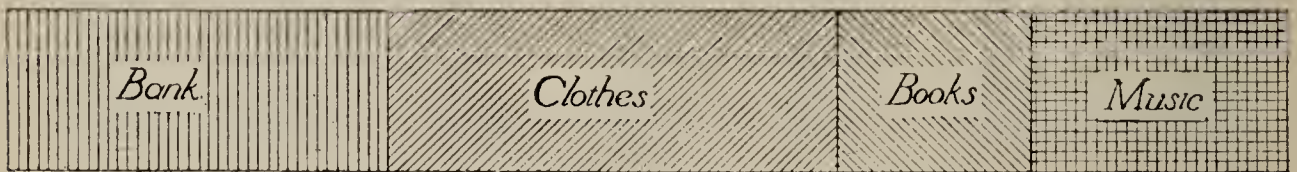
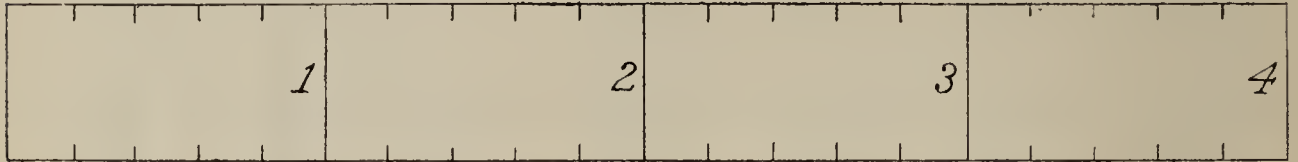

What Louise did with her earnings

1. These diagrams show what William and Louise did with the money which they earned last summer. Make a table showing what each of them did with the money. What percent of his money did William put in the bank?
2. What percent did he spend for clothes? For books? For tools?
3. What percent did Louise spend for clothes? For books? For music?
4. Draw diagrams to show what Alfred, Henry, Nathan, Mary, Norah, and Rose did with the money which they earned last summer. Make a copy of the 4-inch rule printed above to use in drawing these diagrams. Why is this better than a regular foot-rule?

	Alfred	Henry	Nathan	Mary	Norah	Rose
Percent in the bank	30	40	55	25	45	75
Percent spent for clothes	25	30	10	15	5	15
Percent spent for books	5	0	15	30	50	0
Percent spent for tools	40	30	5	0	0	0
Percent spent for music	0	0	15	30	0	10

5. What percent of 4 inches is $2\frac{4}{5}$ inches?
6. What distance equals 35 percent of 4 inches?

I. 30 boys in Richmond belong to a club that owns a camp on the Kiowa River. Some of them, who ride out to camp on their bicycles or motorcycles, wish to build a rough shed to keep the bicycles in. It will cost \$75. The question arises of how to pay for it. Find the right numbers for the places where the dots are:

1. Henry thought that each boy should be taxed $\frac{1}{30}$ of the cost or . . .
2. Joe thought that only those 12 boys who had bicycles or motorcycles should be taxed, each of them paying a tax of $\frac{1}{12}$ of the cost or . . .
3. Dick said, "A motorcycle should pay a higher tax than an ordinary bicycle, for it takes up more room and is more likely to cause a fire in the shed. I think the 9 boys who own bicycles should pay \$3 and the three boys who have motorcycles should each pay twice that, or . . . That will leave . . . If everybody also pays . . ., whether he has a bicycle or not, we shall have just enough."
4. They finally decided to levy a general tax of \$1.50 on each boy, an additional tax of \$2.00 on each of the 9 boys who have bicycles, and an additional tax of \$4.00 on each of the boys who have motorcycles. What percent of the total cost of the shed is to be paid
 - (a) by a boy who has no cycle?
 - (b) by a boy who has a plain bicycle?
 - (c) by a boy who has a motorcycle?

II. Five families in Amesbury own expensive camps side by side on Echo Lake. They plan to raise money to hire a man to live there all the time to protect the camp against fire, thieves, etc. They decide to tax themselves each year 3.6% of the value of the camps, each family to pay according to the value of its camp. Find how much each family should pay if the value of

The Eaton family's camp is	\$2000,
The Manly family's camp is	2500,
The Peters family's camp is	1800,
The Stevens family's camp is	3200,
The Williams family's camp is	2400.

36. Public Business. The Town or City as a Business Firm

1. Who owns the public-school buildings in your city or town?
2. Who owns the roads?
3. Name any other property that belongs to all the people of your city or town,— that is, to the public.
4. What is the total value of the public property of this town?

High-school building and equipment	\$ 45,000
Elementary-school buildings and equipment	110,000
Other public buildings and jail	38,000
Engine houses and equipment of fire department	27,000
Water works, water pipes, etc.	120,000
Washington Park	195,000
Roads, sidewalks, sewers, street lamps, etc. (estimated)	520,000

5. Do you know somebody who works for the public, who is employed by the city or town? What does he (or she) do? By whom are his wages paid?
6. What does a town pay per year for teachers' salaries (including principals), if it has:

1 principal of the high school, receiving	\$2200
3 principals of elementary schools, each receiving	1600
2 teachers, each receiving	1400
3 teachers, each receiving	1100
5 teachers, each receiving	1000
11 teachers, each receiving	900
8 teachers, each receiving	850
6 teachers, each receiving	800
4 teachers, each receiving	700
3 teachers, each receiving	600

7. Name some of the other features of the business of a town or city besides maintaining schools.
8. What percent of its total expenses for the year did this city spend for each of these features of its business?

Police department and courts	\$122,400
Fire department	108,600
Health department	59,000
Hospitals, asylums, etc.	143,200
Schools	395,000

Libraries	23,800
Parks and gardens	18,800
Sewers	13,400
Lighting, repairing, and cleaning the streets	282,600
Removing garbage	19,400
Water works	104,200
Other expenses	324,000
Total expenses	1,614,400

9. If it costs a city \$395,000 a year to educate 15,210 children, how much does it cost per child? (Find result to the nearest cent.)
10. If it costs \$18,800 per year for parks in a city of 51,200 inhabitants, how much does it cost per inhabitant for parks?

37. How a City or Town Obtains Money to Pay Its Bills

1. When the city or the town pays teachers, policemen, and firemen, or pays for a new fire engine, or for a band stand, or for repairing a street, in what way may the city or town obtain the money to pay with? Name as many ways as you can discover.

You may think of a city or town as a business firm. All the people who live there regularly are partners in the firm. Certain men (like the mayor, the aldermen, the selectmen, the school board) are chosen to carry on the business. You may think of them as the government of the city. The business of the city or town is to protect its inhabitants from thieves, murderers, and other criminals, to protect property against loss by fire, to protect the health of its inhabitants against contagious disease like typhoid fever or smallpox, and to do many other things.

The money to pay the expenses of a city or town comes mostly in four ways.

I. **A general tax on land and buildings.** Anybody who owns a piece of land or a building in the city is required to pay a certain percent of its value to the city, to be used to pay the expenses of the city.

1. In Salem each owner of a piece of land or a building is required to pay 1.8% of its value every year.

How much does each of these persons pay each year as a general tax?

Mr. A., who owns land and buildings in Salem valued at \$11,000
 Mrs. B., who owns land and buildings in Salem valued at 4,500
 Mrs. C., who owns land and buildings in Salem valued at 16,000
 Mrs. D., who owns land and buildings in Salem valued at 2,200

II. Special taxes or assessments on property. Anybody whose property is made more valuable by something the city does may be required to pay part of the expense.

2. Mr. E., Mr. F., Mr. G., and Mr. H. owned the land on Maple Street as shown in the diagram. The town put in sidewalks, and sewers, and macadamized part of the street and made other improvements, at a total cost of \$1800. Each man was required to pay an assessment of 3 cents for every square foot of land in his lot on Maple Street. How much was the assessment (a) For Mr. E.? (b) For Mr. F.?

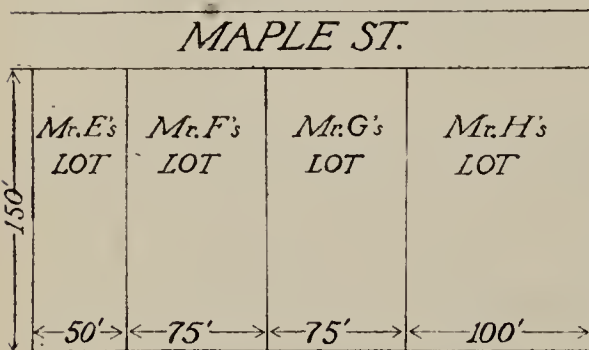

(c) For Mr. G.?

(d) For Mr. H.?

3. What percent of the total cost did the four men together pay?
4. How much was left for the city to pay out of city money?

III. Special licenses on special privileges. Anybody who keeps a dog may have to pay so much a year to the city. Anybody who sells drugs may be required to pay so much a year for a license or right to sell the drugs.

5. If a town receives \$2 from each of 721 persons for dog licenses, \$5 each from 14 men who are licensed to keep drug stores, \$25 for a license to keep a slaughter house, \$5 each from 16 persons who have lunch carts, pop-corn wagons, or peddlers' licenses, and \$368 from other special privileges, what is its total income from these taxes for special privileges?

IV. Regular payments for goods sold or work done by the city.

A city may sell water or electricity or gas, just as any water company or lighting company does. It may require the parents of children who come to its schools from out of town to pay for their children's education.

6. At 8 cents per thousand gallons what does a city receive for 196,750,000 gallons of water?
7. At \$24 for a child in the elementary school and \$36 for a child in the high school, what does a town receive from 32 out-of-town children attending high school, and 13 out-of-town children attending elementary schools?
8. The town of Glenville received \$29,410 from general taxes on land and buildings, \$1504 from special assessments for improvements, \$380 from licenses, and \$3460 from payments for water. (a) What is its total income? (b) What percent of the total income comes from the general tax on land and buildings?
9. The tax rate in Glenville is 18.3 mills on each dollar's worth of land and buildings, or \$1.83 on each \$100, or \$18.30 on each \$1000. What is the tax on a house and lot valued at \$4500?

38. Taxes: Assessed Valuation

Men are chosen to set a value on each piece of land and each building in a town. The value which they set is called the **assessed value** or **assessed valuation**. The tax each owner is required to pay is reckoned as a certain part of the assessed valuation. It is customary to make the assessed valuation less than the real value of the property.

Remember that 1 mill = \$.001 or 1 tenth of a cent.

I. Read, supplying the missing numbers:

- a. A tax rate of 19 mills on each dollar of assessed valuation means a tax of ...%
- b. A tax rate of \$21.30 on each \$1000 of assessed valuation means a tax of ...%

- c. A tax rate of \$1.64 on each \$100 of assessed valuation means a tax of ...%
- d. A tax rate of 18.6 mills on each dollar of assessed valuation means a tax of ...%
- e. A tax rate of 2.14% means ...mills on a dollar, or ...dollars on each \$100.
- f. The tax on \$2000 at the rate of 19 mills on a dollar or 1.9% = ...
- g. The tax on \$6000 at the rate of \$21 per thousand = ...
- h. The tax on \$4000 at the rate of \$2.12 per hundred = ...
- II. Tell the amount of tax to be paid on land and buildings —
- a. Of an assessed valuation of \$9000, the tax rate being 2.11%.
- b. Of an assessed valuation of \$2500, the tax rate being 20 mills on a dollar.
- c. Of an assessed valuation of \$3000, the tax rate being \$1.90 per hundred.

39. Review

- A town contains taxable property valued at \$1,246,000. If the town collects 1.7% on the value of the property, (a) how much money will it have to spend? (b) If 45% of the taxes collected are allotted to the school board to spend for schools, how much money will the school board have to spend for schools?
- At the rate of 1.76% how much will each of these property owners pay as his tax?
 Mr. A., who owns taxable property valued at \$6500.
 Mr. B., who owns taxable property valued at \$12,700.
 A company which owns taxable property valued at \$47,000.
- In 1910 the assessed valuation of the land and buildings in Dover was \$1,104,500. The tax rate was 1.83%. In 1915 the assessed valuation of the land and buildings in the town was \$1,302,000. The tax rate was 1.78%. How much more money was raised by tax in 1915 than in 1910? Find the answer to the nearest dollar.

When public or private business is done by several persons together, they need rules to follow in making decisions.

1. Suppose that your class has to decide about giving a present to the school. Would it be fair to decide when only 40% of the class were present?

A **quorum** is the number of persons who must be present at a meeting before the meeting has a right to do business.

2. In the Washington School, the rule is that $66\frac{2}{3}\%$ of a class is a quorum. How many must be present in a class of 36 pupils?
3. One of their rules about the number of votes necessary to decide is that a tax can be levied on members of the class only by a vote of 75% or more of those present. Would a vote of 23 ayes and 9 noes be enough to tax a class for a present for the school?
4. In deciding ordinary matters, "a *majority* of the votes cast is required." This means any number that is greater than $\frac{1}{2} \times$ (total number of votes cast). How many votes are required for a majority when the total vote is 20? When it is 25? When it is 33? 18? 15?
5. In voting for class president, the candidate receiving a plurality (that is, the highest number of votes) wins, even if he does not have a majority of the votes. If A has 15 votes, B 9, and C 8, who has a majority of votes? Who is elected?
6. The word "*majority*" is sometimes used to mean the number of votes *more than all other candidates together received*. For example, if X receives 200 votes, Y receives 75, and Z receives 25, X is said to win by a majority of 100. By what majority did D win in an election where D received 98 votes, E received 42, and F received 36?
7. The word "*plurality*" is sometimes used to mean the number of votes *more than the next highest* candidate received. For example, people would say that D won over E by a plurality of 56 (98-42). By what plurality did X win over Y in Ex. 6?

8. Hold an election, voting on which study is the most useful,— Arithmetic, Language, History, Geography, or Spelling. Count the votes. Has any study a majority of the votes? What is its plurality over the next highest study?

When you see or hear “majority” or “plurality” used, make sure which meaning it has.

When you use the word “majority” or “plurality,” make clear which meaning you intend it to have.

41. The Town or City as a Borrower

1. Would it be fair to make the people who happened to own property in a city or town in 1915 pay in that one year the entire cost of a new high-school building that would be used for the next twenty years? Tell why you answer as you do.
2. In 1916 a town builds a reservoir and lays the water pipes through the streets at a cost of \$20,000. The plan is to spread the payment over 20 years, paying most the first year, and less and less each year after that. So the town borrows \$20,000 Jan. 1, 1916, arranging to pay \$1000 Jan. 1, 1917, \$1000 Jan. 1, 1918, and so on. Each year the town also pays interest at 5% on the money it owes. State how much the town has to pay each year until all is paid. Say,

On Jan. 1, 1917, the town pays . . . interest and . . . on the principal.

On Jan. 1, 1918, the town pays . . . interest and . . . on the principal; etc.

A city or town can borrow money, just as any business firm can, if its credit is good or if it has security to offer. When a town borrows for a short time it borrows from a bank, just as any private business firm does.

When it borrows for a long time it borrows usually from the people who will lend it the money at the lowest rate of interest.

It can do this in two ways. It can announce, "*The city of XYZ wishes to borrow \$100,000 for 20 years. How low interest will you take?*"

Or it can announce, "*The city of XYZ wishes to borrow \$100,000 for 20 years at $4\frac{1}{2}$ percent. How much will you pay extra for the privilege of lending the city this money at this rate of interest?*"

3. Which would be a better bargain for a city: To borrow \$100,000 for 20 years at $4\frac{1}{4}\%$ interest, or to borrow \$94,000 for 20 years at $4\frac{1}{2}$ percent interest and be paid \$6000 cash down by the lender for the privilege of lending the money? Compare the amount of interest to be paid each year, and the amount of principal to be paid at the end of 20 years.
4. A city issues bonds due in 50 years bearing 5% interest payable semiannually. It receives for each \$1000 bond (that is, for each \$1000 that it promises to pay) \$1065. It issues 30 such \$1000 bonds. (a) How much cash does it receive for them? (b) How much interest does it have to pay every half year on them? (c) How much money must it pay to the owners of the bonds at the end of 50 years?
5. The streets, sewers, schools, parks, water works, and other public property of City A are valued at \$2,100,000. It owes money to the extent of \$1,735,000. What percent is the amount of the debt of the amount of public property?
6. Find what percent the number of dollars owed by each city is of the number of dollars that its public property is worth.

	City Debt	Value of Property Owned by City
City I	\$2,840,000	\$5,167,000
City II	2,620,000	3,274,000
City III	2,970,000	8,150,000
City IV	2,735,000	4,167,000

7. City G owes \$2,740,000, on which it pays interest at the average rate of $4\frac{3}{4}\%$. How much money does it have to pay each year for interest? It pays \$47,000 a year for the maintenance of its schools. How many times as much does it pay for interest as it pays for maintenance of schools?

The promises that a city or town or county makes to pay money that it borrows for a long time are usually in the form of a bond. For a city or town to issue bonds means simply that the city or town borrows money. For you to own a city's bond for \$500 simply means that that city owes you \$500. A city's bond is usually a very safe investment.

1. How much does the owner receive every year from each of these bonds?

- a. A \$500 bond, bearing interest at $4\frac{1}{2}\%$
- b. A \$1000 bond, bearing interest at $4\frac{1}{4}\%$
- c. Six \$100 bonds, bearing interest at 4%

2. Helen's grandmother left her a legacy of \$2500. Helen's father invested it for her in this way:

He paid \$524.00 for a \$500 New York City bond, bearing $4\frac{1}{2}\%$ interest.

He paid \$511.50 for a \$500 Penna. R. R. bond, bearing $4\frac{1}{2}\%$ interest.

He paid \$501.00 for a \$500 city of Springfield bond, bearing 4% interest.

He paid \$512.50 for a \$500 U. S. Steel bond, bearing 5% interest.

He put the rest of the money in the savings bank where it bears 4% interest.

- a. How much does Helen receive each year as interest from all the money?
 - b. How much more does she receive than she would if the entire \$2500 were put in the savings bank?
 - c. What percent does she receive on the average from the \$2500 invested?
3. Which is the better bargain for you, to pay \$507.50 for a city's bond on which you receive $4\frac{1}{2}\%$ interest on \$500 each year and \$500 at the end of 10 years, or to pay \$500 for a city's bond on which you receive 4% interest on \$500 each year and \$500 at the end of 10 years? (You may assume that both bonds are perfectly safe.)

43. How Cities Spend the Money Obtained from Taxes 177

- Examine this table and diagram. The numbers show the number of dollars out of every \$100 spent in all, that were spent for schools, libraries, parks, street sprinkling, police, and interest on debt.

	Schools	Libraries and Museums	Parks	Street Sprinkling	Police Dept.	Interest on Debt
City A	33.75	1.29	4.20	3.79	8.37	4.70
City B	12.76	.08	1.54	.25	14.78	25.66

The diagram shows how City A spends part of its money.

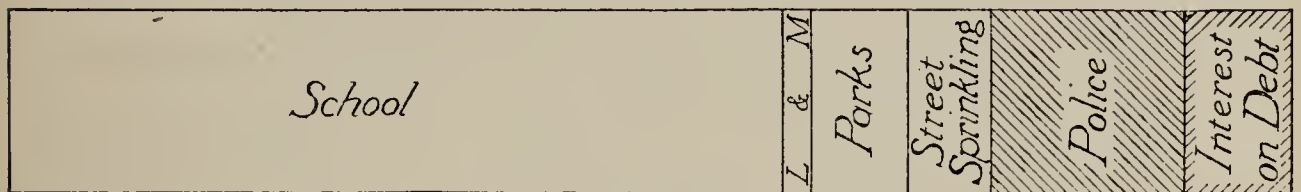

- Which fraction of an inch in the diagram represents \$1? Is it $\frac{1}{16}$, $\frac{1}{8}$, $\frac{3}{16}$, or $\frac{1}{4}$ in.?
- Make a rough diagram to show how City B spends its money.
- How many times as much did City A spend (out of \$100) for schools as City B?
- Compare the expenditures of the two cities for Libraries and Museums, for Parks, and for Interest on Debt.

44. Expenses for Schools

X and Y are two cities. City X spent \$54,614 on its schools. City Y spent \$58,427. The table shows how the money was spent in part.

	City X	City Y
Salaries of teachers	\$34,362	\$16,294
Textbooks and supplies	3,227	2,550
Janitors' salaries	2,172	4,931
Coal	4,804	9,411
Repairs	1,909	7,706
Other expenses	8,140	17,535
Total expenses for schools	<u>\$54,614</u>	<u>\$58,427</u>

Use the table at the bottom of page 177 to answer these questions:

1. What percent of the total expenses for schools in City X was for teachers' salaries?
2. What percent of the total expenses for schools in City Y was for teachers' salaries?
3. Make the same comparison, (a) For textbooks and supplies. (b) For janitors' salaries. (c) For coal. (d) For repairs.
4. Which city probably had the better teachers?
5. About how many times as much does City X spend for teachers' salaries as for textbooks and supplies?
6. A man in City Y claimed that if the city had not bought its coal from friends of politicians at high prices and hired friends of politicians to make repairs that were not needed, the expense for coal could have been reduced to $\frac{3}{4}$ of what it was and the expense for repairs to $\frac{2}{3}$ of what it was. (a) How much of a reduction would that have made? (b) If the money so saved had been spent to get better teachers, by what percent could the teachers' salaries have been increased? [Find results to the nearest cent in (a), and to the nearest tenth of a percent in (b)].

45. Expenses for Health

One of the best ways to spend public money is for the prevention of diseases. Public health is purchasable.

Draw graphs showing these facts:

1. By inoculation and other means the deaths in the Philippines from smallpox were reduced by 99% in 10 years.
2. As a result of public and private health work, the percent of persons having consumption who die from the disease has changed from 47 in 1851-1860 to 41 in '61-'70, to 39 in '71-'80, to 36 in '81-'90, to 28 in '91-'00, to 22 in 1900-'06.
3. The death rate from typhoid fever in an American city was reduced from 82 to 18 by improving the water supply.

This is a plan of a cross-section of half the width of a concrete road. 8' stands for 8 feet, 8" stands for 8 inches.

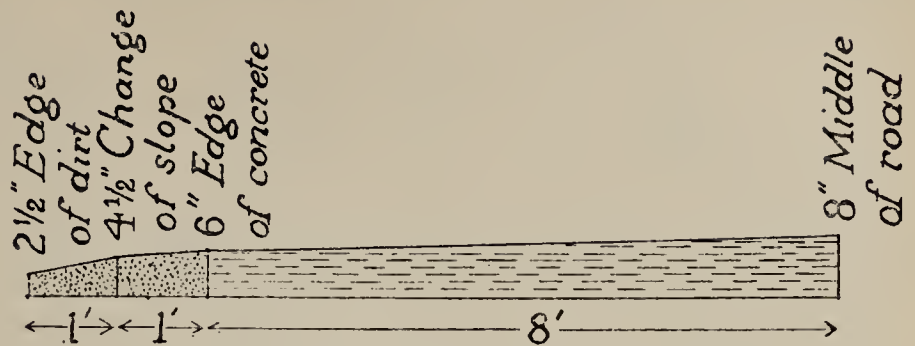

1. How thick is the concrete at the middle of the road?
2. How thick is the concrete at the edge of the concrete?
Supply the missing numbers:
3. The concrete part of the road rises ... inches from the edge to the middle, or ... inches for 8 feet of width, or ... inch per foot of width.
4. The dirt part of the road rises ... inches from the outside edge to the change of slope, or ... inches per foot of width. From the change of slope to the edge of concrete, it rises ... inch per foot of width.
5. From the edge of dirt to the middle of the road, there is a rise of ... inches in ... feet of width. The rise is ... percent of the width of half the road.
6. What will be the cost for interest for a year at $4\frac{1}{2}\%$ if a county borrows money enough to build 8.4 miles of such a road at \$13,500 per mile?
7. It costs the county \$32.50 per mile the first year to maintain the road in condition. The county also spends \$5000 each year to pay back part of the money which it borrowed. How much does the county pay the first year in all for interest, maintenance, and payment on debt?
8. It is estimated that 45,000 trips from one end to the other of this road are made by automobiles every year, 35,000 by heavy teams, and 30,000 by light teams. If 10¢ was paid to the county for each automobile trip, 12¢ for each trip by a heavy team, and 5¢ for each trip by a light team, how much income would the county receive per year from the use of the road?

47. Good Roads

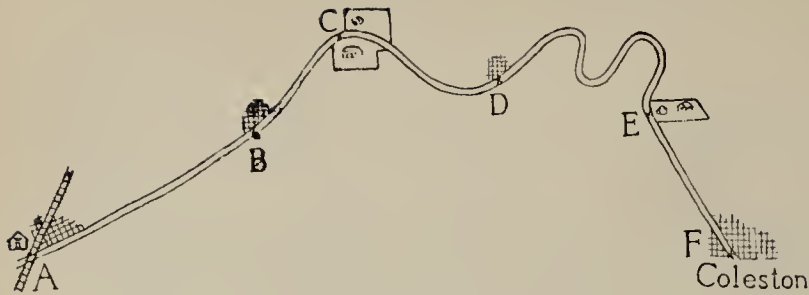

Here are a map and some facts about the road from the railroad station (at A) to Coleston (at F), as it was before it was improved.

A to B, 4.1 mi., bad turns, muddy. B to C, 2.2 mi., fairly good. C to D, 2.9 mi., very sandy. D to E, 3.85 mi., two bad hills. E to F, 2.4 mi., very sandy. It is a full day's work for 2 horses to pull a wagon plus a load of 1 ton from A to F or from F to A, and come back with the empty wagon.

1. How long was the road?
2. What percent of it was very sandy?
3. What percent of it was fairly good?
4. Counting the cost for a man, two horses, and a wagon for a day at \$4.80, what was the cost for hauling 9 tons from A to F?
5. Mr. Abbott estimated the total number of tons hauled from A to F or F to A per year as 1260. Counting 1 ton hauled 1 mile as *1 ton-mile*, how many ton-miles of hauling did he estimate as the traffic from A to F?
6. He estimated the hauling to villages on the way from A to F as 10,850 ton-miles. Using your result in Ex. 5, find the total ton-miles of traffic on the road, and the total cost at an average of \$.174 per ton-mile.
7. In 1914 the state spent \$15,500 on this road; and the towns through which it ran spent 50% as much as the state. How much was spent in all?
8. The road was made $6\frac{1}{2}$ percent shorter by cutting, filling, etc. How long was it at the end of 1915?
9. The cost per ton-mile for hauling was reduced from \$.174 in 1913 to \$.102 in 1915. What percent of \$.174 was the reduction?
10. How much will be saved this year by having the good road if 22,800 ton-miles of traffic are hauled at \$.102 per ton-mile instead of \$.174?
11. The number of bicycles owned in Coleston increased from 6 in 1913 to 14 in 1915. The number of automobiles owned

increased from 2 in 1913 to 8 in 1915. Express each increase as a percent of the number owned in 1913.

12. There are three roads from Lucy's house. One is an excellent state road. One is a fair dirt road with few hills. The third is hilly and sandy. Lucy's father reckons that on the state road his horse can haul 180% as much as on the sandy, hilly road and 150% as much as on the dirt road.
- If 3250 lb. is a proper amount to pull on the state road, what is a proper amount to pull on the sandy, hilly road?
 - What is a proper amount to pull on the fair dirt road?
 - If the wagon and driver weigh 600 lb., how many bushels of corn, weighing (with the bag) $56\frac{1}{2}$ lb. each, should be put on the wagon to make a proper amount to pull on the state road? (Find result to the nearest whole number of bushels.)
13. It is said that to pull a load of 1000 lb. on a nearly horizontal road requires the same effort as to pull a load of 540 lb. up a 4% grade or rise. What load for a 4% grade will require the same effort as a 2500 lb. load on a horizontal road?

48. Salaries of County Officers

Examine this table showing the salaries of some of the men who work for the public in three counties:

	Superintendent of Schools	Sheriff	Treasurer	Attorney	Assessor	Judge
County A	\$2400	\$4000	\$3000	\$3000	\$2400	\$2000
County B	2750	2300	2700	5000	2500	2250
County C	2000	3000	3000	2750	2750	3000

- Express each of the salaries of County A as a percent of the salary of the superintendent of schools of that county.
- Express each of the salaries of County B as a percent of the corresponding salary (that is, the salary of the same office) in County A.
- How much higher is the average salary for sheriff in these three counties than the average salary for the superintendent of schools?

Some of the public business of the United States is carried on by the cities and towns and counties. Some of it is carried on by separate states. Some of it is carried on by the national or federal government at Washington.

The chief expenses of the national government are for maintaining the army and navy, paying pensions to men who were in the army and navy, maintaining post-offices and carrying the mail, payments of interest on the nation's debts, and making public improvements.

- The expenses for post-offices and carrying the mail in a recent year were \$290,170,768. The receipts from postage stamps, money orders, etc., were \$287,934,566. (a) How much more was spent than was received? (b) The receipts of the postal department were what percent of the expenses? (Find the result to the nearest tenth of a percent.)
- The expenses for the army and the expenses for the navy for every fifth year from 1894 to 1914 are shown in this table. Copy and complete the diagram showing the facts of the table, but use 4 inches instead of 1 inch to represent \$100,000,000.

MILITARY EXPENSES OF THE UNITED STATES IN MILLIONS OF DOLLARS

	PER YEAR		Pensions for Service in War
	Army	Navy	
1894	55	32	141
1899	230	64	139
1904	115	104	143
1909	161	116	162
1914	174	140	173

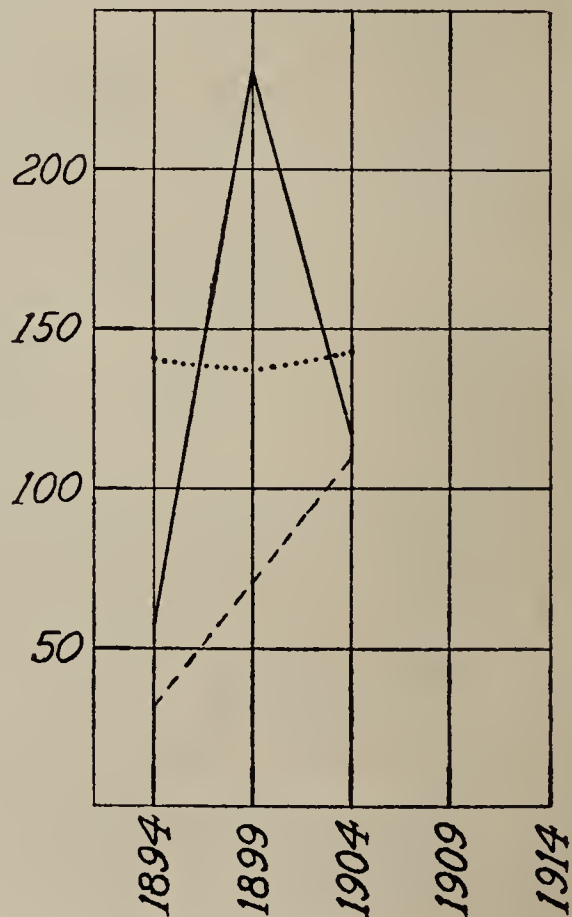

- By what percent did the yearly expense for the navy increase from 1894 to 1914?
- By what percent did the yearly expense for the army increase from 1894 to 1914?

The money to pay the expenses of the national government comes from taxes which are paid on articles brought into this country from other countries, from taxes on wines, liquors, beer, tobacco, and other articles, from special taxes paid by men and women who have large incomes, and from other sources.

1. In a recent year the people of this country paid \$38,077,844 tax on cotton goods, \$6,547,378 tax on china and earthen ware, \$17,665,994 tax on silk goods, \$53,039,304 tax on sugar, and \$41,900,693 tax on woolen goods. How much was paid in all five taxes together?
2. Mr. Straus bought 6 dozen sets of dishes from a man in England. He paid the man in England \$13.42 per set. He paid the United States government for the right to bring them into this country 40% of what he paid the man in England. How much did he pay in all?

*A sum of money paid to the government for the right to bring goods into this country is called a **tax on imports** or a **duty**.*

*A set of rules for the taxes on imports telling how much must be paid on each sort of goods is called a **tariff**.*

51. National Debts

A nation often borrows money either to pay for useful works of peace like the Panama Canal or to pay the cost of war.

1. The debt of the United States rose from \$88,000,000 to \$2,636,000,000 from 1861 to 1866 as a result of the Civil War. From 1866 to 1891 it fell to \$852,000,000. (a) How much did it increase per year on the average during the 5 years of war? (b) How much was paid off per year on the average during the 25 years of peace?
2. In the first year of the great European war, the Allies borrowed \$10,500,000,000 to pay part of the bills, at an average rate of 5%. (a) How much interest must be paid each year on this debt? (b) How many times as much did they borrow for a year of war as the United States paid to build the Panama Canal (\$375,000,000)?

3. If a nation can save \$500,000,000 a year during times of peace, and has to spend \$7,500,000,000 a year during war, (a) How many years of peace are needed to pay for each year of war? (b) What percent of the time can it be at war and still pay its bills?

52. Problems of the Home

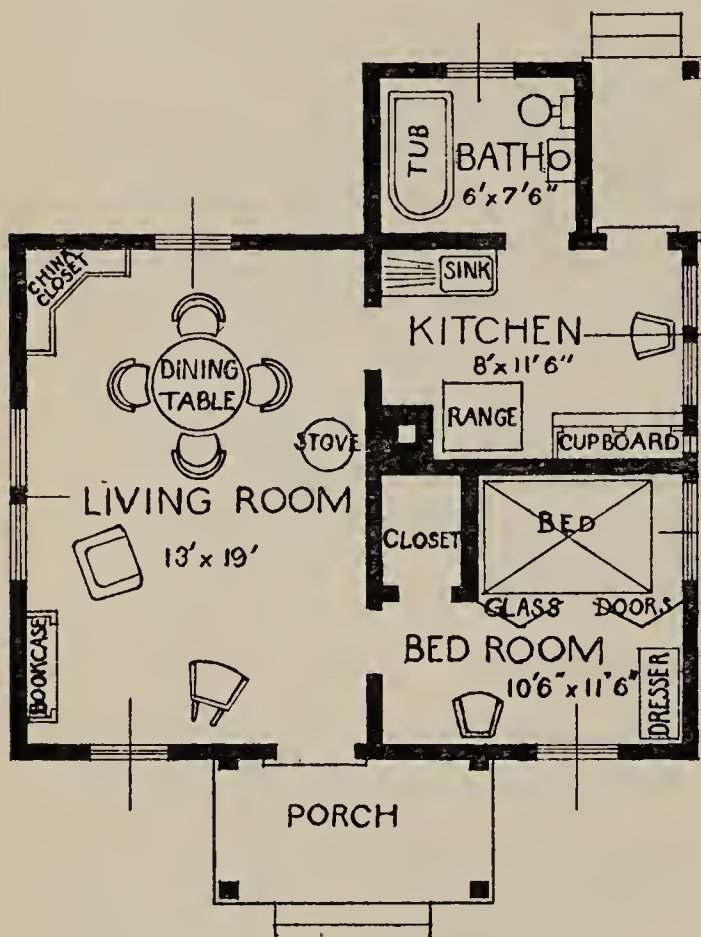

- (a) Find the outside length and width of this house (without the porch). Count 6 in. for each wall or partition. (b) Since $1\frac{1}{2}$ in. represents 19 ft., what represents 1 foot on this plan?
- Using prices decided upon by the class, find the cost of the furniture shown on the plan.
- The house cost \$900 to build; the lot cost \$250. House and lot rent for \$10 a month. What percent of the total cost is the rent for a year?
- It can be bought for the cost plus 10%, or on the installment plan for \$30 a month for four years. Figure out what a person will spend who borrows money at 6% interest to buy it for cash, paying at the end of each year \$287.50 plus the interest due.
- Find which is the better bargain, to buy on the installment plan or to borrow and pay as described in Ex. 4. You need not do any more work than is necessary to find out which is cheaper and to be able to prove that you are right.

1. Examine this table, which tells how families, each consisting of 2 adults and 2 children, planned to use their annual incomes. A family's *annual income* is the amount of money it has to spend per year. A family *budget* is a plan for using the money.

Make a similar table, but put in the number of dollars in each place instead of the percents or fractions.

	Burns Family	Dean Family	Williams Family	Hill Family	Allen Family
Total Annual Income	\$720	\$900	\$1200	\$1500	\$4200
Meat and groceries	42%	$\frac{2}{5}$	36%	35%	23%
Rent and carfare	20%	$\frac{1}{5}$	16 $\frac{2}{3}$ %	17.6%	20%
Operating expenses (see below)	8%	$\frac{1}{10}$	8%	9.4%	16%
Clothing	15%	$\frac{3}{20}$	16%	18%	16%
Higher life (see below)	8%	$\frac{1}{10}$	8 $\frac{1}{3}$ %	12%	10%
Savings, insurance, other investments, and fund for doctor's bills and emergencies	7%	$\frac{1}{20}$	15%	8%	15%

"Operating expenses" refers to money paid for heat, light, servants, repairs, furniture, bedding, etc. "Higher life" refers to money paid for charity, church, clubs and societies, books, music, etc.

2. Examine the table printed here and find: (a) Which family pays the largest percent of its income for meat and groceries. (b) Which family pays nearly twice as large a percent of its income for meat and groceries as the Allen family.
3. Examine the table you have written and find (a) which family pays the largest amount for meat and groceries. (b) Which family pays about a third as much money for meat and groceries as the Allen family?
4. Examine the table printed here and answer these questions for each family:
- (a) How many times as large a percentage of its income does the family allot for clothing as for savings, etc.? (b) For clothing as for higher life? (c) How many times as large a percentage of its income does the family allot for meat and groceries as for higher life? (d) For meat and groceries as for operating expenses?

54. Family Costs: Making Bread

1. A standard 5-cent loaf of bread weighs 12 ounces. 1 ounce of dough is lost in baking. How many ounces of dough are required to make six 5-cent loaves of bread?
2. It takes 8 ounces of flour to make one 5-cent loaf of bread. How many loaves would be made from a barrel of flour containing 196 lb., counting that none is wasted?
3. Find the cost per loaf for materials if the following materials make 380 loaves: — 1 bbl. flour at \$7.50; 6 lb. sugar at 6¢; 5 lb. lard at 18¢; salt, 3¢; 19 qt. milk at 8¢; yeast, 66¢.
4. Helen and her mother, Mrs. Fiske, make as much bread as is contained in 10 5-cent loaves each time that they bake bread. It takes $1\frac{1}{2}$ hours of Mrs. Fiske's time and 1 hour of Helen's time each time that they make bread. Counting the labor cost at 20¢ per hour for Mrs. Fiske and 8¢ per hour for Helen, what is the labor cost per 5-cent loaf of bread?
5. Mrs. Fiske and Helen do not count the labor cost because they enjoy making the bread, but they do count a general cost of 45¢ per 100 loaves made for wear and tear on the pans, soap for washing them, the extra coal used in cooking, etc. Using this fact and your answer to problem 3, find how much they save a year by making their own bread, counting that they use on the average two 5-cent loaves per day.
6. Would there be any saving supposing that they *did* count the labor cost as in problem 4?
7. Every 11 ounces of Mrs. Fiske's bread has as much nourishment as 12 ounces of baker's bread. How much baker's bread would they have to eat to get as much nourishment as they get from a pound of Mrs. Fiske's bread?
8. Write 5 problems about the cost of making bread in a big bakery, and selling it. Think of the cost of materials, cost of labor at the bakery, cost of rent of building, cost of maintaining a wagon to deliver the bread, cost of labor of the driver, and cost of making out and collecting bills and keeping accounts.

(In Ex. 1 to 7, use pencil only when you cannot do the work mentally.)

- State the exact cost of four eggs—
At 3¢ each. At 30¢ per doz. At 16 for 25¢.
At 25¢ per doz. At 40¢ per doz. At 35¢ per doz.
- State the exact cost of $\frac{1}{2}$ pt. cream—
At 40¢ per qt. At 50¢ per qt. At 60¢ per qt. At 75¢ per qt.
- State the exact cost of one article when you receive—
2 for 5¢. 3 for 10¢. 4 for 15¢. 6 for 25¢.
7 for 25¢. 8 for 25¢. 7 for 50¢. 15 for 25¢.
7 for 1¢. 8 for 1¢. 9 for 1¢. 9 for 25¢.
- State the exact cost of 3 lb. sugar when you pay—
5 $\frac{1}{4}$ ¢ per lb. 6 $\frac{1}{2}$ ¢. 5 $\frac{3}{4}$ ¢. 6 $\frac{1}{4}$ ¢. 5 $\frac{1}{2}$ ¢. 7 $\frac{1}{4}$ ¢.
When you receive 4 lb. for 25¢. 9 lb. for 50¢.
15 lb. for \$1.00. 32 lb. for \$1.50.
- State the exact cost for 18 articles, at the rate of—
10¢ each. \$2 per doz. \$1.50 per doz. 3¢ each.
- At the rate of \$1.00 per doz., what is the exact cost of 3 articles?
Of 4 articles? Of 5 articles?
- What is the cost of seven articles—
At \$1.25 each? At 15¢ each? At 18¢ each?
At 25¢ each? At 22¢ each? At \$2.50 each?
- Examine the table printed below. How much do you save
on a dozen cakes of each kind of soap if you buy by the
dozen instead of one at a time?

Kind of Soap	Number of Cakes per Box	Prices		
		Per Box	Per Doz.	Each
Smith's Laundry	112	\$5.10	\$.55	\$.05
Lenox	100	3.50	.45	.04
Copco	100	7.50	.90	.08
Colgate's Laundry	100	6.00	.75	.07
Fairy (large)	100	7.50	.90	.08
Fairy (small)	100	4.55	.55	.05

- How much do you save on a dozen cakes of each kind of soap
if you buy by the box instead of one at a time?
- How many times as much does Copco cost per 100 as Lenox
costs?
- Make four problems about these prices for the class to solve.

The price for strictly fresh eggs was 22¢ per doz. in Apr., May, and June, 25¢ in July, 28¢ in Aug., 30¢ in Sept., 34¢ in Oct., 40¢ in Nov., and 48¢ in Dec.

1. How much more did it cost for a cake containing 8 eggs in Dec. than in May?
2. How many times as much was the cost for fresh eggs in Nov. as in May for a family using 2 doz. per week in Nov. and 3 doz. per week in May?
3. How much would a family save by using fresh eggs as shown below instead of using six dozen every month?

Apr. 9 doz.	July 8 doz.	Oct. 4 doz.
May 9 doz.	Aug. 6 doz.	Nov. 3 doz.
June 8 doz.	Sept. 5 doz.	Dec. 2 doz.

4. When eggs sell to the family in New York at 32¢ per doz. the money is said to go as follows:

To the farmer who produces the eggs	\$.205
To the shipper for cases, handling, etc.	.0123
To transportation charges	.0106
To the commission merchant	.01
To the jobber (wholesale dealer) for his expenses	.024
To the jobber for his risk and labor	.011
To delivering to the retailer	.004
To the retail dealer for his expenses	.0281
To the retail dealer for his risk, labor, and profit	.01497

What percent of the 11½ cents that the family pays (more than the farmer receives) goes (a) To the commission merchant? (b) To the jobber for his risk and labor? (c) To the retail dealer for his risk and labor?

5. If a commission merchant pays \$7200 per year for rent, clerks, telephone, and other expenses, how many dozen eggs must he sell per year to pay expenses? (Count the commission merchant's profit as the amount stated in the table above.)
6. If the farmer's expenses for keeping and feeding his hens (except his own labor and skill) are 11¾¢ per dozen, how many dozen eggs must he produce per day to earn \$1.75 a day for his labor and skill? (Count the farmer's receipts per dozen eggs as the amount stated in the table above.)

This table shows how much of certain sorts of food that we buy is not eaten or is *refuse* (like the peel of a banana or the bones of a fish) and how much of what is eaten is “*water*,” “*nourishment*,” and “*more or less useful in other ways*.”

1. Read each line, saying, “Of a banana, 35% is not eaten. Of what is eaten, 75.3% is water, 23.9% is nourishment, and 0.8% is more or less useful in other ways.”

	Refuse	Edible Portion		
	Not Eaten	Water	Nourishment	Otherwise Useful
Bananas	35.0	75.3	23.9	0.8
Baker's bread	0.0	35.3	63.6	1.1
Beef (round steak)	7.0	70.0	28.9	1.1
Cabbage	15.0	91.5	7.5	1.0
Flour	0.0	11.9	87.5	0.6
Milk	0.0	87.0	12.3	0.7
Potatoes	10.0	78.3	20.7	1.0
Sugar	0.0	0.0	100.0	0.0

2. Find how many pounds of refuse, how many pounds of water, how many pounds of nourishment, and how many pounds of otherwise useful food substances you receive in each of these cases:
 - a. When you buy 20 loaves of bread weighing 12 oz. each.
 - b. When you buy 5 doz. bananas weighing 14 lb.
 - c. When you buy 4 lb. round steak.
 - d. When you buy a crate of cabbage weighing 40 lb.
 - e. When you buy 30 lb. of flour.
 - f. When you buy 13 qt. milk.
 - g. When you buy 60 lb. potatoes.
 - h. When you buy 18 lb. sugar.
3. Counting that each of the purchases of problem 2 costs \$1.00, how many times as much nourishment do you get for a dollar—
 - (a) When you buy milk as when you buy steak?
 - (b) When you buy potatoes as when you buy steak?
 - (c) When you buy sugar as when you buy steak?
 - (d) When you buy flour as when you buy steak?

Sugar is very nourishing, but it does not provide all the substances that the body needs. The body needs Proteins, Fats, Carbohydrates, Iron, Phosphates, Water, and other things.

This table tells what percent of each food eaten is Protein, what percent is Fat, what percent is Carbohydrates, and what percent is Iron.

	Protein	Fat	Carbohydrates	Iron
Bread	9.2	1.3	53.1	.0009
Butter	1.0	85.0	0.0	.0000
Cheese	25.9	33.7	2.5	.0000
Chocolate	12.9	48.7	30.3	.0000
Eggs	13.4	10.5	0.0	.0019
Milk	3.3	4.0	5.0	.00034
Peanuts (shelled)	25.8	38.6	24.4	.00035
Potatoes	2.2	0.1	18.4	.0015
Sugar	0.0	0.0	100.0	.0000
Wheat flour	11.4	1.0	75.1	.0015

1. How many pounds of protein, how many pounds of fat, how many pounds of carbohydrates, and what fraction of a pound of iron are eaten when 50 lb. bread, 4 lb. butter, and 10 lb. milk are eaten?
2. When 50 lb. bread, 4 lb. cheese, and 10 lb. potatoes are eaten?
3. When 50 lb. bread, 4 lb. peanuts, and 10 lb. milk are eaten?
4. What is the weight of the protein in a cake made of 2 lb. flour, 1 lb. milk, 8 eggs (call 8 eggs 1 lb.), $\frac{1}{4}$ lb. butter, 1 lb. sugar? What is the weight of the carbohydrates in it? Of the fats in it?
5. What is the weight of protein in a 12-oz. loaf of bread, 4 oz. of cheese, and 1 pint of milk (count 1 pt. as 1 lb.)? What is the weight of the carbohydrates? Of the fats?
6. What is the weight of each (protein, carbohydrates, fat) in a 12-oz. loaf of bread, 2 oz. butter, and 2 oz. sugar?
7. Counting 8 eggs to a pound, find the amount of protein, of fat, and of carbohydrates in an omelet of 4 eggs and $\frac{1}{2}$ pt. milk.

The proteins are needed by a boy or girl to repair wear and tear of the body and make it grow. The fats and carbohydrates are needed to furnish the energy to enable the boy or girl to work and play and the heat to keep the body warm.

1. A large and growing boy or girl 14 years old would be able to grow and work and play on 4 oz. of protein, 4 oz. of fats, and 16 oz. of carbohydrates per day. How much more of each sort than this would be contained in 1 qt. milk (2 lb.), two 5-cent loaves of bread (12 oz. each), 3 oz. of butter, 4 eggs ($\frac{1}{2}$ lb.), and 2 oz. sugar?
2. A daily ration containing 4 oz. protein, 3 oz. fats, and 18 oz. carbohydrates would possibly do as well. How much more of each sort than this would be contained in $1\frac{1}{2}$ lb. bread, $\frac{1}{2}$ lb. cheese, 2 lb. milk, and $1\frac{1}{2}$ lb. potatoes?
3. Is the trouble with a ration of 3 lb. of bread and 4 oz. of butter per day that it is not nourishing enough?
4. How much protein, fat, and carbohydrates does a camper carry in a 1-lb. cake made half of chocolate and half of sugar?
5. How much does he carry in a pound of sandwiches composed of 2 parts by weight of bread, and 1 part of cheese?

Regular milk contains 3.3% protein, 4.0% fat, and 5.0% carbohydrates. A standard brand of condensed milk contains 8.8% protein, 8.3% fat, and 54.1% carbohydrates. Cheese contains 25.9% protein, 33.7% fat, and 2.5% carbohydrates.

6. Compare the protein, fat, and carbohydrates in 2 qt. (4 lb.) of milk and $\frac{3}{8}$ lb. sugar with those in 1 lb. condensed milk.
7. (a) How many times as much protein is there in a pound of condensed milk as in a pound of ordinary milk? (b) How many times as much fat? (c) How many times as much carbohydrates?
8. How many pounds of ordinary milk will contain as much fat as 1 pound of cheese?
9. How many pounds of ordinary milk will contain as much protein as 1 pound of cheese?

If a person ate only one sort of food, the costs for materials would be:

- 8¢ per day if he ate only wheat flour at 4¢ per pound
- 10¢ per day if he ate only oatmeal at 6¢ per pound
- 10¢ per day if he ate only sugar at 6¢ per pound
- 14¢ per day if he ate only potatoes at 90¢ per bushel
- 16¢ per day if he ate only fat pork at 20¢ per lb.
- 28¢ per day if he ate only milk at 6¢ per qt.
- 88¢ per day if he ate only round steak at 20¢ per lb.
- \$1.14 per day if he ate only eggs at 30¢ per doz.

What would be the cost per day —

1. If he ate only sugar at 9¢ per lb.?
2. If he ate only potatoes at \$1.20 a bu.?
3. If he ate only potatoes at \$1.50 per bu.?
4. If he ate only milk at 8¢ per qt.?
5. If he ate only milk at 4¢ per qt.?
6. If he ate only eggs at 40¢ per doz.?

61. Grading Foods

In the high-school class in household science, they give marks (1, 2, 3, 4, or 5) to different foods for —

Nourishment per dollar spent.

Healthfulness.

Taste and value in making the rest of the meal attractive.

Ease of preparation.

1 is *very poor*; 2 is *poor*; 3 is *fair*; 4 is *good*; 5 is *excellent*.

1. 35 children marked milk. It received two 5s, sixteen 4s, twelve 3s, and five 2s for "*Nourishment per dollar spent*." What was the average mark given to it by the class for "*Nourishment per dollar spent*"?
2. Milk received twenty-eight 5s, five 4s, and two 3s, for "*Healthfulness*." What was the average mark for "*Healthfulness*"?
3. It received eighteen 5s, ten 4s, six 3s, and one 2 for "*Taste, etc.*" What was the average mark for "*Taste, etc.*"?
4. Ask your teacher to let you vote (a) on oatmeal and (b) on eggs; and find what average marks your class gives to each.

1. A certain pattern is stated to require 6 yd. of material 20 in. wide, or $4\frac{3}{4}$ yd. 27 in. wide, or $3\frac{3}{4}$ yd. 36 in. wide, or $3\frac{3}{8}$ yd. 44 in. wide. If the same material can be bought in 20-in. width for 40¢ per yard, in 27-in. width for 54¢ per yard, in 36-in. width for 72¢ per yard, and in 44-in. width for 88¢ per yard, which is the cheapest width to buy?
2. What is the exact amount of material (in sq. yd.) used in each of the four cases?
3. No. 7064 requires $2\frac{7}{8}$ yd. 27 in. wide or $2\frac{1}{8}$ yd. 36 in. wide. How much difference is there between these two amounts of material?
4. A certain pattern is said to require $3\frac{7}{8}$ yd. 27 in. wide, or $3\frac{3}{8}$ yd. 36 in. wide, or $2\frac{1}{8}$ yd. 44 in. wide. Which width requires the least material measured in sq. yd.?
5. A certain cloth is sold in widths of 36, 40, 42, 44, and 50 inches wide. At 45¢ per yard for the 36-in. width, about what should you pay per yard (a) For the 40-inch width? (b) For the 44-inch width? (c) For the 50-inch width?
6. Make three easy, and three hard, problems for the class to solve, using these facts:

A pattern for a child's wrapper requires cloth as follows:

	Age of Child				
	3 Yr.	5 Yr.	7 Yr.	9 Yr.	11 Yr.
Goods, 27 in. wide	$3\frac{1}{2}$	4	$4\frac{1}{2}$	5	$5\frac{1}{2}$
Goods, 36 in. wide	$2\frac{3}{8}$	3	$3\frac{1}{2}$	4	$4\frac{1}{2}$
Goods, 44 in. wide	$2\frac{1}{4}$	$2\frac{1}{2}$	$2\frac{3}{4}$	$3\frac{1}{8}$	$3\frac{1}{2}$

7. How many inches wide is cloth that is (a) $1\frac{1}{9}$ yd. wide? (b) $1\frac{2}{9}$ yd. wide? (c) $1\frac{1}{4}$ yd. wide? (d) $\frac{3}{4}$ yd. wide?
8. What fraction of a yard wide is cloth that is (a) 18 in. wide? (b) 20 in. wide? (c) 24 in. wide? (d) 30 in. wide? (e) 40 in. wide? (f) 44 in. wide?
9. A suit requires (for a medium size) 7 yards of velveteen 40 inches wide. About how much will be required if a cloth 44 in. wide is used, if this cloth cuts to fit the pattern as well as the 40-in. width?

63. Family Measurements

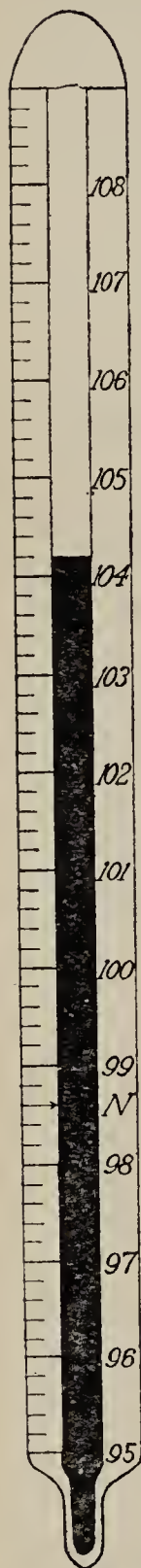

- Examine this picture of a thermometer. It is the sort of thermometer which a doctor or nurse uses to tell whether you have fever. When a person is well and has no fever the temperature of his body is about 98.6 degrees. How high will it be if it rises $2\frac{1}{2}$ degrees?
- 98.6 degrees is called the normal temperature or "normal." How much above "normal" is a temperature of 104.2?
- Examine this temperature chart for Henry during an ordinary attack of measles. 1, 2, 3, 4, etc., mean days; M and E mean morning and evening; 98°, 99°, etc., mean 98 degrees, 99 degrees, etc. On what day was Henry's temperature highest? How much above normal was it then?
- For how many days was Henry's temperature above $101\frac{1}{2}$?
- How much higher on the average was the E temperature than the M temperature?
- How many times as far above normal was Henry's temperature on the evening of the third day as on the evening of the second day?

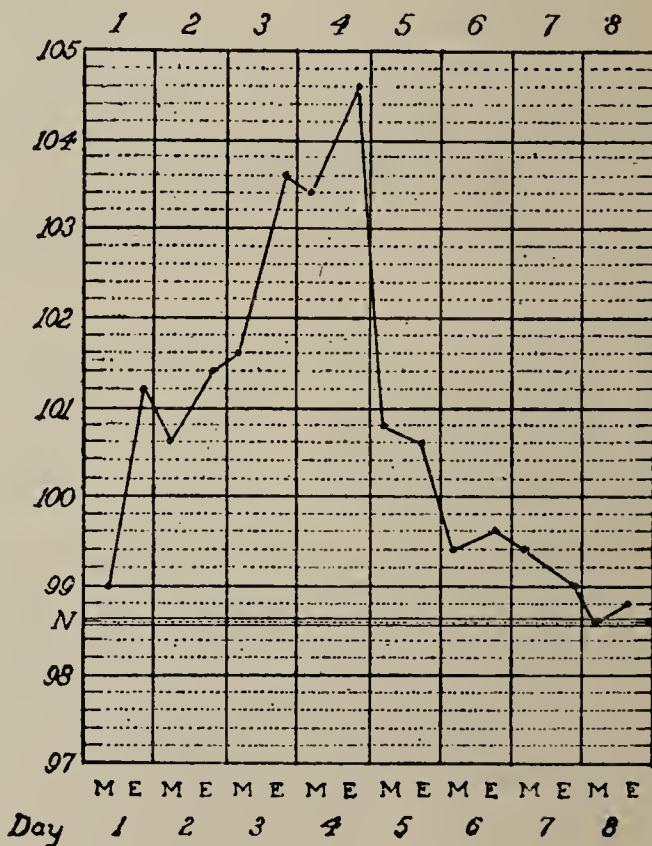

- Make two problems about Henry's temperature chart for the class to solve.

The children kept this record of the temperature of the school-room during February:

Room Temperatures

	9:30	10:30	11:30	1:30	2:30
Feb. 1	62	70	72	68	70
Feb. 2	67	73	74	73	75
Feb. 3	64	72	71	72	73
Feb. 4	65	71	70	69	71
Feb. 5	66	74	75	71	70
Feb. 8	63	69	71	70	70
Feb. 9	68	75	76	70	69
Feb. 10	65	71	70	69	71
Feb. 11	62	68	69	68	70
Feb. 15	68	71	72	71	70
Feb. 16	70	76	76	73	74
Feb. 17	68	70	71	68	67
Feb. 18	66	69	71	70	70
Feb. 19	65	68	70	67	66
Feb. 23	64	68	71	66	68
Feb. 24	66	71	72	72	70
Feb. 25	67	73	75	73	73
Feb. 26	67	72	73	69	71

1. *a.* What was the average temperature at 9:30?
- b.* What was the average temperature at 10:30?
- c.* What was the average temperature at 11:30?
- d.* What was the average temperature at 1:30?
- e.* What was the average temperature at 2:30?
2. In what percent of the 90 observations was the temperature only 63 degrees or lower?
3. In what percent of the observations was the temperature 73 degrees or higher?
4. Calling a temperature of 66, 67, 68, 69, or 70 "*satisfactory*," what percent of the temperatures were "*satisfactory*"?
5. Examine the diagrams on p. 196. Read the diagram for School A, saying, "On 2 days, the temperature was 67°; on 4 days it was 68°; on 5 days it was 69°"; etc. Find what percent of the days were "*satisfactory*" as to temperature in School A. In School B.

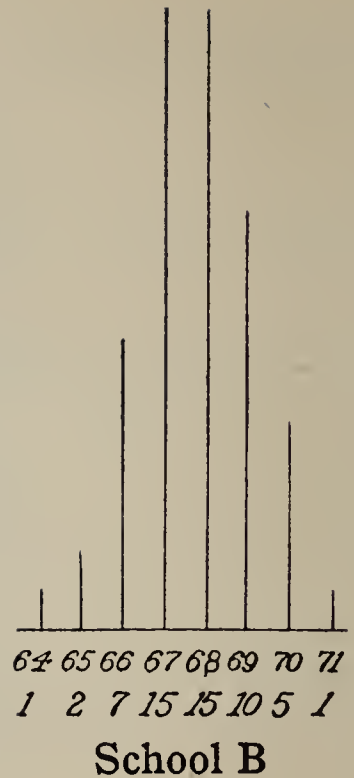
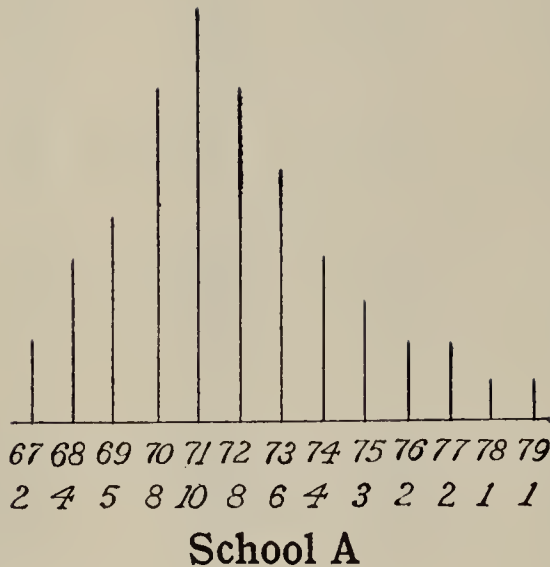

6. Tell whether it grew hotter or colder from 6 A.M., Jan. 6, to 6 A.M., Jan. 7, and how many degrees rise or fall of temperature there was. Do the same for the change from Jan. 7 to Jan. 8, for the change from Jan. 8 to Jan. 9, etc.

TEMPERATURE AT
6 A.M.

Jan. 6	14 above zero
Jan. 7	8 above zero
Jan. 8	6 below zero
Jan. 9	11 below zero
Jan. 10	9 above zero
Jan. 11	33 above zero
Jan. 12	21 above zero

7. Draw a diagram showing the way the temperature changed from Jan. 6 to Jan. 12. (a) What fraction of an inch will you use to represent one day if you wish to make your diagram $3\frac{1}{2}$ inches wide? (b) What fraction of an inch will you use to represent one degree if you wish to make your diagram about $5\frac{1}{2}$ inches from the top to the bottom? (c) Compare your diagram with those of the other pupils, with respect to accuracy, neatness, and clearness.

1. Nell and Dick made candy to sell at the church fair. They put in 5 lb. sugar, 1 lb. milk, $\frac{1}{8}$ lb. butter, and $\frac{1}{4}$ lb. chocolate. How many pounds of material did they use?
2. When the candy was made they weighed it. They had just $5\frac{1}{4}$ lb. How much of the materials they put in had gone off in bubbles or stuck to the kettle?
3. How many quarter-pound boxes will $5\frac{1}{4}$ lb. candy fill? How many yards of ribbon will it take to tie up the boxes of candy if each box requires $\frac{7}{8}$ yd.?
4. Mrs. Lewis used 5 quarts of currant juice and 5 quarts of sugar syrup to make jelly. She filled 32 half-pint jars with jelly. How much of her materials boiled away or stuck to the kettle?
5. In a $7\frac{1}{2}$ -lb. roast of beef $1\frac{1}{8}$ lb. was refuse (refuse means gristle, bone, etc., that cannot be eaten). What percent was refuse?
6. Counting that chickens, as purchased at the market, contain 38% refuse, how much edible meat do you obtain from $8\frac{1}{2}$ lb. chicken? What is the cost per pound of the edible portion, when the cost per pound of the chicken as purchased is 24¢?
7. How many shirt-waist lengths of $2\frac{1}{2}$ yd. each can be cut from 20 yards of cloth?
8. An ordinary gas burner consumes about 7 ft. of gas per hr. How much will it cost per week when gas is \$1.20 per 1000 ft., if two burners are kept lighted for an average of 3 hours a day and four other burners are kept lighted for an average of 30 min. per day?
9. A 16-candle-power tungsten lamp uses 25 watts of electricity per hr. What is the cost per hour for electricity at 12¢ per kilowatt? (1 kilowatt = 1000 watts.)
10. An electric toaster takes 400 watts per hour. How much does it cost to use it for 15 minutes at 12¢ per kilowatt?
11. Find the answers to Ex. 9. and 10, if the cost of electricity is reduced to 10¢ per kilowatt.

1. Examine this table. Supply the missing numbers for the last four lines:

The square of 2 is 4.	The cube of 2 is 8.	$2^2 = 2 \times 2.$	$2^3 = 2 \times 2 \times 2.$
The square of 3 is 9.	The cube of 3 is 27.	$3^2 = 3 \times 3.$	$3^3 = 3 \times 3 \times 3.$
The square of 4 is 16.	The cube of 4 is 64.	$4^2 = 4 \times 4.$	$4^3 = 4 \times 4 \times 4.$
The square of 5 is 25.	The cube of 5 is 125.	$5^2 = 5 \times 5.$	$5^3 = 5 \times 5 \times 5.$
The square of 6 is ..	The cube of 6 is ...	$6^2 = .. \times ..$	$6^3 = .. \times .. \times ..$
The square of 7 is ..	The cube of 7 is ...	$7^2 = .. \times ..$	$7^3 = .. \times .. \times ..$
The square of 8 is ..	The cube of 8 is ...	$8^2 = .. \times ..$	$8^3 = .. \times .. \times ..$
The square of 9 is ..	The cube of 9 is ...	$9^2 = .. \times ..$	$9^3 = .. \times .. \times ..$

2. State what the square of a number is. Make your statement clear.
3. State what the cube of a number is.
4. *a.* How much is 10^2 ? *b.* How much is 11^2 ? *c.* How much is 12^2 ? *d.* How much is 10^3 ?
5. How much less is 8^2 than 82?
6. How much more is 10^3 than 103?
7. How much more is 4^3 than 43?
8. Copy and supply the missing numbers as shown in the first line:

The square of 1.3 is 1.69. 1.3^3 is 2.197.

The square of 2.1 is 2.1^3 is

The square of 2.5 is 2.5^3 is

The square of 3.2 is 3.2^3 is

The square of 4.5 is 4.5^3 is

The square of 11 is 11^3 is

The square of 20 is 20^3 is

The square of 30 is 30^3 is

The square of 100 is 100^3 is

$15^2 = \dots$ $15^3 = \dots$

$10^2 = \dots$ $10^3 = \dots$

If l = the length of one side of a square —

The perimeter of a square = $4l$.

The area of a square = l^2 .

9. What will be the area of a square if $l = 3.7$?

10. Suppose that squares are drawn on each of these lines as base, as is done for line *a*. What will be the perimeter of the square on *b*? What will be its area?

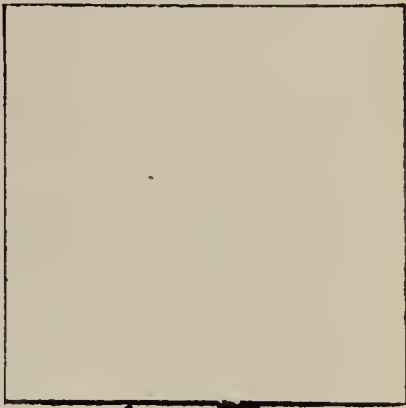

11. Answer the same question for *c*, *d*, *e*, and *f*.

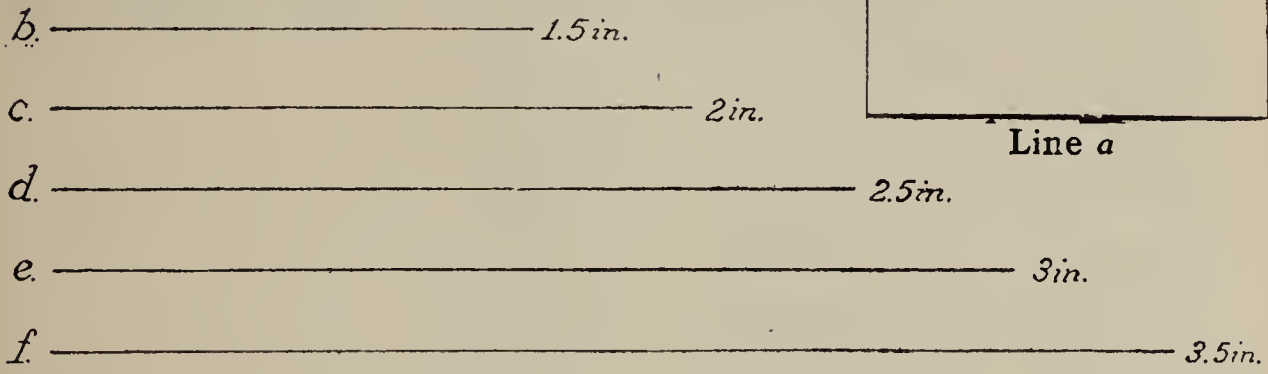

12. Suppose that cubes are made on each of these lines as one edge, as is shown for line *a* here.

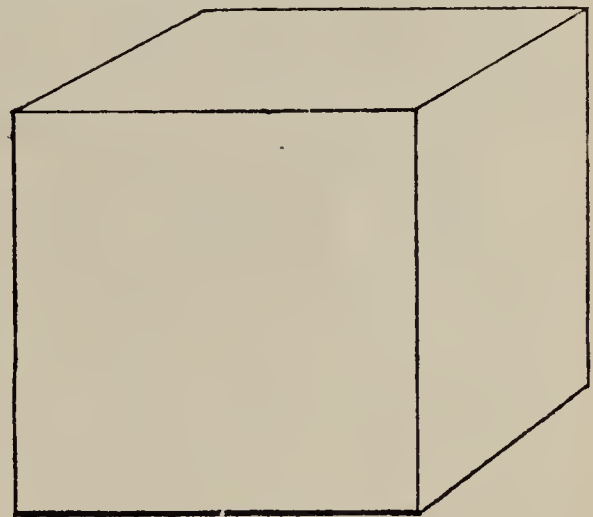

13. What will be the volume of the cube on line *b* as edge?
 14. What will be the volume of the cube on line *c* as edge?
 15. What will be the volume of the cube on line *d* as edge?
 16. What will be the volume of the cube on line *e* as edge?

17. Copy this table. Supply the missing squares and cubes in this table. Preserve your copy of this table for future use.

	Square	Cube		Square	Cube		Square	Cube
.1	.01	.001	1.1	1.21	1.331	2.1	9.261
.2	.04	1.2	2.2	4.84
.3	.09	.027	1.3	2.197	2.3
.4	1.4	1.96	2.744	2.4	13.824
.5	.25	1.5	2.5	15.625
.6	1.6	2.56	4.096	2.6	6.76
.7	.49	1.7	2.7	19.683
.8512	1.8	3.24	2.8	7.84
.9	1.9	6.859	2.9	8.41	24.389
1.0	1.00	1.000	2.0	3.0	27 000

67. Square Roots and Cube Roots

1. Examine this table. Supply the missing numbers in the last 5 lines. $\sqrt{\quad}$ means "square root of."

The square root of 16 is 4. $4 \times 4 = 16.$ $\sqrt{16} = 4.$

The square root of 484 is 22. $22 \times 22 = 484.$ $\sqrt{484} = 22.$

The square root of 25 is 5. $5 \times 5 = 25.$ $\sqrt{25} = 5.$

The square root of 400 is 20. $20 \times 20 = 400.$ $\sqrt{400} = 20.$

The square root of 49 is ... $\sqrt{49} = \dots$

The square root of 81 is ... $\sqrt{81} = \dots$

The square root of 36 is ... $\sqrt{36} = \dots$

The square root of 64 is ... $\sqrt{64} = \dots$

The square root of 100 is ... $\sqrt{100} = \dots$

2. Tell what the "square root of a number" means.

Tell the value of each of these:

$$4^2 \quad 4^3 \quad \sqrt{4} \quad \sqrt{36} \quad \sqrt{9} \quad 9^2 \quad 2^2 \quad 2^3 \quad \sqrt{49} \quad \sqrt{144}$$

3. Examine this table. Supply the missing numbers in the last three lines, estimating. If your first estimate is wrong, try again. $\sqrt[3]{\quad}$ means "cube root of."

The cube root of 8 is 2. $\sqrt[3]{8} = 2.$ $2 \times 2 \times 2 = 8.$

The cube root of 64 is 4. $\sqrt[3]{64} = 4.$ $4 \times 4 \times 4 = 64.$

The cube root of 3375 is 15. $15 \times 15 \times 15 = 3375.$

The cube root of 27 is ...

The cube root of 1000 is ...

The cube root of 125 is ...

4. Supply the missing numbers:

Since the cube of 3 is 27, the cube root of 27 is .. $\sqrt[3]{27} = \dots$

Since the cube of 4 is 64, the cube root of .. is .. $\sqrt[3]{64} = \dots$

Since the cube of 6 is 216, the cube root of .. is .. $\sqrt[3]{216} = \dots$

Since the cube of 7 is 343, the cube root of .. is .. $\sqrt[3]{343} = \dots$

5. Think how to use your copy of the table on page 199 to find the square root of 121, 324, 625, 144, 361, 784, 484, 289, 441, and 225.

Rule I

In a right triangle the square of the hypotenuse (the longest side) equals the sum of the squares of the other two sides.

1. Find the area of square *a*.
2. Of square *b*.
3. Of square *c*.
4. Of square *d*.

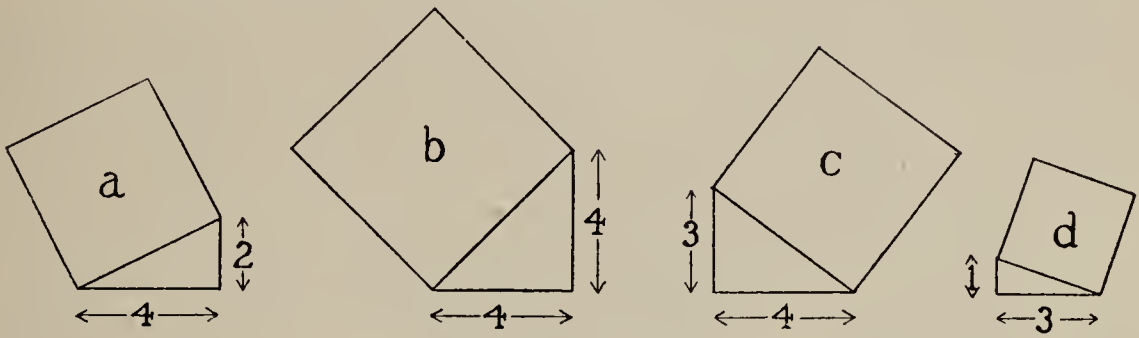
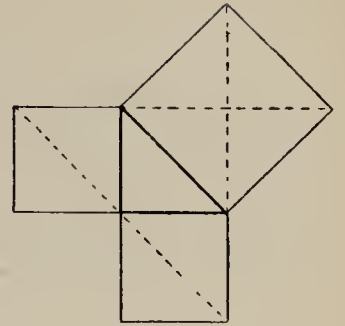

Rule II

If the square of the hypotenuse of a triangle is exactly equal to the sum of the squares of the other two sides, the triangle is a right triangle.

8. To have a right angle to use in testing whether one line is exactly perpendicular to another, mechanics make a triangle with one side 3 inches, one side 4 inches, and with the hypotenuse 5 inches long. Show that this fits rule II.

Supply the missing numbers in Ex. 9 and Ex. 10.

9. To make a right triangle, the hypotenuse must be ... inches long if the other two sides are 8 and 6 inches long.
10. If the other sides are 9 ft. and 12 ft. the hypotenuse must be ... feet long.

If this field is an exact rectangle,

11. How large must the square on line *ab* be?
12. How long must the line *ab* itself be?
13. How long must the line *cd* be?
14. How long must the line *ef* be?

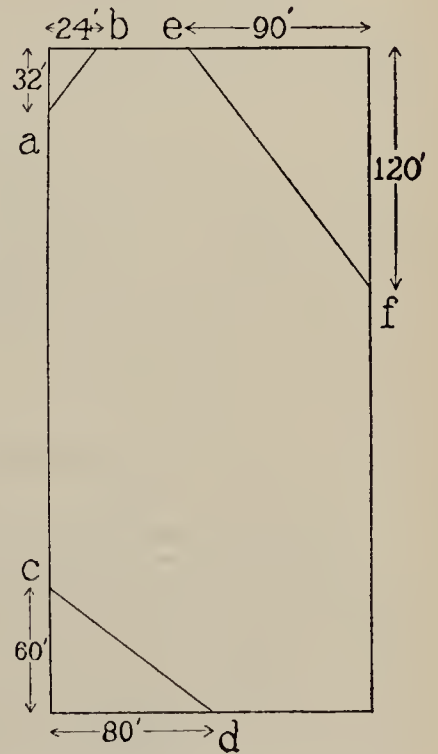

Rule III

In a right triangle, to find the length of the hypotenuse, find the square root of the sum of the squares of the other two sides.

1. What is the length of the hypotenuse of each of these triangles? (You may use the table below to help you.)

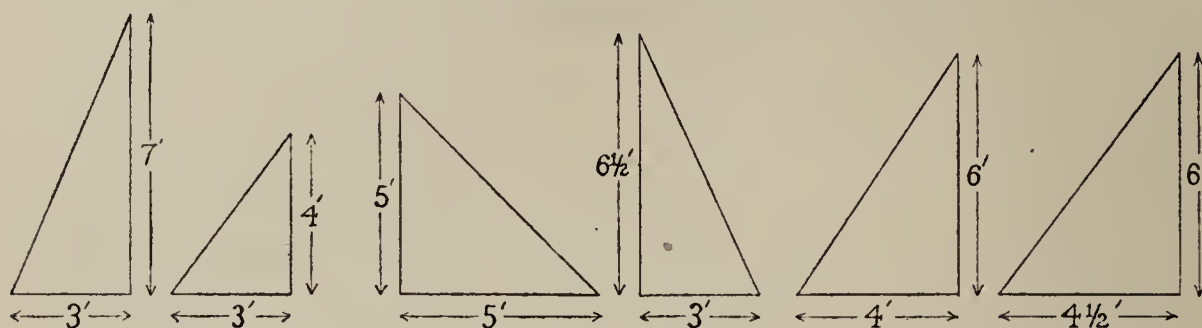

Num.	Sq. Root	Num.	Sq. Root	Num.	Sq. Root
50	7.071	53	7.28	56.25	7.5
51	7.141	54	7.348	58	7.616
51.25	7.159	55	7.416	59	7.681
52	7.211	56	7.483	60	7.746

2. In testing two lines to find out whether one is exactly perpendicular to the other so as to make a right angle with it, carpenters and surveyors mark off a point 6 ft. from the corner on one line and a point 8 ft. from the corner on the other and measure the line from one point to the other. How long will it be if the angle is an exact right angle?

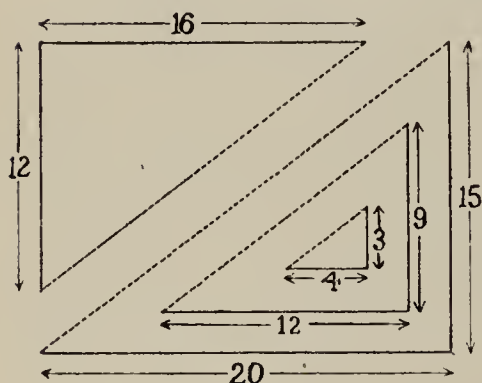

3. How long will each of these dotted lines be? The angles are right angles. (You may use your copy of the table on page 199 to help you.)

70. Estimating the Square Root of a Number

To find what the square root of a number is look in a table of square roots like the one shown on page 244, if you have one. Such tables are printed in the handy books which mechanics, surveyors, engineers, and other workers use in their work. If you do not happen to have a table of square roots to use, you can

find the square root for yourself, by estimating and correcting your estimate.

It will often be useful to estimate one figure at a time like this:

To find the square root of 186:

$$\begin{array}{r} 13 \\ 13 \overline{)186} \end{array}$$

First estimate what number times itself will give about 180 as a result. For example, think, " $10 \times 10 = 100$. It is more than 10. $20 \times 20 = 400$. It is less than 20. So I write 1 in the tens place as the first figure. $12 \times 12 = 144$. So 12 is too small. I know that $13 \times 13 = 169$, $14 \times 14 = 196$. It is more than 13 and less than 14. 14 is the nearest whole number." If you wish a closer result, try 13.5×13.5 . The result is 182.25. Or try 13.6×13.6 . The result is 184.96. Or try 13.7×13.7 . The result is 187.69.

1. It will usually save time in finding square roots if you make out first a little table of the squares of the numbers from 13 to 29.

Copy and complete this table to use in Ex. 3, 4, 5, 6, 7, and 8.

$13 \times 13 =$	$17 \times 17 =$	$21 \times 21 =$	$25 \times 25 =$
$14 \times 14 =$	$18 \times 18 =$	$22 \times 22 =$	$26 \times 26 =$
$15 \times 15 =$	$19 \times 19 =$	$23 \times 23 =$	$27 \times 27 =$
$16 \times 16 =$	$20 \times 20 =$	$24 \times 24 =$	$28 \times 28 =$
			$29 \times 29 =$

2. Read the results of your table, supposing that you are finding the squares of 1.3×1.3 , 1.4×1.4 , 1.5×1.5 , etc.
3. Using your table, make an estimate of the square root of 350. Try your estimate by multiplying it by itself. Then estimate again until your estimate multiplied by itself gives a result between 349 and 351.
4. Estimate from your table what the square root of 450 is. Correct your estimate until the square is between 449 and 451.
5. Close the book and find the square root of 186 by yourself.
6. Estimate the square root of 151, to the nearest whole number
7. Estimate (to the nearest whole number) the square root of —
a. 255 b. 318 c. 47 d. 85 e. 500 f. 632 g. 975
8. Estimate the square root of 32 to the nearest tenth.

204 71. Estimating Square Roots to the Second
Decimal Place

Finding a square root is like dividing, except that you have only the dividend to start with, and have to find both the divisor and the quotient and have them be the same number.

You may save time in estimating the correct square root by estimating in this way:

To find the square root of 75, to the second decimal place.

Think of 8×8 and 9×9 . Write 8 as the first figure.

$$\begin{array}{r}
 8.66 \\
 \hline
 75.0000 \\
 64 \\
 \hline
 166 \quad \overline{1100} \\
 \quad 996 \\
 \hline
 1726 \quad \overline{10400}
 \end{array}$$

Subtract 64 from 75.

Bring down two figures (00), making 1100.

Think how many times 16 (2×8) is contained in 110.

6
16 $\overline{110}$ Write 6 as the second figure.

Think " $6 \times 166 = 996$."

Subtract 966 from 1100.

Bring down two figures (00), making 10400.

Think how many times 172 (2×86) is contained in 1040.

$$\begin{array}{r}
 6 \\
 172 \overline{1040} \\
 1032
 \end{array}$$

Write 6 as the third figure.

Place the decimal point where it belongs. Check your result by multiplying 8.66×8.66 . The result should be very close to 75.

1. Find the square root of 62.4 to the second decimal place.
2. Find the square root of 9.94 to the second decimal place.
3. Find the square root of 38 to the second decimal place.

72. Estimating the Cube Root of a Number

To find the cube root of a number, look in a table of cube roots such as will be found in handy books for mechanics and engineers.

If you need to find the cube root of a number when you cannot procure such a table, estimate and correct your estimate.

A **circle** is a surface bounded by a curved line called the **circumference**, every point of which is at the same distance from the center.

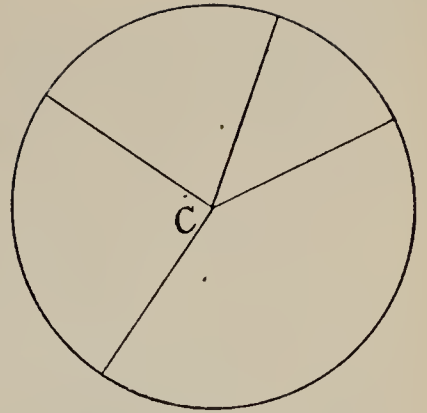

1. Name objects, like a cent or a wheel, that are circular in shape.
2. Any line from the center to the circumference is a **radius** of the circle. What do you know about the lengths of the four radii in the picture?
3. Take a strip of cardboard about $3\frac{1}{2}$ inches long. Make a hole near one end just big enough to put a pin through. Make holes $\frac{1}{2}$ inch from the pin hole, 1 inch from the pin hole, $1\frac{1}{2}$ inches, 2 inches, $2\frac{1}{2}$ inches, and 3 inches. Make these holes just big enough for the point of a pencil. Use this strip to draw the circumference of a circle with a radius of $\frac{1}{2}$ inch.
4. Draw also the circumferences of circles 1, $1\frac{1}{2}$, 2, $2\frac{1}{2}$, and 3 inches radius.
5. A **diameter** of a circle is a line drawn from the circumference through the center across to the circumference. Draw a diameter in each circle.
6. The diameter of a circle is how many times as long as a radius of the same circle?

“*The radius of a circle*” or the letter r may be used to mean “the *length* of the radius of the circle.”

“*The diameter of a circle*” or $2r$, may be used to mean “the *length* of the diameter of the circle.”

“*The circumference of a circle*” may be used to mean “the *length* of the circumference of the circle.”

If you should measure the circumference of each circle that you drew, you would find that the circumference of a circle is almost exactly $2\frac{2}{7} \times$ the diameter (or $3\frac{1}{7}$ or, more exactly, $3.1416 \times$ the diameter). This is true of any circle.

7. What is the length of the circumference of each of the circles that you drew? (Use $2\frac{2}{7} \times \text{diam.}$ or $2\frac{2}{7} \times 2 \times \text{radius.}$)
8. What is the **perimeter** or length of the circumference of each of these wheels?

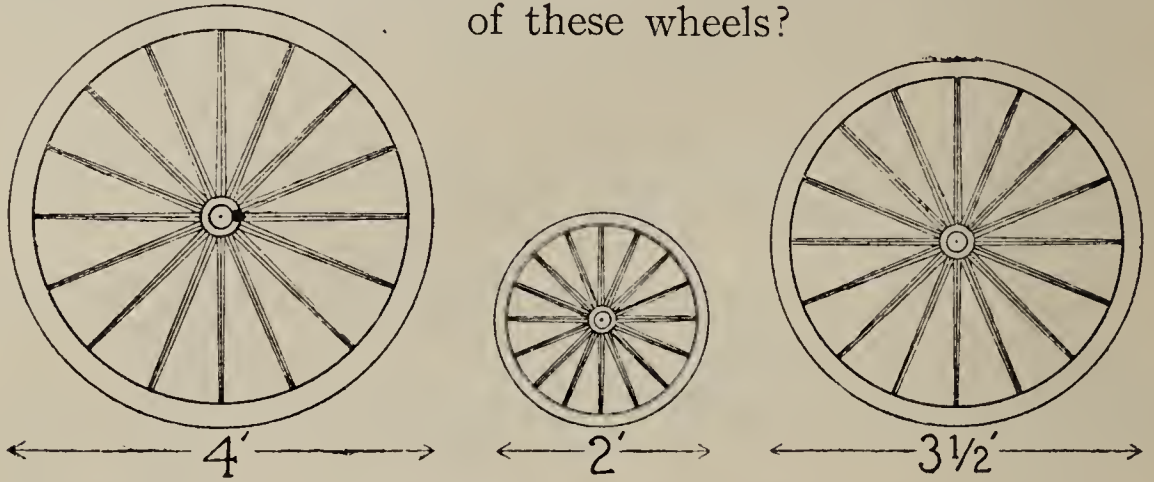

74. Finding the Area of a Circle

The area of a circle = $\frac{22}{7} \times$ the square of the radius.

$$\text{Area} = \frac{22}{7} \times r^2$$

1. Supply the missing words:
 If the radius is measured in inches the area is in square inches.
 If the radius is measured in feet the area is in
 If the radius is measured in miles the area is in

2. What is the area of each circle that you drew in Ex. 3 and Ex. 4, on page 205?
3. What is the area of circle *a* shown here? Of *b*? Of *c*? Of *d*?
4. Find the area of a circle whose radius is 25 ft.
5. Find the area of a circle whose diameter is 25 ft.

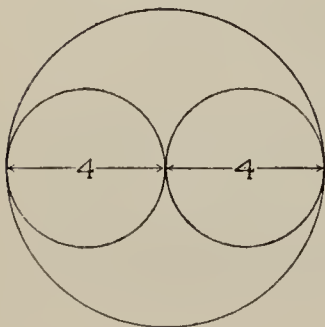
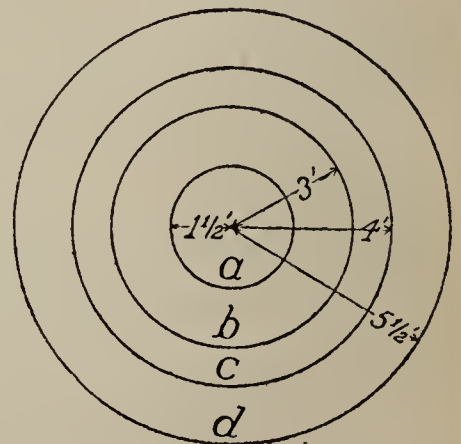

6. Draw a rough sketch showing the two circles of Ex. 4 and 5. Let 1" stand for 10 ft.
7. Two circles each 4 yards in diameter are drawn inside a circle 8 yards in diameter as shown here. How much space is left?

8. Find the area of the circular road shown in the diagram. The radius of the outer circle is 67 ft.; the radius of the inner circle is 45 ft.
9. Find the cost of covering it with gravel at 6¢ per sq. yd.

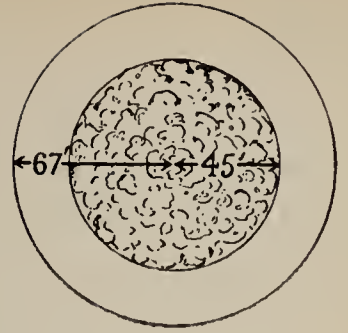

75. Computing the Cubic Capacity of Circular Wells, Pipes, Tanks, and Other Cylinders

1. Arthur and Grace made a little water garden out of iron wagon-wheel tires and cement, as shown in the picture. The tires were $4\frac{1}{2}$ ft. inside diameter. Each was 4 in. wide.
- (a) How many square feet is the area of their water garden?
- (b) How deep is the water when it is full to the top?
- (c) How many cubic feet of water does it hold when the water is $1\frac{1}{2}$ ft. deep?

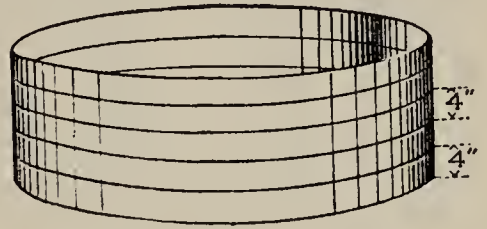

2. They made a second garden for water lilies out of the big water pipe shown in the picture, 36 in. in diameter (inside measure), except where it flares out at the top. There it is 42 in. in diameter.

- (a) How many square feet are there in the surface of the water in the water pipe if it is filled to the very top?
- (b) How many square feet are there in the surface of the water when the pipe is not filled above the line -a-a-a-?

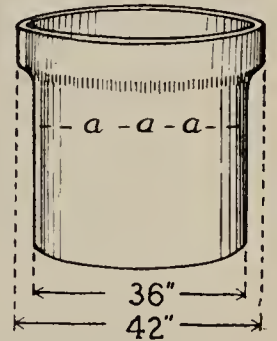

3. The circles below represent cross-sections of pipes whose inside diameters are $\frac{3}{8}$ in., $\frac{1}{2}$ in., $\frac{5}{8}$ in., and $\frac{3}{4}$ in. What fraction of a square inch is each cross-section? How many cubic inches of water will there be in a pipe of each sort when it is filled 6 inches deep?

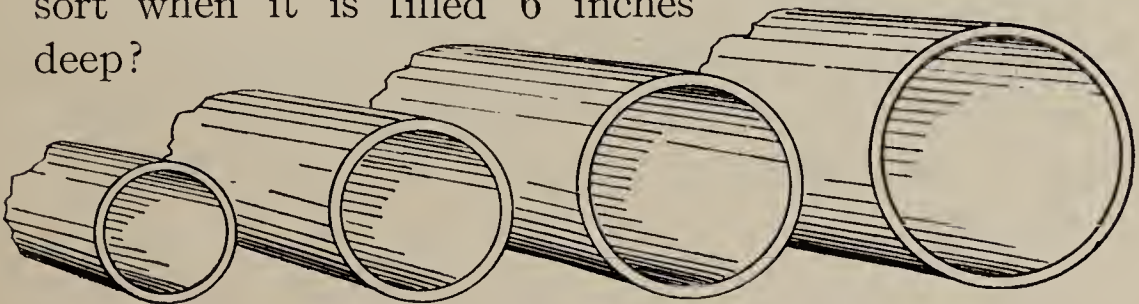

In arithmetic we use the words *cylinder* and *cylindrical* to refer to a shape like a round pencil before it is sharpened, or a well, or a silo, or a standpipe, as shown in the pictures. The two ends are circles. There are other sorts of cylinders.

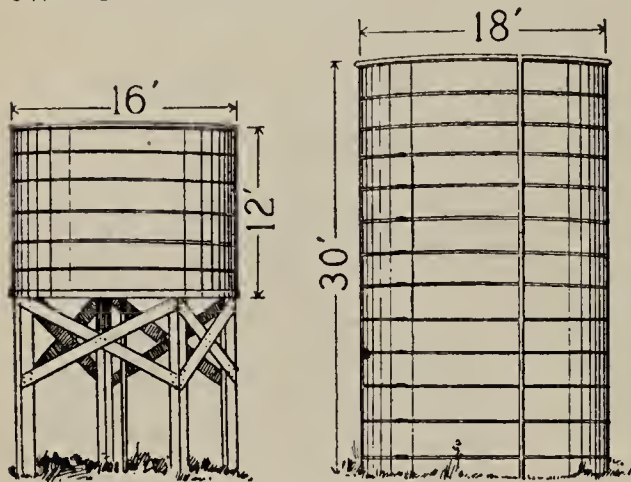

The **area of the base** of a cylinder is the area of one of its circular ends.

The **altitude** (height or depth) of a cylinder is the perpendicular distance from one of its circular ends to the other.

The **volume or cubic capacity** of a cylinder is the number of cu. in. or cu. ft. or cu. yd., etc., which it occupies or holds.

If the altitude and the area of the base are expressed in the right units of measure,

Volume of a cylinder = altitude \times (area of base)

4. a. State the altitude of each of the cylinders on this page.
b. Tell how you will find the area of the base of a cylinder.
c. Find the area of the base of each cylinder on this page.
5. The silo, standpipe, cistern, and well shown in the pictures all have circles as bases. The horizontal dimension lines show the diameters (inside measure). How many cubic feet will each hold when it is full?
6. Find how many cubic feet there will be in the contents of each when filled to a depth of 10 feet.
7. How many times as much will the silo shown above hold as a silo that is just as tall but only 9 ft. in diameter?
8. What is the volume of a cylinder 20 in. tall and 3.5 in. in diameter?

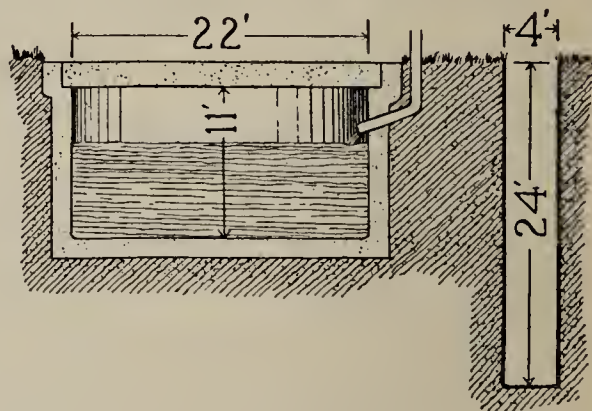

1. Take a cylinder of wood 5 inches long cut from a broom handle.
How can you find the amount of surface of the two ends?
2. Cut a rectangle of paper five inches long and as wide as $2\frac{2}{7} \times$ the diameter of the broom handle.

Wrap it around the 5-inch piece of broom handle. Compare its area with the area of the lateral surface of the piece of broom handle. (*Lateral surface* of a cylinder means the surface, not counting the two ends.)

3. If convenient, repeat this comparison with cylinders of larger diameter and of both shorter and longer altitude.
4. Supply the missing words:

The amount of surface at one end of a cylinder is the area of the circle which forms that end. It is $2\frac{2}{7} \times$ the square of the ... of the cylinder.

The amount of lateral surface of a right cylinder = the ... of the cylinder $\times 2\frac{2}{7}$ of the ...

5. What dimensions shall you cut a piece of paper to cover the lateral surface of a cylinder 3 in. in diameter and 8 in. high?
6. To cover the lateral surface of a cylinder of 6 in. diameter and 10 in. high?
7. How many square feet of sheet copper will be required to make a cylindrical tank $1\frac{1}{4}$ ft. in diameter and 4 ft. high (allowing that 5 sq. ft. extra are used up in lapping joints, waste in cutting, etc.)?
8. How many gallons of water will the tank hold, counting that 1 cubic foot equals $7\frac{1}{2}$ gallons?
9. How many times as much water as the tank of Ex. 7 will a tank of the same height but $2\frac{1}{2}$ ft. in diameter hold?

TO THE TEACHER.—It is not important that pupils should remember the formulae for the surfaces and volumes of cylinders, spheres, cones, pyramids, or prisms (except $l \times w \times h$ for a rectangular prism). It is important that they should acquire ability to *interpret* and *use* formulae, and to understand and use the tables computed on the basis of certain formulae.

210 77. **Writing Arithmetical Arguments and Proofs***

1. Which increases most rapidly as you increase the diameter of a circle—its radius, its circumference, or its area?
2. Write a clear statement proving that your answer to Ex. 1 is true.
3. Which increases more rapidly if you increase the diameter of a cylinder without changing its altitude—its total surface or its volume?
4. Write a clear statement showing why your answer is true.
5. Would the cost of painting be more or less for one tank 8 ft. tall and 6 ft. in diameter, or for three tanks each 8 ft. tall and 3 ft. in diameter? Write a proof that your answer is correct.
6. Would the single large tank hold more or less than the three smaller tanks together, or would both hold just the same amount, supposing that the measures given in Ex. 5 are inside dimensions? Write a proof that your answer is correct.

78. **To Find the Volume of Any Solid or the Capacity of Any Receptacle**

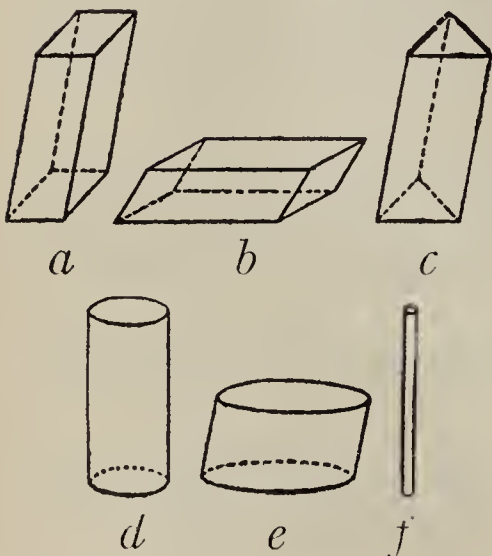

If the space to be measured is in the shape of a **prism** like a, b, or c, or a **cylinder** like d, e, or f, **multiply the area of the base by the altitude.** In a prism whose corners are all right angles, multiply length \times width \times height (or depth).

In a cylinder, use altitude $\times \pi r^2$. π (pi) = $\frac{22}{7}$ or 3.1416. r = the radius of the circle which is the base of the cylinder.

1. Find the number of cubic yards in a wall 41 yd. long, 18 in. wide, and 4 ft. high.
2. Find the number of cubic feet in a beam 24 ft. long, 8 in. wide, and 1 ft. thick.

* TO THE TEACHER.—These and similar proofs may well be discussed in the periods assigned to English.

- Find the number of cubic feet in a cylindrical hole 8 ft. in diameter and 12 ft. deep.
- Find the number of cubic feet in a driven well 6 in. in diameter and 240 ft. deep.
- How many gallons of water does the well of Ex. 4 contain when the water comes to within 20 feet of the top, counting $7\frac{1}{2}$ gallons to a cubic foot?
- How many cubic yards are there in a space $8' \times 12' \times 15'$?

If the space to be measured is in the shape of a **cone** like *g* or a **pyramid** like *h*, multiply the area of the base by $\frac{1}{3}$ of the altitude.



g



h

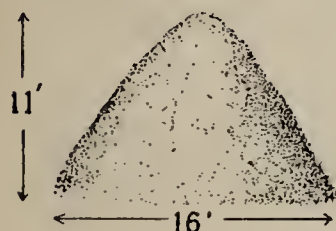

- This pile of sand is 11 ft. high and 16 ft. in diameter across the bottom. How many cubic feet of sand does it contain, assuming that its shape is that of a cone?

- How many cubic feet of air does this tent contain?

If the space to be measured is in some irregular shape, various ways may be taken to find its volume. If it is a small receptacle, measure the volume of sand or water required to fill it.



If convenient, test the rules for cones and pyramids by measuring the amount of sand required to fill some.

If it is a small solid, measure the volume of water that it displaces.

- John put an iron weight in a quart measure and then filled the measure with water. He poured the water into another measure and found that there was exactly $\frac{3}{4}$ qt. Since 1 qt. contains $57\frac{3}{4}$ cubic inches, how many cubic inches did the iron weight contain?

If the space to be measured is a large irregular receptacle like a ship or a cave, or a large irregular solid like a hill or mountain, the work of measuring its volume is too hard for a boy or girl.

212 79. Remembering What to Do by Equations

It is convenient to think of certain arithmetical facts in the form of **equations** or **formulae**. For example, you may think of the fact that the length of the circumference of a circle is equal to 3.1416 (roughly $2\frac{2}{7}$) times the length of the diameter of the circle in any of these ways.

Let π (pi) represent 3.1416 or $2\frac{2}{7}$. Then

$$\text{circumf.} = \pi \times \text{diam.}$$

$$\text{or circumf.} = \pi \times 2r$$

$$\text{or circumf.} = 2\pi r$$

$$\text{Area of a circle} = \text{one half of radius} \times \text{circumference}$$

$$\text{Area of a circle} = \frac{1}{2}r \times 2\pi r$$

$$\text{Area of a circle} = \pi r^2$$

These equations or formulae are easy ways to remember how to find the area of a circle if you know its radius or diameter or circumference.

It does you very little good, however, to remember a formula unless you remember what it means. So be sure that you know what a formula means when you learn it.

The perimeter or circumference of the circle on p. 213 is 12 inches. Its center is at O .

*The part of it between **A** and **B** is called the arc **AB**.*

*The part of it between **B** and **C** is called the arc **BC**.*

*The part of it between **C** and **D** is called the arc **CD**.*

1. The arc AB is 90° . How long is it in inches?
2. The arc BC is 60° . How long is it in inches?
3. The arc CD is 30° . How long is it in inches?
4. The arc DE is 45° . How long is it in inches?
5. How many degrees is the angle EOA ?
6. How long in inches is the arc EA ?

*The surface bounded by two radii and an arc of a circle is called a **sector**.*

The area of a sector = $\frac{1}{2}r \times$ the length of its arc.

$$\text{Area} = \frac{r}{2} \times \text{arc.}$$

7. Sector $BOC = \frac{1}{2}r \times 2$. Sector $COD = \frac{1}{2}r \times 1$. Sector $DOE = \frac{1}{2}r \times 1\frac{1}{2}$. Find the area of each of these sectors, using $1\frac{10}{11}$ in. for r .

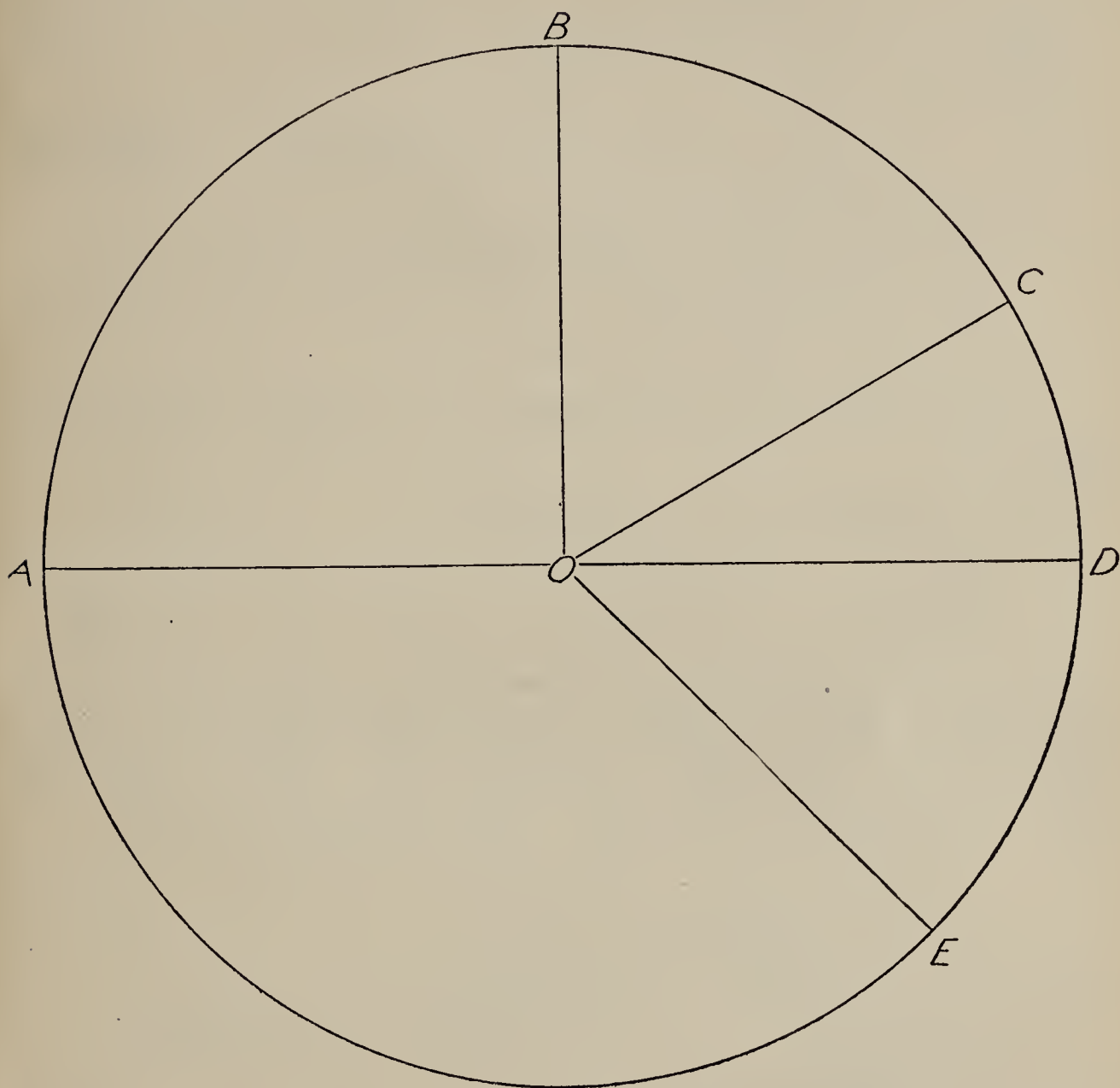

8. Find the area of sector AOB .
9. Find the area of sector EOA .
10. If the circumference of a circle is 44 in., how long is the arc of a sector of 90° ? How long is the arc of a sector of 60° ? How long is an arc of 45° ? An arc of 36° ? An arc of 10° ?
11. How long is an arc of a **quadrant** (or sector of 90°) when the circumference is 10 in. long? When it is 20 in. long? When it is 30 in. long? When it is 36 in. long?

80. Understanding Equations or Formulae

- I. Let r = the number of miles per hour traveled.
 Let d = the distance traveled (in miles).
 Let t = the time (in hours).

Tell clearly in words the meaning of each of these. tr means t times r .

$$d = tr \quad r = \frac{d}{t} \quad t = \frac{d}{r} \quad 3d = 3tr \quad \frac{1}{3}d = \frac{1}{3}tr$$

- II. Let I = the number of dollars of interest.
 Let P = the number of dollars on which interest is paid.
 Let R = the rate per year.
 Let T = the time in years.

Which of these are correct equations or formulae showing the value of I ?

$$I = P \times R \times T \quad I = P \times R \times P \quad I = TRP$$

$$I = \frac{P}{R} \times T \quad I = R \times P \times T \quad I = \frac{1}{2} (P \times R) \times \frac{T}{360}$$

III. In the equations or formulae below, which letter stands for *altitude*? Which stands for *base*? Which stands for *radius*? Which stands for 3.1416, or roughly $3\frac{1}{7}$? Which stands for *area*? Which stands for *length*? Which stands for *width*?

In a rectangle, $a = l \times w$ or $a = h \times b$

In a parallelogram, $a = h \times b$

In a triangle, $a = \frac{1}{2}h \times b$

In a circle, $a = \pi r^2$ or $a = \frac{1}{2}r \times 2\pi r$

In a sector, $a = \frac{1}{2}r \times \text{arc}$

IV. Find the area of each of the surfaces represented below.

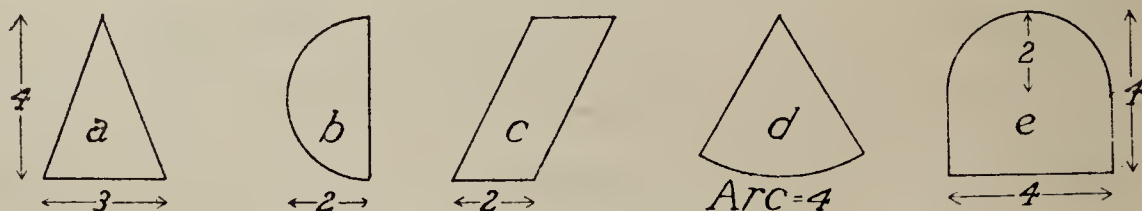

V. Find the perimeter or distance around each of the surfaces.

VI. Find the area of this athletic field:

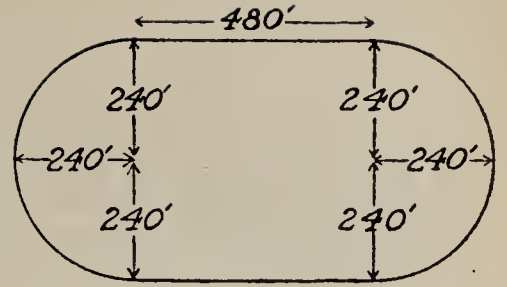

81.

1. Supply the missing numbers:

The diameter of a circle = ... \times the radius.

The circumference of a circle = ... \times the radius.

The area of a circle = π ...

2. Supply the missing words:

The volume of a right cylinder = \times area of base.

$$V = h \times \pi r^2$$

3. Write an equation for the area of the lat. surf. of a rt. cyl.

4. How many sq. ft. in this formal garden are occupied (a) By the four beds of shrubs? (b) By the fountain? (c) By the path surrounding the fountain? (d) By the beds of roses and ivy? (e) By the lawns?

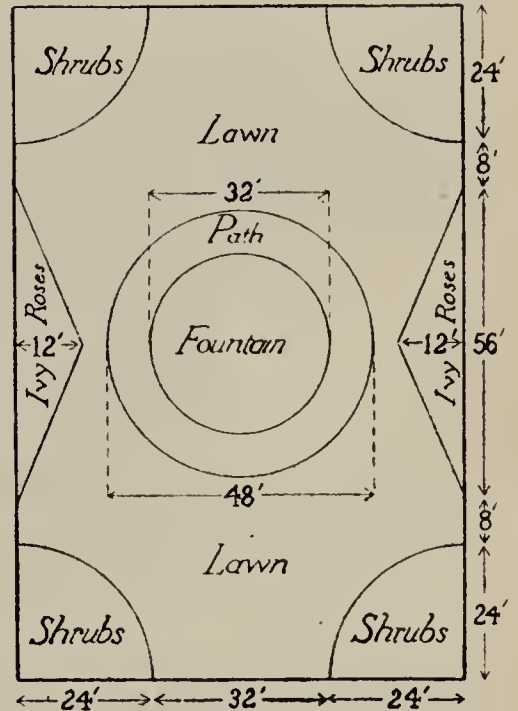

5. A tree disease starts at Glendale. If it spreads 50 miles from Glendale in every direction, how many square miles will be affected by the disease?

6. How much does the air in a cylindrical smokestack 8 ft. in diameter and 75 ft. high weigh, counting the weight of 1 cu. ft. of air as .081 lb.?

7. How many times as much will a well 6 ft. in diameter and 28 ft. deep hold as a well 3 ft. in diameter and 28 ft. deep?

8. What is the volume of a cube, if each edge is $3\frac{1}{2}$ in. long?

9. How many times as large is the area of a circle whose radius is 20 ft. as that of a circle whose radius is 10 ft.?

82. Speeds and Strengths

Study each of these equations or formulae until you know how to use it in solving problems 1 to 7 below.

Let S = the rim speed or the number of feet per minute that a particle on the circumference of a wheel travels.

Let R.P.M. = the number of revolutions or complete turns that the wheel makes per minute.

Let R = the radius of the wheel, in feet or fractions of a foot.

$$\text{Then } S = 2\pi r \times \text{R.P.M.}$$

To find the number of revolutions per minute required to give a certain rim speed, you therefore use

$$\text{R.P.M.} = \frac{S}{2\pi r}$$

Let $wt.$ = the number of pounds that is a safe load for a beam to hold up when the weight is distributed evenly over the beam.

Let b = the width of the beam (in inches).

Let d = the depth of the beam (in inches).

Let l = the distance between supports (in feet).

$$\text{Then, for chestnut, } wt. = (120 \times b \times d^2) \div l.$$

$$\text{for hemlock, } wt. = (110 \times b \times d^2) \div l.$$

$$\text{for Georgia pine, } wt. = (200 \times b \times d^2) \div l.$$

Let S = the breaking strength of manila rope (that is, the number of pounds that a manila rope will just hold without breaking).

Let $r = \frac{1}{2}$ the diameter of the rope in inches.

$$\text{Then } S = 720 \times \text{the square of } 2\pi r. \quad S = 720 (2\pi r)^2.$$

Let Ls = a safe load (in pounds) for manila rope working at slow speed.

Let S = the breaking strength of the rope.

$$\text{Then } Ls = \frac{S}{7} \quad \text{or} \quad Ls = \frac{720 (2\pi r)^2}{7}$$

1. What is the rim speed in feet per minute of each of the grindstones or emery wheels represented in the picture on p. 217, at 750 revolutions per minute?
2. (a) Answer the same question for 1200 revolutions per minute.
(b) How many times as great is the rim speed of the 16-inch wheel as the speed of the 10-inch wheel?

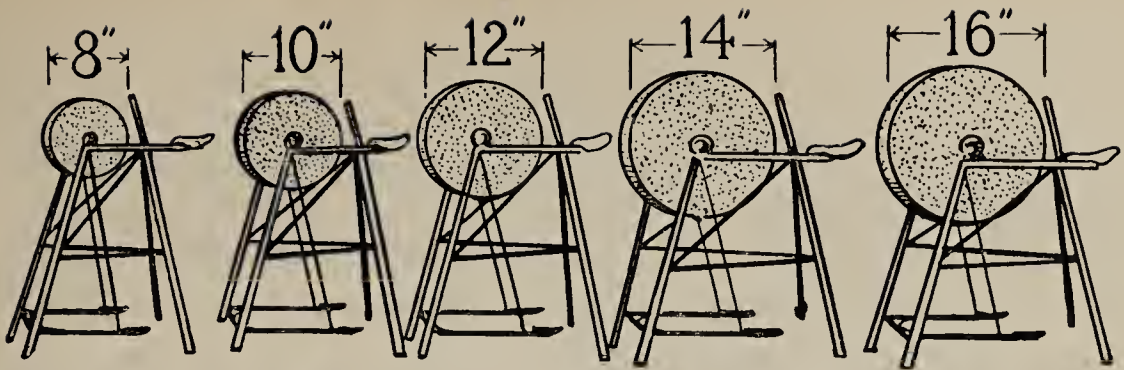

3. How many revolutions per minute will give the rim of a wheel 28 inches in diameter a rim speed of 3520 ft. per minute?
4. A rim speed of over 5000 ft. per minute for an emery wheel is unsafe. How many R.P.M. can a wheel 6 inches in diameter have without being unsafe?

5. What is a safe distributed load for each of the beams represented in Diagram I if all are made of hemlock? If they are made of Georgia pine? If they are made of chestnut? The ends are $4" \times 12"$, $2" \times 4"$, $3" \times 6"$, and $6" \times 6"$ respectively.

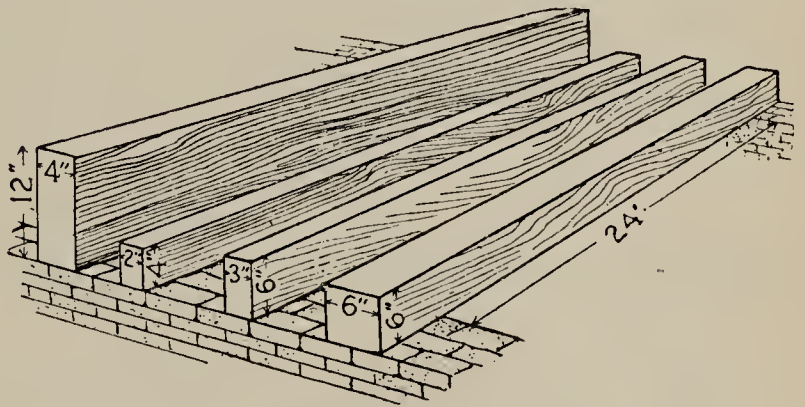

Diagram I

6. What is a safe distributed load for each of the beams shown in Diagram II, supposing each of them to be 18 ft. long between supports? Find the answers for each of the three kinds of wood.

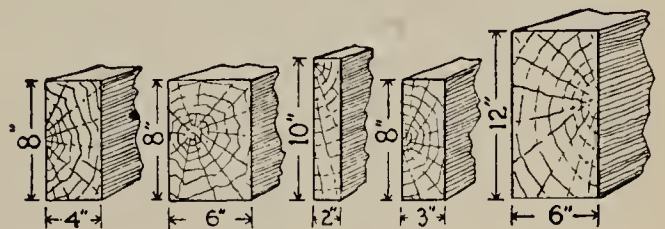

Diagram II

7. (a) Find the breaking strength of a manila rope 2" in diameter.
 (b) Find the breaking strength of a manila rope $1\frac{1}{4}"$ in diam.
 (c) Find the breaking strength of a manila rope $\frac{3}{4}"$ in diam.
 (d) Find the safe load at slow speed of a manila rope $2\frac{1}{2}"$ in diam
 (e) Find the safe load at slow speed of a manila rope $1\frac{1}{2}"$ in diam.

There are two sorts of thermometers. The ordinary sort used in the United States is a **Fahrenheit** scale, on which 32 degrees (32° F.) is the temperature of melting ice and 212 degrees (212° F.) is the temperature of boiling water. In many countries the thermometers are made with a **Centigrade** scale on which 0 degrees (0° C.) is the temperature of melting ice and 100 degrees (100° C.) is the temperature of boiling water.

Let T_F represent any temperature above 32 degrees on the Fahrenheit scale.
Let T_C represent that same temperature on the Centigrade scale.

$$\text{Then } T_F = (1.8 \times T_C) + 32$$

$$T_C = \frac{T_F - 32}{1.8}$$

1. How hot by our scale (the F. scale) is 30° C.? 40° C.? 50° C.?
2. Change this table of the temperatures at which various substances melt to the Fahrenheit scale.

Ice	0° C.	Lead	327° C.
Tallow	45° C.	Gold	1063° C.

3. What temperature on the Centigrade scale equals 86° F.? 104° F.? 50° F.? 9° F.?
4. How many degrees Fahrenheit equal one degree Centigrade?
5. What part of a Centigrade degree is one degree of the Fahrenheit scale?

Call the number of cents on each dollar invested which you receive each year from an investment of money in stocks or bonds the **Yield** or **Yield Percent** or **Y**.

Call the percent that you receive per year on the par value of the stocks as dividend or interest the **Rate** and call what you paid for the stocks or bonds the **Cost**. Then

$$\text{Yield} = \frac{\text{Rate} \times \text{Par Value}}{\text{Cost}}$$

6. What is the yield of a \$1000 bond paying 4½% interest, if bought at \$945?
7. What is the yield of 10 shares of a stock paying 7% dividend on a par value of \$100 each, if bought at \$113.25 each?
8. What is the yield of a \$500 bond paying 4% interest, if bought for \$451.75?

Let arc = the length of an arc of a circle.

Let r = the length of the radius of the circle.

Let D = the number of degrees in the arc.

Let $\pi = 3.1416$ or $\frac{22}{7}$. Arc and r must be measured in the same units.

$$\text{Then } arc = \frac{D}{360} \times 2\pi r$$

The diagram shows the circumference of a circle. O is the center.

The part of it between a and b is called arc ab .

The part of it between c and d is called arc cd .

The part of it between e and f is called arc ef .

The entire circumference is 7.2 inches.

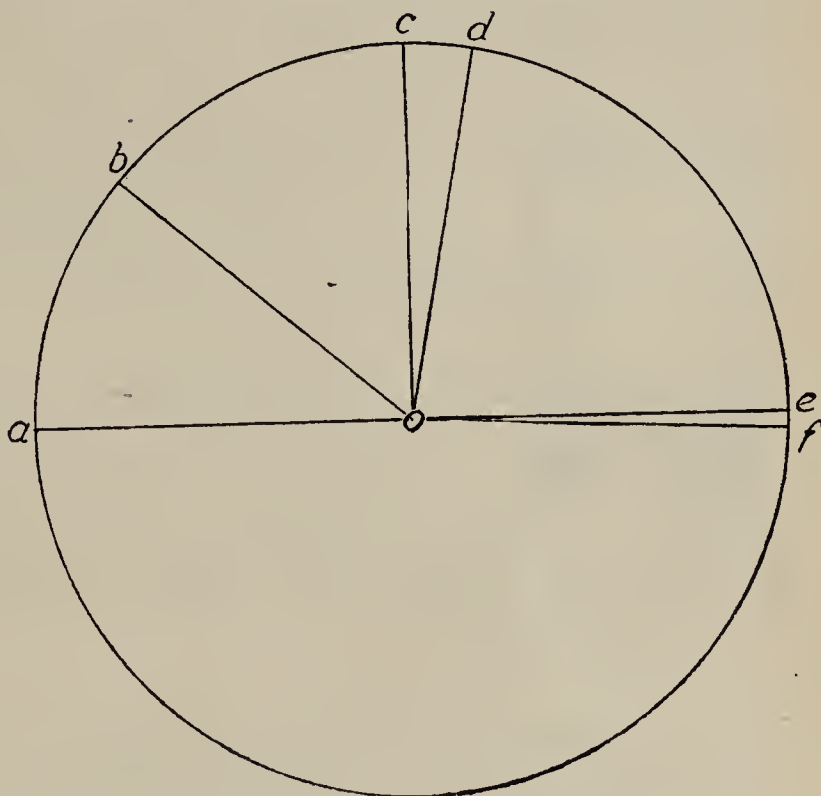

- The arc ab is made by two lines, oa and ob , which are 40° apart. How long is ab ?
- The arc cd is made by two lines oc and od , which are 10° apart. How long is cd ?
- The arc ef is made by two lines oe and of , which are 2° apart. How long is ef ?
- Imagine that each inch represented 1000 miles.
 - How long would the 40° arc be then?
 - How long would the 10° arc be then?
- (a) How long would a 1° arc be then? (b) An arc of $\frac{1}{2}$ a degree? (c) An arc of $\frac{1}{60}$ of a degree?

$\frac{1}{60}$ of a degree is called 1 *minute* and written $1'$.
 $\frac{1}{360}$ of a degree is called 1 *second* and written $1''$.
 $7^\circ 4' 50''$ is read "7 degrees 4 minutes 50 seconds."

85. Lengths, Areas, and Volumes

Choose the right one of these equations or formulae for each of the problems below and use it to find the answer.

In a rectangular prism the volume, $V = l \times b \times h$

In a right cylinder the volume, $V = h \times \pi r^2$

In a sphere the volume, $V = \frac{4}{3} \pi r^3$

In a sphere the area of the surface = $4 \pi r^2$

In a cube the volume, $V = l^3$ if l is the length of any side.

In a right triangle, hypot. = $\sqrt{\text{sum of squares of other two sides.}}$

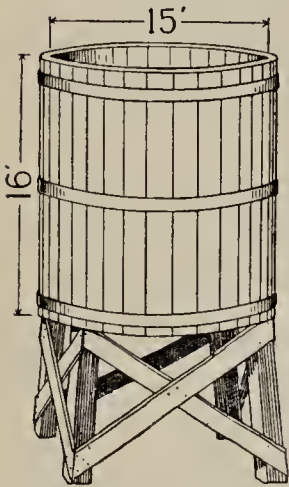

1. How many square miles are there on the earth's surface, counting it as a sphere with a radius of 4000 mi.?
2. How many cubic feet are there in a box $8' \times 4\frac{1}{2}' \times 2\frac{1}{2}'$?
3. How many cubic feet are there in a spherical balloon 30 ft. in diameter?
4. How many cubic feet are there in 1 cubic yard?

5. How many cubic feet will this round water tank hold?

6. Find the distance from A to B , if line BC is perpendicular to line CA .

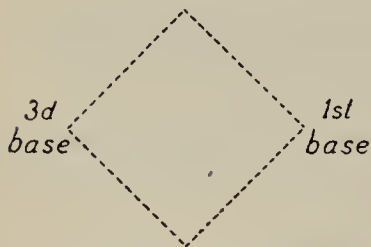
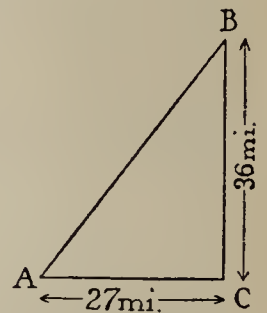

7. A baseball diamond is a square 90 ft. on each side. Is the distance from 1st base to 3d base more or less than 130 ft.?

8. What is the distance to the nearest foot?
9. What is the distance to the nearest tenth of a foot?

86. Longitude

Be ready to tell what you learned about longitude in geography.

1 degree of longitude = $\frac{1}{360}$ of a circumference.

1. How many miles does 1 degree of longitude equal (a) When the circumference is 2400 miles? (b) When the circumference is 20,000 miles? (c) When it is 12,000 miles?
2. At what places on the earth's surface could a man walk through 360° of longitude in a few minutes?
3. M is 17° west of Greenwich. S is 9° west of Greenwich. V is 9° east of Greenwich. (a) How many degrees of longitude apart are M and S? (b) M and V? (c) S and V?
4. The earth turns through an angle of 360° in 24 hours. Through how many degrees does it turn in 1 hr.?
5. About how much later does the sun rise in a place 30° W. of Chicago than in Chicago?
6. How many minutes of time does it take the earth to turn through an angle of 1° or $60'$?
7. How many miles = $5'$ of longitude when the circumference is 25,000 miles?
8. How much longer is daylight than dark,
 - (a) When the sun rises at 4:55 A.M. and sets at 7:00 P.M.?
 - (b) When the sun rises at 4:49 A.M. and sets at 7:23 P.M.?

87. The Metric or Decimal System of Weights and Measures

In almost all civilized countries the metric or decimal system of weights and measures is used.

Length is measured by the millimeter, meter, and kilometer.

1 meter or 1 m. = 39.37 inches.

1 millimeter or 1 mm. = .001 m. or .03937 in. 1 inch = 25.4 millimeters.

1 kilometer or 1 km. = 1000 meters.

1. How many millimeters = 1 meter?

2. How many meters = 1 kilometer?

3. Which is longer, a yard or a meter?

4. How much longer?

5. About how many mm. = $\frac{1}{4}$ in.? $\frac{1}{8}$ in.? $\frac{1}{2}$ in.?

• = 1 mm.

■ = 2 mm.

▬ = 10 mm.

▬ =
1 inch or 25.4 mm.

Weight is measured by the milligram, gram, and kilogram.

1 gram or 1 g. = about $\frac{1}{28}$ of an ounce.

1 milligram or 1 mg. = .001 g. 1 kilogram or 1 kg. = 1000 grams.

1 kilogram = a little over 2.2 lb.

6. (a) How many milligrams = 1 gram? (b) How many grams = 1 kilogram?
7. (a) Tell something that weighs only about 2 or 3 grams.
(b) Tell something that weighs about 5 or 6 kilograms.
8. (a) Which is heavier, 10 kilograms or 20 lb.? (b) How much heavier?
9. How many kilograms are there in 10,000 grams?

Liquids are measured by the liter.

1 liter = a little over a quart (about $1\frac{1}{8}$ qt.)

10. How many milliliters do you expect will equal 1 liter?
11. How many liters do you expect will equal 1 kiloliter?
12. Which means 1000 — “kilo” or “milli”?
13. Which means .001 — “kilo” or “milli”?
14. Electricity is measured in watts. (a) What name do you expect will be given to 1000 watts? (b) What do you think *w.* and *kw.* stand for?
15. Supply the missing numbers. Remember what mm., m., and km. mean. Remember what mg., g., and kg. mean.
.005 km. or .5 m. = ... mm. .657 m. = ... mm.
750 mg. = ... g. 8.4 kw. or kilowatts = ... watts.
250 g. = ... kg. $\frac{1}{4}$ kw. = ... watts.
3500 watts = ... kilowatts. $\frac{3}{4}$ kg. = ... grams.

88. The Plan of the Metric System

Supply the missing words:

1. To express 2964.5 meters as a number of kilometers, the decimal point is moved ... places to the ...
2. To express 3.728 kg. as a number of grams, the decimal point is moved ... places to the ...

To add metric or decimal quantities, express them in the same unit, write with the decimal points in a column, and add.

3. Add 3.0168 km., 292.5 m. and 6800 mm., expressing the result in meters.

$$\begin{array}{r} 3016.8 \\ 292.5 \\ 6.8 \\ \hline m. \end{array}$$

4. Add 3.0168 mi., 292.5 yd., and 6800 in., expressing the result in yd.
5. Which is easier and less likely to cause mistakes, Ex. 3 or Ex. 4?
6. Which do you think is the more convenient system of weights and measures,— the metric system with km., m. and mm., kg., g., and mg., etc., or the English system of mi., rd., yd., ft., in. and lb., oz., etc.? Why?

_____ = 1 centimeter. _____ = 2 cm.

1 centimeter or 1 cm. = 10 millimeters. 1 inch = 2.54 cm.

1 decimeter or 1 dm. = 10 cm. or 100 mm. 1 cm. = .3937 in.

7. How many centimeters = 1 meter?
8. How many decimeters = 1 meter?
9. Hold your hands about 1 decimeter apart.
10. Think of dollars, dimes, cents, and mills and m., dm., cm., and mm. In what way is the American system of units of money like the metric system of units of length?

89. Review

1 m. = 39.37 in. 1 kg. = 2.2 lb. 1 liter = 1.0567 qt.

1. How tall in inches is a boy 1.45 m. tall?
2. What is the diameter in inches of a 75-mm. gun (*i.e.*, a gun 75 mm. in diameter)?
3. A girl is 1.708 m. tall and weighs 48.6 kg. Express her height in inches and her weight in pounds.
4. How many kilograms are there in 10 lb.? (Find result to the second decimal place.)

5. How many inches are there in 1 mile?
6. How many meters are there in 1 mile?
7. How many quarts does a 25-liter cask contain?
8. How much longer is a 100-meter dash than a 100-yard dash?
9. Which is longer, 3 meters or 3.5 yd.? How much longer?
10. Which is the higher record for a running high jump — 6 ft. 3 in. or 2.06 meters?
11. In an endurance test, a soldier marched 58.52 kilometers one day, 60.13 kilometers the next day, and 53.7 kilometers the third. How many kilometers did he march in all?
12. How many meters did he march?
13. Counting $\frac{1}{11}$ yd. to a meter, about how many yards did he march?
14. Counting 1609 meters to a mile how many miles did he march?
 $1 \text{ cm.} = .3937 \text{ in.} \quad 1 \text{ in.} = 2.54 \text{ cm.}$

15. How many millimeters = $\frac{1}{8}$ inch?

16. How many centimeters = 3.06 in.?

17. How many millimeters = $\frac{2}{5}$ in.?

A 25-watt lamp is one that requires 25 watts of electricity.

A 60-watt lamp is one that requires 60 watts of electricity.

18. How many 25-watt lamps will 1 kilowatt of electricity supply?
19. How many 60-watt lamps will 1 kilowatt of electricity supply?
20. If the use of 1 kilowatt for an hour costs 9¢, how much does it cost for the use of 180 watts for an hour?
21. What is the cost of 125 milligrams of a certain metal at \$1.60 a gram?
22. The number of watts supplied by an electric current is equal to the number of amperes in the current \times the number of volts. Write an equation explaining the fact stated in this sentence, if we:
 Let P represent the power in watts.
 Let I represent the electrical current in amperes.
 Let E represent the voltage in volts.
23. Use this equation to find the electrical power supplied by 20 amperes at 110 volts.

1. Make a rule of cardboard or stiff paper 10 cm. long. Mark it in cm. and mm.
2. Draw a square 2 cm. on a side.
3. Draw a square 10 cm. on a side. How many sq. cm. is its area?
4. Show by rectangles areas of 1 sq. cm., 2 sq. cm., 4 sq. cm., 12 sq. cm., and 50 sq. cm.
5. Tell something that is about 1 cubic centimeter (that is, 1 cm. long, 1 cm. wide, and 1 cm. high).
6. Tell something that is about 1 cubic meter (*i.e.*, 1 m. \times 1 m. \times 1 m.).
7. Which of these contains (a) About 1 cu. cm.? (b) About 10 cu. cm.? (c) About 250 cu. cm.? (d) About 1000 cu. cm.? (e) About 28,000 cu. cm.? (f) About 1.3 cubic meters?

A pencil. A glass of water. A quart. A cubic yard. A very large pea. A cubic foot.

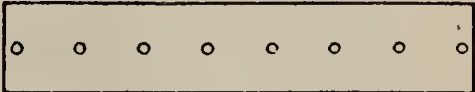
8. Make eight holes in a strip of cardboard, 5 mm. apart as shown in the diagram.
 
9. Draw circles with radii of 2 cm., $2\frac{1}{2}$ cm., 3 cm., and $3\frac{1}{2}$ cm.
10. Mark on each circle its circumference and its area in sq. cm.
11. *c.c.* is often written for cu. cm. or cubic centimeter. 1 c.c. of water weighs 1 gram. How many c.c. weigh 1 kilogram?
12. What is the sum of 15.8 cm., 219 mm., and .814 m.?
13. If 5 pieces, each 75 millimeters long, are cut from a meter length of wire, how much is left?
14. Tell what each of these means: kg., g., mg., kw.
15. How many cubic centimeters are there in a rectangular block. 1.3 cm. \times 2.9 cm. \times 4.6 cm.?
16. How many cubic meters are there in a rectangular excavation $4\frac{1}{2}$ m. \times $3\frac{3}{4}$ m. \times 10 m.?
17. What percent of 2140 kilowatts is 902 kilowatts?

91. Important Foreign Measures

(Do not learn this table. Simply use it to solve problems 1 to 14.)

If paid in gold

1 shilling of English money = \$.243 12 pennies or 12d. = 1 shilling

1 franc of French money = .193 100 centimes = 1 franc.

1 mark of German money = .238 100 pfennigs = 1 mark.

1 meter = 39.37 in. 1 kilogram or kilo = 2.2 lb.

1. About how many marks equal a dollar?
2. About how many francs equal a dollar?
3. About how many dollars equal 20 shillings?
4. About how many American pennies equal one English penny?
5. About how many centimes equal 1 cent?
6. About how many pfennigs equal 1 cent?
7. Which is cheaper, \$1.00 a yard or 5 marks a meter?
8. Which is cheaper, 10¢ a pound or 1 mark a kilogram?
9. Find the exact price in dollars and cents of articles priced at—
(a) 5 shillings, (b) 18 francs, (c) 6½ marks, (d) 32 shillings.
10. Find the value in dollars and cents of each of these:
£1, which equals 1 pound sterling or 20 shillings.
£4, 7s. 5d. (4 pounds sterling, 7 shillings, and 5 English pennies).
10 centimes (a centime = .01 franc).
1 guinea, which equals 21 shillings.
11. How many shillings equal 10 francs?
12. What percent of a mark is a franc?
13. How many times as much is 10d. worth as 10 centimes?
14. How much less are 4 shillings than 1 dollar?

92. Review. Factoring

The numbers whose product is a number are called the factors of that number. 2, 3, and 5 are the factors of 30; for $30 = 2 \times 3 \times 5$.

To factor a number is to express it as the product of its factors.

1. Factor each of these numbers, using only whole numbers as factors:
- | | | | | | | | | | |
|----|----|----|----|----|----|----|----|----|----|
| 10 | 12 | 14 | 15 | 16 | 18 | 20 | 22 | 24 | 25 |
| 26 | 27 | 28 | 30 | 32 | 33 | 34 | 35 | 36 | 38 |

A number that is divisible without a remainder by no integers except itself and 1 is called a prime number.

2. Which of the numbers from 10 to 20 are prime?
3. Which of the numbers from 21 to 30 are prime?
4. Which of the numbers from 51 to 60 are prime?
5. How can you know whether a number is divisible by 2?
6. How can you know whether a number is divisible by 3?
7. How can you know whether a number is divisible by 5?
8. How can you know whether a number is divisible by 10?
9. Express each of these fractions in lowest terms:

<i>a.</i>	<i>b.</i>	<i>c.</i>	<i>d.</i>	<i>e.</i>	<i>f.</i>	<i>g.</i>	<i>h.</i>
$\frac{30}{36}$	$\frac{42}{105}$	$\frac{56}{55}$	$\frac{24}{30}$	$\frac{35}{75}$	$\frac{48}{60}$	$\frac{20}{24}$	$\frac{18}{24}$
<i>i.</i>	<i>j.</i>	<i>k.</i>	<i>l.</i>	<i>m.</i>	<i>n.</i>	<i>o.</i>	<i>p.</i>
$\frac{120}{144}$	$\frac{50}{64}$	$\frac{18}{32}$	$\frac{15}{24}$	$\frac{54}{64}$	$\frac{75}{96}$	$\frac{35}{50}$	$\frac{39}{48}$

93. Review. Arithmetical Language

I. Look at each of these words or phrases and tell whether it means something about an angle or triangle, something about a circle, something about business and money, something about numbers themselves, or something about the metric system:

factor product gram diameter acute meter principal
 interest equation obtuse arc mortgage note centimeter
 ratio radius sector commission discount square root
 average bond altitude profit cube root. par value liter
 circumference bank discount stock hypotenuse brokerage
 tax right angle numerator compounded semiannually
 denominator.

II. What does “*terms*” mean in each of these sentences?

The terms of his three insurance policies were, respectively, 1, 3, and 5 years.

It does not alter the value of a fraction to multiply or divide both terms by the same number.

III. Illustrate two uses of the word "*dividend*."

IV. Illustrate two uses of the word "*square*."

V. Solve these problems. (If you are not sure of the meaning of some word, study what is said about that word in the pages where it occurs in this book. You will find what the pages are in the index on pages 288 f.)

1. At 5% per year, what is the use of \$4000 for 3 years worth?
2. How much money must be invested at 4% to give \$200 income per year?
3. How much more is received per year from \$10,000 invested to yield 5% than from \$10,000 invested to yield 4½%?
4. How much is the interest on \$400 for 90 days at 4%?
5. Mr. N. bought a house and lot for \$4500, paying ⅓ cash and borrowing the rest on a mortgage at 5% interest. (a) How much did he borrow and how much interest must he pay every six months? He pays a tax on a valuation of \$3500 at the rate of \$2 per \$100. (b) How much does it cost him per year for taxes? He has the house insured for \$3000 and pays \$18 every three years for the insurance. (c) How much does he pay per \$100 per year for insurance?
6. How much does a broker earn by buying stocks of a par value of \$1200 at ⅛% commission?
7. How much do you pay for a \$6 article when you buy it (a) at a reduction of 15%? (b) At a discount of 20%, 10%?
8. What percent per year must you receive on \$5000 to have it yield an income of \$25 a month?

94. Review. Business Language and Business Problems

1. A man borrows \$500 at 5½% interest and at the end of each year he gives the lender \$100 to pay the interest for the year and a part of the principal. How much does he still owe after making the third payment of \$100?
2. How many dollars' worth must Louise sell at 12½% commission to make \$7.50?

3. Mr. A.'s money is worth 5% per year to him and his time is worth 40¢ per hour. He buys a machine for \$100 that saves him two hours a week for a year, and sells it at the end of the year for \$75. How much does he gain by doing so?
4. How much does George receive on sales of \$670 at 2½% commission?
5. The Cook County Coöperative Association store gives a discount of 3% to members of the association. What does a member of the association really pay for an article whose regular price is \$8.75?
6. What do you really pay for an article whose catalogue price is \$9.50 if you receive 30% discount?
7. How much more is a note for \$600 dated to-day, payable in 90 days, with interest at 6%, worth than a note for \$600 dated to-day, payable in 90 days without interest?
8. How much more will the first note of Ex. 7 be worth than the second, thirty days from to-day?
9. How many dollars will a bank deduct for interest at 6% from a non-interest-bearing note for \$300 payable in 90 days?
10. At 17 mills or 1.7¢ on a dollar, what is the tax on a house and lot assessed at \$7500?
11. If you leave \$150 in the savings bank at 4% interest compounded semiannually, how much interest is added to the principal at the end of the first half year? At the end of the second half year? At the end of the third half year?
12. How much will it cost to insure a house for \$5000 for three years at 25¢ per \$100 per year?
13. Mr. A. spends, each year, \$57 for taxes, \$12.50 for insurance, \$125 for painting, repairs, etc., and \$135 for interest on the mortgage on his house. (a) How much less does he spend per month now than he did when he paid \$40 a month rent? (b) He pays interest at 4½% on the mortgage. How much more would he have to pay per year for interest if the rate were 6% instead of 4½%? (c) How much is the amount of the mortgage?

95. Review. Graphs and Diagrams

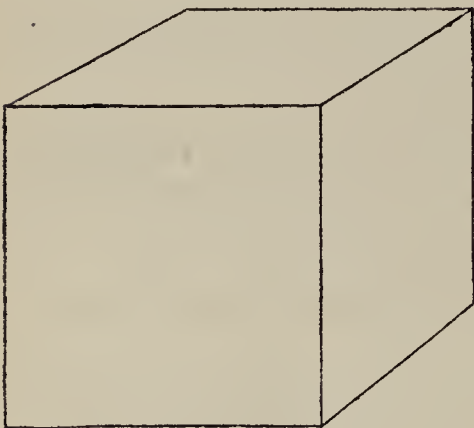

1. Copy the line shown here and draw beside it a line 8 times as long.
2. Copy the square shown here and draw beside it a square containing 8 sq. in. Use $2\frac{5}{8}$ or 2.83 as the square root of 8.
3. Copy the cube shown here and draw beside it a cube containing 8 cubic inches.

4. A man showed these two pictures a few years ago to make people believe that the number of sailors in the British navy was very, very much

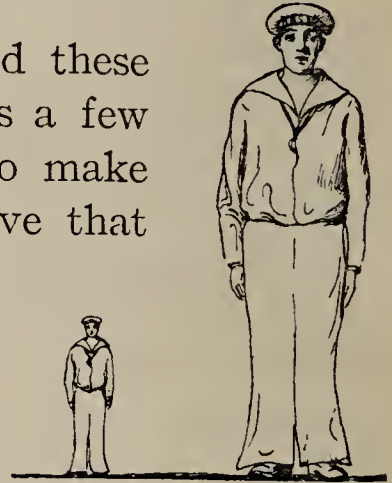

American Navy 55,389 men British Navy 150,609 men

greater than the number in the United States navy. Why do his pictures tell a lie? (The numbers with them are correct.)

5. A man showed Picture A to make certain people think that their wages were twice as high in 1915 as in 1910. Another man said, "By your own figures your picture lies. It should be like this," and drew Picture B. Which picture is correct? (The numbers are correct in both.)

Picture A

Picture B

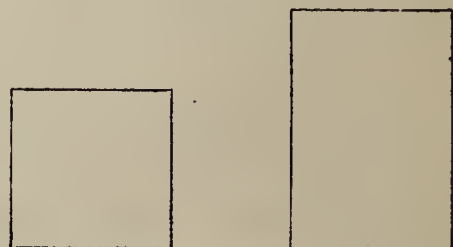
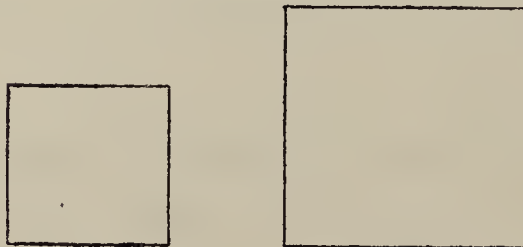

In 1910

In 1915

In 1910

In 1915

Size of pay check

Size of pay check

\$12.08

\$18.12

\$12.08

\$18.12

6. John drew this graph to show his improvement in adding. He said it showed that he did 10 times as well at the end as at the beginning.

as at the beginning. Draw it the way it should be drawn to show that he did about $1\frac{1}{2}$ times as well at the end as at the beginning. (The numbers are correct.)

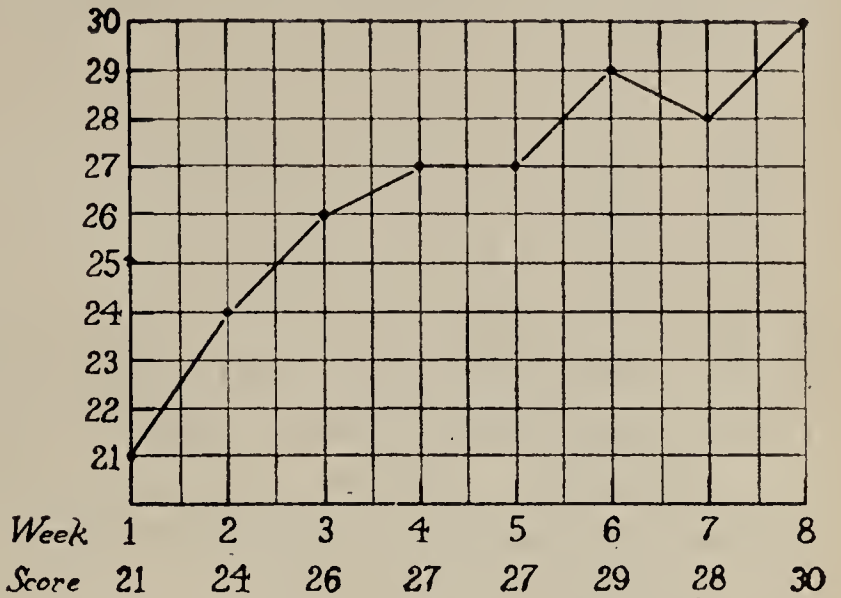

7. 100 boys and girls in the 8th-grade class took a long test of 100 problems in arithmetic. The scores were as shown in the table. The table reads "3 boys and no girls had 0 wrong, 5 boys and 4 girls had 1 wrong, etc." Read the whole table.

Number of Problems Wrong	Boys	Girls
0	3	0
1	5	4
2	8	7
3	12	11
4	20	16
5	22	24
6	13	17
7	8	10
8	3	8
9	3	3
10	2	0
11	1	0

8. Fred claimed that the boys were twice as good as the girls, because twice as many boys had only 0 or 1 error. How might a girl argue unfairly that the boys were twice as bad in this test as the girls?

9. If you find any diagrams in magazines which use pictures of men or ships or bags or other such objects to represent quantities to be compared, bring them to school.

1. Say the missing words or numbers:

A dollar is to a dime as a dime is to a . . .

A kilometer is to a meter as a . . . is to a gram.

A . . . is to an hour as a second is to a . . .

A . . . is to an inch as a dozen is to a single thing.

The ratio of a pound to an ounce is . . . to 1.

The ratio of 45 to 9 is . . . to 1.

2. State the square of 4; of 3, 2, 1, 1.1, 1.2, 10, 1.5.

3. State the square root of 81; of 36, 144, 1.44, 10,000.

4. State the volume in cubic inches of a cube $10'' \times 10'' \times 10''$. Of a cube $9'' \times 9'' \times 9''$. Of a cube $1\frac{1}{2}'' \times 1\frac{1}{2}'' \times 1\frac{1}{2}''$.

5. Which will have more nearly 100 cu. in. — a cube $4'' \times 4'' \times 4''$ or one $5'' \times 5'' \times 5''$?

6. Tell the value of each of these: 3^2 3^3 7^2 4^3 6^2 10^2 100^2 12^2

7. Tell the value of x in each of these equations:

A.

$$x = \frac{2}{3} \text{ of } 105$$

$$x + 9 = 20$$

$$180^\circ - 120^\circ = x$$

$$35 = 7x$$

$$x^2 = 49$$

$$\frac{x}{4} = 5$$

$$x^3 = (5 \times 4) + 7$$

$$x - 4 = \frac{2 \times 4 \times 3}{6}$$

B.

$$x + 8 = 15$$

$$21 - x = 16$$

$$x^2 = 81$$

$$3x = 7 + 8$$

$$\frac{8}{x} = 4$$

$$9 + x = 25$$

$$x = \sqrt{25}$$

$$x = \sqrt{10 + 6}$$

C.

$$12 + x = 16$$

$$\frac{x}{3} = 10$$

$$\frac{10}{x} = 2$$

$$10 = x \times 15$$

$$32 - x = 20$$

$$x^2 = 6^2 + 8^2$$

$$x = \sqrt{3^2 + 4^2}$$

$$x + 5 = (9 \times 2) - 8$$

8. Which will be the nearest to 100, 4.5^3 or 4.6^3 ?

9. Find the square, the square root, and the cube root of 64.

10. In a mixture of 2 parts of C and 3 parts of S and 7 parts of G, what percent is C, what percent is S, and what percent is G?

11. How many pounds of C, how many pounds of S, and how many pounds of G would you use in making 100 lb. of a mixture in these proportions:

1 part C, 3 parts S, and 8 parts G.

1. What equation do you use to find the area of a triangle?
2. Find the area of each of these triangles. The dimensions represent miles.

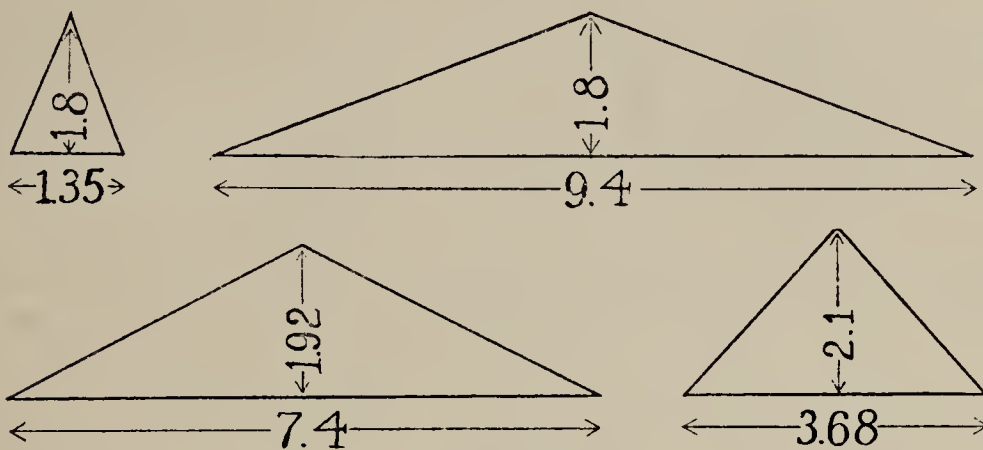

3. Which of the surfaces shown below are parallelograms? Which are sectors of circles? Which are composed of a rectangle and two semicircles?

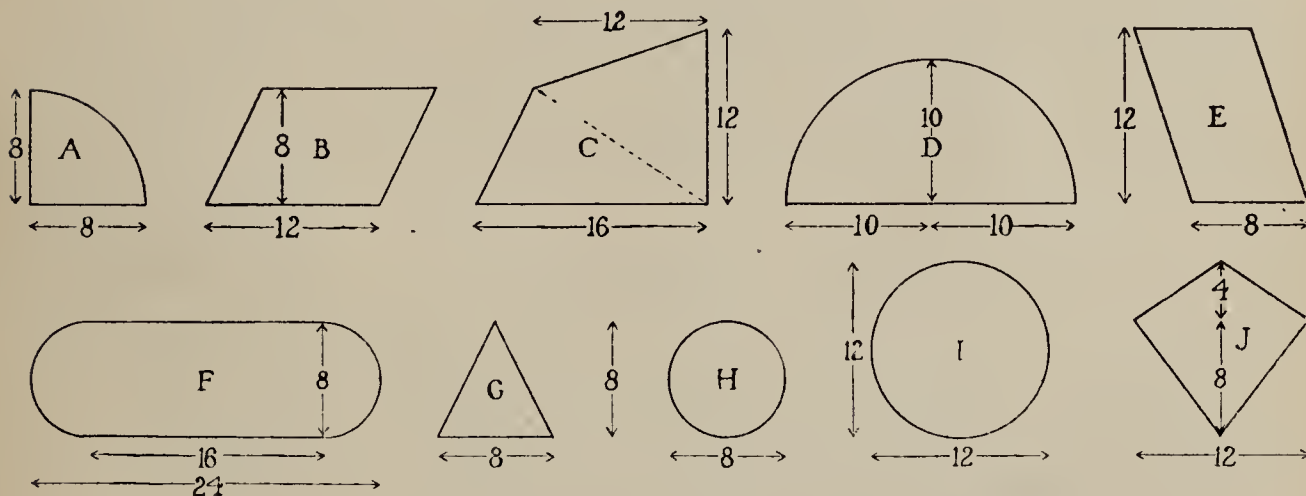

4. Use the equations printed below to find the area of each of the surfaces shown.
5. Use equations that you know (or use your common-sense) to find the perimeter of each of the surfaces shown.

The dimensions represent feet.

Area of circle = πr^2 . *Area of parallelogram* = $\text{alt.} \times \text{base}$.

Area of sector = $\frac{1}{2}r \times \text{arc}$. *Area of any surface bounded by straight lines* = *sum of areas of triangles composing it.*

Area of any surface bounded by straight lines = *sum of areas of triangles composing it.*

234 98. Optional Exercises in Understanding Equations

1. Which of the solids shown below are spheres? Which are cones? Which are pyramids? Which are cylinders?

Which are rectangular prisms (shaped like a box or beam)?

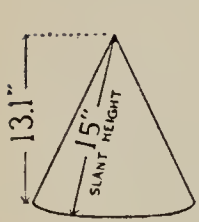

a

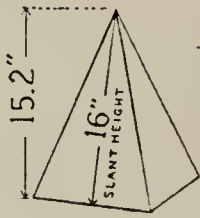

b

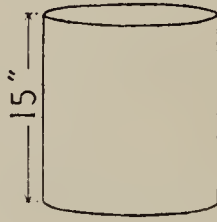

c

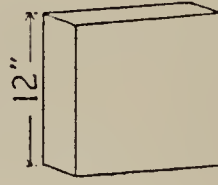

d

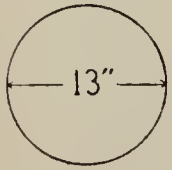

Base of a



Base of b

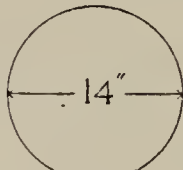

Base of c



Base of d

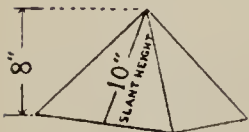

e

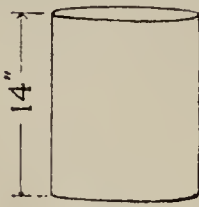

f



g

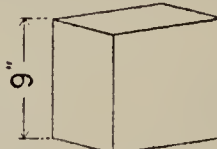

h

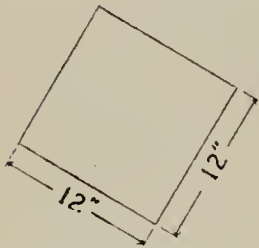
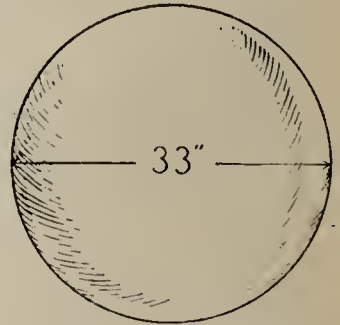

Base of e



Base of f

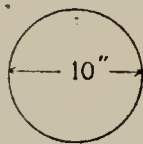

Base of g

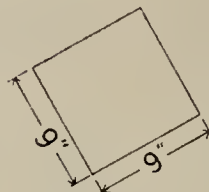

Base of h

2. Use the equations printed below to find the volume of each solid and the area of its surface.

In a cylinder, volume = alt. \times area of base.

In a cone, volume = $\frac{1}{3}$ alt. \times area of base.

In a sphere, volume = $\frac{4}{3} \pi r^3$.

In a pyramid, volume = $\frac{1}{3}$ alt. \times area of base.

In a cylinder, surface = $2 \times$ (area of base) + (alt. $\times 2\pi r$).

In a cone, surface = area of base + ($\frac{1}{2}$ slant height \times circumf. of base). The pictures show what the slant height is.

In a sphere, surface = $4 \pi r^2$

In a pyramid, surface = (area of base) + ($\frac{1}{2}$ slant height \times perimeter of base).

1. At $1\frac{1}{4}$ bushels of seed per acre, how much buckwheat is required to sow a 6-acre field?
2. How many tiles 6 in. square will be required to cover a space 8 ft. \times 10 ft.?
3. When Jan. 8 comes on Monday, what day of the week will Jan. 25 be? What day of the week will Feb. 8 be?
4. Soldiers marching 2 ft. 6 in. per step and 100 steps to a minute, go how far in 5 min.?
5. Helen and Dora are the two candidates for class president. If forty-one children vote, how many votes must Helen have to beat Dora by 5 votes?
6. How long will it take 200 men to do what 100 men can do in 12 days?
7. If one pipe can fill a tank in 2 hr. and another pipe can fill it in 3 hr., how long will it take both pipes together to fill the tank?
8. How many strips of carpet $\frac{3}{4}$ yd. wide will cover a floor 18 ft. wide?
9. What does a square inch represent on a map when a line $\frac{1}{8}$ in. long represents 1 mile? When a line 1 inch long represents 50 mi.?
10. A roller is 11 ft. in circumference and 5 ft. long. (a) How many revolutions does it make in going 330 ft.? (b) How many square feet does it roll in going that distance?
11. In a fort there are 60 men and enough food to keep the 60 men for 20 days. (a) How long will it last if 20 more men come? (b) If 20 new men come and 40 of the first 60 go?

The rate for sending money by telegraph is $2 \times$ (cost of 10-word message) + (1% of amount sent).

12. What does it cost to send \$2.50 from New York (a) to Alabama (10-word rate is \$.60)? (b) To Arizona (10-word rate is \$1.00)?
13. Agnes can typewrite n pages in c hours. How many pages can she typewrite in $3c$ hours?

14. An orchard has a rows, b trees in a row. How many trees are there in all?
15. A boy was at bat d times and made f base hits. What was his percent of base hits?
16. A train goes r miles per hour. How far does it go in a minute?
17. A train goes k miles in 10 hours. How far does it go in 20 hours, at that rate?
18. A man bought a house for h dollars, a lot for i dollars, and spent j dollars on furnishings. What represents his total expenses?
19. Three girls agree to divide the cost of renting a typewriter in proportion to the number of hours each uses it. The rent is \$12. Anna uses it 150 hours, Dorothy uses it 100 hours, and Grace uses it 50 hours. How much should each girl pay?
20. What sum must be invested at 5% to yield \$100 per year?
21. It costs \$3.20 to manufacture a certain article. The expenses of selling it are 25% of the cost. What price would you put on it so as to make 10% more than the cost of manufacturing and selling it?
22. Mr. Logan fails in business and can pay the persons to whom he owes money only 30 cents on a dollar. How much can he pay on a debt of \$25?
23. The cost for insurance of \$2500 for three years is \$16.20. At that rate what would be the cost of \$1000 insurance for 1 yr.?

100. Review. Problem Solving

1. A train leaves Spokane at 8:25 A.M. and reaches Pasco, 147 miles distant, at 12:45 P.M. Allowing 24 min. for stops, what is the average rate while the train is moving?
2. From 9 A.M. to noon an automobile went 50 miles. At that rate, how far will it go from 1 P.M. to 8:30 P.M.?
3. A man offered a new car for \$1000, asserting this was 20% less than it cost him. What did he say it cost? The car really cost him \$1200. What percent reduction did he make?

4. Helen can copy $4\frac{1}{2}$ pp. per hr.; Sarah can copy $3\frac{3}{4}$ pp. per hr. How long will it take both together to copy $41\frac{1}{4}$ pp.?

5. Which is the largest, and which is the smallest, of these fractions?

$$\frac{19}{160}$$

$$\frac{23}{200}$$

$$\frac{13}{110}$$

6. A watch that loses $\frac{1}{2}$ minute per day, loses how many seconds per hour?

7. A family with an income of \$950 spent \$378 on food, \$200 on rent, and \$188 on clothes. What percent of the income was spent on food? On rent? On clothes?

8. How long will four barrels of water, each containing $31\frac{1}{2}$ gallons, last 8 men, if each is given $1\frac{1}{2}$ pt. per day for five days and 1 pt. a day after that?

9. In taking food for a camping trip, hunters count on $2\frac{1}{8}$ lb. per man per day for a summer trip and $2\frac{1}{2}$ lb. per man per day for a winter trip. How much less is the weight for four men for an eight-day trip in the summer than it is in the winter?

10. What percent is the weight for a summer trip of the weight for a winter trip, the number of men and the length of the trip being the same?

11. How long will 100 lb. last 4 men on a summer trip? On a winter trip?

12. (a) How many more sq. ft. of floor space has a tent of $9\frac{1}{2}' \times 11\frac{5}{6}'$ floor space than a tent of $7\frac{1}{6}' \times 7\frac{1}{6}'$ floor space?

(b) How much larger is a rectangular box $3\frac{1}{4}'$ by $2\frac{1}{2}'$ by $2\frac{2}{3}'$ than a cube each of whose edges is $2\frac{2}{3}$ ft. long?

13. How many times as much floor space has a tent of 11 ft. 10 in. \times 14 ft. 3 in. floor space than a tent of 7 ft. 2 in. \times 7 ft. 2 in. floor space?

14. Mr. M. plans to make this lawn 20% longer and 10% wider than it is



now. How many square feet will it have then? What percent of its present area will its area then be?

The surface of a sphere = $4 \pi r^2$ (where r = the radius of the sphere).

The volume of a sphere = $\frac{4}{3} \pi r^3$ (where r = the radius of the sphere).

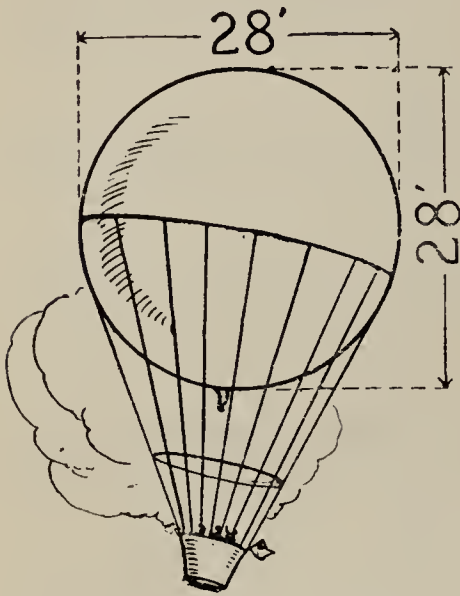

15. How many square yards of silk are needed to make this spherical balloon, allowing 60 sq. yd. for overlapping and waste in cutting? (Find result to the nearest square yard.)
16. How many cubic feet of gas does the balloon hold? (Find result to the nearest cubic foot.)
17. How much more will it weigh when filled with air weighing 2.2 lb. per cu. yd. than it will weigh when filled with hydrogen weighing .15 lb. per cu. yd.? (Find result to the nearest pound.)
18. How much does it cost to fill the balloon with gas at \$1.10 per 1000 cu. ft.? (Find result to the nearest dollar.)
19. In 1911 prices were 44% higher than in 1897, so that a dollar in 1911 would buy only $\frac{100}{144}$ as much as in 1897. Which was really better, a salary of \$700 in 1897, or a salary of \$1000 in 1911?
20. A man borrows \$500 at 6%. Each year for three years he pays \$150. How much does he owe at the end of the third year?
21. During a year Mr. S. borrows \$500 for 30 days on four occasions, and \$500 for 60 days on three occasions. How much interest does he pay in all at 6%?
22. What sum of money must be invested at 4% to yield an annual income of \$500? At 4½%, how much annual income would that sum of money yield?
23. A push-cart man buys eggs at 15¢ per dozen and sells them at 15 for 25¢. How many eggs must he sell to earn \$1.80?
24. What is the value of the butter-fat in 475 lb. milk containing 3.9% butter-fat, at 28¢ per lb.?

25. Which is worth more for butter-fat, 475 lb. containing 3.9% butter-fat, or 580 lb. containing 3.2% butter-fat?
26. What will it cost to lay six rows of drain tile, each row 60 rods long, counting the tile at \$24.75 per 1000 ft. and the labor of digging the trenches and laying the tile at 40¢ per rod?
27. Mr. A. conducts a motion-picture theater which has 250 seats. The admission charge is 5¢ in the afternoon and 10¢ in the evening. The average number of paid admissions per day is 720, of which 486 are evening admissions. The expenses are \$325 a year for advertising, \$1460 a year for rent and heat, \$18 a week for operator, \$75 a week for rental of films, and \$15.70 for each day that the theater is open, for electricity, ticket seller, ticket taker, ushers, cleaning, and incidentals. How much does Mr. A. receive per year for his risk and time in carrying on this motion-picture business, if the theater is open in all 310 days?
28. Mr. E. bought 10 crates, each containing 24 boxes of strawberries, for \$2.25 a crate. (a) How much must he charge per box to make enough to pay for the berries, \$1.50 for the use of a horse and wagon for a day, and \$3.25 for his time, labor, and risk, counting that he sells every box? (b) If he sells all but six boxes at 2 boxes for 25¢, and sells the six boxes for 10¢ each, how much does he receive for his time, labor, and risk?
29. On Jan. 1, 1917, Arthur begins business with \$900 of his own. He plans to have $1\frac{1}{2}$ times as much by Jan. 1, 1918, and $1\frac{1}{2}$ times as much on Jan. 1, 1919, as on Jan. 1, 1918, and so on, increasing his property by 50% each year over the last. Find how much he plans to have on Jan. 1, 1918, Jan. 1, 1919, Jan. 1, 1920, Jan. 1, 1921, and on Jan. 1, 1922.
30. Draw a graph that will show the way Arthur hopes to make his property increase.
31. A man began with \$1000. Each year for five years he doubled his money. Show the facts in a graph.

I. Tell the missing numbers or words:

12 in. = 1 ...	1 acre = ... sq. rd.
16½ ft. = 1 ...	1 sq. mi. = ... A.
320 rd. = 1 ...	1 cu. ft. = ... cu. in.
1 sq. ft. = ... sq. in.	1 cu. yd. = ... cu. ft.
1 sq. rd. = ... sq. ft.	1 mile = ... ft.

II. Solve these problems:

- How many cubic feet will 4 cords of wood occupy?
- A perch of stone or masonry is 16½ ft. long, 1½ ft. thick, and 1 ft. high. How many cubic feet equal 12 perches?
- A vara = 33⅓ inches. How many varas equal 1 mile? How many square varas equal one acre?
- 1 knot or *nautical mile* = 1.151 regular miles. If the rate is 22 knots per hr., what is the rate in regular miles?
- How many knots per hr. does a ship go at the rate of 20 regular miles per hr.?
- A long ton is 2240 lb. How many long tons equal 100 regular tons?
- 1 bbl. (barrel) = 31½ gallons. How many bbl. does a 500-gallon tank hold?

102. Time and Distance

This table tells the distances from New York to Hillsdale and places on the way to Hillsdale by a main automobile road.

DISTANCES FROM NEW YORK	MILES
to Yonkers	13.2
to Dobbs Ferry	19.5
to Briarcliff	32.1
to Lake Mahopac	54.1
to Carmel	59.9
to Pawling	73.5
to Amenia	96.9
to Copake	117.3
to Hillsdale	123.5

- How far is it from Yonkers to Dobbs Ferry?
- How far is it from Dobbs Ferry to Briarcliff?
- How many times as far is it from Lake Mahopac to Pawling as it is from Lake Mahopac to Carmel?

4. How many times as far is it from New York to Hillsdale as it is from New York to Briarcliff?
5. What fraction of the entire trip from New York to Hillsdale is completed when you reach Lake Mahopac? When you reach Pawling? When you reach Amenia?
6. Leaving New York at 8 A.M. and traveling at the rate of 18 mi. per hour, when will you reach Carmel?
7. If, after stopping at Carmel for lunch, you start again at 1:15 P.M. and go at the rate of 20 miles an hour, at what time will you reach Hillsdale?
8. If you use $10\frac{1}{2}$ gallons of gasoline on the entire trip of Ex. 6 and Ex. 7, how many miles have you traveled per gallon of gasoline?
9. How much time should you allow for the trip from New York to Hillsdale, counting 15 miles per hour when actually in motion, 45 min. for lunch, and one hour and a half for breakdowns and other special stops?
10. Make up two problems for the class to solve about a trip on this road.

103. Hidden Facts

The makers of this automobile claim that it can be run at a total cost of $2\frac{1}{2}\text{¢}$ per mile, distributed as follows:

	Cost per mile
Gasoline (25 miles per gal. at 20¢)	.008
Oil (800 miles per gal. at 60¢)	.00075
Tires \$12 each	.0032
Repairs \$50 per year	.00333 $\frac{1}{3}$
Insurance (theft, fire)	.00066 $\frac{2}{3}$
Deprec. 25% yearly	.00666 $\frac{2}{3}$
Interest at 6%	.0016
Total	.02421 $\frac{2}{3}$

1. A man read this statement in a magazine. He wished to know the price of this automobile and how many miles per year the makers counted, in making the estimates of the statement. His 14-year-old son found out from the statement itself. Can you?

In shops, offices, and schools, people make use very often of tables to save the time of long computations. In using tables, it is necessary (1) to know what the numbers in the tables mean, (2) to choose the right tables, (3) to find the numbers that you need, (4) to copy them exactly, and (5) to use them in the right way. The exercises on this page and page 243 are to give you practice in choosing and using the tables on pages 244 to 248.*

1. Use the tables to find:

$$19^2 \quad \sqrt{19} \quad \sqrt[3]{19} \quad 19^3 \quad \frac{1}{19} \text{ (expressed as a decimal)}$$

$$\sqrt{8} \quad \sqrt{12} \quad 24^2 \quad \sqrt[3]{15} \quad \sqrt{20} \quad \sqrt[3]{22} \quad 23^3 \quad \sqrt{5}$$

$$\sqrt[3]{10} \quad \sqrt[3]{14} \quad \sqrt{17} \quad 18^3 \quad 23^2 \quad 21^3 \quad \sqrt{17} \quad \sqrt{2} \quad \sqrt[3]{2}$$

2. To express as decimal fractions:

$$\frac{1}{7} \quad \frac{1}{11} \quad \frac{1}{13} \quad \frac{1}{15} \quad \frac{1}{19} \quad \frac{1}{23}$$

3. To find the number of ounces in:

$$10 \text{ g.} \quad 83 \text{ g.} \quad 46 \text{ g.} \quad 300 \text{ g.} \quad 500 \text{ g.} \quad 98 \text{ g.} \quad 1000 \text{ g.} \quad 268 \text{ g.}$$

4. To find the number of grams in:

$$\frac{1}{32} \text{ oz.} \quad 7 \text{ oz.} \quad 9 \text{ oz.} \quad 8\frac{1}{2} \text{ oz.} \quad 2 \text{ lb. } 4 \text{ oz.} \quad 1\frac{1}{8} \text{ oz.} \quad 4\frac{3}{16} \text{ oz.}$$

$$\frac{3}{32} \text{ oz.} \quad \frac{7}{16} \text{ oz.} \quad \frac{5}{8} \text{ oz.} \quad \frac{3}{4} \text{ oz.} \quad .7 \text{ oz.} \quad .6 \text{ oz.} \quad 10.6 \text{ oz.} \quad 10.3 \text{ oz.}$$

5. *a.* To find the interest on \$600 at $5\frac{1}{2}\%$ for 60 da.
b. To find the interest on \$350 at $5\frac{1}{2}\%$ for 90 da.
c. To find the interest on \$800 at $4\frac{1}{2}\%$ for 6 mo.
d. To find the interest on \$450 at 7% for 90 da.
e. To find the interest on \$250 at 8% for 60 da.
f. To find the interest on \$300 at 7% for 4 mo. and 5 days.
g. To find the interest on \$700 at 5% for 90 da.
h. To find the interest on \$1000 at $4\frac{1}{2}\%$ for 6 mo.
i. To find the interest on \$1000 at 5% for 60 da.
j. To find the interest on \$6000 at 5% for 10 da.

6. Try to find the squares of the numbers from 13 to 25 without using the tables or pencil and paper.

* TO THE TEACHER.—Explain the nature and use of the tables only when it is necessary. Let the pupils find out for themselves so far as they can.

Number	Square	Cube	Sq. Root	Cube Root	Reciprocal
1	1	1	1.000	1.000	1.000
2	4	8	1.414	1.260	0.500
3	9	27	1.732	1.442	.333
4	16	64	2.000	1.587	.250
5	25	125	2.236	1.710	.200
6	36	216	2.449	1.817	.167
7	49	343	2.646	1.913	.143
8	64	512	2.828	2.000	.125
9	81	729	3.000	2.080	.111
10	100	1000	3.162	2.154	.100
11	121	1331	3.317	2.224	.091
12	144	1728	3.464	2.289	.083
13	169	2197	3.606	2.351	.077
14	196	2744	3.742	2.410	.071
15	225	3375	3.873	2.466	.067
16	256	4096	4.000	2.520	.063
17	289	4913	4.123	2.571	.059
18	324	5832	4.243	2.621	.056
19	361	6859	4.359	2.668	.053
20	400	8000	4.472	2.714	.050
21	441	9261	4.583	2.759	.048
22	484	10648	4.690	2.802	.045
23	529	12167	4.796	2.844	.043
24	576	13824	4.899	2.884	.042

Conversion Table. Grams to Ounces

Grams	Ounces	Grams	Ounces	Grams	Ounces	Grams	Ounces	Grams	Ounces
1	0.035	21	0.741	41	1.446	61	2.151	81	2.857
2	0.071	22	0.776	42	1.481	62	2.187	82	2.892
3	0.106	23	0.811	43	1.517	63	2.222	83	2.927
4	0.141	24	0.846	44	1.552	64	2.257	84	2.963
5	0.176	25	0.882	45	1.587	65	2.293	85	2.998
6	0.212	26	0.917	46	1.622	66	2.328	86	3.033
7	0.247	27	0.952	47	1.658	67	2.363	87	3.068
8	0.282	28	0.988	48	1.693	68	2.398	88	3.104
9	0.317	29	1.023	49	1.728	69	2.434	89	3.139
10	0.353	30	1.058	50	1.764	70	2.469	90	3.174
11	0.388	31	1.093	51	1.799	71	2.504	91	3.210
12	0.423	32	1.128	52	1.834	72	2.539	92	3.245
13	0.458	33	1.164	53	1.869	73	2.575	93	3.280
14	0.494	34	1.199	54	1.905	74	2.610	94	3.315
15	0.529	35	1.234	55	1.940	75	2.645	95	3.351
16	0.564	36	1.270	56	1.975	76	2.681	96	3.386
17	0.599	37	1.305	57	2.010	77	2.716	97	3.421
18	0.635	38	1.340	58	2.046	78	2.751	98	3.456
19	0.670	39	1.376	59	2.081	79	2.786	99	3.492
20	0.705	40	1.411	60	2.116	80	2.822	100	3.527

Conversion Table. Ounces to Grams

Ounces	Grams	Ounces	Grams	Ounces	Grams	Ounces	Grams
$\frac{1}{16}$	1.77	$\frac{3}{8}$	10.63	1	28.35	9	255.15
$\frac{1}{12}$	2.36	$\frac{5}{8}$	17.72	2	56.70	10	283.50
$\frac{1}{8}$	3.54	$\frac{7}{8}$	24.81	3	85.05	11	311.84
$\frac{1}{6}$	4.73	$\frac{3}{16}$	5.32	4	113.40	12	340.20
$\frac{1}{4}$	7.09	$\frac{5}{16}$	8.86	5	141.75	13	368.55
$\frac{1}{3}$	9.45	$\frac{7}{16}$	12.40	6	170.10	14	396.90
$\frac{1}{2}$	14.17	$\frac{9}{16}$	15.95	7	198.45	15	425.25
$\frac{2}{3}$	18.90	$1\frac{1}{16}$	19.49	8	226.80	16	453.60
$\frac{3}{4}$	21.27	$1\frac{3}{16}$	23.04				
$\frac{5}{6}$	23.62	$1\frac{5}{16}$	26.58				

Products of 879 \times 1, 2, 3, 4, etc.

879	0	100	200	300	400	500	600	700	800	900	
0	0	879	1758	2637	3516	4395	5274	6153	7032	7911	00
1	8	887	1766	2645	3524	4403	5282	6161	7040	7919	79
2	17	896	1775	2654	3533	4412	5291	6170	7049	7928	58
3	26	905	1784	2663	3542	4421	5300	6179	7058	7937	37
4	35	914	1793	2672	3551	4430	5309	6188	7067	7946	16
5	43	922	1801	2680	3559	4438	5317	6196	7075	7954	95
6	52	931	1810	2689	3568	4447	5326	6205	7084	7963	74
7	61	940	1819	2698	3577	4456	5335	6214	7093	7972	53
8	70	949	1828	2707	3586	4465	5344	6223	7102	7981	32
9	79	958	1837	2716	3595	4474	5353	6232	7111	7990	11
10	87	966	1845	2724	3603	4482	5361	6240	7119	7998	90
11	96	975	1854	2733	3612	4491	5370	6249	7128	8007	69
12	105	984	1863	2742	3621	4500	5379	6258	7137	8016	48
13	114	993	1872	2751	3630	4509	5388	6267	7146	8025	27
14	123	1002	1881	2760	3639	4518	5397	6276	7155	8034	06
15	131	1010	1889	2768	3647	4526	5405	6284	7163	8042	85
16	140	1019	1898	2777	3656	4535	5414	6293	7172	8051	64
17	149	1028	1907	2786	3665	4544	5423	6302	7181	8060	43
18	158	1037	1916	2795	3674	4553	5432	6311	7190	8069	22
19	167	1046	1925	2804	3683	4562	5441	6320	7199	8078	01
20	175	1054	1933	2812	3691	4570	5449	6328	7207	8086	80
21	184	1063	1942	2821	3700	4579	5458	6337	7216	8095	59
22	193	1072	1951	2830	3709	4588	5467	6346	7225	8104	38
23	202	1081	1960	2839	3718	4597	5476	6355	7234	8113	17
24	210	1089	1968	2847	3726	4605	5484	6363	7242	8121	96
25	219	1098	1977	2856	3735	4614	5493	6372	7251	8130	75
26	228	1107	1986	2865	3744	4623	5502	6381	7260	8139	54

27	237	1116	1995	2874	3753	4632	5511	6390	7269	8148	<i>33</i>
28	246	1125	2004	2883	3762	4641	5520	6399	7278	8157	<i>12</i>
29	254	1133	2012	2891	3770	4649	5528	6407	7286	8165	<i>91</i>
30	263	1142	2021	2900	3779	4658	5537	6416	7295	8174	<i>70</i>
31	272	1151	2030	2909	3788	4667	5546	6425	7304	8183	<i>49</i>
32	281	1160	2039	2918	3797	4676	5555	6434	7313	8192	<i>28</i>
33	290	1169	2048	2927	3806	4685	5564	6443	7322	8201	<i>07</i>
34	298	1177	2056	2935	3814	4693	5572	6451	7330	8209	<i>86</i>
35	307	1186	2065	2944	3823	4702	5581	6460	7339	8218	<i>65</i>
36	316	1195	2074	2953	3832	4711	5590	6469	7348	8227	<i>44</i>
37	325	1204	2083	2962	3841	4720	5599	6478	7357	8236	<i>23</i>
38	334	1213	2092	2971	3850	4729	5608	6487	7366	8245	<i>02</i>
39	342	1221	2100	2979	3858	4737	5616	6495	7374	8253	<i>81</i>
40	351	1230	2109	2988	3867	4746	5625	6504	7383	8262	<i>60</i>
41	360	1239	2118	2997	3876	4755	5634	6513	7392	8271	<i>39</i>
42	369	1248	2127	3006	3885	4764	5643	6522	7401	8280	<i>18</i>
43	377	1256	2135	3014	3893	4772	5651	6530	7409	8288	<i>97</i>
44	386	1265	2144	3023	3902	4781	5660	6539	7418	8297	<i>76</i>
45	395	1274	2153	3032	3911	4790	5669	6548	7427	8306	<i>55</i>
46	404	1283	2162	3041	3920	4799	5678	6557	7436	8315	<i>34</i>
47	413	1292	2171	3050	3929	4808	5687	6566	7445	8324	<i>13</i>
48	421	1300	2179	3058	3937	4816	5695	6574	7453	8332	<i>92</i>
49	430	1309	2188	3067	3946	4825	5704	6583	7462	8341	<i>71</i>
50	439	1318	2197	3076	3955	4834	5713	6592	7471	8350	<i>50</i>

Interest on \$100

Time	Rate						
	4%	4½%	5%	5½%	6%	7%	8%
1 day	\$.011	\$.012	\$.014	\$.015	\$.017	\$.019	\$.022
2 days	.022	.025	.028	.030	.033	.039	.044
3 days	.033	.037	.042	.046	.050	.058	.067
4 days	.044	.050	.055	.061	.067	.078	.089
5 days	.056	.062	.069	.076	.083	.097	.111
6 days	.067	.075	.083	.092	.10	.117	.133
30 days	.333	.375	.417	.458	.50	.583	.667
60 days	.667	.750	.833	.917	1.00	1.166	1.333
90 days	1.000	1.125	1.250	1.375	1.50	1.75	2.000
6 mo.	2.000	2.250	2.500	2.750	3.000	3.50	4.000
12 mo.	4.000	4.500	5.000	5.500	6.000	7.00	8.000

Contents in Board Feet of Joists, Scantling, and Timber

Length in Feet

Cross Section	Feet Board Measure									
	12	14	16	18	20	22	24	26	28	30
2 × 4	8	9	11	12	13	15	16	17	19	20
2 × 6	12	14	16	18	20	22	24	26	28	30
2 × 8	16	19	21	24	27	29	32	35	37	40
2 × 10	20	23	27	30	33	37	40	43	47	50
2 × 12	24	28	32	36	40	44	48	52	56	60
2 × 14	28	33	37	42	47	51	56	61	65	70
3 × 8	24	28	32	36	40	44	48	52	56	60
3 × 10	30	35	40	45	50	55	60	65	70	75
3 × 12	36	42	48	54	60	66	72	78	84	90
3 × 14	42	49	56	63	70	77	84	91	98	105
4 × 4	16	19	21	24	27	29	32	35	37	40
4 × 6	24	28	32	36	40	44	48	52	56	60
4 × 8	32	37	43	48	53	59	64	69	75	80
4 × 10	40	47	53	60	67	73	80	87	93	100
4 × 12	48	56	64	72	80	88	96	104	112	120
4 × 14	56	65	75	84	93	103	112	121	131	140
6 × 6	36	42	48	54	60	66	72	78	84	90
6 × 8	48	56	64	72	80	88	96	104	112	120
6 × 10	60	70	80	90	100	110	120	130	140	150
6 × 12	72	84	96	108	120	132	144	156	168	180

APPENDIX

It is not intended that any one pupil should do all the work of this appendix, though nothing is included which is not worth while for all, apart from its special practical value for a particular class. Sections 1 to 8 give practice of special value for those who will use arithmetic chiefly in clerical work; sections 9 to 16 give training of special value for mechanical trades and professions; sections 17 to 24 review arithmetic using problems of country life and agriculture; sections 25 to 32 present certain features of pure arithmetic of special interest to those who are mathematically gifted or are destined to study algebra. The work for any class or pupil may be that of one of these four groups, or a selection from two or more groups.

1. Errorless Counting and Tabulating

In business, manufacturing, home-management, and everywhere else, absolutely accurate counting is necessary. Neat and thoughtful arrangement of the results of counting is very desirable.

1. Make a table showing how many of these 40 items are listed as *Boston*, how many are listed as *Chicago*, how many are listed as *Duluth*, etc.

2. Make a second table showing how many are from \$10.50 to \$11.49 in price, how many are from \$11.50 to \$12.49, how many are from \$12.50 to \$13.49, etc.

3. Make a third table showing how many are in Class I, how many are in Class II, how many are in Class III, etc.

4. Think of ways to check the accuracy of your counting.

5. Express the facts of each table as percents of 40.

6. Arrange all your tables in clear, brief, and neat form, if they are not so already.

LOCALITY	CLASS	PRICE
Chicago	I	\$10.75
Boston	V	11.90
St. Louis	II	13.25
St. Louis	I	11.70
Duluth	III	12.15

Chicago	V	11.40
Albany	IV	14.30
St. Louis	I	10.75
Boston	I	12.00
Chicago	III	12.50

Albany	V	14.25
Duluth	II	14.50
Boston	IV	12.25
St. Louis	I	14.75
Duluth	V	11.80

Chicago	V	14.35
Boston	I	15.90
Chicago	II	14.40
Chicago	IV	15.10
St. Louis	V	12.20

Chicago	I	11.00
Albany	II	10.90
Boston	V	12.45
Duluth	III	13.15
Boston	I	12.50

Duluth	II	10.50
Chicago	V	10.60
St. Louis	IV	12.10
Boston	I	11.50
Boston	V	13.55

St. Louis	III	14.89
Albany	I	10.80
Chicago	II	15.90
Chicago	IV	12.72
Chicago	II	13.60

St. Louis	III	15.20
Duluth	I	11.55
Boston	IV	15.45
St. Louis	I	11.35
Chicago	IV	13.10

2. Comparing Entries

Look at each pair of numbers. Make a list of the letters of those pairs where the two numbers are *not* exactly alike.

<i>a.</i> 702645	702645	<i>A.</i> 908701	908701
<i>b.</i> 610124	611124	<i>B.</i> 116872	116872
<i>c.</i> 503763	503763	<i>C.</i> 805794	805794
<i>d.</i> 921821	921821	<i>D.</i> 248067	248067
<i>e.</i> 869030	863090	<i>E.</i> 753915	753915
<i>f.</i> 274502	274502	<i>F.</i> 310283	210283
<i>g.</i> 485734	485734	<i>G.</i> 601943	601943
<i>h.</i> 697685	697685	<i>H.</i> 439250	439250
<i>i.</i> 806960	806960	<i>I.</i> 583622	583922
<i>j.</i> 378117	378171	<i>J.</i> 927474	927474
<i>k.</i> 145900	145900	<i>K.</i> 845825	845825
<i>l.</i> 238392	238392	<i>L.</i> 646935	646935
<i>m.</i> 39273	39273	<i>M.</i> 767561	767561
<i>n.</i> 901284	901284	<i>N.</i> 385000	380000
<i>o.</i> 861357	861357	<i>O.</i> 466799	467699
<i>p.</i> 450549	490594	<i>P.</i> 674887	674877
<i>q.</i> 546457	546457	<i>Q.</i> 589746	589746
<i>r.</i> 673860	673860	<i>R.</i> 291968	291968
<i>s.</i> 896812	896812	<i>S.</i> 109590	109590
<i>t.</i> 782933	782833	<i>T.</i> 323041	323041
<i>u.</i> 638542	638542	<i>U.</i> 347391	347391
<i>v.</i> 596169	596169	<i>V.</i> 252824	252824
<i>w.</i> 405970	405970	<i>W.</i> 861753	861735
<i>x.</i> 924441	92441	<i>X.</i> 486798	486798
<i>y.</i> 133508	133508	<i>Y.</i> 719060	719060

3. Errorless Copying and Adding

Copy these columns and find the sums. Look carefully at the number before you copy it; remember it so that you won't have to look a second time. Check your results by adding with the printed numbers in the book, laying a slip of paper across the page under the columns that you add.

1.	2.	3.	4.	5.
93.25	47.36	91.87	64.15	31.82
42.31	92.54	92.35	57.49	12.89
97.16	73.95	89.62	87.94	46.17
49.32	94.31	21.45	36.24	45.29
<u>97.52</u>	<u>82.54</u>	<u>67.43</u>	<u>29.34</u>	<u>17.63</u>
6.	7.	8.	9.	10.
459.62	412.58	826.53	614.87	357.81
723.89	465.21	271.63	819.37	725.39
128.76	539.26	874.36	968.51	846.23
346.12	395.48	432.16	153.67	164.83
<u>541.78</u>	<u>716.29</u>	<u>298.17</u>	<u>369.78</u>	<u>238.74</u>
11.	12.	13.	14.	15.
9836.42	1683.79	6945.17	2539.14	7456.82
4263.57	3721.59	7549.36	2978.35	6275.19
6541.73	9473.86	5897.61	1348.52	1462.37
8371.62	6913.24	8145.36	3261.75	3687.92
<u>4685.71</u>	<u>9716.48</u>	<u>4796.12</u>	<u>4956.83</u>	<u>7842.95</u>

4. Computing Discounts

Here are the list prices and discounts of 15 articles sold by the N. P. Co.

Article	List Price	% Discount	Article	List Price	% Discount	Article	List Price	% Discount
B 14	\$2.40	20	E 6	\$2.00	30	J 7	\$ 1.25	10
B 18	2.50	20	E 10	5.00	30	J 12	7.20	10
C 9	2.80	15	G 4	1.50	16 $\frac{2}{3}$	K 18	9.00	12
C 11	1.60	15	G 8	6.00	16 $\frac{2}{3}$	M 2	3.20	40
D 3	4.80	33 $\frac{1}{3}$	H 2	9.00	35	O 16	16.00	18

You are a clerk for the N. P. Co. who has to write the list price, discount, and net price for each of the 30 orders on page 253.

Write each result neatly as shown for Order No. 1.

Order No.	Art.	List and Discount	Net	Order No.	Art.	Order No.	Art.
1. 6	C 9	\$16.80		11. 4	E 6	21. 4	C 9
		2.52	\$14.28	12. 5	J 7	22. 6	D 3
2. 4	D 3			13. 3	C 11	23. 2	B 18
3. 6	G 8			14. 6	E 10	24. 6	C 11
4. 3	B 18			15. 6	K 18	25. 4	M 2
5. 2	C 11			16. 6	J 12	26. 5	J 7
6. 6	H 2			17. 2	G 4	27. 3	E 6
7. 5	M 2			18. 5	O 16	28. 7	E 10
8. 8	O 16			19. 5	J 12	29. 1	O 16
9. 2	G 8			20. 8	B 14	30. 5	G 4
10. 3	C 9						

5. Short Methods

- Which is quicker and less likely to cause mistakes, I or II?
- Which is quicker and less likely to cause mistakes, A or B?

I.	II.	A. $144 \times \$.0625$
9	525	B. $144 \times \frac{1}{16}$
<u>525</u>	9	
45	<u>4725</u>	
18		
<u>45</u>		
4725		

- Find the amount of each of these orders:

a. 618 articles at 4¢	e. 725 articles at 11¢
b. 390 articles at 7¢	f. 196 articles at 5¢
c. 415 articles at 9¢	g. 250 articles at $12\frac{1}{2}$ ¢
d. 275 articles at 8¢	h. 72 articles at $37\frac{1}{2}$ ¢

When convenient, you have used $\frac{5}{6}$ for $83\frac{1}{3}$ ¢, $\frac{1}{6}$ for $16\frac{2}{3}$ ¢, $\frac{1}{12}$ for $8\frac{1}{3}$ ¢, etc.

It is often convenient to use $\frac{5}{4}$ for \$1.25, $\frac{7}{4}$ for \$1.75, $\frac{9}{4}$ for \$2.25, etc.

- What could you use for \$1.12 $\frac{1}{2}$? For \$1.33 $\frac{1}{3}$? For \$1.08 $\frac{1}{3}$?
For \$1.62 $\frac{1}{2}$?

5. Find the amount of each of these orders:

- | | |
|---|---|
| a. 18 articles at $66\frac{2}{3}\text{¢}$ | f. 5 articles at \$1.75 |
| b. 6 articles at $87\frac{1}{2}\text{¢}$ | g. 6 articles at \$1.08 $\frac{1}{2}$ |
| c. 12 articles at \$1.12 $\frac{1}{2}$ | h. 8 articles at \$1.62 $\frac{1}{2}$ |
| d. 6 articles at \$2.25 | i. 9 articles at \$1.33 $\frac{1}{3}$ |
| e. 30 articles at 75¢ | j. 15 articles at .83 $\frac{1}{3}\text{¢}$ |

You know that—

*To multiply by 25, you may multiply by 100 and divide by 4.
 To multiply by 75, you may multiply by 300 and divide by 4.
 To multiply by 125, you may multiply by 500 and divide by 4.
 To multiply by 175, you may multiply by 700 and divide by 4.*

*To divide by 25, divide by 100 and multiply by 4.
 To divide by 75, divide by 300 and multiply by 4.
 To divide by 125, divide by 500 and multiply by 4.*

6. See if this method saves time by using it for these exercises.

- | | | |
|-----------------------|----------------------|----------------------------|
| a. $25 \times \$2.80$ | e. $18 \times \$125$ | i. $\frac{1}{25}$ of 440 |
| b. 75×3.50 | f. $28 \times \$75$ | j. $\frac{1}{75}$ of 1250 |
| c. 125×6.40 | g. $36 \times .25$ | k. $\frac{1}{125}$ of 400 |
| d. $175 \times .23$ | h. $256 \times .25$ | l. $\frac{1}{175}$ of 1575 |

You know that—

Net price = list price minus discount.

7. Find the net price when the list price and discount are as stated here:

- | | | |
|-----------------------------------|-----------------------------------|---------------------|
| a. \$4.50 less $\frac{1}{5}$ | e. \$2.28 less 10% | i. \$ 4.75 less 20% |
| b. \$7.10 less 30% | f. \$.90 less 15% | j. \$ 5.20 less 40% |
| c. \$1.50 less 12 $\frac{1}{2}$ % | g. \$1.75 less 25% | k. \$18.00 less 15% |
| d. \$1.20 less 7 $\frac{1}{2}$ % | h. \$1.50 less 33 $\frac{1}{3}$ % | l. \$ 6.20 less 10% |

8. What is a short method of multiplying by 99, or 1.99, or 2.99?

9. What is a short method of multiplying by 98, or 1.98, or 2.98?

10. Find the products, using short methods. Do not write any more figures than is necessary. Do all that you can mentally.

<i>a.</i>	<i>b.</i>	<i>c.</i>	<i>d.</i>	<i>e.</i>	<i>f.</i>
99¢	\$2.98	\$7.50	3¢	\$1.37½	98¢
<u>12</u>	<u>7</u>	<u>25</u>	<u>541</u>	<u>8</u>	<u>30</u>
<i>g.</i>	<i>h.</i>	<i>i.</i>	<i>j.</i>	<i>k.</i>	<i>l.</i>
\$13.00	7¢	\$1.98	\$480	\$2000	98¢
<u>75</u>	<u>415</u>	<u>20</u>	<u>.25</u>	<u>.66⅔</u>	<u>8</u>

11. State the sums when you add 29 to each of these numbers:

738	376	529	272	916	829
757	959	264	403	538	495
215	467	398	747	285	904
602	683	658	946	837	328

12. State the remainders (*a*) when you subtract 19 from each of these numbers. (*b*) When you subtract 190 from each. (*c*) When you subtract 25 from each. (*d*) When you subtract 150 from each.

In adding fractions make use of facts that you know to shorten the work.

13. Name as many combinations of fractions which make 1 as you can (like $\left\{ \begin{array}{l} \frac{1}{2} \\ \frac{1}{2} \end{array} \right\}$ $\left\{ \begin{array}{l} \frac{3}{8} \\ \frac{5}{8} \end{array} \right\}$ $\left\{ \begin{array}{l} \frac{5}{12} \\ \frac{7}{12} \end{array} \right\}$ $\left\{ \begin{array}{l} \frac{7}{8} \\ \frac{1}{8} \end{array} \right\}$ $\left\{ \begin{array}{l} \frac{1}{8} \\ \frac{1}{4} \\ \frac{5}{8} \end{array} \right\}$ etc.)

14. Find the sums of each of these columns of fractions as quickly as you can:

<i>a.</i>	<i>b.</i>	<i>c.</i>	<i>d.</i>	<i>e.</i>	<i>f.</i>	<i>g.</i>	<i>h.</i>
2½	1⅛	2⅓	3¼	1⅓	3¼	2⅜	4⅜
3	1½	2¼	3	1	5	2	4⅛
2¼	1½	2¼	3¼	1¼	4½	1⅜	4
2	1⅜	2⅔	3⅛	1	6½	2	3⅝
3	2	1	3	1⅔	4¼	1⅝	3
<u>2½</u>	<u>1½</u>	<u>1½</u>	<u>3⅜</u>	<u>1¼</u>	<u>5</u>	<u>2⅛</u>	<u>3⅞</u>

6. Checking Results

1. Find 64.8% of \$87.95. Check the result in at least two ways.
2. Find exactly what percent 212 is of 480. Check your result.
3. Find the profit on 10,000 articles at \$.0625 per article. Check your result by expressing .0625 as a common fraction of a dollar.
4. The amount of business done by a firm in 1910 was \$2,869,785.00. In 1915 it was \$3,148,620.00. Find the increase. Check your result.
5. Illustrate different ways of checking results in addition.
6. Illustrate different ways of checking results in multiplication.

7. Shortening Work by Making and Using Tables

If you have to multiply many different numbers by 14, very often, it is convenient to make a table like this:

PRODUCTS OF 14 × THE NUMBERS FROM 1 TO 50									
1	14	11	154	21	294	31	434	41	574
2	28	12	168	22	308	32	448	42	588
3	42	13	...	23	...	33	...	43	...
4	56	14	...	24	...	34	...	44	...
5	70	15	...	25	...	35	...	45	...
6	84	16	...	26	...	36	...	46	...
7	...	17	...	27	...	37	...	47	...
8	...	18	...	28	...	38	...	48	...
9	...	19	...	29	...	39	...	49	...
10	...	20	...	30	...	40	...	50	...

1. Supply the products for 7×14 , 8×14 , etc., to complete this table.
2. Is it easier to find what they are by adding 14 to the last one found, or by multiplying?
3. Supply the numbers to complete this table:

PRODUCTS OF 16 × THE NUMBERS FROM 1 TO 25									
1	16	6	96	11	176	16	256	21	336
2	32	7	112	12	192	17	272	22	352
3	...	8	...	13	...	18	...	23	...
4	...	9	...	14	...	19	...	24	...
5	...	10	...	15	...	20	...	25	...

If you ever have very much multiplication or division to do, buy a big book called *Crelle's Calculating Tables*. It gives the products of every number from 1 to 1000 by every number from 1 to 1000. A part of one page has been shown on pages 246 and 247.

Examine the table on page 246 again, and see how it is used. Note especially what you do with the numbers in the last right-hand columns.

5. Use the table to find 879×3 , 879×4 , 879×13 , 879×103 , 879×105 , 879×113 , 879×213 , 879×313 .
6. Use the table to find as many of these products as you can in 5 minutes:

A.	B.	C.	D.
879×38	879×341	879×246	879×323
879×138	879×243	879×432	879×341
879×148	879×242	879×226	879×243
879×248	879×419	879×121	879×420
879×228	879×428	879×309	879×144
879×216	879×35	879×218	879×26
879×119	879×231	879×43	879×235
879×420	879×104	879×437	879×310

7. What would you do to the product of 879×417 (a) To make it the product of $879 \times \$4.17$? (b) To make it the product of $87.9 \times \$4.17$? (c) To make it 87.9% of $\$41.70$?
8. Use the table on pages 246 and 247 to find the products:

879×346	87.9% of $\$9200$	$.879 \times 436$
$879 \times 34,600$	87.9% of $\$9.20$	8.79×34.8
$87.9 \times \$3.46$	87.9% of $\$13,700$	8.79×3.48
$346 \times \$8.79$	18.9% of $\$8790$	$87,900 \times 43,900$
$48 \times \$87.90$	472×879	$258 \times 87,900$
9. Think how to use the table to find what number to multiply 879 by to have 752,583 as the product. To find what number to multiply 879 by to have 300,495 as the product.
10. Find what number you multiply by 879 (a) To have 101,361 as product. (b) To have 377,637 as product. (c) To have 560,625 as product.

8. Practical Computations

1. Find the cost of materials for each of these meals at the prices given in the table. Do not extend decimals beyond hundredths of a cent.

Meal A	Meal B	Prices
1 oz. corn flakes	10 dates	apple pie, 20¢ each
2 eggs	4 oz. bacon	bacon, 26¢ per lb.
1 oz. butter	4 oz. baked potatoes	bread, 12 oz. for 5¢
$\frac{1}{2}$ pt. milk	2 oz. bread	butter, 30¢ per lb.
	1 oz. sugar	cheese, 24¢ per lb.
	1 gill milk	corn flakes, 12 oz. for 10¢
		dates, pkg. of 45 for 10¢
		eggs, 32¢ per doz.
Meal C	Meal D	Hamburg steak, 22¢ per lb.
4 oz. cheese	4 oz. Hamburg steak	milk, 8¢ per qt.
6 oz. bread	8 oz. baked potatoes	potatoes, 60 lb. for \$1.00
1 pt. milk	2 oz. bread	sugar, 7 lb. for 50¢
	$\frac{1}{6}$ apple pie	

- How much more will it cost for Meal A if eggs are 40¢ per doz. instead of 32¢?
- How much less will it cost for Meal B if bacon is 22¢ per lb. instead of 26¢?
- How much less will it cost for Meal C if cheese is 20¢ per lb. instead of 24¢?
- How much more will it cost for Meal D if potatoes are 60 lb. for \$1.50 instead of \$1.00?
- How much will Breakfast B weigh, counting that the dates average $\frac{1}{6}$ oz. and calling a pint of milk a pound? How much will Breakfast A weigh counting each egg as 2 oz.?
- Using the prices in the table, supply the missing numbers (count that 1 pt. milk weighs 1 lb., and that 8 eggs weigh 1 lb.):
 - Butter costs . . . times as much per pound as milk.
 - Eggs cost . . . times as much per pound as potatoes.
 - Butter costs . . . times as much per pound as sugar.
 - Corn flakes cost .. times as much per pound as bread.
 - Eggs cost . . . times as much per pound as milk.
 - Eggs cost . . . times as much per pound as bread.

Here is the summary of the Drake family expenditures. Find the total for each column.

	Food	Rent and Carfare	Clothing	Gas	Fuel	Labor	Laundry	Furnishings	Doctor and Health, Dentist	Incidentals	Higher Life	Insurance
Jan.	46.50	23.10	4.25	2.20		5.00	1.05	7.05		2.08	3.00	
Feb.	42.10	22.45	9.65	2.09		3.75	1.10		9.00	3.14	3.00	
Mar.	40.60	23.20	7.30	1.97	6.50	5.00	1.05	1.30		1.62	3.90	
Apr.	41.37	23.35	47.20	1.62		6.25	.95			2.05	8.00	
May	48.04	23.45	3.25	1.44		5.00	1.30	2.60	8.00	3.22	3.75	41.80
June	37.90	24.05	4.89	1.30	6.50	6.25	1.05	2.18		1.04	4.15	
July	40.05	23.70	5.06	1.23		5.00	1.10			.68	6.50	
Aug.	41.20	21.95	4.05	1.41	52.00	2.50	1.20	11.40		1.17	5.25	
Sept.	41.19	23.15	68.50	1.62		3.75	1.25			3.06	5.75	
Oct.	42.38	24.05		1.85		6.25	1.20	5.18		1.94	3.00	
Nov.	43.25	23.65	35.10	1.97		5.00	1.10			2.92	18.20	
Dec.	42.18	23.70	20.50	2.10	6.50	5.00	1.05	1.25		1.16	11.20	

8. How much did they spend on the average per month for each item of those listed?
 9. Mr. Drake earned \$1380 that year. They received \$4.50 per week for room and board from his nephew, and \$71.25 from the children, who earned the money for their clothes. How much more did they receive than they spent?
 10. What percent of their total expenditures went (a) For food? (b) For rent and carfare? (c) For all operating expenses?
 11. How much can they save per year by reducing the cost for food 10%, and the cost for labor 50%?
 12. The N. R. Company pays its workers as follows:
 - For making article 13a, 8½¢ per dozen*
 - For making article 13e, 4⅝¢ per dozen*
 - For making article 17b, 2⅛¢ per dozen*
 - For making article 21c, 13¼¢ per dozen*
 - For making article 26a, 17¢ per dozen*
- How much is paid for each of these jobs?
- a. 14 doz. of 13a.
 - b. 10½ doz. of 13a.
 - c. 26 doz. of 13e.
 - d. 8½ doz. of 13e.
 - e. 9 doz. of 17b.
 - f. 23 doz. of 17b.
 - g. 16 doz. of 21c.
 - h. 9½ doz. of 21c.
 - i. 11½ doz. of 26a.
 - j. 3⅓ doz. of 26a.
 - k. 7⅔ doz. of 26a.
 - l. 12 doz. of 21c.

9. Exactness in Measurements

- Take three pieces of paper, each 2 inches long.
Mark one to show twenty-fifths of an inch ($\frac{1}{25}$ s).
Mark one to show tenths of an inch ($\frac{1}{10}$ s).
Mark one to show thirty-seconds of an inch ($\frac{1}{32}$ s).

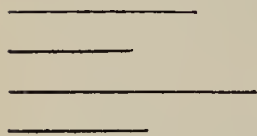

- First estimate the length of each of these lines in $\frac{1}{32}$ s of an inch; then measure the line and see how near you estimated.

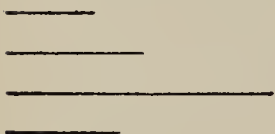

- Estimate the length of each of these lines in $\frac{1}{25}$ s of an inch, then measure it.

- Which of these lines do you think is longer? Measure the lines.



- Estimate the circumference of each of these circles as a decimal number of inches or a decimal fraction of an inch. Then measure the diameter to the nearest twenty-fifth of an inch, compute the circumference as $\pi \times \text{diam.}$, and see how near your estimates were.

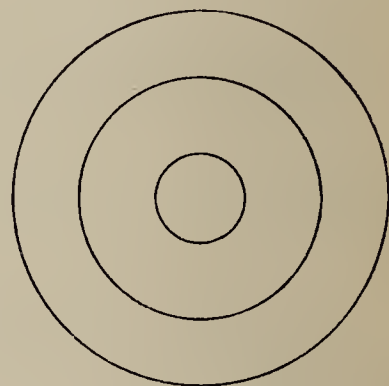

- 1 centimeter (cm.) = .3937 in. How near is that to $\frac{8}{20}$ in.?
- How large will be your error if you take 10 cm. to be $3\frac{19}{20}$ in.?
- 10 millimeters = 1 cm. What is the exact diameter in inches of a 75-millimeter gun?

10. Shop Measurements

Figures of exactly the same shape are called similar figures.

The lengths of corresponding lines in similar figures are proportional.

- OAB and OCD are of exactly the same shape. How long is CD ?

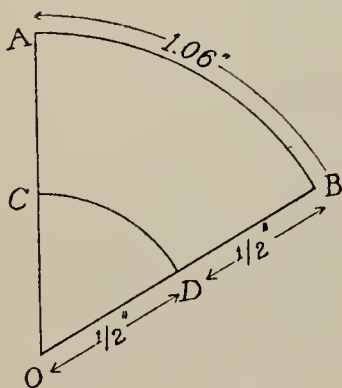

2. The smallest circle has a diameter of .27 in. (a) Find its circumference by using $\pi \times \text{diam.}$ (b) Use an easier way to find the circumference of the other circles.
3. $M_1N_1P_1Q_1$ and $MNPQ$ are of exactly the same shape. (a) Find the length of MP by $\sqrt{(MN)^2 + (NP)^2}$. (b) Use an easier way to find the length of M_1P_1 .

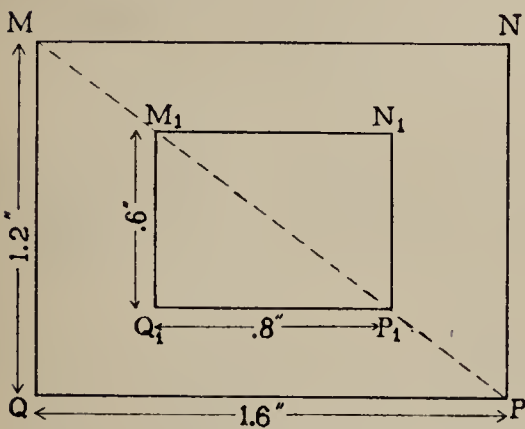
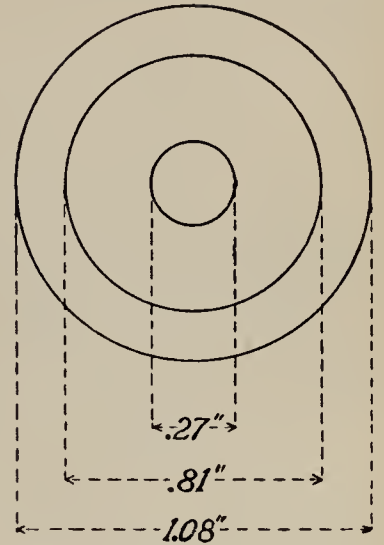

4. In drawing an angle to equal AOB on p. 260, a boy made a mistake so that two lines at a distance of 1 inch from the vertex O were .027 in. farther apart than they ought to be. (a) How much too far apart will his lines be at a distance of 4 in. from the vertex?

(b) At a distance of 10 in. from the vertex?

5. John tried to draw a line CP perpendicular to CA . At a distance of 1 inch from C , his line was .016 in. distant from the true perpendicular. How far from the true perpendicular would his line be if drawn straight on for 18 in.?
6. How much too big will the area of a square be if you make the lines 1% too long (a) When you are trying to draw a square to contain 9 sq. in.? (b) When you are trying to draw a square to contain 100 sq. in.?
7. How much too big will the area of a circle be if you make a radius 2% too long, when you are trying to draw a circle with a radius (a) Of $4\frac{1}{2}$ in.? (b) Of 7 in.? (c) Of 1 ft.?
8. How much too small will the volume of a cube be if you make each edge 3.9 inches long instead of 4.0 inches?

11. Shop Calculations

Cups to hold the balls of ball-bearings are made in the following sizes:

Size A, $\frac{4\frac{5}{4}}{6}$ in.	Size D, $\frac{5\frac{5}{4}}{6}$ in.	Size G, $1\frac{3}{32}$ in.
Size B, $\frac{3}{4}$ in.	Size E, $\frac{7}{8}$ in.	Size H, $1\frac{1}{8}$ in.
Size C, $\frac{1\frac{3}{8}}{16}$ in.	Size F, $\frac{2\frac{9}{2}}{32}$ in.	Size I, $1\frac{9}{64}$ in.

- How much larger is B than A? 2. C than B? 3. D than C?
- E than D? 5. F than E? 6. G than F? 7. H than G?
- I than H?
- Express each of these sizes in millimeters (1 inch = 25.4 mm.)

This table tells how much cement, sand, and gravel is required to make 1 cu. yd. of solid concrete, when you mix them in the proportions 1:2:3; when you mix them in the proportions 1:2:4; and when you mix them in the proportions 1:3:5. (*bbbl.* means *barrel* or *barrels.*)

For a 1:2:3 mixture use 1.74 bbl. cement, .52 cu. yd. sand, .78 cu. yd. gravel.

For a 1:2:4 mixture use 1.51 bbl. cement, .45 cu. yd. sand, .89 cu. yd. gravel.

For a 1:3:5 mixture use 1.16 bbl. cement, .52 cu. yd. sand, .86 cu. yd. gravel.

How much of each is required—

- For a job of making 2.5 cu. yd. of a 1:2:4 mixture?
- For a job of making 260 cu. yd. of a 1:3:5 mixture?
- For a job of making 118 cu. yd. of a 1:2:3 mixture?
- How many times as much cement is required to make a cubic yard of a 1:2:3 mixture as of a 1:3:5 mixture?
- Explain why just as much sand is required to make a cu. yd. of 1:3:5 as to make a cu. yd. of 1:2:3 mixture.
- How can it be that 1 bbl. + .52 cu. yd. + .77 cu. yd. of material (plus water too) added together gives only 1 cu. yd. of concrete?
- Counting a barrel as .47 cu. yd., how much more space do the dry materials for a cubic yard of 1:2:3 concrete occupy when separate than when made into concrete?
- At 22¢ per hour, how much is earned in $7\frac{1}{2}$ hr.? In $8\frac{3}{4}$ hr.?
- At $23\frac{1}{2}$ ¢ per hour, how much is earned in $7\frac{3}{4}$ hr.? In $8\frac{1}{4}$ hr.?
- At $28\frac{3}{4}$ ¢ per hour, how much is earned in $8\frac{1}{2}$ hr.? In 9 hr.?
- At 31¢ per hour, how much is earned in $7\frac{3}{4}$ hr.? In $8\frac{1}{2}$ hr.?

1. How many teeth are there on Gear A? On the idler? On Gear B? Record the numbers to use in Ex. 2, 3, and 7.
2. When Gear A makes one complete revolution, how many times will the idler revolve—2 or $2\frac{1}{2}$ or 3?
3. When the idler makes one complete revolution how many times will Gear B revolve—one time or $1\frac{1}{2}$ times or $1\frac{3}{5}$ times or $1\frac{3}{4}$ times?

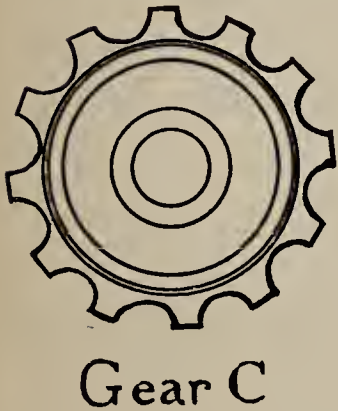
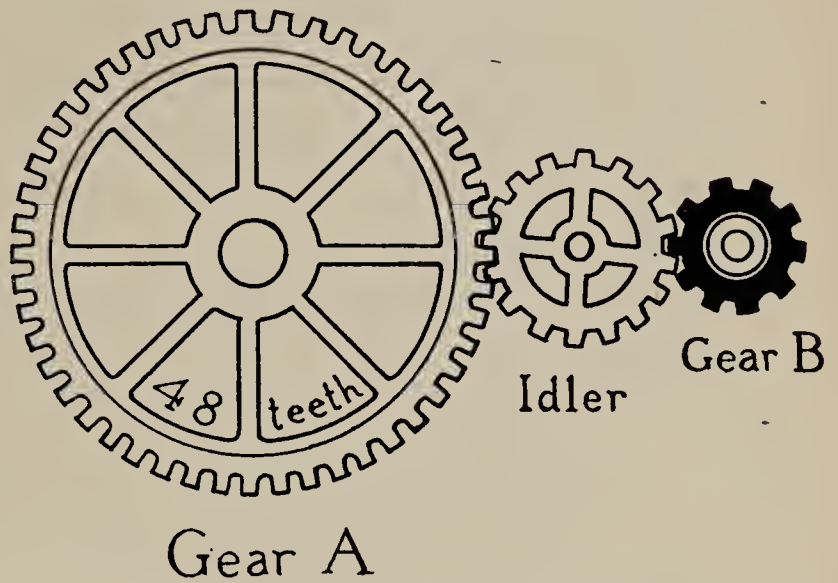

4. Gear C has 12 teeth. How many teeth must a gear have that fits into Gear C and revolves once while Gear C revolves 8 times?
5. How many times does the rear wheel of this bicycle revolve for each complete revolution of its sprocket wheel?

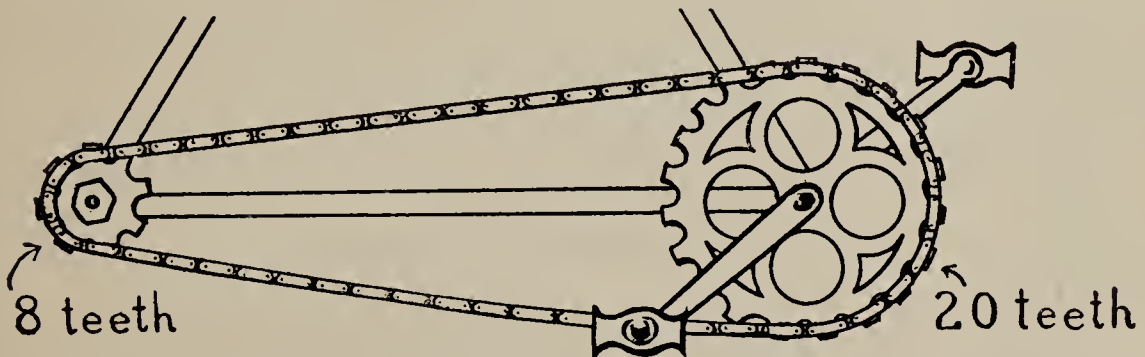

6. If the rear wheel is 28 in. in diameter, how far does the bicycle go for each revolution of its sprocket wheel?
7. If Gear A in the picture at the top of the page makes 100 R.P.M. (revolutions per minute), how many R.P.M. does Gear B make?

13. Shop Equations

1. Make an equation to use in finding the rim speed of a grindstone when you know its diameter.
2. Use the equation to find:
 - a. The rim speed of a grindstone 18 in. in diam. at 80 R.P.M.
 - b. The rim speed of a grindstone 1 ft. in diam. at 400 R.P.M.
 - c. The rim speed of an emery wheel 6 in. in diam. at 1750 R.P.M.

A grindstone for carpenters' tools should be turned at a rim speed of 600 feet per minute.

A grindstone for machinists' tools should be turned at a rim speed of 1000 feet per minute.

3. Which gives more nearly the right speed for a grindstone 16 in. in diameter to sharpen carpenters' tools, 150 R.P.M. or 160 R.P.M.?
4. Which gives nearest the right speed for a 16-inch grindstone for machinists' tools, 240 R.P.M. or 250 R.P.M.?
5. How many revolutions can an emery wheel 15 in. in diameter make per minute without having its rim speed exceed the safe limit of 5500 ft. per min.?

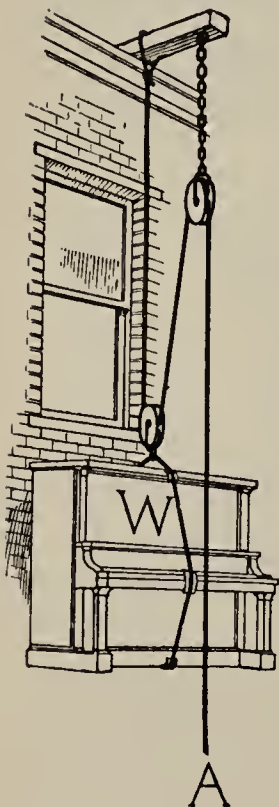

Force and Distance

6. If a man pulls rope *A* down 6 ft. how far up will the weight *W* go?
7. How far up will the weight go (a) If *A* is pulled down 20 ft.? (b) If *A* is pulled down 14 ft.?
8. How far down must rope *A* be pulled (a) To hoist weight *W* up 6 ft.? (b) To hoist it 8 ft.?
9. Neglecting friction, how far must a force of 100 lb. act (a) To raise a weight of 500 lb. 2 ft.? (b) To raise 500 lb. $3\frac{1}{2}$ ft.? (c) To raise 400 lb. 4 ft.?
10. Through what distance must a force of 150 lb. act to raise a weight of 750 lb. 3 ft.?

- | | Weight in Pounds
of 1 cu. ft. of |
|---|-------------------------------------|
| 1. Examine this table. Which substances are heavier than lead? Which is lighter than air? Which would be best for filling a balloon? | Gold 1204 |
| | Mercury 849 |
| 2. Which substance weighs about 9 times as much as water? | Lead 711 |
| | Copper 557 |
| 3. Which weighs about $1\frac{5}{7}$ times as much as lead? | Water 62.4 |
| | Ice 56.8 |
| 4. Which weighs about .9 as much as water? | Gasoline 43.7 |
| | Cork 15.6 |
| 5. Air has weight. A tank containing 12 cu. ft. weighs about 1 lb. less if all the air is pumped out of it than it does with the air in it. About how many pounds does the air in a tank containing 24 cubic feet weigh? | Air .081 |
| | Hydrogen .00563 |
| 6. Which substance weighs about 750 times as much as air? | |
| 7. How many cubic feet of air will it take to weigh as much as 1 cu. ft. of water? | |
| 8. Water is how many times as heavy as cork? | |
| 9. Lead is how many times as heavy as water? | |
| 10. A balloon contains 80 cu. ft. of air and 170 cu. ft. of hydrogen gas. How much does the mixture weigh? How much does the mixture weigh per cu. ft.? | |
| 11. Out of oiled silk and canvas weighing $2\frac{3}{4}$ lb. a hollow life-preserver is made. It contains $\frac{7}{8}$ of a cu. ft. of air and fills 1 cu. ft. of space. How much does the life preserver weigh with the air in it? How much less does it weigh than 1 cu. ft. of water? | |
| 12. The glass in a bottle weighs 1.14 lb., its cork weighs .003 lb. It contains 40 cu. in. of air. How much less does it weigh than 44 cu. in. of water? | |
| 13. How much does the air in a chimney one foot square and 40 ft. tall weigh? | |
| 14. How many cubic feet of hydrogen will weigh as much as one cubic foot of air? | |

15. Wages

1. Examine this table of actual average yearly earnings of skilled workmen in 9 American cities in 1913.

Cities	Bricklayers	Carpenters	Machinists	Painters	Plasterers	Plumbers
San Francisco, Cal.	\$1390	\$ 964	\$ 944	\$1081	\$1309	\$1540
Denver, Colo.	1053	960	1023	779	1082	1054
Chicago, Ill.	1293	1139	884	1232	1326	1394
Kansas City, Kan.	1247	930	956	1066	1331	1373
Baltimore, Md.	1057	908	824	767	1161	1101
Boston, Mass.	1244	1026	1074	957	1201	1320
Minneapolis, Minn.	1197	1030	958	921	1201	1044
New York, N. Y.	1078	1076	934	833	1142	1245
Cleveland, Ohio	1192	992	875	1003	1132	1219

2. Which trade is the best paid on the average?
3. Which trade is the next best paid on the average?
4. Was it necessary to add every column to answer Ex. 2 and Ex. 3 correctly?
5. Examine the table and estimate (a) in which city the average of the six amounts is highest, and (b) in which city it is lowest. Then add and see if your estimates were correct.
6. Find the average for the six amounts in Baltimore and find what percent it is of the average yearly salary of a woman teacher in the elementary school (which is \$692 in Baltimore).
7. Counting that the average number of days worked by a bricklayer in San Francisco was 280, find his average daily earnings when at work.
8. Chicago pays its women teachers in the elementary school \$1034 per year on the average. Would an increase of 40% in the Baltimore salaries for women teachers make them as high as those in Chicago?
9. What percent increase would be necessary to make the Baltimore women's salaries equal to those in Chicago?
10. What percent of \$908 must be added to \$908 to make \$1076, the New York carpenter's earnings?
11. What percent increase is necessary to make the average earnings of a plumber in Boston equal \$1540, the average for San Francisco?

In estimating the number of shingles required carpenters use this table:

	Shingles Needed per 100 Sq. Ft. of Roof
Shingles laid 4 inches to the weather	1000
Shingles laid $4\frac{1}{4}$ inches to the weather	910
Shingles laid $4\frac{1}{2}$ inches to the weather	833
Shingles laid 5 inches to the weather	752

1. According to this table, how many thousand shingles are needed for each of these roofs: (a) If laid 4 in. to the weather? (b) If laid $4\frac{1}{4}$ in. to the weather? (c) If laid $4\frac{1}{2}$ in. to the weather?

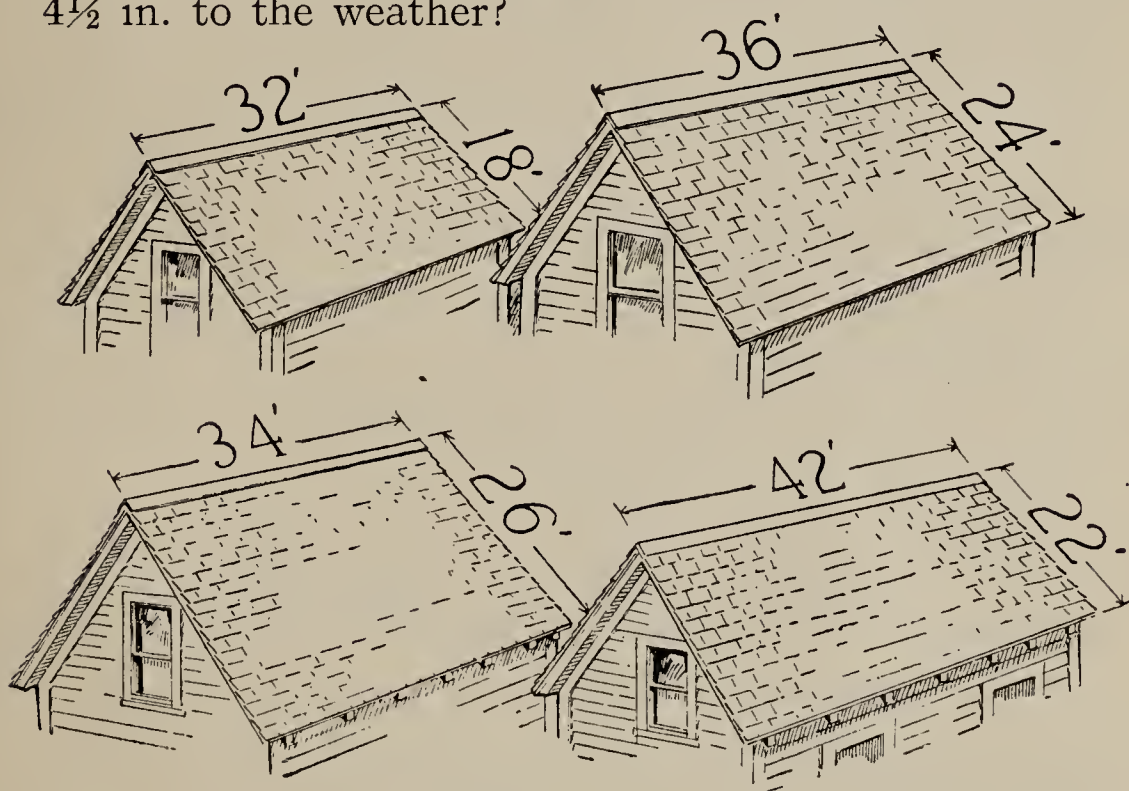

2. Mr. S. adds 8% to the estimate for a job of shingling 7600 sq. ft. because of special work. How many thousand shingles does he buy?

The weight of a cubic ft. of water is 62.4 lb.

3. What is the weight of a column of water of 1 sq. in. base, 1 ft. high?
4. What is the weight of the water in a pipe 100 ft. long full of water if the cross-section of the pipe is $3\frac{1}{4}$ sq. in. in area?
5. What is the weight of the water in 120 ft. of pipe of inside diameter $1\frac{1}{2}$ in.?

Review (continued)

Cast iron is 7.2 times as heavy as water.

Wrought iron is 7.7 times as heavy as water.

Steel is 7.8 times as heavy as water.

6. Find the weight of 1 cu. ft. of each.
7. Find the weight of 1 cu. in. of each.
8. A piece of a machine can be made of $16\frac{1}{2}$ lb. cast iron, costing $2\frac{5}{8}\text{¢}$ per lb., or of $8\frac{3}{4}$ lb. steel costing $6\frac{1}{8}\text{¢}$ per lb. What will be the cost for materials in each case?
9. There are 60 ft. of $\frac{1}{4}$ -in. manila rope to a pound. How many feet would be sold for a dollar at 27¢ per lb.?
10. You can buy $\frac{5}{16}$ -in. rope for 26¢ per lb. There are 45 ft. to a pound. How many feet of $\frac{5}{16}$ -in. rope would be sold for a dollar at this rate?
11. Arthur bought a set of drills. The sizes ran like this: $\frac{1}{16}$ in., $\frac{5}{64}$ in., $\frac{3}{32}$ in., $\frac{7}{64}$ in., $\frac{1}{8}$ in., etc. Write the sizes of the next eight of the drills.
12. What will 10 8-ft. bars of cold rolled steel, weighing 4.16 lb. per foot, cost at $5\frac{1}{2}\text{¢}$ per lb.?
13. How many square feet of flooring should be bought for this floor, allowing 12% extra for waste in cutting?
14. What is the cost per sq. yd. for a sidewalk 30 ft. long and 3 ft. wide, for which you use $2\frac{1}{2}$ bbl. cement at \$1.50 per bbl., $1\frac{1}{4}$ cu. yd. stone at \$1.50 per cu. yd., 1 cu. yd. sand at \$1.00, $2\frac{3}{4}$ cu. yd. cinders at 60¢ , and 12 hr. labor at 25¢ per hr.?
15. Supply the missing numbers in these series. Study each series until you understand it.
 - a. 1 2 3 4 ... 6 7 8 ... 10
 - b. 1 4 9 ... 25 ... 49 100
 - c. 1 8 27 64 ... 216 ... 512 729
 - d. $\frac{1}{3}$ $\frac{2}{3}$ 1 $1\frac{1}{3}$... 2 $3\frac{1}{3}$
 - e. 20 24 28 ... 36 40 52 ...

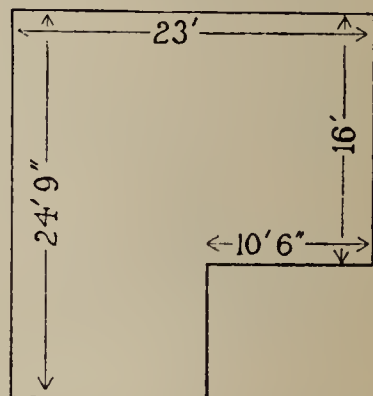

SPACE TO ALLOW PER TREE OR PLANT IN PLANTING

Apples	35 ft. × 35 ft.	Currants	4 ft. × 4 ft.
Sour cherries	15 ft. × 15 ft.	Raspberries	4 ft. × 3 ft.
Sweet cherries	20 ft. × 20 ft.	Strawberries	4 ft. × 1 ft.
Grapes	8 ft. × 8 ft.	Asparagus	3 ft. × 1 ft.

1 acre = 43,560 sq. ft.

Suppose that you allow space as stated in the table above.

1. For an orchard of $2\frac{1}{4}$ acres, how many apple trees are needed?
2. How many sour cherry trees? 3. How many sweet cherry trees?
4. How many grape vines? 5. How many currant bushes?
6. How many raspberry bushes are needed for a quarter of an acre?
7. How many strawberry plants? 8. How many asparagus roots?
9. How much space is needed for 100 raspberries, 100 currants, and 200 strawberry plants?

	APPLE TREES		
	Each	10	100
XXX size; 5 to 7 ft.	\$0.30	\$2.50	\$17.50
XX size; $4\frac{1}{2}$ to 6 ft.	.25	2.00	14.00
X size; 4 to 5 ft.	.20	1.50	10.00

Quantities of 50 or over are sold at the 100 rate.

10. At these prices, what is the cost for 75 XX trees and 50 X trees?
11. How much do you save by buying 50 XXX trees all at once instead of in 5 lots of 10?
12. What would be the price per 100 of XXX trees if they were sold at the rate of 10 less 25%?

The average crops for berries in this country are:

Strawberries, 1745 qt. per acre	Cranberries, 1814 qt. per acre
Blackberries, 1184 qt. per acre	Currants, 1386 qt. per acre
Raspberries, 1255 qt. per acre	Gooseberries, 1245 qt. per acre

13. How much is an average strawberry crop worth at $5\frac{3}{4}$ ¢ per qt.?
14. How much is an average cranberry crop worth at 8.06¢ per qt.?

18. Field Crops

1. Mr. K. has a 40-acre corn field. He uses 10 bushels of seed corn to sow it. (a) How much is that per acre? (b) What is the cost per acre at \$1.50 per bushel? (c) He uses 3 tons of fertilizer for this field. How many pounds does he use per acre?
2. Mr. K. tested three lots of seed corn, using 250 kernels of each sort. 60 kernels of variety A were bad, 36 kernels of variety B were bad, 20 kernels of variety C were bad. What percent of variety A was good? Of variety B? Of variety C?
3. 56 lb. of shelled corn is commonly counted as a bushel. What is the price per pound at 63¢ per bushel?

COSTS PER ACRE

	Potatoes	Oats
Rent of land	\$ 4.42	\$ 4.09
Cost of man, horse, equipment, and labor	42.19	11.15
Other costs	22.00	6.28

4. (a) What percent of the total cost of growing the crop is the rent of the land in the case of potatoes? (b) In the case of oats?
5. If a farmer could grow twice as many potatoes per acre by spending \$80 more per acre for labor, fertilizer, etc., would it pay him to do so; or would it be cheaper for him to plant twice as many acres of potatoes?
6. The production of corn in the United States increased from 600 million bushels in 1850 to 2100 million bushels in 1900. If it should increase in the same ratio from 1900 to 1950, what would be the size of the crop in 1950?
7. The food value of the crops raised per acre is 1458 in Iowa, and 1191 in Bavaria. The food value of the crops raised per person working is 86,777 in Iowa and 21,231 in Bavaria. (a) How many times as much is raised per acre in Iowa as in Bavaria? (b) How many times as much is raised per person working? (Find results to the first decimal place only.)

1. An acre of corn producing 50 bushels uses up 1,500,000 lb. water.
An acre of potatoes producing 200 bushels uses up 1,268,000 lb. water.
How much water is used up (a) Per bushel of corn? (b) Per bushel of potatoes?
2. The valuable elements of fertilizers are nitrogen, phosphoric acid, and potash. Nitrogen costs about 15¢ per lb.; phosphoric acid and potash cost about 5¢ per lb. The D.C.T. fertilizer contains 3.3% nitrogen, 8% phosphoric acid, and 7% potash. It costs \$38 per ton. (a) How many pounds of each does a farmer get when he buys a ton of D.C.T. fertilizer? (b) How much would he save by buying the three valuable elements instead of the whole ton of fertilizer?
3. What is the value of a ton of fertilizer containing 1.6% nitrogen, 7% phosphoric acid available, and 2% potash?

Different crops need different mixtures of fertilizers. These mixtures of P, N₁, N₂, and K are recommended for corn and cotton. P is a fertilizer containing phosphoric acid. N₁ and N₂ are two different fertilizers containing nitrogen. K is a fertilizer containing potash.

*For Corn: I. P, N₁, and K, in these proportions: 11, 12, and 2.
or II. P, N₂, and K, in these proportions: 4, 3, and 1.*

For Cotton: III. P, N₁, and K, in these proportions: 9, 8, and 3.

4. Find what you would buy to make a ton of each of the mixtures.

Record your results in a table like this:

	For a ton of Mixture No. I you would buy	For a ton of Mixture No. II you would buy	For a ton of Mixture No. III you would buy
P lb. lb. lb.
N ₁ lb. lb. lb.
N ₂ lb. lb. lb.
K lb. lb. lb.

State the missing numbers:

1. If you toss a penny, the chances are . . . out of 2 that it will fall heads.
2. If you open a book at random the chances are 2 out of . . . that the number of the page will end in 1 or 3.
3. The chances are . . . out of 7 that Christmas will come on Monday.
4. In a certain place 20 percent of July days are rainy. What are the chances that it will rain there on July 11 of this year?

In an experiment it was found that—

77 out of 100 wheat seeds 3 years old would grow.

37 out of 100 wheat seeds 4 years old would grow.

15 out of 100 wheat seeds 5 years old would grow.

6 out of 100 wheat seeds 6 years old would grow.

5. If you plant a grain of wheat 3 years old the chances are about . . . out of 4 that it will grow. The chances are about 1 out of . . . that it will *not* grow.
6. If you plant a grain of wheat 4 years old, the chances are about . . . out of 3 that it will *not* grow.
7. If you plant a grain of wheat 5 years old, the chances are about 6 out of . . . that it will not grow.

21. Mixtures to Protect Trees and Plants

1. Bordeaux mixture is made of 4 lb. copper sulphate and 4 lb. quicklime to 50 gal. water. What quantities of quicklime and water would you use with $\frac{1}{2}$ lb. copper sulphate?
2. Lime sulphur preparation is made of 20 lb. quicklime and 15 lb. sulphur to 50 gal. water. What quantities of quicklime and sulphur would you use with 10 gal. of water?
3. Kerosene emulsion is made of soap solution, kerosene, and water in the proportions 1, 2, and 9. The soap solution is made by dissolving $\frac{1}{2}$ lb. soap in 1 gal. of boiling water. How much soap and how much kerosene are required to make 24 gal. of the mixture?

1. Before modern farm machinery was invented, it required 38 hr. 45 min. of human labor to grow and harvest 40 bushels of corn, 21 hr. 5 min. to harvest 1 ton of hay, and 61 hr. to grow and harvest 20 bushels of wheat. Now, with the aid of machinery, 15 hr. 8 min. are required for the corn, 3 hr. 56 min. for the hay, and 3 hr. 19 min. for the wheat. (a) How many times as much human labor was required for corn before the invention of farm machinery as is required now? (b) For hay? (c) For wheat? (Express the quantities as decimal numbers of hours before dividing.)

2. Find the missing percents:

	Cost per Acre with Hand Tools	Cost per Acre with Modern Machinery	Percent Which Cost with Machinery is of Cost with Hand Tools
Barley	\$ 3.88	\$1.06
Wheat	4.00	1.12
Hay	1.92	.63
Corn	16.34	6.62
Potatoes	13.18	5.97

3. It is estimated that without machinery it would cost 1.87 times as much to produce the farm crops of the United States, as it costs now when farm machinery is used. If the cost for next year with machinery is 775 million dollars, what would it be without machinery?

4. 1500 lb. of cotton as it is picked yields 500 lb. of lint cotton, 150 lb. of cotton-seed oil, 337 lb. of cotton-seed meal, 500 lb. of hulls, and 13 lb. of lintners. (a) What is the value of the 1500 lb. of cotton, if the lint cotton is worth $11\frac{5}{8}\text{¢}$ per lb.; the oil $5\frac{3}{8}\text{¢}$ per lb.; the meal $1\frac{1}{3}\text{¢}$ per lb.; the hulls $\frac{2}{5}\text{¢}$ per lb.; and the lintners $3\frac{1}{4}\text{¢}$ per lb.? (b) What percent of the total value is the value of the lint cotton itself?

5. Before the invention of the cotton gin, the seeds were picked out by hand, and it took a good worker 48 hours to gin 15 lb. of seed cotton producing 5 lb. of lint cotton. Counting 8 hrs. as a day's labor, how many days would it require 100 men to gin 4 tons of seed cotton?

1. Find the missing numbers:

A. Farmers on farms worth under \$5000 receive on the average for their own labor \$290 per year. Farmers on farms worth \$5000 to \$10,000 receive for their labor 53% more than that or...per year. Farmers on farms worth \$10,000 to \$15,000 receive for their labor \$770 per year or ...% of \$290. Farmers on farms worth \$15,000 to \$20,000 receive \$1000 per year or...times as much as farmers on farms worth less than \$5000.

B. Farmers on farms raising 140 acres or over of crops make an average income of \$1260. Farmers on farms raising 81 to 100 acres of crops make an average income of \$640 or ... as much. Farmers raising from 21 to 40 acres of crops make an average income of \$250 or only...percent of \$1260.

2. A man had \$9000 from which he received 5% income each year. He earned \$1200 per year in business. How much did he have per year in all?

3. In 1916 this man bought a farm with the \$9000. As a farmer he pays the expenses of running the farm and has \$1150 per year in addition. His family also has the use of the farmhouse which is worth \$15 a month, and potatoes, milk, and eggs worth on the average \$3 a week. Compare the family income before and after the man changed from business to farming.

4. An amateur farmer built a set of barns to house 30 cows. They cost \$28,000. Counting the interest at 5%, taxes at 1½%, repairs at 2%, and depreciation at 1%, (a) What was the cost per year for the home for the 30 cows? (b) What was the cost per year per cow? A good cow earns \$25 a year for her owner, over the cost of her feed and care. (c) What percent of her room rent in this barn could a good cow earn?

5. What will be the cost per year for insurance for four barns for \$1500 each, at the rate of 25¢ per \$100 for three years?

Examine this table. Think of an animal as an engine that does work and produces milk or meat. The food the animal eats is like the coal and oil and new parts used to repair the engine. This table tells how much real food an animal receives from each sort of material in the list. Proteid or protein is the kind of food substance that makes muscle. Carbohydrate is the kind of food substance that is in potatoes, sugar, or cornstarch.

NUMBER OF POUNDS OF DIGESTIBLE FOODSTUFFS IN 100 POUNDS

	Proteid or Protein	Carbohydrate	Fat
Alfalfa hay	11.0	39.6	1.2
Corn	7.9	66.7	4.3
Corn ensilage	0.9	11.3	0.7
Corn stover	1.7	32.4	0.7
Cotton-seed meal	37.2	16.9	12.2
Cow peas	18.3	54.2	1.1
Cow-pea hay	10.8	38.6	1.1
Gluten meal	25.8	43.4	11.0
Linseed meal (new)	28.2	40.1	2.8
Oats	9.2	47.3	4.2
Red clover hay	6.8	35.8	1.7
Skimmed milk	3.1	4.7	0.8
Soya beans	29.6	22.3	14.4
Timothy hay	2.8	43.4	1.4
Wheat bran	12.2	39.2	2.7
Wheat middlings	12.8	53.0	3.4

1. A growing calf weighing 300 lb. needs 1 lb. digestible proteid per day. Would he obtain it from a ration of 20 lb. of timothy hay and 10 lb. skimmed milk?
2. A working horse that weighs 1500 lb. needs 17.7 units of a mixture of digestible carbohydrates and fats. In this *c.f.* mixture you count each pound of carbohydrate as 1 unit and each pound of fat as $2\frac{1}{4}$ units. Will the horse obtain what he needs from 12 qt. oats (counting 1 bu. of oats as 32 lb.) per day?
3. If you feed him the 12 qt. of oats plus 25 lb. timothy hay, how many units of the *c.f.* mixture does he obtain?
4. He needs also 2.7 lb. digestible protein per day. Will he obtain that from the 12 qt. oats and 25 lb. hay?

5. How much protein, how much carbohydrate, and how much fat will a horse obtain from 2 lb. gluten meal, 6 lb. corn, 8 lb. oats, 10 lb. red clover hay, and 15 lb. timothy hay?

(The number of pounds of carbohydrate) + (2¼ times the number of pounds of fat) in 100 lb. of a food may be called the **c.f. value**.

6. What is the *c.f. value* (a) For alfalfa? (b) For red clover hay? (c) For timothy hay? (d) For corn ensilage? (e) For corn stover?
7. A cow requires per day 2.3 lb. proteid and 14.9 lb. of *c.f. value* for every 1000 lb. of its weight. What is the requirement (a) For a cow weighing 725 lb.? (b) For a cow weighing 950 lb.?

Nutritive Ratios

The ratio of the number of pounds of *c.f. value* to the number of pounds of proteid in 100 lb. of a food is called the **nutritive ratio** of that food.

$$\text{Nutritive ratio} = \frac{\text{lb. of } c.f. \text{ value}}{\text{lb. of proteid}} \quad \text{or } N = \frac{c.f.}{p}$$

$$c.f. = \text{carbohydrate} + 2\frac{1}{4} \text{ fat.}$$

It is important to give an animal food of the right nutritive ratio.

8. What is the nutritive ratio of clover hay which contains 7.4% of digestible protein, 38% of digestible carbohydrates, and 1.9% of digestible fat?
9. What is the nutritive ratio of each of the first five foods of the table on page 275?
10. Which of the five is nearest to the correct ratio for a milch cow, which is 6?
11. Which of the five has far too much protein in proportion to the carbohydrates and fat?
12. Which of the five has far too much carbohydrates and fats in proportion to the protein?

In any equation what is on the left side of the equality sign is called the first *member* or *side* of the equation. What is on the right side of the equality sign is called the second *member* or *side*.

Any true equation will still be true if you add the same quantity to both sides or subtract the same quantity from both sides or multiply both sides by the same number or divide both sides by the same number.

1. Suppose the equation is $x - 3.37 \text{ in.} = 36 \text{ in.}$ and that you add 3.37 in. to each side, giving
 $x - 3.37 \text{ in.} + 3.37 \text{ in.} = 36 \text{ in.} + 3.37 \text{ in.}$
 or $x = 36 \text{ in.} + 3.37 \text{ in.}$

Substitute the value of 1 meter for x and show that the upper equation is true and the lower equation also.

2. Suppose the equation is $x + 3\frac{1}{2} \text{ ft.} = 20 \text{ ft.}$ and that you subtract $3\frac{1}{2} \text{ ft.}$ from each side, giving $x = 20 \text{ ft.} - 3\frac{1}{2} \text{ ft.}$ Let x be the value of 1 rod. Prove that both equations are true.
3. Suppose the equation is $\text{Area of triangle } ABC = \frac{1}{2} \text{ alt.} \times \text{base.}$ Multiply both sides by 2, giving $2 (\text{area of triangle } ABC) = \text{alt.} \times \text{base.}$

Substitute 30 for area of triangle ABC .

Substitute 6 for altitude.

Substitute 10 for base.

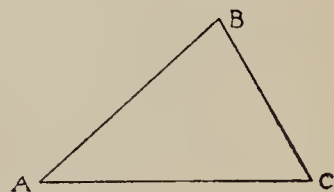

What results do you obtain in the two equations?

4. Suppose the equation is $\text{circumf.} = \pi \times \text{diam.}$

Divide both sides by π , giving $\frac{\text{circumf.}}{\pi} = \text{diam.}$

Use this second equation to find the diameter of a tree where it measures 44 inches around.

5. Divide both sides of the equation $\pi r^2 = \text{area of circle}$ by π , giving $r^2 = (\text{area of circle}) \div \pi$

Use this second equation to find approximately how long a radius you need to use (a) to make a circle containing 10 sq. in.;

(b) to make a circle containing 11 sq. in.; (c) to make one containing 12 sq. in.; (d) 13 sq. in. (First find r^2 . Then find r by finding the square root of r^2 or estimate r from the table below.)

$1.78^2 = 3.17$	$1.86^2 = 3.46$	$1.94^2 = 3.76$	$2.02^2 = 4.08$
$1.79^2 = 3.20$	$1.87^2 = 3.50$	$1.95^2 = 3.80$	$2.03^2 = 4.12$
$1.80^2 = 3.24$	$1.88^2 = 3.53$	$1.96^2 = 3.84$	$2.04^2 = 4.16$
$1.81^2 = 3.28$	$1.89^2 = 3.57$	$1.97^2 = 3.88$	$2.05^2 = 4.20$
$1.82^2 = 3.31$	$1.90^2 = 3.61$	$1.98^2 = 3.92$	$2.06^2 = 4.24$
$1.83^2 = 3.35$	$1.91^2 = 3.65$	$1.99^2 = 3.96$	$2.07^2 = 4.285$
$1.84^2 = 3.385$	$1.92^2 = 3.69$	$2.00^2 = 4.00$	$2.08^2 = 4.33$
$1.85^2 = 3.42$	$1.93^2 = 3.725$	$2.01^2 = 4.04$	$2.09^2 = 4.37$

6. Find the value of w , x , y , or z in these equations by adding or subtracting some quantity from both sides and performing the operations indicated.

$$x + 4 = \frac{28}{4} \quad (\text{What will you subtract from each side?})$$

$$y - 5 = \frac{21}{3} \quad (\text{What will you add to each side?})$$

$$z - 2 = \frac{7 + 5}{3} \quad w + 6 = \frac{1}{4} \text{ of } 32$$

7. Find the value of w , x , y , z , etc., in these equations by multiplying or dividing both sides of the equation by some number and performing the operations indicated.

$$2x = 6 + 8 \qquad \frac{I}{3} = 15$$

$$\frac{y}{2} = 5 \qquad \frac{n}{6} = 8$$

$$4z = 18 + 2 \qquad 10x = 8^2 + 8$$

$$7w = 5 + 10 + 15 + 5 \qquad 3q = 4^2 - 1$$

8. Find the values of q , r , s , etc., in these equations:

$$x + 2 = 9 \qquad 3z = 28 - 7 \qquad 18 = u - 7$$

$$14 - t = 8 \qquad \frac{3v}{4} = 9 \qquad 2 = \frac{s}{5}$$

$$\frac{2r}{3} = 10 \qquad \frac{w}{2} = 70 \qquad 6 + 9 = 3q$$

To *solve an equation* means to find the value which is represented by area, x , y , z , circum., volume, I, T, W, . . . or whatever name you give to the number that you wish to find.

1. Solve each of these equations:

$$x + 2 = 5 \quad y - 4 = 8 \quad 3z = \frac{1}{2} \text{ of } 30 \quad t = 10\frac{1}{4}$$

$$x^2 = 30 + 6 \quad z^3 = 8 \times 2 \times 4 \quad I = .04 \times \$100 \times 2$$

2. State the facts of this problem in an equation representing the number that you wish to find by some letter. Then solve the equation.

A certain number plus $\frac{2}{3}$ of 15 = 6 \times 8. What is the number?

3. Do the same for each of these problems:

a. A certain number divided by π equals the square of 8. What is the number?

b. The cube of a number equals $4 \times 2\frac{1}{2} \times .8$. What is the number?

c. The volume of a sphere is $\frac{4}{3}$ of the product of $\pi \times$ the cube of the radius of the sphere. What is the volume of a sphere of 14 inches radius?

d. The volume of a cone in cubic inches is $\frac{1}{3}$ of the product of its height \times the area of the circle which forms the base of the cone. What is the volume of a cone if its height is 6 in. and its base is a circle with 2 inches as radius?

e. The volume of a pyramid in cubic feet is $\frac{1}{3}$ of the product of its height \times the area of its base. What is the volume of a pyramid which is 15 ft. high if its base is a square 3 ft. on a side?

f. The square of a number equals the sum of the square of 64 and the square of 48. What is the number?

g. The rim speed of a wheel in ft. per min. equals the number of revolutions per minute \times the circumference of the wheel (in feet). What is the rim speed of a wheel 2 ft. in diameter at 250 revolutions per minute?

- h. The number of watts of electrical energy equals the product of the current in amperes \times its voltage or E.M.F. in volts. $Watts = Amperes \times Volts$. How many watts are there in a current of 10 amperes at an E.M.F. or voltage of 110 volts?
- i. How many watts are there in a current of 10 amperes at an E.M.F. of 250 volts?
- j. How many amperes of current are required at an E.M.F. of 110 volts to give 660 watts?
- k. How many amperes of current are required at an E.M.F. of 250 volts to give 2000 watts?
- l. How many volts must the E.M.F. be to have 440 watts from a current of 2 amperes?
- m. How much money must be invested at 4% interest to produce an income of \$200 every six months? Use $x \times .04 = 2 \times \200 or any other equation that tells the facts about the amount of money to be invested.
- n. How much money must be invested at 5% interest to produce an income of \$250 every 3 months?
- o. At what rate must \$30,000 be invested to produce an income of \$250 every 3 months?
- p. At what rate must \$25,000 be invested to produce an income of \$125 per month?
4. Perform the operations indicated and solve for x :
- I. $x = (\$12,930 \div 15) + (\frac{1}{8} \text{ of } \$16,500) - (.06 \times \$3500)$.
- II. $x + (15\% \text{ of } \$7940) = (2\frac{1}{2} \times \$7940) + (22\frac{1}{2}\% \text{ of } \$6000)$
- III. $3x = \$9750 - (12\% \text{ of } \$9750) - (\frac{2}{5} \times \$4300) - (.08 \times \$1200)$
- IV. $5x + \$4000 = (\frac{3}{4} \text{ of } \$8750) + (\frac{5}{8} \text{ of } \$6200) - (30\% \text{ of } \$6500)$
- V. $2x + \frac{1}{2}x = \$11,250$. VI. $\frac{x}{3} = (.04 \times \$20,000)$
- VII. $x =$ the square root of the sum of 60^2 and 80^2 .
- VIII. $x =$ the average of 8.246, 7.36, 11.8, and 9.87.

Find the value of x in each of the equations below by substituting the value of the table for a, b, c , etc., and solving the equations. ab means $a \times b$, cde means $c \times d \times e$. πfl means $\pi \times f \times l$.

$a = 10$	$f = 7$	$k = 12$	$p = 8$
$b = 5$	$g = 9$	$l = 20$	$q = 4$
$c = 3$	$h = 44$	$m = 42$	$r = 3$
$d = 5$	$i = 16$	$n = 68$	$s = 6$
$e = 6$	$j = .04$	$\pi = 2\frac{2}{7}$	$t = 9$

- $x = ab$
- $x = \pi f^2$
- $x = i \div (j \times k)$
- $x = 1.8m + 32$
- $x = 4\pi f^2$
- $x = \frac{720f^2}{7}$
- $x = \sqrt{q^2 + r^2}$
- $x = \frac{4}{3}\pi f^3$
- $x = abc$
- $x = \frac{1}{2}fg$
- $x = 2\pi fl$
- $x = \frac{\sqrt{h}}{\pi}$
- $x = \frac{n - 32}{1.8}$
- $\frac{x}{5} = \frac{r}{t}$
- $x = e \times \frac{1}{2}(a + d)$
- $x = \frac{120b \times c^2}{a}$
- $x = 2\pi f$
- $x = 720f^2$
- $x = \frac{5280}{10l}$
- $x = a^3$
- $3x = 4\pi t^2$

28. Addition with Letters

- Let q stand for 1 quart. Let p stand for 1 peck. Let b stand for 1 bushel.

Mr. A. has $1b + 3p + 6q$.

Mr. B. has $2b + 2p + 7q$.

Mr. C. has $1b + 2p + 5q$.

How much have all three men together?

What is the average amount per man?

- Check your result by adding in this way:

$$\begin{array}{r}
 1b + 3p + 6q \\
 2b + 2p + 7q \\
 1b + 2p + 5q \\
 \hline
 4b + 7p + 18q
 \end{array}$$

3. Let a stand for \$12. Let b stand for \$29. Let c stand for \$38.
Let d stand for \$8.

Mr. A. has $7a + 9b + c + d$.

Mr. N. has $5a + 7b + 5c + d$.

Mr. S. has $6a + 6b + c + 6d$.

Mr. T. has $2a + 8b + 3c + 2d$. How much have all four men together?

4. Check your result by finding the sum as $20a + 30b + 10c + 10d$ and then substituting \$12 for a , \$29 for b , etc.

5. Add:

$$5\frac{1}{2}e + 2\frac{3}{8}f + \frac{5}{6}g$$

$$4\frac{1}{4}e + 1\frac{3}{8}f + 1\frac{1}{6}g$$

$$\underline{5\frac{1}{4}e + 8\frac{1}{4}f + g}$$

6. What is the value of $15e + 12f + 3g$ if $e = \frac{1}{3}$, $f = \frac{1}{2}$, and $g = \frac{2}{3}$?

29.

$2\pi r$ means 2 times π times r . $7bh$ means $7 \times b \times h$.

prt means $p \times r \times t$. ab^2 means $a \times$ (the square of b).

$$a = 18 \quad h = 2\frac{1}{4} \quad r = 35$$

$$b = 8 \quad l = 3 \quad p = \frac{1}{3}$$

$$c = 6 \quad \pi = 2\frac{2}{7} \quad t = 2$$

What is the value of x in each of these equations?

- | | | | |
|-------------------------|-----------------------------|-------------------------|-----------------------|
| 1. $x = abc$ | 5. $x = \pi r^2$ | 9. $x = 7bh$ | 13. $x = c^3$ |
| 2. $x = bc^2$ | 6. $x = 5^2 t^2$ | 10. $x = \frac{1}{3}st$ | 14. $x = 4\pi r^2$ |
| 3. $x = 2\pi r$ | 7. $x = \frac{4}{3}\pi r^3$ | 11. $x = hl$ | 15. $x = \sqrt[3]{b}$ |
| 4. $x = \sqrt{b^2 c^2}$ | 8. $x = 4l^3$ | 12. $x = 3a\pi r^2$ | 16. $x = 4t^2 - 3s$ |

What is the value of y in each of these equations?

- | | | | |
|-------------------------------------|----------------------------|--------------------------------------|------------------------------|
| 17. $y = \frac{3}{a} + \frac{2}{c}$ | 20. $y = \frac{a}{b + 2c}$ | 23. $y = \frac{\sqrt{2a}}{t^2}$ | 26. $y = 9s + \frac{t^2}{3}$ |
| 18. $y = \frac{16}{ab}$ | 21. $y = \frac{3st}{bh}$ | 24. $y = \frac{4hb}{a}$ | 27. $y = \frac{b^2}{t^3}$ |
| 19. $y = \frac{15}{bc - a}$ | 22. $y = \frac{c^2}{ab}$ | 25. $y = \frac{\sqrt{b^2 + c^2}}{r}$ | 28. $y = \frac{4lbh}{6t^3}$ |

State the missing numbers:

- At 4 P.M. the thermometer stood at 6 degrees above zero. By 8 P.M. it was 10 degrees colder or ... degrees below zero.
- By 11 P.M. it was at -8 (8 degrees below zero) or ... degrees colder than it was at 4 P.M.
- (a) How much colder is -6 degrees than $+8$ degrees? (b) How much colder is -36 than -16 ?

RANGE OF RECORDED TEMPERATURE
FOR AMERICAN CITIES

	High	Low
Boston	102	-13
Chicago	103	-23
Key West	100	41
New York	100	-6
Seattle	96	3
San Francisco	101	29
St. Paul	104	-41

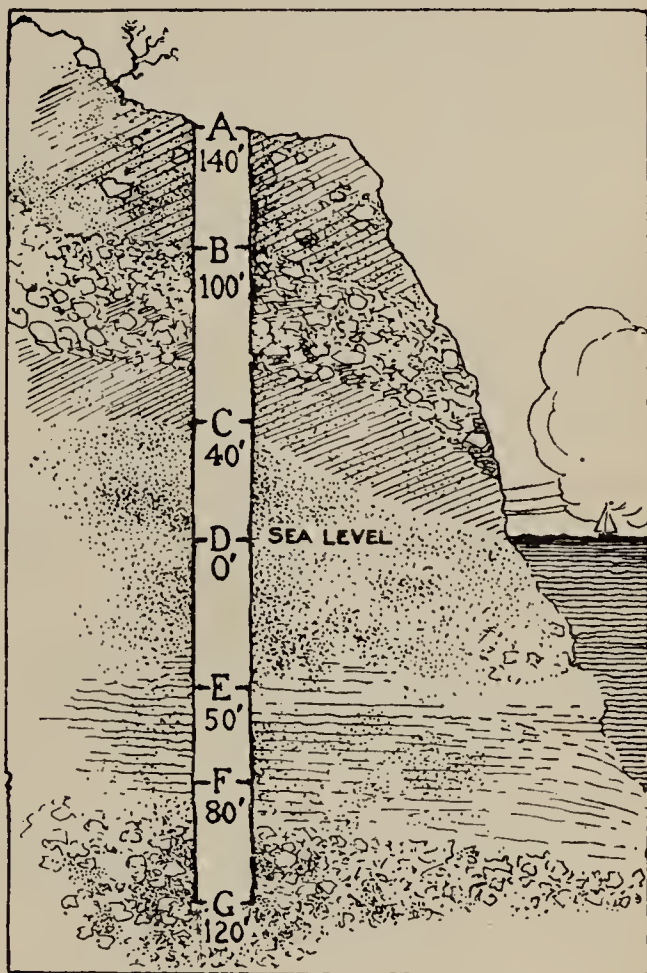

- Tell the difference between the highest and lowest temperatures at each of the places named in the table. -13 , -23 , -6 , and -41 mean 13 below zero, 23 below zero, etc.
- How much higher is A than B on this map?
- How much higher is A than C? 7. Than D?
- Than E? 9. Than F?
- How much higher is D than E? 11. Than F?
- How much higher is E than F?
- Call distances above sea level $+$; and call distances below sea level $-$. M is $+42$ ft. R is -36 ft. How much higher is M than R?
- N is $+940$ ft.; S is -60 ft. How much higher is N than S?

31. Negative Numbers

$-1, -2, -3, -4, -5, -50, -100$, etc., are called **Negative Numbers**.

1. Count backward by 2s from 10 to -20 , beginning 10, 8, 6, 4, 2, 0, $-2, -4, -6$.
2. Count backward by 3s from 12 to -30 , beginning 12, 9, 6, 3, 0, $-3, -6$.
3. Count backward by 4s from 12 to -40 , beginning 12, 8, 4.
4. Count backward by 5s from 15 to -25 , beginning 15, 10, 5.
5. Count by 6s to 42, beginning $-42, -36, -30, -24$.
6. Count by 7s to 35, beginning $-70, -63, -56$.
7. (a) How much must you add to -2 to make $+4$? (b) To -5 to make $+2$? (c) To -6 to make $+1$? (d) To -3 to make $+9$? (e) To -10 to make 0?
8. Call each dollar that a man has or is owed to him $+1$.
Call each dollar that he owes -1 .
If he owes more than he has, is his balance $+$ or $-$?
9. If he has \$62 and owes \$42, what is his balance, $+$ \$20 or $-$ \$20 or $+$ \$104 or $-$ \$104?
10. What is his balance (a) If he has \$16 and owes \$30? (b) If he has \$20 and owes \$30?
11. How much must a man whose balance is $-$ \$23 save to make his balance $+$ \$27?
12. What is the average wealth of four brothers, whose balances are $+$ \$1500, $-$ \$800, $-$ \$400, and $+$ \$300?

Call profits $+$ (plus). Call losses $-$ (minus).
13. A certain business has five departments which showed profits or losses for the year as follows: $+$ \$1800, $+$ \$900, $-$ \$400, $-$ \$100, and $-$ \$200. What was the profit for the year for the whole business?
14. In another business of six departments, four showed on the average $+$ \$1200 per department, two showed on the average $-$ \$400. What was the profit for the year for the whole business?

15. Call each change from one year to the next year + when it is an increase and - when it is a decrease. Supply the missing numbers for column 3 of this table prefixing + or - to show whether the change was an increase or a decrease.

Year	Sales	Amount of Change
'11	\$12,682	
		'11 to '12 + \$1488
'12	14,170	
		'12 to '13
'13	13,390	
		'13 to '14
'14	11,685	
		'14 to '15
'15	16,213	
		'15 to '16
'16	13,878	

16. A firm gives each of its employees a score like this:

<i>For any specially good piece of work,</i>	+ 5
<i>For a useful suggestion about the business,</i>	+ 8
<i>For specially neat appearance,</i>	+ 3
<i>For specially good manners,</i>	+ 3
<i>For each time late to work,</i>	- 2
<i>For each little error in arithmetical work or copying,</i>	- 1
<i>For each important error in arithmetical work or copying,</i>	- 3
<i>For disputing with other employees,</i>	- 4
<i>For being untidy or impolite,</i>	- 4

What is each employee's total score for the record shown in the table? Each line (/) means one piece of work or suggestion or dispute or error, etc.

	Ames	Bean	Hirsch	Kelly	Platt	Rowe
Specially good work	/		///	//		//
Useful suggestions	//		//			///
Appearance		/			/	/
Manners		/			/	/
Late		//			////	
Small errors		/		///		
Large errors		/		/		
Disputing	/					
Untidiness	/		//			
Impoliteness			/			

Numbers like 1, 2, 3, 16, 100, $\frac{1}{2}$, $\frac{7}{12}$, are called **positive numbers**. Numbers like -1, -2, -3, -16, -100, $-\frac{1}{2}$, $-\frac{7}{12}$, are called **negative numbers**.

32. Using Negative Numbers

By using negative numbers you can subtract any number from any other. 15 from 10 leaves -5 ; 30 from 5 leaves -25 . 6 from 2 leaves -4 . $7a$ from $3a$ leaves $-4a$; $8d$ from $3d$ leaves $-5d$.

1. Tell the differences when you subtract the lower number from the upper:

$$\begin{array}{r} 2 \\ \hline 4 \end{array} \quad \begin{array}{r} 4b \\ \hline 12b \end{array} \quad \begin{array}{r} 11c \\ \hline 8c \end{array} \quad \begin{array}{r} 6 \\ \hline 12 \end{array} \quad \begin{array}{r} 3c \\ \hline 9c \end{array} \quad \begin{array}{r} 7x \\ \hline 10x \end{array} \quad \begin{array}{r} 15d \\ \hline 6d \end{array} \quad \begin{array}{r} 5 \\ \hline 13 \end{array}$$

$$\begin{array}{r} 10a \\ \hline 15a \end{array} \quad \begin{array}{r} 4y \\ \hline 8y \end{array} \quad \begin{array}{r} 6 \\ \hline 11 \end{array} \quad \begin{array}{r} 7e \\ \hline 9e \end{array} \quad \begin{array}{r} 9b \\ \hline 2b \end{array} \quad \begin{array}{r} 8c \\ \hline 10c \end{array} \quad \begin{array}{r} 2 \\ \hline 5 \end{array} \quad \begin{array}{r} 16 \\ \hline 7 \end{array}$$

2. Tell the sums:

$$\begin{array}{r} + 8 \\ - 10 \\ + 6 \\ \hline \end{array} \quad \begin{array}{r} - 3e \\ - 7e \\ - 5e \\ \hline \end{array} \quad \begin{array}{r} + 6d \\ + d \\ + 4d \\ \hline \end{array} \quad \begin{array}{r} - 4x \\ + 9x \\ + 8x \\ \hline \end{array} \quad \begin{array}{r} - 3a \\ + 5a \\ + 2a \\ \hline \end{array} \quad \begin{array}{r} - 4b \\ - 9b \\ + 7b \\ \hline \end{array} \quad \begin{array}{r} - 8c \\ + 9c \\ - 7c \\ \hline \end{array} \quad \begin{array}{r} - 9 \\ - 9 \\ - 9 \\ \hline \end{array}$$

3. What is the average temperature for a week when 4 days each were -3° , and 3 days were each -5° ?
4. What is the average score of an employee for a year who receives -15 for each of six months and -5 for each of the other six months?
5. What is the average temperature for a week when 5 days were -4° each, one day was $+5^\circ$, and one day was $+1^\circ$?
6. When a negative number is multiplied or divided by a positive number, is the result a positive number or a negative number?
7. Say the multiplication tables using negative numbers as the multiplicands.
8. Say the division tables, using negative numbers as the dividends.

$$2 \times -2 = -4$$

$$3 \times -2 = -6$$

$$4 \times -2 = -8$$

$$5 \times -2 = \dots$$

etc.

$$2 \times -3 = -6$$

$$3 \times -3 = -9$$

$$4 \times -3 = \dots$$

$$5 \times -3 = \dots$$

etc.

$$4 \overline{) -8} = -2$$

$$4 \overline{) -12} = -3$$

$$4 \overline{) -16} = \dots$$

$$4 \overline{) -20} = \dots$$

etc.

INDEX

The numbers refers to pages. No attempt is made to index the details of computations or problems. The references are only to pages where the topic is treated at some length.

- | | | |
|--|---|---|
| <p>Accounts, 141 f., 274
 Addition, 1 f., 81 f.;
 <i>see also</i> Table of Contents
 Aliquot parts, 17
 Altitude, 208
 Arc, 212 f., 219 f.
 Area, 206, 209, 220, 225, 223
 Assessments, 167 f.</p> <p>Bills, 41 f.
 Board measure, 108 f., 243
 Bonds, 161 f.
 Bonus and piece work, 153
 Borrowing, 62 f., 142 f., 174
 Budgets, 185, 259
 Buying, 57 f.</p> <p>Canceling, 15 f.
 Centigrade scale, 218
 Checks, 45, 139 f.
 Circles, 205 f.
 Circular measure, 111 f.
 Circumference, 205
 Commission, 54 f., 153
 Compass, 112 f.
 Compound interest, 58
 Cones, 211, 234
 Cord, 110
 Cube, 198 f.
 Cube root, 200
 Cylinders, 207 f.</p> <p>Decimals, 1 f., 131 f.
 Deposits, 139 f.
 Diameter, 205
 Dietaries, 191 f.
 Discounts, 46 f.</p> | <p>Dividends, 157 f.
 Division, 18 f., 81 f., 136; <i>see also</i> Table of Contents
 Draft, 45</p> <p>Equations, 117 f., 135, 212 f., 233 f., 264, 277
 Expenditures, public, 177 f., 182</p> <p>Face: of note, 146; of policy, 36
 Factoring, 226
 Fahrenheit scale, 218
 Farm problems, 100 f., 269 f.
 Foods, 74 f., 189 f., 275 f.
 Foreign money, 226</p> <p>Gain, 50 f., 118
 Games, 35, 135, 138
 Gear ratios, 263
 Graphs, 81, 164 f., 195 f., 230 f.</p> <p>Heights, 116
 Home problems, 49, 74 f., 130 f., 184 f., 189 f.
 Hypotenuse rules, 201 f.</p> <p>Income, 163
 Industrial problems, 23, 150 f., 216 f., 260 f.
 Installments, 68 f.
 Insurance, 35 f., 39</p> | <p>Interest, 59 f., 62 f., 67 f., 119, 122, 135, 242
 Inventories, 34
 Investing, 159 f.</p> <p>List price, 47 f., 119
 Loans, 63 f.
 Longitude, 220 f.
 Loss, 50 f.</p> <p>Maps, 113, 127 f.
 Measurements, 26 f., 108 f., 111 f., 133 f., 205 f., 233 f., 240, 245, 248
 Metric system, 221 f.
 Money orders, 44
 Mortgages, 161 f.
 Multiplication, 13 f., 81 f.; <i>see also</i> Table of Contents.</p> <p>Negative numbers, 283 f.
 Net prices, 47 f., 119
 Notes, 63 f., 142 f., 148 f.</p> <p>Par value, 150 f.
 Parallelograms, 119, 134
 Parentheses, 103 f., 122
 Partial payments, 68 f.
 Percents, 28 f., 131 f., 189 f.; <i>see also</i> Table of Contents
 Policy, 36
 Postal Savings Banks, 60</p> |
|--|---|---|

Practice, *see* Table of Contents
Premium, 36
Prices, 33, 47 f., 119
Principal, 62, 122
Prisms, 210
Problem solving, 97 f.;
see also Table of Contents
Promissory notes, 63, 145 f.
Proportion 12, 77 f., 114 f., 137, 262
Public business, 168 f.
Pyramids, 211

Radius, 205
Ratio, 12, 77 f., 114 f., 137, 262 f., 276
Rations, 191 f.
Real estate, 160
Receipts, 41 f., 169 f., 183
Recipes, 76 f.

Reciprocal, 24 f.
Rectangles, 119
Reviews, 1 f., 69 f., 116 f., 123 f., 129 f., 138, 172 f., 197, 223 f., 226 f.; *see also* Table of Contents
Roads, 179 f.
Roots, 200, 202 f.

Sale slips, 41 f.
Saving, 58, 60 f., 159 f.
Savings banks, 59 f.
School: activities, 30 f.; expenditures, 177 f.
Sectors, 212 f.
Selling, 50 f.
Shares, 153 f.
Similar figures, 114 f., 260 f.
Spheres, 234
Squares and square roots, 198 f.

Stocks, 153 f.
Subtraction, 8 f., 81 f.

Tables, 67, 242 f., 256 f., 265 f.
Taxes, 167 f.
Term, 36
Tests, 5, 6, 7, 10, 31, 36, 82 f., 98 f., 131, 132, 133 f.
Triangles, 114 f., 119, 133 f.

Units of measure, 26 f., 218, 221 f.

Valuation, 40, 171 f.
Volume, 207 f., 220, 225
Voting, 173 f.

Wages, 150 f., 181 f., 266

FEB 1 1918

RAND
& C