



OFFICE OF
Educational Technology

Future Ready Schools:

Building Technology Infrastructure for Learning

U.S. DEPARTMENT OF EDUCATION

<http://tech.ed.gov>



U.S. Department of Education

Arne Duncan

Secretary

Office of Educational Technology

Richard Culatta

Director

November 2014

The mention of trade names, commercial products or organizations in this report does not imply endorsements by the U.S. government. Further, the inclusion of information or URL does not reflect the importance of the organization, nor is it intended to endorse any views expressed, or products or services offered. The U.S. Department of Education is not responsible for controlling or guaranteeing the accuracy, relevance, timeliness or completeness of this information.

This report is in the public domain. Authorization to reproduce this report in whole or in part is granted. While permission to reprint this publication is not necessary, the suggested citation is: U.S. Department of Education, Office of Educational Technology, Future Ready Schools: Building Technology Infrastructure for Learning, Washington, D.C., 2014.

This report is available on the Department's Web site at <http://tech.ed.gov>.

Requests for alternate format documents such as Braille or large print should be submitted to the Alternate Format Center by calling 202-260-0852 or by contacting the 504 coordinator via email at om_eeos@ed.gov.

Contents

Acknowledgements	5
Introduction: The Promise of Ubiquitous Connected Learning	6
The Need for Speed	7
Getting Started	10
Getting High-Speed Internet to Schools	17
Types of Internet Connections	17
Approaches for Connecting Schools	23
Path 1: Schools Connect Through the District to Research & Education Networks	23
Path 2: Schools Connect Through District to Commercial ISP	26
Path 3: Schools Connect Directly to Commercial ISP	28
Path 4: Devices Connect Directly to Commercial ISP	29
Major Cost Drivers	31
E-Rate Funding for Internet Connectivity	32
Special Considerations for Rural Areas	33
Getting High-Speed Internet Throughout Schools	35
Planning Your Network	35
Configuring and Managing Your Network	39
Getting Devices to Students and Teachers	44
Factors to Consider When Selecting Devices	44
Determining Device Requirements	47
Structuring Device Purchases	48
Funding Device Purchases	49
Setting a Refresh Cycle	50
District Devices at Home	52
Choosing a Rollout Model	54
Planning Your Rollout	54

Responsible Use, Privacy, and Other Considerations	57
Device Management	57
Ensuring and Encouraging Responsible Use	58
Protecting Privacy	59
Safeguarding Against Inappropriate Content	61
Dealing with Lost or Damaged Devices	63
Conclusion	66
Appendix	67
Notes	68

Acknowledgements

This guide was developed under the guidance of Richard Culatta, Bernadette Adams, Joseph South, and Zac Chase of the U.S. Department of Education, Office of Educational Technology.

Marianne Bakia of SRI International led guide development and drafting. Other contributing authors were Marie Bienkowski, Sarah Nixon Gerard, Jim Klo, and Gloria I. Miller. Susan Thomas of S2 Enterprises LLC supported the development team with substantive editing, writing, and advice. Jennifer Knudsen, Rob Muller, and Phil Vahey, also of SRI International, provided advice and insightful feedback on drafts. Eryn Heying provided research assistance, and Brenda Waller provided administrative assistance. Kate Borelli produced graphics and layout.

The authors thank the experts interviewed for this guide: Kristen Atkins (Qualcomm), Denise Atkinson-Shorey (e-Luminosity), Wayne Beasley (Craven County Schools, North Carolina), Cathy Benham (CSM Consulting), Kevin Carman (Education Channel Marketing, AT&T), Fred Dyste (Digital West Networks), Kim Friends (CSM Consulting), LeRoy Hardy, Jr. (Dicoer Education Technology Management), Lisa Hone (Federal Communications Commission), Greg Klein (Rogers Family Foundation), Keith Krueger (Consortium for School Networking), Jen Leasure (The Quilt), Greg Mathison (CISCO), Evan Marwell (Education Superhighway), Carroll McGillin (CISCO), Sujeet Rao (U.S. Department of Education), Tom Rolfes (Network Nebraska), Teri Sanders (Imperial County Office of Education, California), Susan Silveira (Qualcomm), Michael Steffen (Federal Communications Commission), Kathleen Styles (U.S. Department of Education), Mary Veres (Sunnyside Unified School District, California), Matt Wallaert (Microsoft/Bing), and Luis Wong (Imperial County Office of Education, California).

In addition, a Technical Working Group of K-12 chief technology officers reviewed drafts of the guide and provided invaluable feedback, writing, and examples from their experiences. Many thanks to Steve Clemons and Greg Ottinger (San Diego County Office of Education, California), Michael Evans (Forsyth County Schools, Georgia), Patrick Larkin (Burlington Public Schools, Massachusetts), Maribeth Luftglass (Fairfax County Public Schools, Virginia), Jeff Mao (Maine Department of Education), Patrick Martin (U.S. Department of Defense Education Activity), Steve Midgley (U.S. Department of Education), Fran Newberg (Philadelphia School District, Pennsylvania), Adam Seldow (Chesterfield School District, Virginia), Scott Smith (Mooresville Graded School District, North Carolina), and Bob Swiggum (Georgia Department of Education).

Introduction: The Promise of Ubiquitous Connected Learning

The U.S. Department of Education's National Educational Technology Plan (NETP) presents a model of learning powered by technology to help the nation's schools provide all students with engaging and powerful learning content, resources, and experiences. The plan calls for revolutionary transformation rather than evolutionary tinkering.

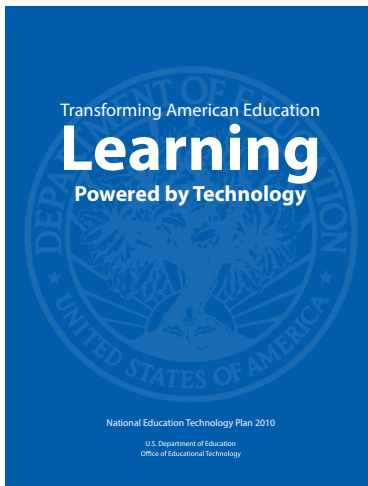

"Technology is at the core of virtually every aspect of our daily lives and work, and we must leverage it to provide engaging and powerful learning experiences and content, as well as resources and assessments that measure student achievement in more complete, authentic, and meaningful ways."

National Education Technology Plan, p. ix

Outside of school, many students enjoy technologies that give them 24/7 access to information and resources and that enable them to find, curate, and create content and connect with people all over the world to share ideas, collaborate, and learn new things. For the vision established by the NETP to be fully realized, access to web-based tools and resources needs to be both instantaneous and ubiquitous inside as well as outside school. To provide students with the education they need to thrive in a globally connected world, we must find ways to design, fund, acquire, and maintain the infrastructure that will make connectivity a reality for every teacher and student in every classroom.

This guide provides practical, actionable information intended to help district leaders (superintendents, principals, and teachers leaders) navigate the many decisions required to deliver cutting-edge connectivity to students. It presents a variety of options for district leaders to consider when making technology infrastructure decisions, recognizing that circumstances and context vary greatly from district to district.

The Need for Speed

"We are denying our teachers and students the tools they need to be successful. That is educationally unsound and morally unacceptable."

Secretary Duncan, June 17, 2013

Concerted efforts by federal, state, and local institutions over the last decade have brought some level of Internet connectivity to nearly all the nation's schools and libraries. However, this connectivity often has gone only as far as the school office or computer lab, where it can be inconsistent at times and staff are unsure how to address routine disruptions in service. In addition, while the speed of the connections in many schools was acceptable for the tools and abilities of yesterday's technologies, it is nowhere near adequate for today's classrooms and falls short of providing our schools, classrooms, and teachers with the digital connectivity and tools necessary to supply our students with a world-class education. The bandwidth required for today's student to upload high-definition multimedia content, participate in an online video conference, and curate an electronic portfolio of learning far exceeds what was required to give students access to early online tools such as email and static reference materials. For students to access cutting-edge digital learning tools, schools will need to upgrade their technical infrastructure to extend high-speed Internet access to every classroom and instructional space.

Definition

Broadband refers to high-speed Internet access that is always on and faster than traditional dial-up access. Broadband provides higher-speed data transmission, as it allows more content to be carried through the "pipe." Although there is not a particular speed that defines them, broadband connections in schools enable students to engage in rich digital learning experiences such as streaming videos, gaming, and interactive services. To better understand the nation's broadband coverage, visit the [FCC's National Broadband Map](#).

Access to high-speed Internet in schools is a pressing social issue as well. When Internet connections in schools are too slow—a problem disproportionately common in rural and underresourced communities—students miss the benefits of educational technologies entirely. Gaps in access to broadband tools and content exacerbate other, preexisting inequities in underconnected schools and unconnected homes.

Outmoded Internet access also raises productivity and efficiency concerns that have financial implications for districts and schools. Teachers without high-speed Internet cannot join streaming global professional conferences, share video of their practice with online peer-coaching groups, or respond via multimedia screen capture to student work in a timely and efficient way during school hours. Often, they must stay late or work from home, where they have access to a faster Internet connection.

"[I]n a country where we expect free Wi-Fi with our coffee, why shouldn't we have it in our schools? Why wouldn't we have it available for our children's education?"

President Obama, June 6, 2013

Nearly half of respondents to a survey of schools and districts by the Federal Communications Commission (FCC) in 2010 reported lower speed connectivity than the average American home.² Eighty percent of respondents to a 2011 FCC survey said their broadband connections did not fully meet their needs,³ and more than half of teachers surveyed reported that slow or unreliable Internet access prevents effective use of technology in their classrooms.²

Recognizing the growing opportunities and need for student and teacher access to high-speed Internet, President Obama launched the ConnectED Initiative, setting a goal of connecting 99% of students to the Internet in their schools and libraries at speeds of no less than 100 megabits per second (Mbps) per 1000 students and a target speed of 1 gigabit per second (Gbps) by 2018.⁴

A second component of the ConnectED Initiative calls on the private sector to provide digital learning devices as well as content and resources for teachers and students that are price-competitive with print-based learning tools such as textbooks and provide cutting-edge access to digital tools.



Definitions

Bandwidth is the amount of data that passes through a network as measured in bits per second (bps).

Kbps is short for kilobits per second. A kilobit is a data transfer rate of 1,000 bits per second. A fax machine takes about 12 seconds to send a page at 30 Kbps.

Mbps is short for megabits per second. A megabit is a data transfer rate of 1,000,000 bits per second. The State Educational Technology Directors Association (SETDA) recommends schools have a minimum of 1 Mbps per student.¹ Mbps of connectivity would enable a single student to stream a 10-minute high-definition video.

Gbps is short for gigabits per second. A gigabit is a data transfer rate of 1,000,000,000 bits per second. This is the ConnectED goal for a school to achieve by 2018. At this speed, 1,000 students could stream a 10-minute high-definition video in real time.

Equally important is the investment in high-quality professional development so teachers enter classrooms ready to use the new tools to support personalized learning for students.⁵

Through the ConnectED Initiative, significant progress has been made toward increasing school-based access to broadband:

- more than \$2 billion in private-sector commitments to deliver technologies to classrooms, including mobile devices, free software, teacher professional development, and home wireless connectivity;
- an additional \$2 billion from the FCC in E-rate funding to connect 20 million more students to next-generation high-speed broadband and wireless; and
- clarification that supporting the transition to digital learning is an allowable use of billions of dollars of U.S. Department of Education grant funds through the Office of Educational Technology's [Dear Colleague Letter](#).

Technological infrastructure is just one element of educational transformation. Its use should be guided by clear goals and effective planning, which require that stakeholders in the system act together and plan beyond technology alone. Therefore, this guide also provides considerations for digital learning resources and staff professional development and addresses other implementation issues such as device selection, responsible use policies, privacy, and security associated with creating effective connected schools.



What this guide won't do for you...

This guide focuses on the steps and decisions you need to make in implementing the technological infrastructure to support a comprehensive educational technology plan. This guide does not address the other key steps in such a plan—determining how students will use technology to advance learning goals, how to provide teachers with the training necessary to use these tools, and what content and instructional methods to use. Establish your vision for how technology will be used to transform learning before using this guide. For more information about crafting a comprehensive district educational technology plan, you should consult other resources, starting with the NETP.

1 Getting Started

IN THIS SECTION

- Planning and leadership demands associated with technical upgrades
- Key questions for assessing conditions in schools and districts
- Setting technical goals for the future

Technology-supported learning across the country is enabling students to create multimedia, to collaborate with experts and learners across the world, and to employ tools to access deeper, more personalized learning, which, in turn, helps them become more college- and career-ready. Teachers, parents, and students are looking for schools to provide high-quality, sustainable, dependable learning tools and cutting-edge connectivity.

Put Learning First

Examples abound of ill-fated “technology first” investments in schools. Instead of a single wide-scale rollout, consider small pilots and phased implementation approaches, which enable you to adjust even the best-laid plans to meet unexpected needs. Check with hardware and software providers as they may offer an opportunity to pilot a solution at little or no cost before making a larger financial commitment. As you refine your pilot, begin to plan how you will move it to scale. Begin to ask which components will need to be reconsidered when applied to entire schools or districts as compared to a select group of users.

While getting connected devices in the hands of students and teachers is important, it takes more than that to shift practices within classrooms, schools and districts and therefore outcomes.

Most important to this transition is a clear vision of the actions and attributes of learning and teaching you hope for as you move toward universal high-speed broadband access. This vision will provide you and your district with a compass by which you can steer the process outlined in this guide. This section explores some important elements of the process.



Look to Those Who've Come Before You

Considering the efforts of those who have come before you can prevent missteps and lead to a more efficient use of time and money. More experienced districts such as those referenced in this guide can share best practices and lessons learned, which can be valuable for planning and monitoring.

You can also find guidance from state and national agencies and nonprofit organizations such as:

- [Alliance for Excellent Education](#)
- [CoSN](#)
- [Digital Promise](#)
- [Education Superhighway](#)
- [ISTE](#)
- [National Clearinghouse for Educational Facilities](#)
- [Project RED](#)
- [SETDA](#)

Check your state department of education website for further guidance. For example, the New Jersey Department of Education has a [Facilities Guide for Technology](#) available online. Many districts post technology plans online that can serve as examples, like [Pleasanton Unified School District](#) in California and [Santa Rosa County District Schools](#) in Florida.

In successful implementations, superintendents lead the transition to connected learning (where students and teachers have access to people and resources to improve learning whenever they need it) and they ensure districts build high-level leadership teams (or call on existing ones) to develop a districtwide vision for how technology supports educational goals and garner staff and community support. In addition to leadership and support from a superintendent, a CTO or CIO offers deep technology expertise, and a chief financial officer actively pursues funding options and opportunities. Superintendents may also rely on recommendations from knowledgeable members of the community and colleagues in other districts.

After identifying a strong planning team, the next step is to assess the capacity of current network infrastructure and devices, gauge current levels of usage, and estimate the demands needed in the future. This assessment will help you determine which parts of the current infrastructure need to be replaced, upgraded, or supplemented.

The following seven questions can guide an evaluation of district Internet needs and capacity.



Hire the Best

If you are looking to hire a district technology lead/chief technology officer (CTO) or chief information officer (CIO), the Consortium for School Networking (CoSN) has a description of recommended skills for a K–12 CTO at <http://www.cosn.org/Framework>.

1. What is the vision for learning that technology will be supporting?

Bandwidth requirements depend on the role technology plays in supporting teaching, learning, and assessment within districts and schools. It's easy to be drawn in by flashy promotional materials and offers of discounts. Without first knowing what learning opportunities you want the devices and connectivity to enable, you'll never know if they were successful. Before making decisions about technology, schools and districts need to articulate how students will use technology to learn. Learning objectives should drive the technology implementation and not the other way around.



The benefits of putting learning first

In an effort to address long-standing academic issues, **Revere High School** in Revere School District in Massachusetts, implemented a school-wide blended learning model. Students, parents, and school staff post lectures, videos, and assignments online so the entire school community has access to needed information. Educators were provided with virtual tools to collaborate with school leaders on a regular basis, thereby receiving more immediate feedback, as well as access to online teaching resources that support professional development needs. The high school's student achievement results have been impressive, particularly compared to peer schools, including winning the 2014 High School Gold Award from the National Center for Urban School Transformation.⁶⁷ A robust investment in supporting teachers and leaders with technology-enabled tools can transform instruction and generate dramatic improvement in student outcomes.



Engage the Community

Community and stakeholder ownership is key to the success of any major school initiative. Involve stakeholders across all stages of planning and implementation by establishing transparent policies and procedures. Communicate these policies with stakeholders and, when possible, remain flexible and responsive to the needs of individual schools to implement their own practices (while defining and communicating the consequences of doing so).

As you begin to talk with students and instructional leaders, ask how they envision students using devices inside and outside the classroom. If part of the instructional plan is for students to use devices at home, then it is also important to have a realistic picture of how many students have reliable home Internet access. Surveying families through an initial home access inventory will reveal what percentage of students have access to broadband Internet at home and guide what you need to do to bring connectivity to all students.

As you better understand connectivity in your district, consider convening families and community leaders for discussions of digital equity. New plans for technology use and infrastructure within schools can provide the perfect opportunity to engage the larger community in conversations about what it means to be a connected community. *See page 52 for additional information about ensuring home access.*

2. What digital tools will be needed?

Get a baseline usage estimate by talking with students, teachers, and school administrators about how they currently use learning technologies. Augment these informal conversations by holding listening sessions or organizing standing advisory groups to ensure clear channels of communication. Outside your district, seek guidance from state assessment officials regarding projected testing demands on technology resources.

Consider how high-speed Internet access and new devices will create opportunities for new kinds of digital learning content and resources schools might not currently be using because of bandwidth limitations. Tasks like audio/video production and videoconferencing require large amounts of bandwidth, especially if used simultaneously by many students. Keep in mind other possible demands on your technology infrastructure such as administrative software, security, web hosting, and other applications that align with administrative needs and communications in schools. Plan to support resource uses as they are as well as how your district or school will adapt to unforeseeable technology demands down the road. *See Factors to Consider When Selecting Devices on page 44 for more information on digital learning resources.*

3. What kind of professional development will teachers and administrators need?

Districts can distribute devices and links to learning resources, but administrators and teachers might not use them unless they understand how they support their work. This will take time and training. Because educators differ in technology expertise and pedagogical knowledge, professional development should be designed to meet the needs of teachers at all levels – from the most traditional teachers to the earliest adopters of blended learning practices. This may mean different training for different administrators and teachers, combined with in-school and online professional learning communities. Consider [ISTE's standards](#) for administrators, teachers, and instructional coaches when designing your professional development expectations.

You will need to provide a significant amount of professional development to ensure that the transition is successful and lasting. While not the focus of this guide, ongoing, fully-funded professional development regarding use and research-supported practices for technology in learning and teaching is extremely important to any effort. See the U.S. Department of Education's *Future Ready Schools: Empowering Educators through Professional Learning* (tech.ed.gov/futureready/professional-learning) for more information on professional development planning using the many existing online communities and resources. In addition, opportunities such as [Connected Educator Month](#) can help teachers begin to join and create online communities and networks of practice.

4. How much bandwidth will be needed?

Your current Internet provider should be able to provide you with usage data for your school network (how much bandwidth is currently being used, at what time, etc.). If your school runs its own network, you will have network monitoring tools that provide a more comprehensive and accurate assessment of current bandwidth. It is a good idea to verify those data by running a web-based speed test such as those listed below. For districts without a current Internet infrastructure, set a target for connectivity speeds such as the ConnectED Initiative's target speed of 1 gigabit per second (Gbps) per 1000 students by 2018.

- **SchoolSpeedTest.org** calculates a network's usable speed—the amount of bandwidth while the network is in use.
- The **Smarter Balanced diagnostic tool** from the Smarter Balanced Assessment Consortium tests whether schools have sufficient bandwidth and browser capabilities to run the Smarter Balanced computer-adaptive tests. If your school is participating in the consortium, ensure you meet all the assessment requirements. Districts that are taking the PARCC or other online assessments should have capacity planning tools on their respective websites.

While speed tests are helpful in determining available bandwidth, they do not pinpoint which part of a network needs to be improved to increase its speed. In addition, precisely measuring connection speeds is difficult because actual speeds will vary based on such factors as the number of simultaneous users and software accessing the network. You get more exact data with a network monitoring service, which provides end-to-end monitoring of a network in varying conditions over time. Many different paths exist for getting high-speed connectivity to your schools. *See Section 2 on page 17 for more information on planning high-speed broadband pathways to your schools.*



Professional Learning Pathways

The San Diego County Office of Education's Professional Learning Center (PLC) provides county educators opportunities to learn more about instructional technologies through face-to-face workshops, blended courses, online courses, and a fully online Master's in Education Leadership with an emphasis in technology. All the blended and online professional development courses have university credit options provided through a partnership with San Diego State University. When planning professional development in conjunction with your educational technology resources, consider offering a variety of choices to enable teachers to personalize their learning as well.



Know Your Network

If choosing an independent vendor to manage your network, consider requesting network monitoring as part of your agreed-upon services. If you maintain your own network, you most likely are able to do network monitoring in house.

5. What will the needs of your in-school network be?

Some school buildings, especially older ones, may require special considerations as you build or improve your network to include high-speed connections. The best way to determine your schools' physical readiness is to have your technology support team or certified consultant conduct a network assessment. During this process, the team will note mechanical, electrical, and environmental conditions that will need to be addressed as you upgrade your network. For example, is existing network cabling sufficient or will new cable need to be installed? How many wireless access points does your school have now, if any, and where are they located? Beyond the network assessment, you may also want to consider other physical infrastructure questions such as whether each classroom has enough electrical outlets for charging devices. *See Planning Your Network on page 35 for more information on these and other network infrastructure questions.*

6. How many and what type of devices are needed?

Once a clear vision for the role of technology in learning and teaching has been established, two factors will help you determine and plan for how many devices your network can support. One factor is how many devices students and teachers can connect to the school network. When determining the number of devices, differentiate between devices owned by the school district and those that are personally owned by students and staff. A second factor is peak demand—the time(s) of day when the most devices are accessing the network simultaneously. This is often first thing in the morning or at the start of every class period. *See Getting High-Speed Internet to Schools on page 17 for additional information on estimating bandwidth needs.*

You also need to know what types of devices are currently owned and in use by the school—desktops, laptops, tablets, and/or smartphones—and when they will reach end of life. Even when you expand the actual broadband capacity in your school, older devices with slower processors might not be able to benefit from faster speeds and will need to be upgraded or replaced. *See page 48 for additional information on purchasing devices.*



Remember Personal Devices

Under a BYOD (bring your own device) policy, students may be permitted to bring their own laptop, tablet, smartphone, or other Internet-enabled device to school. When planning how much bandwidth your school will need, don't forget to account for these personal devices. High school students are most likely to own mobile devices (80%), but 65% of students in grades 6–8 are also smartphone users.⁸ A majority of teachers (52%), parents (57%), and district administrators (52%) now use a personal mobile device such as a smartphone.⁹ For most schools, the way that students and staff access the school Wi-Fi network with personal devices should differ from how they access the network with school-issued devices. *For more information on network planning, see page 35. For more about BYOD policies, see page 48.*



Assess Physical Needs Early

Upgrading your physical infrastructure can be expensive and time consuming, so it is best to determine whether this is necessary at your school and develop a plan to tackle the problem early.

7. What resources are available to fund the transition?

One of the most important resources available for the transition to sustainable broadband connectivity in schools is the Schools and Libraries Universal Service Support Program, also known as the E-rate program. The FCC's E-rate program provides discounts of up to 90% to help elementary and secondary schools and eligible libraries connect to the Internet and maintain internal connections. The highest discounts are provided to high-poverty schools and libraries, and rural schools and libraries can also apply for higher discount rates.

In recent years, E-rate funding requests have far exceeded available funding. On July 23, 2014, in response to the President's ConnectED Initiative, the FCC released the E-rate Modernization Order targeting funding to Wi-Fi networks in schools and libraries across the United States while ensuring support continues to be available for broadband connectivity to schools and libraries.

In addition to E-rate, some federal education grants may be applied to supporting the transition to digital learning. There are also some innovative cost-saving models worth considering. Some schools have partnered with other area educational institutions or even their town or city to pool bandwidth needs and create local or municipal networks that save all parties money. Each section of this Guide points to funding resources and suggestions specific to its topic. For a comprehensive list of connectivity funding resources, please see tech.ed.gov/funding/.

The next two sections discuss considerations in upgrading Internet connections to the school and within a school, respectively.

2 Getting High-Speed Internet to Schools

IN THIS SECTION

- Understanding types of available connectivity
- Four paths for connecting districts and schools
- Cost drivers and funding sources to consider
- Special considerations for rural areas

The U.S. Department of Education recommends a minimum connectivity speed of 100 Mbps and a target speed of 1 Gbps per 1000 students for schools by 2018.⁹ This translates to a per-student target of at least 1 Mbps to meet the 2018 ConnectED Initiative goal.^{10,11} This section gives an overview of the technical details associated with getting high-speed Internet to your school. It first reviews the wired and wireless types of connectivity and then outlines how those connectivity types are most commonly used to create high-speed pathways for schools. This section is designed to help you understand the most common models for connecting schools and districts to broadband so you can ask informed questions and identify which options are right for your district.

Definitions

Backbone describes the major network connections across the country. Think of them as the major highways of the Internet.

Middle mile Refers to the part of a telecommunications network that connects the Internet backbone and regional Internet service provider or district.

Last mile refers to the connection between the regional Internet service provider and individual school buildings.

Types of Internet Connections

Wired Connections

Wired technologies are faster and more reliable than wireless technologies for getting high-speed Internet to your district or school because they experience fewer threats to signal quality such as weather and geographic interference. The most common wired technologies are fiber-optic cable (known as fiber) and Data Over Cable Service (known as cable or DOCSIS).



The easiest way to take advantage of either of these options is to use wires that have already been installed. Although cable wiring is likely to be the most prevalent in your area and is less likely to require installation, fiber can be faster and more reliable and is often less expensive over a period of time, as its high capacity often means a lower price per megabyte. Installing fiber requires specialized training and equipment and often requires underground trenching or stringing the fiber from telephone poles to connect the Internet service provider (ISP) to the district.

Some areas are experimenting with ways to reduce fiber installation costs. A California executive order permits ISPs to install fiber at cost as part of any public works project that already requires an open trench in which fiber could be also laid. The cost to install fiber is substantially lower when the trench has already been dug or when fiber has been strung aerially for the majority of distance and trenched from the poles to schools.¹²

New installation techniques are also being piloted to reduce the cost of laying fiber. During microtrenching, fiber is laid into a slot less than 1 inch wide and about a foot deep.¹³

Consult closely with ISPs and check with utility and municipal institutions to understand all possible wired access and installation options in your area. When comparing the cost cable and fiber, consider the “total cost of ownership” (see below), and check with your local ISP because rates and availability vary by region.

INTERNET OVER FIBER

Fiber is the fastest and most reliable connection to the Internet. Most customers, including schools, do not own their own fiber (similar to telephone or electric lines) because owning it requires purchasing the property rights along the trench where the fiber is installed, which tends to make it cost prohibitive. Two frequently used options for getting fiber Internet access are leasing or obtaining a right of use contract.^{14,15}

An indefeasible right of use contract (IRU) generally provides complete use of a fiber line without any limitations for a long period of time. IRUs are often negotiated on terms similar to mortgages (e.g., 15–30 years) with a single payment up front. IRUs typically come from utility companies, telecoms, or railroads that maintain and service dark fiber. This means that fiber obtained through an IRU does not come with any of the network equipment required to activate it, and substantial up-front costs to “light” the fiber must be factored in. However, IRUs can result in significantly reduced long-term costs relative to leasing.

Definitions

Fiber-optic cable (fiber) consists of a thin cylinder of glass encased in a protective cover. It uses light rather than electrical pulses to transmit data. Each strand of the cable can pass a signal in only one direction, so fiber-optic cable must have at least two strands: one for sending and one for receiving data. Unlike Data Over Cable Service, fiber-optic cables are not subject to interference, which greatly increases the transmission distance. Fiber speeds are currently limited by the abilities of the equipment on either end of the connection. Some fiber connections allow for speeds up to 100 Gbps.

Internet Over Cable Service (cable) is Internet provided via cable TV networks. Currently, cable can enable download speeds in excess of 300 Mbps, depending on local infrastructure. The cable industry is working to increase downloading speeds up to 10 Gbps in the coming years.

With leased fiber, the owner retains the fiber and provides the district with the ability to use a certain amount of capacity based on the lease agreement. Similar to an IRU, unused dark fiber can be leased, requiring the district to provide the network equipment to activate the fiber. However, there are also options to lease fiber at a higher cost that already includes all the required equipment. Leases are usually shorter contracts of up to 1–5 years with monthly payments to the service provider. Districts can choose to use less than the full capacity of the fiber up front and pay for additional capacity later if it becomes necessary.

Either through an IRU or a lease, dark fiber can provide almost limitless future capacity at a marginal cost because the expense in increasing bandwidth generally comes from the network equipment that is connected to the fiber, not the fiber itself.



Check Total Cost of Ownership

When comparing prices of network connections, make sure to compare the **price per megabyte**, not just up-front costs. To calculate price per megabyte, add all capital expenses and recurring costs and divide by the number of megabytes received. For example, a 100- MB connection may cost \$100 per month, or \$1 per megabyte. A 10-GB connection may cost \$500 per month—a substantially higher monthly bill but resulting in a cost of only \$0.50 per megabyte. Keep in mind, however, that not every school needs a 10-GB connection. If a school is only using 1 GB but is paying for a 10-GB connection, it would be overbuying for its needs.



Definitions

Dark fiber is fiber optic cable that has already been laid, generally underground, but does not have the networking equipment on each end to connect to the Internet.

Indefeasible right of use (IRU) is a contract to use someone’s dark fiber for a long period at a low cost. A district that acquires fiber through an IRU is responsible for providing the equipment to connect (or light) the fiber.

Leased fiber is a contract between an ISP and a district whereby the ISP agrees to deliver Internet services using fiber owned by public telephone network or other provider. The connection fee is a fixed monthly rate determined by the distance and speed provided. Leased fiber can either be dark (as in an IRU) or include all the required network equipment.



Connecting via Fiber through Creative Approaches

In 2011, **Chesterfield County Public Schools** in Virginia had a network that was slow and unreliable, especially for remotely located schools, which prevented many teachers from using digital media with their students. As part of an ambitious district strategic plan to support blended learning, the district technology team designed and implemented a complete leased fiber network. The lease required the vendor to provide equitable bandwidth to all schools and administrative buildings. Because the new fiber network was more expensive than the previous approach, Chesterfield



Schools needed more funding than its existing E-rate discounts. The district decided to prioritize bandwidth over other technology expenses like accidental damage warranties on staff and student computers or support on old hardware. In addition, the district reduced print textbook purchases to fund the new digital content strategy. The staff agreed that the end result—a scalable and reliable network that supported blended learning in every classroom—was worth it.

Butte School District in Montana initiated a public-private partnership in 2013 with a fiber provider and the Montana Economic Revitalization and Development Institute to build a new network connecting the district office with all district schools.^{16,17} Originally, the district’s remote location meant schools were forced to use outdated telephone lines for their primary connection to the Internet. A slight improvement was made when Butte was able to upgrade to a shared fiber network providing a 10-Mbps connection. Unfortunately, 10-Mbps was still too slow for simultaneous online learning and assessment, leading to the creation of the public-private partnership. The district has an IRU with the telecommunications provider that built the network.¹⁸ Now all nine Butte schools have access to a 2-Gbps fiber connection fast enough to videoconference between classrooms, enable teachers to complete online professional development, and give every student simultaneous high-speed Internet access.

INTERNET OVER CABLE

Internet service provided over cable has the benefit of using the more prevalent existing cable infrastructure, which can reduce the initial cost of installation. However, if your district requires more bandwidth than the existing cable infrastructure can provide, options for increasing bandwidth may be limited.

Check with your provider to get a clear understanding of current capacity and potential expansion of bandwidth. Make sure whatever bandwidth level you negotiate is provided as a guaranteed minimum, and not just an “average” or “best-efforts” level.



Check Cable Capacity

Check with your cable provider for details on the maximum capacity available at your location. If it is not sufficient for a primary connection, cable still may be a cost-effective backup solution.

When negotiating agreements for cable connectivity, include terms setting clear understandings of how changes in bandwidth pricing will affect your district. One such option is a multiyear lease with the ability to renegotiate bandwidth and price structure annually.

Wireless

In some areas such as rural regions that span great distances, neither fiber nor cable service is available. In those situations, your district will need a wireless solution such as fixed wireless, mobile broadband, or a satellite Internet connection.

FIXED WIRELESS

Fixed wireless options (sometimes called WiMAX) often require erecting towers and installing wireless transmission/receiver platforms to carry the signal from place to place (thus the term *fixed* wireless). Each requires a clear line of sight between the tower and the school (or directly between two schools if there is line of sight between them). Generally, wireless options provide a lower speed at a higher price per megabyte than wired options, and not all options will be available in your region. Fixed wireless is generally much faster to set up than fiber or cable, especially where district-owned buildings are in line of sight to each other. Fixed wireless connections are subject to a small amount of latency, similar to being on a phone call with a bit of a delay. This may create challenges for students who are using videoconferencing or other real-time interactions.

MOBILE BROADBAND

Mobile data services, like those that provide the data service on smartphones, may be available under limited circumstances where schools may have rights to a wireless spectrum based on existing educational spectrum licenses from the FCC. These licenses were historically issued by the FCC to educational agencies around the country under the Educational Broadcast Spectrum program. While the FCC is not currently granting any new licenses, the Commission is developing a new mechanism for education organizations to apply for this type of connectivity where it is available. As with fixed wireless, mobile wireless users will experience a small amount of latency.



Leverage ConnectED Partners

Many private [ConnectED Initiative](#) partners are offering schools mobile connectivity services as part of their commitments. These connections can follow students home, providing access outside school.

SATELLITE INTERNET

Satellite service is a type of wireless connection for schools where cable or fiber is not available. Satellite Internet requires a good line of sight from the school to the correct orbiting satellite. When terrain or frequent bad weather makes other wireless solutions impossible, satellite may be the only feasible option. Of all the wireless options, satellite tends to be the most expensive per megabit per second. It also typically includes monthly usage caps and limited maximum download and upload speeds. Satellite connections are subject to significant latency due to the distance the signal must travel to connect to the satellite. This means that satellite connections may not allow for real-time services such as videoconferencing.

If multiple wireless options are available in your area, know that each comes with its own trade-off between speed, stability, and cost. Because wireless connections are subject to more environmental interferences than wired connections, service can be disrupted in areas with rough terrain or in bad weather.

Given the various capabilities and restrictions of fixed wireless and satellite technologies, be sure to compare services before deciding on a provider by determining price per megabyte, latency, environmental issues, and any bandwidth usage limits.



Definitions

Fixed wireless can currently provide speeds up to 1 Gbps, is suitable for portable mobile broadband connectivity and cellular backbone as an alternative to cable, and can deliver data, Voice over Internet Protocol (VoIP), and Internet Protocol Television (IPTV). WiMAX comes in two forms: mobile and fixed. Mobile connects buildings to user devices, and fixed connects buildings together. When considering WiMAX, look for industry certification regarding WiMAX standards to ensure interoperability with other certified products.

Mobile broadband is wireless Internet access from cell towers via a mobile phone, tablet, or portable modem. Mobile broadband (also called 4G or LTE) can provide high-speed connections up to 1 Gbps for downloading and uploading over the same network infrastructure wireless carriers.

Satellite Internet can provide fixed, portable, and mobile Internet access with data rates of up to 1 Gbps downloading and up to 10 Mbps uploading. Satellite broadband is among the most expensive forms of wireless Internet access, but it can provide connectivity in the most remote areas where no other connectivity options exist. Best performance requires a clear line of sight between the satellite and the antenna at the connecting building.

Approaches for Connecting Schools

Once you understand the types of Internet connections available, you are prepared to consider the best approach for getting that access to your district. Possible pathways are described below, along with associated pros and cons of each, to help you decide which path is right for you.

In your approach for connecting your school, you can plan for additional speed and reliability through multiple connections or by contracting with multiple Internet service providers (ISP). This can keep your network functioning in the event that any one ISP experiences an outage or a connecting line is cut. Multiple connections can also allow for connectivity speeds beyond your baseline goal and increase the area within which students and teachers can connect to your network.

Path 1: Schools Connect Through the District to Research & Education Networks

Research and education networks, called R&E networks or RENs, are high-speed wired networks independent of the commercial Internet. They are run by state or regional consortia and were originally developed to meet the needs of academic and research communities.

RENs vary in their funding and operating models but generally offer the same benefit to their members: low-cost connectivity achieved by aggregating demand. RENs are typically funded by a combination of government and member fees.¹⁹ Thirty-one states offer their RENs to K–12 districts and schools.²⁰ These are usually fiber connections, although schools in rural areas may also connect wirelessly.

All state RENs are supported by either a national consortium or regional RENs. This structure allows REN members to save money by pooling bandwidth across more users. Another advantage to RENs is the ability to access content stored within the network at a lower cost because users do not need to access the Internet outside the REN. For example, if an online video collection is housed at a university that is part of the REN, the schools can download those materials without having to pay for access to the Internet. This provides a cost-effective solution for normal usage while giving members the ability to occasionally spike Internet usage for short periods, such as for assessments and software updates.



Definitions

A **Wide Area Network (WAN)** provides the connection *between* the district office and all the schools and sites within a district. A WAN may also connect to other educational institutions (such as universities and libraries) if your district is part of a regional education network.

A **Local Area Network (LAN)** is the network *within* a school or district building through which computers and devices connect to the Internet. LANs, in contrast to WANs, service much smaller geographic areas.



Find RENs

Not all districts are located near a REN connection point. To find out if a REN is located nearby, go to this website:
<http://www.internet2.edu>.

If a REN is available in your region, compare the speed and cost of it with those of the other paths described below.

Illustrated below are schools connecting through the district to a REN. Note that the REN uses multiple ISP connections to pool bandwidth for members and provide redundancy should an ISP experience an outage.

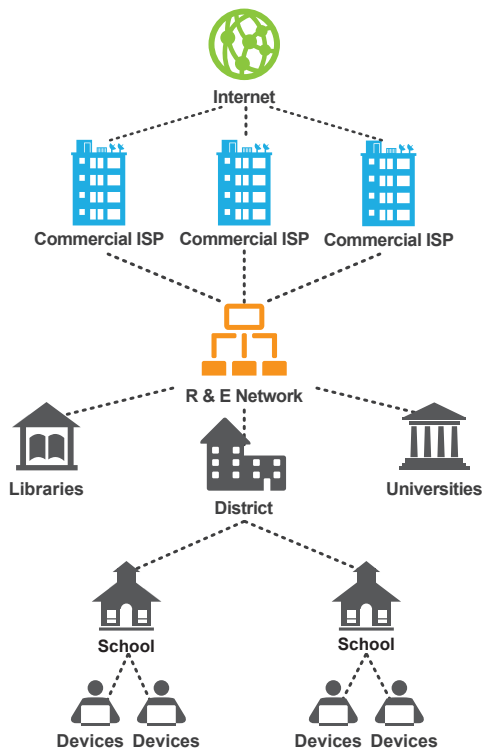

Where this path makes sense:

If your district or school is in an area where you have access to a state-operated network, this may be the most cost-effective way to connect to high-speed Internet.

Pros

- Can be cost-effective because RENs can negotiate lower costs by purchasing Internet access on behalf of all institutions in the REN.
- If your REN has the ability, additional capacity can be added for short periods of time when usage is expected to spike (such as during assessments).
- With fiber RENs, increasing bandwidth can be accomplished at a fraction of the cost of the initial setup.
- Hardware and services such as firewalls, security, and content filtering can be centralized at the district level, which simplifies management and avoids increased costs from multiple purchases.
- Greater reliability exists on RENs because they use multiple Internet service providers at the same time to manage information loads.
- Content providers may house content within the network so the need to pay for bandwidth to access content outside the network is reduced.

Cons

- Up-front costs for building a connection from a district to the REN can be high.
- A high-speed WAN connecting the district and schools must already exist (or be constructed) for this approach to work.
- A high-speed LAN must exist for distributing the Internet access from the WAN throughout the school.
- Because of funding models for consortia, costs may vary with usage rates, which can make projecting long-term cost difficult.
- Accessing content outside the REN (on the Internet) can have restrictions in addition to a metered cost beyond recurring membership fees.



Research & Education Networks in Action

The **North Carolina Research and Education Network** (NCREN), one of the first statewide RENs in the country, provides high-speed Internet to all K–12 districts as well as higher education campuses and academic research institutions across North Carolina.²³ Whereas NCREN was primarily funded by in-state resources, the state took advantage of two Broadband Technology Opportunities Program grants through the Recovery Act and Race to the Top to expand its network and cloud infrastructure.²⁴

Network Nebraska provides 232 districts and more than 350,000 K–20 students with Internet access that supports a statewide videoconferencing service and e-learning courses. The network purchasing consortium aggregates and shares bandwidth demands for groups of districts so that they can peak demand when needed without paying extra costs. For example, one group of 92 districts in the northeast part of the state cooperatively purchases Internet capacity of 3 Gbps per month.²² Network Nebraska has been able to provide 94% of Nebraska school districts with high-speed Internet connectivity.²² Network Nebraska cooperatively purchases its core routers with the University of Nebraska and leverages state master contracts for its last mile connections (the segments that connect the network backbone to the school). This aggregated demand lowers the cost of connecting schools.

The **Utah Education Network** (UEN) is a statewide, publicly funded partnership between the state's education institutions and local telecommunications providers that connects all of Utah's K–12 schools, colleges, and libraries to the Internet. UEN also offers its members Internet filtering, network support, and a learning management system.²¹ The foundation of the UEN is a high-capacity fiber backbone. Smaller fiber segments connect the core backbone to WANs, which in turn connect the state's colleges and universities to the Internet. Ninety percent of the state's K–12 districts connect either directly to that backbone or indirectly through the colleges and universities. Most public high schools and middle schools connect at 100 Mbps, with some connecting at speeds up to 1 Gbps.²¹

Path 2: Schools Connect Through District to Commercial ISP

On the second path, your district buys bandwidth from a commercial ISP. The ISP creates a high-speed backbone to a centralized district connection. This type of connection is called the middle mile. Schools connect to the Internet through the district WAN. This is similar to RENs, but instead of being part of a consortium of other state institutions, districts connect directly to a commercial ISP. Districts can contract with their ISP or another entity to build the infrastructure for their schools' WAN if they do not have the internal capacity.

Illustrated below is the path of schools connecting through the district to a commercial ISP.

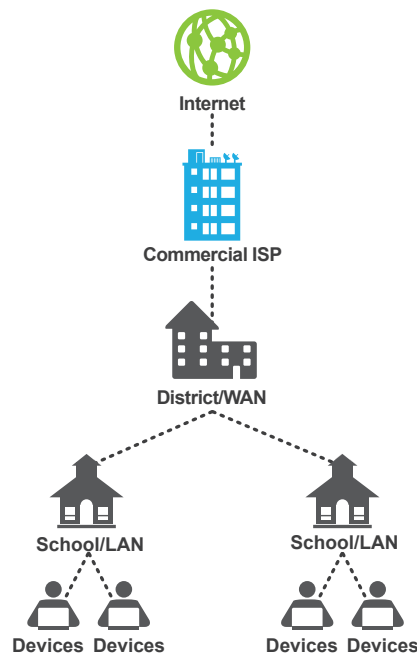

Where this path makes sense:

If your school is in a medium to large district where the district can exercise bulk purchasing power—and a local REN does not exist or offer the most cost-effective connectivity—this may be the most cost-effective option for you.

Pros

- This can be cost-effective because districts can negotiate lower costs by purchasing Internet access on behalf of all schools in the district.
- If your ISP has the ability, additional capacity can be added for short periods of time when usage is expected to spike (such as during assessments).
- By pooling capacity, large schools benefit by sharing the cost of anticipated usage spikes while smaller schools are able to take advantage of the cheaper rate offered with high-volume purchasing.

- Hardware and services such as firewalls, security, and content filtering can be centralized at the district level, which simplifies management and avoids increased costs from multiple purchases.
- The ISP may subsidize the cost of establishing the infrastructure to the district with a longer contract.

Cons

- Up-front costs for building a connection from a district to the ISP network can be high.
- A high-speed WAN connecting the district and schools must already exist (or be constructed) for this approach to work.
- A district must contract with multiple ISPs in order to have redundant secondary or tertiary Internet connections should one experience an outage due to malfunction or a severed cable.
- A high-speed LAN must exist for distributing the Internet access from the WAN throughout the school.
- This approach lacks the purchasing power and possibly the redundancy of a larger REN.



A District's Direct Path to Its ISP

Forsyth County School District, north of Atlanta, Georgia, serves approximately 42,400 students and is growing at a rate of 1,600 students per year. The district has 35 physical schools and an online school for grades 6–12. The district and schools are connected through a redundant fiber network, with a managed 1 GB connection through one ISP and an additional leased fiber connection that the district manages. In addition to the approximately 500MB connection provided by the state, the district contracts for Internet access from two separate ISPs for an aggregated 2.5 GB of total bandwidth.



Forsyth's approach has the advantage of multiple ISPs, which allows rerouting of Internet traffic should one ISP experience an outage. Because network management is centralized at the district level, fewer firewall and filter appliances are required. Purchasing bandwidth at the district level enabled the district to negotiate more competitive pricing than purchasing Internet access individually for each school. By incorporating redundant connections from school sites to the data center and maintaining redundant connections to the Internet from the district office, the district is well protected from Internet outages interfering with lessons.

Path 3: Schools Connect Directly to Commercial ISP

In the third path, schools connect directly to the ISP for broadband access rather than through a district connection. The ISP manages and maintains the connection right to the school. This can be a more expensive path to connectivity because it has limited opportunities to take advantage of economies of scale. The district is still responsible for providing a LAN for distributing connectivity to classrooms and throughout the building as in the other paths, but it does not have to worry about creating a connection to the district or to the ISP.

Definition

Virtual private network (VPN) encryption software enables computers to connect with each other across a public network as if they were connected to a private, secure network.

Illustrated below is the path of schools connecting directly to a commercial ISP.

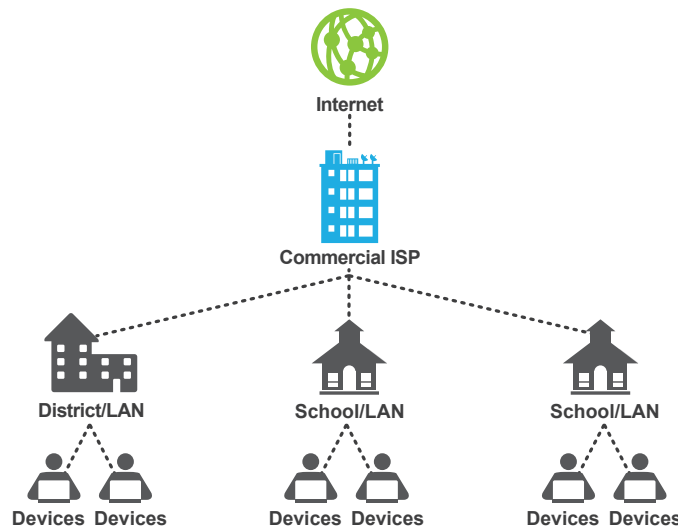

Where this path makes sense:

If your school lacks the purchasing power of a big district and the ability to operate its own WAN, and if a local REN does not exist or offer the most cost-effective connectivity, this path could be right for you. For schools in geographically remote locations, this may be the only option.

Pros

- Schools can negotiate variable usage agreements to accommodate spikes in demand.
- Districts are not responsible for maintaining a district network because the ISP connects directly to the school.
- Direct ISP-to-site connections mean that an interruption in connectivity for one school or district building does not result in an interruption for the entire district.
- The ISP may subsidize the cost of establishing the infrastructure to the district with a longer contract.

Cons

- Up-front costs for building a connection from the schools to the ISP network can be high.
- A high-speed LAN must exist for distributing the Internet access throughout the school.
- The district must contract with multiple ISPs in order to have redundancy.
- This path lacks the purchasing power of either RENs or district-purchased Internet access.
- This path has no redundancy should the ISP experience a network outage.
- Without a central district network, this path lacks the capacity to store heavily used content internally.

Path 4: Devices Connect Directly to Commercial ISP

In the fourth path, a district leases mobile broadband wireless services from an ISP, which then provides high-speed Internet access directly to student devices. The key advantage to this approach is that it does not require students to be connected to a school network and can function anywhere that cellular service is available. Although this approach can be used independently of the other three paths, it is typically used to augment a school or district network to provide connectivity when students are not in a school building. In this approach, devices do not connect to the Internet through a school network (LAN), so content filtering or security settings would have to be implemented by the ISP.

Not all devices are compatible with mobile broadband, so it is important to check on device options when considering this approach. Often, service providers will offer discounts on device purchases when you are purchasing data plans.

The major downside of this path is that it can be extremely expensive at large scale and does not offer the connectivity speeds required by some learning resources. It is the newest of the four paths for connecting to the Internet and thus is still evolving.

Until speeds and costs improve, this path can be used as a supplement at schools that have a wireless connection within the school (using one of the other paths) to provide students with equitable connectivity outside school.



Provide Home Access Equity

Schools that encourage off-campus use of school-owned mobile devices should explore Path 4 when students' home Internet connections are not available or sufficient.

It is possible, as technology and capacity increase over time, that this approach will become more economical.

The illustration below shows this path in use, providing a connection directly to student devices when outside of school and students connecting to school-provided wireless when inside school.

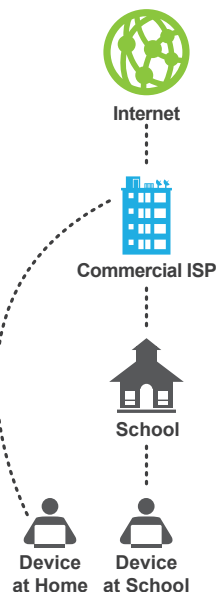

Where this path makes sense:

If your school lacks the purchasing power of a big district and the ability to operate its own WAN, and if a local REN does not exist or offer the most cost-effective connectivity, this path could be right for you. For schools in geographically remote locations, this may be the only option.

Pros

- Internet connectivity can be provided to students off campus.
- Districts are not responsible for maintaining a district or school network because the ISP connects directly to the devices.
- There are no upfront construction costs.
- The ISP may subsidize the cost of devices for the district with a longer contract.

Cons

- This path can cost significantly more than others.
- There is no ability to contract with multiple ISPs to have redundancy.
- This path lacks the purchasing power of either RENs or district-purchased Internet access.
- This approach will work only with devices that support mobile broadband.
- This path does not support Internet telephone service (VoIP). *See Section 3 for additional information on VOIP.*
- The potential for vendor lock-in is high because it is not easy to change mobile broadband providers as technology varies from one provider to another.



Connecting Student Devices Using Mobile Cellular Broadband

Located in the Sierra Nevada mountain range, **Lake Tahoe Unified School District (LTUSD)** is a rural district of six schools, with 60% of students qualifying for free or reduced-price lunch. Lake Tahoe wanted to provide connectivity to students at home, as well as at school, so the mobile broadband solution was appealing.

LTUSD partnered with a commercial 3G mobile broadband provider and device vendor to supply netbooks to 3,000 students in grades 3–12.²⁵ Each computer is equipped with Wi-Fi and a 3G wireless modem. LTUSD provides in-school and home Internet connectivity by permitting students to connect to Wi-Fi and 3G networks managed by the mobile broadband provider.

The district wanted to deploy the devices without overburdening its small IT staff, so the mobile broadband provider also is responsible for content filtering in conjunction with district IT staff. These vendor relationships permit LTUSD to provide students with connectivity without having to continuously update IT staff on latest technologies.²⁵ The district estimates that the implementation plan for all costs, including staff development and operating expenses, will total approximately \$600,000 per year.²⁶ While some of the materials were paid for using bonds, other components of the technology implementation, such as the connection to the ISP, were paid for using general funds, categorical funding, and E-rate.²⁶

Major Cost Drivers

Actual costs will vary widely from district to district based on local circumstances. As you are generating comparisons of the total cost of ownership of the network, the following factors will most likely have the greatest impact:

- How many devices and which digital learning resources your network must support
- The capacity and age of your physical infrastructure, including conduits, cables, and wireless access points
- How much of your existing equipment can be used in your new network
- The distance and geographic difficulty (terrain, weather) of connecting your school buildings to the Internet
- The paths for connecting that are available to you (joining an REN, leasing dark fiber, etc.)
- The level and type of security measures you need to provide.

Two cost drivers many schools underestimate are those for human capital and ongoing network monitoring and maintenance. Human capital costs include the time, personnel, sustained professional development, and expertise to manage the network and provide technical support for teachers, staff, and students. Staff can include consultants to assist with technology planning, set-up, and testing. When you are calculating the total cost of operating your network, be sure to inquire about which services are included and which the district would need to provide to make sure you are comparing like services.

Ongoing network monitoring and maintenance costs include the following:

- Network management and monitoring
- User help desk/technical support
- Maintenance and upgrade of devices and equipment
- Insurance for devices
- Estimates of future demand
- Licensing fees for digital learning content
- Security filtering
- Network redundancy.

As your district transitions to greater connectivity, some costs can be redirected to help support the new costs. Schools have redirected funding that had been used to pay for textbooks, printers, copiers, and computer labs to help cover the cost of network and mobile devices.

The demand for network speed and capacity will continue to increase over time. Build a network that can be improved rather than one that will require an entirely new network at the end of your contract in order to meet future demands. Consider the absolute maximum speed of your network, the maximum number of devices you can accommodate, and your ability to take advantage of falling bandwidth prices if you enter into a long-term contract.



Save Costs and Bandwidth Through Caching

One way to reduce overall bandwidth fees is to relocate content on the Internet into local caching proxies. A **cache** is a special high-speed storage mechanism that can be either a reserved section of main memory or an independent high-speed storage device. High-use content can be accessed from the cache multiple times without going back to the Internet for downloading. This tactic helps reduce costs for schools and can lower delivery costs for content providers. Caching proxies can be located within REN, with private third-party services, or at the district level. You may also consider inquiring about hosting content from frequently used services to lower bandwidth use. Districts can further reduce costs by installing caching proxies within their LANs. Consider a class of 30 students, all of whom need to review the same video lesson. Instead of being downloaded 30 times, the video is downloaded once and redistributed from the local cache to each student's device.

E-Rate Funding for Internet Connectivity

The Schools and Libraries Universal Service Support Program, often referred to as E-rate, makes telecommunications and information services more affordable for U.S. schools and libraries. Mandated by Congress in 1996 and implemented by the FCC in 1997, the E-rate program provides eligible schools and libraries with discounted telecommunications, telecommunications services, Internet access, and internal connections.

The FCC has modernized the E-rate program—one of the largest financial resources available for schools to transition to broadband. The 2014 E-rate Modernization Order intensified focus on the greatest and most urgent need—closing the Wi-Fi gap—while transitioning support away from legacy technologies to advanced broadband connectivity. The changes to the program are expected to ensure greater access to E-rate support to connect 10 million students a year to 21st century educational tools and target an additional \$5 billion for Wi-Fi services over the next 5 years.

The FCC established the following goals as guidance in its modernization efforts:

1. Ensuring affordable access to high-speed broadband sufficient to support digital learning in schools and robust connectivity for all libraries
2. Maximizing the cost-effectiveness of spending for E-rate–supported purchases
3. Making the E-rate application process and other E-rate processes fast, simple, and efficient.²⁷

Special Considerations for Rural Areas

Rural areas often have unique challenges to getting high-speed Internet to their schools. Delivering high-speed bandwidth to remote districts and schools may first require improvements to the region’s network infrastructure before it can become available to the district. Connecting remote regions can be challenging because of physical obstacles as well as land-right usage. The Navajo Nation Telecommunications Regulatory Commission noted that the barriers for its tribe in obtaining



Supplementing E-Rate with State and Local Efforts

The **State of Maine** pays for broadband in schools using a fee of up to 0.7% on telecommunication services, similar to the Federal Universal Service fund, called the Maine Telecommunications Education Access Fund (MTEAF). The Maine Public Utilities Commission collects this fee on phone bills and then disperses it to the statewide broadband network to pay for the non-E-rate portion of the cost of broadband. The MTEAF was the result of legislation passed in 1999 authorizing its creation by the Public Utilities Commission. Other states such as Georgia, Iowa, and North Carolina allow counties to enact similar paths using taxes rather than fees to finance technology for student learning.²⁸ Typically, the tax is for a limited number of years, after which it must be reapproved by a vote or it will expire.



Mobile Wireless Hotspots Providing Connectivity Outside of School

Sunnyside Unified School District in Tucson, Arizona, is an example of a district pursuing strategies to connect students when they are off campus. Although 86% of students are low income and many lack Internet access at home, the district is one of the few in the United States to move entirely to digital textbooks.³¹ To provide access, school buses are equipped with mobile wireless hotspots, enabling students to access the Internet and do homework on the way to and from school.³² Through a partnership with the Native American Advancement Foundation,³³ the district is increasing mobile learning opportunities for children in remote villages in the nearby Tohono O’odham Indian Reservation. Sunnyside outfitted a used City of Tucson van with the same wireless hotspot equipment that is on the school buses, and the van travels daily to a new village in the reservation to provide access to students. *See Home Access in Section 4 for more information on other strategies districts are using to increase student home access.*



high-speed Internet include a lack of adequate physical infrastructure, which is difficult to build because of “complications with land status, rights of way and building regulations.”²⁹ These challenges can lead to schools in rural areas paying significantly more per megabyte than suburban and urban schools.³⁰ Despite these difficulties, rural districts are succeeding in developing innovative approaches to providing teachers and students with the connectivity they need within and beyond schools.

Many communities have succeeded in creating low-cost fiber systems that benefit schools, local government, businesses, and residents. These involve partnering with municipal governments to engage in community-wide rollout of increased broadband access in schools, libraries, government buildings, and other public places. While these efforts can require years of coordination and planning, the costs are often offset for school districts and other local stakeholders by lower bandwidth cost once the networks come online. Collaborating with municipal governments can reduce the cost to schools and districts of establishing and maintaining broadband connections because they are shared over a wider number of users. Some districts work with housing developments, development groups, and city government to bury fiber optic cable for schools when they are digging trenches for construction.



Districts and Municipalities Building Networks Together

For years, **Craven County School District** in rural North Carolina faced difficulties providing the connectivity required to support learning. The district was too far from the state’s REN to make that a viable option. Nor could the district afford an upgraded WAN to connect to its schools because of the high cost of wired and wireless options. The existing WAN and 25 Mbps connectivity conditions could not support services such as multimedia streaming, video conferencing, and centralized web servers. In 2005, Craven County Schools began exploring the possibility of constructing its own fiber optic network by learning where fiber already existed in the county and identifying potential partners. The nearby cities of Havelock and New Bern had already constructed municipal fiber optic networks. Craven County Schools initiated a partnership with Havelock and New Bern, Craven Community College, and Craven County Government to build shared infrastructure.

The local board of education told the district that it would fund the project as long as it found a favorable comparison between the total cost of ownership and current leasing costs. The district, of approximately 15,000 students across 695 square miles, was paying nearly \$350,000 per year to lease telecommunications services. The partnership achieved substantial savings by working directly with fiber manufacturers, paying \$1.2 million for its 76 miles of fiber and accompanying infrastructure. In addition, the groups developed a consortium agreement and a memorandum of understanding to outline responsibilities. The project was completed within 18 months, and the network has been operational since early 2009.³⁴ Internet connectivity will ultimately be expanded to 100 MB and beyond for the schools.

For Craven County, one of the most important lessons learned was the challenge of communicating between and within different agencies.³⁵ School officials are still getting calls today on how to get county and municipal governments to talk to one another.³⁴ Their advice is to start meeting early with city, county, and community college officials. In addition, the group has been well organized and planned for maintenance. Because the district designed and built the network, staff also know how to maintain it, which saves maintenance costs.

3 Getting High-Speed Internet Throughout Schools

IN THIS SECTION

- Providing wireless access in your schools
- Network planning
- Physical infrastructure considerations
- Network provisioning, configuration, and management
- Managing risks

High-speed Internet in your district becomes useful when it is available in all places where teaching and learning are taking place. This section presents information to help you understand what factors are important and what questions to ask as you design your school networks.

Planning Your Network

While the fastest way to get an Internet connection to schools is typically with a wired connection, wireless access within school buildings is the best way to connect students and staff. Wireless access throughout all learning spaces enables students and staff to have mobility and flexibility when engaging with learning devices, such as tablets, laptops, and smartphones. The first step in creating or upgrading wireless access in your school is to identify who will be using the network and for what purposes. This will help you determine the number of connections you need to support as well as the amount of bandwidth required in each location. Knowing this, you can decide on the physical location for access points throughout your school. To meet demand, it is also important to conduct a network assessment to determine how many access points are needed



Definitions

Wi-Fi is a wireless network connection using one or more of the IEEE 802.11 network specifications that carry a “Wi-Fi CERTIFIED” seal of approval from the Wi-Fi Alliance. “Wi-Fi ac” is the current generation of Wi-Fi certified devices. Devices with a “Wi-Fi CERTIFIED n” designation are from the previous generation (and therefore are usually less expensive—and slower—than ac devices). A Wi-Fi channel is one frequency within the Wi-Fi spectrum. Most Wi-Fi networks have approximately 11–15 channels.

A **wireless access point (AP)** is a device that allows wireless connections to a wired network using Wi-Fi or a related standard wireless network protocol.

Ethernet is a family of networking technologies for LANs. Ethernet standards are most commonly provisioned with twisted-pair and fiber optic cable. When twisted-pair is used, CAT 6a cabling is required to support speeds up to 10 Gbps. For fiber optic cable, there is a range of Ethernet standards to support a variety of distances over 300 feet and speeds in excess of 100 Gbps.

throughout the school building. If your district lacks the capacity to do this, a professional network designer can help.

Wireless signals are influenced by environmental factors such as radio frequencies, electrical interference from power sources, and building design and construction, so the placement of access points is important. A network assessment

will provide you with recommendations for the location and capacity of access points that need to be installed. Knowing the number of devices that will connect to the network, as well as anticipated use for each location in the school, is necessary to make the determination. When performing the network assessment, it is helpful to test some of the actual devices you are considering using if they are available.

Wireless signals have difficulty passing through concrete walls and are subject to interference from such sources as Bluetooth devices or microwave ovens. Check for interference at different times of day and on different days as part of your network assessment. It may be that interference from devices peaks at a key time during the day, requiring an increase in access points to compensate.



Leverage Outside Organizations for Help

For more specific guidance on conducting a site survey, both CoSN and Education Superhighway have resources on their websites outlining allocation of resources and options for external consultation.



Remember to Count All Devices

As **Burlington High School** in Burlington, Massachusetts prepared to provide mobile devices for just over 1,000 students, school staff did their homework in creating a wireless infrastructure. A vendor completed a network assessment to provide the school with the correct number of wireless access points for the 360,000-square-foot campus.

On the first day of school, however, Burlington's CTO came to the quick realization that students' personal devices had not been considered in the network assessment. Burlington was not actually a 1:1 (device-to-student) school, but a 2:1 or even 3:1 school when considering all the personal devices being used on the network. This created limited access to the network and was particularly problematic for classrooms near the cafeteria, where 500 students regularly attempted to access Wi-Fi during lunch from their personal devices. District IT staff were able to make the necessary adjustments to wireless access points to support the actual number of devices. Burlington's experience offers an important lesson: Consider every device that will be using the network, not just the devices provided by the school.



Consider All Physical Aspects of the Network

There are a number of components to consider when planning to create or upgrade your network, including:

- **Electricity**—What elements of the network require external power? How many outlets are required to meet these needs? Will a generator be necessary to support the network in the case of a power outage?
- **Cabling**—How far from where the network enters your school will the access points be installed?
- **Access points**—How will your school conduct a proper site survey to determine both the number and types of access points? In general, at least one access point per classroom is a good rule, but precisely how many will depend on the hardware selection. Larger rooms (e.g., cafeteria) will require more access points. Will a consultant assist with this process?

DETERMINE WIRING NEEDS

Once you have a high-speed Internet connection to the school, it is critical to have internal cabling to distribute the connection to all classrooms and learning spaces such as cafeterias, gymnasiums and other common areas. Even if a high-speed connection exists to the school, students and teachers will be able to take advantage of it only if updated cabling is in place to bring the bandwidth to the wireless access points. Fiber or CAT 6a cabling is recommended for in-school networks. If the signal must travel more than 300 feet, you will need to use fiber or add repeaters to strengthen the signal. Cables designed to be run through drop ceilings (known as plenum cables) are subject to special fire-safety standards for flammability and smoke density. A licensed electrical or telecommunications contractor can advise you on the relevant codes for your location and type of installation.



The Speed of the Entire Network Matters

To get high-speed Internet connectivity from where it enters the building to classrooms, every segment of the network must be able to accommodate high speeds. Even if a school is connected to the Internet via fiber, if the network inside the school is outdated, students will not experience high-speed connectivity in their classrooms. In short, the slowest segment of your network determines the speed of the network downstream from that point. Be sure to check that the equipment connecting each network segment at least meets your minimum speed requirements. Routine inspection and continuous monitoring of the network will help you identify misconfigured and/or failing equipment, inferior or damaged cables, or radio interference that is causing dropped connections. Internal or consulting IT experts can help you define a strategy that best fits your installation.

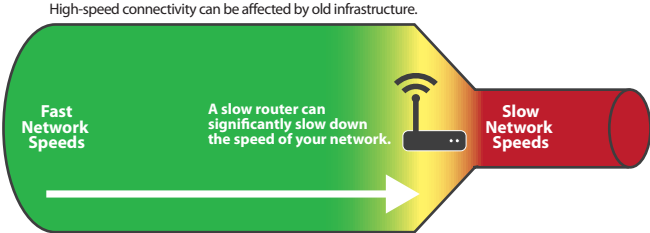

CONSIDER PHONE REQUIREMENTS (VOIP)

Voice communications should also be considered when planning a network. VoIP technology enables schools to use the same network that provides Internet access to provide phone service. This approach eliminates the cost of maintaining a separate phone system and can reduce the amount of cabling needed throughout the building. When planning your network, additional capacity and cabling should be factored in if you plan to support VoIP.



Register with E911

In order for emergency service providers (such as 911) to determine the location of calls made over VoIP, the address of the phone must be registered manually. Schools must ensure their provider is properly registering the handset's physical location information with the E911 registry if they are using VoIP phones.

IMPORTANT QUESTIONS TO ASK

When designing a network for a school, several operational and logistical questions should be asked and answered by the team planning and implementing the network:

- **Intrusion detection** – Are automated alerts in place if software is acting malicious or someone is unlawfully accessing the school network?
- **Security** – Is network equipment safe from theft, vandalism, and physical hacking?
- **Firewalls** – Are you able to restrict what data enter and exit the school network?
- **Load balancing** - Can you ensure that school/district network resources scale to meet student and staff needs?
- **Content filtering** – Are tools in place to restrict access to inappropriate content while still permitting access to all learning tools?
- **Network management** – Will the network be required to initiate wireless software updates to connected devices?
- **Mobility** - Is the network configured so that students can remain connected even if they move to different physical locations in the building?
- **User log-ins** - Will users need to log in to access the network? Does the network hardware support the kinds of log-in services you want to offer?



Compare Costs

Having a comparison against which you can measure your network design and cost can be helpful. Look to the [Analysis of Costs to Upgrade and Maintain Robust Local Area Networks for All K-12 Schools](#) by CoSN and Education Superhighway to compare your plan with that of others who have gone before you.



Definitions

Content filtering is the ability to screen content traveling over the network in real time and either restrict access to a resource or censor content. For example, schools should filter access to sites known to contain inappropriate content. Schools should perform due diligence to censor/flag potentially restricted content.

A **firewall** is a physical hardware device that acts as a gatekeeper on the network, restricting access into and out of the network based on a predefined policy.

An **intrusion detection system (IDS)** is a service used to identify security threats within a network. These solutions alert the operator to suspicious files, processes, and configurations on a network.

Load balancing is the ability to adjust the network to scale access to resources on demand. Load balancing provides equitable access to network resources.

Log-in services validate identity so a user can gain access to a computer system or other technology.

Network management refers to the activities, methods, procedures, and tools that pertain to the operation, administration, and maintenance of networked systems. This includes the management of access points and other devices that constitute the network.

Quality of service (QoS) is used to prioritize certain types of network traffic over other types, such as traffic to online assessments and learning management systems over content sites to ensure students have the best access available to most important content.

Student mobility refers to students needing to move without losing connectivity within a wireless network as they relocate each period or block.

Configuring and Managing Your Network

Having a plan for configuring and managing your school network will position you to better respond to issues as they arise. The information presented here can help you consider which options are best for your network and know what features and services to ask for.

Consider purchasing commercial-grade equipment. While small office/home office-grade equipment may be easier to obtain and lower in cost, it may not offer key features that will reduce your overall ownership costs. Features you will probably want in whatever device model you choose include the abilities to update device control programs remotely, update the configuration



SOHO for Mobile Labs

Compared to commercial-grade equipment, an unmanaged small office/home office (SOHO) wireless access point might be acceptable for a laptop cart, in a mobile lab where equipment is moved around frequently, or for an ad hoc event like providing a temporary wireless bridge for a sporting event. If you use a SOHO in addition to your main network, make sure filtering and security settings are in place to protect users.

of devices en masse rather than one by one, connect all devices to a single monitoring system, provide an access point on more than one Wi-Fi channel, provide log-in capability to a central log-in server (make sure the device supports the log-in technology you plan to use), and provide virtual LAN (VLAN) routing on a per-user basis (so students can use the same router as teachers but have access to a different VLAN).

A comprehensive network monitoring service should be included in a connectivity plan. While IDSs and network management are part of the solution, a good monitoring system analyzes and discovers such information as:

- Network traffic and saturation – identify parts of the network that are over- or under-utilized
- Time of use - identify peak times or conditions
- System-wide status and capacities - detect when a service (like VoIP) might be failing or when storage needs expansion or archiving
- Unreachable or misconfigured devices - quickly diagnose a problematic network.

Most servers, routers, and wireless access points need to be refreshed every 4 to 6 years. Selecting hardware that can discover its configuration from a central management tool is preferred and will save you time over devices that need to be configured individually. It is also important to ensure that new hardware is compatible with available software before working at full scale.

PRIORITIZING TRAFFIC

An important approach to maximizing bandwidth is to prioritize certain types of traffic. For example, downloading videos may be a lower priority at times when bandwidth is needed for testing or other classroom projects. You can also mark specific domains or sites as high- or low-priority traffic depending on instructional value.

In addition to providing access to school-owned devices, you may consider providing access for student and staff personal devices or public guest access for school visitors. Segmenting your network gives students and staff prioritized access separate from public access.

Some schools segment their network in ascending order of priority: high-priority traffic (e.g., testing), normal classroom traffic, BYOD traffic, and public guest traffic. Providing public guest



Trust Experts for Installation

Installing network cable in your school is a technical job that is often subject to local and state electrical building and fire codes. Configuring network hardware for use with wireless access points requires considerable expertise. The installation should be secure from damage and tampering, and the work performed by trusted individuals. Be sure to involve network professionals and school IT decision-makers when making any changes to the network configuration or infrastructure.



Segment for Security

Segmenting your wireless network can allow different types of access and provide greater security. For example, there may be a BYOD network for students, faculty, or guests to use their personal devices that is separate from the official school wireless network used by school-provided devices.

access will affect the design of your wireless infrastructure because it adds more complexity to the network architecture given the requirement for additional layers of security and authentication.



Segmenting Networks to Align with Learning Priorities

Fairfax County Public Schools (FCPS) in northern Virginia has a dedicated network for BYOD devices. FCPS has over 200 schools and centers serving 185,000 students and more than 30,000 staff, and it provides public Wi-Fi access in all facilities. To support this large number of users, the district configured its network into three segments. Students use the FCPSMobile configuration by authenticating themselves to the network using their student ID and password. Once authenticated, students have access to filtered high-speed Internet, intranet resources, print and file share services, and learning resources. The FCPS staff accesses the secure Fairfax network, which provides additional access to intranet and business systems like the student information system, online testing, human resources, and financial systems. The public FCPS access provides filtered broadband but no access to the FCPS private intranet. By configuring the network into three segments, priorities can be set so that during peak bandwidth traffic times, the highest priority traffic (e.g., student access to learning resources) is given preference over public access. If your school has or is planning a BYOD policy to complement other changes, it may be worth considering configuration of the network and wireless infrastructure to support separate segments of access.

As you monitor peaks, track both upload and download speeds. Students may show a high rate of downloads as they access content and require more upload speed as they stream video tutoring sessions with neighboring schools or videoconference with outside experts for research projects.

The illustration below provides an example of connections that can be used to extend high-speed connectivity throughout a school campus.



Be Mindful of Multiple Peaks

One of the highest traffic peaks typically occurs when students log in at the beginning of each instructional period. Because all students generally do this at approximately the same time during their day or class period, it is the most likely time for peak conditions to occur. However, it may not be the only occurrence, although pace and network use are usually more staggered once students are logged in. Knowing when to expect peaks and the bandwidth required to accommodate them will help you build a network ready for the extremes of use demands rather than the average.

Connecting the Campus

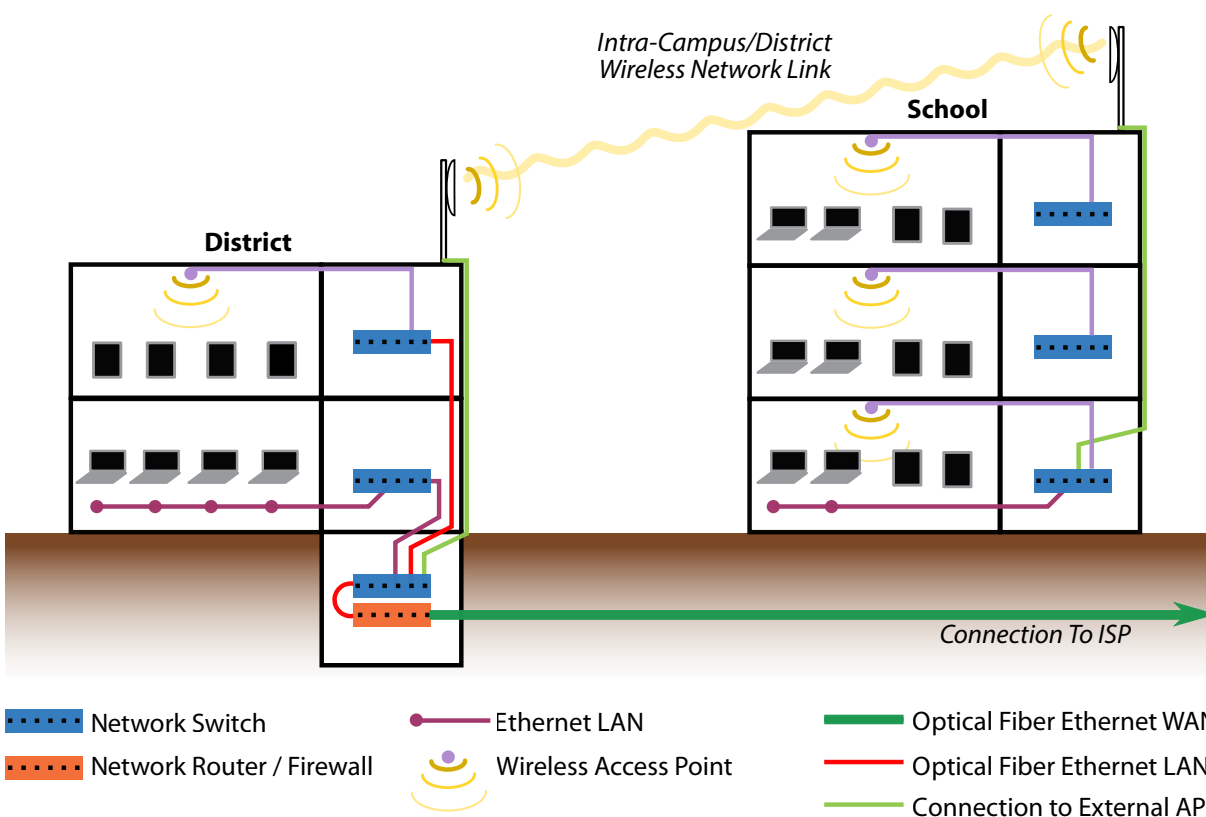

MANAGING THREATS

When installing or upgrading your network, include plans to manage physical and virtual threats such as those outlined here. In many cases, access to networks and the information stored on them can be as enticing to thieves and hackers as the equipment used to create the network.

Building cybersecurity capacity of district personnel is an important line of defense against the inadvertent disclosure of student data such as the attachment of a file that includes protected information. Helping everyone in your district understand basic cybersecurity practices will reduce risky behavior where data are concerned.

Unauthorized users could try to gain access to steal school or district property (licensed software and other paid resources), personal information (student/staff grades, records, contact information, medical information), or operate malicious services (illegal file sharing, game servers, etc.). Authenticating users before permitting network access can help reduce this threat.

No matter how strong the safeguards, no network is impenetrable. Develop and share your plan for responding to a data breach so that you and your district can best ameliorate any inadvertent or malicious disclosure of private data. See PTAC's [Data Security and Management Training: Best Practice Considerations](#) and [Data Breach Response Checklist](#) for guidance in protecting against and dealing with unintended and malicious data disclosures.

A single virus or malware infection can render an entire network inoperable within a few minutes. Virus and malware scanning and removal software at the central network level and on all learning devices reduces risk from these threats.

Equipment rooms should be secured with access limited to authorized personnel. Network equipment not in a locked facility, such as wireless and rooftop-mounted APs, should be protected by commonly available housing and protective cabling to discourage tampering. School IT staff can consult with an IT security specialist to audit and make recommendations specific to your needs.

For school IT staff, ensuring students are protected from harm and have sufficient trouble-free access to network resources to meet learning objectives is paramount. VLANs with authentication based on user type rather than location can provide more seamless access for students as they move through schools. When combined with a content filter, firewalls are effective at preventing access to inappropriate content and websites, and many include QoS features. *See Section 5 for more guidance on privacy and protection considerations.*



Include Teachers in Filtering

Content filters are not perfect, and Internet content changes frequently. Ensure that your content-filtering process can be quickly modified. Creating and managing content filters often require human intervention. Be sure to have instructional staff participate or run this process. Sometimes, schools delegate content filtering to IT staff who have little experience with instruction, which can create problems for staff and students. When instructional staff members discover inappropriate content is accessible via the school network, a streamlined process should exist for reporting, evaluating, and implementing temporary or permanent blocks for the content. A temporary block may be needed when a usually useful site becomes compromised and displays inappropriate content.

4 Getting Devices to Students and Teachers

IN THIS SECTION

- Importance of devices in modern education environments
- Considerations when selecting devices
- BYOD programs
- Funding strategies
- Device maintenance and management
- Home access
- Rollout models

The educational benefits of increased connectivity are realized only when Internet-enabled devices are available to teachers and students. Devices that must be shared by many students or accessed only in designated computer labs limit the ability of students to engage in ongoing collaboration and of teachers to use high-quality digital learning materials. Students who do not have their own devices may not have access to the same level of personalized learning that enables students to learn through practices best suited to their needs and related to their interests and experiences. They also may not learn as productively as those in an environment where all students have access to devices whenever they need them.³⁶ Moreover, many states have college- and career-ready standards, which require students to possess certain technological competencies to prepare them to thrive in a connected world.

More school districts are adopting web-based productivity tools and digital content for teaching and learning. These shifts to web-based materials and tools can decrease paper usage, make teacher time more efficient, and enable students and teachers to access learning materials at any time of day.

Factors to Consider When Selecting Devices

Learning objectives and your vision for technology-enabled teaching and learning should be the primary driving factors in your selection of devices for teachers and students.

Test a wide variety of devices before making a selection. One of the best ways to test devices is by creating a testing script, a list of actions for teachers and students to try on each device. If a school district will be using specific web-based systems, offer an online curriculum or have students regularly watch videos from a particular site; each of these functions should be tested on every potential type of device.

Do not compare devices by technical specifications alone. If you want students to make movies, test how well each device makes movies. If you want teachers to participate in online communities, test how well each device enables them to do so. If you want devices to last for a certain amount of time without having to be recharged, try using them for that amount of time. Your main evaluation criteria should be how responsive and usable devices and software are in helping students and teachers complete various tasks.



Tip

Visit the [Federal Registry for Educational Excellence \(FREE\)](#) for access to thousands of digital teaching and learning resources.

Issues of accessibility are of particular importance when considering which devices will best serve students' learning needs. Special education specialists should be an integral part of the device selection process. The Individuals with Disabilities Education Act (IDEA) ensures that children with disabilities have access to the general curriculum and that they will receive the services and supports needed to achieve their educational goals, and to prepare them for further education, employment and independent living.

Children must have full access to content and instruction required to effectively participate in educational environments and to meet their educational goals. Assistive and instructional technologies such as special software and devices, and accessible versions of curricular materials, textbooks and media are powerful tools that ensure full access to educational curricula and content. For more information about assistive and instructional technologies, media and accessible educational materials, visit the [Center on Technology and Disability](#) and [Bookshare.org](#).

As with networks, it is important to compare the total cost of ownership for devices and peripherals, including keyboards, protective screens, cases, and any necessary software. A cheap device that requires an expensive case for protection from damage may cost more in the end than a device that is more durable but slightly more expensive.

Computing devices most frequently come in four different types: desktops, laptops, tablets, and smartphones. Generally, either laptops or tablets are the choice when providing devices to all students because they are portable, have large enough screens for most activities, and are available at prices that make them affordable for mass deployment.

Some districts involve a variety of stakeholders in device selection. In Rhode Island, for example, the devices used in the Chariho Regional School District's 1:1 initiative were chosen by a Device Selection Advisory Committee composed of administrators, superintendents, school committee members, teachers, students, the director of technology, and a community member.^{37,38}

Inclusion of these stakeholders can help inform the decisions being made and begins to bolster community support as you roll out your plan and implementation to schools and the surrounding community. Above all else, as you evaluate devices, be sure that they align with the learning and use goals you drafted as part of Section 1 of this guide.

Ask these questions when deciding which devices are right for your schools:

- What are your expectations for extended battery life?
- How reliable is the device's operating system relative to privacy and data storage concerns, and does this align with your district's privacy policy?
- What level of durability are you looking for in the device(s)?
- To what extent are considerations of screen size, keyboard/mouse, and peripherals such as scientific probes important for device selection?
- Given the ages of the students who will be using these devices, what choices are most developmentally appropriate?

Here are some pros and cons to consider as you evaluate and plan for device purchases.

Tablets are relatively lightweight, offer a touch screen interface, and typically have longer battery life

than laptops. They also have instant-on capabilities, meaning that as soon as they are turned on, they are ready to be used. Laptops may take a few seconds to wake up after they have gone into sleep mode. Some find that reading and interacting with text are easier on a tablet than a laptop. One disadvantage of tablets is that web-based educational apps (applications) that have not been designed specifically for a tablet may be difficult to use. A school already committed to particular digital learning content should make sure that tablets will accommodate the software including any media files it may include.



Definition

Digital learning content includes resources such as teacher-created websites, free and open digital resources, and purchased content such as digital textbooks. This content can be available via an Internet connection or downloadable to devices.

Pros

- Tablets tend to be cheaper and lighter and have simpler interfaces than laptops, which can be particularly useful for younger learners.
- The always-on nature of tablets makes information and tools more easily accessible.
- Several peripherals such as science probes can complement the mobility of tablets, making lab experiments in the field possible.

Cons

- Tablets typically do not have built-in keyboards, which can make longer writing assignments challenging.
- The smaller screen size may make it harder for students to create media.
- Not all learning resource providers have updated their products to be used on a mobile device, which may adversely affect functionality and interactivity.
- Tablets can lack the processing power necessary for productivity tasks such as multimedia creation that are available in many laptops.

Laptops, although slightly less portable than tablets, often have larger screens, more powerful processors, and full keyboards. Some laptops also include the touch screen functionality of tablets. For the CTO of Houston Independent School District, laptops made the most sense for his high school deployment because "We knew we wanted to have something that had a keyboard enabled with it, and we knew that for a

majority of kids, when they go to college, a laptop is the tool they find most functional."³⁹ Some laptops have web-based operating systems that rely largely on cloud-based file storage. Whereas these are often less expensive, they also come with trade-offs regarding functionality and processing power. As with any decision about learning tools, consider what you want students and teachers to accomplish with these tools to help guide your thinking.

Pros

- Laptops have larger displays and more processing power for students to create their own media and use advanced software.
- They have built-in keyboards.
- They are compatible with a wide range of digital learning resources and educational software.

Cons

- Battery life is often less reliable than that of tablets.
- Their size and moving parts can diminish mobile use.

Determining Device Requirements

Requirements for devices depend on what your schools plan to do with them now and over the life of the devices. Consider requirements for assessments that may be delivered on the devices. Many state online assessments specify minimum screen sizes, speed, and keyboard and/or mouse requirements. Visit the PARCC or Smarter Balanced consortia websites for specific information on those assessments. If your state or district uses other assessment systems, check the technical requirements of those systems as well.

Purchasing devices that barely meet minimum specifications for delivering assessments may not be in the best interest of the district's broader educational goals. Consider optimal rather than minimal standards because they allow devices to be used as intended, allow for growth and expansion over the device lifetime, and allow room for unexpected future developments. A 9-inch screen may be the minimum threshold for online assessments, but will a

9-inch screen serve other educational needs for your students? This does not mean that districts should feel compelled to purchase the latest and greatest. For example, San Diego County purchases devices that fall in the 55%–75% range of premium (0% being the minimum specification and 100% being the most above-specification technology). By following this purchase strategy, the county has been successful in purchasing devices that are above the minimum technical specifications, are acceptably premium, and are reasonably priced.



Use Single Sign-On when Possible

Some school districts are able to negotiate up front with vendors and content providers the ability to use a single-sign on (SSO) process. SSO is a user authentication process that enables a user (student, teacher, administrator, and/or parent) to enter one name and password to access multiple applications. The process eliminates further prompts when the user switches applications during the same session. To avoid trying to retrofit software, be proactive about establishing the SSO process up front. Sign-on should be as simple as possible so that students are not scrambling to remember passwords and wasting valuable class time.



Bring Your Own Device (BYOD)

BYOD policies can provide students with greater choice and control of their technological habits. However, schools should be cautious when considering BYOD as a replacement for school-provided devices. BYOD policies alone can create several challenges:

1. **Economic disparity**—The ability to access digital learning materials is disproportionately distributed to students whose families can afford the devices. This can widen the very learning gaps that technology is capable of closing. It may also raise legal concerns because schools are expected to provide a free education for students. If devices are required materials, all students must have access to an equivalent device.⁴⁰
2. **Instructional burden**—It can be increasingly difficult for teachers to manage learning activities when they have to support multiple platforms and devices (some activities may be incompatible with some devices). In this situation, teachers may revert to “lowest common denominator” activities that work on older and less robust devices at the expense of the learning experience.
3. **Assessment security**—Student-owned devices may not have the functionality necessary to support a secure testing environment. If your school participates in online assessments, student-owned devices will most likely not provide an acceptable assessment option.

When considering allowing BYOD at your school, consider four important lessons from leaders who have already undertaken these efforts:

- Security measures (such as content filtering) must be managed at the network level rather than at the device level.
- Cloud-based resources are helpful for managing the transition between school and home.
- Students may need to log in to learning systems from BYOD devices. Be sure you support such log-ins.
- Set minimum device requirements for BYOD devices or provide a list of preferred devices. This can drive family purchases and standardize more of the device environment.

Structuring Device Purchases

This section highlights three funding strategies commonly used by districts across the country.

Through **outright purchase**, a district buys and owns the devices until it decides to retire them via donation, salvage, or other forms of disposal. With this model, districts may purchase a warranty or service agreement from the manufacturer or retailer to repair or replace devices under certain circumstances. Although it allows for expedient purchases, there can be challenges in relying on an outright purchasing



Request Proposals

To keep costs lower overall, be mindful of how you develop purchasing agreements. Issuing a request for proposal (RFP) instead of requesting a price quote makes vendors compete for your business, leading to more competitive prices for your district. For small districts that may not be requesting large enough proposals to attract bids, partnering with other districts or states on collaborative purchases is a good option.

approach. Unless a school district specifically creates a yearly budget line item for technology on a per-pupil basis, the tendency is to use one-time funds or other nonrecurring budget sources to pay for the initial purchase. This line item is established by some districts as the result of amortizing the purchase across multiple fiscal years through the selling party or a third-party lending institution. This allows for outright purchase in schools and districts that do not have budgets allowing for a single bulk payment.

Often, these devices end up being deployed to students and teachers for 5 or more years. This extended use can result in students using outdated technology and districts spending a lot on labor and parts to maintain older devices. Before leveraging nonrepeating funds for an initial technology purchases, decide how you will fund the replacement or update devices in subsequent years.

In a **leasing** model, the school district acquires devices in exchange for periodic payments instead of purchasing devices outright. The leasing company owns the equipment and provides an equipment refresh based on the terms of the lease. For example, a district may determine that a 3-year refresh is appropriate to ensure students are using modern devices. At the end of the 3-year term, the leasing company refreshes all the devices and potentially pays the district for the residual value in the devices. Relative to outright purchase, leasing addresses some of the challenges created by owning equipment, like regular budgeting, maintenance, and equipment replacement.

With **cooperative purchasing**, school districts in some states or regions may be able to buy from regional, state, or consortium-based purchasing contracts. These contracts can offer volume-purchase and discount pricing for smaller or medium-size school districts. These buying consortia may also grant access to bids and RFPs that can be piggybacked on by other agencies. These cost reductions, redirections, and reallocations are important steps in budgeting analysis before any funds are expended. Consult your state education authority for information on consortium purchasing available near you.

Funding Device Purchases

In the past, it has been acceptable for technology purchases to be seen as supporting resources outside the standard curriculum. As students' learning needs move toward a diverse learning ecosystem reliant on the presence of multiple technologies, such purchases can no longer be seen as extra. In addition to the possible funding sources outlined here, you should begin to adopt the mindset that technology purchases are normal parts of the operation of a school and recurring expenses within the budget.

Historically, school districts have paid for technology from general operating funds or special budget sources that are outside the general fund. Special sources may include grants, donations, local categoricals targeted for specific purposes, lottery funds, special-purpose local-option sales tax (Georgia, North Carolina, Iowa), fines and forfeitures, and federal funding available through the Elementary and Secondary Education Act (ESEA) of 2001.



Make Every Dollar Count

This U.S. Department of Education Office of Educational Technology provides guidance and examples for leveraging federal funds to purchase educational technology:

tech.ed.gov/funding/

Some school districts leverage short- and long-term bonds approved by voters to pay for technology. This approach is risky because taxpayers can be saddled with debt that outlives the devices by many years. In addition, it gives the appearance that device purchases are one-time expenses rather than recurring ones. Some have suggested using bonds with shorter lengths, closer to the expected life expectancy of the devices. In Ann Arbor, Michigan, voters passed a 5-year technology bond. School leaders should carefully evaluate the benefits of bonds because many devices can be more cheaply replaced than repaired in just a few years. In California, a new type of school bond was introduced to provide school districts with an ongoing funding source for education technology that also protects taxpayers from incurring long-term debt.⁴¹ Contact your local government to see what funding options are available to purchase devices and other elements of school technology.

In addition to identifying new funding sources, district leaders are wise to consider costs that can be eliminated because of the evolving education model. For example, funds typically dedicated to textbooks, printed materials, or other instructional resources may be redirected to devices that make such resources obsolete. Several districts, such as Huntsville, Alabama, and Mooresville, North Carolina, stopped purchasing textbooks, allowing the redistribution of funds to support the transition to digital learning.

Schools and districts are increasingly using open educational resources (OER) to reduce licensing costs for digital content. As with any new curricular resource, the transition to OER will require professional development for teachers as well as time to curate and share those resources. In addition to the potential of long-term savings from the elimination of licensing fees, open resources may have the added benefit of allowing teachers to customize and share their materials with others without violating licensing agreements.

Setting a Refresh Cycle

Beyond 4 years, the combination of student wear and tear and software updates require devices to be replaced. "Within three to four years, it is less expensive to replace the device than repair it," says Doug Levin, the executive director of SETDA.⁴² Devices should be disposed of by resale, donation, salvage, recycling, or other form of disposal to minimize harm to the environment. If you are considering resale, be sure first to check on local legal restrictions and any contractual language regarding such sales. Additionally, consult the Electronic Product Assessment Tool to better understand the environmental impact of your technology purchases and disposal of those products if they cannot be resold or donated. For information on more environmentally friendly technology, consult CoSN's SmartIT paper at www.cosn.org/smartIT.

When considering device purchases, account for the cost of battery replacement. Some states, such as Maine, include the replacement of any battery that no longer holds a useful charge plus the proper recycling of the spent battery in their annual cost per student because batteries often require replacement before devices reach end of life. Newer devices have longer battery lives, and some providers claim that batteries on their new devices will last 3 to 4 years before they need replacing.

Strategies for Managing Devices and Applications

Device management is both a technical and managerial issue that includes such aspects as deciding what content is allowed on the devices, remotely wiping stolen devices, and tracking devices reported missing. From a technical perspective, it is important to plan and implement procedures that employ system-level controls for device and application management. School district staff should be able to push out updates,

security protocols, and other critical functions from a central location (versus physically touching each device). Most operating systems have built-in mobile device management tools or support third-party device management tools. *See Device Management in Section 5 for more information.*

Warranties and Maintenance

Although educational technology implementations are and should be about learning and education, they become focused on technology each time something breaks. Make sure you have a plan for addressing inevitable device maintenance and repair. Whether you retain school employees or outside contractors for the job, you need a plan for how repairs will happen quickly and with minimal disruptions to learning. You can supplement your professional technical support with student support teams to handle less detailed recurring repair concerns. If equipment cannot be repaired fast enough, the situation can be disruptive to teachers and students.

Varying degrees of local or off-site maintenance may be needed depending on the expertise of staff. In addition, the strategy for maintenance needs to take into consideration continuity of learning such as providing students and staff replacement devices while theirs are being repaired or have been misplaced. Typically, schools operate along these lines:

TIER 1: Local – Repairs that can be handled by the local school or sent out for repair (lower warranty cost)

TIER 2: Off site – Repairs requiring the device be sent to a repair center. Consider these needs while negotiating warranties and contracts.

Clarify a plan for Tier 1 and Tier 2 maintenance before signing a contract to decide which repair issues will be handled in the district and which will be sent out. Buying a warranty can cover or lessen the cost of the repair, but it does not mean the repair is actually made. Schools should ensure that they have plans and contracts in place that take into account the time it takes to repair the devices. If outsourcing maintenance, then service-level agreements with the provider can clarify responsibilities for both parties. When performing in-house maintenance, check warranties first to see whether manufacturers cover needed maintenance at no or low cost.



Make Learning Justify Spending

Before engaging in discussions about funding options, have an answer to the question about how device investment contributes to student learning. Your district's finance officer also needs to be on board and understand what it means for long-term financial planning combined with your vision for teaching and learning. Auburn, Maine, is in year 4 of providing tablets to students in K–12. The district calculated the cost of remediation and found that if the devices can reduce remediation by even a small number of students, that reduction will pay for the devices.



Students as Tech Support

At Burlington High School in Massachusetts, the Student Help Desk is a resource for all students on their basic tech needs. The Help Desk also teaches students valuable lessons about digital citizenship and encourages them to take responsibility for their devices. Encouraging students to be a part of the solution gives them a sense of responsibility and ownership.

Try to make warranties match your refresh cycle unless it is cost prohibitive to extend a warranty program to the planned life of your devices. Some larger districts are moving to service center models of IT support, sharing resources across several districts. This reduces costs by eliminating such expenses as vendor-trained school staff and using cloud-based services. With the maturity of cloud-based technical services, school districts now have the option to outsource some infrastructure services to regional data centers.

District Devices at Home

Districts opting to send devices home with students are creating policies and expectations pertaining to acceptable use and establishing agreements for handling a lost or damaged device. These policy considerations and others are addressed in Section 5.



Know Students' Home Access, and Craft Educational Experiences Accordingly

Teachers who become accustomed to leveraging technologies in the classroom may not stop to consider students' access levels at home if devices are required to be left in the classroom or lockers. Even if students may take devices home, they might not have Internet connectivity. Students without access may need to worry about work-arounds. Some may download and upload content while they are at school. Such work-arounds caused by inequity negate the gains made by increasing school connectivity.

Some districts provide wireless access on school buses or at community centers where students spend time after school. Others partner with local businesses, providing them with extra power supplies or other incentives in exchange for providing students with free wireless access. *See Section 3 for information on wireless networks available to the community and Path 4 in Section 2 for information on mobile broadband cellular services.*

Some districts are pursuing strategies for connecting students off campus to provide continuous connected learning opportunities. For example, according to a CoSN survey, 29% of districts provide or subsidize Internet access for low-income families, 50% have partnerships with community or business wireless hot spots for student use, and 13% provide students with filtered smartphones.⁴³ Some districts are choosing to provide students with a wireless router that acts as a mobile hot spot (aka wireless mobile data bridge)—a small portable device that provides wireless connectivity to nearby computers. For example, Irving Independent School District outside Dallas, Texas, began distributing mobile hot spots to qualifying families who lack Internet access in 2013.⁴⁴

As you consider allowing students to take district-provided devices home during the school year, start to anticipate family and student interest in taking devices home over the summer. For some 1:1 programs, schools delay the summer option until a year or two into the program so they better understand and meet repair needs. Others prohibit students from taking devices home over the summer entirely for fear of increased loss or damage when students are away from school. As you begin to deploy devices, anticipate questions from families and other stakeholders and have answers prepared.



Determining Student Access at Home

Fairfax County Public Schools in northern Virginia surveys families about home access and includes home access questions on emergency care forms that are updated annually. Fairfax's CTO offers some tips based on the district's experience.

Fairfax initially distributed the district-wide survey via email. For families that did not respond, the district conducted an automated telephone survey (to home phones and cell phones). Then, for those who had not responded to the email or telephone surveys, schools followed up with individual phone calls and papers sent home in backpacks. "It may seem obvious, but if your survey is only email or web-based, you will likely miss the families you are most concerned about," notes Fairfax's CTO. In addition, Fairfax issued all the surveys (web, phone, paper) in multiple languages and individualized surveys based on the students' home language. Remember to be sensitive to the language divide as well as the digital divide.

With regard to devices, the survey asked whether a family had adequate devices at home for their students to do homework rather than whether they had a computer/device at home because even if there is one computer in the home, it may be shared by multiple children and multiple adults. Finally, the district includes the survey information as required fields in the student information system (SIS). The questions, "Do you have Internet access at home?" and "Do you have adequate devices at home?" were added to the emergency information form families are required to update annually. Having the data in the SIS is advantageous because they are easy for teachers to access and easy to report, and it is easy to see which students' information is missing.

Think of home surveys as spaces for parents to communicate their needs directly to schools as well. Consider including open items that allow for responses outside pre-identified data to increase your understanding of unidentified needs.

Choosing a Rollout Model

Four possible models for device rollout are outlined here. Each has the potential of being used in conjunction with the others, and you should design a rollout that best suits your schools' needs and capacities. Consider piloting whichever model you choose with a small sample to allow for necessary adjustments when you are ready to deploy to the full district or school.

Full school: The entire student body of a school receives devices at the same time.

Pros: Creates a cultural shift within the school. A concentration of resources are available for full professional development for faculty and teachers. High school rollouts can benefit from wholesale 9–12 deployment because multi-grade classrooms in high school make grade-by-grade implementation difficult.

Cons: Provides limited opportunity to work out the kinks at the school level and a great deal of pressure to ensure professional development and logistics are adequately planned.

Grade level: Over the course of several years or throughout a single year, devices are distributed to students one grade level at a time. Often in this model, devices are given to the youngest grade in a school each year. More specific educational goals drive which grades are selected. As students age up a grade, they take their devices with them. This cycle continues until all students have received devices. Be careful of using this in high school because of the concern mentioned above; this may work best for middle school and elementary school.

Pros: Allows you to buy fewer devices at a time as well as work out the kinks in a single grade and prepare a few teachers at the same time.

Cons: Runs the risk of losing funding for the next grade level. Creates inequity of access across grade levels.

Subject area: Devices are rolled out to a focused discipline or content areas within schools. This is effective if a school has a discipline focus, such as STEM or the arts, that will be implemented well with a device model. This is especially common with literacy in younger grades. Consider subjects for which you have buy-in about the potential for technology, along with educational need and determination.

Pros: Allows an additional focus on the educational requirements of a specific subject. Less expensive than a schoolwide rollout and allows time for lessons learned (similar to a grade-level rollout).

Cons: The student experience can be uneven across classrooms, teachers, and/or subject areas. Some teachers may lack interest or ownership in using devices for learning because they see them as belonging to other programs or subject areas. Other subjects may want to use the technology to support their subject areas as well.

Exemplar teacher model: Work first with the teachers who can and are interested in helping you build a program. Consider identifying these teachers by outlining the vision for utilizing digital learning resources, and the requirements for participation as an exemplar teacher. Ask interested teachers to apply for consideration and include past examples of work and learning that align with district plans.

Pros: Works through the process with power users and early adopters to develop policies, protocols, and procedures. Greater chance of success out of the gate, which can be helpful while building momentum. Allows for adjustments from lessons learned.

Cons: Risks non-pilot teachers feeling disconnected from the process. Could also result in policies and procedures that fail to take into account reluctant users.



Full-School Pilot Model

Consider which rollout strategy makes the most sense for your school or district. The **Houston School District** kicked off its \$18 million 1:1 laptop PowerUp initiative in 2013. The district ramped up the initiative in phases throughout the school year so that the infrastructure capacity could be tested and adjusted. It used a full-school pilot model for the initial rollout. At the start of the 2013–14 school year, teachers at 11 pilot high schools received laptops. In January 2014, all students in the pilot high schools received laptops, with the program ultimately providing 130,000 students in grades 3–12 with laptops. Before implementing the program, the district superintendent and CTO observed several other 1:1 programs to learn from them and to brainstorm improvements. Their main advice for other districts considering 1:1 programs is to be flexible and willing to alter course if something is not working.⁴⁵

Planning Your Rollout

Planning must take place at the district and school levels to ensure a smooth rollout. In the same way that your district will need to develop a plan that is unique to your needs and context, your schools will most likely need some leeway in designing a process that suits their school populations. While the suggestions here offer guidance, providing schools with planning templates will require them to consider key issues while allowing for site ownership of the process.

Beginning an initiative that includes devices for all students will mean an influx of device inventory at all levels. Plan for a flow of responsibility for checking devices in and out. Many schools will use existing systems such as those in place in libraries or media centers to leverage existing capacities and system knowledge.

Consider parents to be partners in this process, especially if you will be providing devices for home use. Plan informational meetings in advance of handing out devices so you can walk parents through policies and procedures and address concerns without the distraction of new devices in students' hands. When scheduling these events, take into account the availability of your parent population so that you can meet face to face with as many parents as possible and avoid miscommunications with parents who are not able to attend.

When communicating with parents and community members, keep them informed of all aspects of the process. For many families, the shift to devices in classrooms and homes will require a great adjustment; providing as much information as you can will help to answer questions as they arise and show your district is operating in accordance with a clear vision and plan.

Professional development on the most effective ways to use digital learning resources will be an ongoing process, and it should begin before teachers receive devices. Plan an introductory course (online, in person, or blended) to help teachers learn basic functionality and troubleshooting before they can access devices. That same course could then be modified for students to ensure all district members have a foundational level of understanding before rollout.

While some students will be adept at device usage from the moment they receive them, some will need guidance, and all will probably require help accessing new digital learning resources. Have a document such

as an electronic handbook preloaded on devices that explains account and sign-on procedures students will need to follow. This will be much easier if your district is using SSO for accessing resources.



Communicating With Stakeholders

In 2012, the **St. Vrain Valley School District** in Colorado formed an instructional technology advisory committee to plan the district's upcoming technology investment so that it would best serve learning goals. Throughout the technology planning and implementation process, the district's goal was to communicate often, build trust with the community through transparency, and to maintain the focus on learning. To keep lines of communication open, the district created a blog to communicate its story and to give stakeholders an opportunity to provide feedback. The technology department placed a shortcut on the home screen of every device to provide families with information and resources about the transition. The shortcut includes information for parents in both English and Spanish, as the district has a significant population of Spanish-speaking families (30%). In addition, the district reached out to community groups working with local families and partnered with libraries and businesses to provide opportunities for family events and trainings.



5 Responsible Use, Privacy, and Other Considerations

IN THIS SECTION

- Device management
- Responsible use & digital citizenship
- Student privacy requirements
- Safeguarding against inappropriate content
- Policies for lost or damaged devices

Setting expectations that encourage device management, digital citizenship, and other policies that outline responsible use, including safeguarding student privacy are essential considerations to ensure technology effectively supports learning. Policies in these areas should be carefully considered before device rollout begins.

Device Management

REMOTE MANAGEMENT

Devices require ongoing management—including keeping software updated, adjusting filtering settings, and changing system preferences. Software tools can be installed on devices to make it easy to remotely update them without users having to take them physically back to the school each time an update is required. This software may also collect information about how devices are being used in order to better support students and teachers. The district is responsible for maintaining up-to-date security and privacy settings to prevent hacking and protect student data. As schools transition to online assessments, installation of special software may be necessary to ensure a secure testing environment.

REMOTE LOCKING

In addition to installing software to remotely update devices, you may also consider installing tools to remotely disable or erase a device in the event of loss or theft. This can increase the likelihood that lost devices are returned to the district as well as prevent data from being taken from a lost or stolen device. Publicly communicating that devices can be permanently locked may also help deter theft. For example, you might put a sticker on the bottom of every device stating that if the device is lost or stolen it will be remotely disabled. Local law enforcement agencies may be good resources for determining how best to deter theft and address missing devices.

STUDENT ACCESS

Districts need to decide how much control students may have over school-provided devices. Less ability to modify or change the device settings can make it easier for IT staff to maintain devices but gives students less freedom to personalize devices for their needs. The decision to allow more control over a device may vary depending on the student. A multi-tiered model of permissions and restrictions gives students who demonstrate responsible behavior more privileges and restricts access for students who fail to show responsible behavior. As you consider these policies, remember that restricting a student's access in one class will affect that student's ability to participate in learning in subsequent classes as well.



Mobile Management for Device Configuration

In Maine's statewide laptop deployment, each student has full administrator access to his or her device, and students are fully responsible for their device's management. The state has a mobile device management system, which allows the state and individual schools to make software available to students and teachers as well as to remotely update software and settings.

Ensuring and Encouraging Responsible Use



Modify What Works

Defining digital citizenship for your district in the face of shifting technological landscapes can be daunting. Turn to organizations like [Common Sense Media](#) for resources to help guide your thinking on the kinds of digital citizens you want educators and students to be. Common Sense materials range from an outreach kit for a family engagement night to advice videos and family tip sheets in English and in Spanish.

Before students are allowed to access the Internet at school, whether via a school-provided or personal device, most schools ask parents and students to sign an Acceptable Use Policy (AUP), also known as a Responsible Use Policy (RUP). An AUP is a written agreement between parents, students, and school personnel that outlines the terms of responsible device use and consequences for misuse. AUPs traditionally cover topics such as guidance on how students are expected to interact with one another in digital spaces, what resources may or may not be accessed with district-provided devices, and standards for academic integrity when using digital resources for learning. Parents are asked to acknowledge that their child agrees to basic care and responsibility guidelines. Students are asked to

sign a contract agreeing to follow rules governing their use of the Internet and online conduct.

AUPs should be written in plain language that is easily accessible for students, parents, and district personnel. For additional information on questions to consider when drafting an AUP, see [CoSN's Rethinking Acceptable Use Policies to Enable Learning: A Guide for School Districts](#). Relying on strict policies and procedures for the use of devices can often have unintended negative consequences like preventing access to legitimate educational resources. Effective AUPs are an opportunity to teach students to create a positive digital persona. Learning responsible digital citizenship while in school helps students to thrive in a

connected world. Digital citizenship can include aspects of students' online lives that range from online etiquette and safety to their rights to privacy and access.

Rather than try to mandate how devices will be used, schools and districts should set forth clear guidelines to parents, teachers, and students about how the devices should be used and about how and when the school/district will use student data. By implementing flexible policy recommendations, schools and districts can set expectations for responsible use.



Definition

An **acceptable use policy** (or **responsible use policy**) is a contract between districts, parents, and students that states the expectations and responsibilities of anyone using the school's network and devices. Signed AUPs typically are required before a student can gain access to a school-provided device or network.



AUPs as Learning Opportunities

AUPs can be written in plain language. For an example, see the [AUP of Austin ISD in Texas](#). Another helpful approach is tailoring your AUP language to different grade levels of students, as [Boston Public Schools in Massachusetts has done](#). Consider creating lesson plans or other materials to help teachers present AUP content in a meaningful way that makes understanding your AUP a learning opportunity.

In addition to providing acceptable use policies for schools, it is essential to provide families with guidelines to help them establish their own norms for acceptable use at home. Many districts hold a mandatory parent orientation before issuing students' devices, and may do so in coordination with parent organizations to lead classes on technology use in the home. Hosting parent and community nights to explain the school's approach to connected learning, ensuring clarity about policies, and presenting digital citizenship for all community members helps to share responsibility. Parents should be educated on use, responsibilities, digital citizenship, and how to manage devices at home.

Protecting Privacy

Schools officials, families, and software developers must be mindful of how data privacy, confidentiality, and security practices affect students.

Schools and districts have an obligation to tell students and parents what kind of student data the school or third parties (e.g., online educational service providers) are collecting and how the data can be used.

As you plan, be certain that policies are in place regarding who has access to student data and that families understand their rights and responsibilities concerning data collection. These policies should include not only formal adoption processes for online educational services, but click-wrap agreements as well. A user encounters click-wrap when asked to click on a button to accept the provider's terms of service before using an app or software. With click-wrap agreements, the act of accepting the terms of service enters the developer and the user (in this case, the school or district) into a contractual relationship akin to signing a contract. Be sure all teachers in your schools understand the implications and district policies governing the use of such software agreements.



Consult PTAC Recommendations

The U.S. Department of Education established the Privacy Technical Assistance Center (PTAC) as a one-stop resource to learn about privacy related to student data. [PTAC](#) provides information and updated guidance on privacy, confidentiality, and security practices through a variety of means, including training materials and direct assistance. PTAC also provides guidance on the relevant privacy laws. PTAC recently provided additional recommendations on [Protecting Student Privacy while Using Online Educational Services](#) and [Transparency Best Practices for Schools and Districts](#).

A number of statutes apply to student privacy in schools. More information on each is below.

FERPA (the **Family Educational Rights and Privacy Act**) gives parents the right to access and seek to amend their children’s education records (these rights transfer to students when they reach 18 years of age or when they attend a postsecondary school at any age). FERPA protects personally identifiable information in education records from unauthorized disclosure, and requires prior written consent before schools share personally identifiable information from student education records. However, school officials with legitimate educational interests can disclose personally identifiable information from education records with vendors subject to certain requirements, including that the vendor performs an institutional service or function that would otherwise be performed by school employees.

The second statute is **COPPA** (the **Children's Online Privacy Protection Act**), which governs online collection of personal information from children under 13. Before an online organization can collect any information from students under 13, “verifiable parental consent” is required. The Federal Trade Commission, which enforces COPPA, has said that school officials can, in certain situations, provide consent on behalf of the parents in order to sign students up for online educational programs at school. Signing up for any online educational program entails some level of student data collection. This can become complicated when students use their own devices at school and sign up for educational services or programs and then take the devices home. For school-provided devices, the law is clearer and schools can collect data on those devices for educational purposes when the devices are at school or elsewhere.

CIPA (the **Children's Internet Protection Act**) imposes several requirements on schools or libraries that receive E-rate discounts for Internet access. Schools and libraries must certify that they have technologies in place to block or filter Internet access to content that is obscene, pornographic, or harmful to minors, and schools must also monitor the online activities of minors.

PPRA (the **Protection of Pupil Rights Amendment**) is intended to protect the rights of parents and students in two ways. The first is by seeking to ensure that schools and contractors make instructional materials available for parents’ inspection if those



Review Federal Guidance

For more guidance on FERPA, visit the US Department of Education’s [FERPA for School Officials](#).

The Federal Trade Commission enforces COPPA. See the FTC’s [Complying with COPPA FAQ](#) for more details.

The FCC’s [CIPA Guide](#) offers a more in-depth understanding of CIPA requirements.

materials will be used in connection with a survey, analysis, or evaluation funded by the U.S. Department of Education. Second, PPRA requires that a school district, with exceptions, directly notify parents of students who are scheduled to participate in activities involving the collection, disclosure, or use of personal information collected from the students for marketing purposes or for sale or provision to others for marketing purposes and give parents the opportunity to opt out of these activities. One important exception to PPRA is that neither parental notice and the opportunity to opt out nor the development and adoption of policies are required for school districts to use students' personal information for the exclusive purpose of developing, evaluating, or providing educational products or services for students or schools.

HIPPA (the **Health Insurance Portability and Privacy Act**) sets national standards for the security of electronic protected health information. In most cases, the HIPPA Privacy Rule does not apply to an elementary or secondary school because the school either: (1) is not a HIPPA-covered entity or (2) is a HIPPA-covered entity but maintains health information only on students in records that are by definition "education records" under FERPA and, therefore, is not subject to the HIPPA Privacy Rule. For a better understanding of the issue, see the [jointly-published guidance](#) from the US Department of Health and Human Services and the US Department of Education.

Safeguarding Against Inappropriate Content

It is the school's responsibility to protect students from inappropriate content when they are using the Internet. This can be done through technical approaches (filtering and blocking) as well as through establishing a digital citizenship curriculum and school culture that includes online safety.

USE TECHNICAL FILTERING

Many tools are available to filter the content that can be accessed on the Internet. All connections to the Internet must be filtered in order to be in compliance with E-rate. However, filtering can be challenging because of the enormous volume of online resources.

When establishing technical filtering solutions, schools must balance protecting students from inappropriate materials with not limiting access to valuable educational content. If filters are set to be too strict, students and teachers may be prevented from using high-quality educational resources and collaboration tools, which would defeat the very purpose of investment in the technology.

Filtering is a partnership between teachers, students, and the people responsible for providing the technical filtering system. Decisions about what materials should be available or restricted should be made in consultation with teachers, and teachers should have an ongoing and streamlined way to request access to



Share Data Wisely

As a general rule, if the school provides the device, has an educational service contract with a vendor performing an institutional function or service, and the application has educational value; then collecting data for purposes of helping the student or teacher or improving the application itself is generally permitted. However, the requirements of FERPA's "school official" exception must be met, including that the data uses are authorized by the school and constitute a legitimate educational interest per the school's annual notification of FERPA rights. For districts that rely on the general terms of service (TOS) offered by outside providers, PTAC provides additional guidance regarding TOS and managing that process. You can find more information at tech.ed.gov/privacy.

sites with educational value as well as to recommend sites that should be restricted.

One helpful strategy is to periodically audit content access. In this approach, websites being accessed by students are regularly reviewed and adjustments made. Inappropriate activity can be detected and consequences created for inappropriate behavior. Conversely, blocked sites that students regularly attempt to access can be reviewed in case they are educational sites that are inadvertently being blocked. This can be a powerful approach for maintaining a strong content filter without limiting educational access to a wide variety of sources.

No technical filtering tool is 100% reliable, and some objectionable content may still pass through, which is why building a curriculum and school culture that include digital citizenship is an essential component of keeping students safe.



Involve Parents

When it comes to content filtering, transparency with families and teachers is key. In general, schools are not required to provide filtering when a device is not used on a school-provided network. It is a good practice, however, to provide filtering on school-owned devices even when they are used on home or public networks. Make sure that you communicate clearly to parents where and how the school is providing filtering and inform them in what cases they are responsible for filtering (such as on personal devices connected to a home network). Give families guidance on both technical and human filtering options that can be put in place on devices they are responsible for. For more information on filtering on devices, see the [FCC guide on Protecting Children from Objectionable Content](#).



Consider how you will filter content on non-district devices

If you are considering a BYOD program, you have additional filtering challenges to consider. Because schools have limited ability to control personal devices, filtering solutions must be implemented at the network level. Districts may require students with their own devices to use only the school's wireless network rather than the student's personal data plan to ensure that filtering is provided. If a district is issuing mobile hot spots for student home Internet use, the service provider for the mobile access must be filtered. Some schools have decided to require that students use their devices to connect to school filtered networks only and use only school-provided learning applications and software.⁴⁶ *For an example of a BYOD filtering success story, see the Fairfax County example in Section 3, on page 41.*

TEACH RESPONSIBILITY

While technical filtering tools should always be in place, teaching students to be responsible Internet users is the best long-term strategy because students can develop judgment, which can ensure appropriate use even when students are using devices that may not have the same technical restrictions (such as home computers or personal smartphones). Approaching the guidance you offer students from this mindset can help them act like the online citizens you hope them to be when you are not in the room or monitoring a device. Failing to teach students responsible use and hoping they will automatically know the safest ways to behave when filters and security settings are no longer present is irresponsible and potentially dangerous.

The most successful approach to protecting students from inappropriate content is a combination of technical filtering and a strong digital citizenship curriculum.

Dealing with Lost or Damaged Devices

Districts should have a plan to address the inevitable issue of lost, stolen, or damaged devices and ensure that parents and students are aware of their responsibilities in these situations.

PREVENTING DEVICE DAMAGE OR LOSS

The best way to deal with device loss or damage is to prevent it from happening in the first place. Implementing the following suggestions can help you prevent and reduce rates of device damage and loss:

- **Teach students responsible practices.** Explicitly discussing with students how they can protect themselves and their devices will help them care for what is likely to be the most expensive learning resource they have ever received from a school. Practices like discussing what they would do in hypothetical situations, group brainstorms of tips to keep themselves safe, and periodically asking students to share what they have learned about taking care of devices are all good starts to the effort.
- **Allow students to customize their devices.** When students are allowed to customize their device, they have a greater sense of ownership of them. Customization may include putting stickers on the device and choosing a unique desktop background image. Customization also helps prevent students from accidentally taking someone else’s device by making it easier to identify their own.
- **Require password lock when devices are not in use.** Many devices require a password after not having been in use for a certain amount of time. Requiring students to set a password on their device can help to make them unattractive to would-be thieves who lack the passcodes. This has the added benefit of preventing students from accessing other students’ work and accounts.
- **Prohibit students from carrying the device outside their backpacks.** In a school setting where all students carry devices from place to place, the chance of damage from being dropped is reduced if devices are moved only in backpacks. Asking students to stow devices in backpacks when moving outside the school can lessen the chances of device theft.
- **Install device-tracking software to locate a missing device and remotely render it inoperable.** If a device is lost or stolen from a student, tracking software can help you to alert authorities to the



Device Protection at All Grade Levels

Policies regarding device care can be made appropriate for even the youngest learners. A kindergarten teacher at Pachappa Elementary School in **Riverside Unified School District** in California said that not one of her 25 students’ devices has been broken in the 2 years her classes have used them.⁴⁷ Each kindergartener uses a small plastic tub (the kind designed for leftovers) to store his or her device when not in use. The teacher tells the students, “That’s their device’s ‘house.’” The plastic case that originally packaged the device is its “bed.” Kindergartners are taught to tuck their device into bed, wrapped in a cloth, its “blanket.” Then they put a “seatbelt” (a rubber band) around the case so that it will not “fall out of bed.”⁴⁷ Children carry their device’s “house” between school and home in their backpacks.

location for retrieval. This software can also help locate devices students may report as stolen that are actually misplaced. If such software is installed, establish clear policies that limit the use of this functionality to cases where the device has been reported lost or stolen or in an emergency.

- **Buy a protective case for the devices to protect them from accidental drops.** Before committing to a mass case purchase, ask manufacturers for trial versions and re-create the scenarios you envision occurring with students dropping devices. If purchasing cases is not part of your budget, this testing can help you supply families with a list of district-approved cases for guidance.

As you design the safety measures that make the most sense for your population, loop families in to your plan and ask for their feedback. This will make device safety everyone's responsibility.

DEALING WITH DEVICE DAMAGE OR LOSS

Whatever your strategy for dealing with lost or stolen devices, communicate it clearly and often with families and students to help embed safe practices across all stakeholders. Some of the strategies that districts use are:

- **Require payment.** Some districts require the student or family to pay for a device that is missing or damaged. The advantage to this approach is that it provides accountability for addressing the damage. However, it can also pose challenges for families who may not be able to afford the new device. For such families, if you choose this option have a plan for possible reduced or installment payments.
- **Contract insurance.** Establishing an insurance policy is the simplest but usually more expensive way to handle lost or missing devices. The insurance policy can either be paid by the district or by the families. If the latter, the district may need to have a solution in place for families who cannot afford the cost of device insurance. Consider a reduced rate or installment plan for these families.
- **Maintain extra inventory.** Some districts choose to self-insure by purposefully purchasing more devices than are needed for the initial rollout and keeping them in stock to replace broken or missing ones. If you self-insure, avoid use the term *insurance* when describing your program because it has legal meaning, and your district is not a licensed insurance company. Establish clear guidelines defining when the school or district is liable for repairing a student's device and when the student is liable (e.g., because of intentional misuse).



Less Damage When Devices Went Home

In Maine, in the first 4 years of the Maine Laptop Initiative (2002–06) schools had a choice to send laptops home or not. Roughly 50% of schools sent the devices home across the state. Data collected showed that damage was *higher* in schools that did not send the devices home than in schools that did. Based on these data, in 2006 the state mandated that schools send the devices home with students. In addition, schools that allowed students to take the devices home generally had better examples of digital learning activities because teachers felt greater flexibility in assigning projects that required longer and deeper uses of the devices.

Districts may establish additional consequences for students with repeated problems with maintaining their device or when there is evidence of intentional damage. Examples may include losing the privilege of taking

the device home or losing the use of the device altogether for a certain period. An older or less expensive device may be provided until the student can show he or she is able to properly maintain control over the original device. These decisions should balance accountability with the need to provide the student with the tools to complete schoolwork.

Conclusion

An essential element of providing equitable education for America's students is ensuring the existence of infrastructure to support personalized learning, collaboration, increased engagement, and creativity. Planning and providing infrastructure, both Internet connectivity and devices, should stem from a clear vision for how learning and teaching will be supported. This involves understanding a variety of technical options and legal requirements as well as seeking input from teachers, leaders, students, parents, and community members. This guide provides a list of options to consider and questions to ask to make sure you make the right choices when leading this change in your district.

Our students live in a connected world where they will be expected to engage and interact with peers and experts online, create and design with digital tools, and be exemplary digital citizens. With vision, infrastructure, professional learning, and devices, our schools will be better able to support students with the opportunity to learn and thrive.



Future Ready Schools: Quick Reference Guide of Key Questions

The questions listed below address many of the important considerations as you plan to bring and increase connectivity throughout your district and schools. Each set corresponds to further guidance within *Future Ready Schools: Building Technology Infrastructure to Support Learning*.

1. Getting Started: Assess Your Current Situation and Set Future Goals (*see Section 1*)

- What is the vision for learning that technology will be supporting?
- What digital learning resources will be needed?
- What kind of professional development will teachers need to become proficient with digital learning?
- What is your current network capacity?
- What is the current state of your physical infrastructure?
- How many and what type of devices does your network support now? What is planned for the future?
- What resources are available to fund the transition?

2. Getting High-Speed Internet to Schools (*see Section 2*)

- What are the options for high-speed Internet access in your area?
- Which of the connectivity path is best for your district's needs?
- What are the elements that will affect cost in your area?
- What funding sources are available to get Internet to schools?
- What resources are available for rural schools?

3. Getting High-Speed Internet Throughout Schools (*see Section 3*)

- What are the steps in planning a wireless network inside a school?
- What physical infrastructure considerations will impact the network?
- How should the network be provisioned, configured, and managed?
- How should security risks to the network be managed?

4. Getting Devices to Students and Teachers (*see Section 4*)

- Why are devices important?
- Which factors should be considered when selecting devices?
- What about BYOD programs?
- How will you pay for devices?
- What funding sources are available?
- How often will devices need to be replaced?
- How will devices be maintained?
- Should your school allow devices to be taken home?
- How should devices be rolled out?

5. Determining Responsible Use, Student Privacy, and Other School Policies (*see Section 5*)

- How should devices be managed?
- How can schools ensure and encourage responsible use of devices?
- What are school obligations for protecting the privacy of students?
- How should content filtering on devices work?
- Which policies for lost or damaged devices make sense?

Notes

- ¹ Fox, C., Waters, J., Fletcher, G., & Levin, D. (2012). *The Broadband Imperative: Recommendations to Address K-12 Education Infrastructure Needs*. Washington, DC: State Educational Technology Directors Association (SETDA).
- ² Federal Communications Commission. (2010). 2010 E-Rate Program and Broadband Usage Survey: Report. Available at http://transition.fcc.gov/010511_Eratereport.pdf
- ³ Federal Communications Commission. (2011). Seventh Broadband Progress Report and Order on Reconsideration. Available at https://apps.fcc.gov/edocs_public/attachmatch/FCC-11-78A1.pdf
- ⁴ The White House. Office of the Press Secretary. (2013). Remarks by the President at Mooresville Middle School - Mooresville, NC. Available at <http://www.whitehouse.gov/the-press-office/2013/06/06/remarks-president-mooresville-middle-school-mooresville-nc>
- ⁵ The White House, Office of the Press Secretary. (2013). President Obama's Plan for Connecting All Schools to the Digital Age. Available at http://www.whitehouse.gov/sites/default/files/docs/connected_fact_sheet.pdf
- ⁶ Donahue, N. & Garcia, L. (2014, July 7). A Working Model for Blended Learning in an Urban School. *Edutopia*. Available at <http://www.edutopia.org/blog/working-model-for-blended-learning-nicholas-donohue-lourenco-garcia>
- ⁷ Foster, M. (2013). Netcraft Analysis: Online Speed Testing Tools. Available at http://www.setda.org/c/document_library/get_file?folderId=353&name=DLFE-1647.pdf
- ⁸ Project Tomorrow. (2013). From Chalkboards to Tablets: The Emergence of the K-12 Digital Learner. Available at <http://www.tomorrow.org/speakup/pdfs/SU12-Students.pdf>
- ⁹ The White House, Office of the Press Secretary. (2013). President Obama's Plan for Connecting All Schools to the Digital Age. Available at http://www.whitehouse.gov/sites/default/files/docs/connected_fact_sheet.pdf
- ¹⁰ Fox, C., Waters, J., Fletcher, G., & Levin, D. (2012). *The Broadband Imperative: Recommendations to Address K-12 Education Infrastructure Needs*. Washington, DC: State Educational Technology Directors Association (SETDA).
- ¹¹ Education Superhighway. (2014, April). *Connecting America's Students: Opportunities for Action*. Available at http://www.educationsuperhighway.org/uploads/1/0/9/4/10946543/esh_k12_e-rate_spending_report_april_2014.pdf
- ¹² California Executive Order S-21-06. (2006, October 27). *Twenty-First Century Government: Expanding Broadband Access and Usage in California*. Available at <http://gov.ca.gov/news.php?id=4818>
- ¹³ NYC Information Technology & Telecommunications. (n.d.). Innovation: Broadband. Available at http://www.nyc.gov/html/doitt/html/business/micro_trenching.shtml
- ¹⁴ CTC Technology and Energy. (n.d.) Dark Fiber Lease Considerations. Available at <http://www.ctcnet.us/DarkFiberLease.pdf>

-
- ¹⁵ Gonzalez, L. (2013, August 1). Dark Fiber Paying off in Florida's Lakeland. *Community Broadband Networks*. Available at <http://www.muninetworks.org/content/dark-fiber-paying-floridas-lakeland>
- ¹⁶ Herold, B. (2014). Districts Get Creative to Build Faster Internet Connections. *Education Week*. Available at http://mobile.edweek.org/c.jsp?DISPATCHED=true&cid=25983841&item=http%3A%2F%2Fwww.edweek.org%2Ffew%2Farticles%2F2014%2F01%2F15%2F17fiber_ep.h33.html
- ¹⁷ Birkenbuel, R. (2014). Butte Schools' Fiber Optics Switch Featured in Nationwide Magazine. *The Montana Standard*. Available at http://mtstandard.com/news/local/butte-schools-fiber-optics-switch-featured-in-nationwide-magazine/article_d2cba792-826a-11e3-a083-001a4bcf887a.html
- ¹⁸ Fatbeam. (2013, July 10). Fatbeam Launches Fiber Optic Network in Butte, Montana. Available at <http://www.blcdc.net/wordpress/wp-content/uploads/2014/03/Community-Fiber-Optic-Network.pdf>
- ¹⁹ CSMG and Gates Foundation. (2011). *Connections, Capacity, Community: Exploring Potential Benefits of Research and Education Networks for Public Libraries*. Available at http://www.arkansased.org/public/userfiles/Legislative_Services/Quality%20Digital%20Learning%20Study/Reports/Connections%20Capacity%20Community.pdf
- ²⁰ State Educational Technology Directors Association. (2012). *The Broadband Imperative: Recommendations to Address K-12 Education Infrastructure Needs*. Available at <http://www.setda.org/web/guest/broadbandimperative>
- ²¹ The Utah Education Network (2012). Welcome to UEN. Available at <http://leadershipsummit.setda.org/wp-content/uploads/sites/5/2013/11/Welcome-to-UEN.pdf>
- ²² State Educational Technology Directors Association. (2012). *The Broadband Imperative: Recommendations to Address K-12 Education Infrastructure Needs*. Available at <http://www.setda.org/web/guest/broadbandimperative>
- ²³ MCNC. (n.d.). About MCNC. Available at <https://www.mcnc.org/about.html>
- ²⁴ MCNC. (2013, April 9). North Carolina "Races to the Top" in the Cloud. Available at <https://www.mcnc.org/news/nc-races-to-top-in-the-cloud>
- ²⁵ AT&T. (2013). Lake Tahoe Hits the Jackpot with Technology-Rich Learning Environment. Available at http://www.corp.att.com/edu/docs/lake_tahoe_netbooks.pdf
- ²⁶ Lake Tahoe Unified School District (2012). *Lake Tahoe Unified School District Education Technology Plan*. Available at <http://www.ltusd.org/userfiles/file/Tech%20Plan%202012-15%20FINAL%20without%20EETT%20Template.pdf>
- ²⁷ Cavanagh, S. (2013, July 28). A Closer Look at the FCC's Ideas for Revamping the E-Rate. *Education Week*. Available at http://blogs.edweek.org/edweek/DigitalEducation/2013/07/a_closer_look_at_the_e-rates_n.html?print=1
- ²⁸ Fulton County Schools. (n.d.). Fulton County Schools SPLOST. Available at <http://www.fultonschools.org/en/SPLOST>
- ²⁹ Navajo Nation Telecommunications Regulatory Commission. (2013). FCC Modernizing the E-Rate Program for Schools and Libraries: Comment from The Navajo Nation Telecommunications Regulatory Commission. Available at <http://apps.fcc.gov/ecfs/document/view?id=7520944058>

-
- ³⁰ Consortium for School Networking (2013). E-Rate and Broadband Survey. Available at <http://www.cosn.org/e-rate-broadband-survey>
- ³¹ Layton, L. (2013, September 11). Arne Duncan sells benefits of Common Core standards, technology to Arizona students. *The Washington Post*. Available at http://www.washingtonpost.com/local/education/arne-duncan-sells-benefits-of-common-core-standards-technology-to-arizona-students/2013/09/11/2485b58c-1b05-11e3-82ef-a059e54c49d0_story.html
- ³² Veres, M. (2013, October 1). Personal communication, Sunnyside Office of Public Information.
- ³³ Sunnyside Unified School District. (n.d.). Available at <http://www.susd12.org/>
- ³⁴ Beasley, W. (2013, November 6). Personal communication.
- ³⁵ School 2.0. (n.d.). Available at <http://etoolkit.org/etoolkit/>
- ³⁶ Greaves, T., Hayes, J., Wilson, L., Gielniak, M., & Peterson, R. (2010). *The Technology Factor: Nine Keys to Student Achievement and Cost-Effectiveness*. MDR.
- ³⁷ Chariho School District. (n.d.). Chariho 1:1 - An Investment in the Future: Our Journey Toward a Vision for Technology Use. Available at http://www.chariho.k12.ri.us/sites/default/files/1-1_vision.pdf
- ³⁸ Chariho School District. (n.d.) Chariho 1:1 Device Selection Advisory Committee. Available at http://www.chariho.k12.ri.us/sites/default/files/device_selection_advisory_committee_members.pdf
- ³⁹ Herold, B. (2014). Houston Launches Ambitious 1-to-1 Computing Initiative. *Education Week*. http://blogs.edweek.org/edweek/DigitalEducation/2014/01/houston_launches_ambitious.html
- ⁴⁰ Lhamon, C. U.S. Department of Education, Office for Civil Rights. (2014, October 1). Dear Colleague Letter: Resource Comparability. Available at <http://www2.ed.gov/about/offices/list/ocr/letters/colleague-resourcecomp-201410.pdf>
- ⁴¹ CASBO (California Association of School Business Officials). (n.d.). New California bond solution developed to fund educational technology. Available at <http://www.casbo.org/?NewSchoolBondSolution>
- ⁴² Davis, M. (2013, October 29). Critics See Risks in Use of Bonds for School Tech Projects. *Education Week*. Available at <http://www.edweek.org/ew/articles/2013/10/30/10bond.h33.html>
- ⁴³ Consortium for School Networking. (2013). E-rate and Broadband Survey 2013. Available at <http://www.cosn.org/sites/default/files/2013EratebroadbandFinal.pdf>
- ⁴⁴ Selk, A. (2013, Jan 13). School district giving out free wifi hotspots to families without Internet. *Dallas Morning News*. Available at <http://irvingblog.dallasnews.com/2013/01/school-district-giving-out-free-wifi-hotspots-to-families-without-internet.html/>
- ⁴⁵ Herold, B. (2014). Houston Launches Ambitious 1-to-1 Computing Initiative. *Education Week*. http://blogs.edweek.org/edweek/DigitalEducation/2014/01/houston_launches_ambitious.html
- ⁴⁶ Norris, C., & Soloway, E. (2011). Tips for BYOD K12 Programs. Critical Issue in Moving to “Bring Your Own Device.” Available at <http://www.districtadministration.com/article/tips-byod-k12-programs>
- ⁴⁷ Straehley, D. (2013, May 24). RIVERSIDE: District introduces textbooks on iPod, other tablets. *The Press-Enterprise*. Available at <http://www.pe.com/local-news/topics/topics-education-headlines/20130524-riverside-district-introduces-textbooks-on-ipod-other-tablets.ece>



OFFICE OF
Educational Technology

The Mission of the Department of Education is to promote student achievement and preparation for global competitiveness by fostering educational excellence and ensuring equal access.

<http://tech.ed.gov>



This work is licensed under a Creative Commons
[Attribution 4.0 International License](https://creativecommons.org/licenses/by/4.0/).