

Josip Juraj Strossmayer University of Osijek  
Faculty of Education and Department of Mathematics

---

Sveučilište Josipa Jurja Strossmayera u Osijeku  
Fakultet za odgojne i obrazovne znanosti i Odjel za matematiku

# **HIGHER GOALS IN MATHEMATICS EDUCATION**

---

---

## **VIŠA POSTIGNUĆA U MATEMATIČKOM OBRAZOVANJU**

**monograph**

*Editors:*

**Zdenka Kolar-Begović  
Ružica Kolar-Šuper  
Ivana Đurđević Babić**

Osijek, 2015

## **International Scientific Committee**

### *Josip Juraj Strossmayer University of Osijek*

Rudolf Scitovski  
Mirta Benšić  
Zdenka Kolar-Begović  
Ružica Kolar-Šuper  
Ivana Đurđević Babić  
Šime Ungar  
Ljerka Jukić Matić  
Ivan Matić  
Marijana Zekić-Sušac

### *University of Zagreb*

Željka Milin Šipuš  
Aleksandra Čižmešija  
Vladimir Volenec  
Mirko Polonijo

### *Foreign universities*

Anders Hast (Sweden)  
Emil Molnár (Hungary)  
Tatjana Hodnik Čadež (Slovenia)  
Edit Debrenti (Romania)  
Sead Rešić (Bosnia and Herzegovina)

## **The Editorial Board**

Emil Molnár (Hungary)  
Anders Hast (Sweden)  
Tatjana Hodnik Čadež (Slovenia)  
Edit Debrenti (Romania)  
Sead Rešić (Bosnia and Herzegovina)  
Zdenka Kolar-Begović (Croatia)  
Ružica Kolar-Šuper (Croatia)  
Ivana Đurđević Babić (Croatia)  
Ljerka Jukić Matić (Croatia)

## **Monograph referees:**

Šime Ungar (Croatia)  
Bettina Dahl Søndergaard (Denmark)  
Maria Alessandra Mariotti (Italy)

## A word from the Editorial Board

---

---

The Croatian educational system is facing an extensive curriculum reform that will reflect on all education segments and not only on the content of school subjects. The leaders of the reform advocate the emphasis on competence development, especially in mathematics education where the development of ideas was neglected. Educational changes are present around the world. These changes point to the necessity of devising new methods for teaching and learning mathematics as well as improving classroom practice. We dare say that such change should be constant, not something that will happen once, but it should become daily work for every teacher, mathematics educator and mathematician, spanning across all educational levels.

Mathematics education reforms call for decreasing the emphasis on complex paper-and-pencil computation drills and placing greater attention to mental computation, estimation skills, thinking strategies for mastering basic facts and conceptual understanding of arithmetic operations. Reform educators believe that such understanding is best pursued by allowing children to solve problems using their own understanding and methods. Under the guidance of the teacher, students eventually arrive at an understanding of standard methods. Such learning can occur in student-centered classrooms, using new, innovative, contemporary methods of teaching, and abandoning traditional transmission of knowledge. The challenges of contemporary teaching of mathematics can be overcome with continuing teachers' professional development. Facilitators of mathematics teachers' professional development are looking for effective ways to promote teachers' learning. This learning can be described in terms of knowledge, beliefs, and teaching practice, thus one of important aspects of teacher professional development is challenging their beliefs about the nature of mathematics as a static discipline with a known set of rules and procedures, into a dynamic body of knowledge which is a result of discoveries from experimentation and application. Such change would influence teaching practice in the long run. Therefore, improving teachers' knowledge but also changing teaching practice leads to improvement of students' competencies (Lipowsky & Rzejak, 2012).

Various studies detected a causal relationship between teachers' mathematical knowledge and beliefs and students' achievement (e.g., Hill et al., 2007). In that manner, the International Association for the Evaluation of Educational Achievement carried out the Teachers Education and Development Study in Mathematics (TEDS-M) to investigate content and pedagogical content knowledge of future mathematics teachers (Blömke et al., 2014). This international comparative study of teacher education placed its focus on the preparation of mathematics teachers at the primary and lower secondary levels of education.

Teachers' content and pedagogical content knowledge is very important because that knowledge helps teachers recognise and then act upon the teaching opportunities that come up in the moment (Anthony & Walshaw, 2009). Teachers

should have mathematical competence to solve problems, but, on the other hand, they also need to be good at problem posing. They should know how to choose, modify and create problems with a didactic purpose, i.e., to be able to critically evaluate the quality of the mathematical activity required to solve the problem proposed and, if necessary, to be able to modify the problem in order to facilitate a richer mathematical activity (Malaspina et al., 2014).

Apart from rankings of student performance, the value of TEDS-M, international comparative research, stems from an insight that each participating country may gain through comparisons with other systems and models. However, these comparisons from other countries can also help developing insights into policy that may help to improve education in our own countries.

From the contributions in this monograph, it appears that awareness of future teachers' beliefs and knowledge is present in the Croatian tertiary education. The studies investigate various aspects of pre-service and in-service teachers' characteristics, like beliefs, knowledge, digital competencies or using ICT in teaching. But the contributions also portray another picture: mathematics education is becoming accepted as a field of scientific research in this region. Although mathematics education research is a young scientific field, it has been recognised that changes in the curriculum and teaching practice should draw upon findings from well-established mathematics education studies. Therefore, in order to enhance mathematics teaching and learning in Croatia and the surrounding countries, there should exist continuous collaboration between communities of mathematics researchers and teacher practitioners, since one of many problems is how to make research results more usable in the classroom:

“It takes time before they become known, so we researchers must become better at developing results in a form that makes them easier to use in practice, in the classroom.” (Johan Lithner)

The aforementioned collaboration must be a two-way street: practitioners should learn from scientists, but scientists should also learn from practitioners.

We believe that this monograph contributes to strengthening mathematics education as the field of research in the region and enhances existing knowledge in the field.

## References

- [1] ANTHONY, G., & WALSHAW, M. (2009), *Effective pedagogy in mathematics: Educational practices series, 19*, International Academy of Education, International Bureau of Education & UNESCO. Available online from the UNESCO website.
- [2] BOESEN, J., BERGQVIST, E., BERGQVIST, T., LITHNER, J., PALM, T., & PALMBERG, B. (2014), *Developing mathematical competence: From the intended to the enacted curriculum*, *The Journal of Mathematical Behaviour*, **33**, 72–87.

- [3] BLÖMEKE, S., HSIEH, F. J., KAISER, G., & SCHMIDT, W. H. (2014), *International Perspectives on Teacher Knowledge, Beliefs and Opportunities to Learn: TEDS-M Results*, Dordrecht, The Netherlands: Springer.
- [4] HILL, H. C., SLEEP, L., LEWIS, J. M., & BALL, D. L. (2007), *Assessing teachers' mathematical knowledge: What matters and what evidence counts?* In F. K. Lester (Ed.), *Second Handbook of Research on Mathematics Teaching and Learning* (pp. 111–156), Charlotte, NC: Information Age.
- [5] LIPOWSKY, F., & RZEJAK, D. (2012), *Lehrerinnen und Lehrer als Lerner-Wann gelingt der Rollentausch?: Merkmale und Wirkungen wirksamer Lehrerfortbildungen*, In D. Bosse (Ed.), *Theorie und Praxis der Schulpädagogik: Vol. 4. Reform der Lehrerbildung in Deutschland, Österreich und der Schweiz* (pp. 235–254), Immenhausen: Prolog Verlag.
- [6] MALASPINA, U. & VALLEJO, E. (2014), *Problem posing in pre-service primary teachers' training*, In Oesterle, S., Nicol, C., Liljedahl, P. & Allan, D. (Eds.) *Proceedings of the Joint Meeting of PME 38 and PME-NA 36*, Vol. 6, p. 159, Vancouver, Canada: PME.

Osijek, May 20, 2015

*The Editorial Board*



# Contents

---

---

<b>Preface</b> .....	3
<b>IN MEMORIAM: Dr. Margita Pavleković</b> .....	5
<b>1. Some new strategies and approaches to algorithms and problem solving in mathematics</b>	
<i>Tatjana Hodnik Čadež, Vida Manfreda Kolar</i> Understanding of mathematically gifted students' approaches to problem solving .....	27
<i>Maja Cindrić, Irena Mišurac</i> Contemporary methods of teaching mathematics – the discovering algorithm method. Algorithm for fraction division .....	41
<i>Edith Debrenti</i> Word problems in mathematics teaching .....	59
<i>Karmelita Pjanić, Edin Liđan</i> Graphical representations in teaching GCF and LCM .....	72
<b>2. The effective integration of information and communication technologies (ICT) into teaching mathematics</b>	
<i>Anders Hast</i> Mathematics + Computer Science = True .....	85
<i>Marijana Zekić-Sušac, Ivana Đurđević Babić</i> Discovering patterns of student behaviour in e-learning environment .....	94
<i>Ivana Đurđević Babić, Anita Marjanović</i> Classification trees in detecting students' motivation for maths from their ICT and Facebook use .....	113
<i>Josipa Matotek</i> Using Moodle in teaching mathematics in Croatian education system .....	130
<i>Karolina Dobi Barišić</i> Future teachers' perception on the application of ICT in the process of assessment and feedback .....	142

### 3. Approaches to teaching mathematics

*Dušan Munđar, Zlatko Erjavec*

Pass rates in mathematical courses: relationship with the state matura exams scores and high school grades ..... 153

*Sead Rešić, Ivana Kovačević*

Approaches to teaching mathematics in lower primary education ..... 164

*Zoran Horvat*

Issues in contemporary teaching of mathematics and teacher competencies ..... 176

*Ksenija Romstein, Stanislava Irović, Mira Vego*

Teaching Mathematics in early education: current issues in classrooms ..... 187

### 4. Fostering geometric thinking

*Doris Dumičić Danilović, Sanja Rukavina*

Preservice mathematics teachers' problem solving processes when working on two nonroutine geometry problems ..... 205

*Karmelita Pjanić, Sanela Nesimović*

Tendencies in identifying geometric shapes observed in photos of real objects – case of students of primary education ..... 228

*Emil Molnár, István Prok, Jenő Szirmai*

Visual mathematics and geometry, the “final” step: projective geometry through linear algebra ..... 239

*Vladimir Volenec*

Is any angle a right angle? ..... 250

*Zdenka Kolar-Begović, Ružica Kolar-Šuper, Vladimir Volenec*

An interesting analogy of Kimberling-Yff's problem ..... 257

### 5. Attitudes toward and beliefs about mathematics and teaching mathematics

*Ljerka Jukić Matić, Ana Mirković Moguš, Marija Kristek*

Pre-service teachers and statistics: an empirical study about attitudes and reasoning ..... 265



<i>Aleksandra Čižmešija, Željka Milin Šipuš</i> Beliefs about mathematics and mathematics teaching of students in mathematics education programme at the Department of Mathematics, University of Zagreb .....	280
<i>Željko Rački, Ana Katalenić, Željko Gregorović</i> Self-reported creativity of primary school teachers and students of teacher studies in diverse domains, and implications of creativity relationships to teaching mathematics in the primary school .....	283
<i>Ljerka Jukić Matić, Dubravka Glasnović Gracin</i> How Croatian mathematics teachers organize their teaching in lower secondary classrooms: differences according to the initial education .....	303
<i>Goran Trupčević, Anđa Valent</i> Structures of Croatian Mathematics Textbooks .....	318
<b>Index</b> .....	331
<b>Acknowledgment to sponsors</b> .....	337



# HIGHER GOALS IN MATHEMATICS EDUCATION

monograph

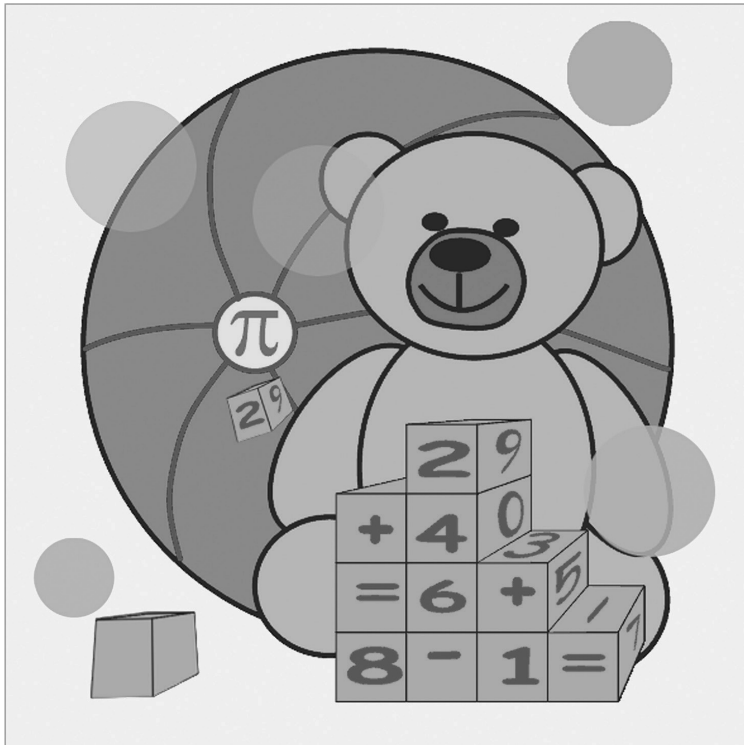



## Preface

---

---

The desire of the editors of and the contributors to this monograph is to encourage the reader to reflect on the use of new trends in the teaching of mathematics. The authors present the results of research conducted in a number of countries by providing significant contributions to increasing the quality of the teaching of mathematics at all levels of education. In addition to the authors from Croatia, authors from Sweden, Slovenia, Hungary, Romania and Bosnia and Herzegovina have made significant contributions as well.

The *In Memoriam* segment is dedicated to the initiator of the international scientific colloquium *Mathematics and Children* and the editor of proceedings volumes *How to teach and learn mathematics* and three monographs *Learning Outcomes*, *The Math Teacher* and *Mathematics Teaching for the Future*, Dr. Margita Pavleković, Associate Professor, who unfortunately passed away last year (on 20 August 2014). In his tribute to the late Professor Pavleković, Professor Mirko Polonijo writes about her life, teaching, scientific interests and major scientific achievements. All of us who worked with Professor Pavleković are grateful for many beautiful memories, moments and experiences she shared with us. Infinite life energy and enthusiasm for new knowledge were the main characteristics of Professor Pavleković. In her teaching, she paid a lot of attention to teaching and working with gifted students.

*Some new strategies and approaches to algorithms and problem solving in mathematics* is the title of the first chapter that gives an overview of research and suggestions related to the approach to the solution of problems in mathematics teaching of gifted students. As problem solving in mathematics is a leading creative activity, the authors would like to encourage mathematics teachers to integrate problem solving into their teaching practice. This would be challenging for gifted students and it would enable them to develop their potentials.

Chapter 2, *The effective integration of information and communication technologies (ICT) into teaching mathematics*, presents experience gained by practicing teachers from Sweden and Croatia of applying ICT in the teaching of mathematics. The authors refer to the growing use of learning management systems in mathematics education and consider the possibilities of applying machine learning methods for educational purposes with the aim of finding out some new facts about the behaviour of students that directly or indirectly affects mathematics teaching. The authors discuss the importance, possibilities and ways of using ICT in teaching mathematics at various levels of education (primary, secondary and university). Special attention in the monograph is focused on mathematics teachers and the integration of technology into various aspects of mathematics education. Given

that in any national curriculum, including the current Croatian curriculum, major emphasis in teaching mathematics is most commonly placed on achieving the learning outcomes, the goal of the monograph is to encourage the intensity of the positive impact of using information and communication technologies (ICT) in education in order to efficiently achieve the learning outcomes in mathematics and constructive teaching of mathematics.

In addition to considering the impact of points scored in the state graduation exam and high school grades on student achievement in college mathematics courses, Chapter 3, *Approaches to teaching mathematics*, provides insight into the teaching of mathematics as well as the problems of the modern teaching of mathematics in pre-school and primary education. In the context of contemporary mathematics teaching, the authors use a critical approach to assess the way and content of teacher education as well as the required competencies of mathematics teachers of high quality.

In the next chapter, *Fostering geometric thinking*, the authors study some interesting problems of geometric character. The importance of visualisation in teaching the content of geometric nature is stressed. Association of geometric content with real situations and objects is recommended for the realisation of this task. The authors emphasise that competencies related to spatial thinking, in particular spatial visualisation, should be among teacher competencies. The processes and difficulties in resolving the tasks of geometric nature are discussed.

The last chapter of the monograph, *Attitudes toward and beliefs about mathematics and teaching mathematics*, brings the views and considerations of mathematics teachers and future mathematics teachers of mathematics, organisation of mathematics education and the teaching of mathematics itself. The authors consider the relation between student achievement and initial education of mathematics teachers relying on the international study Teacher Education and Development Study in Mathematics (TEDSM) which investigates mathematics education programs and mathematical content and pedagogical content knowledge of future teachers depending on their initial education. Research on teachers' attitudes towards statistics, as well as their understanding of statistical concepts in achieving success when implementing a statistics curriculum, is also presented. Textbooks which play an important role in every mathematics classroom are compared in this chapter as well.

*The Editorial Board*

## IN MEMORIAM

## Dr. Margita Pavleković, Associate Professor (Dalj, 8 December 1948 – Osijek, 20 August 2014)

---



---

On 20 August 2014, members of the Department of Mathematics, Faculty of Science, University of Zagreb, received the following sad news, “Dear colleagues, it is with great sadness that we announce that our dear colleague and friend, Professor Margita Pavleković, a long-time associate of our Department, a professor at the University of Osijek and one of the first heads of the Seminar on Teaching Mathematics, passed away this morning after a critical illness. She will be remembered by great enthusiasm for promoting the quality of mathematics education and popularisation of mathematics, as well as for being a great fighter. The funeral of our dear Margita will be held on Friday, 22 August 2014, at 2 pm at the Central Cemetery in Osijek.” The news spread all over our mathematical community and beyond. The news of her death saddened many who directly or indirectly knew Dr. Margita Pavleković, Associate Professor at the Faculty of Teacher Education in Osijek, a scientific advisor in an interdisciplinary field of science, areas of mathematics and pedagogy, both as a person and as an expert, through her thought words and action. A commemorative service was held at the Faculty of Teacher Education on the day of the funeral at 11 am. [The transcript of the eulogy given at the funeral by the head of the Department of Natural Sciences, Faculty of Teacher Education, Dr. Zdenka Kolar-Begović, Associate Professor, was published in the journal “Matematika i škola” XVI, No. 76, pp. 40–42. More information about the life and work of the late Professor Margita Pavleković can be found in Glasnik matematički 2014 Yearbook, pp. 543–561]



Three months earlier, in May 2014, scientific advisor Margita Pavleković was granted the Faculty of Teacher Education Lifetime Achievement Award “for her exceptional contribution to the Faculty of Teacher Education in Osijek and promotion of its position and reputation as well as her exceptional contribution to

the popularisation of mathematics as an important factor in motivating pupils and students to engage in mathematics (...).” This was the academic year in which Professor Pavleković reached 65 years of age and hence she was supposed to retire on 1 October.

Many of Professor Pavleković’s friends, colleagues and admirers, along with family members, alumni and students gathered on 12 December 2014 at a commemoration service held at the Department of Mathematics, Faculty of Science, University of Zagreb, in memory of our dear colleague and meritorious promoter of mathematics and mathematics education.

The late Margita Pavleković was born on 8 December 1948 in Dalj. She completed her primary and secondary school education in Osijek, where she graduated in 1967. Two years later, she graduated from the two-year study of mathematics and physics at the Academy of Pedagogy in Osijek with the paper entitled *Sets of numbers* and obtained the mathematics and physics teacher certification degree. She started to work in a primary school but later she moved to a high school. In the period 1969–1974, she taught mathematics and physics at the elementary schools in Vladislavci and Čepin, and from 1974 to 1981, she taught mathematics and descriptive geometry at Osijek High School specialising in natural sciences and mathematics, which was later renamed as the Centre for Vocational Education “Braća Ribar”. In a letter in which a former student of hers talks about Professor Pavleković’s work at that school, he writes: “In addition to her professional, scientific and human side that fellow mathematicians talked about at the commemoration service, I would like to mention briefly what our Margita did in the organisation of a completely new specialisation in vocational education in 1978 for us students. We were the first generation of the vocational education programme majoring in mathematics and informatics. Back in 1978, there were no unique textbooks that would cover all the material (there was intensive teaching of mathematics expanding both knowledge width and depth). Margita got college textbooks – every student’s desk had a copy of each textbook, so that students did not have to purchase any textbooks or bring them to classes. She also managed to get scientific calculators (at that time, they were rather expensive and not all of us could afford to buy one) and let everyone use them, both during classes and in-class examinations. She took care of us and our majors – not only mathematics, but also physics and informatics (which was in its infancy then, with no possibility of practice: everything was learnt “by heart”), struggled to raise the quality of teaching, organised tours of data centres and high-quality IT practical training. Her course in vectors was pure poetry in comparison to the earlier dull interpretation of vectors (“by definition”) – with plenty of practical examples, almost “stunts”! Finally, in the fourth grade, almost a third of us participated in the mathematics competition at the level of the former republic (today it would be the national competition), and one student took part in in the physics and the mathematics competition at the national level, respectively. And finally, in the autumn we enrolled at best and most popular faculties with best scores. . . .”

In the meantime, while working, studying and raising her two girls, in 1975 she obtained a BSc degree in mathematics with descriptive geometry from the Department of Mathematics, Faculty of Science, University of Zagreb, with the thesis entitled *The algebra of dual and split-complex numbers*. She was fortunate to take



classes in Osijek. In fact, as she said in one speech, in 1971, you could count on the fingers of one hand the number of maths teachers holding a university degree in Osijek. BSc degree holders in mathematics were rare in Osijek secondary schools, universities, and the economy. A hundred mathematics teachers from Osijek and the surrounding area holding mathematics teacher certification degrees decided to take action to improve that situation. As a result, a complementary study in mathematics was launched in Osijek that was financially supported by the Employment Office in Osijek and organisationally backed by teachers from the Department of Mathematics, Faculty of Science, University of Zagreb. Let us mention that eighty students enrolled in the first year of this additional in-service training programme, and only twelve of them managed to enrol in the second year and successfully complete the study.

Since the 1978/79 academic year, Professor Pavleković worked as an associate at the Faculty of Education in Osijek (in 1977, the Academy of Pedagogy grew into the Faculty of Education) teaching courses within the framework of the study programme in mathematics, i.e., exercise sessions in *Linear Algebra* and *Vector Spaces*. On 1 October 1981, she was appointed assistant in the area of natural sciences, field mathematics, branch teaching mathematics, which would mark her entire career and be both the subject and the field of her interest, research, writing and lectures. In 1984, Margita Pavleković obtained her MSc from the Department of Mathematics, Faculty of Science, University of Belgrade, with the thesis entitled *Solving systems of algebraic equations* mentored by Professor Slaviša Prešić. After obtaining her MSc degree, she was appointed research assistant (she was appointed assistant and research assistant on 1 April 1984 and 1 September 1992, respectively).

Margita Pavleković obtained her PhD degree in mathematics from the Department of Mathematics, Faculty of Science, University of Zagreb, on 11 July 1993. The academic degree of Doctor of Natural Sciences in the field of mathematics was conferred upon her by the University of Zagreb in 1993. The doctoral dissertation entitled *The difficulties students encounter in mathematics classes in the final years of primary school and the ways of their elimination* was written under the supervision of Professor Boris Pavković. It should be noted here that this was the first PhD in mathematics education obtained from the Faculty of Science, i.e., any Department of Mathematics in Croatia. In other words, this was the first PhD in mathematics education in Croatia.

On 1 October 1996, Professor Pavleković was appointed assistant professor in the natural sciences, field mathematics, branch mathematics education, at the Faculty of Education, University of Osijek, in the study programmes granting a Bachelor's degree in mathematics and physics and a Bachelor's degree in elementary education.

When within the framework of the reorganisation of the University of Osijek the Teacher Training College (in 1998) and the Department of Mathematics (in 1999) were established as independent institutions, Dr. Margita Pavleković worked for two years at both of these institutions. On 15 July 2000, she was appointed tenured college professor in the natural sciences, field mathematics, for courses *Mathematics education* and *Mathematics*. From 1 October 2000 she worked full-

time as a tenured college professor at the Teacher Training College, later the Faculty of Teacher Education of Josip Juraj Strossmayer University of Osijek.

On 30 April 2005, she was appointed assistant professor in the natural sciences, field mathematics, for the second time.

Professor Pavleković was appointed associate professor on 23 May 2011 in the field of interdisciplinary science, mathematics and pedagogy.

Here it should be noted that this appointment procedure was initiated in 2008 and lasted from March 2009 until April 2011, due to its redirection from social sciences, field pedagogy, to the field of interdisciplinary science, mathematics and pedagogy. However, the consequence of the overall long procedure, which Dr. Margita Pavleković experienced many times before, partly because her cases were precedents, and partly due to carelessness and lack of understanding outside mathematical circles, was unjust. She could not be appointed full professor because of the time limit, and her entire work, activities and numerous achievements prove that she absolutely deserved that appointment.

Fortunately, the procedure for appointment to the highest scientific position was initiated. Encouraged by the members of the previous expert committee, the members of the Scientific Field Committee and colleagues from the Faculty, in February 2012 Dr. Margita Pavleković launched the election procedure and on 25 September 2012 she was appointed scientific advisor in an interdisciplinary field of science (mathematics and pedagogy).

It should be pointed out here that shortly afterwards (i.e., on 19 February 2013) the National Science Council appointed Dr. Margita Pavleković member of the Scientific Field Committee for an interdisciplinary field (science, arts) for the period 2013–2017. Unfortunately, 18 months later, Dr. Margita Pavleković passed away.

Professor Pavleković was dean of the Teacher Training College from 2003 to 2006. By her wholehearted commitment she significantly contributed to the transformation of teacher training colleges to faculties of teacher education. The last of her duties at the Faculty of Teacher Education was director of the Department for Continuing Education. Once, i.e., 1986–1999, she was head of the Department of Mathematics and Informatics at the Faculty of Education.

At the University of Osijek, Professor Pavleković taught the following courses: *Teaching Mathematics with Informatics*, *Elementary Mathematics* and *Linear Algebra* at the Department of Mathematics, and *Mathematics*, *Teaching Mathematics*, *Algebra*, *Learning and Playing on the Computer*, *Mathematics and Talented Students*, and *Recreational Mathematics* at the Faculty of Teacher Education.

From 1994 to 1996 she was a visiting teacher at the Faculty of Science and Education, University of Split, teaching in the study programmes granting a Bachelor's degree in mathematics and informatics and a Bachelor's degree in elementary education (*Mathematics I*, *Non-Euclidean Spaces*, *Geometric Models*, *Elementary Mathematics*). In her last academic year 2013/14, as well as in the previous two academic years, she also held classes outside Osijek, i.e., in Pula. Those were lectures in the courses *Teaching Mathematics I*, *II*, *III* in the fourth and fifth year of the Integrated undergraduate and graduate university study programme of teacher

education at the Department of Educational Sciences, Juraj Dobrića University of Pula. She mentored about 80 students in various study programmes in preparing their theses.

Dr. Margita Pavleković was a researcher on several scientific projects supported by the Ministry of Science, Education and Sports: 1984–1996 *Teaching mathematics* (headed by B. Pavković, Faculty of Science, Zagreb), 1996–2000 *Pedagogical assistance to children refugees and returnees* (headed by A. Peko, Faculty of Education, Osijek) and *Education and training model in the Croatian Danube Region* (headed by I. Vodopija, Faculty of Education, Osijek). Dr. Pavleković was the principal investigator on the project *Teaching mathematics at the Faculty of Education from 2000 to 2002* and the same project at the Faculty of Teacher Education from 2002 to 2006. Later, since April 2008 she was the principal investigator of the project *Education of students with special interest in mathematics*.

She was a member of the Croatian Society of Mathematicians and Physicists since 1983, i.e., the Croatian Mathematical Society since its foundation in 1991, and Osijek Mathematical Society since 1993. She was the first secretary of the branch (from its foundation in 1993 to 1995). She was also a member of the American Mathematical Society (since 1996) and A Magyar Tudományos Akadémia tagja (since 2003).

For many years, Professor Pavleković was devotedly involved in numerous social and professional activities, particularly those in areas related to education. She was a co-author, but the principal co-author, of a mathematics textbook and accompanying materials for the first grade in elementary school where she included parts of a Croatian fairy tale Regoč written by Ivana Brlić Mažuranić, and showed how the plot of that fairy tales can be the basis of the correlation in the first grade mathematics. She reviewed many books in the fields of mathematics and informatics for primary and secondary schools, she was an active member of the movement “Science to Youth”, established and led a series of mathematics summer, winter and permanent schools and courses for elementary and secondary school children, where she also delivered lectures, as well as in national and regional seminars for mathematics teachers.

In 1994, the Ministry of Science and Technology appointed Dr. Margita Pavleković head of the Examination Committee for conducting professional examinations in mathematics of primary and secondary school mathematics teachers: she inspected over 550 professional examinations in mathematics taken by both primary school teachers and mathematics teachers.

She was a member of editorial boards of the following publications: *Matematičko-fizički list* (since 1991), *Matka* (since 1993), *Matematika i škola* (since 1999), and *Život i škola* (since 1999).

She authored or co-authored about thirty scientific and forty professional papers in Croatian and foreign publications. This includes two university textbooks (in several editions), a scientific study, a textbook set and a trilingual professional and popular book.

Dr. Pavleković’s work is primarily related to the teaching of mathematics in all its aspects, such as her contribution dedicated to enriching and expanding the

content of teaching, the popularisation of mathematics and scientific reflections on the topics in the field of mathematics education. However, her overall long-term activity was truly interdisciplinary. In particular, it was related to the teaching of mathematics in primary schools, especially to finding original methodological approaches, scientific explanations and procedures resulting in more effective mathematical literacy of children and teacher training students, but also to life-long teacher training. She explored and constantly scientifically explained the situation in the classroom trying to find the ways to improve it by means of original methodological approaches. In addition, the past decade of her research interest was focused on the problem of recognition of mathematically gifted students. She included students, junior researchers, assistants and school teachers into her research, trying to achieve successful collaboration of the Faculty, school and home.

Professor Margita Pavleković was specially engaged in designing, initiating and organising an international conference *Mathematics and Child* (International Scientific Colloquium “Mathematics and Children”), whose first meeting was held in 2007. Her major contribution related to the teaching of mathematics and mathematics education is marked by her university textbooks *Teaching mathematics with informatics I* (1997) and *II* (1999) and the scientific study *Mathematics and talented students – curriculum development at teacher training studies for the identification, training and support to gifted and talented students* (2009).

The dedication in the book *Mathematics and talented students* reads: “The book itself and the results referred to therein are dedicated to scientists, organ and tissue donors, transplant teams and my family.” Namely, at the beginning of the nineties, “during the Homeland War we lived in cellars. We were freezing while Osijek was showered with shells. Stress and cold contributed to the failing of my kidneys. I was about to start dialysis. And I went through nine years of dialysis.”

Throughout those nine long years Professor Pavleković was under constant pressure of uncertainty regarding her possible kidney transplantation because of her specific “parameters” implying that there was a little chance for her to find an adequate donor. In early 2002, on Tuesday 15 January at Zagreb Clinical Hospital Centre Rebro Margita Pavleković received a kidney transplant. In the same year, she published the book *The Gift of Donated Life*, in which she “described her regular dialysis treatment and the waiting time for a kidney transplant. She described the difficult, but also happy moments when she had a chance to get a new organ and return to full health, though through painstaking surgery and a difficult period following it. It is an instructive and moving story, and many readers were deeply touched. Her experience encouraged many who have not had the opportunity to learn about posthumous organ donation as a high level of civilisation. Through her work in the public, she greatly contributed to promoting the culture of posthumous organ donation and transplantation treatment.” A year later, in 2003, the book was published as a trilingual edition, complemented by translations into English and Hungarian. In the same year, Dr. Margita Pavleković presented *The Gift of Donated Life* personally in Lisbon, as the president of the Croatian Association of dialysed, transplanted and chronic kidney diseased patients at the annual CEAPIR (the global kidney patients’ federation) meeting. The introductory part of her book concludes by saying: “The author strongly hopes that her authentic story will contribute to raising interest of people in this subject, and then consequently to increasing the number of those who will choose to donate organs after their death, as a distinctive

expression of altruism and human solidarity. The author sincerely thanks all people who spend their time on this topic and share their interest with others.”

Having learned the sad news, Dr. Igor Povrzanović, a former president of the Croatian Donor Network sent a letter expressing deep condolences to the family, colleagues and friends of the late Dr. Margita Pavleković, thanking for the opportunity to be able to indirectly address the gathering at the commemoration service with these words: “Professor Pavleković coped with her disease for years, with courage and dignity, with a lot of optimism and determination, and at the same time with so much humanity and concern for the entire population of affected patients patiently waiting for a transplant and the preservation of their life and health. She took an open and decisive attitude that solidarity of the citizens had to be encouraged in this case. Through her activities, she was a role model who contributed much to the general positive climate towards posthumous organ donation by her public activity and publications. In cooperation with us and in harmony with many organisations and individuals, almost the world’s best transplant results in our country are achieved. Ms. Pavleković gave her immediate contribution to the preservation of life and health of thousands of patients. We sincerely thank her for that. We will remember and honour her great contribution and her smiling, happy, humane and optimistic person. We express our particular gratitude, the Croatian Donor Network and the former president Dr. Igor Povrzanović.”

Dr. Margita Pavleković was an appreciated and recognised university teacher characterised by a significant, outstanding and successful teaching and research career, scientific and professional, great social and selfless commitment. She had an impressive résumé marked by commitment to the teaching of mathematics at all levels and in all aspects. She made interesting, valuable and original contributions within the field of mathematics education. With years of dedicated teaching at the Faculty of Teacher Education and the Department of Mathematics, University of Osijek, and tireless and dedicated activity through the Osijek branch of the Croatian Mathematical Society, she improved the quality and contributed to modernisation and raising of the level of mathematics teaching in our schools and universities.

All who knew Professor Margita Pavleković, no matter how they addressed her, as Professor Pavleković, colleague Pavleković or closely – Margita or even closer – Mancika, they admired her particularities and peculiarities, versatile talents, strength and courage in the frail body, life reality, optimism and poetry of her life, humour and firmness. She loved life, she knew how to enjoy it, and she knew how to transfer that to all who surrounded her. She was a great fighter and always ahead of time, often under-appreciated and under-recognised, but that did not hinder her from acting or discourage her. Indeed, it gave rise to persistence in her personal and public life making her to strive to better, more correct and more valuable living. She was just and good. She helped many people to become fairer and better. She spread love around in the broadest sense of the word.

*Mirko Polonijo*

*Translated by Ivanka Ferčec*

## Prof. dr. sc. Margita Pavleković (Dalj, 08. 12. 1948. – Osijek, 20. 08. 2014.)

---



---

Članovi Matematičkog odsjeka Prirodoslovno-matematičkog fakulteta Sveučilišta u Zagrebu dobili su 20. kolovoza prošle 2014. godine tužnu vijest s riječima “Drage kolegice i kolege, s velikom tugom javljamo Vam da je jutros, nakon teške bolesti preminula draga kolegica i prijateljica, profesorica Margita Pavleković, dugogodišnja suradnica našeg odjela, profesorica Sveučilišta u Osijeku i jedna od prvih voditeljica Seminara za metodiku nastave matematike. Pamtit ćemo je po izuzetnom entuzijazmu u promicanju kvalitete matematičkog obrazovanja i popularizaciji matematike, te kao velikog životnog borca. Posljednji ispraćaj naše drage Margite bit će u petak, 22. kolovoza 2014. u 14 sati na Centralnom groblju u Osijeku.” Vijest se proširila cijelom našom matematičkom zajednicom, pa i šire. Rastužila je mnoge koji su dr. sc. Margitu Pavleković, izvanrednu profesoricu Učiteljskog fakulteta u Osijeku i znanstvenu savjetnicu u interdisciplinarnom području znanosti, polja matematike i pedagogije, izravno ili neizravno poznavali i znali kao osobu i stručnjakinju, kroz njezinu izrečenu ili zapisanu misao i riječ te djelovanje. Komemoracija na matičnom fakultetu održana je na dan sahrane u 11h. [Tekst govora koji je voditeljica fakultetskog Odsjeka za prirodne znanosti prof. dr. sc. Zdenka Kolar-Begović tada izrekla objavljen je u časopisu “Matematika i škola” XVI, broj 76, str. 40–42. O životu i radu pokojne profesorice Margite Pavleković može se pročitati i u Godišnjaku Glasnika matematičkog za 2014. godinu, str. 543–561.]



A tri mjeseca ranije, u svibnju iste 2014. znanstvena savjetnica Margita Pavleković je “zbog izuzetnog doprinosa u djelovanju Učiteljskog fakulteta u Osijeku i promicanja njegovog položaja i ugleda te izuzetnog doprinosa popularizaciji matematike kao važnog čimbenika u motivaciji učenika i studenata za bavljenje matematikom (... dobila nagradu za životno djelo Učiteljskog fakulteta). Krajem

rujna završavala je akademska godina u kojoj je profesorica Pavleković navršila 65 godina života, a s prvim listopadom trebala je otići u mirovinu.

U spomen na dragu kolegicu i zaslužnu promicateljicu matematike i matematičke edukacije održana je 12. prosinca 2014. na zagrebačkom Matematičkom odsjeku PMF-a komemoracija na kojoj su se okupili mnogi njezini prijatelji, kolege i štovatelji, zajedno s članovima obitelji i bivšim studentima i učenicima.

Pokojna Margita Pavleković rođena je 8. prosinca 1948. godine u Dalju. Osnovnu školu i gimnaziju prirodoslovno-matematičkog smjera završila je u Osijeku gdje je maturirala 1967. godine. Dvije godine kasnije diplomirala je na dvogodišnjem studiju matematike i fizike na Pedagoškoj akademiji u Osijeku s radom *Skupovi brojeva* te stekla višu stručnu spremu sa zvanjem nastavnika matematike i fizike. Odmah se zaposlila u osnovnoj školi, a kasnije je prešla na gimnaziju. U periodu od 1969. – 1974. predavala je matematiku i fiziku na osnovnim školama u Vladislavcima i Čepinu, a od 1974. – 1981. matematiku i nacrtnu geometriju na osječkoj Gimnaziji prirodoslovno-matematičkog smjera, odnosno kasnije preimenovanom Centru za usmjereno obrazovanje “Braća Ribar”. Jedan bivši učenik ovako se u pismu osvrnuo na djelovanje profesorice Pavleković: “Pored one stručne, znanstvene i ljudske strane koju su kolege matematičari ispričali na komemoraciji, samo bih u par crtica ponovio što je naša Margita u organizaciji potpuno novog smjera usmjerenog obrazovanja 1978. postigla za nas učenike. Mi smo bili prva generacija usmjerenog obrazovanja – smjer matematičko-informatički. Te 1978. nisu postojali jedinstveni udžbenici koji bi pokrivali cijelo gradivo (radilo se o intenzivnoj nastavi matematike i u širinu i u dubinu). Margita je nabavila fakultetske udžbenike – za svaki učenički stol po jedan primjerak svakog udžbenika, tako da ih učenici nisu morali nabavljati niti donositi/odnositi. Nabavila je i znanstvene kalkulatore (koji su u ono doba bili jako skupi i nisu ih si svi mogli priuštiti) i dala svima mogućnost njihovog korištenja, kako za vrijeme nastave/vježbi tako i za vrijeme ispita. Vodila je brigu o nama i cijelom smjeru – ne samo kako se odvija matematika, nego i fizika i informatika (koja je tada bila u povojima, bez mogućnosti praktičnog rada: sve se učilo “napamet” . . . ), borila se da se podigne kvaliteta nastave, organiziraju obilasci računskih centara i organizira kvalitetna informatička praksa. Njezin kurs o vektorima je bio prava poezija prema dotadašnjem suhoparnom tumačenju vektora (“po definiciji”) – s mnoštvom praktičnih primjera, gotovo “štosova”! I na kraju, u četvrtom razredu, skoro trećina nas je bilo na republičkom natjecanju (danas bi to bilo državno) iz matematike, jedan na saveznom iz fizike, jedan iz matematike. A na jesen smo pokupili puno prvih mjesta na najjačim fakultetima. . . ”

U međuvremenu je, istodobno radeći, studirajući i podižući svoje dvije djevojčice, 1975. obranom diplomskog rada pod naslovom *Algebra dualnih i dvojnih brojeva* na Matematičkom odjelu Prirodoslovno-matematičkoga fakulteta u Zagrebu stekla zvanje profesora matematike s nacrtnom geometrijom. Imala je sreću da se nastava održavala u Osijeku. Naime, kao što sama navodi u jednom obraćanju, “1971. godine u Osijeku su se doslovno prstima jedne ruke mogli nabrojati nastavnici matematike s visokom stručnom spremom. Matematički kadar bio je deficitaran na osječkim srednjim školama, fakultetima, privredi. Stotinjak zainteresiranih nastavnika matematike s višom stručnom spremom iz Osijeka i okoline

krenulo je u akciju za poboljšanjem ove situacije. Uz financijsku podršku Zavoda za zapošljavanje u Osijeku i spremnosti nastavnika s Matematičkoga odjela Prirodoslovno-matematičkoga fakulteta u Zagrebu, pokrenut je dopunski studij iz matematike u organizaciji PMF-a koji se izvodio u Osijeku.” Spomenimo da je prvu godinu ovog tzv. “doškolavanja” upisalo osamdeset studenata, a na drugu prešlo i uspješno okončalo studij tek dvanaest.

Od akademske 1978./79. godine radila je profesorica Pavleković kao vanjska suradnica na Pedagoškom fakultetu u Osijeku (Pedagoška akademija je 1977. prerasla u fakultet) na studiju matematike, vodeći vježbe iz *Linearne algebre i Vektorskih prostora*. Od 1. listopada 1981. godine zaposlila se u istoj ustanovi na radnom mjestu asistenta za područje prirodnih znanosti, polje matematike, disciplinu Metodika nastave matematike koja će obilježiti cijelu njezinu karijeru, bit će predmet i područje njezinog interesa, istraživanja, pisanja i predavanja. Kasnije će, nakon magistriranja biti izabrana u zvanje znanstvenog asistenta (istraživačko zvanje asistent: 01. 04. 1984., znanstveni asistent: 01. 09. 1992.).

Margita Pavleković magistrirala je 1984. na Matematičkom odjelu Prirodno-matematičkoga fakulteta Univerziteta u Beogradu, s radom *Rješavanje sistema algebarskih jednadžbi* pod mentorstvom prof. dr. sc. Slaviše Prešića.

U akademski stupanj doktora prirodnih znanosti iz područja matematike Margita Pavleković je promovirana 1993. godine na zagrebačkom sveučilištu, nakon što je 11. srpnja 1992. doktorirala na Matematičkom odjelu Prirodoslovno-matematičkoga fakulteta Sveučilišta u Zagrebu. Naslov doktorske disertacije je bio *Teškoće učenika u nastavi matematike završnih razreda osnovne škole i načini njihova otklanjanja*, a voditelj rada prof. dr. sc. Boris Pavković. Valja naglasiti da je riječ o prvom doktoratu iz edukacije matematike obranjenom na Prirodoslovno matematičkom fakultetu, odnosno na nekom matematičkom odjelu/odsjeku u Hrvatskoj. Drugim riječima, prvom matematičkom doktoratu u Hrvatskoj iz discipline metodike matematike.

Godine 1996. (01. 10.) izabrana je u zvanje docenta iz područja prirodnih znanosti, polje matematika, za disciplinu Metodika matematike na Pedagoškom fakultetu u Osijeku na studiju matematika-fizika i studiju razredne nastave.

Izdvajanjem Visoke učiteljske škole (1998.) i Odjela za matematiku (1999.) iz Pedagoškoga fakulteta, a u okviru reorganizacije Sveučilišta J. J. Strossmayer u Osijeku, dr. sc. Margita Pavleković je dvije godine bila zaposlena s podijeljenim radnim vremenom na obje novonastale ustanove. U srpnju 2000. godine (15. 07.) izabrana je u trajno zvanje profesora visoke škole za područje prirodnih znanosti, polje matematika, za predmete *Metodika matematike* i *Matematika*. U tom je zvanju od 1. listopada iste godine bila zaposlena s punim radnim vremenom na Visokoj učiteljskoj školi, kasnijem Učiteljskom fakultetu Sveučilišta J. J. Strossmayer u Osijeku.

Drugi put je izabrana u znanstveno-nastavno zvanje docenta 30. 04. 2005., za znanstveno područje prirodnih znanosti, polje matematika.

U znanstveno-nastavno zvanje izvanrednoga profesora izabrana 23. 05. 2011. u interdisciplinarnom području znanosti, polja matematika i pedagogija.



Ovdje valja napomenuti da je taj izbor započeo još 2008. godine, a trajao od ožujka 2009. do travnja 2011., zbog preusmjerenja izbora s područja društvenih znanosti, polja pedagogije na područje interdisciplinarnih znanosti, polja matematika i pedagogija. Međutim, sveukupna duga procedura unapređenja, a kakvu je dr. sc. Margita Pavleković iskusila više puta i ranije, dijelom zato što su njezini “predmeti” bili presedani, a dijelom zbog površnosti i nerazumijevanja izvan matematičkih krugova, urodila je nepravdom posljedicom. Nije mogla biti izabrana u znanstveno-nastavno zvanje redovita profesora zbog vremenskih rokova. A svojim cjelokupnim radom, djelovanjem i mnogobrojnim postignućima taj izbor je apsolutno zaslužila.

Srećom, proveden je izbor u najviše znanstveno zvanje. Potaknuli su je članovi prethodnog stručnog povjerenstva i članovi Matičnog odbora te bliski kolege s fakulteta pa je dr. sc. Margita Pavleković u veljači 2012. pokrenula postupak izbora i 25. rujna iste godine izabrana u znanstveno zvanje znanstvenog savjetnika, u interdisciplinarnom području znanosti (polja matematika i pedagogija).

Prikladno je ovdje naglasiti kako je nedugo iza toga (19. veljače 2013.) Nacionalno vijeće za znanost imenovalo dr. sc. Margitu Pavleković u Matični odbor za interdisciplinarno područje (znanost; umjetnost) za razdoblje 2013. – 2017. godine. Nažalost, 18 mjeseci kasnije dr. sc. Margita Pavleković je preminula.

Profesorica Pavleković je bila dekanica Visoke učiteljske škole u razdoblju od 2003. do 2006. godine te je svojim svesrdnim zalaganjem bitno pridonijela preras-tanju visokih učiteljskih škola u učiteljske fakultete. Posljednja njezina dužnost na Učiteljskom fakultetu bilo je voditeljstvo Odsjeka za cjeloživotno obrazovanje. Svojedobno je 1986. – 1999. bila voditeljica Katedre za matematiku i informatiku Pedagoškog fakulteta.

Na Sveučilištu u Osijeku predavala je kolegije *Metodika matematike s informatikom*, *Elementarna matematika* i *Linearna algebra* na Odjelu za matematiku, a na Učiteljskom fakultetu kolegije *Matematika*, *Metodika matematike*, *Algebra*, *Učenje i igra na računalu*, *Matematika i nadareni učenici*, te *Matematika u igri i razonodi*.

Od 1994. do 1996. godine bila je gostujuća nastavnica na Fakultetu prirodoslovno-matematičkih znanosti i odgojnih područja Sveučilišta u Splitu na učiteljskom studiju i studijskoj grupi profesor matematike i informatike (*Matematika I*, *Neeuklidski prostori*, *Modeli geometrije*, *Elementarna matematika*). Posljednje radne i životne akademske godine 2013./14., kao i prethodne dvije, držala je nastavu i izvan Osijeka, u Puli. Bila su to predavanja iz *Metodike matematike I, II, III* na četvrtoj i petoj godini integriranog prediplomskog i diplomskog učiteljskog studija na Odjelu za odgojne i obrazovne znanosti Sveučilišta Jurja Dobrile u Puli. Bila je mentorica studentima pri izradi osamdesetak diplomskih radova na različitim studijima.

Dr. sc. Margita Pavleković je bila istraživačica na nekoliko znanstvenih projekata Ministarstva znanosti, obrazovanja i športa: *Metodika matematike* (voditelj B. Pavković, PMF, Zagreb) od 1984. do 1996., a projekte *Pedagoška pomoć djeci prognanika i povratnika* (voditeljica A. Peko, Pedagoški fakultet, Osijek) i *Model*

*odgoja i izobrazbe u Hrvatskom Podunavlju* (voditeljica I. Vodopija, Pedagoški fakultet, Osijek) od 1996. do 2000. godine. Kao glavna istraživačica vodila je znanstveni projekt *Metodika nastave matematike na Pedagoškom fakultetu od 2000. – 2002.* i istoimeni projekt na Učiteljskom fakultetu od 2002. do 2006. godine. Kasnije, od travnja 2008. je bila glavna istraživačica i nositeljica projekta *Obrazovanje učenika s posebnim interesom za matematiku.*

Bila je članica Društva matematičara i fizičara Hrvatske od 1983. odnosno Hrvatskoga matematičkoga društva od njegovog osnivanja 1991., a od 1993. preko njegove podružnice Udruge matematičara Osijek. Bila je prva tajnica podružnice, od njezina osnutka 1993. do 1995. Također je bila članica American Mathematical Society (od 1996.) i A Magyar Tudományos Akadémia tagja (od 2003.).

Dugi niz godina profesorica Pavleković je bila požrtvovno uključena u mnogobrojne društvene i stručne aktivnosti, posebice one na područjima vezanima za obrazovanje. Napisala je u koautorstvu, ali kao glavni koautor, udžbenik matematike i popratne materijale za prvi razred osnovne škole. Pri tome je u tekst uključila dijelove bajke Regoč Ivane Brlić Mažuranić, te pokazala kako potka spomenute bajke može biti temelj kvalitetne korelacije u cjelokupnoj nastavi polaznika prvoga razreda osnovne škole. Recenzirala je mnoge udžbenike iz matematike i informatike za osnovne i srednje škole, bila je aktivna članica pokreta “Znanost mladima”, osnovala je i vodila niz matematičkih ljetnih, zimskih i stalnih škola i tečajeva za učenike osnovnih i srednjih škola te na njima držala predavanja, kao i na republičkim, državnim i regionalnim seminarima za nastavnike i učitelje matematike.

Ministarstvo znanosti i tehnologije imenovalo je 1994. dr. sc. Margitu Pavleković predsjednicom ispitnih povjerenstava za polaganje stručnih ispita iz matematike za osnovne i srednje škole: obavila je preko 550 stručnih ispita iz matematike za učitelje razredne nastave te učitelje i profesore matematike.

Bila je članica izdavačkog savjeta *Matematičko-fizičkog lista* (od 1991.), redakcijskog kolegija *Matke* (od 1993), uredništva *Matematika i škola* (od 1999.), redakcijskog kolegija *Život i škola* (od 1999.).

Objavila je samostalno odnosno u koautorstvu tridesetak znanstvenih te četrdesetak stručnih radova u našim i stranim publikacijama. To uključuje dva sveučilišna udžbenika u više izdanja, znanstvenu studiju, udžbenički komplet i trojezičnu stručno-popularnu knjigu.

Radovi dr. sc. Margite Pavleković su prvenstveno vezani uz nastavu matematike u svim njezinim aspektima, kao stručni prilozi posvećeni obogaćivanju i proširivanju sadržaja nastave, populariziranju matematike, te znanstvenom promišljanju tema iz metodike matematike. Međutim, njezino cjelokupno dugogodišnje djelovanje bilo je doista interdisciplinarno. Posebno je bila vezana uz nastavu matematike u osnovnoj školi, osobito u iznalaženju originalnih metodičkih pristupa, znanstvenih objašnjenja i postupaka prema učinkovitijem matematičkom opismenjavanju djece i studenata učiteljskih studija, ali i cjeloživotnoj izobrazbi učitelja. Istraživala je i kontinuirano znanstveno objašnjavala stanja u nastavnoj praksi pa ju

onda nastojala unaprijediti originalnim metodičkim pristupima. Dodatno, posljednjih desetak godina njezin znanstveni interes je bio usmjeren na problem prepoznavanja matematički darovitih učenika. U svoja istraživanja uključivala je studente, znanstvene novake, asistente i školske učitelje, ostvarujući uspješnu suradnju fakulteta, škole i doma.

Posebno mjesto ima angažiranje profesorice Margite Pavleković u osmišljavanju, pokretanju i organiziranju međunarodnog znanstvenog skupa *Matematika i dijete* (International Scientific Colloquium “Mathematics and Children”) čiji je prvi sastanak održan 2007. godine. A najznačajniji doprinos vezan uz nastavu matematike, odnosno matematičku edukaciju dala je svojim sveučilišnim udžbenicima *Metodika nastave matematike s informatikom I* (1997.) i *II* (1999.) te znanstvenom studijom *Matematika i nadareni učenici – razvoj kurikula na učiteljskim studijima za prepoznavanje, izobrazbu i podršku darovitih učenika* (2009.).

Posveta u knjizi *Matematika i nadareni učenici* glasi: “Knjigu i rezultate o kojima se govori posvećujem znanstvenicima, davaocima organa i tkiva, transplantacijskim timovima i svojoj obitelji”. Naime, početkom devedesetih, nastupa “podrumski život za vrijeme domovinskog rata. Smrzavamo se u granatama obasipanom Osijeku. Stres i hladnoća pridonijeli su otkazivanju mojih bubrega. Bila sam pred dijalizom. I ‘odradila’ na njoj svojih devet godina”.

U tih dugih devet godina cijelo vrijeme je profesorica Pavleković bila pod pritiskom neizvjesnosti moguće transplatacije bubrega zbog specifičnosti njezinih “parametara” koji su značili malu vjerojatnost nalaženja adekvatnog donora. Početkom 2002. godine, u utorak 15. siječnja, na zagrebačkom Kliničkom bolničkom centru Rebro Margiti Pavleković je presađen bubrežni bubreg. Iste godine objavljuje knjigu *Život meni na dar* u kojoj je “opisala razdoblje svog liječenja na redovitoj hemodijalizi i vrijeme čekanja na transplantaciju bubrega. Opisala je teške, ali i sretne trenutke kada se pružila prilika da dobije novi organ i da se mukotrpnim, ali uspješnim operacijskim zahvatom i teškim razdobljem nakon toga, vrati u puno zdravlje. Dirljiva je i poučna priča, koja je duboko dirnula mnoge čitaoce. Njeno iskustvo potaknulo je sve one koji do sada nisu imali prilike saznati o postmortalnom darivanju kao visokom stupnju civilizacijskog dosega. Autorica je kroz niz godina svojim radom u javnosti uvelike doprinijela promicanju kulture postmortalnog darivanja organa i transplantacijskog liječenja”. Godinu dana kasnije, 2003. knjiga je izašla u trojezičnom izdanju, dopunjena je prijevodima na engleski i mađarski jezik. Iste godine, dr. sc. Margita Pavleković predstavila je *The gift of Donated Life* osobno u Lisabonu, kao predsjednica Udruge dijaliziranih, transplantiranih i kroničnih bubrežnih bolesnika Hrvatske na godišnjoj skupštini CEAPIR-a – svjetske udruge bubrežnih bolesnika. Uvodni tekst svoje knjige zaključuje riječima: “Autorica se toplo nada kako će svojom autentičnom pričom pridonijeti povećanju interesa ljudi za ovu temu, a onda i povećanju broja onih koji će se opredijeliti za darivanje organa poslije smrti, kao naglašenom izrazu nesebičnosti i ljudske solidarnosti. Svakom pojedincu koji svoje vrijeme i interes o ovoj temi podijeli s drugima, autorica iskreno zahvaljuje.”

Saznavši za tužnu vijest i održavanje komemoracije u Zagrebu, primarijus dr. Igor Povrzanović, bivši predsjednik Hrvatske donorske mreže uputio je pismo s izrazima duboke sućuti obitelji, suradnicima i prijateljima pokojne dr. sc. Margite Pavleković, zahvaljujući na prilici da se posredno obrati skupu ovim riječima: “Gospođa prof. Pavleković hrabro i s dostojanstvom se godinama nosila sa svojom bolešću, s mnogo optimizma i odlučnosti. Istovremeno s toliko humanosti i brige za čitavu populaciju pogođenih bolesnika koji su strpljivo čekali presadak i očuvanje života i zdravlja. Na tom planu istaknula se otvorenim i odlučnim stavom da se solidarnost građana i u tom slučaju mora probuditi. Svojom aktivnošću bila je uzor i primjer i svojim je javnim istupima i objavljenim tekstovima mnogo doprinijela općoj pozitivnoj klimi prema postmortalnom doniranju organa. U suradnji s nama i u suglasju s mnogim organizacijama i pojedincima uspjelo se u našoj zemlji doći do gotovo najboljih svjetskih transplantacijskih rezultata. Gđa Pavleković dala je tako svoj neposredni obol očuvanju života i zdravlja tisućama bolesnika. Na tome joj iskreno zahvaljujemo. Sjećat ćemo se velikog doprinosa te nasmijane, zadovoljne, humane i optimistične osobe. Izražavamo joj osobitu zahvalnost, Hrvatska donorska mreža i bivši predsjednik prim. dr. Igor Povrzanović.”

Dr. sc. Margita Pavleković bila je cijenjena i priznata sveučilišna nastavnica koju je resila značajna, zapažena i uspješna predavačka i istraživačka karijera, znanstvena i stručna, velika društvena i nesebična angažiranost. Bila je osoba dojmljive biografije obilježene posvećenošću poučavanju matematike na svim razinama i u svim aspektima. Dala je mnoštvo zanimljivih, vrijednih i originalnih priloga unutar metodike matematike. Svojim dugogodišnjim predanim nastavnim radom na Učiteljskom fakultetu i Odjelu za matematiku Sveučilišta u Osijeku, te neumornim i predanim djelovanjem kroz osječku podružnicu Hrvatskog matematičkog društva, trajno je doprinijela kvaliteti, osuvremenjavanju i podizanju razine nastave matematike na našim sveučilištima i u našim školama.

Svi koji su poznavali dr. sc. Margitu Pavleković, ma kako je oslovljavali, kao profesorica Pavleković, kolegica Pavleković ili blisko – Margita ili još bliže – Mancika, divili su se njezinoj posebnosti i osobitosti, svestranim talentima, snazi i hrabrosti u krhkom tijelu, životnoj realnosti, optimizmu i poetičnosti njezina življenja, duhovitosti i nepokolebljivosti. Život je voljela, znala je u njemu uživati, znala je to prenositi na sve koji su je okruživali. Bila je veliki borac i uvijek ispred vremena, često nedovoljno shvaćena i priznata, no to ju nikada nije omelo ni obeshrabrilo. Dapače, to ju je poticalo da ustrajno u osobnom i javnom životu stremi boljem, ispravnijem i vrednijem. Bila je pravedna i dobra. I pomogla je mnogima da postanu pravedniji i bolji. Širila je ljubav oko sebe u najširem poimanju te riječi.

*Mirko Polonijo*

## Popis objavljenih knjiga, udžbenika, znanstvenih i stručnih radova prof. dr. sc. Margite Pavleković

---

---

### Sveučilišni udžbenici

- **Pavleković, M.** (1997), *Metodika nastave matematike s informatikom I*, Element, Zagreb, 312 str. (drugo izdanje 2001., treće 2008.).
- **Pavleković, M.** (1999), *Metodika nastave matematike s informatikom II*, Element, Zagreb, 203 str.

### Znanstveno-popularne knjige

- **Pavleković, M.** (2002), *Život meni na dar*, Udruga dijaliziranih, transplantiranih i kroničnih bubrežnih bolesnika u Osijeku, Hrvatska donorska mreža Osijek, Pedagoški fakultet u Osijeku, 68 str.
- **Pavleković, M.** (2003), *Život meni na dar, The Gift of Donated Life, Ajándékba kapott élet*, Udruga dijaliziranih, transplantiranih i kroničnih bubrežnih bolesnika u Osijeku, Hrvatska donorska mreža Osijek, Visoka učiteljska škola u Osijeku, 163 str. (trojezično: hrvatski, engleski, mađarski).

### Znanstvena studija, poglavlje u znanstvenoj knjizi, uređivanje znanstvene knjige

- **Pavleković, M.** (2009), *Matematika i nadareni učenici – razvoj kurikula na učiteljskim studijima za prepoznavanje, izobrazbu i podršku darovitih učenika*, Element, Zagreb, 192 str.
- **Pavleković, M.** (2004), *O matematičkoj izobrazbi učitelja u Osijeku do 1945.*, u: Učiteljska škola u Osijeku 1893.-1965., ravnatelji, profesori i maturanti, HAZU, Zagreb-Osijek, 55–65.
- **Pavleković, M.** (Ed.) (2007), *Proceedings of the International Scientific Colloquium Mathematics and Children – How to teach and learn mathematics*, Učiteljski fakultet Osijek, pp. 371.

- **Pavleković, M.** (Ed.) (2009), *The Second International Scientific Colloquium Mathematics and Children – Learning Outcomes*, Element, Zagreb, pp. 208.
- **Pavleković, M.**, Mirković Moguš, A., Moslavac, D. (2009), *Mathematics and Informatics in extracurricular activities chosen by pupils and offered by their teachers*, in *The Second International Scientific Colloquium Mathematics and Children – Learning Outcomes*, Element, Zagreb, 26–37.
- **Pavleković, M.** (Ed.) (2011), *The Third International Scientific Colloquium Mathematics and Children – The Math-Teacher*, Element, Zagreb, pp. 578.
- Đurđević, I., Zekić-Sušac, M., **Pavleković, M.** (2011), *The effect of students' learning style on the selection of elective modules*, in *The Third International Scientific Colloquium Mathematics and Children – The Math Teacher*, Element, Zagreb, 141–149.
- **Pavleković, M.**, Kolar-Begović, Z., Kolar-Šuper, R. (Eds.) (2013), *The Fourth International Scientific Colloquium Mathematics and Children – Mathematics Teaching for the Future*, Element, Zagreb, pp. 352.
- Gregorović, Ž., Palinkaš, D., **Pavleković, M.** (2013), *Correlation between pupils' managing of graphing data and their level of geometric thinking*, in *The Fourth International Scientific Colloquium Mathematics and Children – Mathematics Teaching for the Future*, Element, Zagreb, 2013., 224–233.

### Znanstveni radovi objavljeni u časopisima i zbornicima

- **Pavleković, M.**, Zekić-Sušac, M., Djurdjević, I. (2009), *Comparison of intelligent systems in detecting a child's mathematical gift*, *Computers and Education*, (53): 142–154.
- **Pavleković, M.**, Zekić-Sušac, M., Đurđević I. (2010), *Recognizing Mathematically Gifted Children by Using Expert systems', Teachers', and Psychologists' Estimations*, *Journal for General Social Issues*, Zg (107): 487–510.
- **Pavleković, M.**, Benšić, M., Zekić-Sušac, M. (2010), *Modeling children's mathematical gift by neural networks and logistic regression*, *Expert Systems with Applications* 37 (2010), 7167–7173.
- **Pavleković-Pope, M.** (1984), *Jedna nova metoda za rješavanje sistema algebarskih jednadžbi s dvije nepoznanice*, *Život i škola*, God. 33, (3): 265–272.
- **Pavleković, M.** (1996), *Bolyai – Gerwienov teorem u nastavi*, *Mathematical Communications*, Vol. 1 (1), 75–79.
- **Pavleković, M.** (1998), *An Approach to Mathematical Induction – starting from the early stages of teaching mathematics*, *Mathematical Communications*, (3), 135–142.
- **Pavleković, M.**, Benšić, M. (2003), *Matematički časopis kao učitelj izvor ideja za suvremenijom organizacijom nastave matematike*, *Život i škola*, 49 (9) 1, 39–49.

- **Pavleković, M.**, Zekić-Sušac, M., Đurđević, I. (2009), *A novel way for detecting children's mathematical gift by using the estimates of teachers, psychologists, expert systems, and students*, International Journal of Research in Education, Delhi, 1 (1), 13–30.
- **Pavleković, M.**, Zekić-Sušac, M., Đurđević, I. (2011), *A Neural Network Model for Predicting Children's, Mathematical Gift*, Croatian Journal of Education, 13, 1, 10–30.
- **Pavleković, M.** (1989), *Logical Method of Solving the System of Algebraic Equations, Inspired by Tarski's theorem of Quantifier elimination*, Working Papers, Pécs, (3): 70–81.
- Sotirov, R., Jakić, M., **Pavleković, M.**, (1998) *Mathematical Models of Hemodialysis*, Proceedings of the Internacional Conference on Operational Research KOI 98, Rovinj, (eds: Aganović, Hunjak, Scitovski) 209–218.
- **Pavleković, M.**, Zekić-Sušac, M., Đurđević I. (2007), *Expert system for detecting a child's gift in mathematics*, Proceedings of the International Scientific Colloquium Mathematics and children (How to teach and learn mathematics), 98–117.
- **Pavleković, M.**, Zekić-Sušac, M., Đurđević, I. (2008), *Integration of expert systems and neural networks in recognizing mathematically gifted children*, Proceedings of the 30<sup>th</sup> International Conference "Information Technology Interfaces ITI 2008", V. V. Stiffler, Hljuz-Dobrić (Eds.), Cavtat/Dubrovnik, Croatia, 557–562.
- **Pavleković, M.** (1989), *Dijagnostička slika obrazovnih dostignuća u nastavi matematike od V. do VIII. razreda osnovne škole u SR Hrvatskoj*, Matematika, XVIII, (2): 5–18.
- **Pavleković, M.** (1991), *Two Interesting Tasks on Geometric Series*, Matematika, XX, (3-4): 75–83.
- **Pavleković, M.**, Kolar, R. (2001), *Računalo u nastavi matematike (rezultati istraživanja)*, Poučak (5): 44–47.
- **Pavleković, M.** (2004), *Strukturalni prijevodi u nastavi matematike (rezultati istraživanja)*, Poučak (17): 39–47.
- **Pavleković, M.** (1989), *Matematičko obrazovanje učenika od V. do VIII. razreda osnovne škole*, u: (ured. Buzatović, M., Galić, B., Pavleković, M., Zeljković, S.), Matematičko obrazovanje učenika u funkciji tehnološkog razvoja, Pedagoški fakultet u Osijeku, 103–160.
- **Pavleković, M.**, Bašić, I. (1998), *Komunikacija u nastavi matematike*, Zbornik radova s međunarodnog znanstvenog skupa Vrjednovanje obrazovanja (ured. Peko, A., Vodopija, I.), Osijek, 202–211.
- **Pavleković, M.** (2005), *Od bajke Regoč Ivane Brlić-Mažuranić do udžbenika za matematiku*, Zbornik radova s međunarodnog znanstvenoga skupa Zlatni danci 6 – život i djelo(vanje) Ivane Brlić Mažuranić (ur. A. Pintarić), Filozofski fakultete Osijek, 179–185.

- **Pavleković, M.**, Kolar-Begović, Z. (2005), *Teachers contribution to the modernization of teaching mathematics*, Proceedings of the International Scientific colloquium on Contemporary teaching in Osijek (Ed. A. Peko), University J. J. Strossmayer Osijek, 98–108.
- Hodnik-Čadež, T., Manfreda Kolar, V., **Pavleković, M.**, Perić, A. (2010.), *Matematična pismenost z vidika razumevanja pojma neskončnosti pri študentih razrednega pouka*, Mednarevni znanstveni sestanek – Pismenost vseh stopnjah izobraževanja (ured. Starc, S., Razpet, N.), Koper, 40–49.

### Udžbenici i priručnici za osnovnu i srednju školu

- **Pavleković-Pope, M.** (1978), *Matrice*, Matematički bilten, br. 1., Zavod za prosvjetno-pedagošku službu za područje Zajednice općina Osijek, 103 str.
- **Pavleković, M.** (1999), *Metodički pristup uporabi modela u nastavi matematike*, Neodidacta, Zagreb, 26 str.
- Bunjački, L., **Pavleković, M.** i Varat, D. (2004), *Nina i Jan, udžbenik za matematiku u prvom razredu osnovne škole*, Neodidacta, Zagreb.
- Bunjački, L., **Pavleković, M.** i Varat, D. (2004), *Nina i Jan, radna bilježnica iz matematike u prvom razredu osnovne škole*, Neodidacta, Zagreb.
- Bunjački, L., **Pavleković, M.** i Varat, D. (2004), *Priručnik za učitelje za matematiku u prvom razredu osnovne škole*, Neodidacta, Zagreb.

### Stručni radovi

- **Pavleković, M.** (1989), *Još jedan način izvođenja volumena krnje piramide*, Život i škola, (1), 69–73.
- **Pavleković, M.** (1987), *Metodika rješavanja trigonometrijskih jednadžbi*, Život i škola, (4), 347–357.
- **Pavleković, M.** (1989), *Posebni oblici rada s nadarenim učenicima u suvremenim uvjetima*, Život i škola, (4), 333–342.
- **Pavleković, M.** (1993), *Kako je Garfield dokazao Pitagorin teorem*, Matka, (3), 9–11.
- **Pavleković, M.** (1993./94), *Napoleonovi trokuti*, Matematičko-fizički list, (3/175), 128–131.
- **Pavleković, M.** (1994), *Proučavanje osne simetrije u osnovnoj školi operacijskim putem*, Život i škola, (4), 327–338.
- **Pavleković, M.** (1994), *Proučavanje rotacije u osnovnoj školi operacijskim putem*, Školski vjesnik, (2), 211–219.



- **Pavleković, M.** (1994), *Konstrukcija jednakih likova*, Matka, (10), 61–64.
- **Pavleković, M.** (2001), *Konstrukcija likova jednakih površina*, Osječka matematička škola, (1), 35–40.
- **Pavleković, M.** (2007), *Matematika i dijete – međunarodni znanstveni kolokvij*, Matematika i škola, 8 (40), 227–230.
- **Pavleković, M.** (2009), *Matematika i dijete – 2. međunarodni znanstveni kolokvij*, Matematika i škola, 10 (50), 237–238.
- **Pavleković, M.** (2011), *Učitelj matematike – 3. međunarodni znanstveni kolokvij “Matematika i dijete”*, Matematika i škola, 12 (59), 187–190.
- **Pavleković, M.** (2013), *Matematika i dijete 2013. – 4. međunarodni znanstveni kolokvij*, Matematika i škola, 12 (70), 232–238.
- **Pavleković, M.** (1998), *Geometrijska interpretacija nekih važnih algebarskih izraza*, Triangle, Volume 2, No. 1, UM BiH, Sarajevo, 3–6.
- **Pavleković, M.** (1998), *Eulerov pravac*, Triangle, Volume 2, No. 3, UM BiH, Sarajevo, 181–185.
- **Pavleković, M.** (1996), *Knjiga “Metodika nastave matematike s informatikom I”*, Zbornik radova 3. susreta nastavnika matematike (ur. S. Varošaneć), Zagreb, 165.
- **Pavleković, M.** (1998), *Eksperiment u nastavi matematike*, Zbornik radova 4. susreta nastavnika matematike (ur. S. Varošaneć), Zagreb, 211–220.
- **Pavleković, M.** (1999), *Eksperimentiranje programskim paketima, ali i modelima, neminovnost nastave matematike u XXI. stoljeću*, Zbornik radova stručno-metodičkog skupa metodičara nastave matematike u osnovnoj i srednjoj školi – Utjecaj rješavanja problema na obrazovni učinak u nastavi matematike, (ur. V. Kadum), Rovinj, 48–60.
- **Pavleković, M.** (2000), *Kako koriste računalo učenici osnovnih i srednjih škola u Slavoniji*, Zbornik radova Prvog kongresa nastavnika matematike RH, (ur. I. Ivanšić, P. Mladinić), Zagreb, 272–273.
- **Pavleković, M.** (2001), *Neke primjedbe i prijedlozi autorima udžbenika*, Zbornik radova drugog stručno-metodičkog skupa metodičara nastave matematike u osnovnoj i srednjoj školi – Uloga udžbenika u matematičkom odgajanju i obrazovanju učenika osnovne i srednje škole, (ur. V. Kadum), Rovinj, 67–75.
- **Pavleković, M.** (2002), *Nastavnikova inventivnost i učinkovitost nastave matematike*, Zbornik radova šestog susreta nastavnika matematike, (ur. I. Ivanšić), Zagreb, 388–404.
- **Pavleković, M., Jurković, K.** (2003), *Kreativni učitelj i matematička izobrazba učenika s teškoćama u osječkim školama*, Zbornik trećeg stručno-metodičkog skupa – Kreativnost učitelja/nastavnika i učenika u nastavi matematike, (ur. V. Kadum), Rovinj, 9–10.
- **Pavleković, M., Kolar-Šuper, R.** (2003), *Kreativni učitelji matematike osječkih škola 2002./03 (poster)*, Zbornik trećeg stručno-metodičkog skupa – Kreativnost

učitelja/nastavnika i učenika u nastavi matematike, (ur. V. Kadum), Rovinj, 67–77.

- **Pavleković, M.**, Duka, S. (2004), *Izoperimetrijski problem u istraživanjima učenika*, Zbornik radova Drugog kongresa nastavnika matematike, (ur. I. Ivanšić, P. Mladinić), Zagreb, 286–296.
- **Pavleković, M.**, Đurđević, I. (2005), *Računalo kao sredstvo poticaja za učenje matematike*, Zbornik radova četvrtog stručno-metodičkoga skupa Metodika nastave matematike u osnovnoj i srednjoj školi – Motivacija u nastavi matematike, (ur. V. Kadum), Pula, 213–215.
- **Pavleković, M.** (2007), *O zornosti u nastavi matematike s darovitim učenicima*, Zbornik radova petog Stručno-metodičkoga skupa Metodika nastave matematike u osnovnoj i srednjoj školi – Zornost u nastavi matematike, (ur. V. Kadum), Pula, 109–115.
- **Pavleković, M.**, Jakopović, D. (2002), *The Mathematics Teaching Process with Help of Mathematica*, in: Conference proceedings about PrimMath (2001): The First Scientific and Technical Conference *Mathematica* in Science, Technology and Education, (Ed. Š. Ungar) Zagreb, September 27–28, 171–186, (electronic 2002).
- **Pavleković, M.**, Idžojtić, R. (2001), *The Mathematics Teaching Process with Help of Mathematica* (poster), in: Conference proceedings about PrimMath(2001): The First Scientific and Technical Conference *Mathematica* in Science, Technology and Education, (Ed. Š. Ungar) Zagreb, September 27–28, 60–61, (electronic 2002).
- **Pavleković, M.**, Bagarić, V. (2005), *Das Märchen “Regotsch der Riese” als Grundlage eines Mathematiklehrwerks*, Beiträge zur Dozentenmobilität 2003/04, (Herausgeber: Pädagogische Akademie des Bundes in der Steiermark, OstRin Prof. Monika Nedwed, Mag. Susanne Linhofer), Graz, 14–26.

# 1.

## Some new strategies and approaches to algorithms and problem solving in mathematics

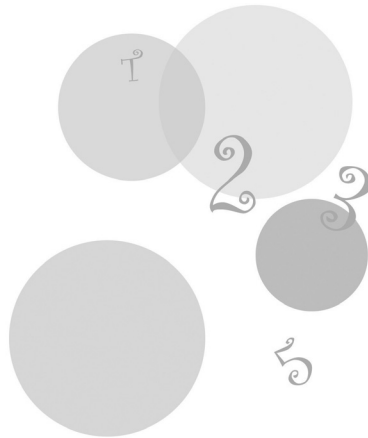



# Understanding of mathematically gifted students' approaches to problem solving

---

---

Tatjana Hodnik Čadež and Vida Manfreda Kolar

Faculty of Education, University of Ljubljana, Slovenia

*Abstract.* Problem solving in mathematics is a leading creative activity and it must be offered (if not to everyone) at least to mathematically gifted students at all levels of education. The research has shown that mathematically gifted students themselves recognize mathematical problem solving to be the most important component for developing their potentials in mathematics. When researching problem-solving activities in relation to students' success one could focus on various issues: mental schemes, generalising, procedural and conceptual problems, heuristics... In this paper we focus on analysing how mathematically gifted students (from 6th to 9th grade of elementary school, age 12 to 15) solved a particular problem (we named it 'the prisoner cell problem') where the skills of generalising and establishing some rules are needed for the solution. We investigate students' solutions to the problem from the perspective of the strategies used, correctness of the solutions at different extensions of the problem in relation to the strategies used, and from the point of relation between their age and success in problem solving. Such an analysis gives us better understanding of the development of mental schemes among mathematically gifted students for solving problems. The research contributes to more systematic and organised work with gifted students in the mathematics classroom. We also want to encourage teachers of mathematics to integrate problem solving into their teaching, since this would be challenging for gifted students and it would enable them to fulfil and develop their potentials. We demonstrate some students' problem-solving solutions and their approaches in order to give mathematics teachers some practical examples which could be starting points both for discussion with students and for challenging them as they learn mathematics.

*Keywords:* mathematically gifted student, problem solving, generalisation, mental scheme, problem-solving strategies

## 1. Introduction

Mathematical giftedness is defined in many different ways. The definition of mathematical giftedness governs the work with gifted pupils in the school and also in activities outside the school. The definition itself is, thus, crucial and must be based on the research findings of giftedness. In different determinations of mathematically gifted students the following characteristics are mentioned: the student is able to move from concrete to abstract situations, is able to generalise, think fluently and make strategic choices in problem-solving strategies (Wieczerkowski, Cropley, Prado, 2002). Krutetskii (1976) distinguishes the mathematically gifted student from the non-gifted student in terms of qualitative differences in cognitive processes (obtaining information, information processing, preservation of information), while emphasising that specific abilities – such as good arithmetic skills, quantitative performance, good spatial orientation, ability to discover mathematical relations and other, for mathematics specific characteristics – are not crucial for determining mathematical giftedness. Kiessweter (1992 in Wieczerkowski et al., 2002) pointed out six issues which describe a higher level of mathematical thinking and which are directly related to mathematical problem solving: organisation of information, recognising patterns and rules, transforming representations of problems, working in complex structures, reversible processing and searching for similar problems. The approach to determining mathematical giftedness which centralises problem solving is called ‘active structuring’ by Zimmerman (1992) and has the following characteristics: it is not algorithmic, it is complex, it leads to multiple solutions, it encourages students to take decisions, it includes uncertainty, it is a self-regulation process that creates meanings (rather than reinventing already known facts). Research which has taken place in Hamburg investigated 234 students (aged between 16 and 20) to see which activities mathematically gifted students consider important for determining mathematical giftedness (Wieczerkowski et al., 2002). All the participants had been involved in six-year program especially designed for mathematically gifted students; after that period they answered a questionnaire consisting of 62 questions. The research showed that the participants emphasised cognitive flexibility as being the most important category of giftedness. Cognitive flexibility consisted of the following dimensions: flexible thinking, reversible processing, translating among different representations, problem generalising, trying out different strategies for solving problems (Wieczerkowski et al., 2002). The researchers concluded that experimenting – trying out different strategies for solving mathematical problems – and generalising are, in the eyes of mathematically gifted students, the most important criteria for mathematically gifted students. The idea of giftedness is, in the ‘process of thinking, closer to problem solving than it is to other capabilities of those gifted in mathematics (Zimmerman, 1992). Metacognitive characteristics of mathematically gifted students include, alongside cognitive dimensions, such personal characteristics as flexibility, openness to new situations, tolerance, good self-esteem, readiness to take risks and a commitment to solving problems (Wieczerkowski et al., 2002).

We can conclude that problem solving is a mathematical activity which challenges mathematically gifted students and encourages the development of their

potentials. We have to understand a mathematical problem as a complex situation which requires that a solver create and try out different strategies for solving the problem and developing new knowledge – that is, the solver does not merely reproduce already known mathematical facts. Given that some define mathematics as a science of generalisation (Maj-Tatsis, Tatsis, 2012), the process of generalising is most important when solving a mathematical. Indeed, we generalise in everyday life much more than we may be aware (Cockburn, 2012). For example, after engaging in small talk, we generalise to some extent the interlocutor's character; we generalise about the weather, traffic, the behaviour of pupils in the classroom. . .

These generalisations are more or less justified, but often questionable, which is not the case in mathematics. Generalisations in mathematics are based on careful consideration of specific examples, on the basis of thoughtful hypotheses, of clarifying them and finally proving them. Krygowska (1979, in Ciosek 2012) distinguishes between four types of generalisation:

- *Generalisation through induction*: one first establishes the rule  $f(1), f(2), f(3) \dots$  and notices that results can be obtained when applying a general rule  $f(n)$  for natural  $n$ , which is a conjecture only.
- *Generalisation through generalising the reasoning*: one notices that the reasoning carried out in a single case will remain correct in a different setting, or that minor modifications will be needed to obtain a general result. E.g., by observing a square's perimeter for particular cases, one can become aware of the structure of the square's perimeter for a general case and consequently also for the perimeter of a rectangle.
- *Generalisation through unifying specific cases*: a group of statements, each referring to one case of a setting, proves capable of being replaced by one general statement, the original ones being its special cases. E.g., the Pythagoras theorem, formulas for acute-angled triangles and for obtuse-angled triangles can be generalised to the cosine formula.
- *Generalisation through perceiving recurrence*: this is similar to generalisation through induction, but in this case the formula  $f(2)$  is obtained by using the formula  $f(1), f(3)$  by using  $f(2) \dots$ ; thus, the result is the recurrence rule  $f(n)$ .

We can notice commonalities between these types of generalisation and the more widely used terms of inductive reasoning. We refer to the first and the last type of generalisation defined by Krygowska, namely, generalisation through induction and generalisation through perceiving recurrence, as inductive reasoning. The second type, generalisation through generalising the reasoning, describes generalisation as an insight into the problem situation without analysing many cases. For the problem solver, one case of generalisation is usually enough. The third type is less bound to problem solving; it serves more to investigate the hierarchies among mathematical concepts.

With regard to their content, for the purposes of our research another two types of mathematical problems can be defined: procedural and conceptual problems. We call procedural problems those which require mere procedural knowledge for their solving; in this case a problem solver is more focused on procedures, rules

and algorithms. On the other hand, conceptual problems are those which require the solver to be familiar with specific mathematical concepts (Haapsalo, 2003). We also propose that there are no disjunctive categories of problems: however, one of them (procedural or conceptual knowledge) prevails over the other when it comes to problem solving.

In this article a case of solving a conceptual mathematical problem which corresponds to generalisation through generalising the reasoning is presented, in line with Krygowska (Krygowska, in Ciosek, 2011) – i.e. a student can find a solution through reasoning and through relating a problem to a corresponding mathematical context which is hidden behind what at first sight seems to be a nonmathematical problem.

## 2. Empirical part

### 2.1. Problem definition and methodology

In the empirical part of the study conducted with primary school students the aim was to explore their problem-solving strategy competences and to answer the following research questions: how successful are primary school students who are identified by a formal procedure as being gifted in mathematics at solving a mathematical problem? What strategies do they use for solving a problem and are they equally effective? How successful are they in transferring knowledge to a new situation with a similar problem? Do they notice the relation of what is, at first sight, a non-mathematical problem to a mathematical context? What is the impact of students' age to their success, choice of strategy and ability to generalise a problem?

The empirical study was based on the descriptive, causal and non-experimental methods of pedagogical research (Hartas 2010, Sagadin 1991), allowing for the exploration of the problem-solving strategies and schemes for problem solving.

### 2.2. Sample description

The study was conducted at randomly chosen Slovenian primary school. The sample consisted of 50 mathematically gifted students (from grades 6 to grade 9 of elementary school, age 12 to 15)

Grade 6	14
Grade 7	10
Grade 8	8
Grade 9	18
Together	50



### 2.3. Data processing procedure

The students were given a mathematical problem called the 'prisoner cell problem'. The problem was as follows:

Part 1: There are 10 prison cells, marked by numbers from 1 to 10. The guard's task in this prison is to unlock or lock the cell doors according to the following rules:

1st day: he unlocks all the doors

2nd day: he locks the doors numbered with a multiple of 2

3rd day: he locks/unlocks the doors numbered with a multiple of 3 (depending on the state from the previous day)

4th day: he locks/unlocks the doors numbered with a multiple of 4 (depending on the state from the previous day)...

And so on until the 10th day.

Which doors will be unlocked after the 10th day? Explain your answer.

Part 2: What if there were 20 doors instead of 10 and the guard were to use the same rule for locking/unlocking the doors for 20 days? (For example: on the 14th day he would lock/unlock all those doors with multiples of 14.) Explain your answer.

All students' solutions were analysed and coded according to these criteria: the success at solving a problem, the chosen strategy and the consistency of solutions for numbers up to 10 in comparison to solutions for numbers up to 20.

Due to the complexity of the problem it was almost impossible to solve it by heart or by intuition; therefore a particular strategy was needed. Approaches which were observed among student's solutions were classified into the following categories:

- a) systematic representations in the table: representation in 'more lines' with a legend which represents the state of the doors (unlocked or locked – the legend could consist of 10, or less, lines if the student noticed the rule already before the tenth step) (Figure 1);

	1	2	3	4	5	6	7	8	9	10
1.	0									
2.		X		X						
3.			X							
4.				0						
5.					X					
6.						X				
7.							X			
8.								X		
9.									X	
10.	0	X	X	0	X	X	X	X	0	X

0 - otvorena  
X - zatvorena

0: Po desetom dnevno so odlozene celice 1, 4, 9

Figure 1. A systematic representation in 'more lines'.

- b) analysis of multiples: for each step a student describes which doors would be unlocked or locked: he or she is focused only on those doors where the change occurs (i.e. the multiples of a given number) (Figure 2);

1. dan - vse odklenjene  
 2. dan = ~~1, 2, 3, 4, 6, 8, 10~~ = zaklenjene      ~~1, 3, 5, 7, 9~~ = odklenjene  
 3. dan = ~~3, 6, 9~~  
           zak. odk. zak.  
 4. dan = ~~4, 8~~  
           odk. odk.  
 5. dan = ~~5, 10~~  
           zak. odk.  
 6. dan = 6 → zak.  
 7. dan = 7 → zak.  
 8. dan = 8 → zak.  
 9. dan = ~~9~~ → odk.  
 10. dan = 10 → zak.

Figure 2. Analysis of multiples.

- c) a representation in 'one line': with numbers from 1 to 10 and with a defined procedure for recording the change of the doors' state (for example: a student circles/erases numbers, colours numbers with 2 different colours, adds certain codes to numbers (Figures 3, 4 and 5);

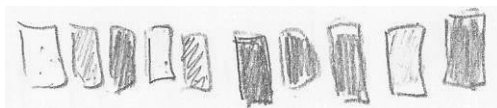

Figure 3. Representation in 'one line' – erasing/colouring the doors.

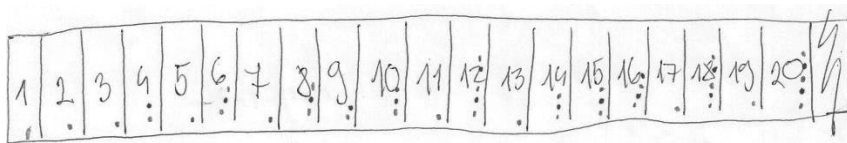

Figure 4. Representation in 'one line' – adding dots.

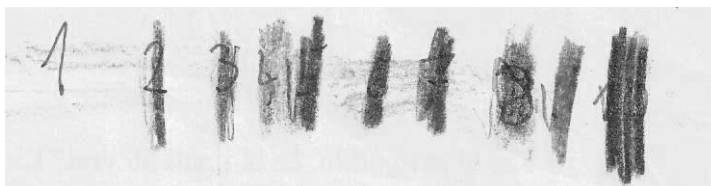

Figure 5. Representation in 'one line' – colouring the doors alternately with two different colours.

- d) writing down the current solutions: after each step a student writes down the numbers of currently unlocked prison cells;  
 e) crossing out the numbers: after each step a student crosses out the numbers which are eliminated, i.e. where the doors are locked;

f) the strategy is not evident or there is no strategy.

Consistency of solutions for numbers up to 10 with solutions for numbers up to 20 refers to a student's awareness that the solutions for numbers up to 10 would remain unchanged in spite of the fact that new numbers would be added to the problem (numbers from 11 to 20). Therefore if a student, while solving the problem with 20 cells, kept the same solutions for doors from 11 to 20 as in the first part of the problem with only 10 cells, then his or her solutions were defined as being consistent regardless of whether or not they were correct. But if a student, when solving the second part of a problem, got different solutions for doors from 11 to 20 than s/he did in the first part of the problem (and wasn't disturbed by the inconsistency of the solutions), then his solutions were defined as being inconsistent.

Since students from different grades were included in our research, we expected to find different levels of mathematical knowledge. Therefore we also wanted to investigate the impact of students' age on their success in solving both problems, as well as on the choice of the strategy and the consistency of solutions.

The data gathered from solving the tasks were processed by employing descriptive statistics (frequency, relative frequency) and qualitative research methods. In the continuation the results of the analysis of various observation aspects are presented.

#### 2.4. Results and interpretation

Students' solutions were analysed from different perspectives according to our research questions:

a) Analysis of solutions according to their correctness

*Table 1.* Students' success in solving both problems.

	<b>Numbers up to 10</b> <b>Number of correct solutions</b>	<b>Numbers up to 20</b> <b>Number of correct solutions</b>
<b>Grade 6</b>	6 (43%)	0 (0%)
<b>Grade 7</b>	4 (40%)	0 (0%)
<b>Grade 8</b>	2 (25%)	1 (13%)
<b>Grade 9</b>	13 (72%)	9 (50%)
<b>Together</b>	25 (50%)	10 (20%)

Since the research sample was relatively small we can't conclude solely on the basis of these results that students in grade 6 or 7 are better at solving problems than students in grade 8 are. However, the jump in the success rate among grade 9 students compared to the other students is evident. Does this mean that also their strategies were more effective?

b) Analysis of solutions according to the choice of the strategy

A diverse choice of strategies was observed in students' solutions; of 50 students, only in 4 cases could the strategy not be defined (either the student didn't understand the problem, or s/he wrote the solution without providing a presentation of the procedure, or the strategy couldn't be discerned from the procedure presentation).

Among the used strategies (from a to e) only one was inappropriate: crossing out the numbers. This is inappropriate because it means the student was changing the doors' state only in one direction, while excluding the possibility of unlocking the doors again. All the remaining strategies were conceived of correctly, but they were not all used with equal success. It is easy to notice that some of the strategies are more transparent, i.e. representation in 'more lines,' where a new line is made for each new step, allowing us to predict that fewer mistakes would happen in the procedure. The strategy of analysing multiples is less transparent. After completing the tenth step we get, rather than a record of the final solution, a necessary synthesis of all the records which were produced after each step. In our opinion representations in 'one line' deserve special attention. As already mentioned, the students used different techniques for recording the change of the doors' state after each step. Some of these techniques were not very transparent, i.e. colouring numbers with two different colours (a student used one colour for locking and another colour for unlocking, but if another locking of the same door was needed s/he added some more of the first colour. . . , sooner or later the presentation became unclear and it was no longer obvious which colour prevailed). On the other hand the strategies of erasing and of adding the dots proved to be very original and useful even in the case of 20 doors. The strategy of erasing then colouring a number makes the final solution clearly visible, but we lose track of the intermediate process. The strategy of adding dots, on the other hand, keeps the information about the intermediate process. By counting dots at a given number we get information about how many times a change occurred at that door: this can be an excellent starting point for searching for a general rule.

Table 2 shows the distributions of strategies used among all participants, according to grade.

Table 2. Distribution of used strategies.

	Grade 6	Grade 7	Grade 8	Grade 9	Together
<b>'More lines' (ML)</b>	4 (29%)	6 (60%)	2 (25%)	6 (33%)	18 (36%)
<b>Analysis of multiples (AM)</b>	2 (14%)	1 (10%)	0	6 (33%)	9 (18%)
<b>'One line' (OL)</b>	4 (29%)	2 (20%)	4 (50%)	2 (11%)	12 (24%)
<b>Writing solutions (S)</b>	2 (14%)	0	0	3 (17%)	5 (10%)
<b>Crossing out (C)</b>	0	1 (10%)	1 (12.5%)	0	2 (4%)
<b>No strategy (N)</b>	2 (14%)	0	1 (12.5%)	1 (6%)	4 (8%)
<b>Together</b>	14	10	8	18	50 (100%)

We can conclude from table 2 that the most used strategy was representation in 'more lines.' It is evident that among 6th and 8th graders representations in 'one line' were often used; among 9th graders, meanwhile, we can notice the growth in the use of multiple strategy analysis and in the strategy of writing solutions which are less present in younger students. The question which obviously occurs from those results is whether the chosen strategy had an impact on problem-solving success.

### c) Analysis of strategy effectiveness

Among students who successfully solved the 'prisoner cell' problem for 10 cells, the strategy of representations in 'more lines' was used by 10 students, the strategy of representations in 'one line' was used by 7 students, and the same number of students used analysis of multiples (4) and writing solutions (4) (see table 2). The most successful strategies among 6th and 7th graders were representations in 'more lines' and representations in 'one line,' while among 9th graders we can notice also successful use of analysis of multiples (AM) and the strategy of writing solutions (S). We believe that the reason for this difference lies in the fact that AM and S strategies demand less systematic work and more synthesis of partial information (AM) or mental work (S). The student who used the strategy of writing solutions (S) had to think about the effect of locking/unlocking the doors in each step, but wrote only a final solution. The student who used the strategy of analysis multiples (AM) had to make a synthesis of what was, at first sight, an opaque and discrete description for each step separately and bring them together in a final record. Young students were less successful at these two strategies; this is due to the fact that they used a more explicit way of recording, after each step, whether the prison cells were open or closed, which enabled strategies of representing partial and final solutions in one or more lines.

Table 3. Effectiveness of strategies for solving the 'prisoner cell' problem.

	ML	OL	AM	S
<b>Grade 6</b>	2	3	0	1
<b>Grade 7</b>	3	1	0	0
<b>Grade 8</b>	1	1	0	0
<b>Grade 9</b>	4	2	4	3
<b>Together</b>	10	7	4	4

### d) Analysis of consistency of the strategies used and generalisations made.

We were interested in whether students would be aware that shifting to the second part of the problem (prison with 20 cells) required no new strategy in comparison to the strategy of the first part of the problem (prison with 10 cells). The number of students who were capable of that insight is presented in table 4.

Table 4. Successful strategy transfer from first to the second part of the problem.

<b>Grade 6</b>	3/14	21%
<b>Grade 7</b>	3/10	30%
<b>Grade 8</b>	4/8	50%
<b>Grade 9</b>	10/18	56%

It is evident that the student's age influences his or her ability to transfer a known strategy into a new situation that is in relation to the development of mental schemes. The strategies which were successful in the first part of the problem (the 10-cell prison) became less useful in the second part of the problem (the 20-cell prison). The strategies led to mistakes and non-readable records. This is especially true for the 6th and 7th grade students. None of them was able to solve the second part of the problem. Though the complexity of the second part of the problem should encourage the students to find out more effective strategies, this was not the case with the younger participants of our research. The 'prisoner cell' problem is connected to the mathematical idea of determining the number of divisors of a given number. If a given number has an odd number of divisors, then the cell will be open at the end; if the number of divisors is an even number, the cell will be closed. The numbers which meet this criterion are squared numbers. Even though determining divisors of a number is part of the grade 6 and 7 mathematics curriculum, none of the participants from these grades was able to connect the prisoner cell problem with this mathematical concept. Two of the students from grade 9 were able to connect the problem to the squares of natural numbers. They didn't find that connection on the basis of thinking about divisors but on the basis of written solutions for 20 cells in the prison. Two 9th graders also wrote a correct final solution based on the analysis of one example, for cell number 14, for which they wrote down its divisors. We assume that they were able, by analysing the number of divisors for number 14 (1, 2, 7 and 14), to conclude that they needed a number which has only one divisor other than 1 and the number itself. We would like to emphasise once more one of the strategies which could be used as a starting point for discovering the relationship between the problem and the divisors. This strategy is presented in Figure 4 as representation in 'one line,' based on adding dots. The students were constantly adding dots to the cell number to present the change of the cell status (closed, open). At the end of the procedure the student counted the number of dots for each cell: if the number of dots is odd, the door is open, and if it's even, the door is closed. Two students used that representation, but neither of them was able to establish the connection between the dots and the divisors of a particular cell number.

### 3. Conclusion

Problem solving is, according to many different research papers and curriculum documents, a vital part of mathematics education. The reason for this conclusion is that problem solving develops cognitive abilities, emphasises the application of

mathematical knowledge, improves creativity, etc. (Schoenfeld, 1992), while also being a basic skill that is needed in all areas of life (Kirkley, 2003).

Problem solving is an activity that is relevant not only to gifted students but to all learners of mathematics. Our research also points out and makes evident that gifted students are motivated to solve problems. The question that arises from these facts is how to develop in the mathematics learning process problem solving skills, heuristics and strategies among students? Though we all agree that problem solving challenges students, less importance is given to developing problem solving knowledge. When and how do students learn to generalise? We assume that this somehow happens along the way as mathematics is learned, and we are often surprised about students' weak performance on problem solving tasks in different assessment schemas, e.g. TIMMS. Students are usually asked to generalise, to connect some mathematical ideas and to reason mathematically. It is again time to question ourselves about what mathematical knowledge our students need. If we all agree that problem solving skills are important, and we have a limited amount of teaching hours of mathematics, then we have to decide what is less important and replace it with problem solving activities. What is 'it' (less important in mathematics) is the key issue! Mathematics is not only calculation; the aim of teaching should also be to develop understanding and mathematical thinking. School teaching has been accused of viewing the act of teaching and the context in which it takes places entirely differently (Pehkonen, Naveri, Laine, 2013).

Research in the field of problem solving is focused on the cognitive processes associated with strategies used by enquirers (students of all levels) in solving selected problems. By analysing the process of solving problems we gain insight into the strategies used by solvers, and on the basis of this insight we can draw conclusions about the success of specific strategies in forming generalisations. An important finding in this regard is that not all strategies are equally efficient – the context of a problem can either support or hinder generalisation. However, selecting a good mathematical problem is not the only criterion for successful generalisation. Another important factor is the social interaction between the solvers of the problem, which means that when solving a problem – in addition to the dimension subject-object (solver-problem) – it is also necessary to take into account the dimension subject-subject (solver-solver, solver-teacher). School culture has typically been characterised by a restriction of discussion; according to learning studies, however, free discussion among pupils should be encouraged and guided in the right direction, while being kept within reasonable bounds (Pehkonen, Naveri, Laine, 2013).

There are two types of mathematical problems: conceptual and procedural ones (Haapsalo, 2003). We believe that generalising when dealing with procedural problems is in many cases not such a problem in comparison to generalising conceptual problems, where connecting the problem to a certain mathematical concept is necessary (Manfreda Kolar, Hodnik Čadež, 2013). (This is true for mathematically gifted students and not for all students. For those who do not have particular potential or interest in mathematics, every instance of mathematical generalising is difficult.) Often a mathematical concept is not explicitly presented in the problem (e.g. the 'prisoner cell' problem has to do with the divisor, which is not obvious at

first sight). Searching for these connections is, to our knowledge, an essential activity for mathematically gifted students. Or, in other words, seeing the mathematics in the problem and not merely operating with numbers.

Our ‘prisoner cell’ problem was a challenge for the gifted students, and they were 50% successful at individually solving the first part of the problem (with 10 cells). This is a clear indication that with a help of a teacher who capably guides discussion among students the success rate would be even higher. We see the role of teacher guidance as that of connecting the idea of the problem with the mathematical concept that lies behind the problem. The role of the teacher is crucial in recognising those students’ solutions which could contribute to further development of activity, to making conclusions and to forming general mathematical statements. By guiding the students with questions we encourage them to connect a problem with mathematics, though this was not evident to the students who participated in our research. We can conclude that the teacher plays an important role in problem solving in school, by means of knowledge, problem selection and the way the problem situation is conveyed, as well as by guiding students through the process of solving the problem. The greater the teacher’s competence in problem solving, the greater the likelihood that s/he will include problem solving situations in mathematics instruction, thus developing this competence among students.

## References

- [1] CIOSEK, M. (2012), *Generalization in the process of defining a concept and exploring it by students*, In B. Maj-Tatsis, K. Tatsis (Eds.) *Generalization in mathematics at all educational levels* (pp. 38–56), University of Rzeszow: Rzeszow.
- [2] COCKBURN, A. D. (2012), *To generalise or not to generalise, that is the question*, In: B. Maj-Tatsis and K. Tatsis (Eds.), *Generalization in mathematics at all educational levels* (pp. 38–56). University of Rzeszow: Rzeszow.
- [3] HAAPASALO, L. (2003), *The conflict between conceptual and procedural knowledge: should we need to understand in order to be able to do, or vice versa?*, In L. Haapasalo & K. Sormunen (Eds.), *Towards meaningful mathematics and science education*, Proceedings on the XIX Symposium of the Finnish Mathematics and Science Education Research Association (pp. 1–20), University of Joensuu, Finland: *Bulletins of the Faculty of Education* (No. 86).
- [4] HARTAS, D. (2010), *Educational research and inquiry, qualitative and quantitative approaches*, London: Continuum International Publishing Group.
- [5] KIRKLEY, J. (2003), *Principles for Teaching Problem Solving*, Retrieved February 20 2012 from: <http://citeseerx.ist.psu.edu/viewdoc/downloaddoi=10.1.1.117.8503&rep=rep1&type=pdf>.
- [6] KRUETSKII, V. A. (1976), *The psychology of mathematical abilities in school children*, Chicago: University of Chicago press.
- [7] MAJ-TASTIS, B., & TASTIS, K. (2012), *Generalization in mathematics at all educational levels*, Rzeszow: University of Rzeszow.



- [8] MANFREDA KOLAR, V., & HODNIK ČADEŽ, T. (2013), *Dependence of the problem solving strategies on the problem context*, In M. Pavleković, M. Kolar-Boegović & R. Kolar-Šuper (Eds.), *Mathematics teaching for the future* (pp. 162–172), Zagreb: Element.
- [9] PEHKONEN, E., NAVERI, L., & LAINE, A. (2013), *On Teaching Problem Solving in school mathematics*, CEPS Journal, Vol. 3, No. 4, 9–25.
- [10] SAGADIN, J. (1991), *Razprave iz pedagoške metodologije* [Discussions on pedagogical methodology], Ljubljana: Znanstveni inštitut Filozofske fakultete Univerze v Ljubljani.
- [11] SCHOENFELD, A. H. (1992), *Learning to Think Mathematically: Problem Solving, Metacognition, and Sense-making in Mathematics*, In D. Grouws (Ed.), *Handbook for Research on Mathematics Teaching and Learning* (pp. 334–370), New York: MacMillan.
- [12] WIECZERKOWSKI, W., CROPLEY, A. J., & PRADO, T. M. (2002), *Nurturing talents/gifts in mathematics*, In K. A. Heller, F. J. Monks, R. J. Sternberg, R. F. Subotnik (Eds.), *International handbook of giftedness and talent*, Oxford: Elsevier Science Ltd.
- [13] ZIMMERMAN, B. (1992), *Profile mathematischer Begabung*, Fallstudien aus einem Projekt für mathematisch talentierte Schüler sowie aus der Geschichte der Mathematik, (Types of mathematical Giftedness. Case Studies from a Project with talented Pupils and from History of Mathematics.), *Der Mathematikunterricht* 1, 19–41.

Contact addresses:

Tatjana Hodnik Čadež  
Faculty of Education  
University of Ljubljana, Slovenia  
e-mail: tatjana.hodnik-cadez@pef.uni-lj.si

Vida Manfreda Kolar  
Faculty of Education  
University of Ljubljana, Slovenia  
e-mail: vida.manfreda-kolar@pef.uni-lj.si

## Razumevanje pristopov k reševanju problemov pri matematično nadarjenih učencih

---

---

Tatjana Hodnik Čadež i Vida Manfreda Kolar

Pedagoška fakulteta, Univerza v Ljubljani, Slovenija

*Povzetek.* Reševanje matematičnih problemov je vodilna kreativna aktivnost v matematiki, ki jo lahko oz. jo moramo ponuditi tudi za matematiko nadarjenim učencem na vseh stopnjah šolanja. Raziskave so namreč pokazale, da tudi matematično nadarjeni učenci opredelijo reševanje problemov kot najpomembnejšo komponento matematične nadarjenosti. Pri reševanju matematičnih problemov se lahko osredinimo na različne vidike, ki so predmet raziskav na področju reševanja problemov: miselne sheme, posploševanje, proceduralni, konceptualni problem, hevrstike... V tem prispevku nas bo zanimalo predvsem to, kako nadarjeni učenci (od 6. do 9. razreda osnovne šole) rešujejo problem, kjer se od njih pričakuje iskanje vzorcev in pravil med informacijami in posploševanje. Rešitve učencev pri reševanju problema analiziramo iz različnih perspektiv: glede na izbor strategije, glede na pravilnost rešitve ob različnih razširitvah problema in glede na relacijo med učenčevo starostjo in uspešnostjo reševanja problema. S tako analizo dobimo boljši vpogled v razvoj miselnih shem za reševanje problemov med matematično nadarjenimi učenci. Z dano raziskavo želimo prispevati k bolj sistematičnemu in organiziranemu delu z nadarjenimi učenci pri pouku matematike. Učitelje matematike želimo spodbuditi, da bi se odločali za vključevanje reševanja problemov v poučevanje, saj bi to predstavljalo spodbudo tudi za nadarjene učence in možnost uresničevanja njihovih potencialov. V prispevku smo predstavili nekatere načine in strategije, ki so jih učenci uporabili pri reševanju izbranega problema z namenom, da bi učiteljem matematike posredovali praktične primere, ki bi jim lahko služili tako kot izhodišče za razgovor z učenci kakor tudi kot izziv za učence v procesu učenja matematike.

*Ključne besede:* matematično nadarjen učenec, reševanje problemov, posploševanje, miselna shema, strategije reševanja problemov

## Contemporary methods of teaching mathematics – the discovering algorithm method. Algorithm for fraction division

---

---

Maja Cindrić<sup>1</sup> and Irena Mišurac<sup>2</sup>

<sup>1</sup>Department of Teachers' and Preschool Teachers' Education, University of Zadar, Croatia

<sup>2</sup>Faculty of Humanities and Social Sciences, Department of Teacher Education, University of Split, Croatia

*Abstract.* The requirements of contemporary life imposed by rapid economic growth and development in the world, and in Croatia, impose new goals and requirements on education. New requirements highlight new values and competences that have not been in focus until recently but have been characterized as competences owned only by individuals. However, flexible problem-solving skills and establishing connections among new information, as well as logical thinking and linking all aspects of knowledge, is no longer a characteristic needed only by single people, but the general population in a world of rapid technological changes and economic development. Such a combination of skills and competence of individuals should be developed through the education system. Mathematics as a subject, by its nature and content is favorable in achieving such goals. Yet the traditional methods of teaching mathematics focused on the adoption of procedural knowledge can only develop such skills with the individual. However, the introduction of new methods of teaching mathematics can enhance traditional teaching and provide the development of necessary skills to a wider population of pupils.

This paper describes one of the modern methods of teaching mathematics, as well as the impact that this method has on procedural knowledge and on the development of conceptual knowledge. Research on the impact of the discovering algorithm method for fraction division in procedural and conceptual knowledge of fraction dividing was conducted on a sample of 241 pupils of the sixth grade of elementary school, divided into test and control groups. The results showed a positive influence of the discovering algorithm method for fraction division on procedural and conceptual knowledge in relation to the traditional method of demonstration procedures and training.

*Keywords:* algorithm, division of fractions, conceptual knowledge, procedural knowledge

## 1. Introduction

The very thought of studying mathematics associates most people with the experience of studying mathematics by practicing a lot of arithmetic operations and drills. These are often problems that require only the application of the same procedure. Most teachers apply such an approach with their pupils in teaching mathematics or classroom teaching. On the other hand, teachers' expectations of the pupil's knowledge in mathematics surpass their teaching and their presentation of learning mathematics. Knowing the multiplication table and addition up to 20 is often equalized with memorizing facts from history or learning by heart, but in certain situations we wish pupils to recognize where they should use this and to skilfully extract from memory what they have learned. That level of knowledge is hardly achieved by copying the shown procedure and practicing it with numerous similar problems. Such type of knowledge, which points out understanding, problem solving, application, logical conclusion, and also skilfulness in performing mathematical operations, is the goal of contemporary teaching of mathematics, as well as the need of the contemporary way of living. How to achieve such a complex goal? Neglecting algorithms and procedures and focusing on the application and solution of problem solving with the help of a calculator? It must, of course, be taken into account that upon emphasizing the deficiencies of the mathematics teaching tradition, its advantages are not to be neglected. The optimal balance in the development of procedural and conceptual knowledge in teaching mathematics is a guarantee of quality development of mathematical thinking with pupils (Hiebert, Lefevre, 1986). It is not necessary to negate teaching algorithms for computing, but to choose the adequate teaching methods and approaches which will, through the introduction of contents, will keep track of the development of earlier emphasized competences. If we look back at the history of mathematics, we can see that all the procedures, schemes, and the very facts of mathematical content have appeared from generalizing and formalizing processes and procedures that arise from a problem, whether applicable in some other field or from mathematics itself. People (whether mathematicians or not) faced with a problem apply their earlier acquired knowledge, logical thinking in finding a solution to a problem. Such processes are improved or generalized only when considered that such a process will be of use to them or someone else on their way to finding a solution to a new problem. And then, such a process becomes a "tool", a tool that can be separated from the primary problem, improved and upgraded. In initial teaching of mathematics, pupils are still not acquainted with the sophisticated mathematical approach, just developing features that are often attributed to good mathematicians, contemplation, logical reasoning and connecting all elements of mathematical and other knowledge. Then the offer of known procedures ("tools") divided from one of their central problems makes this procedure abstract and unclear. Such an approach is surely not a contribution to the development of skills as deliberation, modelling, problem solving or making connections. Such an approach is the framework of problem directed teaching of mathematics where the goals of tuition place the development of mathematical reason in the foreground which is necessarily to remain in the background of all algorithm and calculation use in teaching mathematics, but outside the school environment (Ma, 1999).

### 1.1. Method of discovering algorithm in teaching mathematics

In teaching mathematics, the presentation and practicing of different procedures has taken such roots that the pupils themselves often wait “to be shown how it is done and so they can practice”. This type of teaching is common in traditional schools directed towards the content and remembering facts and procedures. Following textbook literature, in teaching mathematics to lower classes of elementary school, most of the time teachers take the time to adopt and practice single algorithm calculations. Thus adopting an algorithm comes into the focus of math teaching and the flexible performance and application of such an algorithm becomes the primary goal of the teacher in such a class. We here wish to firstly point out that we do not consider flexible knowledge of calculation to be an inessential part of mathematical knowledge. On the contrary, flexible calculation is an important thread in the bundle of mathematical competences, as Kilpatrick (2001) describes the expected goals of teaching mathematics. However, isolated from understanding, logical reasoning, capacity of problem solving and the possibilities of connecting the calculations with situations that make the calculation meaningful, as well as situations where that calculation can be applied, the bare knowledge of calculation does not have a great significance in the informatics society of nowadays.

This type of deliberation leads us to shaping teaching methods which, through work on mathematical procedures or algorithms, will also develop the other important elements of quality mathematical knowledge. One of such methods in teaching mathematics is discovering algorithm. Through solving problems, mathematical modeling and applying earlier acquired knowledge, pupils actively build new cognitions which are not new for those with a higher level of knowledge, but they are also directed to discovering them (Freudental, 1973). Such an approach starts with choosing a problem, which includes a context that according to Vergnaud (1996) is the basic of three elements of the mathematical concept construction. In order to solve the problem, the pupil models the situation to a certain level. Just as in the history of mathematics, with time procedures improved and thus it is not to be expected that, based on one problem, pupils discover a standardized algorithm by themselves. Pupils come to various ideas in solving problems. Due to the difference in their cognitive possibilities and former acquired knowledge, they apply the strategy of various levels, from elementary to complex ones. Problem solving by pupils, besides carefully planned activities, is to be complemented by quality discussions moderated by the teacher who directs pupils towards the improvement of the preliminary procedure. Sometimes the teacher intervenes by placing another problem at the critical moment, which leads the pupil to search for more adequate forms of solution or procedure. If the given task is not a problem for the pupil, he will solve it using the most developed solution strategy which most often includes calculation. The pupil then has no need for developing neither new strategies nor setting off to discover new cognitions which will generalize and thus build up his present knowledge. It is often possible to see in lower primary school grade textbooks that the algorithm of written division starts with a problem such as  $36:3$  even in the form of a textual problem with a certain context. However, such a problem is not a challenging for most pupils at that age and they easily determine

the quotient. Knowing that  $36 : 3 = 12$  they have no need to resort to discovering a new procedure in finding the solution and cannot understand the longer written procedure beneath the problem itself. Through several such examples, whose procedure of written algorithm the teacher offers on the blackboard, pupils recognize this as the goal of adopting and writing the very manner of division and not just finding the quotient. Focus on understanding and memorizing the procedure drags the pupil away from the meaningful use of the same in new situations. Hart (1981) showed that regardless of the amount of time dedicated to studying the written algorithm of division, children prefer to use the strategy of consecutive deduction instead of division, for example, in situations when they have to determine how much time is needed for a truck to cross 500 km, if driving at a speed of 75 km/h, they prefer to deduce 75 from 500 until they exhaust the initial group instead of using division. The authors of this work observed in the same way a child who successfully divides a written algorithm in math class, but if outside the school context she wants to determine how many eggs she can buy with 37 kn and each egg costs 3 kn, the instead of dividing, she writes a series of numbers from 1 to 37 and crosses out 3 numbers in a row and for each crossed out line she draw one egg in the shopping bag. At the end, by counting she determines that she can buy 12 eggs with 1 kn remaining for which she can buy a lollipop which she also draw in the bag (Figure 1).

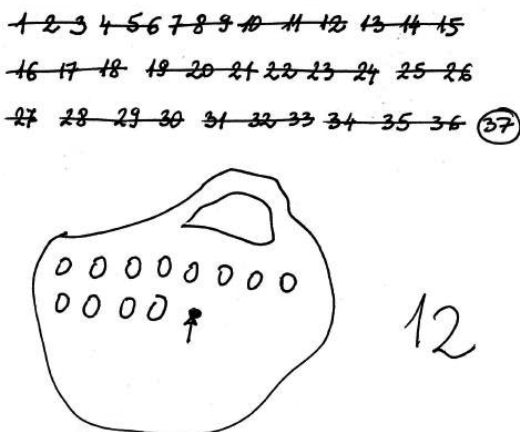

Figure 1. Instead of the written division, the child uses a more elementary strategy.

Illustrated in this way, it seems that the algorithms instructed in the school context have become an end in themselves.

We can thus also reflect on adopting the addition table of numbers up to 20 or the multiplication table. The isolated fact itself from the addition table, such as  $7 + 4 = 11$ , does not mean anything if it is not connected to the cognitive network with the facts that  $7 + 3 = 10$ , and then  $7 + 4$  has to be 1 more than 10 etc. (Skemp, 1976, Van Hiel 1973, Cindrić and Mišurac, 2013). The child builds such a network on the basis of physical experience and previously acquired formal and informal knowledge on numbers and calculation operations. Thus knowing facts in desired

way cannot be divided from the application of such facts and their awareness and meaning through single examples.

The goal of teaching mathematics must be deeper and more significant than the very adoption of procedures and mathematical facts. According to Kilpatrick (2001), the goal of teaching mathematics is to develop in pupils conceptual understanding, procedure performance fluency, capacity of using various strategies, deliberation and a positive attitude towards mathematics. In this matter, all skills must be interwoven and permeate one another. Such an aim cannot be realized through traditional methods of teaching like the demonstration and practicing of algorithm, but it is possible through the method of “discovering” algorithm. Pupils who have a well developed concept of a single type of number and a well developed concept of calculation operations, problem solving, mathematical modelling, discover the algorithm gradually without having it demonstrated to them by the teacher. With this procedure the contents of teaching mathematics are not negated, as it may at moments seem, but pupils are, on the contrary, allowed to take the road of discovering mathematics and its beauties just as others had gone a long time before them. Freudental (1973) states that pupils should be given the possibility to rediscover mathematics. However, the discovery process of single cognitions in the history of mathematics was a long-term process, while through the organized process of teaching in which the teacher must be aware of a child’s possibilities and possible outcome of the process can shorten this process without forcing the pupil to accept single facts, but lead the pupil to cognition through planned activities. In the method of algorithm discovering, the key role is played by the teacher as a moderator of activities and people who lead a discussion, and through key issues and perturbations leads the pupil to insights and cognitive conflicts with which a strong network of understanding is built.

## 1.2. Discovering the algorithm for fraction division

According to the Elementary School Teaching Plan and Programme (2006) the division of fractions is taught in Croatian schools in the 6<sup>th</sup> grade (12-year-olds). The traditional division of fractions is taught with an earlier introduction of reciprocal values of fractions without influencing the purposefulness of defining reciprocal values. The algorithm of fraction division is then presented to pupils according to the model:

$$\frac{a}{b} : \frac{c}{d} = \frac{a}{b} \cdot \frac{d}{c}.$$

Contrary to this approach, it is possible to approach the division of fractions by discovering the division algorithm. Sharp and Adams (2002) offer realistic situations where they observe pupils’ strategies in discovering algorithms, just like Yim (2010) who shows the strategies in which pupils, by drawing rectangles, determine the quotient from the connection between division and multiplication. In our research we have set off from the combination of realistic situations suggested by Sharp and Adams (2002) leading towards the principle suggested by Yim (2010).

We are here offering the skeleton discussion, which, depending on the situation and pupils' foreknowledge, leads in different directions and leads pupils towards the discovery of the division algorithm which we used in our research.

Examiner: Mary decided to sell olive oil to tourists. She had 12 litres and poured them into bottles of  $\frac{1}{2}$  litre. How many bottles did Mary need?

*(If the pupil immediately answers 24 bottles, he is asked how he came to that answer. If he does not know how to answer then he must be lead to sketch it and try to come to the conclusion)*

Examiner: How would he write that calculation? The pupil most often gets the answer by counting and does not connect that with division and then a similar problem is given: "Sanja was also selling olive oil to tourists. She had thirteen litres of oil and poured them into bottles of 2 litres. How many bottles did Sanja need?" If the pupil again does not connect this with division, for the number are in the form of a multiplication table and the pupil cannot guess that the answer is 7, because  $7 \cdot 2 = 14$ , then the following problem is given. "Neighbour Frane sells olive oil to a factory in wholesale for he has 636 litres of oil. The oil is transported in bottles of 12 litres. How many bottles does neighbour Frane need?"

Examiner: Can you say now how you would write the equation in the first problem?

Pupil:  $12 : \frac{1}{2} =$

Examiner: Right, and what is the answer, i.e. how much is  $12 : \frac{1}{2}$ ?

Pupil:  $12 : \frac{1}{2} = 24$ .

Examiner: Right! You're dividing fractions! Have you already learned to divide fractions?

Pupil: No.

Examiner: Can we continue?

Pupil: Yes!

Examiner: After having sold 12 litres of oil, Mary got  $1\frac{1}{4}$  more litres of oil to sell from her grandmother. How many  $\frac{1}{2}$  litre bottles did she need to pour her grandmother's oil into? How would you write that equation?

Pupil:  $1\frac{1}{4} : \frac{1}{2} =$

Examiner: Write the expression with an improper fraction!

Pupil:  $\frac{5}{4} : \frac{1}{2} =$

Examiner: Make a sketch! Let's imagine that each one of these squares is 1 litre



of oil. Shade the amount of oil Mary has! If you know that each bottle contains  $\frac{1}{2}$  litre, how many such bottles do you have to single out? Will all the bottles be full?

Pupil:

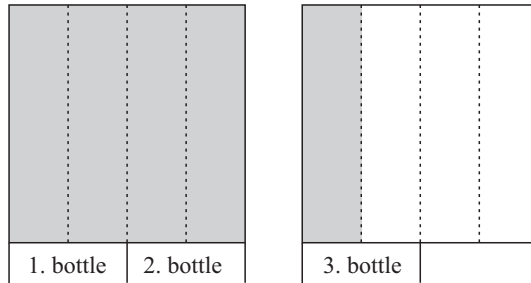

Examiner: How many bottles will be filled with oil?

Pupil:  $2\frac{1}{2}$  bottles.

Examiner: How is that express with an improper fraction?

Pupil:  $\frac{5}{2}$ .

Examiner: How can we know how much is  $\frac{5}{4} : \frac{1}{2} = ?$

Pupil:  $\frac{5}{4} : \frac{1}{2} = \frac{5}{2}$ .

Examiner: What does  $\frac{5}{4} : 2$  mean?

Pupil: Mary has  $\frac{5}{4}$  litres of oil and wants to pour it into bottles of 2 litres. How many bottles does she need?

Examiner: Does she need more than one bottle?

Pupil: No.

Examiner: Why?

Pupil:  $\frac{5}{4}$  is less than 2.

Examiner: Then we can change the question, can't we?

Pupil: How much of the two-litre bottle will be filled?

Examiner: Right! How would you define the answer?

Pupil: I would divide  $\frac{5}{4} : 2$ ?

Examiner: Can you divide those two numbers?

Pupil: Not really!

Examiner: Can you use a drawing like in the previous example?

Pupil:

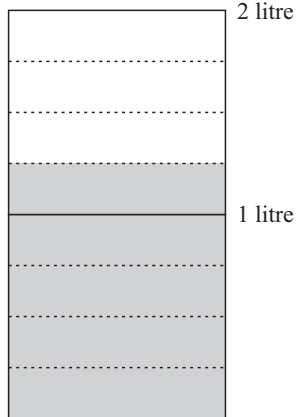

Examiner: How much of the two-litre bottle is filled?

Pupil:  $\frac{5}{8}$

Examiner: Can you now give a full answer?

Pupil:  $\frac{5}{4} : \frac{2}{1} = \frac{5}{8}$ .

Examiner: Now copy all the equations of fraction division, maybe you can notice regularity. It would be difficult to each time imagine pouring olive oil and determine that with a drawing, wouldn't it? Do you think there is an easier way of dividing fractions?

Pupil: I think there is!

Examiner: I want you to discover it by yourself. Can you?

The very course of activities is accompanied by the physical activities of pouring liquid or drawing where the pupil can be offered empty rectangles or let the pupils do this by themselves. Different variations of this skeleton are to be adapted to the pupil's potentials.

## 2. Methods

### 2.1. Research goal

Children in elementary school have more problems with division than any other calculation, and particularly in dividing two fractions (Cindrić and Mišurac, 2010). In teaching and practicing algorithm, pupils remember the procedure, but without repetition they forget it after a short period of time. Our goal is to show that using the discovering algorithm method through the proposed structure and the indication of active participation of pupils in building their own knowledge, pupils are more successful in procedural and conceptual knowledge. It is also our goal to show that such knowledge is permanently retained by pupils.

## 2.2. Model research

The model group research consisted of 241 sixth-grade pupils from 4 elementary schools in the Zadar County region. The model group was divided into a test group and a control group. The mean age of the pupils in the test group was 11.8 years, while in the control group it was 12.0 years, which is not significant for the differences in research results. The groups were also comparable according to the gender structure, in the test group 52% were boys and 48% girls, while in the control group 55% were boys and 45% girls. There were more boys than girls in both groups so that the possible differences in successfulness were not caused by the differences in the gender structure of the test and control groups.

## 2.3. Research procedure

In order to understand and analyze the research, it is important to emphasize the role of the mathematics teacher in the sectors where the test and control groups are found. Teachers that had gathered at the mathematics teachers' team meeting were asked for cooperation in the research of contemporary working methods in teaching mathematics. Three mathematics teachers with 10, 18, and 21 years of experience responded to the invitation. These three teachers were chosen to be the teachers of the test group. Three more teachers who were not familiar with the discovery algorithm method were further asked to test their pupils. The teachers in the control group were chosen in a way to correspond in age experience to the teachers in the test group. Their years of teaching mathematics experience were 5, 20 and 22 years. They were, however, asked to briefly describe the manner of introducing the division of fractions. Their work was based on presenting the algorithm and practicing (Figure 2), whereby they were confirmed as being adequate as teachers in the control group for which we expect to being taught in the traditional manner.

3. Objasnite ukratko način na koji uvodite dijeljenje razlomaka u 6. razredu.	3. Objasnite ukratko način na koji uvodite dijeljenje razlomaka u 6. razredu.
$\frac{a}{b} : \frac{a}{d} = \frac{a}{b} \cdot \frac{d}{c} = \frac{ad}{bc}$ <p>Pr. <math>\frac{2}{3} : \frac{1}{6} =</math></p> $= \frac{2}{3} \cdot \frac{6}{1}$ $= 4$	<p>→ ponoviti množenje razlomaka prvo  → -- reciprocne brojeve  → uvesti pravilo za dijeljenje razlomaka</p> $\frac{a}{b} : \frac{c}{d} = \frac{a}{b} \cdot \frac{d}{c}$

(3. Explain briefly the way you introduce fraction division in 6<sup>th</sup> grade

- Repeat the multiplication of fractions first
- Repeat reciprocal numbers
- Introduce the rule for fraction division)

Figure 2. Traditional approach to fraction division posed by math teachers.

The teachers of the test group participated in a two-day workshop on the theme of contemporary mathematics teaching, where, among other things, the intervention procedure in teaching was developed. Intervention in teaching lasted for two lessons. The testing of the test and control groups was performed longitudinally in three periods. The first period 10 days after the teaching intervention, and the second seven days after the intervention, and 10 months after the intervention.

## 2.4. Research hypotheses

The research hypotheses are:

- Pupils taught fraction division by the discovery algorithm method were more successful in the procedural and conceptual knowledge of fraction division compared to pupils taught fraction division by presenting the division algorithm and practicing it.
- Pupils taught fraction division by the discovery algorithm method were more successful after having been taught, 7 months after having been taught and 10 months after having been taught compared to pupils that had been taught fraction division by presenting the division algorithm and practicing it.

## 2.5. Collecting data

Tests that both groups had undergone were part of the teaching process, and pupils did not acquire grades for the shown knowledge. The first test was at the end of the education unit on fractions, the second at the end of sixth grade and the third at the beginning of seventh grade. Procedural knowledge was checked with problems P1–P4 (Table 1), while conceptual knowledge was checked with problems K1–K3 (Table 2). Each test consisted of 4 procedural type of problem and 1 conceptual type of problem from K1–K3.

*Table 1.* Problems that test procedural knowledge of fraction division.

Problem mark	Problem	Discussion
P1	$14 : \frac{1}{5} =$	Dividend greater than the divisor. Dividend less than 1, and the divisor a natural number.
P2	$\frac{3}{5} : \frac{1}{7} =$	Dividend greater than the divisor. Both fractions.
P3	$\frac{2}{3} : 2 =$	Dividend less than the divisor. Divisor a natural number.
P4	$\frac{1}{4} : \frac{1}{2} =$	Dividend less than the divisor. Both fractions.

The procedural type of problem, from P1–P4, was created in a way to investigate eventual children’s misconceptions on dividing numbers, recorded in relevant literature. Children are familiar with division based on correct dividing in daily life and such division model, the partitive model, often takes up a larger space within school mathematics. Fishbein and others (1985), researched children’s misconceptions connected with division even though they did not define the problem as misconception but as persistent and influential models. The effect of such a model is that it corresponds to natural and basic features of human cognition (Fischbein, 1985). Namely, not only children but adults try to interpret naturally facts and ideas in terms of models that are coherent to them. In division, they point out that it concerns two intuitive models that children use when the problem situation demands division, and this is the partitive model of division and the measurement model of division. The consequences of the intuitive model that children have on division are as follows:

- The dividend must be less than the divisor
- The dividend must be a whole number
- The quotient must be less than the dividend.

On the other hand, assignments K1–K3 interpret the meaning of fraction division, if pupils thus recognize it. It is important to emphasize that there are no assignments of similar context in the textbook literature used by pupils. Also, this textbook literature does not cover contextualizing and meaningful interpretation of fraction division. The authors themselves introduce fraction division by demonstration procedure in the similar manner as teachers who show this in the control group.

*Table 2.* Problems that test the conceptual knowledge of fraction division.

<b>Problem mark</b>	<b>Problem</b>
K1	My dog got sick yesterday. I took him to the veterinarian. The veterinarian established an infection and gave me 15 tablets for him. My dog is quite big and the veterinarian recommended that I give him $1$ and $\frac{2}{3}$ tablet a day. How many days will the dog be taking tablets?
K2	My mother is a florist. This weekend she is making wedding confetti. They are made of shiny ribbons. $1\frac{1}{2}$ m of ribbon is needed for each confetti. How many confetti will she make with 11 m of ribbon?
K3	Yesterday Barbara celebrated her birthday. She treated her friends with pizza at the birthday feast. $\frac{7}{8}$ of one pizza was left over and she wanted to put it in the fridge. Before putting it in the fridge, she will put the pizza in plastic vessels with lids so it will not dry up. $\frac{3}{8}$ of the pizza fits in each vessel. How many plastic vessels does Barbara need?

All the problems from K1–K3 include the measurement model of division, which means that pupils have the possibility of solving with continual subtraction or use of various illustrations as shown in Figure 3.

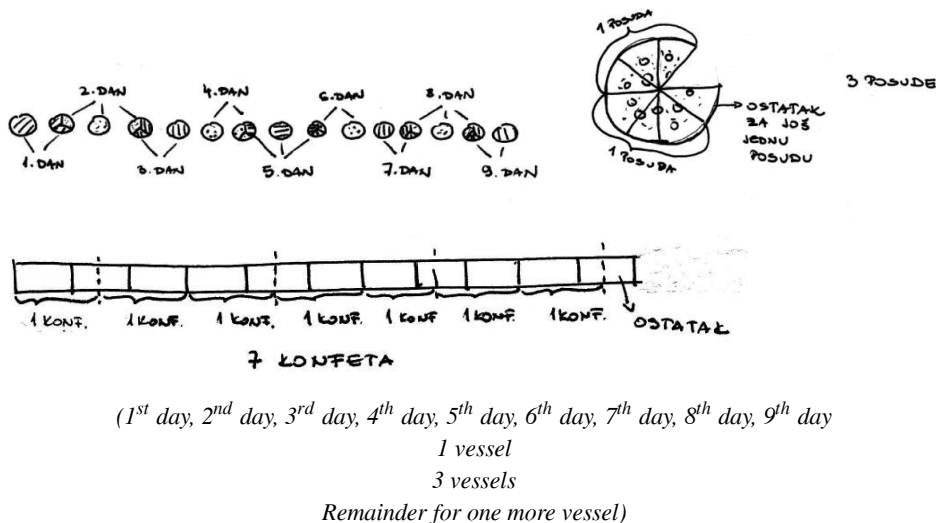

Figure 3. Illustrated modelling of a situation in K1–K3.

The use of the division algorithm in a series of strategies is most complex under the condition that in problems K2 and K3 the result is to be interpreted due to the existence of remainder which influences in different ways the interpretation of the results in problems K2 and K3. It is pointed out to pupils that they are expected to interpret the result in the form of a sentence. Only an interpreted result would be taken into consideration as correct.

### 3. Results

Average success in solving procedural problems P1–P4 of test group and control group immediately after teaching intervention (0), seven months after teaching intervention (7) and 10 months after teaching intervention (10) are shown in Table 3.

Table 3. Test group and control group success in procedural problems.

Months:	0	7	10
Test group (%)	82	64	59
Control group	75	41	40

In examining the diagram of Figure 4, we notice that, over the long term, the test group is more successful than the control group. At the moment, after

the intervention, the difference itself is smaller and statistically insignificant ( $p = 0.098113$ ), which we explain by the fact that at that moment all pupils were ready for the final examination of the fraction unit. The differences in successfulness in procedural knowledge after 7 to 10 months become statistically significant ( $p = 0.014001$ ) in favour of the test group.

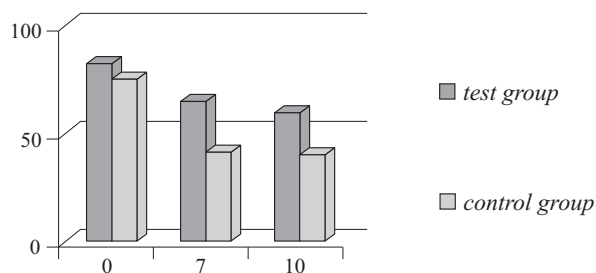

Figure 4. Diagram of success dependence on procedural knowledge in the course of time from the adoption of test and control groups.

Differences in successfulness of the test and control groups in conceptual understanding are highly significant, which can be seen in Table 4 and the diagram in Figure 5. The statistic significance of the difference is determined by the t-test, which for the period 0 gives  $p = 0.000241$ , for 7 months after intervention  $p < 0.00001$  and 10 months after intervention  $p < 0.00001$ .

The difference in types of problems P1–P4 does not give a statistically significant difference in the successful solution to single problems, which is to be expected due to eventual misconceptions in the division of fractions. The explanation to such a result can be found in the insufficient reflection of the pupil on what has been done. Knowing the division algorithm, pupils apply it, but in doing so they do not think of the meaningfulness of the result. Such a fact points to the focusing of algorithm implementation in teaching mathematics.

Table 4. Test group and control group success in conceptual problems.

Months:	0	7	10
Test group	64	35	41
Control group	21	10	8

Besides the success analysis itself, it is essential to point out the forms and ways of problem solving. Among all the examinees who successfully answered the question in the test group, 25% (0), 10% (7) and 9% (10) of them modelled the problem mathematically using the division algorithm with correct interpretation, while the others only gave the right solution without influence on the manner of acquiring the solution. An image or schematic presentation of the situation was not perceived in any of the pupils. 3% of the pupils in the control group modelled mathematically in all the observed periods. The remaining pupils, just like in the control group, gave an answer without additional explanation or display.

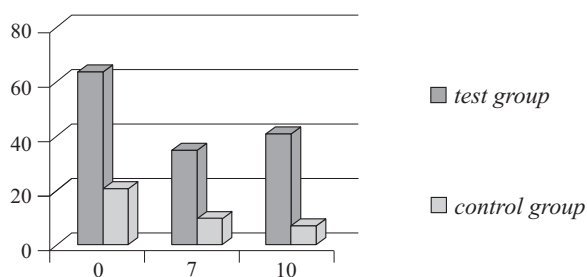

Figure 5. Diagram of success dependence on conceptual knowledge in the course of time from the adoption of test and control groups.

#### 4. Discussion

Researches (Carpenter, 1993) have shown that even little children, before receiving the formal teaching of mathematics, can solve many different types of textual problems, particularly those with addition and subtraction, through direct modelling of the problem situation, operation and connection in the problem. One of the basic processes in solving such problems is drawing up models and solving such problems. Many problems can be solved by directly illustrating the critical features with the help of physical, illustrated, and concrete displays. Thus modelling is shown as a relatively natural process in problem solving with little children. Reviewing the results and how pupils came to the solution in the test and control groups, we notice that none of the examinees resorts to any type of modelling besides formal mathematical modelling (numeral expression). Those who do not succeed in setting a numeral expression do not solve the problem. These results lead to obstinate traditional models of teaching where the pupil is directed only to modelling the problem by setting a numerical expression. Pupils in the school environment do not dare use any type of modelling that is not in line with the teaching. Do we thus through teaching neglect the essential aspect of a child's personality, creativity, innovation and use of logical thinking? The traditional way of teaching does not indicate the road from an elementary strategy of problem solving to a more complex one such as setting numerical expressions, while the cognitive possibilities of all pupils are not equal. Some children can "skip 3 steps" while others must go "step by step", and even then they often need assistance and encouragement. Pupils' solving textual problems adds up to choosing the calculation operation with which they will "connect" the numbers shown in the text. The calculation pupils most often choose is according to a key word in the text. The choice of dividing numbers in problems K1–K3 can be interpreted also with the fact that problems K1–K3 are preceded by P1–P4 in which pupils are asked to divide fractions. We can thus surely reduce the value of the results of conceptual understanding whereby it is demanded of the pupil to divide fractions and reduce the value of the results of conceptual understanding for both groups. It would not be, in any case, justified to expect great changes in the way of thinking and approaching textual problems only on the basis of one intervention in teaching. It is difficult to expect a spectrum of different strategies in the approach to problems as offered by Yim (2010) in



his study where he shows research with Japanese pupils whose national curriculum and math teaching has been directed for a good number of years towards the contemporary needs in mathematical education.

However, regardless of the disputability of conceptual understanding results, test group pupils have shown significantly better results in conceptual understanding after a longer period of studying. The discovering algorithm method has surely contributed to the understanding and meaningfulness of fraction division in pupils, whereby fraction division has been “networked” with the remaining concepts which pupils have been connecting to division and thus improved permanent memory of the division procedure. The discovering algorithm method, which combined with the discussion and cognitive conflict of pupils, releases the naturally embedded misconceptions, achieves understanding and meaningfulness of mathematics, and pupils are given security in problem solving where the solution does not have to necessarily result immediately with the mathematical method, but with some representation which will lead the pupil to the mathematical model.

## 5. Conclusions

In the approach to teaching mathematics, there is usual talk of the traditional and contemporary teaching of mathematics. Changes in the perception of teaching mathematics have come about for many reasons, and it is possible to briefly say that children’s and young people’s interest in mathematics is all the more decreasing, while the need for employees with developed mathematical skills is all the more increasing. There is an increasing need in society for young people who have a developed mathematical opinion in every socially useful profession. Leading people of industry and business state that future employees need much more than the traditional calculation skills of multiplication, division, addition and subtraction which were sufficient when jobs added up to problems that were repeated and represented routine. A higher level of mathematical knowledge and skills is needed in daily life, and almost every job demands the skills of analysis and interpretation of many mathematical concepts. Today employees are required to have mathematical literacy, technological competence, they should be adaptable to changes and capable of solving various complex problems, and possess the skills of effective lifelong learning. Due to this many changes have been initiated in the world in the approach to learning mathematics. The contemporary approach to mathematical school contents in most countries today emphasizes the development of conceptual knowledge controlled within the teaching process but does not also neglect procedural knowledge. All contemporary world curricula of teaching mathematics emphasize the skills of problem solving, logical thinking and argumentation, and a flexible application of mathematical knowledge as the framework of teaching mathematics, and they point out the optimal balance between the development of conceptual and procedural knowledge. The joint knowledge of facts, procedures and conceptual understanding is what we want our pupils to acquire in studying mathematics in school. Pupils who memorize facts and procedures without conceptual understanding are often not sure when and how to use what they know

and their knowledge is very fragile. On one hand, algorithms that are excessively practiced in mathematics without conceptual understanding are often forgotten or are incorrectly remembered. On the other hand, understanding concepts without fluency in performing calculations can represent an obstacle in solving problems. The goal is, therefore, to acquire computation fluency, but to also conceptually understand numbers, calculations and algorithms. It is not possible to realize such goal of mathematics teaching with the traditional method of teaching mathematics, which emphasizes the demonstration of the teacher, and the copying and practicing of the pupil. Accepting and implementing new methods such as the discovering algorithm method in teaching mathematics is necessary in achieving new goals. It is important to point out also that the acceptance of new values and methods does not mean the complete rejection of traditional values and methods.

## References

- [1] CARPENTER T. P., ANSELL E., FRANKE M. L., FENNEMA E., WEISBECK L. (1993), *Models of problem solving: a study of kindergarten children's problem solving processes*, Journal for Research in Mathematics Education, 24, 428–441.
- [2] CINDRIĆ, M., MIŠURAC Z. I. (2010), *Kvalitativna analiza nacionalnih ispita iz matematike i integracije*, In N. Marković (Ed.) Kvalitativna analiza ispita provedenih 2008. godine u osnovnim školama, Zagreb: Nacionalni centar za vanjsko vrednovanje obrazovanja.
- [3] CINDRIĆ, M., MIŠURAC Z. I. (2012), *Prednosti diskusije i kognitivnog konflikta kao metode rada u suvremenoj nastavi matematike*, Journal of the Institute for Educational Research, Vol. 44, No. 1, Beograd.
- [4] FREUDENTHAL, H. (1973.), *Mathematics as an Educational Task*, Dordrecht: Reidel.
- [5] HART, K. M. (1981), *Children's understanding of mathematics*, London: John Murray.
- [6] HIEBERT J., LEFEVRE P. (1986), *Conceptual and procedural knowledge in mathematics: An introduction analysis*, In J. Hiebert (Ed.), *Conceptual and procedural knowledge: The case study of mathematics* (p. 1–27), Hillsdale, NJ : Lawrence Erlbaum.
- [7] KILPATRICK, J., SWAFFORD J., FINDELL, B. (2001), *Adding it Up. Helping Children Learn Mathematics*, Washington: National Academy Press.
- [8] MA L. (1999), *Knowing and teaching elementary mathematics*, Hillsdale, NJ: Lawrence Erlbaum.
- [9] Elementary school plan and programme (2006)/online/ from <http://public.mzos.hr/Default.aspx?sec=2199> [Accessed 10/02/2014].
- [10] SHARP, J., ADAMS, B. (2002.), *Children's Constructions of Knowledge for Fraction Division After Solving Realistic Problems*, The Journal of Educational Research, 95 (6), 333–335.
- [11] SKEMP, R. R. (1976), *Relational understanding and instrumental understanding*, Mathematics teaching, 77, 20–26.

- [12] VAN HIEL, P. M. (1973), *Understanding and insight*, Purmerend: Muusses.
- [13] VREGNAUD G. (1996), *The theory of conceptual fields*, In L. Steffe, P. Nesher, P. Cobb, G. A. Goldin i B. Greer (Ed.), *Theories of Mathematical Learning* (p. 219–239), Mahwah New Jersey: Lawrence Erlbaum.
- [14] YIM, J. (2010), *Children's strategies for division by fractions in the context of the area of rectangle*, *Educational Studies in Mathematics*, Vol. 73, 105–120.

*Contact addresses:*

Maja Cindrić  
Department of Teachers' and Preschool Teachers' Education  
University of Zadar  
Franje Tuđmana 24i, 23000 Zadar, Croatia  
e-mail: mcindric@unizd.hr

Irena Mišurac  
Faculty of Humanities and Social Sciences  
Department of Teacher Education  
University of Split  
Teslina 12, 21000 Split, Croatia  
e-mail: irenavz@fst.hr

# Suvremene metode poučavanja matematike – metoda otkrivanja algoritama. Algoritam dijeljenja razlomaka

---

---

Maja Cindrić<sup>1</sup> i Irena Mišurac<sup>2</sup>

<sup>1</sup>Odjel za izobrazbu učitelja i odgojitelja, Sveučilište u Zadru, Hrvatska

<sup>2</sup>Filozofski fakultet, Sveučilište u Splitu, Hrvatska

*Sažetak.* Suvremene potrebe života koje nameće rapidni gospodarski rast i razvoj u cijelom svijetu, i u Hrvatskoj, nameće nove ciljeve i potrebe od strane obrazovanja. Novi zahtjevi ističu nove vrijednosti i kompetencije koje do nedavno nisu bile u fokusu, već su se karakterizirale kao kompetencije koje posjeduju samo pojedinci. Ipak vještine fleksibilnog rješavanja problema i manipularanja novim informacijama, kao i logičko razmišljanje i povezivanje svih aspekata znanja, više nije karakteristika potrebna samo pojedinim osobama, već široj populaciji u svijetu brzih tehnoloških promjena i gospodarskog razvoja. Takav splet vrijednosti i kompetencija kod pojedinaca potrebno je razviti kroz obrazovni sustav. Matematika, kao nastavni predmet, upravo svojom prirodom i sadržajima povoljna je za postizanje takvih ciljeva. Ipak tradicionalne metode poučavanja matematike fokusirane su na usvajanje proceduralnih znanja, koje samo kod pojedinaca mogu razviti navedene vještine. Ipak uvođenjem novih metoda rada kroz nastavu matematike, tradicionalna nastava se može oplemeniti, te pružiti široj populaciji učenika razvoj potrebnih kompetencija.

Ovaj rad opisuje jednu od suvremenih metoda rada u nastavi matematike, kao i utjecaj koji ta metoda ima na trajnost proceduralnog znanja i razvoj konceptualnog znanja. Istraživanje utjecaja metode otkrivanja algoritma dijeljenja razlomaka na proceduralno i konceptualno znanje o dijeljenju razlomaka, provedeno je na uzorku od 241 učenika šestog razreda osnovne škole, podijeljenih u testnu i kontrolnu skupinu. Rezultati su pokazali pozitivan utjecaj metode otkrivanja algoritma na proceduralno i konceptualno znanje u odnosu na tradicionalnu metodu demonstracije procedure i uvježbavanja.

*Ključne riječi:* algoritam; dijeljenje razlomaka; konceptualno znanje; proceduralno znanje

## Word problems in mathematics teaching

---

---

Edith Debrenti

Teacher Training Institute, Partium Christian University, Oradea, Romania

*Abstract.* General problem-solving skills are of central importance in school mathematics achievement. Word problems play an important role not just in mathematical education, but in general education as well. Word problem solving, as well as comprehension and text interpretation are present among the skills in the mathematical competence model. Word problems also play a crucial role in forming the concept of operations and indirectly in practicing operations. Working with word problems in elementary education creates a base for the ability to model more complex, practical problems. Word problems also help in developing comprehension, judging, memorization and self-check abilities.

In order to efficiently enhance students' problem solving skills they should be assigned world problems which are new to them and to which they themselves have to find the steps to the solution, the algorithm.

A number of researches, experiments and scientific papers in the didactics of mathematics prove that the role of visual representations in word problem solving is essential. Visual representation often helps in understanding a problem. Using visual representations leads to a better understanding and to improving special mathematical reasoning.

In all stages of education we must place great emphasis on word problems, on their correct interpretation, understanding, on observing the steps in problem solving, possible representations, interpreting results in terms of real world situations because word problems play an important role in developing comprehension.

The aim of this research was to measure students' word problem-solving skills, as well as to investigate the way they can actively apply their knowledge when solving problems directly and not directly connected to the curriculum. We have investigated the relationship between different knowledge areas and levels in the case of Primary School and Kindergarten Teacher Training College's students at Partium Christian University Oradea.

*Keywords:* teacher training, word problems, reading, arithmetical problem-solving methods, primary school textbooks

## Introduction

Mathematical competence encompasses the development and use of skills and abilities related to mathematical reasoning. The OECD PISA mentions the following eight components of mathematical competence: (OECD, 1999)

1. reasoning, making deductions
2. argument and elaborating a proof
3. communication
4. modelling
5. finding solutions
6. representation
7. using symbolic, formal and technical language and operations
8. using mathematical tools.

The mathematical competence model based on factor and content analysis contains a detailed list of abilities and skills of mathematical competence (Caroll, 1996; Fabian et al., 2008):

*Table 1.* Mathematical competence model.

Skills	counting, calculation, quantitative reasoning, estimation, measuring, measurement conversion, word problem solving
Reasoning skills	systematization, combinatorial reasoning, deductive and inductive reasoning, calculating probabilities, argumentation
Communication skills	relation terminology, comprehension, text interpretation, spatial visualization, visual-spatial representation, presentation
Acquisition skills	problem receptivity, problem representation, originality, creativity, problem solving, metacognition
Learning skills	concentration, part-whole awareness, memorization, problem solving speed

Word problem solving as well as comprehension and text interpretation are present among the skills in the mathematical competence model. Problem solving is one of the acquisition skills.

Representation and presentation are also components of mathematical competence belonging to acquisition and communication skills respectively.

The *Mathematics Programmes of Study* effective in Romania does not present the objectives for word problem solving for school grades 1 to 8. There are no details concerning the steps or levels attaching them to grades or age groups.

The performance standards for the end of elementary education state as an objective “using arithmetic reasoning in solving word problems” as well as “solving problems that require three operations at most.” (<http://programe.ise.ro>).

As concerns secondary school only the 5<sup>th</sup> grade curriculum contains as an objective “solving word problems with the help of equations and inequalities.” When it comes to higher grades solving word problems is mentioned only in a general context, e.g. “solving practical problems using operations with real numbers.” (<http://programe.ise.ro>).

One can raise the question what about the different types of word problems which cannot be solved with equation, e.g. logical, combinatorial or other specific word problems which need more complex strategies.

Course books or workbooks do not contain any open problems.

## Reading, word problems, representations

According to a present-day definition “word problems are real-life, practical problems in which the correlation between the known and unknown quantities are provided in the form of text, and their solutions need some kind of mathematical model.” (Török , 2013)

Word problems also play a crucial role in forming the concept of operations and indirectly in practicing operations. Working with word problems in elementary education creates a base for the ability to model more complex, practical problems. Word problems also help in developing comprehension, judging, memorization and self-check abilities.

To an efficient development of problem-solving skills it is recommended to use more new word problems to which students have to find the steps leading to the solution, the algorithm.

In all stages of education we must place great emphasis on word problems, on their correct interpretation, understanding, on observing the steps in problem solving, possible representations, interpreting results in terms of real world situations because word problems play an important role in developing comprehension.

How do we solve word problems? There are different models for this. Pólya’s model develops reasoning and divides problem solving into four steps. (Pólya, 2000)

- I. *Understand the problem!*
- II. *Look for connections between data and the unknown! If you cannot find direct connections look for helping problems! Make a plan for solving the problem!*
- III. *Carry out the plan!*
- IV. *Check the solution!*

The first step, understanding the problem, emphasizes the importance of first reading the problem carefully and systematizing the data. The question and the stipulation jointly determine the next step, namely making a plan.

In making the plan students can rely on previously acquired knowledge as well. Pólya elaborates this stage in most details. Students need to find correlation between the data and the unknown. If the student finds the exercise easy, it means that he/she has already solved several problems of this type, thus it will not develop his reasoning but automate his/her knowledge. If the problem is more difficult, it is important that the student does not give up. Every well solved helping problem or similar problem will help. It is important that the student learns how to reason, how to ask questions. They should get acquainted to as many types of problems as possible in the most realistic way possible. These types of problems improve students' initiating abilities, and consequently increase their self-esteem in mathematics.

When carrying out the plan it is important to do operations correctly.

The fourth step is one of the most important ones, checking the solution. If the problem is solved correctly it is enough to check it, if it is not solved correctly, the student will notice what the problem is, what needs to be corrected or thought further.

The methods for solving word problems are: general methods, as well as particular methods such as representation, contrasting, hypotheses, backwards working, rule of three, method of balancing.

Numerous psychological studies prove that the representation of mathematical objects and pictorial representations play an important role in the learning process. Illustrations facilitate a better understanding of concepts or of a problem, they help develop mathematical reasoning.

The essence lies in representing the data of the problem, the unknown and the relations between them, and using the representation to analyze and solve the problem. One can use sketches, plane figures, segments, symbols and conventional signs or letters. Representation is important since it contributes to a better understanding and memorization of the problem. (Olosz & Olosz, 2000; Goldin & Kaput, 1996) analyzed the structure of internal mathematical representations and found that the imagistic system (nonverbal configurations of objects, relations and transformations, including visual imagery and spatial representations) receives much less attention from educators than other systems of mathematical representations. It is clear from Goldin & Kaput's argumentation that the ability to visualize data and their relations in a mathematical problem may contribute to mathematics problem solving.

(Hegarty & Kozhevnikov, 1999) have found that "some visual-spatial representations promote problem-solving success".

Drawings used for solving word problems can be categorized based on (Kozhevnikov et al., 2002) as schematic and pictorial.

Schematic drawings modelling mathematic quantities and relations play an important role in the cognitive processes involved in mathematical problem solving. "Mental representations generated in the process of word problem solving can be introduced as early as elementary education. Students who are made aware



of mental representations built on visual imagery perform better, and change their convictions related to mathematics.” (Csikos et al., 2012)

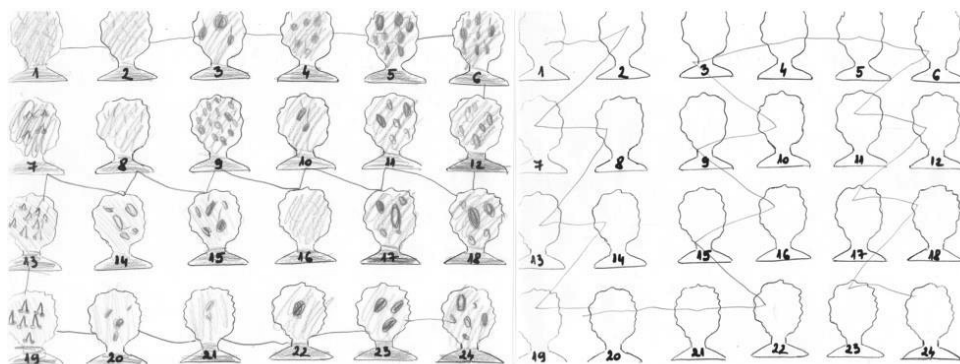

Figure 1. 2nd grade students solve problems with the help of representations (pictorial and schematic drawings).

Students need to be made aware of using visual representations. This should be done through practice, with a lot of patience. Using concrete and iconic representations is necessary not only for the so called slow students or elementary students. These representations are important for all students and are useful throughout the entire learning process. (Wttmann, 1998)

“One mode of representation does not suffice for the conditions and requirements of solving a problem or managing a situation. Most often multiple representation is asked for. A parallel engagement of different modes of representation and the connection between these yields a more efficient activity. Mathematical power lies in the properties separate from representations and the connection between representations”. (Dreyfus & Eisenberg, 1996)

In our teacher training programme we have placed great emphasis on word problems, on their correct interpretation, understanding, on observing the steps in problem solving, possible representations, interpreting results in terms of real world situations, etc. (Pólya, 2000) and we place great emphasis on different methods of solving arithmetic problems, especially on particular methods (such as representation, contrasting, hypotheses, backwards working, rule of three, method of balancing) and drills. Teacher trainees need to be thought to see through a child’s eyes and they need to part with the algebraic methods as they need to adapt to children’s way of thinking, and should not use unknowns represented by letters of the latin alphabet.

First of all they need to be retaught the arithmetical methods and we need to promote these as opposed to algebraic methods.

Practice shows that this is not an easy endeavour. Students favour the algebraic methods, which they are more familiar with, and have a hard time with representations although they need representations for advancing better understanding, and

mathematical reasoning. Most of the word problems in textbooks require representation and an even larger number require a special problem-solving method.

Debrenti (2013) presented a research carried out on teacher training graduates. In this I measured the extent to which future teachers could be sensitized to using representations when solving word problems, thus facilitating a better understanding of the problem.

## **The research**

### **Aim and methodology**

The basis for the research was a mathematical test. Kindergarten and primary school teacher trainees (25 second year students) have been asked to complete a test in mathematics. The problems in the test are appropriate for testing usable knowledge, since they require careful reading and understanding. Using different word problems the aim was to measure the reading and problem solving skills of our students at the start of the methodology of mathematics course.

Another aim was to investigate whether students choose the arithmetic of algebraic method of problem solving, and whether they use representations. We hypothesized that there would be difficulties in understanding the problems and that students would prefer the algebraic method.

We wanted to investigate the connection between different knowledge areas, levels (operations, conceptual understanding, exercise and problem solving), hypothesizing a causal relationship.

The test contains 6 problems, i.e. 6 items in six groups. By means of these problems we investigated students' knowledge of the basic mathematical concepts and their operational background, as well as students' interpretation of word problems and their use of representations, i.e. the application of mathematics in everyday life.

The test is similar to the ones used in schools for assessing content knowledge. Problems are of a basic level (practically part of the 1st-8th grade curriculum), however they test the skills component of knowledge. Apart from six items, the problems do not directly ask for curriculum knowledge. Students need to understand, interpret and make connection between elements in order to solve the problems. These have to be solidly integrated into their knowledge system. The test is primarily suitable for displaying simple, quantitative information and analyzing problems of understanding. In the case of word problems requiring representation it was also an important aspect whether students can solve them using various representations (as expected when they become teachers) or whether they can only apply the algebraic method.

When selecting the problems it was an important aspect that they should not be rich in mathematical content. We have chosen problems which are essential due to their applicability in other subjects or fields.

Students needed to use their knowledge of: the concept of fractions, fraction of a whole number, probability calculation, permutation, measurements, perimeter calculation.

Based on their content the problems can be categorized into six groups. Each group focuses on different problems of understanding; nonetheless each problem requires text interpretation.

Word problem that can be solved using arithmetic method (representation with segments) (1.): These are the most basic readings, operations, without which one cannot make even the simplest calculations. In order to understand word problems and use a correct representation students need to be familiar with some common terms, how much more, how many times more, as well as to understand correlations correctly (somewhat more, less, mathematical operations: addition, subtraction, division, multiplication). Representation can be used.

Word problem (2.): A legs and heads problem (students could use symbolic representation).

Problem solving (3.): This type needs more complex reasoning, combinatorics-counting all possible situations, probability counting, comparing the probability of two cases (which is more probable?)

Operations (4.): In this problem students have to deal with the concept of fractions.

Geometry problem (5.): Students need to be familiar with the concept of the perimeter of a rectangle. Representation can be used.

Logical (probability) problem (6.): students should state the conditions for the certain occurrence of an event

Students were given one hour to complete the test. Answers, i.e., each item was rated on a dichotomous scale (right/wrong). Students scored 1 point for right answers and 0 points for wrong answers.

## The test used for assessment

1. Three crates contain altogether 614 kg of goods. The second crate is twice as heavy as the first one and 4 kg lighter than the third one. How many kg of goods do the crates contain? (Nemes & Nemes, 2006)

*Arithmetic solution:*

First crate is : 1.: I———I

thus, the second is: 2.: I———I———I

while the third: 3. : I———I———I———I 4 kg heavier.

Altogether 614 kg of goods.

$$614 - 4 = 610, \quad 610 : 5 = 122.$$

As a result the first crate weighs 122 kg, the second  $122 \cdot 2 = 244$ , while the third 4 kg more, i.e.  $244 + 4 = 248$  kg.

2. There are altogether 30 poultry and sheep in my grandparents' yard. Knowing that there is a total of 70 legs how many sheep and poultry does my grandmother have? (Nemes & Nemes, 2006)

*Solution:* symbolic representation is required. Each animal has at least two legs, thus a total of  $30 \cdot 2 = 60$  legs. The difference:  $70 - 60 = 10$  sheep legs. Thus, there are  $10 : 2 = 5$  sheep and  $30 - 5 = 25$  poultry.

3. Anna, Béla, Csilla and Dóra are going to the cinema together. In how many different combinations can they seat on four chairs next to each other? Write down the possible seating orders. (Nemes & Nemes, 2006)

*Solution:*  $4 \cdot 3 \cdot 2 \cdot 1 = 24$  possibilities.

4. Five children share four oranges. How much does one child get? (Nemes & Nemes, 2006)

*Solution:*  $\frac{4}{5}$  orange for a child.

5. A rectangle-shaped, 42 cm long and 27 cm wide picture is glued on a cardboard which is 5 cm larger than the picture in all directions. Calculate the perimeter of the picture and that of the cardboard. (Nemes & Nemes, 2006)

*Solution:* the dimensions of the picture  $w = 27$ ,  $l = 42$ , perimeter  $P = 2l + 2w = 2 \cdot 42 + 2 \cdot 27 = 138$  cm.

The dimensions of the cardboard  $w = 27 + 5 = 32$ ,  $l = 42 + 5 = 47$ , perimeter  $P = 2l + 2w = 2 \cdot 47 + 2 \cdot 32 = 158$  cm.

6. There are 10 pieces of socks drying in the yard. We want to pick up a pair of socks in the dark. We know that there are five different pairs of socks. How many pieces do we have to pick up to make sure that we pick up a pair? (Nemes & Nemes, 2006)

*Solution:* we have to pick up at least 6 pieces.

## The results of the survey

The table below contains the test results. The problems were chosen in conformity with the curriculum, they were solvable, thus results can be compared to the highest possible score, the one hundred per cent achievement.

Table 1. Avarage score and dispersion of the test.

Students	Number of students	Avarage score	Dispersion
Total	25	2.48 (41.33%)	1.81

The extreme values are the following: four students (16%) scored zero points (0%), another student (4%) performed much better than the rest, scoring a max-

imum of 6 points, i.e. 100%. Three students (12%) achieved 83.33% on the test. (Considering that the test contained simple problems the results are not satisfying.)

Table 2. Results of the sections and the test (scores and percentage, total).

Sections	Maximum score	Number of right answers	Section results in percentage
1. Word problem requiring arithmetic methods	25	7	28%
2. Word problem	25	6	24%
3. Problem solving	25	11	44%
4. Operations	25	16	64%
5. Geometry problem	25	12	48%
6. Logical problem (probability)	25	10	40%
Test (total)	150	62	41.33%

The first section contained word problems requiring arithmetic method (representation with segments) (1). We wanted to avoid the algebraic solution, since this method cannot be used for the age group they are going to teach (7-11 years, 1st-4th grade)

Students solved problem 1 in the following way:

Table 3. Methods chosen by students for solving problem 1.

Method	Arithmetic	Algebraic	Guessing, trials	Wrong answer
Proportion of students who applied this method	— (0%)	5 students (20%)	2 students (8%)	7 students (28%)

None of the students used the arithmetic method (one of the students used correct representation (correct understanding), however the problem was not solved) 5 students (20%) used the algebraic method, with equations, two students (8%) chose the trial-and-error method.

The second word problem (2.) was a heads and legs problem. One student (4%) made calculations, 5 students (20%) used the trial-and-error method.

In the case of problem solving (3.) where students had to calculate all possibilities 11 students (44%) gave correct answers.

In the case of operations (4.) students had to work with fractions. Dividing 4 oranges to 5 children requires a deeper understanding of fractions. 16 students (64%) provided correct answers, while 9 students (36%) failed in doing this.

The geometry problem (5.) required calculating the perimeter of two rectangles. Prior to this students had to define the size of one of the rectangles. 12 students (48%) provided correct answers, while 13 students (52%) did not.

Logical problems need more complex reasoning. Students had to state the conditions for the certain occurrence of an event. Students face difficulties when it comes to solving logical problems. On average 60% of the students could not solve the problem.

The table below shows the correlations between the subtests. The Pearson's correlation coefficients are very diverse. The highest correlation can be found between solving the logical problems and the geometry problem ( $r = 0.52$ ). There is also a high correlation between operations and knowledge in combinatorics ( $r = 0.49$ ), as well as between operations and solving logical problems ( $r = 0.44$ ). The correlation coefficients between logical problems and combinatorics is  $r = 0.42$ , while the coefficient between solving logical problems and word problems is  $r = 0.40$ .

Table 4. Correlations of the subtests.

Subtest	1. Word problem (1.)	2. Word problem (2.)	3. Problem solving	4. Operations	5. Geometry problem	6. Logical problem
1. Word problem (1.)	1					
2. Word problem (2.)	0.27	1				
3. Problem solving	0.34	0.06	1			
4. Operations	0.28	0.22	0.49	1		
5. Geometry problem	0.11	0.20	0.11	0.05	1	
6. Logical problem	0.40	0.30	0.42	0.44	0.52	1

## Conclusions

On the whole, the test contained easy problems which could be solved using elementary school mathematical knowledge. The results are unsatisfactory.

Analyzing the interrelation between the subtests we find that students achieved differently in each section.

On the whole 41.33% of the students solved the problems correctly. They achieved the best result in operations (64%) and the geometry problem (48%). This is followed by combinatorics (44%) and logical (probability calculation) (40%). Students had the most difficulty with solving word problems (24% and 28% respectively).

None of the students used the arithmetic method to solve the word problem. 20% chose the algebraic method, while 8% of the students used the trial-and-error method. In the case of the second word problem one student (4%) made calculations, while 5 students used the trial-and-error method.

In the case of the combinatorics problem 11 students (44%) provided correct answers, while in the case of operations 16 students (64%) gave correct answers and 9 students (36%) failed to solve the problem correctly.

The geometry problem was solved by 12 students (48%), while 13 students (52%) failed to do so. The logical problem was solved by 40% of the students.

The Pearson's correlation coefficients are very diverse. The highest correlation can be found between solving the logical problems and the geometry problem ( $r = 0.52$ ). There is also a high correlation between operations and knowledge in combinatorics ( $r = 0.49$ ), as well as between operations and solving logical problems ( $r = 0.44$ ). The correlation coefficients between logical problems and combinatorics is  $r = 0.42$ , while the coefficient between solving logical problems and word problems is  $r = 0.40$ . Students need to be familiar with operations. They can become more successful if taught correct text interpretation and different (arithmetic) problem solving methods suitable for children's knowledge and needs. This way their sense of satisfaction would increase and frustration would be reduced.

If we strive for efficiency we need all methods, tools and representations which help teachers in making the mathematics class understandable and accessible for all students. Whether working individually or together students develop their problem solving skills, they become more experienced and more active in the classroom.

## References

- [1] CAROLL, J. B. (1996), *Mathematical abilities: some results from factor analysis*, In R. Sternberg, & T. Ben-Zeev (Eds.), *The Nature of Mathematical Thinking*, (pp. 3–25), Mahwah, NJ: Lawrence Erlbaum Associates Publishers.
- [2] CSÍKOS, Cs., SZITÁNYI, J., & KELEMEN, R. (2012), *The effects of using drawings in developing young children's mathematical word problem solving: A design experiment with third-grade Hungarian students*, *Educational Studies in Mathematics*, 81 (1), 47–65.
- [3] DEBRENTI, E. (2013), *Representations in primary mathematics teaching*, *Acta Didactica Napociensia*, 6 (3), 55–63.
- [4] DREYFUS, T., & EISENBERG, T. (1996), *On different facets of mathematical thinking*, In R. Sternberg, & T. Ben-Zeev (Eds.), *The Nature of Mathematical Thinking* (pp. 253–284), Mahwah, NJ: Lawrence Erlbaum Associates Publishers.
- [5] FÁBIÁN, M., LAJOS, J., OLASZ, T., & VIDÁKOVICH, T. (2008), *Matematikai kompetenciaterület- szakmai koncepció*, [Accessed 07/09/2015] from [www.sulinet.hu/tanar/kompetenciateruletek/2\\_matematika/1\\_koncepcio/matematikai\\_kompetencia](http://www.sulinet.hu/tanar/kompetenciateruletek/2_matematika/1_koncepcio/matematikai_kompetencia).
- [6] GOLDIN, G., & KAPUT, J. (1996), *A joint perspective on the idea of representation in learning and doing mathematics*, In L. Steffe, P. Nesher, P. Cobb, G. Goldin, & B. Greer (Eds.), *Theories of mathematical learning* (pp. 397–430), Hillsdale Erlbaum.

- [7] HEGARTY, M., & KOZHEVNIKOV, M. (1999), *Types of visual-spatial representations and mathematical problem solving*, Journal of Educational Psychology, 91, 684–689.
- [8] KOZHEVNIKOV, M., HEGARTY, M., & MAYER, R. (2002), *Revising the visualizer-verbalizer dimension: Evidence for two types of visualizers*, Cognition and Instruction, 20, 47–77.
- [9] NEMES, E., & NEMES, I. (2006), *Matematika tankönyv a IV. osztály számára*, Sepsiszentgyörgy: T3 Kiadó.
- [10] OLOSZ, F., & OLOSZ, E. (2000), *Matematika és módszertan*, Kolozsvár: Erdélyi Tankönyvtanács.
- [11] PÓLYA, G. (2000), *A gondolkodás iskolája*, Budapest: Akkord kiadó.
- [12] TÖRÖK, T. (2013), *Szöveges feladatok és tanításuk*, In K. Herendiné (Ed.), *A matematika tanítása az alsó osztályokban* (pp. 164–191), Budapest: Nemzedékek Tudása tankönyvkiadó.
- [13] <http://programe.ise.ro>, (n.d.), [Accessed 28 /02/ 2015].
- [14] <http://www.oecd.org/edu/school/programmeforinternationalstudent-assessmentpisa/33693997.pdf>, (n.d.), [Accessed 28 /02/ 2015].
- [15] WITTMANN, E. C. (1998), *Standard Number Representations*, Journal für Didaktik der Mathematik, 19 (2–3), 149–178.

Contact address:

Edith Debrenti  
Teacher Training Institute  
Partium Christian University  
Str. Primariei nr. 36 Oradea, Romania  
e-mail: edit.debrenti@gmail.com



## Szöveges feladatok a matematikatanítás során

---

---

Edith Debrenti

Tanárképző Intézet, Partiumi Keresztény Egyetem, Nagyvárad, Románia

*Kivonat.* Az iskolai matematikatanítás során az általános problémamegoldó képesség fejlesztése az egyik legfontosabb cél. A szöveges feladatok fontos szerepet játszanak nemcsak a matematika tanítása, hanem a teljes képzés során. A matematikai kompetencia modelljében az összetevők között a készségeknél találjuk a szövegesfeladatok megoldását, a szövegértést és a szövegértelmezést is.

A szöveges feladatok a műveletfogalom kialakításában és a műveletvégzés közvetett gyakoroltatásában is meghatározó szerepet töltenek be, ugyanakkor az elemi osztályokban a szöveges feladatok feldolgozásával a bonyolultabb gyakorlati problémák matematikai modellezésének képességét alapozzák meg. A szöveges feladatok segítségével fejleszteni lehet a tanulók szövegértését, ítéelő-, emlékező-, lényegkiemelő és önellenőrző képességét.

A problémamegoldó képesség hatékony fejlesztéséhez hozzájárul minél több olyan szöveges feladat felvetése, amely ismeretlen a feladatmegoldó számára, és amelyhez neki kell megtalálnia a megoldási lépéseket, az algoritmust.

A matematika didaktika számos kutatása, kísérlete, szakcikke bizonyítja, hogy a vizuális reprezentációk szerepe a szöveges feladatok megoldása során nagyon jelentős, egy vizuális reprezentáció gyakran segít egy probléma felfogásában, a jobb megértés és a sajátos matematikai gondolkodásmódok fejlesztése érdekében ábrázolásra, vizuális reprezentációk használatára szükség van.

A teljes tanulmányi folyamat során nagy hangsúlyt fektetünk a szöveges feladatokra, ezek helyes értelmezésére, megértésére, a megoldási lépések betartására, esetleges reprezentációra, az eredménynek a valósággal való egybevetésére, mert a szöveges feladatoknak jelentős szerepe van a szövegértés fejlesztésében.

Kutatásom alapját egy matematikai teszt alkalmazása képezte, amely olyan feladatokat tartalmazott, amelyek helyes szövegértelmezés és megértés esetén oldhatók meg, így alkalmasak a használható tudás vizsgálatára. Tananyaghoz kötődő feladatok megoldására kérve a tanítóképzős hallgatókat, mérni szerettem volna önálló gondolkodásukat, problémamegoldó képességüket, tudásuk aktív alkalmazni tudását. A különböző ismereti területek, szintek közötti összefüggéseket vizsgáltam a Tanárképző Intézet pedagógiai képzésben résztvevő hallgatói esetében.

*Kulcsszavak:* tanítóképzés, szöveges feladatok, szövegértés, aritmetikai módszerek, elemi tankönyvek

# Graphical representations in teaching GCF and LCM

---

---

Karmelita Pjanić and Edin Liđan\*

Faculty of Educational Sciences, University of Bihać, Bosnia and Herzegovina

*Abstract.* The greatest common factor (GCF) and the least common multiple (LCM) of numbers are concepts which have been shown in literature to be calculated by students in rule-based manner. Therefore, students' knowledge is procedural and students usually cannot provide intuitive or logical explanation for procedure. Common method for finding the GCF and the LCM employ factoring. This method is based on symbolical representation of concepts of GCF, LCM and factorization.

In this paper, we describe alternative approach for finding GCF and LCM. This approach is based on graphical representation of concepts of LCF and LCM and includes three models: Venn diagrams, line method and area method for finding GCF and LCM. Taking into account role of visualization, we propose the use of graphical models as teaching tools in order to reinforce students' understanding of GCF and LCM.

*Keywords:* greatest common factor, least common multiple, graphical representation, factorization, teaching tools

## 1. Introduction

School practice shows that many issues in arithmetic and elementary number theory, first of all those related to the structure of natural numbers and the relationship among numbers, are not well grasped by pupils. It is important both for teachers and students to understand how number theory concepts are developed and maintained and how to distinguish between bona fide numerical concepts and the rote manipulation of symbols. Furthermore, teachers have to be aware how these concepts should be developed and interconnected to form solid mathematical knowledge. Unfortunately, many teachers, especially beginners, are concentrated on drill and

---

\*Corresponding author.

practice and providing standard answers to familiar questions instead to uncovering structure of concepts.

The greatest common factor (GCF) and the least common multiple (LCM) of numbers are concepts which have been shown in literature to be calculated by students in rule-based manner (Zaskis, 2000, Kurz, Garcia, 2012, Ibrahimpašić, Pjanić, 2014). Students' knowledge is procedural and students usually cannot provide intuitive or logical explanation for procedure.

## **2. Role of representations in developing procedural and conceptual knowledge**

Types of mathematical knowledge were in focus of many studies during 20<sup>th</sup> century. Bruner (1960) and Gagne (1985) referred to skill learning as opposed to principle learning or understanding. Scheffler (1965) distinguished “knowing how to” and “knowing that” and Piaget (1978) put procedures as opposed to concepts. In that manner the notions of procedural and conceptual knowledge arise. Procedural knowledge in mathematics is composed of two parts: knowledge of the formal language of mathematics (symbols and syntax) and the rules, algorithms, or procedures used to solve mathematical tasks (Hiebert & Lefevre, 1986). Conceptual knowledge is knowledge that is rich in relationships. It can be thought of as a connected web of knowledge, a network in which the links between concepts are as important as the concepts alone. Unfortunately, most school mathematics curricula are overly concerned with developing procedural knowledge, focusing on speed and accuracy in using computational algorithms, rather than the development of higher order thought processes, such as those used in problem solving, deductive reasoning, and logical inference (Post, Cramer, 1989). Procedural and conceptual knowledge are not diametrically opposed and unrelated. There are connections between procedures and concepts, however in school practice often neglected. Teachers should be aware of the importance of the interaction between the two forms of knowledge and the role each can play in the development and maintenance of the other. Both procedural and conceptual quantitative knowledge are vital.

Multiple representations of mathematical concepts have important role in development of both conceptual and procedural mathematical knowledge. Representations can be viewed as the facilitators which enable linkages between the real world and the mathematical world. Formulae, tables, graphs, diagrams, numerals, equations and manipulative materials all are mathematical “objects” – representations, used to represent various real world ideas and relationships. At a more advanced stage these “objects” themselves can be represented by formulae, tables, and so forth. That is, mathematical concepts can be viewed as tools to help with understanding new situations and problems and also as objects that can be investigated in their own right (Post, Cramer, 1989). Translations within and between these representations constitute the essence of mathematical activity.

Visual or graphical representations are a powerful way for students to access abstract math ideas. Drawing a situation, graphing lists of data, placing numbers on a number line, making diagrams all help to make abstract concepts more concrete. Graphical representations include both static and dynamic “pictures”. Choosing the “right” graphical representation often depends on content and context. In some contexts, there are multiple ways to represent the same idea. Students need to view a variety of graphical representations in order to acquire mathematical concept.

### 3. Graphical representations of the greatest common factor and the least common multiple

Many issues related to the structure of natural numbers and the relationships among numbers are not well grasped by pupils. It has been noted that pupils often confuse and interchange terms the greatest common factor (GCF) and the least common multiple (LCM) and often do not grasp the connection between factors and multiples (Zazkis, 2000).

A common method for teaching prime decomposition involves the formation of factor trees (Griffiths, 2010) (see Figure 1a) or factor schema (Ibrahimpaišić, Pjanić, 2014) (see Figure 1b). Factor tree and factor schema help pupils visualize the multiplicative breakdown of a number but do little else in relation to the development of the concept. Kurz and Garcia (2010, 2012) introduced tiles model as alternative way to build concepts of factors and multipliers.

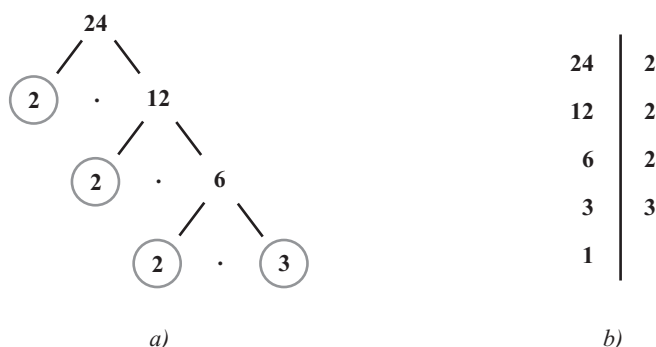

Figure 1. Prime factorization of number 24 a) factor tree, b) factor schema.

Factor schema is commonly used to find out GCF and LCM of two or three numbers. When introducing concepts of GCF and LCM teachers usually state definitions of concepts and demonstrate procedure – factor schema, of finding GCF and LCM. However, factor schema alone, as symbolical representation, could not help students to develop concepts of GCF and LCM. Little is known about the kinds of graphical representations and experimental interfaces that might help pupils learn and understand GCF and LCM.

In order to link procedural and conceptual knowledge teachers could use several modes of graphical representations of concepts of GCF and LCM of two positive integers:

1. Venn diagrams model,
2. Rectangular area model,
3. Line segment model.

### 1. Venn diagram model

Prime factors of two given positive integers  $a$  and  $b$  could be represented as elements of two sets  $A$  and  $B$ . Elements of intersection  $A \cap B$  indicate common prime factors. All common factors of given numbers we can obtain by multiplication of common prime factors. The greatest common factor of given numbers is equal to product of elements of set  $A \cap B$ . On the other hand, since the set  $A$  contains all the factors of  $a$ , every multiple of  $a$  must contain all of these factors. Likewise, since the set  $B$  contains all the factors of  $b$ , every multiple of  $b$  must contain all of these factors. In order to be a multiple of both numbers, a number must contain all the factors of both numbers. The smallest number to do this is equal to product of elements of set  $A \cup B$ . Venn diagram model for (finding out) GCF and LCM of numbers 24 and 32 is and 32 is illustrated in Figure 2.

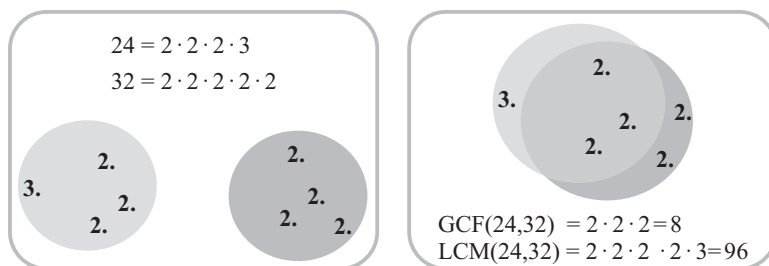

Figure 2. Venn diagram model for GCF and LCM of numbers 24 and 32.

The previous activity can be generalized to three numbers. First, a Venn diagram with three circles is created. In the triple overlapping section, we place prime factors that are common to the three given numbers. This will yield the GCF for all three numbers. If a prime factor is only common to two numbers, we place it in the overlapping section of those two numbers. All of the prime factors are then multiplied to find the LCM.

### 2. Rectangular area model

Let numbers  $a$  and  $b$  be dimensions of a rectangle. Any common factor of numbers  $a$  and  $b$  could be the dimensions of a square that would tile that entire rectangle. To

determine the  $\text{GCF}(a, b) = c$ , we want to find the dimensions of the largest square that could tile the entire rectangle without gaps or overlap. It can be accomplished in manner based on Euclidean algorithm. Resulting square is the greatest common measure of given rectangle and its length  $c$  is the greatest common measure (GCF) of lengths  $a$  and  $b$ .

If  $a < b$ , there is one or more  $a \times a$  squares that fit inside rectangle  $a \times b$  and is flush against side  $a$  of rectangle. If entire rectangle is not tiled with  $a \times a$  squares, rectangle  $r \times a$ ,  $r < a$ , remains. Rectangle  $r \times a$  could be tiled with one or more  $r \times r$  squares completely or leaving remaining rectangle which we tile with smaller squares etc. Let us illustrate rectangular area model to determine  $\text{GCF}(32, 24)$ .

Start with the  $32 \times 24$  rectangle. The largest square tile that fits inside this rectangle and is flush against one side is  $24 \times 24$ . Only one tile of this size will fit. The largest square tile that fits inside the remaining rectangle and is flush against one side is  $8 \times 8$ . Three tiles of this size will fit. The original rectangle is now completely filled (Figure 3).

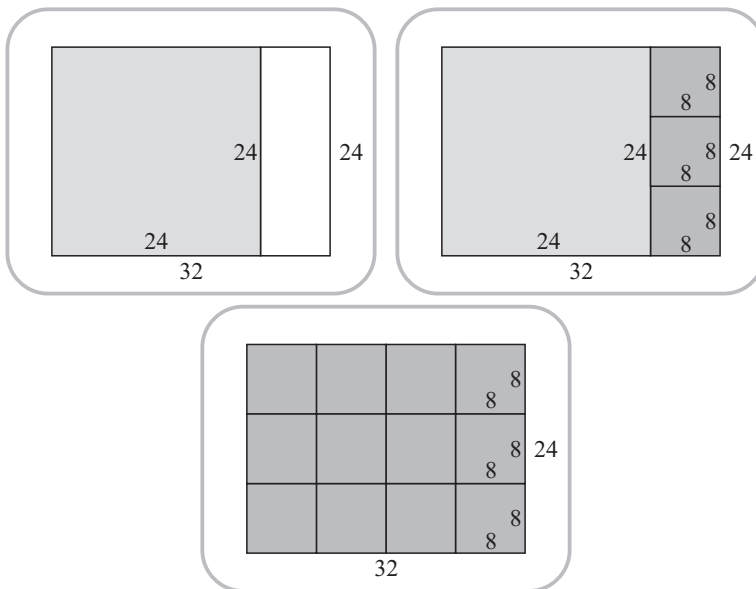

Figure 3. Rectangular area model of  $\text{GCF}(24,32)$ .

Square  $8 \times 8$  is the largest square that tiles rectangle  $32 \times 24$  without gaps and overlapping. There are other, smaller squares that would tile  $32 \times 24$  rectangle, for example  $1 \times 1$  square,  $2 \times 2$  or  $4 \times 4$  square. All those squares are measures of given rectangle, but the  $8 \times 8$  square is the greatest measure. Therefore, number 8 is the greatest common measure (factor) of numbers 32 and 24.

Rectangle area model could be used to represent least common multiple. If we think of  $a$  and  $b$  as the dimensions of a rectangle that could tile a square, then

it follows that any common multiple could be the dimensions of a square that could be tiled by this rectangle. The LCM of  $a$  and  $b$  would be the dimensions of the smallest square that could be tiled by the  $a \times b$  rectangle, i.e. the smallest square that could be measured by  $a \times b$  rectangle. Such square could be obtained in following manner. Start with the  $a \times b$  rectangle with goal to make a square tiled with rectangles of these dimensions. If the width ( $a$ ) is less than the height ( $b$ ), we add column(s) of tiles to make rectangle  $na \times b$ ,  $b \leq na$ . If  $b = na$ , we obtain square that is tiled by the given rectangle. In other case, the width ( $na$ ) is greater than the height ( $b$ ), so we add row(s) of tiles under the existing rectangle to obtain  $na \times mb$ , rectangle. If  $na = mb$ , we obtain square that is tiled by  $a \times b$  rectangle. If  $mb > na$ , we add column(s) to existing rectangle etc. The first square that is obtained in such manner is the smallest square that could be measured by given rectangle  $a \times b$ . Let  $pa \times qb$  ( $pa = qb$ ) is such square. Dimensions  $a$  and  $b$  of rectangle are measures of dimensions of square  $pa \times qb$ , ( $pa = qb$ ). So, the number  $pa = qb$  is the least common multiple of numbers  $a$  and  $b$ .

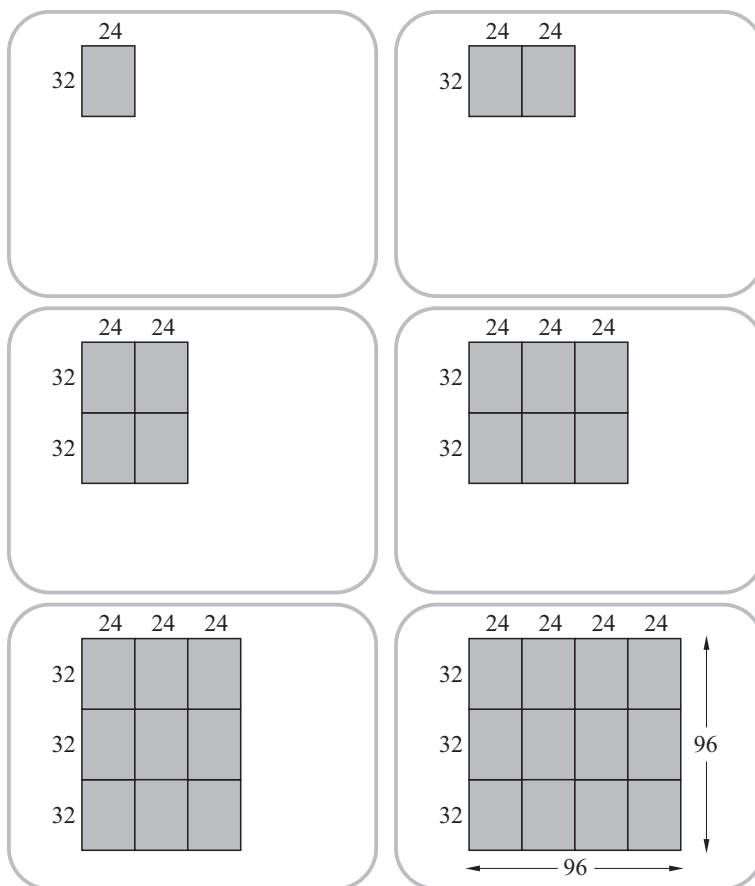

Figure 4. Rectangular model for LCM(24,32).

To find out  $\text{LCM}(32,24)$  we start with the  $24 \times 32$  rectangle. The goal is to make a square tiled with rectangles of these dimensions. Since the width (24) is less than the height (32), we add a column of tiles to the right of the rectangle ( $32 : 24 = 1$ , remainder 8). This makes a  $48 \times 32$  rectangle. The width (48) is now greater than the height (32), so we add a row of tiles under the existing rectangle. This makes a  $48 \times 34$  rectangle. Since the width (48) is less than the height (64), we add a column of tiles to the right of the rectangle. This makes a  $72 \times 64$  rectangle. Finally, by adding one more row and column, we obtain  $96 \times 96$  square that is tiled by  $24 \times 32$  rectangles. So,  $\text{LCM}(32, 24) = 96$ . Process is illustrated in Figure 4.

### 3. Line segment model

Let numbers  $a$  and  $b$  are lengths of two line segments. We are supposed to find out the longest line segment that will measure given line segments. It can be accomplished in manner based on Euclidean algorithm. Let  $a > b$ . We measure line segment of length  $a$  with line segment of length  $b$ . If there is leftover, for example, line segment of length  $d$ , we take this line segment to measure line segment of length  $b$ . If there is no leftover, we conclude that line segment of length  $d$  is the greatest common measure of given line segments. In opposite, we measure line segment of length  $b$  by length  $d$ . We continue process of measuring until there is no leftover. In Figure 5 line segment model for  $\text{GCF}(32, 24)$  is illustrated.



Figure 5. Line segment model for  $\text{GCF}(32, 24)$ .

Line segment of length 32 is measured with line segment of length 24. Line segment of length 24 is contained once in line segment of length 32 and there is leftover of length 8. Now, line segment of length 24 is measured by leftover – line segment of length 8. Line segment of length 8 is contained exactly 3 times in line segment of length 24. As  $32 = 24 + 8$ , it is obvious that line segment of length 8 is contained 4 times in line segment of length 32. So, line segment of length 8 is the greatest common measure of line segments of lengths 32 and 24. We may conclude that  $\text{GCF}(32, 24) = 8$ .

On the other hand, line segment model can be used to find out LCM of two given numbers. It can be done based on same principles included in rectangular



area model. We observe two line segments with lengths  $a$  and  $b$  ( $a > b$ ). The goal is to find out line segment that could be measured with both given line segments. Similarly to rectangular area model, we extend shorter line segment (length  $b$ ) to obtain line segment of length equal or bigger than  $a$ .

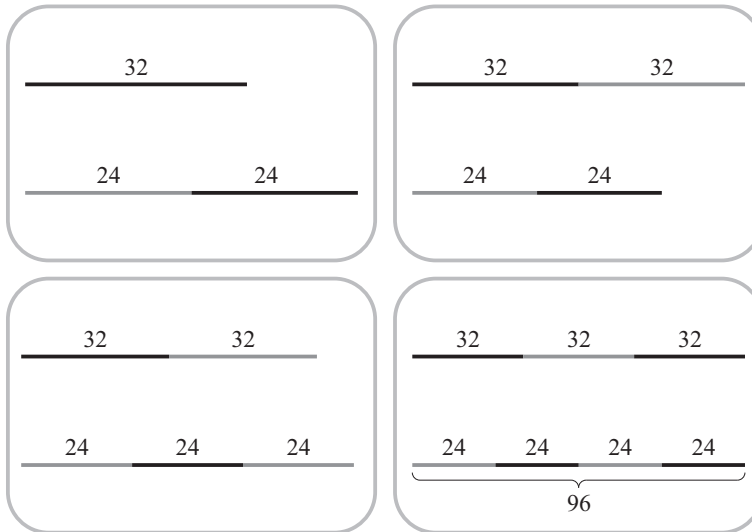

Figure 6. Line segment model for LCM(32, 24).

#### 4. Conclusion

Linking procedural and conceptual mathematical knowledge is an important yet neglected goal of mathematics education, the attainment of which is a complex but achievable enterprise (Kadijevich, Haapasalo, 2001). Three models presented in this paper could be implemented as graphical, but also as visual animated representations, or enactive representations. When possible, teachers should include alternative visual representations and discuss the similarities and differences between the representations. This will help students to move more easily from one representation to an alternative they prefer.

Developing this strategy early will give students tools and ways of thinking that they can use as they advance in their learning of more abstract concepts. Choosing the “right” visual representation often depends on content and context. We suggest that students need to view a variety of graphical (in general, visual) representations if possible. Also, teachers should be able to uncover “hidden” structure of mathematical concept and its representations. Models presented in this paper will be instruments in our further research aimed to detect if teachers recognize those models as useful in school practice.

## References

- [1] BRUNER, J. S. (1960), *The process of education*, New York: Vintage Books.
- [2] GAGNE, R. (1985), *The conditions of learning and theory of instruction*, Holt, Rinehart & Winston, New York.
- [3] GRIFFITHS, M. (2010), *Thematic mathematics: The combinatorics of prime factorization*, *Teaching Mathematics and its Applications*, 29 (1), 25–40.
- [4] HIEBERT, J., LEFEVRE, P. (1986), *Conceptual and procedural knowledge in mathematics: An introductory analysis*, In J. Hiebert (Ed.), *The case of mathematics*, Hillsdale, NJ: Erlbaum.
- [5] IBRAHIMPAŠIĆ, B., PJANIĆ, K. (2014), *Euklidov algoritam za određivanje najvećeg Zajedničkog djelioca*, *MATCOL*, XX (1), Banja Luka, 15–25.
- [6] KADIJEVIĆ, DJ., HAAPASALO, L. (2001), *Linking procedural and conceptual mathematical Knowledge through CAL*, *Journal of Computer Assisted Learning*, 17 (2), 156–165.
- [7] KURZ, T., GARCIA, J. (2010), *Prime decomposition using tools*, *Teaching Children Mathematics*, 17 (4), 256–259.
- [8] KURZ, T., GARCIA, J. (2012), *Moving beyond factor trees*, *Mathematics Teaching in the Middle School*, 18 (1), 52–60.
- [9] PIAGET, J. (1978), *Success and understanding*, Cambridge, MA: Harvard University Press.
- [10] POST, T., CRAMER, K. (1989), *Knowledge, Representation and Quantitative Thinking*, In M. Reynolds (Ed.) *Knowledge Base for the Beginning Teacher – Special publication of the AACTE*, Oxford: Pergamon Press, 221–231.
- [11] ZAZKIS, R. (2000), *Factors, divisors and multiples: Exploring the web of students' connections*, *Research in Collegiate Mathematics Education*, 4, 210–238.

Contact addresses:

Karmelita Pjanić  
Faculty of Educational Sciences  
University of Bihać  
Luke Marjanovića b.b., Bihać  
Bosnia and Herzegovina  
e-mail: kpjanic@gmail.com

Edin Liđan  
Faculty of Educational Sciences  
University of Bihać  
Luke Marjanovića b.b., Bihać  
Bosnia and Herzegovina  
e-mail: lidjan.edin@hotmail.com

## Grafičke reprezentacije pojmova najveći zajednički djelilac i najmanji zajednički višekratnik

---

---

Karmelita Pjanić i Edin Liđan

Pedagoški fakultet Univerziteta u Bihaću, Bosna i Hercegovina

*Sažetak.* Relevantne studije ukazuju na to da se poučavanje učenika o najvećem zajedničkom djeliocu (NZD) i najmanjem zajedničkom višekratniku (NZV) svodi na jednostranu primjenu postupaka njihovog izračunavanja. Prema tome, znanje učenika je proceduralno. Učenici nisu u stanju dati intuitivno ili logičko objašnjenje naučenog postupka. Metoda faktORIZACIJE predstavlja običajenu metodu određivanja NZD i NZV i predstavljena je isključivo u simboličkoj reprezentaciji.

U radu prikazujemo alternativne pristupe u određivanju NZD i NZS. Ističemo tri modela utemeljena na grafičkoj reprezentaciji pojmova NZD i NZV: Vennov dijagram, model duži i model pravougaonika. Uzimajući u obzir važnost vizualizacije, smatramo da ponuđeni modeli, utemeljeni na grafičkoj reprezentaciji pojmova NZD i NZV, mogu pomoći učenicima u formiranju ne samo proceduralnog već i konceptualnog znanja.

*Ključne riječi:* najveći zajednički djelilac, najmanji zajednički sadržalac, grafička reprezentacija, faktORIZACIJA, sredstva poučavanja



## 2.

# The effective integration of information and communication technologies (ICT) into teaching mathematics

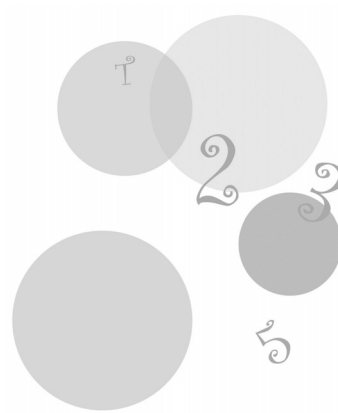



# Mathematics + Computer Science = True

---

---

Anders Hast

Department of Information Technology, Division of Visual Information and Interaction, Uppsala University, Sweden

*Abstract.* Mathematics is a fundamental tool for many sciences. Even so, they are often taught as completely separate topics in higher education. Sometimes math problems are taken from sciences like physics or from real life examples and even if some parts of the mathematics needed is briefly explained when teaching sciences, it is often assumed that the knowledge and understanding of mathematics has already been acquired to a sufficient level before the course starts. However, it is easy to see that a deeper understanding of the mathematics behind the problem in question, also helps in acquiring a better and most of all a deeper understanding of the problem itself. So, the question therefore is how this can be done in computer science in higher education? In other words, how can computer science benefit from including some teaching of mathematics and vice versa? Examples from a mixed course in mathematics and computer graphics will be given and experiences from teaching graphics and mathematics will be discussed. Moreover, experiences from other levels of education will be given and also an overview of how Uppsala University in Sweden supports teachers with a variety of pedagogical and didactic courses as well as other initiatives.

*Keywords:* teaching, mathematics, computer graphics, higher education

## 1. Introduction

Mathematics is a fundamental tool for many sciences. Consequently many scientifically oriented study programs in Sweden start with a rather big blocks of mathematics, followed or interleaved with the major topic in question. Just to take one example, in the bachelor program in computer science at Uppsala University the first year consist of 20 credits of math and 40 credits of computer science. The second year also have 20 credits of math, while the third year contains no math, even if students can opt to take such courses in the part where students can choose freely. In order to take the master program in computer science it is required that the students have taken at least 30 credits of math. Moreover, it is said in the program

syllabus that the expected result of the study (in line with the aims stipulated in the Swedish University Ordinance, which regulates higher education in Sweden) is that the students shall (among other things):

- have detailed knowledge of methods and principles regarding computers as a versatile aid – above all in the fields of mathematics, natural sciences and technology, but also in other subject areas
- be able to use knowledge of mathematics or allied fields of natural science in order to intensify understanding of computer science

Obviously, mathematics is considered being important, even if the above list could be interpreted as mathematics is equal to any other natural science. In practice though, the program contains a considerable amount of mathematics but very little natural science. Nevertheless, math is being taught as a completely separate topic. Here one exception must be mentioned and that is Scientific Computing, which to some extent mixes both the mathematical foundation and computer science. However, not all students study this area and it is likewise required that the students have taken courses in math before studying this topic.

The main question we will look at in this paper is: *Can Mathematics and Computer Science be mixed in a natural way in a single course instead of teaching it as two separate courses?*

## 2. Mixing Mathematics and Computer Science

When teaching mathematics, some problems explained by the teacher, or perhaps more often problems in the text book, might be taken from sciences like physics or from real life examples. Even so, the focus is quite naturally on the math and not the science in question as the problem does not in general require much more knowledge than explained in the problem text. In a similar manner, when teaching sciences, some parts of the mathematics behind the problem might be briefly explained. Nonetheless, it is often assumed that the knowledge and understanding of mathematics has already been acquired to a sufficient level for that particular problem and it is furthermore required that the students have taken some specified mathematics courses before the course starts

Nevertheless, it is easy to see that a deeper understanding of the mathematics behind the problem in question, also helps in acquiring a better and most of all a deeper understanding of the problem itself. One obvious risk is that when the students study computer science, they have already forgotten some of the math required to solve the problem, or at least the calculation skills are at best a bit rusty. One way to solve this problem is to take time to repeat briefly the math required before going deep into the problem. This is something that seems to happen rarely in computer science education. Nevertheless, it is something that probably should happen more often. Another way to solve it, or rather a complement to the above mentioned solution, is to teach both topics in the same course.



This raises the questions: how can this be done in computer science in higher education? In other words, how can computer science benefit from including some teaching of mathematics and vice versa?

### 2.1. Computer graphics, modelling and animation

The *Creative Programming* program was created at the University of Gävle, in Sweden with the goal of combining skills in art and computer science in an innovative way. This program later changed name to *Creative Computer graphics (CCG)* before it was unfortunately closed down for political reasons. A program that combines different topics like art and computer science will face the problem of being divided between two faculties or institutions and there is an obvious risk of ‘falling between chairs’. The game developing program at the University of Gotland faced similar problem when this smaller university collage was merged into Uppsala University. In the end someone had to take the responsibility for it and the easy way out is to denounce responsibility all together. Nonetheless, some important lessons were learned from teaching at CCG and the focus will be on the mix of math and computer science, even if the program had a big portion of art in its curriculum.

The *Computer graphics, modelling and animation* course (15 credits) combined both mathematics, computer science and art. It was described as two courses in one (Ollila, 1999) because of this combination. The idea was that this course would deliver complex mathematical concepts to students that do not have the traditional background in linear algebra, which is the fundamental mathematical concept needed in computer graphics. The lectures and programming oriented practicals were taught by the computer science staff, while the modelling, animation and creative parts were taught by the same staff but also by experts in the industry. Hence, there were no mathematicians involved in the teaching process. It might sound peculiar to a mathematician, that a course having a substantial part of math is not taught by the staff from the math department. However, this was decided with consensus between the staff of both departments. The mathematicians did not simply have the knowledge and skills in computer graphics, while the computer science staff teaching computer graphics had substantial (or at least enough) skills in mathematics. As an example, the author to this paper studied pure mathematics on both bachelor and masters level.

### 2.2. Computer graphics and mathematics

The study program underwent several changes during the years and especially the requirement for the students changed. First there was a clear mix of art students and computer science students and the program had two distinct directions that reflected this mix of two different skills and interests (Zdravkovic et al., 2002). Later on the program required all to focus on computer science and the mathematics part increased to two math oriented courses. This caused a noticeable drop in the number of students as art oriented students did not want to study two full courses of mathematics. Therefore it was decided to try the opposite, and math was

incorporated into the computer graphics course, which changed name to *Computer Graphics and Mathematics*.

The idea was that computer graphics concepts were to be introduced by explaining the math behind each concept. This was done in two steps: first one teacher from the computer science department explained the mathematics in one or two lectures. This could of course been handled by someone from the mathematics department. Basic concepts in linear algebra was covered such as vectors, matrices and basic operations on these. Secondly, another teacher from the same department introduced new computer graphics concepts that are all based on linear algebra. It was shown how the math introduced in the previous lectures is applied in computer graphics. Especially transformations are necessary for animation and it all boils down to simple matrix multiplication of  $4 \times 4$  matrices using homogenous coordinates (Angel, 2009).

Of course one could question the fact that one teacher introduced the math while another showed how it could be applied for computer graphics, but it was simply a matter of convenience as the first teacher was more directed to image processing than computer graphics. In any case, the conclusion we drew during the years that the course was held was that students would more easily accept the mathematics part when it was tough together with computer graphics. This student group was much more inclined towards art than science and therefore it would have been really hard to teach them math as a separate topic.

At the university, mathematics as such was generally taught using two basic principles. The bachelor students in mathematics were trained to follow proofs, while the engineering students were trained to use equations as a tool, without really having to know the origin of the equations. Our approach in the mixed courses was to show the origin of the equations and hence giving the proof in a more informal way. As an example one can easily show why the rotation matrix contains sine and cosine by drawing a simple figure showing how rotation works, as in figure 4.35 in the textbook of Angel (Angel, 2009). One could also take this one step further when explaining bump mapping and explain why an orthogonal frame actually is a rotation (Hast, 2007). The idea is that by showing that the equations they use actually have a geometric meaning, the students would more easily accept the concept. It was noticed during the lectures that students adopted this thinking and asked questions showing that they actually understood this otherwise rather complex concept.

Likewise, homogenous coordinates can be hard to understand and not that easy to accept as a tool. However, by showing that translation becomes multiplication instead of addition, when using homogenous coordinates, the students could also more easily adopt this technique.

### 2.3. Differential geometry

A third example is from differential geometry, which is a pure mathematics course. However, it turns out to have many interesting applications in the field of computer graphics. Operations like bump mapping (Angel, 2009) are computed on the surface of objects and that is what differential geometry is all about. Especially,

frames, normals, tangents and bi-tangents are important concepts used in both disciplines. There was no intended mix between the topics, but the teacher allowed the students to come up with projects as part of the examination of the course. The author, who took the course, chose to apply it in computer graphics and it turned out to work very well. Many insights were obtained during the course, for instance the aforementioned relationship between rotations and frames (Hast, 2007). These insights from the course were used when later teaching graphics.

#### 2.4. One example of teaching mathematics at high school level

Sometimes, the resistance to learn anything related to math can be overwhelming. The author had the opportunity to be a substitute for another teacher in a math class at high school. The pupils enrolled in the building construction program made it very clear that math was something they would never use in their work. Therefore, the approach was changed accordingly and instead of teaching them what an equation was, which was the actual topic in question, a simple example was chosen, namely: how to calculate the mean consumption of gasoline for a specific car. As all of them were young boys this all went very well until they finally realised that the teacher actually was trying to teach them some math. They simply refused to learn the simple equation when it was presented.

What went wrong? They all wanted to know how to compute the mean consumption, but they were not interested in the math. However, one can obviously not separate these two things. It seems like the resistance to mathematics as such was already there since many years. Probably they also took the chance to have an 'easy time' when the ordinary teacher was on leave. It can be added that only one out of 25 had pen and paper to take notes during the lesson. Perhaps, and this is a big 'maybe', it would have helped if math was incorporated in a natural way in other subjects in school. Nevertheless, it could also be noted that when teaching computer science at high school, it was no big deal to introduce mathematical problems in programming exercises. Instead it was something the pupils enjoyed for most of the time. In any case, it leads to the question whether math could successfully be taught in other topics without being presented as 'mathematics'?

### 3. The power of mathematics

The student group in the CCG program consisted foremost of students with a strong creative interest, with an apparent direction towards art. It might seem like a long step from art to mathematics, but it is interesting to note how Romeike (Romeike, 2008) argues that there are three main drivers for creativity in computer science education: 1) the person with his motivation and interest, 2) the IT environment, 3) and the subject of software design itself. For the students in the program, number 2 would perhaps better be defined as the tools they were using like Maya (Maya, 2015) or similar, and number 3 as modelling and animation, rather than software design. Nevertheless, one could add, and this goes for most directions of computer science, that the ability to master something well is a fourth driver. When students are good at programming, modelling, animation or whatever they are doing, they

usually want to make it known to their teachers and fellow students that they are good at it and that itself incites them to become even better. This is often expressed in the way that they add more interesting features to their creation so that their wish to show off feeds creativity. In a similar manner, being good at math, helps the students to do complicated stuff, whether it is a special effect or some other type of computation. Nothing boosts the self esteem as much as being able to do something that the fellow students cannot do, at least not yet. Therefore, mathematics itself can be a powerful booster of the ego, but it can also be discouraging for those who do not understand it or have difficulties mastering it. Therefore, it is very important to help all students to reach both the necessary level of understanding, but also being able to use mathematics as a tool.

#### 4. What about the teachers?

So far we have discussed that mixing mathematics and computer science, especially in the field of computer graphics has proven to be a good idea. Being able to understand mathematics is very important for the students. However, it is up to the teachers, perhaps together with the directors of study to carefully consider pros and cons when changing courses in a study program. What works for one group of students might not work at all for another group. In any case, the teachers also need training and the possibility to exchange experiences with colleagues. Uppsala University has realised this, both on university level as well as faculty level and therefore provides training for teachers in form of regular courses from a day up to two weeks as well as shorter workshops and seminars. These courses aim at developing teaching skills as well as making the teacher reflect on his and her own teaching. Shall lectures always be given in front of a class? Can later year students be involved in the teaching as resources? How can students be helped to make better written and oral presentations? These questions reflect just a few of the topics covered in these courses.

##### 4.1. The DiaNa training initiative

DiaNa is short for *Dialogue for Scientists and Engineers* (DiaNa, 2014) and the purpose of DiaNa is to give students the tools they need to use in their careers, in both academia, industry or government. A key factor for successful work is to be able to communicate with many different target groups and get the message across. Three courses are given, namely *Group Interaction*, *Oral Presentations* and *Written presentations*. In order to help the teachers to act as supervisors in their courses and to be able to give their students training in the three above mentioned fields, DiaNa also offers training for teachers. Teachers sometimes feel that they are not competent enough within the field of communication to be able to give good feedback to the students. However, this is generally not true as teachers are experts compared to the students. In order to be able to give the best feedback to the students the supervisors need to know both their science and the basics of communication, and these courses provide the latter.

#### 4.2. Quality enhancement and academic teaching and learning

Uppsala University also have a unit for quality enhancement and academic teaching and learning (KUUP, 2014), which has multiple purposes among others are ‘to support the quality work pursued in University operations and to contribute to the coordination and showcasing of various initiatives’. Another important task is ‘to promote gender- and diversity-aware teaching, teaching for sustainable development and the use of IT as a tool in teaching and educational development efforts’. The unit also aim ‘to monitor and highlight national and international developments and research in the fields of quality development and academic teaching and learning and to initiate activities prompted by them’. And they also offer a number of courses for teachers as one of their mission is ‘to promote educational development within the University by providing teacher training courses and other services.’

All these initiatives (and more) are part of the quality work being carried out at Uppsala university and the courses are generally free of charge (as they also are in the aforementioned DiaNa project).

#### 4.3. Other initiatives

There are also a substantial amount of money reserved for pedagogical projects, and new teaching ideas are encouraged. However, to the best of the knowledge of the author no project so far has been aimed at interdisciplinary teaching, where mathematics is one part.

Another initiative taken in some universities in Sweden is to promote teacher to become an *Excellent Teacher*. This nomination corresponds to habilitation in science and is intended to encourage teachers to reflect on their teaching and even do research on education within their fields. Obviously, there are challenges ahead as new technology changes the way students study (Faria et al., 2013, Mueller and Oppenheimer, 2014). In Sweden and elsewhere it can be noticed that students use computers much more and also tend to study at home rather than participating in lectures. Perhaps we as teachers need to consider these changes, sooner rather than later, and act thereafter.

### 5. Conclusion

The main question considered was: *Can Mathematics and Computer Science be mixed in a natural way in a single course instead of teaching it as two separate courses?* An example from a course was given that showed that this can actually be done. The example in question was a computer graphics course, which is a suitable topic as it is based on math and uses math as its fundamental tool to solve complicated problems and thus making them easy to handle. It is the strong belief of the author that computer science can benefit from including some teaching of mathematics and vice versa. However, the first has rarely been investigated in higher education in Sweden, while the latter has been used in practice many times as digital tools are being used in teaching mathematics.

Moreover, Uppsala University promote the pedagogical development of their staff, offering number of courses with different aims. The university has also taken the initiative, together with some other universities, to offer a career path for teachers that want to become better and that reflect on their teaching methods and approaches.

It is also possible to start new pedagogical projects, but the question is whether the university is ready for integrating topics that are being taught by different institutions.

## References

- [1] ANGEL, E. (2009), *Interactive Computer Graphics*, Geometric Object and Transformations, Bump Mapping, (pp. 159–220, 494–498), Pearson International Edition.
- [2] DiaNa, *Dialogue for Scientists and Engineers* (2014), <http://www2.ibg.uu.se/diana/?languageId=1> [Accessed 16/04/2015].
- [3] SANA, F., WESTON, T., CEPEDA, N. J. (2013), *Laptop multitasking hinders classroom learning for both users and nearby peers*, *Computers & Education*, Volume 62, March (pp. 24–31).
- [4] HAST, A., (2007), *Understanding Rotations and their Applications*, Proceedings of the 5:th Conference ‘Geometry and Graphics’, Silesian technical University in Gliwice, Ustron, Poland. (pp. 1–2).
- [5] Maya, *Comprehensive 3D animation software* (2015), <http://www.autodesk.com/products/maya/overview> [Accessed 16/04/2015].
- [6] MUELLER, P. A. AND OPPENHEIMER, D. M. (2014), *The Pen Is Mightier Than the Keyboard: Advantages of Longhand Over Laptop Note Taking*, *Psychological Science*.
- [7] OLLILA, M. (1999), *Combining Art and Mathematics in Computer Graphics Education*, EUROGRAPHICS Workshop: Computer Graphics and Visualisation Education – Charting the Future for Computer Graphics Education, July 3–5, Coimbra, Portugal, (pp. 105–110).
- [8] KUUP, *Quality Enhancement and Academic Teaching and Learning* (2014). <https://mp.uu.se/en/web/info/vart-uu/ledning-och-organisation/uf/planering/kvalped> [Accessed 16/04/2015].
- [9] ROMEIKE, R. (2008), *Towards Students’ Motivation and Interest: Teaching Tips for Applying Creativity*, Proceedings of the 8th International Conference on Computing Education Research (pp. 113–114).
- [10] ZDRAVKOVIC, V., CARLING, E., SEIPEL, S., HAST, A. (2002), *Swedish Universities Prepare Students for Entry Into Industry*, *Computer Graphics*, newsletter of ACM SIGGRAPH, Vol. 36, No. 2, (pp. 27–32).

Contact address:

Anders Hast  
 Department of Information Technology  
 Division of Visual Information and Interaction  
 Uppsala University  
 Läagerhyddsvägen 2, 751 05 Uppsala, Sweden  
 e-mail: anders.hast@it.uu.se

## Matematik + Datavetenskap = Sant

---

---

Anders Hast

Department of Information Technology, Division of Visual Information and Interaction,  
Uppsala University, Sweden

*Abstrakt.* Matematik är ett grundläggande verktyg i många vetenskaper, men lärs ofta ut som helt skilda ämnen i den högre utbildningen. Ibland användes matematikproblem tagna från Fysik och andra ämnen eller från vardagsexempel. Även om matematiken som behövs förklaras kort, så antas det att matematikkunskapen redan inhämtats i tidigare kurser. Det är lätt att inse att en djupare förståelse av matematiken bakom problemet i fråga också hjälper att bättre förså problemet självt. Så frågan är hur detta kan åstadkommas i högre utbildning? Med andra ord, hur kan undervisning i datavetenskap ha nytta av att inkludera undervisning i matematik och vice versa? Exempel från en kurs där dessa ämnen blandas diskuteras och det ges exempel på erfarenheter från undervisning på olika nivå. Dessutom beskrivs några av de insatser som Uppsala Universitet gör för att stödja lärare pedagogiskt och didaktiskt.”

*Nyckelord:* Undervisning, Matematik, Datorgrafik, Högre utbildning

# Discovering patterns of student behaviour in e-learning environment

---

---

Marijana Zekić-Sušac<sup>1</sup> and Ivana Đurđević Babić\*<sup>2</sup>

<sup>1</sup>Faculty of Economics, Josip Juraj Strossmayer University of Osijek, Croatia

<sup>2</sup>Faculty of Education, Josip Juraj Strossmayer University of Osijek, Croatia

*Abstract.* The benefits of e-learning have been widely recognized in today's education. However, behaviour of students attending a course through an e-learning platform and its connection to students' satisfaction with a course is still not investigated enough. This paper analyses a course log data in e-learning environment in addition to some students' descriptive variables at University of Osijek, and aims to discover patterns in students' behaviour that could enable to create profiles of satisfied and unsatisfied students. The final purpose is to reveal knowledge about student behaviour that will assist academic teachers in increasing the level of their students' satisfaction. The methodology used in the research includes several data mining methods, such as statistical tests of dependence, and support vector machines. The results show that satisfied students put more effort in frequent viewing of all course materials, they are more active in uploading assignments, and have more previously earned ECTS points than unsatisfied students. The extracted characteristics could be used to improve student satisfaction with the course by stimulating those activities. In order to generalize results, the research is to be extended to include more e-courses on different levels of academic education.

*Keywords:* student behaviour, e-learning, data mining, classification trees, support vector machines

## 1. Introduction

E-learning environment has recently been widely used as a technological improvement of the educational process, and its positive effect has been confirmed in many papers (Romero et al., 2008). However, the behaviour of students in such environment is not investigated enough, especially in relation to their satisfaction with the course. Usually, academic educational institutions try to assess the quality of

---

\*Corresponding author.



course by gathering information about course satisfaction through students' evaluation questionnaires. However, such questionnaires are usually conducted at the end of the course, meaning that their results could be used to improve the course for the future generations of students. The problem of student satisfaction was mostly observed from a customer-orientated perspective where students are identified as customers of academic institutions who are mainly concerned with students' satisfaction with the support service, tuition and accommodation, or environmental factors. This paper is an extension of previous research of Đurđević Babić (2015) who modelled students satisfaction in e-learning environment by using data about their behaviour during a course from log files of the used e-learning system. Her results showed that it is possible to create a successful classification model of students' satisfaction with a course based on data mining methods, such as artificial neural networks and classification trees, and identified some key predictors of students' satisfaction. However the methods used in the previous research do not answer the core questions, such as "What is the profile of our unsatisfied students and satisfied students?".

In this paper, the authors aim to extend the previous research by identifying a profile of unsatisfied and profile of satisfied students based on their descriptive data and log data. The final purpose is to reveal knowledge about students' characteristics and behaviour that will assist academic teachers in increasing the level of their students' satisfaction. The methodology used in the research includes data mining methods, such as statistical tests of dependence, and two machine learning methods: support vector machines and decision trees. We believe that identified profiles could assist teachers to recognize unsatisfied students even during the course, and to react promptly by creating a stimulating environment that will enhance student satisfaction with a course and a positive overall course experience. First, the statistical tests of dependence will be used to examine the relationship among students' characteristics with their level of satisfaction. Next, the support vector machine method will be used to create a model of students' satisfaction with the course, and finally, the decision rules will be used to extract the knowledge of students' profile regarding course satisfaction.

The paper is structured as follows: section 2 provides an overview of previous research, section 3 describes the sample used in this research and methodology of statistical tests, and two machine learning methods: support vector machines and decision trees. Then the results of the statistical tests and machine learning are presented followed by description of students' profiles. Discussion and conclusion describe some expressions on obtained results and guidelines for further research.

## **2. Literature review**

There is a large number of papers published on the subject of student satisfaction with a course, but not many of them were focused on the relationship between e-learning process and student behaviour during the e-learning course. Yunus et al. (2010) investigated the relationship between lecturers' motivation, empowerment

and service quality with students' level of satisfaction in Malaysian polytechnics. In their research, Pearson's correlation and linear regression analysis were used. Their results showed that motivation, empowerment and quality of service help to achieve satisfaction of the polytechnic students in the amount of 37.2%. Wei and Ramalu (2011) explored the relationship between service quality and the level of student's satisfaction in five different areas (the academic department, the university sport center, the university residential hall, the university transportation services and the university internet services). They applied SERVQUAL as service quality measure with five of its own dimensions (tangible, reliability, responsiveness, assurance and empathy) and concluded that these dimensions are connected with students' satisfaction. Research carried out by Hanaysha et al. (2011) also found significant correlation among the five dimensions of service quality (tangibility, reliability, responsiveness, assurance, and empathy) and student satisfaction. These findings were to certain extent affirmed in the research conducted by Negricea et al. (2014). They used different model with three variables (the tangible elements of the university, the compliance with university's values and the reliability which it transmits to the exterior) and concluded that these three variables have a significant impact on student satisfaction (Negricea et al., 2014).

Some papers were more oriented towards analyzing characteristics of students in the e-learning process. In his research, Hong (2002) was focused on Web-based course and tried to explore the effect of student descriptive and instructional variables on their satisfaction and achievement, as well as the relationship between student descriptive and instructional variables and student satisfaction with learning from the Web-based course. Interviews, questionnaires and the Faculty academic records were used for data collecting. By using classic statistical tests, the author deduced that most of the variables, such as student gender, age, learning styles (concrete, abstract), time spent on the course, perceptions of student-student interactions, course activities, and asynchronous Web-based conferences were not related to satisfaction. However, experienced computer users were detected as more satisfied with the course than the others were. Inspired by the Hong's research, in this paper we tried to analyze similar variables on e-learning course at a Croatian university, but to use more advanced methodology in order to find the relationship among student descriptive variables and its behavior in an e-learning environment with the level of satisfaction with a course.

The machine learning methods were used in the paper of Romero et al. (2008) who tested association rules and decision trees in order to classify students according to their success of passing the exam (fail, pass, good and excellent). The rules extracted from decision tree in their case study showed that students with a low number of passed quizzes were instantly classified as the ones that fail the exam while students with a high number of passed quizzes were directed to category with the excellent students. The rest of the students were classified as fail, pass or good based on the amount and scores in other variables. The authors revealed a large number of association rules in this study and realized that some of them (such as rules that show conforming or unexpected relationships) can be interesting from educational point of view in detecting students with learning issues. Pavleković et

al. (2009) extracted important features of children's mathematical gift by using neural networks and logistic regression methodology, and showed that machine learning methods could be efficiently used in classification type of problems in education.

It can be concluded that student satisfaction with courses was a subject of previous research, but more from the service quality perspective. When student descriptive variables and their activity were used, standard statistical methodology was applied. In this paper we try machine learning methods to investigate some hidden relationships between student behavior in e-learning environment and their satisfaction with a course.

### **3. Sample and methodology**

#### **3.1. Description of sample**

The study is based on a survey conducted at the Faculty of Education (University of Josip Juraj Strossmayer in Osijek, 2015) in the academic year 2013/2014. In this paper we used the sample of 132 students who used Moodle e-learning system as a support in the learning process within a course. The data about student activity in the e-learning system were used in addition to nine statements of students expressing their satisfaction with the course. The satisfaction is measured by student agreement with given statements on a 5-point Likert scale. For the purpose of this research the Internal students survey of the Faculty of Education in Osijek with nine statements was used. Scores obtained for each statement were summed and the higher final score indicated the higher level of students' course satisfaction. The final scores were divided into two categories: students with higher level of course satisfaction with final score higher than or equal to 41 (category labeled as 1) and students with lower level of course satisfaction with final score lower than 41 (category labeled as 0). Student course satisfaction was used as the dependent variable for the modelling purposes.

The list of variables used as predictors of student satisfaction and their descriptive statistics is given in Table 1. The frequencies were presented for categorical variables, while the mean and standard deviation are shown for continuous variables.

In order to properly train and test machine learning methods, the sample was divided into two subsamples: training sample (70% of the cases) and test sample (30% of the cases). Support vector machines and decision trees were trained on the train subsample and tested on the test sample in order to enable the comparison of their results.

Table 1. Variables and their descriptive statistics.

Name	Type	Explanation	Descriptive statistics
Gender	dichotomous	1-female; 2-male	1 = 96.97%, 2 = 3.03%
Financing	dichotomous	the basis of the study financing: 1-success (EU); 2-personal needs	1 = 78.79%, 2 = 21.21%
County	nominal	county where student attended high school: 1 – Bjelovar-Bilogora; 2 – Virovitica-Podravina; 3 – Osijek-Baranja; 4 – Požega-Slavonia; 5 – Vukovar-Srijem; 6 – Koprivnica-Križevci; 7 – Brod-Posavina; 8 – Zagreb County; 9 – Sisak-Moslavina; 10 – Međimurje	1 = 2.27%, 2 = 8.33%, 3 = 31.06%, 4 = 5.30%, 5 = 22.73%, 6 = 0.76%, 7 = 25.76%, 8 = 1.52%, 9 = 1.92%, 10 = 0.76%
Assignment upload	continuous	the total number of uploaded assignments	Mean = 3.70, stdev = 2.76
Assignment view	continuous	the total number of viewed assignments	Mean = 21.95, stdev = 20.00
Course view	continuous	the total number of viewed course	Mean = 55.83, stdev = 30.50
View discussion	continuous	the total number of viewed discussions	Mean = 5.79, stdev = 5.31
View forum	continuous	the total number of viewed forum	Mean = 9.92, stdev = 9.63
Page view	continuous	the total number of viewed page	Mean = 0.27, stdev = 0.58
Questionnaire submit	continuous	the total number of submitted questionnaires	Mean = 0.47, stdev = 0.67
Questionnaire view	continuous	the total number of viewed questionnaires	Mean = 1.05, stdev = 1.47
Resource view	continuous	the total number of viewed resources	Mean = 23.03, stdev = 11.27
Url view	continuous	the total number of viewed urls	Mean = 0.20, stdev = 0.64
View all	continuous	the total number of viewed all participants in course	Mean = 0.64, stdev = 4.04
User view	continuous	the total number of viewed individual profiles	Mean = 0.20, stdev = 0.62
ECTS	continuous	the total number of collected European Credit Transfer System points in the academic year	Mean = 60.48, stdev = 3.98
GPA	continuous	grade point average	Mean = 4.29, stdev = 0.31
Course satisfaction	binary	0- lower level of course satisfaction; 1-higher level of students satisfaction	0 = 50%, 1 = 50%

### 3.2. Support vector machines and decision tree methodology

Support vector machine (SVM) is a machine learning methods that could be used both for classification and regression types of problems. It is based on non-linear mapping of the input vectors into a high-dimensional feature space by using the maximum margin hyperplane (Yu et al., 2003). The result of this method are so-called optimal separating hyperplanes that produce a global optimum. The benefits

of SVM are in high generalization performance, and lack of possibility to find a local optima (Behzad et al., 2009). Suppose we are given a set of training data  $x_i \in \mathbf{R}^n$  with the desired output  $y_i \in \{+1, -1\}$  corresponding with the two classes, and assume there is a separating hyperplane with the target function  $w \cdot x_i + b = 0$ , where  $w$  is the weight vector, and  $b$  is a bias. The aim of the SVM method is to select  $w$  and  $b$  to maximize the margin or distance between the parallel hyperplanes that are as far apart as possible while still separating the data. There are two basic types of SVM. In type 1, the following error function is minimized (StatSoft, 2015):

$$\frac{1}{2}w^T w + C \sum_{i=1}^N \xi_i \quad (1)$$

subject to the constraints:

$$y_i (w^T \phi(x_i) + b) \geq 1 - \xi_i \text{ and } \xi_i \geq 0, i = 1, \dots, N \quad (2)$$

where  $C$  is the capacity constant (determined in advance),  $w$  is the weight vector (or vector of coefficients),  $b$  is a constant, and  $\xi_i$  are the parameters for handling nonseparable inputs.  $N$  is the number of cases in the training sample. The kernel function  $\phi$  is used to transform data from the input to the feature space. The constant  $C$  effects error penalization, therefore should be chosen carefully. In this paper we also use the type 2 SVM, which uses different error function to minimize (StatSoft, 2015):

$$\frac{1}{2}w^T w - \nu\rho + \frac{1}{N} \sum_{i=1}^N \xi_i \quad (3)$$

subject to the constraints:

$$y_i (w^T \phi(x_i) + b) \geq \rho - \xi_i, \xi_i \geq 0, i = 1, \dots, N \text{ and } \rho \geq 0, \quad (4)$$

where  $\nu$  is the “nu” constant that is also determined in advance, and affects the learning process and  $\rho$  is the optimization variable.

The kernel function in SVM method can be (Hsu et al., 2003):

linear

$$K(x_i, x_j) = x_i^T \cdot x_j, \quad (5)$$

sigmoid

$$K(x_i, x_j) = \tanh(\gamma x_i^T \cdot x_j + r), \gamma > 0, \gamma, r \text{ are parameters}, \quad (6)$$

radial basis function (RBF)

$$K(x_i, x_j) = \exp\left(-\gamma \|x_i - x_j\|^2\right), \gamma > 0, \quad (7)$$

or polynomial

$$K(x_i, x_j) = (\gamma x_i^T \cdot x_j + r)^d \quad (8)$$

where  $d$  is degree. SVM learns faster than some other machine learning methods (such as neural networks), and is able to select a small and most proper subset of data pairs (support vectors). Since its performance depends mostly on the choice of kernel function and hyper parameters, a cross-validation procedure is suggested as a successful tool for adjusting those parameters (Behzad et al., 2009).

In our experiments, we use three non-linear kernels in SVM: polynomial, RBF, and exponential. The values of parameters used in the SVM models such as gamma coefficient, degree, and  $C$  were reported in the Results section.

Decision tree i.e. classification tree is a method aimed for classification and regression, which builds a binary tree by splitting the input vectors at each node according to a function of a single input. The most common algorithm used in this method is Classification and Regression Tree (CART) which considers all possible splits in order to find the best one by a measure called the Gini index. CART algorithm is performed in the following steps (Questier, 2005): (1) assign all objects to root node, (2) split each input variable at all possible split points, (3) for each split point, split the parent node into two child nodes by separating the objects with values lower and higher than the split point for the considered input variable, (4) select the variable and split point with the highest reduction of impurity, (5) perform the split of the parent node into the two child nodes according to the selected split point, (6) repeat steps 2–5, using each node as a new parent node, until the tree has maximum size, and (7) prune the tree back using cross-validation to select the right-sized tree. One of the evaluation functions most commonly used for splitting the decision tree is the Gini index according to (Apte, 1997):

$$Gini(t) = 1 - \sum_i p_i^2 \quad (9)$$

where  $t$  is a current node and  $p_i$  is the probability of class  $i$  in  $t$ . In our experiments, the CART algorithm was used in the decision tree with the Gini index for splitting.

### 3.3. Modelling procedure

In order to obtain the profiles of students according to their level of satisfaction with the course, the following procedure was suggested:

- (1) Identifying obvious (linear) relationships – statistical tests of linear relationship (a) among input variables, and (b) between the output (satisfaction) and input variables (t-test, chi-square test).
- (2) Identifying non-linear relationships (non-linear modelling) – using available input predictors to create a classification model of student satisfaction with the course (machine learning methods: support vector machines and classification trees).
- (3) Identifying student profiles according to their satisfaction with the course.

In step (1) the linear relationship among input variables is examined in order to see if there are input variables with a high linear intercorrelation, which could

be an argument for variable reduction. Variable reduction is useful in case when the dimension of input space is very high, and improves the model efficiency. The analysis of the dependence of the output variable (satisfaction) with each input variable is useful for justifying the necessity of further steps of non-linear modelling. In case of high linear relationships among the input and output variables, linear modelling is preferred instead of non-linear. Step (2) should be conducted if the linear relationships among the output and input variables are not very high in general. In step (2) we use support vector machines and decision trees for modelling purposes, but in general, any nonlinear method of machine learning could be used instead. After non-linear modelling, if the model performs well (i.e. produces an acceptable error) on the test sample, the step (3) should be conducted to extract profiles of satisfied and unsatisfied students from input data.

The above three steps were conducted on the observed data sample, and the results are described in the following section.

## 4. Results

The results of each of the conducted step in the suggested modelling procedure are described separately, although they were interconnected in a way that the results in each step were used as the input information for the next step.

### 4.1. Identifying obvious (linear) relationships

The choice of statistical tests for identifying linear relationship between variables was made upon the type of the variables in a specific analysis. In step (1a) of the modelling procedure, the Pearson correlation coefficient was used to identify linear correlation among input continuous variables. The complete correlation matrix is given in Table 2 of Appendix, while in the following table we present only the important ( $p < 0.05$ ) linear relationships observed among each of the input variables and other variables.

*Table 3.* Summary results of the correlation analysis among continuous input variables.

Input variable	Positive linear relationship ( $p < 0.05$ )	Negative linear relationship ( $p < 0.05$ )
assignment upload	assignment view, course view, questionnaire submit, questionnaire view	view discussion, view forum, exams
assignment view	assignment upload, course view, questionnaire submit, questionnaire view, resource view, GPA	view discussion, ECTS, exams
course view	assignment upload, assignment view, view discussion, view forum, page view, questionnaire submit, questionnaire view, resource view, view all, GPA	
view discussion	course view, view forum, page view, exams	assignment upload, assignment view

view forum	course view, view discussion, page view, view all, exams	assignment upload
page view	course view, view discussion, view forum, GPA	
questionnaire submit	assignment upload, assignment view, course view, questionnaire view, URL view	exams
questionnaire view	assignment upload, assignment view, course view, questionnaire submit, url view, view all	exams
resource view	assignment view, course view, GPA	
url view	questionnaire submit, questionnaire view	
view all	course view, view forum, questionnaire view, user view	
user view	view all	
ECTS	exams	assignment view
GPA	assignment view, course view, page view, resource view, exams	
Exams	view discussion, view forum, ECTS, GPA	assignment upload, assignment view, questionnaire submit, questionnaire view

It can be seen from the Table 3 that *course view* is positively correlated with the largest number of input variables, including student GPA, meaning that the students that were more frequently looking at the course page in the e-learning system have a higher GPA, and also have a higher frequency of *assignment upload*, *assignment view*, *view discussion*, *view forum*, *page view*, *questionnaire submit*, *questionnaire view*, *resource view*, and *view all* course info. A positive correlation is also obtained among *assignment view* and the following variables: *assignment upload*, *course view*, *questionnaire submit*, *questionnaire view*, *resource view*, *GPA*. It can be concluded that the students who more often read their assignments instructions also more often upload their assignments, read the course material, read and submit the questionnaire, read resources, and have a higher GPA.

There is also a negative correlation revealing that the students who upload their assignment more frequently have lower frequency of viewing discussions and forums, meaning that the students that read discussions and forum messages are more active in submitting their assignments. Such students also have lower number of passed exams. One of the implication that could be made upon Table 2 is that students who communicate more at the e-learning course less frequently upload their assignments. However, the GPA is positively correlated with a group of variables that describe the frequency of viewing course materials, revealing that students who are more active in reading course materials have a higher GPA.

It is interesting that most of the significant correlation coefficients are lower than 0.5, and although significant, the linear correlation among variables is not high in general. A high linear correlation is only observed between *assignment view* and *course view* (0.7), and between *view forum* and *view discussion* (0.75). The above



results only provide some information about linear relationship among continuous input variables, showing that there are significant linear correlations but they are not high in general.

Step (1b) is to identify possible relationship between each individual input variable and the output variable. The t-test for independent samples is conducted to examine if there is a difference among the group of satisfied and the group of unsatisfied students in relation to their: GPA, ECTS, number of previously passed exams, and the variables that describe student activity in the e-learning system. The results showed that:

- There is no statistically significant difference between satisfaction with the course and GPA, number of previously passed exams, *assignment view*, *course view*, *view discussion*, *view forum*, *page view*, *questionnaire submit*, *questionnaire view*, *resource view*, *URL view*, *view all*, *user view*.
- There is a statistically significant difference between satisfaction with the course and ECTS points ( $p < 0.01$ ).

Figure 1 presents the Box & Whisker plot of the difference between student satisfaction and the number of earned ECTS points.

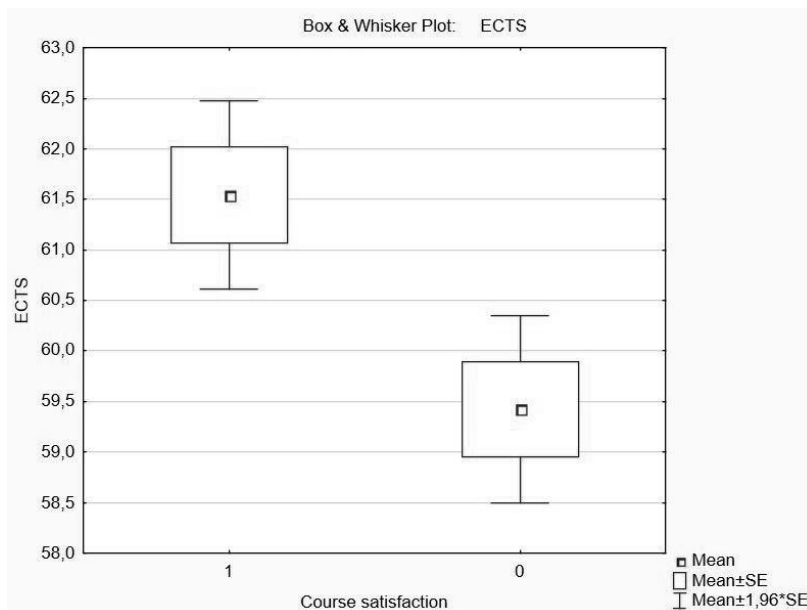

Figure 1. Box & Whisker plot of the variables *Course satisfaction* and *ECTS*.

It can be seen from Figure 1 that the mean value of earned ECTS points of satisfied students (with value 1 for Course satisfaction) is 61,5, while the unsatisfied students have earned approximately 59,5 ECTS points in average. The above

reveals that satisfied students are those who have previously earned more ECTS points.

The relationship of students' satisfaction and categorical variables is analyzed by the Pearson chi-square test. The test showed that there is no significant dependence between student course satisfaction and the type of financing, county which students come from, and gender.

The above statistical results partially confirm the research of Hong (2002) who also did not find significant relationship between student satisfaction and its activity on the course. However, our research found the variable ECTS as important for distinguishing satisfied from unsatisfied students. The conducted tests only analyze the difference in means or frequencies of two groups, and more tests should be done to reject the existence of any relationship among those variables with the satisfaction. Therefore we decide to continue with the procedure by designing a non-linear model of predicting student satisfaction with the course.

#### 4.2. Non-linear modelling – support vector machines and decision trees

Two machine learning methods: support vector machine and classification trees are used to conduct non-linear modelling of student satisfaction with the course as the Step 2 of the modelling procedure. Their results are presented below.

Two types of support vector machines (SVM) described in section 3.2. were tested in Statistica software. Table 4 presents the training constants, kernel types, overall classification accuracy, as well as separate accuracy for the output category 0 (unsatisfied students) and category 1 (satisfied students) for each of the tested SVM architectures. All the presented results are obtained on the test sample (consisting of 30% of data that were not used in training phase). The SVM model which produces the highest overall accuracy is noted in bold font.

Table 4. Results of the support vector machine models.

SVM type	Training constants	Kernel type	Classification accuracy on test sample (%)		
			Overall	0	1
type 1	capacity = 1.00	Polynomial (degree = 3, gamma = 0.06, coefficient = 0.00)	47.50	20.00	75.00
type 1	capacity = 8.00	Radial Basis Function (gamma = 0.06)	52.50	40.00	65.00
type 1	capacity = 9.00	Sigmoid (gamma = 0.06, coefficient = 0.00)	52.50	30.00	75.00
<b>type 2</b>	<b>nu = 0.40</b>	<b>Radial Basis Function (gamma = 0.06)</b>	<b>70.00</b>	<b>70.00</b>	<b>70.00</b>
type 2	nu = 0.30	Polynomial (degree = 3, gamma = 0.06, coefficient = 0.00)	60.00	55.00	65.00
type 2	nu = 0.30	Sigmoid (gamma = 0.06, coefficient = 1.00)	47.50	35.00	60.00

It can be seen from Table 4 that the most accurate SVM model is obtained by the type 2 SVM, with Radial Basis Function kernel, and with nu constant of 0.4.

Its overall classification accuracy is 70%, and the same result is obtained for each of the two categories of the satisfaction.

The decision tree with the highest classification accuracy was obtained by the use of CART algorithm with Gini measure of goodness of fit. The value of prior probabilities was set to estimated and misclassification cost was fixed on equal. FACT style was applied as a stopping rule with fraction of objects set to 0.9. This model had the overall classification accuracy of 62.5% (60.00% for category 0 (satisfied students) and 65.00% for category 1 (unsatisfied students)). Although the decision tree model was less accurate in recognizing satisfied and unsatisfied students on the test sample, this methodology is able to produce the decision rules in the form of “If X then Y” which are very ease to explain and implement, therefore very beneficial for decision makers. The graphical presentation of the obtained decision tree model is given in Figure 2.

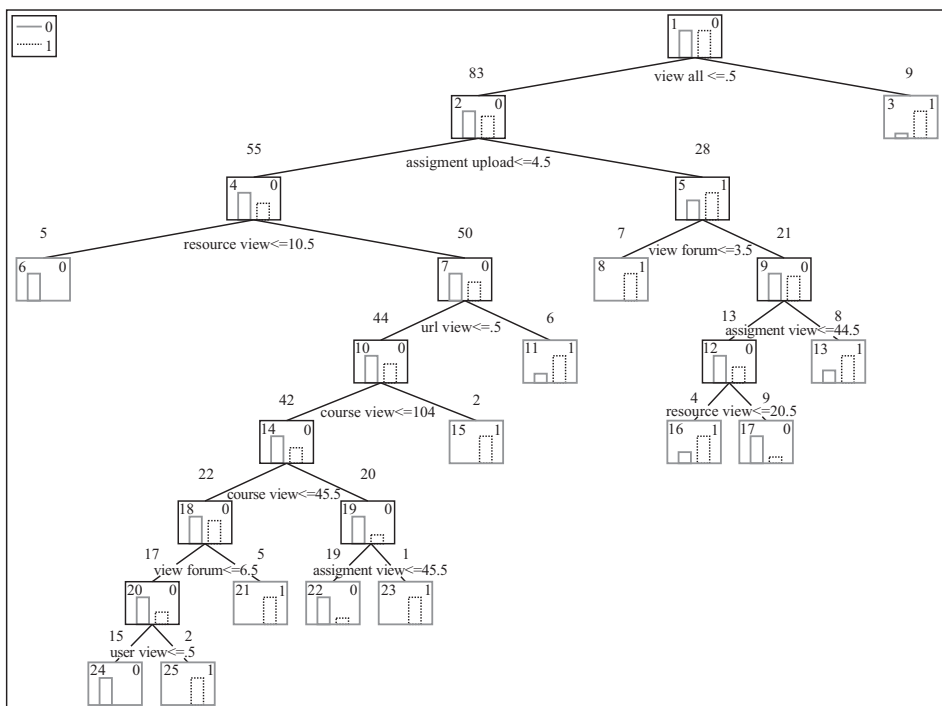

Figure 2. Graphical representation of classification tree.

It can be seen from Figure 2 that the decision tree consists of 24 nodes while the extracted rule set is composed of 13 production rules. The extracted rules are presented in Table 5.

Table 5. Decision tree rules.

Rule number	Description
1	IF view all $\leq 0.5$ AND assignment upload $\leq 4.45$ AND resource view $\leq 10.5$ THEN classify as 0.
2	IF view all $> 0.5$ THEN classify as 1.
3	IF view all $\leq 0.5$ AND assignment upload $> 4.5$ AND view forum $\leq 3.5$ THEN classify as 1
4	IF view all $\leq 0.5$ AND assignment upload $> 4.5$ AND view forum $> 3.5$ AND assignment view $\leq 44.5$ AND resource view $\leq 20.5$ THEN classify as 1
5	IF view all $\leq 0.5$ AND assignment upload $> 4.5$ AND view forum $> 3.5$ AND assignment view $> 44.5$ THEN classify as 1
6	IF view all $\leq 0.5$ AND assignment upload $> 4.5$ AND view forum $> 3.5$ AND assignment view $\leq 44.5$ AND resource view $\leq 20.5$ THEN classify as 1
7	IF view all $\leq 0.5$ AND assignment upload $> 4.5$ AND view forum $> 3.5$ AND assignment view $\leq 44.5$ AND resource view $> 20.5$ THEN classify as 0
8	IF view all $\leq 0.5$ AND assignment upload $\leq 4.45$ AND resource view $> 10.5$ AND url view $\leq 0.5$ AND course view $\leq 104$ AND course view $\leq 45.5$ AND view forum $\leq 6.5$ AND user view $\leq 0.5$ THEN classify as 0.
9	IF view all $\leq 0.5$ AND assignment upload $\leq 4.45$ AND resource view $> 10.5$ AND url view $\leq 0.5$ AND course view $\leq 104$ AND course view $\leq 45.5$ AND view forum $> 6.5$ THEN classify as 1.
10	IF view all $\leq 0.5$ AND assignment upload $\leq 4.45$ AND resource view $> 10.5$ AND url view $\leq 0.5$ AND course view $\leq 104$ AND course view $> 45.5$ AND assignment view $\leq 32.5$ THEN classify as 0.
11	IF view all $\leq 0.5$ AND assignment upload $\leq 4.45$ AND resource view $> 10.5$ AND url view $\leq 0.5$ AND course view $> 104$ THEN classify as 1.
12	IF view all $\leq 0.5$ AND assignment upload $\leq 4.45$ AND resource view $> 10.5$ AND url view $> 0.5$ THEN classify as 1.
13	IF view all $\leq 0.5$ AND assignment upload $\leq 4.45$ AND resource view $> 10.5$ AND url view $\leq 0.5$ AND course view $\leq 104$ AND course view $> 45.5$ AND assignment view $> 32.5$ THEN classify as 1.

Rules that draw attention are 1, 7, 8, and 10, where students were classified in the category labeled as 0 (unsatisfied). Because of the relevance of the extracted rules decimal number are in interpretation rounded to the nearest whole number. Those rules can be used to create four groups of unsatisfied students with the following characteristics:

- Rule 1 (or group 1 of unsatisfied students) – those who viewed all course materials once or less, and uploaded their assignments 5 times or less, and viewed resources 11 times or less.
- Rule 7 (or group 2 of unsatisfied students) – those who viewed all course material once or less, uploaded their assignments more than 5 times, viewed forum more than 4 times, view the assignments 45 times or less, and viewed courses more than 21 times.
- Rule 8 (or group 3 of unsatisfied students) – those who viewed all course materials once or less, uploaded their assignments 45 times or less, viewed resources

more than 11 times, viewed url once or less, viewed course 104 times or less, viewed course 46 times or less, viewed forum 7 times or less, and viewed users once or less.

- Rule 10 (or group 4 of unsatisfied students) – those who viewed all course materials once or less, uploaded their assignments 5 times or less, viewed resources more than 11 times, viewed url once or less, viewed course 104 times or less, viewed course more than 46 times, viewed assignment 33 times or less.

The rules in Table 5 that identify satisfied students are more diversified, implying that satisfied students have different activities, but if for clarity reasons we apply the same procedure as above only to four levels, the following groups of satisfied students can be extracted:

- Rule 2 (group 1 of satisfied students) – those who viewed all course materials more than once
- Rule 3 (group 2 of satisfied students) – those who viewed all course materials once or less, but also uploaded their assignment more than 5 times and viewed forum 4 times or less
- Rules 4, 5, and 6 (group 3 of satisfied students) – those who viewed all course materials once or less, but also uploaded their assignment more than 5 times, viewed forum more than 4 times, and viewed assignment more than 45 times (or less than 45 times, but in that case viewed resource 21 times or less)
- Rules 9, 11, 12, and 13 (group 4 of satisfied students) - those who viewed all course materials once or less, but also uploaded their assignment 5 times or less, viewed resource more than 11 times, and viewed url once or less (or viewed url more than once, but also viewed course more than 104 times (or 104 times or less, but also viewed course more than 46 times).

The above shows that satisfied students are all of those who viewed course materials more than once, and that rule is very simple. However, there are satisfied students among those who viewed course materials only once or less, but in that case they share some other characteristics, mainly regarding the frequency of uploading their assignments and view of resources. After completion of the step (2) of the suggested modelling procedure, the last step is to identify student profiles according to their satisfaction, which is described in the next section.

#### 4.3. Identifying student profiles according to their satisfaction with the course

The above described rules show that unsatisfied students are more homogeneous group than satisfied student, and that four different groups of their main characteristics regarding the course activity in e-learning environment exist. In order to identify a common profile of unsatisfied students, the values of variables that appear in most among four above groups were extracted, such that the following common characteristics of unsatisfied students could be identified:

- unsatisfied students are those who viewed all course materials once or less, uploaded their assignments 5 times or less, viewed resources more than 11 times, viewed forum between 5 and 7 times, viewed course between 22 and 46 times,

viewed users once or less, and viewed the assignments 33 times or less. Also, following the results of statistical tests of differences (see section 4.2), it can be also concluded that unsatisfied students have a lower value of total ECTS points earned.

Identifying the profile of satisfied students is a more difficult task due to their diverse characteristics, but it can be implied on the basis of the extracted rules that:

- satisfied students are those who viewed all course materials more than once
- and also those who viewed all course materials once or less, but also uploaded their assignment more than 5 times and viewed forum 4 times or less.

Those profiles could lead to a general conclusion that students who view all course materials (i.e. are systematic and do not learn partially) are more satisfied with the course than students who view only selected materials. On the other side, students who view selected materials, but upload more of their assignments (i.e. work hard on their assignments) are also generally satisfied. However, communication on the e-learning platform, measured by the view of forum, was found to be a characteristic of unsatisfied, rather than satisfied students.

## 5. Conclusion

The paper deals with the problem of student satisfaction with a course in an e-learning environment. The aim was to discover patterns in students' behaviour that could help in creating profiles of satisfied and unsatisfied students. Input space consisted of student activities during a course captured from log files, as well as student descriptive variables. A three-step modelling procedure was suggested to reveal the knowledge about students' behaviour. In the first step, statistical tests were conducted to find correlations among input variables, as well as the dependence among input variables and the student satisfaction. Then the nonlinear machine learning methods, such as support vector machines and decision rules were used to model student satisfaction with a course. It was shown that the support vector machines have a higher accuracy in predicting student satisfaction, while the decision rules are more explanatory in extracting important characteristics of students. In the third step, the characteristic groups and profiles of students were identified according to their satisfaction. The results show that unsatisfied students are more homogeneous than satisfied ones, they view all course materials only once or never, and are not very active in uploading their assignments. On the other side, satisfied students put more effort in frequent viewing of all course materials, they are more active in uploading assignments, and have more previously earned ECTS points than unsatisfied students. The extracted characteristics could be used to improve student satisfaction with the course by stimulating the activities that imply satisfaction with the course. The results of this research could be used by academic teachers in increasing the level of their student satisfaction, and also the researchers in this area could benefit from the suggested modelling procedure. Future research could be focused on including more e-courses in the dataset on different levels of academic education, in order to generalize the results.

Appendix

Table 2. Correlation matrix for input variables\*.

	assignment upload	assignment view	course view	view discussion	view forum	page view	questionnaire submit	questionnaire view	resource view	url view	view all	user view	ECTS	GPA	exams
assignment upload	1.00	<b>0.66</b>	<b>0.29</b>	<b>-0.32</b>	<b>-0.19</b>	0.01	<b>0.21</b>	<b>0.23</b>	0.10	0.03	0.00	0.00	-0.11	0.06	<b>-0.44</b>
assignment view	<b>0.66</b>	1.00	<b>0.70</b>	<b>-0.21</b>	-0.05	0.06	<b>0.26</b>	<b>0.26</b>	<b>0.27</b>	0.03	0.01	0.04	<b>-0.18</b>	<b>0.20</b>	<b>-0.49</b>
course view	<b>0.29</b>	<b>0.70</b>	1.00	<b>0.23</b>	<b>0.35</b>	<b>0.20</b>	<b>0.33</b>	<b>0.32</b>	<b>0.58</b>	0.07	<b>0.19</b>	0.03	-0.14	<b>0.34</b>	-0.15
view discussion	<b>-0.32</b>	<b>-0.21</b>	<b>0.23</b>	1.00	<b>0.75</b>	<b>0.32</b>	-0.08	-0.08	0.17	0.01	0.09	0.02	0.10	0.12	<b>0.34</b>
view forum	<b>-0.19</b>	-0.05	<b>0.35</b>	<b>0.75</b>	1.00	<b>0.35</b>	0.04	0.04	0.14	0.12	<b>0.22</b>	0.14	0.12	0.14	<b>0.28</b>
page view	0.01	0.06	<b>0.20</b>	<b>0.32</b>	<b>0.35</b>	1.00	0.11	0.09	0.03	0.02	0.08	0.00	0.10	<b>0.26</b>	0.08
questionnaire submit	<b>0.21</b>	<b>0.26</b>	<b>0.33</b>	-0.08	0.04	0.11	1.00	<b>0.97</b>	0.10	<b>0.24</b>	0.17	-0.02	-0.06	0.14	<b>-0.25</b>
questionnaire view	<b>0.23</b>	<b>0.26</b>	<b>0.32</b>	-0.08	0.04	0.09	<b>0.97</b>	1.00	0.11	<b>0.22</b>	<b>0.19</b>	-0.03	-0.09	0.17	<b>-0.25</b>
resource view	0.10	<b>0.27</b>	<b>0.58</b>	0.17	0.14	0.03	0.10	0.11	1.00	0.01	0.04	-0.10	-0.10	<b>0.25</b>	-0.01
url view	0.03	0.03	0.07	0.01	0.12	0.02	<b>0.24</b>	<b>0.22</b>	0.01	1.00	0.10	0.09	-0.03	-0.03	0.12
view all	0.00	0.01	<b>0.19</b>	0.09	<b>0.22</b>	0.08	0.17	<b>0.19</b>	0.04	0.10	1.00	<b>0.27</b>	0.01	0.15	0.13
user view	0.00	0.04	0.03	0.02	0.14	0.00	-0.02	-0.03	-0.10	0.09	<b>0.27</b>	1.00	0.04	-0.15	0.02
ECTS	-0.11	<b>-0.18</b>	-0.14	0.10	0.12	0.10	-0.06	-0.09	-0.10	-0.03	0.01	0.04	1.00	-0.04	<b>0.25</b>
GPA	0.06	<b>0.20</b>	<b>0.34</b>	0.12	0.14	<b>0.26</b>	0.14	0.17	<b>0.25</b>	-0.03	0.15	-0.15	-0.04	1.00	<b>0.20</b>
exams	<b>-0.44</b>	<b>-0.49</b>	-0.15	<b>0.34</b>	<b>0.28</b>	0.08	<b>-0.25</b>	<b>-0.25</b>	-0.01	0.12	0.13	0.02	<b>0.25</b>	<b>0.20</b>	1.00

\*significant coefficients (p<0.05) are in bold font

## References

- [1] ABDULLAH, Z., HERAWAN, T., AHMAD, N., & DERIS, M. M. (2011), *Mining significant association rules from educational data using critical relative support approach*, *Procedia-Social and Behavioral Sciences*, 28, 97–101.
- [2] APTE, C. AND S. WEISS (1997), *Data Mining with Decision Trees and Decision Rules*, *Future Generation Computer Systems*, Vol. 13, pp. 197–210.
- [3] BARADWAJ, B. K., & PAL, S. (2012), *Mining educational data to analyze students' performance*, arXiv preprint arXiv:1201.3417.
- [4] BEHZAD, M., ASGHAR, K., EAZI, M. AND PALHANG, M. (2009), *Generalization performance of support vector machines and neural networks in runoff modeling*, *Expert Systems with Applications*, Vol. 36, pp. 7624–7629.
- [5] ĐURĐEVIĆ BABIĆ, I. (2015), *Predicting student satisfaction with courses based on log data from a virtual learning environment – a neural network and classification tree model*, *Croatian Operational Research Review*, 6 (1), 105–116.
- [6] GUZZI, P. H., MILANO, M., & CANNATARO, M. (2014), *Mining Association Rules from Gene Ontology and Protein Networks: Promises and Challenges*, *Procedia Computer Science*, 29, 1970–1980.
- [7] HANAYSHA, J., ABDULLAH, H. H., & WAROKKA, A. (2011), *Service quality and students' satisfaction at higher learning institutions: The competing dimensions of Malaysian Universities' competitiveness*, *Journal of Southeast Asian Research*, 1.
- [8] HONG, K. S. (2002), *Relationships between students' and instructional variables with satisfaction and learning from a Web-based course*, *The Internet and Higher Education*, 5 (2), 267–281.
- [9] HSU, C. W., CHANG, C. C., & LIN, C. J. (2003), *A practical guide to support vector classification*, <https://www.cs.sfu.ca/people/Faculty/teaching/726/spring11/svmguide.pdf>, [Accessed on 4 May 2015].
- [10] KAMBER, M., WINSTONE, L., GONG, W., CHENG, S., & HAN, J. (1997, April), *Generalization and decision tree induction: efficient classification in data mining*, In *Research Issues in Data Engineering, 1997. Proceedings. Seventh International Workshop on* (pp. 111–120). IEEE.
- [11] NARVEKAR, M., & SYED, S. F. (2015), *An Optimized Algorithm for Association Rule Mining Using FP Tree*, *Procedia Computer Science*, 45, 101–110.
- [12] NEGRICEA, C. I., EDU, T., & AVRAM, E. M. (2014), *Establishing Influence of Specific Academic Quality on Student Satisfaction*, *Procedia-Social and Behavioral Sciences*, 116, 4430–4435.
- [13] PAVLEKOVIĆ, M., ZEKIĆ-SUŠAC, M., ĐURĐEVIĆ, I. (2009), *Comparison of intelligent systems in detecting a child's mathematical gift*, *Computers and Education*, 53, pp. 142–154.
- [14] QUESTIER, F., PUT, R., COOMANS, D., WALCZAK, B. AND VANDER HEYDEN Y. (2005), *The use of CART and multivariate regression trees for supervised and unsupervised feature selection*, *Chemometrics and Intelligent Laboratory Systems*, Vol. 76, pp. 45–54.



- [15] QUINLAN, J. R. (1987, August), *Generating Production Rules from Decision Trees*, In *IJCAI* (Vol. 87, pp. 304–307).
- [16] RAHMAN, C. M., SOHEL, F. A., NAUSHAD, P., & KAMRUZZAMAN, S. M. (2010), *Text classification using the concept of association rule of data mining*, arXiv preprint arXiv:1009.4582.
- [17] ROMERO, C., VENTURA, S., & GARCÍA, E. (2008), *Data mining in course management systems: Moodle case study and tutorial*, *Computers & Education*, 51 (1), 368–384.
- [18] SADH, A. S., & SHUKLA, N. (2013), *Association Rules Optimization: A Survey*, *International Journal of Advanced Computer Research (IJACR)*, 3.
- [19] StatSoft, Support Vector Machines (SVM) Introductory Overview, <http://www.statsoft.com/textbook/support-vector-machines>, [Accessed on 15 April 2015]
- [20] University of Josip Juraj Strossmayer in Osijek, Faculty of Education in Osijek, Internal student survey of the Faculty of Education in Osijek, [http:// web.foozos.hr/images/dokumenti/osiguravanje-kvalitete/Obrazac\\_za\\_provodjenje\\_interne\\_studentske\\_ankete.doc](http://web.foozos.hr/images/dokumenti/osiguravanje-kvalitete/Obrazac_za_provodjenje_interne_studentske_ankete.doc) [Accessed on 21 April 2015].
- [21] WEI, C. C. AND RAMALU, S. S. (2011), *Students Satisfaction towards the University: Does Service Quality Matters?*, *International Journal of Education*, 3, 2, E15.
- [22] YU, H., YANG, J. HAN, J. (2003), *Classifying Large Data Sets Using SVMs with Hierarchical Clustering*, KDD '03 Proceedings of the ninth ACM SIGKDD International Conference on Knowledge Discovery and Data Mining, ACM New York, NY, USA, pp. 306–315.
- [23] YUNUS, N. K. Y., ISHAK, S. AND RAZAK, A. Z. A. A. (2010), *Motivation, Empowerment, Service Quality and Polytechnic Students' Level of Satisfaction in Malaysia*, *International Journal of Business and Social Science*, 1, 120–128.

*Contact addresses:*

Marijana Zekić-Sušac  
Faculty of Economics in Osijek  
Josip Juraj Strossmayer University of Osijek  
Gajev trg 7, 31000 Osijek, Croatia  
e-mail: [marijana@efos.hr](mailto:marijana@efos.hr)

Ivana Đurđević Babić  
Faculty of Education  
Josip Juraj Strossmayer University of Osijek  
Cara Hadrijana 10, 31000 Osijek, Croatia  
e-mail: [idjurdjevic@foozos.hr](mailto:idjurdjevic@foozos.hr)

## Otkrivanje uzoraka kod ponašanja studenata u okolini e-učenja

---

---

Marijana Zekić-Sušac<sup>1</sup> i Ivana Đurđević Babić<sup>2</sup>

<sup>1</sup>Ekonomski fakultet u Osijeku, Sveučilište Josipa Jurja Strossmayera u Osijeku, Hrvatska

<sup>2</sup>Fakultet za odgojne i obrazovne znanosti, Sveučilište Josipa Jurja Strossmayera u Osijeku, Hrvatska

*Sažetak.* Prednosti e-učenja u velikoj su mjeri prepoznate u današnjem obrazovanju. Međutim, još uvijek nije dovoljno istraženo ponašanje studenata na nekom kolegiju koji koristi platformu za e-učenje te povezanost tog ponašanja i zadovoljstva studenata s tim kolegijem. Ovaj rad analizira log podatke kolegija Fakulteta za odgojne i obrazovne znanosti u Osijeku u okolini e-učenja i teži otkrivanju uzoraka u ponašanju studenata koji bi mogli omogućiti kreiranje profila zadovoljnih i nezadovoljnih studenata. Konačni cilj rada je otkriti znanje o ponašanju studenata koje će pomoći akademskim nastavnicima u povećanju stupnja zadovoljstva njihovih studenata. Metodologija korištena u ovom istraživanju uključuje nekoliko metoda rudarenja podataka, kao što su statistički testovi zavisnosti i metode strojnog učenja: stabla odlučivanja i asocijacijska pravila. Rezultati pokazuju da su zadovoljni studenti oni koji ulažu više truda u često pregledavanje materijala kolegija, aktivniji su u komunikaciji, imaju više prethodno položenih kolegija od nezadovoljnih studenata te više njih samostalno financira svoj studij. U svrhu generalizacije rezultata, istraživanje bi trebalo proširiti na veći broj kolegija koji se odvijaju koristeći potporu sustava za e-učenje na različitim razinama akademskog obrazovanja.

*Ključne riječi:* ponašanje studenata, e-učenje, asocijacijska pravila, rudarenje podacima, stabla odlučivanja

# Classification trees in detecting students' motivation for maths from their ICT and Facebook use

---

---

Ivana Đurđević Babić\* and Anita Marjanović

Faculty of Education, Josip Juraj Strossmayer University of Osijek, Croatia

*Abstract.* Previous studies show that students' motivation for maths is an important factor of students' active engagement in the learning process and the level of students' achievement in mathematics courses. The purpose of this paper is to present the potential of classification trees in detecting students' motivation for maths. In addition, the aim was to construct a classification tree model that will be effective in detecting students with a lower level of motivation for maths. The classification tree model was established on students' perception of their ICT and Facebook use. Motivated Strategies for Learning Questionnaire (MSLQ) (Pintrich et al., 1991) scale was used for determining the level of students' motivation for maths, and the Facebook Intensity (FI) scale (Ellison et al., 2007) was used for measuring students' Facebook use. The students from the third year of the Faculty of Education in Osijek participated in this research. The results showed great potential of a classification tree model as means for detecting students' motivation for maths since the best obtained classification tree model achieved accuracy of 80% in detecting students with a lower level of motivation for maths.

*Keywords:* classification tree, motivation for maths, ICT usage, Facebook usage, students' attitude

## 1. Introduction

Although there are many factors that affect students' academic achievement, students' motivation is identified as one of the most important. As emphasized by Githua and Mwangi (2003) motivated students are capable of using advanced cognitive skills in learning as well as taking in and fully understanding more information from the subject matter (Githua and Mwangi (2003) from Graham and

---

\*Corresponding author.

Golan 1991). Additionally, these authors stress the teachers' role in detection, encouragement and upholding of students' motivation (Githua and Mwangi, 2003 from Slavin 1997). Yavuz et al. (2012) refer to student motivation in mathematics and perceive its possible advantage in students' mathematical activities as aid in predicting procedures and results. The positive effect of motivation on the decreasing of dropout rates and improving students' success is mentioned in Moenikia and Zahed-Babelan (2010) (from Kushman, Sieber, & Harold, 2000).

With the purpose of detecting students' level of motivation for maths, this paper aims to analyse the potential of development and successfulness of classification tree model derived from students' perception of their ICT and Facebook use. Besides decision trees, several data mining methods such as neural networks, genetic algorithm, k-nearest neighbour classifier, Bayesian classifiers or support vector machines can be used for solving classification problem. Because of their ability to create model without a large number of parameters (Wang et al., 2015) and assumptions regarding the probability distribution of attributes, as mentioned in Mistikoglu et al. (2015), decision trees are used in this research.

In spite of the fact that motivation is often researched, data mining methods are rarely used for solving this problem. This paper contributes to the research in this field by exploring if students' level of motivation could be detected by merely using students' attitudes related to ICT use in mathematics teaching and assessments of their ICT and Facebook usage.

The review of previous research relevant to the issue of students' mathematics motivation is presented in the next section. The description of used scales, sample and methodology of classification trees is presented in Section 3 while the obtained results and description of the most appropriate model are reported in Section 4. A short discussion with limitation of this research is presented in the last section.

## 2. Literature review

Kebritchi et al. (2010) conducted a study in order to examine the effects of mathematics computer games DimensionM<sup>TM</sup> on mathematics achievement and motivation of secondary school students. They used quantitative instruments and interviews to collect data. Although their research did not show significant overall findings, they concluded that the results obtained by their motivation interview supported findings of previous research and therefore concluded that game-play may have a positive effect on students' motivation for mathematics. Authors Githua and Mwangi (2003) conducted other type of research dealing with students' motivation. They carried out a research in Kenya's secondary schools and investigated the correlation of students' mathematics self-concept and their motivation for learning mathematics as well as students' gender differences. The conclusion of this research was that at the level of significance of 0.05 there is a relationship between students' mathematics self-concept and students' motivation for learning mathematics. In addition, they identified gender differences in students' perception of likelihood of success and satisfaction in learning mathematics. Lapointe et al.

(2005) examined students' perceptions of teacher behaviour in self-efficacy, intrinsic value and test anxiety in mathematics for teaching disabled, average and talented students. Their results showed that the students who participated in that research differ in motivational beliefs in maths and in perceptions of the teacher. They also found that for average and talented students, students' perception of the teacher has implications in motivation for maths. Suárez-Álvarez et al. (2014) examined the relationship between academic performance in mathematics and sciences and academic self-concept, motivation and academic expectations on a sample of second grade students of Compulsory Secondary Education in Spain. They established that these variables have statistically significant correlation with students' academic performance. Bakar et al. (2010) investigated secondary school students' motivation when using the V-transformation courseware and software GeoGebra. Based on the obtained results, they encourage technology usage in order to motivate students for teaching and learning mathematics. Using the expectancy-value motivational model on 8<sup>th</sup> and 9<sup>th</sup> graders Gasco et al. (2014) conducted a research in order to analyse gender differences in motivation for mathematics. Their results showed the existence of gender difference only in the outcome of the self-efficacy in the 8<sup>th</sup> grade. Moenikia and Zahed-Babelan (2010) investigated the correlation between students' mathematics' attitude, academic motivation and intelligence quotient with mathematics achievement. They established a statistically significant correlation between these variables. Academic motivation was also considered in research performed by Andrei et al. (2014) where academic motivation and learning strategies of the 9<sup>th</sup> grade students in humanities study were compared with mathematics and science study.

In most of the educational data mining research, motivation is used as one of the predictive attributes, but in several, it is the dependent (target) value. One of the studies where it is considered as target value is research conducted by Cocea and Weibelzahl (2007) where students' engagement is identified with students' motivation. Cocea and Weibelzahl (2007) used eight data mining techniques in order to investigate students' log files for detecting students' engagement level in e-learning system. They gathered and analysed log events associated with 14 attributes (goal, preference, reading pages, pre-tests, tests, hyperlink, manual, help, glossary, communication, search, remarks, statistics, feedback) and used additional information (user ID, sequence ID, session ID and total time of the sequence) in order to classify students into three categories (engaged, disengaged, neutral). The highest classification accuracy in this research was obtained by Classification via Regression and the authors concluded that in this model, based on their data set, attributes that are related with reading pages, tests, hyperlinks and glossary have the greatest influence on predicting students' engagement. Hershkovitz and Nachmias (2010) also used data mining and log files for assessment of students' motivation. They used 13 variables (gender, age, department, secondary school major, secondary school grade, study type, funding, place of residency, lecturer degree, gender and department, number of repetitions, grade of C++ course) and decision trees for generating classification rules. Based on three different algorithms (ID3, C4.5, Naïve Bayes) they obtained inadequate classification accuracy. The highest obtained classification accuracy in their research was 38.46%.

### 3. Methodology

Altogether 103 students from the third year of the Faculty of Education in Osijek and the branch campus in Slavonski Brod were involved in this study. The research was conducted in the academic year 2014/2015. The students were asked to complete Facebook Intensity (FI) scale (Ellison et al., 2007.) and Motivated Strategies for Learning Questionnaire (MSLQ) scale (Pintrich et al., 1991.). Furthermore, they answer the question concerning their age, eight questions about their perception of their ICT use and to express their level of agreement on a five point Likert scale (1-strongly disagree, 5-strongly agree) with six statements concerning the use of ICT in mathematics. With the purpose of building binary classification tree, final scores of students' motivation were classified into two categories. The first category labelled as 1 contains students with a higher level of motivation for mathematics (the mean of all used MSLQ item scores was greater than or equal to 4.695) and the second category indicates students with a lower level of motivation for mathematics (the mean of all used MSLQ item scores was less than 4.695) and labelled as 0. The variable containing the notation of students' level of motivation was the output (dependent) variable of the model while the mean of all items scores from the Facebook Intensity (FI) scale, age, students' perception of their ICT usage as well as their agreement with mentioned statements dealing with ICT use in mathematics were input variables.

The list of predictor variables and their short description used in classification models is given in Table 1.

Table 1. Predictor variables in classification tree model.

Variable	Variable description	Basic statistics
V1	students' age (0 – less than 20, 1 – from 20 to 23, 2 – from 24 to 26, 3 – more than 26)	0 = 0.98%, 1 = 98.00%, 2 = 0.98%, 3 = 0.00%
V2	estimated monthly ICT use (0 – never, 1 – rarely, 2 – sometimes, 3 – very often, 4 – always)	0 = 0.98%, 1 = 0.00%, 2 = 1.96%, 3 = 49.02%, 4 = 48.04%
V3	estimated daily ICT use (0 – less than 15 minutes, 1 – 15 to 59 minutes, 2 – hour or two, 3 – two to three hours, 4 – more than 3 hours)	0 = 0.98%, 1 = 6.86%, 2 = 25.49%, 3 = 26.47%, 4 = 40.20%
V4	most common purpose of ICT use (0 – education, 1 – entertainment, 2 – informing, 3 – communication, 4 – research, 5 – something else)	0 = 0.00%, 1 = 53.92%, 2 = 17.65%, 3 = 5.88%, 4 = 22.55%, 5 = 0.00%
V5	self-evaluated ICT literacy grade (1 – extremely poor, 2 – below average, 3 – average, 4 – above average, 5 – excellent)	1 = 0.00%, 2 = 1.96%, 3 = 33.33%, 4 = 52.94%, 5 = 11.76%
V6	frequency of ICT use for obtaining learning materials (1 – never, 2 – rarely, 3 – sometimes, 4 – very often, 5 – always)	1 = 0.00%, 2 = 0.98%, 3 = 8.82%, 4 = 77.45%, 5 = 12.75%

V7	frequency of ICT use for communication with colleagues (1 – never, 2 – rarely, 3 – sometimes, 4 – very often, 5 – always)	1 = 0.00%, 2 = 0.00%, 3 = 8.82%, 4 = 47.06%, 5 = 44.12%
V8	frequency of ICT use for communication with teachers (1 – never, 2 – rarely, 3 – sometimes, 4 – very often, 5 – always)	1 = 1.96%, 2 = 12.75%, 3 = 54.90%, 4 = 23.53%, 5 = 6.86%
V9	frequency of ICT use for obtaining relevant information and news about the study (1 – never, 2 – rarely, 3 – sometimes, 4 – very often, 5 – always)	1 = 0.00%, 2 = 3.92%, 3 = 22.55%, 4 = 53.92%, 5 = 19.61%
V10	level of agreement with the statement that ICT in math- ematics teaching should be used for gathering feedbacks from students (1 – strongly disagree, 2 – disagree, 3 – undecided, 4 – agree, 5 – strongly agree)	1 = 0.98%, 2 = 4.90%, 3 = 27.45%, 4 = 33.33%, 5 = 33.33%
V11	level of agreement with the statement that ICT in math- ematics teaching should be used for communication with students (1 – strongly disagree, 2 – disagree, 3 – undecided, 4 – agree, 5 – strongly agree)	1 = 0.00%, 2 = 5.88%, 3 = 12.75%, 4 = 38.24%, 5 = 43.14%
V12	level of agreement with the statement that ICT in math- ematics teaching should be used for actively engaging students in class (1 – strongly disagree, 2 – disagree, 3 – undecided, 4 – agree, 5 – strongly agree)	1 = 2.94%, 2 = 3.92%, 3 = 18.63%, 4 = 40.20%, 5 = 34.31%
V13	level of agreement with the statement that ICT in math- ematics teaching should be used for clarification of basic mathematics concepts (1 – strongly disagree, 2 – disagree, 3 – undecided, 4 – agree, 5 – strongly agree)	1 = 7.84%, 2 = 12.75%, 3 = 41.18%, 4 = 17.65%, 5 = 20.59%
V14	level of agreement with the statement that ICT in math- ematics teaching should be used for repetition of learned subject matter (1 – strongly disagree, 2 – disagree, 3 – undecided, 4 – agree, 5 – strongly agree)	1 = 4.90%, 2 = 7.84%, 3 = 31.37%, 4 = 29.41%, 5 = 26.47%
V15	level of agreement with the statement that ICT in math- ematics teaching should be used for explaining geometric concepts (1 – strongly disagree, 2 – disagree, 3 – undecided, 4 – agree, 5 – strongly agree)	1 = 6.86%, 2 = 11.76%, 3 = 24.51%, 4 = 21.57%, 5 = 35.29%
V16	the obtained mean of items scores in Facebook Intensity scale	M = 4.00, SD = 1.01

The obtained classification tree models were compared based on their average classification accuracy of both categories contained in the output variable. The model with the highest overall classification rate was regarded as the most successful model. The training sample included 80% of the data and the remaining 20% of the data formed the test sample. The samples were randomly chosen. The results gained from test sample were used for models comparison.

### 3.1. Measure of Facebook usage

Facebook intensity scale of Ellison et al. (2007) was used as a measure of Facebook usage in this study. As reported by the authors of the scale, in scale items Facebook users provide details about the total number of their Facebook friends and the daily amount of time spent on Facebook. The authors emphasized that this scale consists of a series of six items for assessing participants' level of intense feelings related with Facebook and the degree of Facebook integration into users' daily activities. A 5-point Likert scale is used for assessing participants' agreement with every item in the scale. The reported measure of scale reliability Cronbach's alpha equals 0.83 (Ellison et al., 2007).

### 3.2. Measure of motivation for mathematics

In order to determine the level of students' motivation for mathematics Motivated Strategies for Learning Questionnaire (MSLQ) scale (Pintrich et al., 1991.) was used. As described in Pintrich et al. (1993) this scale consists of two parts. The first part of the MSLQ was developed to measure students' motivation while the second part deals with students' use of learning strategies (Pintrich et al., 1993). The entire MSLQ consists of 81 items in which students assess their level of agreement on a 7-point Likert scale ranging from 1 (strongly disagree) to 7 (strongly agree). Only 31 items that form the first motivational part of the MSLQ were adapted from MSLQ scale in this research. As explained in Pintrich et al. (1991), this motivational part of MSLQ includes three value component (Intrinsic Goal Orientation, Extrinsic Goal Orientation and Task Value), two expectancy components (Control beliefs, Self-efficacy for learning and performance) and affective component (Test anxiety). The final score of students' motivation is gained by taking the mean of the all item scores. The detailed interpretation of scale history development, description of the scale items as well as reliability, predictive validity of MSLQ scale and instructions for scoring the scale can be found in Pintrich et al. (1993) and MSLQ Manual (Pintrich et al., 1991). The extensive use of MSLQ in various fields such as education psychology or teacher training and in numerous educational institutions in different levels of education was noticed and clearly indicated by Karadeniz et al. (2008).

### 3.3. Classification tree

Decision tree is a data mining technique that can be used for classification or regression problems. In case when it is applied for classification, it is called classification tree and is used for classification of cases to a predefined set of categories (Rokach and Maimon, 2015). Dejaeger et al. (2012) clarify that the reasons for extensive use of decision trees in different fields lie in their main advantages such as flexibility, computational efficiency and comprehensibility. Rokach and Maimon (2015) underline their simplicity and transparency as reasons for decision tree



popularity. Classification tree consists of root node, branches, internal and leaf (terminal) nodes. The value of one predefined category is assigned to every leaf node. Every internal node in classification tree represents a test on an attribute of cases while each branch represents the outcome of that test (Maimon and Rokach, 2005). Classification tree mostly starts the splitting process from the root node and builds the tree using top-down strategy to the leaf node. This process can be denoted as binary tree where every parent node has two child nodes (Robotham et al., 2011). Gorunescu (2011) lists Gini index, entropy, misclassification measure, Chi-square measure and G-square measure as mostly used splitting criteria. The splitting repeats until defined stopping parameters are achieved. Different algorithms can be used for building decision tree but discriminant-based univariate splits algorithms (based on QUEST (Quick, Unbiased, Efficient, Statistical Tree) algorithm) and Classification and Regression Trees (CART) are among the most popular, because of their ability to work with ordered and categorical variables. Rokach and Maimon (2015) clarify that QUEST, using statistical tests such as ANOVA, Levene's test or Pearson's chi-square, enquires if there is a relationship between every input and target variable and chooses the variable with the highest significance of the relationship as split variable.

Questier et al. (2005) specified seven CART steps and defined the Gini index as:

$$\text{Gini}=1 - \sum_{j=1}^c \left(\frac{n_j}{n}\right)^2 \quad (1)$$

where  $n$  is the number of cases in node,  $c$  possible categories and  $n_j$  the number of cases from category  $j$  in the node.

Algorithms available in Statistica 12 (Classification and Regression Trees (CART) algorithm and discriminant-based univariate splits algorithms build on QUEST (Quick, Unbiased, Efficient Statistical Trees)) were applied in this research. Gini index, Chi-square measure or G-square measure were used as goodness of fit when applying CART exhaustive search.

#### 4. Results

All 16 input variables were used for construction of classification tree models. The results with the highest average classification rate achieved for both categories by the use of both split selection methods are presented in Table 2. The best classification tree model was obtained by discriminant-based univariate split selection method where equal prior probabilities and equal misclassification costs were specified. FACT-style direct stopping with fraction of object set to 0.08 was selected as the stopping rule. This model attained the overall classification accuracy of 75% and had 12 splits and 13 leaf (terminal) nodes. Models that were using equal prior probabilities and equal misclassification costs but different stopping rule obtained the second best result in overall classification accuracy with discriminant-based

univariate split selection method. These models obtained overall classification accuracy of 60% (0–80%, 1–40%) when using as a stopping rule prune on deviance (minimum  $n = 5$ , standard error rule = 1) or prune on misclassification error (minimum  $n = 5$ , standard error rule = 1) with the specified parameters.

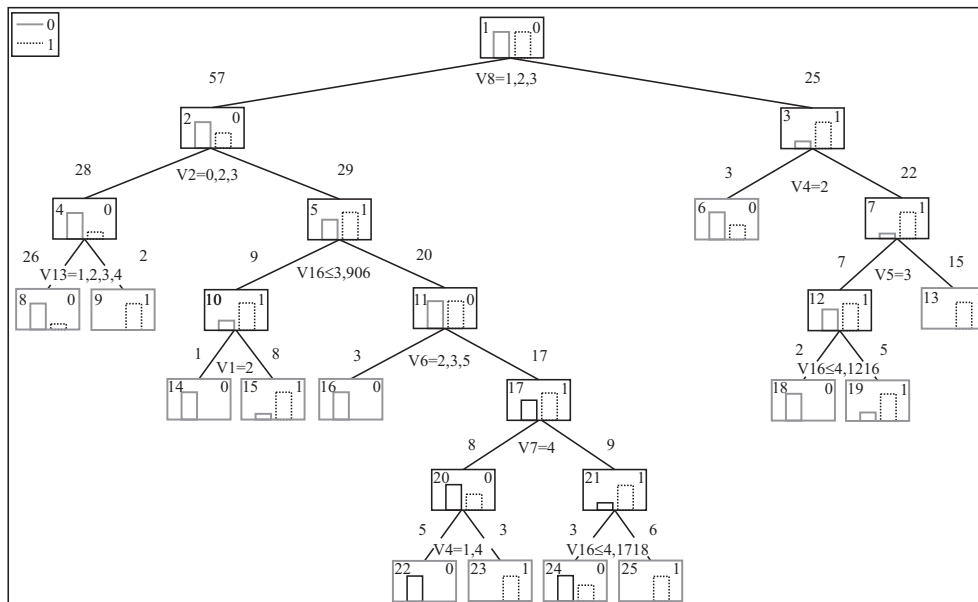

Figure 1. Graphical representation of the classification tree obtained by the discriminant-based univariate splits method and FACT-style stopping rule.

Figure 1 represents classification tree diagram of the classification tree with the highest overall classification accuracy. In this representation, each decision node consists of a node number that is given in the top left corner, assigned node category in the top right corner and histograms of cases in each class at node. On left and right branch from the node, number of cases sent to the child node are given while below the node information about split condition can be found (StatSoft, 2015). Cases who satisfied the split condition were sent to child node on left branch and those who did not satisfy it were sent to child node on right branch. It is noticeable from the diagram that 82 students were preliminary assigned to the root node (node 1) and into category 0. After the first split (variable V8 was selected as split variable) 25 students were preliminary denoted as the ones with a higher level of motivation for mathematics (category 1) and were sent to the right child node (node 3). They did not satisfy the split condition because they estimated that they very often or always use ICT in communication with their teachers. Remaining 57 students that satisfied split condition (sometimes, rarely or never use ICT in communication with their teachers) were sent to the left child node (node 2) and they were preliminary denoted as the ones with the lower level of motivation for

maths (category 0). The splitting procedure continued on both of the child nodes until all terminal nodes were reached.

From the graphical representation of this classification tree model, several interesting paths from the root node were identified in prediction of students with a lower level of motivation for mathematics. Students who estimated that they never, rarely or sometimes use ICT in communication with their teachers (V8), who monthly never, sometimes or very often use ICT (V2) and do not strongly agree with the statement that ICT in mathematics teaching should be used for clarification of basic mathematic concepts (V13) were identified as those with a lower level of motivation for mathematics. Students who estimated that they never, rarely or sometimes use ICT in communication with their teachers (V8), monthly used ICT rarely or always (V2) and had the mean of all items in Facebook Intensity scale (V16) greater than 3.906 but who rarely, sometimes or always use ICT for obtaining learning materials (V6) were also categorized as students with a lower level of motivation for mathematics. Those who estimated that they never, rarely or sometimes use ICT in communication with their teachers (V8), monthly used ICT rarely or always (V2), whose mean of all items in Facebook Intensity scale (V16) was greater than 3.906, never or very often used ICT for obtaining learning materials (V6), very often used ICT for communication with colleagues (V7) and used ICT for entertainment or research (V4) were categorized in category 0 as well. Additionally, this category also contains students who never, rarely or sometimes use ICT in communication with their teachers (V8), monthly used ICT rarely or always (V2), whose mean of all items in Facebook Intensity scale (V16) was greater than 3.906, never or very often used ICT for obtaining learning materials (V6), do not use ICT for communication with colleagues (V7) very often but have the mean of FI item (V16) score lower or equal to 4.1718. As the ones with a lower level of motivation for mathematics were also identified students who use ICT in communication with their teachers (V8) very often or always but most commonly use ICT for some informing (V4). Those students who use ICT in communication with their teachers (V8) very often or always, generally use ICT for other purposes (not informing) (V4), self-evaluated their ICT literacy (V5) as average but have the mean of FI item (V16) score lower or equal to 4.1216, were also labelled as students with a lower level of motivation for mathematics.

Because of the complex graphical representation of the classification tree (12 splits, 13 terminal nodes) this tree structure is also presented in Table 2. When observing only the terminal nodes denoted to the class 0 (nodes 8, 14, 16, 22, 24, 6, 18) it can be concluded that 39 students were correctly classified as the ones with the lower level of motivation for mathematics while 4 students were misclassified in this category (2 cases were misclassified in node 8, 1 case in node 24 and 1 case in node 6).

Table 2. Tree structure of the best classification tree obtained by the discriminant-based univariate splits method and FACT-style stopping rule.

Node	Left branch	Right branch	$n$ in class 0	$n$ in class 1	Predicted class
1	2	3	41	41	0
2	4	5	36	21	0
3	6	7	5	20	1
4	8	9	24	4	0
5	10	11	12	17	1
6			2	1	0
7	12	13	3	19	1
8			24	2	0
9			0	2	1
10	14	15	2	7	1
11	16	17	10	10	0
12	18	19	3	4	1
13			0	15	1
14			1	0	0
15			1	7	1
16			3	0	0
17	20	21	7	10	1
18			2	0	0
19			1	4	1
20	22	23	5	3	0
21	24	25	2	7	1
22			5	0	0
23			0	3	1
24			2	1	0
25			0	6	1

From the results given in the Table 3 it can be noticed that both split selection methods were more successful in detection of students with a lower level of students' motivation for mathematics than in detection of students with higher level.

Table 3. The best results obtained by used split selection methods.

Split selection method	Stopping rule	Prior probabilities	Classification rate	
			0	1
Discriminant-based univariate splits.	FACT	Equal	80%	70%
CART	FACT	Equal	80%	50%

Table 4. The contingency table for McNemar's test.

Discriminant-based univariate splits vs. CART		CART	
		0	1
Discriminant-based univariate splits	0	10	1
	1	6	3

McNemar's test was used to compare the performance of these two split selection methods (see Table 4) and it suggests ( $\chi^2 = 3.57$ ) that there is no statistically significant difference in classifiers performance at the level of significance 0.05.

In order to attain more insight into models classification potential, false positive rate (type I error), sensitivity (Sn), false negative rate (type II error) and specificity (Sp) measures for the best obtained models by two split selection methods were calculated. As explained in Rokach and Maimon (2015) sensitivity measures models ability to identify positive samples and is represented by the equation:

$$Sn = \frac{\text{number of true positive samples}}{\text{number of positive samples}} \quad (2)$$

while the specificity measures models ability to identify negative samples and is represented by equation:

$$Sp = \frac{\text{number of true negative samples}}{\text{number of negative samples}} \quad (3)$$

False negative rate (type II error = 0.3) of the model with the highest classification accuracy is greater than the false positive rate (type I error = 0.2) which suggest that model tends to misclassify more students whose level of motivation for mathematics is higher with the ones with a lower level of motivation for mathematics. Both values (type I. and II. error) are low (see Table 5). This model is sensitive 70% in detecting students with a higher level of students' motivation for mathematics. The specificity of the same model is 0.8, which means that the model will not falsely detect students with a lower level of motivation for mathematics as the ones with a higher level of motivation in 80% of the cases.

Table 5. Type I and II errors for models.

	Discriminant-based univariate splits		CART	
	1	0	1	0
1	0.7	0.2	0.5	0.2
0	0.3	0.8	0.5	0.8

3D histogram given in Figure 2 is used to illustrate which terminal node of the best classification tree classifies most of the cases in the category of the students with a lower or higher level of motivation for mathematics. It is visible that node 13 classifies most of the cases in the category of students with a higher level of students' motivation, while node 8 mostly classifies cases in category of students with a lower level of students' motivation.

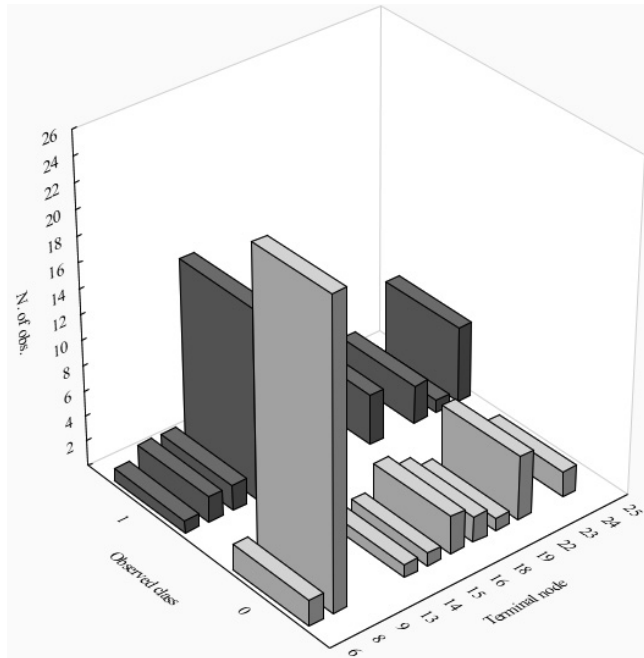
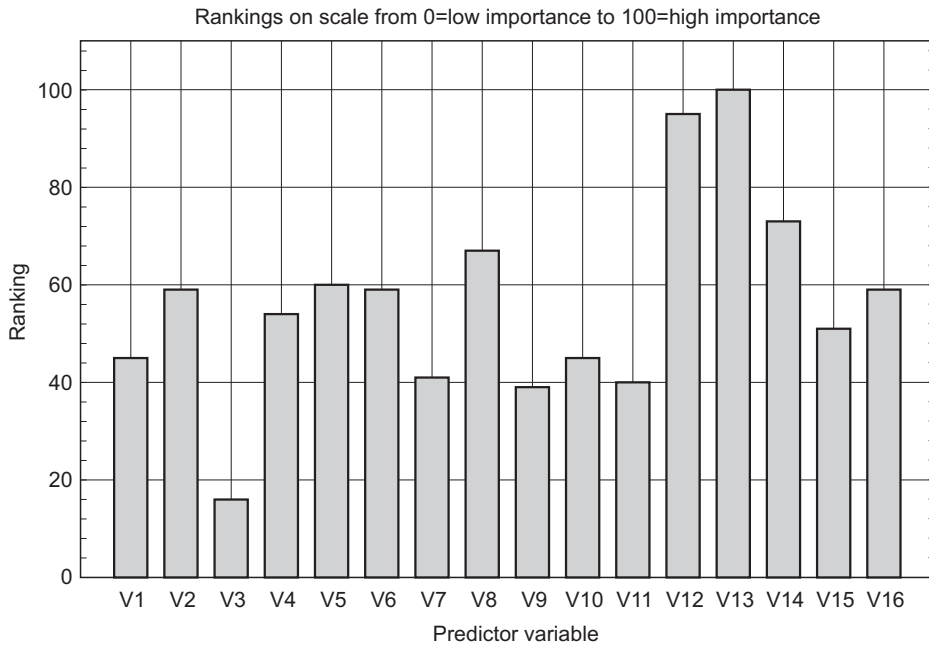

Figure 2. Graphical representation of classification for observed class by each node.

A bar chart of the rankings for each predictor variable is presented in Figure 3. The predictor variable importance is calculated by summing the drop in node impurity all over tree nodes and expressing these sums relative to the largest sum found over all predictors which is different from some other programs where variable importance is viewed solely in the context of the split variable (StatSoft, 2015). Therefore, it is possible that some variables that show large drop values over many nodes are not chosen as split variables (StatSoft, 2015). As it shows, variable V13 (agreement with the statement that ICT in mathematics teaching should be used for clarification of basic mathematics concepts) is the predictor variable with the highest importance. That is, this variable has the greatest effect on the outcome in this classification tree. The students' estimated daily ICT use is the lowest ranged variable.



*Figure 3.* Predictor variable importance rankings of the best discriminant-based univariate split model.

## 5. Conclusion

The obtained results suggest that classification trees can be used for predicting students' level of motivation for mathematics. Based on students' estimations of their ICT use and their attitudes towards ICT use in mathematics teaching, successful classification tree with overall classification accuracy of 75% for classifying students according to their level of motivation for mathematics was created. Classification trees with two different split selection methods were trained and tested and the models with the highest results gained by these methods were compared. McNemar's test showed that there is no statistically significant difference at 5% level between models performance ( $\chi^2 = 3.57$ ). Regardless of which split selection method was used in classification trees, trees were more efficient in detecting students with a lower level of motivation for mathematics. The overall highest classification accuracy of 75% was achieved by classification tree with discriminant-based univariate splits algorithm and the process of achieving classification in this classification tree was presented. This model had lower false positive rate (20%) than false negative rate (30%) which suggests that the model tends to incorrectly classify more students with higher level of motivation for mathematics. Based on the MSLQ scale results the number of students with lower level of motivation and students with higher level of motivation for mathematics in sample was equal. That is, 50% of the participants were categorized into the category with the ones with the lower level of motivation for mathematics. Because of the stated results, the

model is more acceptable for detection of students with a lower level of motivation for mathematics. The results suggest that predicting variables with the highest impact on the classification tree performance are mostly from the set of variables related to students' expectations and attitudes about whether ICT should be used in mathematics teaching.

The findings from this research can be used as suggestions on how to promptly detect students with insufficient or lower motivation for mathematics in class. Moreover, the results encourage educators to use ICT in mathematics teaching and suggest that it is advisable to bring into focus students' expectations concerning ICT use in teaching.

Sample selection and a rather small amount of prediction variables are the notable limitations of this study. In order to obtain generalization, these limitations could be overcome in future research by expanding the sample and including students of other study years as well as students of some other levels of education (primary or secondary). In addition, different data mining techniques could be used in order to achieve even better overall classification accuracy and to identify factors that have an effect on students' motivation for mathematics.

## References

- [1] ANDREI, C., IZABELA, V. P., & VALENTINA, Z. (2014), *Comparative Study between Study Tracks: Math and Sciences or Humanities, Regarding Academic Motivation and Learning Strategies in the 9th Grade Students*, *Procedia-Social and Behavioral Sciences*, 128, 432–437.
- [2] BAKAR, K. A., AYUB, A. F. M., LUAN, W. S., & TARMIZI, R. A. (2010), *Exploring secondary school students' motivation using technologies in teaching and learning mathematics*, *Procedia-Social and Behavioral Sciences*, 2 (2), 4650–4654.
- [3] COCEA, M. AND WEIBELZAHN, S. (2007), *Eliciting motivation knowledge from log files towards motivation diagnosis for Adaptive Systems*, In *User Modeling 2007* (pp. 197–206), Springer Berlin Heidelberg.
- [4] DEJAEGER, K., GOETHALS, F., GIANGRECO, A., MOLA, L., & BAESSENS, B. (2012), *Gaining insight into student satisfaction using comprehensible data mining techniques*, *European Journal of Operational Research*, 218 (2), 548–562.
- [5] ELLISON, N. B., STEINFELD, C., & LAMPE, C. (2007), *The benefits of Facebook "friends:" Social capital and college students' use of online social network sites*, *Journal of Computer-Mediated Communication*, 12 (4), 1143–1168.
- [6] GASCO, J., GOÑI, A., & VILLARROEL, J. D. (2014), *Sex Differences in Mathematics Motivation in 8th and 9th Grade*, *Procedia-Social and Behavioral Sciences*, 116, 1026–1031.
- [7] GITHUA, B. N., AND MWANGI, J. G. (2003), *Students' mathematics self-concept and motivation to learn mathematics: relationship and gender differences among Kenya's secondary-school students in Nairobi and Rift Valley provinces*, *International Journal of Educational Development*, 23 (5), 487–499.



- [8] GORUNESCU, F. (2011, January), *Data Mining Techniques and Models*, In Data Mining (pp. 185–317), Springer Berlin Heidelberg.
- [9] HERSHKOVITZ, A. AND NACHMIAS, R. (2010), *Log-based assessment of motivation in online learning*, Handbook of Educational Data Mining, 287.
- [10] KARADENIZ, S., BUYUKOZTURK, S., AKGUN, O. E., CAKMAK, E. K., & DEMIREL, F. (2008), *The Turkish Adaptation Study of Motivated Strategies for Learning Questionnaire (MSLQ) for 12–18 Year Old Children: Results of Confirmatory Factor Analysis*, Online Submission, 7 (4).
- [11] KEBRITCHI, M., HIRUMI, A., & BAI, H. (2010), *The effects of modern mathematics computer games on mathematics achievement and class motivation*, Computers & education, 55 (2), 427–443.
- [12] LAPOINTE, J. M., LEGAULT, F., & BATISTE, S. J. (2005), *Teacher interpersonal behavior and adolescents' motivation in mathematics: A comparison of learning disabled, average, and talented students*, International Journal of Educational Research, 43 (1), 39–54.
- [13] MAIMON, O., & ROKACH, L. (2005), *Classification trees, Data mining and knowledge discovery handbook* (Vol. 2), Maimon, O., & Rokach, L. (Eds.), New York: Springer.
- [14] MISTIKOGLU, G., GEREK, I. H., ERDIS, E., USMEN, P. M., CAKAN, H., & KAZAN, E. E. (2015), *Decision tree analysis of construction fall accidents involving roofers*, Expert Systems with Applications, 42 (4), 2256–2263.
- [15] MOENIKIA, M., & ZAHED-BABELAN, A. (2010), *A study of simple and multiple relations between mathematics attitude, academic motivation and intelligence quotient with mathematics achievement*, Procedia-Social and Behavioral Sciences, 2 (2), 1537–1542.
- [16] PINTRICH, P. R., SMITH, D. A., GARCÍA, T., & MCKEACHIE, W. J. (1993), *Reliability and predictive validity of the Motivated Strategies for Learning Questionnaire (MSLQ)*, Educational and psychological measurement, 53 (3), 801–813.
- [17] PINTRICH, P. R. et al. (1991), *A manual for the use of the Motivated Strategies for Learning Questionnaire (MSLQ)*.
- [18] QUESTIER, F., PUT, R., COOMANS, D., WALCZAK, B., & VANDER HEYDEN, Y. (2005), *The use of CART and multivariate regression trees for supervised and unsupervised feature selection*, Chemometrics and Intelligent Laboratory Systems, 76 (1), 45–54.
- [19] ROBOTHAM, H., CASTILLO, J., BOSCH, P., & PEREZ-KALLENS, J. (2011), *A comparison of multi-class support vector machine and classification tree methods for hydroacoustic classification of fish-schools in Chile*, Fisheries Research, 111 (3), 170–176.
- [20] ROKACH, L., MAIMON, O. (2015), *Data mining with decision trees: theory and applications*, World scientific. 2<sup>nd</sup> ed., Singapore.
- [21] StatSoft, How To Predict Membership, Classification Trees, <http://www.statsoft.com/Textbook/Classification-Trees>, [Accessed on 14 May 2015].
- [22] StatSoft, Predictor Importance in STATISTICA GC&RT, Interactive Trees, and Boosted Trees, <http://documentation.statsoft.com/STATISTICAHelp.aspx?path=Gxx/Gcrt/Overviews/PredictorImportanceinSTATISTICAGCRTInteractiveTreesandBoostedTrees> [Accessed on 14 May 2015].

- [23] SUÁREZ-ÁLVAREZ, J., FERNÁNDEZ-ALONSO, R., & MUÑIZ, J. (2014), *Self-concept, motivation, expectations, and socioeconomic level as predictors of academic performance in mathematics*, Learning and Individual Differences, 30, 118–123.
- [24] WANG, X., LIU, X., PEDRYCZ, W., & ZHANG, L. (2015), *Fuzzy rule based decision trees*, Pattern Recognition, 48 (1), 50–59.
- [25] YAVUZ, G., OZYILDIRIM, F., & DOGAN, N. (2012), *Mathematics motivation scale: a validity and reliability*, Procedia-Social and Behavioral Sciences, 46, 1633–1638.

*Contact addresses:*

Ivana Đurđević Babić  
Faculty of Education  
Josip Juraj Strossmayer University of Osijek  
Cara Hadrijana 10, Croatia  
e-mail: idjurdjevic@foozos.hr

Anita Marjanović  
Faculty of Education  
Josip Juraj Strossmayer University of Osijek  
Cara Hadrijana 10, Croatia  
e-mail: amarjanovic@foozos.hr

## **Stabla odlučivanja u otkrivanju motivacije studenata za učenje matematike iz njihovog korištenja IKT i Facebooka**

---

---

Ivana Đurđević Babić i Anita Marjanović

Fakultet za odgojne i obrazovne znanosti, Sveučilište Josipa Jurja Strossmayera u Osijeku, Hrvatska

*Sažetak.* Prethodna istraživanja su pokazala da je motivacija za učenje matematike važan faktor kod aktivnog angažmana studenata u procesu učenja i kod razine uspješnosti studenata u matematičkim kolegijima. Svrha ovog rada je predstaviti potencijal stabala odlučivanja u otkrivanju motivacije studenata za učenje matematike. Nadalje, cilj je bio izgraditi model stabla odlučivanja koji će biti efikasan u otkrivanju studenata s nižim stupnjem motivacije za učenje matematike. Model stabla odlučivanja temeljen je na percepciji studenata o njihovom korištenju IKT i društvene mreže Facebook. Za određivanje stupnja motivacije studenata za učenje matematike koristila se skala Motivated Strategies for Learning Questionnaire (MSLQ) (Pintrich et al., 1991), a skala Facebook Intensity (FI) (Ellison et al., 2007) koristila se za mjerenje upotrebe društvene mreže Facebooka. U ovom istraživanju sudjelovali su studenti treće godine Fakulteta za odgojne i obrazovne znanosti. Rezultati su ukazali na veliki potencijal modela stabla odlučivanja kao sredstva za detekciju motivacije studenata za učenje matematike s obzirom da je najbolji model stabla odlučivanja postigao točnost od 80% u detekciji studenata s nižim stupnjem motivacije za učenje matematike.

*Ključne riječi:* stabla odlučivanja, motivacija za učenje matematike, upotreba IKT, upotreba Facebooka, stavovi studenata

# Using Moodle in teaching mathematics in Croatian education system

---

---

Josipa Matotek

Faculty of Civil Engineering, Josip Juraj Strossmayer University of Osijek, Croatia

*Abstract.* Moodle (**Modular Object-Oriented Dynamic Learning Environment**) is an open-source computer system for creating online courses (Macmillan Dictionary). This is a Learning Management System for online or hybrid teaching and learning. In this article it will be presented how Croatian educators use Moodle in teaching mathematics through examples from successful practice at all levels of education.

The purpose of this article is to show a large range of options offered by Moodle to make teaching of mathematics innovating, more interactive and interesting; to find out the most commonly used tools in math courses and to present the results obtained from a questionnaire conducted among teachers who have Moodle courses. The author also analyses different type of performance of courses, reasons for using a certain course and both students' and teachers' satisfaction with the courses.

*Keywords:* Moodle, teaching mathematics, education, distance learning, on-line quiz

## 1. Introduction – about Moodle

Today, in time of fast technological progress it is very important to introduce changes in the educational process. One of the many ways in which we can achieve that is the creation and use of courses in Moodle. Moodle (**Modular Object-Oriented Dynamic Learning Environment**) is one of the Learning Management System (LMS) for online or hybrid learning. This is a free tool for making digital learning materials and teaching. This is very popular LMS because, except it is free, it is easily accessible, reliable and intuitive to use in many different options. Flexible environment conducive to the students' active participation in the learning process is opposed to passive role, which they often have in our standard education system. Moodle is an open source learning platform which means that it is allowed

to change and adapt the source code. The other benefits of Moodle are unlimited numbers of courses and simultaneous operation of a large number of users. The first version of Moodle was released on 2002. The creator of this LMS was Martin Dougiamas, born 1964 in Australia. There is a very interesting story about his childhood which had a great influence on him. He was the only non-Aboriginal child in the village and he accomplished his primary school education through an old form of distance learning using radio waves. Every few weeks, he would receive all needed teaching materials by plane from the school 1000 km away from his home. Later, when he was studying at the university, he came across LMS (WebCT), but he was frustrated with its many limitations. Then he started to use Moodle as a PHD student of Computer Science and Education. Until today, Moodle has been constantly developing (its design and development is guided by a social constructionist pedagogy) and it has adopted many e-learning standards. Moodle is designed to support teaching and learning. It ranks first place on the list of the 20 most popular LMS according to Capterra. So far Moodle has been used in more than 220 states, with almost 70 000 000 users, and it has been translated into hundreds of languages. In Croatia, there are almost 140 registered sites. All information in this article were collected only from CARNet (Croatian Academic and Research Network) installation of Moodle, named Loomen which has almost 4500 courses with over 87 100 users at all educational levels in Croatia. It should be noted that some other sites were inaccessible to the author of this article and therefore they were not included in this analysis; this is particularly true for courses at some universities and faculties. CARNet provides Moodle services, free of charge, to all education institution in Croatia. To log into the Loomen system, one requires only AAI (authentication and authorization identity) which have all students and all teachers in the entire education system.

This article also tries to explore how Moodle can be integrated into teaching mathematics. A system that allows simple construction of mathematical formulas is another important issue. Moodle provides text editor with math notation, Dragmath. There are different Maths' modules. Probably one of the most useful Math's module is one which enables using Tex in Moodle. There is, a module that allows the incorporation of GeoGebra activities in Moodle and the users can save the state of the activities to continue them later. It allows embedding easily GeoGebra activities in Moodle course. Furthermore, WIRIS Plugin is the component connecting a Moodle server with the different WIRIS tools in order to create and edit mathematical formulas, calculations, plots and quizzes.

Moodle provides a whole range of activities, resources and collaboration tools. The purpose of this article is to show many options offered by Moodle to make teaching and learning of mathematics innovating, more interactive and interesting. The article also points out the most commonly used tools in mathematics courses and presents the results obtained from a questionnaire conducted among teachers who have Moodle courses. Furthermore, different types of performance of Moodle courses, reasons for using certain courses and both students' and teachers' satisfactions with the courses are described in this paper.

## 2. Literature review and examples from practice

Many articles about different aspects of using technology, especially LMS, in educational processes can be found in literature.

According to the case study conducted on University of Borås, Sweden, tools intended to enhance the learning experience by facilitating collaboration and the creation of communities of learners, are sparingly used. The lecturer's choices of tools suggest a strong resistance to changing their teaching practices, due to the lecturer's focus on the subject specific content of the courses they teach. (Jurado and Petterson, 2012)

An exploratory study about using Moodle as a support tool for teaching in higher education in Portugal led to similar findings. Most teachers used Moodle as a content repository, the most used resources were link to a file or website and compose a text page, the main used activities were assignments and, to a lesser degree, forums. They concluded that most of teachers did not change their pedagogical practice as a consequence of using Moodle and those who claimed to have changed their practice, had received internal training. (Fidalgo et al., 2012).

Blanco, M. and Ginovart, M. (2009) presented their project about Moodle quizzes for assessing statistical topics in engineering studies. They concluded that these quizzes were certainly useful to promote student involvement in mathematical subjects.

There are also some very good examples of using Moodle as a support tool for teaching in Croatia.

One of them is a combined course "Matka za bistro glavice" (Čuvidić, 2014), which is used as additional material for the work with gifted children from the first to fourth class of primary school. This course allows every student to progress at his/her own pace and to solve task he/she wants according to their skills and level of mathematical knowledge. Later in the classroom, children can be helped with tasks with most common mistakes. These mistakes are easy to notice since Moodle automatically controls solved tasks. The most widely used activity was the Hot Potatoes test or some other games like Sudoku and Millionaire with math tasks. Resources providing presentations and explanations are just different Word or Power Point Presentation documents.

For last several years there has been organized so called "Small math school" at the Faculty of Educational Sciences in Osijek, which is intended for fourth-grade primary school students with a special interests in mathematics. Its goal is to raise the quality of education and to improve better communication among users. Pavleković et al. (2010) point out some of the Moodle advantages: ability to access activities and materials from anywhere there is an internet, the possibility of using different tools, creating easier and faster assessment quizzes, encouraging students to cooperate, or checking newly acquired knowledge.

Another successful project of implementing Moodle in the learning process was the "Week without books" (Petković, 2012) for fourth-grade primary school

students. During one week teaching was conducted according to the school curriculum, but without textbooks. When it came to math classes, the week's topic was radius of rectangles and squares and pupils needed just their notebooks and geometry set tools. They used Moodle for math activity games crosswords, tests and quizzes. They used embedded video on a Moodle page for presenting new material to pupils.

The next two courses, named "E-classroom Math 8" and "E-classroom Math 6", were used in the sixth and eighth grade of primary school (Belavić, 2012). These were excellent examples of combining GeoGebra and Moodle. The course included the online textbook, some video lessons, books and documents, but the real value of the courses was the use of GeoGebra. The students got their homework in GeoGebra and later on received comments regarding the homework. For this purpose they used communication tool forums and activity assignment. The courses also contained glossary and test.

Njerš M. created 2012 "Series" course intended for the fourth grade of grammar schools. The resource book was used for introducing and teaching the new lessons, as well as for knowledge evaluation and activity assignments.

The example of using Moodle at university level was the course called "Mathematics for Engineers" (Matotek et al., 2012), which has already been used four years in a row with continuous improvement and enrichment of new activities and contents. The course has been used to download teaching materials, using pdf documents, links to external contents and resource books. In addition to the forum, which has aimed at improving communication, the course also has intended to achieve collaboration using a tool wiki. Students have been invited to create a wiki adding examples of the use of differential equations and for this activity they are rewarded with bonus points in the colloquium.

Course Mathematics 2 was awarded for the best e-course at the University of Zagreb in the academic year 2008/09<sup>th</sup>. Divjak, B. et al. (2010) investigated in correlation between students' usage of Moodle and passing their exams successfully.

Despite many good examples we have to enumerate some disadvantages of this teaching method: the lack of IT equipment at schools, the lack of professionals and support for the development of such content, as well as insufficient education of teachers. Therefore, such work has not yet been the rule but rather an exception, carried out by enthusiasts, except in some faculties, where the use of Moodle is required.

### 3. Methodology

We conducted an online questionnaire in Moodle, and send messages in the system to all teachers who organized Loomen courses. The data were collected in March 2015. The survey was voluntary and anonymous. It was intended to find out the reasons for using Moodle, how both the teachers and their students were satisfied

with the role of Moodle as a support tool in the learning process. Any kind of teachers' feedback is important because some advantages of using Moodle, as well as its possible shortcomings can consequently lead to a great help to its future users.

### 3.1. Questionnaire

Before sending a questionnaire to teachers, we tried to find out the exact number of math teachers involved in the CARNet Moodle system named Loomen and the number of active courses. But, since Loomen courses are sorted only by the name of educational institution, there is no exact overview of mathematical courses. Using method of ordinary counting from the list of all available courses, it has been found out that the total number of mathematical courses is 161, which is only 3.63% of the all organized courses. Math courses can be recognized by their names because most courses are closed to the public. Figure 1 shows the distribution of mathematical courses at different levels of education. According to this figure, it can be concluded that most courses have been organized in secondary schools. On the other hand, it should be emphasized that it is the total number of the Loomen system courses, and it does not necessarily mean that all these courses are currently active, or that they have ever been. Unfortunately, there is currently no better way to enquire into this.

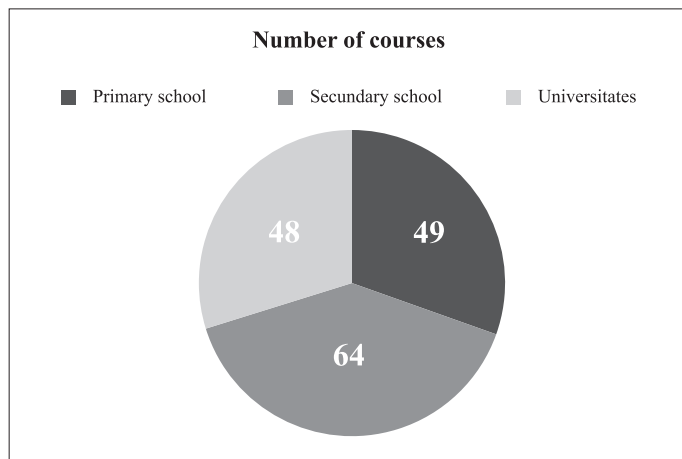

Figure 1. Number of mathematical Loomen courses.

### 3.2. Results and discussion

There were altogether 105 collected surveys in total. 12 of all the involved teachers (11.43%) teach math at all levels of education, from primary school to university level. According to Croatian Central Bureau of Statistics [14, p. 150], the ratio of women employees to men employees in education system is 77% versus 23%. As



expected, a similar ratio is maintained among the surveyed math teachers: 75% of women versus 25% of men.

Despite the general opinion that the integration of the information and communication technologies (ICT) into teaching is favored by the younger generation, in practice many opposite examples can be objected. The information found in the literature sources also (Đeri et al. 2013) confirms the fact that the teacher's age does not affect his/her attitude toward using computer technology in teaching. Figure 2 shows the distribution of math teachers using Moodle by years of work experience, the data were collected in our questionnaire. The average length of work experience of teachers' using Moodle is 22.92 years.

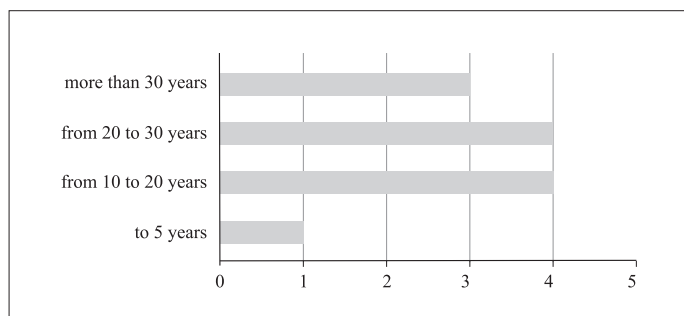

Figure 2. Work experience of math teachers.

### 3.2.1. Types of performance of courses in the Moodle system

There were many different reasons for integrating courses into teaching process. The reasons marked by the majority of respondents were modernization of teaching, increase of students' motivation and facilitation of student learning process. The often selected motives, but in a slightly smaller percentage, were curiosity and desire to try something new, improvement of their teaching competencies and communication skills. Some of the users had to introduce Moodle courses following the orders of their superiors, but this reason is specific only for some faculties where all subjects must have courses.

After general questions that were excluded from further analysis the respondents who did not use their course in practice with students, such was 16% (exact percentage in group of all courses and group of only math courses). Considering the type of performance of Moodle course, only about 20% of courses were exclusively online and students used them independently, without additional mentoring. Even 80% courses were combined courses whose content accompanied the teaching materials. Table 1 presents the exact distribution and almost the same percentage in both, group of all courses and math courses was noticed.

60% of math courses followed a specific teaching unit and the duration of the course was limited by the duration of the unit, while 40% of courses were organized throughout the entire school year. 60% of teachers re-organized the same

course with the second-generation students, in average 3.6 times. Although this percentage seemed to be significant, when it came to data about all courses, this percentage was even higher – up to 85%. This could have been explained by the higher number of respondents who worked at universities in the group of all courses (39%, as opposed to only 10% of math teachers at universities), because they had the opportunity to repeat the course year after year unlike math teachers at schools who usually could not do that.

Table 1. Types of performance of Moodle courses.

	in math courses	in all courses
exclusively online courses independently used by students, without additional mentoring	2 (20%)	16 (18%)
combined courses with the contents accompanying teaching materials that students used at home with the support of a mentor-teacher	3 (30%)	26 (30%)
combined courses with the contents accompanying teaching materials that students used at home with the support of a mentor-teacher or/and during their classes	5 (50%)	44 (50%)
none of the above	0	2 (2%)

### 3.2.2. Reasons for using Moodle courses

Motives for using Moodle differed since Moodle could be used for various purposes (see Figure 3). A significant difference could have been seen in the case of downloading of working materials, such as presentations, documentations, links, etc. (repository of working materials). This difference, similarly as explained above, did not arise from a variety of course contents, but it could be explained by the working place of teachers in two observed groups (whether they work at primary, secondary or tertiary level of education).

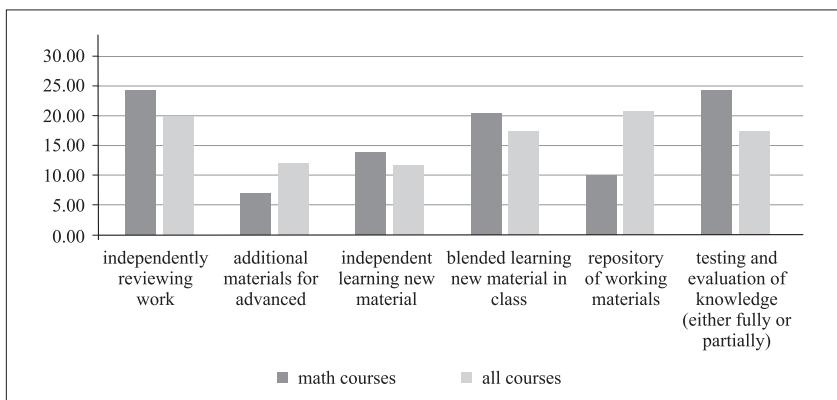

Figure 3. Reasons for using Moodle courses (the results are displayed in percentages).

### 3.2.3. Analysis of activities, resources and tools

A questionnaire survey was conducted to rate utility of different activities and resources as well as communication and collaboration tools. They were offered 19 most popular ones (in the opinion of the author). Teachers were supposed to evaluate only those that had been used in their courses. Mark 1 meant “does not consider useful”, and mark 5 meant “finds very useful”.

Table 2 shows results for some best rated and most used activities. The obtained results present percentage of teachers who used certain activity as well as the average grade gained for particular activity. The biggest differences can be noticed in GeoGebra, Games and Hot Potatoes test. It is clear that mathematical tool GeoGebra was used more often in mathematical courses than in other courses and thereby got better grades. Games and Hot Potatoes test activities were more suitable for younger students. There was much higher ratio of primary school teachers teaching math courses in comparison to university teachers and that was the reason how could be explained difference between number of users of certain activities and assessment of their usefulness. The other activities had very similar average grade in both groups.

Table 2. Rate of utility of Moodle activity.

	math courses		all courses	
	percentage of using the activity	average grade	percentage of using the activity	average grade
Forum	100%	4.2	79.55%	4.1
GeoGebra	50%	4.2	23.86%	3.4
Games	80%	4.75	55.68%	3.8
Hot Potatoes test	70%	4.71	51.14%	4
Test	100%	4.5	86.36%	4.6
Quiz	60%	4.33	61.36%	4.1
File	100%	4.6	92.05%	4.8
URL	90%	4.9	77.27%	4.7

### 3.2.4. Satisfaction with the course

Figure 4 indicates that the teachers were very satisfied with using Moodle courses and with the results and achievement of the set goals. The numbers represent average grade, where mark 1 means “not at all satisfied”, and mark 5 means “totally satisfied”. The teachers were asked to evaluate, in their opinion, the impact of the course on their students. Their responses can be seen in Figure 4 (third and fourth answer). Their students also expressed satisfaction over these changes in teaching, they were more interested in studying and problem solving.

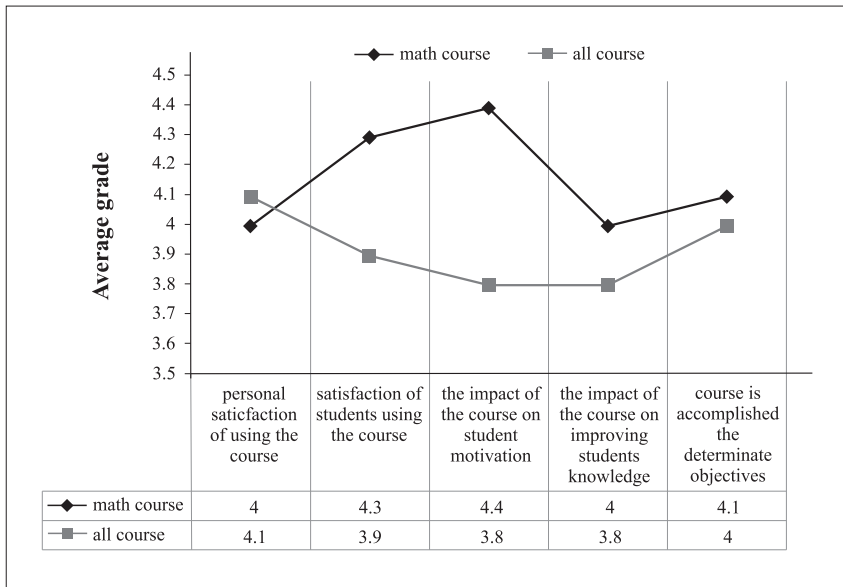

Figure 4. Satisfaction with the course in teachers' opinion.

The outcome is similar in both groups; the biggest difference can be seen in the evaluation of the course impact on student's motivation. In literature it can be found that in lower grades of elementary school the impact on motivation is highlighted (Petković, 2012), (Čuvidić, 2014) whereas it decreases at higher levels (Belavić, 2012). Furthermore, at the author's university course, the author observed significantly reduced motivation in tasks which had not been preannounced to be evaluated. It indicates that students were not sufficiently motivated for the activity itself, unless it was further evaluated. From the presented references to impose the view that the impact of the course on students' motivation decreases with level of education. Recall, it is the higher proportion of respondents who work in universities in the group of all courses (39%), as opposed to only 10% math teacher at universities. All of these could explain the maximum difference in the average grades of the impact of the course on the students' motivation in both groups of observed courses. But for more serious conclusion about the course impact on the students' motivation depending on their level of education, (i.e. ages) requires further, more detailed analysis.

#### 4. Conclusion

Based on the observed examples, the research and study of available courses, it can be concluded that in fact only few math teachers use Moodle courses (mostly combined form of courses) in creating their classes. However, those few teachers and their students have enjoyed working with Moodle. Students could easily manage the interface and Moodle has even been successfully used at lower levels of the

education system. The information is transmitted quickly and is accessible at any time.

Reviews of math teachers those using Moodle in teaching coincides almost in all aspects with opinions of all the other teachers those responded to the survey.

Moodle abounds in various activities and resources which can enrich the course content. For instance, forum improves the communication between teachers and students, and among students themselves. Also using this communication tool they can learn from each other. It was noted that collaborative tools (wiki, blog, and glossary) are not so popular among the students nor the teachers. Very popular activities are various activities for assessment such as tests and quizzes. Their benefits are multiple, since they can be used for the evaluation of knowledge, and as tool for reviewing and self-evaluation. Math teachers use the mathematical tool GeoGebra more often than other teachers and consequently they gave it better grades.

The paper presents various aspects of the use of Moodle in teaching and learning mathematics, and it gives a review of the most frequently used and best evaluated activities and resources. In Croatia has just started a major project – e-schools, which will apply to the STEM subjects. It is expected that the Moodle will play a major role and hopefully the results obtained from this article will contribute to more systematic teacher's education and raising awareness of Moodle's widespread use.

The article also shows that some possible further researches should investigate whether there is a connection between the course impact on the student motivation and their age and what kind of connection that could be. Future researches could focus on using only certain resources or activities and on detailed analysis of their implementation. Especially interesting fact could be to investigate the usage of tests or some another activities for evaluation and self-assessments in regard to the use of the standard way of evaluating.

## Acknowledgments

The author would like to gratefully and sincerely thank the teachers Čuvidić, Njerš and Belavić who made their Moodle courses accessible to the author and an anonymous reviewer for his/her comments that have improved this article.

## References

- [1] BELAVIĆ, D. (2012), "Online" učionica, *Miš*, **64** (10), 182–187.
- [2] BLANCO, M. AND GINOVART, M. (2009), *Creating Moodle quizzes for the subjects of mathematics and statistics corresponding to the first years in engineering studies*, EDULEARN09 Proceedings, [https://upcommons.upc.edu/e-prints/bitstream/2117/3064/1/blanco\\_ginovart\\_edulearn09.pdf](https://upcommons.upc.edu/e-prints/bitstream/2117/3064/1/blanco_ginovart_edulearn09.pdf) [Accessed 28/03/2015].
- [3] *CARNet Moodle*, <http://loomen.carnet.hr> [Accessed 26/03/2015].

- [4] ČUVIDIĆ, M. (2014), *E-matematika u razrednoj nastavi*, Šesti kongres nastavnika matematike.
- [5] DIVJAK, B., BRUMEC, M., PEHARDA, P. (2010), *Stavovi prema matematici i korištenju novih tehnologija u nastavnom procesu*, Matematika i e-učenje, zbornik radova, 5–9
- [6] ĐERI, I. AND DOBI BARIŠIĆ, K. AND JUKIĆ MATIĆ, LJ. (2013), *The influence of formal education and personal initiatives on the willingness to use ICT in teaching mathematics*, Mathematics teaching for the future, monography, 261–269.
- [7] FIDALGO, P., PAZ, J. AND SANTOS, F. L. (2012), *Using Moodle as a support tool for teaching in Higher Education in Portugal: an exploratory study*, Eled e-learning and education, **8**, <http://eled.campussource.de/archive/8/3161> [Accessed 26/03/2015].
- [8] JURADO, R. G. AND PETTERSSON, T. (2012), *The use of learning management systems: A Longitudinal Case Study*, Eled e-learning and education, **8**, <http://eled.campussource.de/archive/8/3145> [Accessed 26/03/2015].
- [9] *Macmillan Dictionary*, <http://www.macmillandictionary.com/dictionary/british/moodle> [Accessed 05/05/2015].
- [10] MATOTEK, J. AND JUGO, G. (2012), *Komparativna analiza online i kombiniranog tečaja implementiranih u sustav Moodle*, CUC 2012, Zbornik radova, [http://cuc.carnet.hr/2012/program/zbornik\\_radova](http://cuc.carnet.hr/2012/program/zbornik_radova) [Accessed 27/03/2015].
- [11] *Moodle*, <http://moodle.org> [Accessed 26/03/2015].
- [12] PAVLEKOVIĆ, M., ĐURĐEVIĆ, I. AND PERIĆ, A. (2010), *Matematika i e-učenje*, Zbornik radova, 65–68.
- [13] PETKOVIĆ, D. (2012), *Projekt Tjedan bez knjiga u e-okruženju*, CUC 2012, Zbornik radova, [http://cuc.carnet.hr/2012/program/zbornik\\_radova](http://cuc.carnet.hr/2012/program/zbornik_radova) [Accessed 27/03/2015].
- [14] *Statistički ljetopis Republike Hrvatske 2012.*, Zagreb, Central Bureau of Statistics of the Republic of Croatia, [http://www.dzs.hr/Hrv\\_Eng/ljetopis/2012/sljh2012.pdf](http://www.dzs.hr/Hrv_Eng/ljetopis/2012/sljh2012.pdf) [Accessed 26/03/2015].
- [15] *Top LMS software* (2014), <http://www.capterra.com/learning-management-system-software/#infographic> [Accessed 26/03/2015].

Contact address:

Josipa Matotek  
Faculty of Civil Engineering  
Josip Juraj Strossmayer University of Osijek  
Crkvena 21, Osijek, Croatia  
e-mail: matotek@gfos.hr

## Upotreba Moodle-a u nastavi matematike u hrvatskom obrazovnom sustavu

---

---

Josipa Matotek

Građevinski fakultet, Sveučilište Josipa Jurja Strossmayera u Osijeku, Hrvatska

*Sažetak.* Moodle (**modularno objektno orijentirano dinamičko** okruženje za učenje) je računalni sustav otvorenog koda koji služi za kreiranje online tečajeva (rječnik Macmillan). Moodle je jedan od sustava za upravljanje učenjem (LMS) za udaljeno ili kombinirano učenje. U radu će, kroz uspješne primjere iz prakse na svim stupnjevima obrazovanja, biti prikazano kako nastavnici matematike u Hrvatskoj koriste Moodle u poučavanju.

Cilj rada je pokazati veliku raznolikost opcija koje nudi Moodle te kako te mogućnosti iskoristiti i učiniti nastavu matematike inovativnijom, zanimljivijom i s većim stupnjem interaktivnosti. Također, svrha rada je i istražiti koji su najčešće korišteni alati u matematičkim tečajevima, ali i prezentirati rezultate dobivene upitnikom provedenim među nastavnicima koji imaju Moodle tečajeve. Analizirat će se različite vrste tečajeva s obzirom na njihovo izvođenje, razlozi njihovog uvođenja i korištenja te zadovoljstvo nastavnika i učenika tečajevima.

*Ključne riječi:* Moodle, nastava matematike, obrazovanje, udaljeno učenje, online kviz

# Future teachers' perception on the application of ICT in the process of assessment and feedback

---

---

Karolina Dobi Barišić

Faculty of Education, Josip Juraj Strossmayer University of Osijek, Croatia

*Abstract.* In recent years the quality of education has been the main focus in higher education. Feedback is a key element of formative assessment or even a key part of the overall approach to learning. Information and communication technology enables more effective ways of teaching with frequent formative assessment and timely feedback. The aim of this study is to examine the extent to which the future teachers are familiar with the concepts of summative and formative assessment, and their perception of the role of ICT in these processes, and to what extent, in this context, formative assessment and feedback appear in their current education. Results showed that future teachers are not very well familiar with these concepts, but are mostly satisfied with communication through ICT although in spite of the emphasized deficiencies. Limitations and implications for further research are considered.

*Keywords:* feedback, formative assessment, summative assessment, information and communication technologies, future teachers.

## 1. Introduction

In recent years, great attention is paid to the quality of education, and many agencies, whose primary role is quality assurance in higher education, are established. Standards and Guidelines for Quality Assurance in the European Higher Education Area stated that the assessment of students is one of the most important elements of higher education. Assessment, in addition to certificates of knowledge, also results in valuable information for the institution about the effectiveness of teaching and student support (European Association for Quality Assurance in Higher Education, 2009.). Assessment is an integral part of learning aimed at providing feedback that allows students to monitor their progress and evaluate the effectiveness of their learning strategies (Carless, 2003). Cramp (Cramp, 2011) highlights that feedback



is a key part of the overall approach to learning. Vygotsky emphasizes the importance of feedback within the socio-constructivist theory of learning. Computers are considered as an optimal tool for the application of socio-constructivist principles to instructional practice (Harasim, 2012).

From a theoretical point of view, Sadler has provided a consistent theory of formative assessment and feedback. According to his theory, assessment denotes any appraisal (or judgment, or evaluation) of a student's work or performance. Formative assessment is concerned with how judgments about the quality of student responses (performances, pieces, or works) can be used to shape and improve student's competence. Summative assessment is in contrast with the formative assessment in its concern with summing up or summarizing the achievement status of a student, and is geared towards reporting at the end of a course of study, especially for purposes of certification. Feedback is a key element in formative assessment, and is usually defined in terms of information about how successfully something has been or is being done (Sadler, 1989). The assessment can have a formative role of providing assistance in learning (Boud, 2000). The impact of formative assessment during the process of teaching has a positive impact on students and the teacher (Bell & Cowie, 2001).

Modern technology corresponds to the learning characteristics of a contemporary student (Gilbert, Whitelock, & Gale, 2011), and the Internet offers many different ways to communicate (Wempen, 2014.). Use of technology in teaching enables more effective ways of teaching implying frequent tests of formative assessment with feedback (Gilbert, Whitelock, & Gale, 2011). Online formative assessment is characterized by a diversity of approaches that can improve learning and achievement of learning outcomes (Gikandi, Morrow, & Davis, 2011).

## 2. Literature review

Teachers in different educational cycles are aware of the need to use ICT, but they point out the shortcomings of their formal education, and emphasize a great need for personal initiatives and further education (Đeri, Dobi Barišić, & Jukić Matić, 2013.).

Carol Evans' (Evans, 2013) review on assessment feedback in higher education from 2000 to 2012, provides a timely and thorough critique of the latest developments within the assessment feedback field and encompasses 460 scientific articles, out of which more than 100 focus on e-assessment feedback. According to Evans, e-assessment feedback (EAF) includes formative and summative feedback delivered or conducted through information communication technology of any kind. A key factor in the efficacy of e-feedback technologies is the nature of the interaction between students and their lecturers within the e-assessment feedback process. Advocates of EAF argue that such approaches encourage students to adopt deeper approaches to and greater self-regulation of learning.

A study conducted in England (Taras, 2008) showed that only 28% of surveyed university teachers closely relate formative assessment and feedback, while 40% of them would not even consider the possibility of formative assessment in

the evaluative task. In addition to these results, the overall impression of the whole research is that teachers have poor knowledge of the concepts of summative and formative assessment, as well as their interconnection.

Miller et al. (Miller, Doering, & Scharber, 2010.) encourage teachers and designers to think beyond the use of traditional scoring and textual comments when developing a plan for student feedback. They believe that feedback should exist as evolving communication between teachers and students, as opposed to a disparate instance of notification.

### 3. Sample, data and methodology

Participants in this study are students of the Faculty of Education in Osijek, Croatia. Faculty of Education educates primary education teachers (pupils age 7–10) and early and preschool education teachers. The research involved students of all years of study. Although all students, a total of 716, were invited to participate in the research, only 152 of them decided to join the research. Ultimately 119 students participated in the study all the way through. Table 1 shows the number of participants by gender, study program and year of study. In regard to the study program, 85 participants attend study of teacher education and 34 participants attend early and pre-school education study (both undergraduate and graduate). In regard to the gender, only 2 out of 119 participants are male, whereas the remaining participants are female, which is not unusual considering gender structure of students at the Faculty of Education in Osijek. In regard to the year of study, most participants are second year students.

Hypothesis and research questions are set as follows: (RQ1) “What is the students’ knowledge about the processes of formative and summative assessment, feedback and ICT?”, (RQ2) “What is the situation in regard to the use of ICT for formative purposes at the Faculty of Education in Osijek”, (RQ3) “What is the opinion of students on the use of ICT in teaching context at the Faculty of Education in Osijek?”, H1: “There is a correlation between the knowledge of formative and summative assessment, feedback and ICT and perception of ICT as a means of communication related to teaching”.

*Table 1.* Structure of participants by gender, study program and year of study.

Feature	Category	Frequency	Relative frequency (%)
<i>GENDER</i>	Female	117	98.3
	Male	2	1.7
<i>STUDY PROGRAM</i>	Primary Education Teachers	85	71.4
	Early and preschool education	34	28.6
<i>YEAR OF STUDY</i>	First year	7	5.9
	Second year	81	68.1
	Third year	19	15.9
	Fourth year	4	3.4
	Fifth year	8	6.7

A survey was used to collect data to answer the research questions and verify hypothesis, considering that there are 716 students studying at the Faculty of Education. Although all students received an invitation to participate in research, only 152 of them decided to participate. Only 119 out of 152 participants completed the survey.

The survey instrument was developed by the researcher and is composed of 40 questions. Perception of students on the application of ICT in the process of assessment and feedback is considered from the perspective of: (a) students' perception of their own knowledge about formative and summative assessment, feedback and ICT, (b) applied knowledge about formative assessment, (c) ICT as a means of communication related to teaching and (d) use of specific type of ICT in communication related to teaching. Three initial questions looked for basic personal and professional information, such as student gender, study program they are enrolled in and year of study. Students' perception of their own knowledge about formative and summative assessment, feedback and ICT was examined through 4 questions, such as "Are you familiar with the term formative assessment". Collected responses were stored in the form of ordinal integer variable. Students' perception of their own knowledge was calculated as an average value of observed variables. Applied knowledge about formative assessment was measured through 10 statements, for example "Shapes and enhances learning". If the student identified connection of the statement and formative assessment correctly, the value of the observed variable was marked as 1, otherwise as -1. Applied knowledge about formative assessment was calculated as average value of observed variables. ICT as a means of communication related to teaching included questions about improvement of the quality of teaching, greater use in informatics courses, frequency and connection with instructional tasks. Use of specific type of ICT in communication related to teaching covers communication with other students and instructors relating to teaching. Type of ICT implies the following (Table 2): email, instant messaging, texting, social network, blog, micro blog, wiki, forum, VoIP (Wempen, 2014.).

Table 2. Types of ICT (Wempen, 2014.).

Type of ICT	Explanation
<i>Email</i>	a computer-based system for exchanging messages through mail servers
<i>Instant messaging</i>	sending and receiving short text messages in real-time over the Internet
<i>Texting</i>	sending and receiving short text messages in real-time over a cell phone network
<i>Chat room</i>	an online virtual room in which you can meet and talk to other people
<i>Social network</i>	an Internet-based system that enables users to interact in real-time and by using
<i>Blog</i>	a web page containing the author's personal experiences and opinions
<i>Wiki</i>	an online database of information that is collaboratively edited by the public
<i>Forum</i>	a web-based discussion and advice sharing site
<i>Voice over Internet Protocol (VoIP)</i>	a means of providing web-based telephony
<i>Videoconferencing</i>	feature-rich, group video chat

ICT as a means of communication and Use of specific type of ICT are discrete quantitative data that were recorded on meaningful integer numerical scale from 1 to 5. They label a grade given to certain statement, where 1 stands for “I totally disagree” and 5 stands for “I completely agree”.

#### 4. Results

In table below (Table 3) statistical distribution of variables of interest is described.

Table 3. Statistical distribution of variables of interest.

Considered feature	Descriptive statistics of sample	
	Mean	Standard deviation
<i>Students' perception of its own knowledge about formative and summative assessment, feedback and ICT</i>	0.398319	0.283436
<i>Applied knowledge about formative assessment</i>	0.248739	0.411048
<i>ICT as a means of communication related to teaching</i>	4.168067	0.718276
<i>Use of specific type of ICT in communication related to teaching</i>	2.194538	0.535866

Results dealing with students' perception of their own knowledge about formative and summative assessment and feedback show that more than half of participants have never heard about it. Information and Communication Technology is better recognized, more than half of participants are familiar with the term (Table 4) 43% of participants connect feedback with the process of formative assessment, but familiarity with the concept of formative assessment does not imply knowing the concept of feedback ( $r(117) = 0.09, p < 0.05$ ). Qualitative data of the considered feature shows that formative assessment is associated with continuous monitoring without rating, summative assessment is associated with overall course assessment and feedback is considered rather a quantitative value than a way to enhance the learning process.

Table 4. Knowledge of the concepts of formative and summative assessment, feedback and ICT.

Recognition of the term	Formative assessment		Summative assessment		Feedback		ICT	
	N	%	N	%	N	%	N	%
<i>Yes</i>	34	28.6	34	28.6	49	41.2	69	58.0
<i>No</i>	85	71.4	85	71.4	70	58.8	50	42.0

On the Faculty of Education, ICT is commonly used as a mean of communication ( $M = 4.17, SD = 0.72$ ) and it is the most common way of providing feedback to the students ( $M = 4.27, SD = 0.92$ ). Students perceive use of ICT in informatics

courses more often than in other courses ( $M = 4.3$ ,  $SD = 1.03$ ), and ICT is more commonly used in communication with other students about teaching ( $M = 4.43$ ,  $SD = 0.86$ ) but with instructors ( $M = 3.87$ ,  $SD = 1.02$ ), as expected. The most common types of ICT used for communication with other students about teaching are social networks ( $M = 4.57$ ,  $SD = 0.99$ ), email ( $M = 3.61$ ,  $SD = 1.24$ ), SMS ( $M = 3.32$ ,  $SD = 1.37$ ) and VoIP ( $M = 3.32$ ,  $SD = 1.0$ ). Communication with instructors about teaching is usually carried out by email ( $M = 4.60$ ,  $SD = 0.84$ ) and social networks ( $M = 2.15$ ,  $SD = 1.49$ ).

Table 5. Statistical distribution of type of ICT in communication with other students and instructor.

Type of ICT	Communication with other students		Communication with instructors	
	Mean	Standard deviation	Mean	Standard deviation
<i>Email</i>	3.605042	1.243413	4.613445	0.844817
<i>Instant messaging</i>	2.907563	1.551334	1.470588	0.998503
<i>SMS</i>	3.319328	1.365016	1.705882	1.237500
<i>Chat</i>	2.184874	1.478469	1.352941	0.819138
<i>Social network</i>	4.571429	0.996361	2.151261	1.493708
<i>Blog</i>	1.294118	0.867032	1.201681	0.618635
<i>Micro Blog</i>	1.277311	0.872600	1.151261	0.531047
<i>Wiki</i>	2.647059	1.429639	1.403361	0.968306
<i>Forum</i>	1.714286	1.009639	1.731092	1.132699
<i>VoIP</i>	3.319328	1.567319	1.546218	1.140531

Correlational analysis of the hypothesis H1 showed that there is no correlation between the knowledge of formative and summative assessment, feedback and ICT and perception of ICT as a means of communication related to teaching ( $r = 0.1313$ ,  $p = 0.155$ ). That means that overall knowledge about formative and summative assessment, feedback and ICT does not influence the perception of ICT as mean of communication, although familiarity with the term of ICT is associated with perception of ICT as mean of communication ( $r = 0.26$ ,  $p = 0.004$ ).

At the end of the survey, students had the opportunity to express their own opinion about the communication with the instructors, especially by means of ICT, and opinion about processes of formative and summative assessment, feedback and ICT. Regarding communication through ICT, the advantages of time and geographic availability are mostly highlighted. Students find communication by means of ICT useful and inevitable in the present, modern time or time of 21<sup>st</sup> century. One student wrote:

*“Communication with teachers by means of ICT today is in much greater use than before. I believe that such communication is much easier for the students and instructors, and that it will develop in the future.”*

Negative aspect that is highlighted is the inaccessibility of some teachers to communicate via ICT, “probably because of their age and rejection of using any

*technology*” as one student stated. Lack of face-to-face communication is also highlighted as one of negative aspects of this kind of communication, e.g. *“I support this type of communication, but in limited amounts, it is important to maintain face to face communication.”*

According to students’ opinion about formative and summative assessment, feedback and ICT, formative assessment is applied at the Faculty of Education, but not through all the courses and not at a satisfactory scope. Summative assessment still dominates as the way of examining the theoretical knowledge in details. Assessment of students’ competences and skills is, in their opinion, neglected. Here are opinions of several students:

*“Although I read meaning of formative and summative assessment in the survey, it still sounds too abstract so I can’t express my opinion about it.”*

*“I think that formative assessment and feedback could greatly improve and encourage students’ capabilities, knowledge and will.”*

*“I hope that next year, all mentioned above, will improve.”*

## 5. Conclusion

Formative assessment, as well as summative assessment, is applied at the Faculty of Education in Osijek. Some respondents understand the connection between formative assessment as a form of improving teaching without grading, but poorly connect feedback with the term of formative assessment. Student are mostly satisfied with communication with instructors by means of ICT, although some negative aspects are emphasized. In communication with instructors, email is the most common type of ICT used, and some students consider it the best way, because it provides a formal way of communication.

On the Faculty of Education 716 students are enrolled and 119 of them participated in this research. The most participants are at the second year of studies, which may affect the results about their perception of formative and summative assessment and feedback. Maybe the fourth- and fifth-year students would be more familiar with these terms.

Expressing their opinions, students emphasized the negative aspects of communication through ICT pertaining to instructors. It would be desirable to examine the opinion of instructors on these issues to see whether these negative experiences grounded or not.

## References

- [1] BELL, B. AND COWIE, B. (2001), *The Characteristics of Formative Assessment in Science Education*, Science Education, 85 (5), 536–553.
- [2] BOUD, D. (2000), *Sustainable Assessment: rethinking assessment for the learning society*, Studies in Continuing Education, 22 (2), 151–167.

- [3] CARLESS, D. (2003), *Learning-oriented assessment*, Adelaide: Evaluation and Assessment conference.
- [4] CRAMP, A. (2011), *Developing first-year engagement with written feedback*, *Active Learning in Higher Education*, 12 (2), 113–124.
- [5] ĐERI, I., DOBI BARIŠIĆ, K. AND JUKIĆ MATIĆ, L. (2013.), *The influence of the formal education and personal initiatives for the willingness to use ICT in teaching mathematics*, In M. Pavleković, Z. Kolar-Begović and R. Kolar-Šuper (Eds.), *Mathematics Teaching for the Future* (pp. 261–271), Osijek: Faculty of Teacher Education.
- [6] European Association for Quality Assurance in Higher Education, (2009.), *Standards and Guidelines for Quality Assurance in the European Higher Education Area*, [http://www.enqa.eu/wp-content/uploads/2013/06/ESG\\_3edition-2.pdf](http://www.enqa.eu/wp-content/uploads/2013/06/ESG_3edition-2.pdf) [Accessed 26/02/2015].
- [7] EVANS, C. (2013), *Making Sense of Assessment Feedback in Higher Education*, *Review of educational Research*, 83 (1), 70–120.
- [8] GIKANDI, J., MORROW, D. AND DAVIS, N. (2011), *Online formative assessment in higher education: A review of the literature*, *Computers&Education*, 57, 2333–2351.
- [9] GILBERT, L., WHITELOCK, D. AND GALE, V. (2011), *Synthesis Report on Assessment and Feedback with Technology Enhancement*, <http://core.ac.uk/download/pdf/1512614.pdf> [Accessed 25/03/2015].
- [10] HARASIM, L. (2012), *Learning Theory and Online Technologies*, Routledge Taylor & Francis Group.
- [11] MILLER, C., DOERING, A. AND SCHARBER, C. (2010.), *No such thing as failure, only feedback: Designing innovative opportunities for e-assessment and technology-mediated feedback*, *Journal of Interactive Learning Research*, 21 (1), 197–224.
- [12] SADLER, R. (1989), *Formative assessment and the design of instructional systems*, *Instructional Science*, 18 (2), 119–144.
- [13] TARAS, M. (2008), *Summative and formative assessment: Perceptions and realities*, *Active learning in higher education*, 9 (2), 172–192.
- [14] WEMPEN, F. (2014.), *Computing Fundamentals – Digital Literacy Edition*, Wiley.

Contact address:

Karolina Dobi Barišić  
Faculty of Education  
Josip Juraj Strossmayer University of Osijek  
Cara Hadrijana 10, 31000 Osijek, Croatia  
e-mail: karolina.dobi@foozos.hr

## Percepcija budućih učitelja o integraciji IKT-a u proces vrednovanja i povratne informacije

---

---

Karolina Dobi Barišić

Fakultet za odgojne i obrazovne znanosti, Sveučilište Josipa Jurja Strossmayera u Osijeku, Hrvatska

*Sažetak.* Posljednjih godina se u visokom obrazovanju fokus stavlja na kvalitetu obrazovanja. Povratna informacija je ključni element formativnog vrednovanja ili čak ključni element cjelokupnog pristupa učenju. Informacijsko komunikacijska tehnologija omogućuje efektivnije načine poučavanja s čestim formativnim provjerama znanja i pravovremenom povratnom informacijom. Cilj ovog istraživanja je ispitati u kojoj mjeri su budućí učitelji upoznati s pojmovima formativnog i sumativnog vrednovanja kao i njihovu percepciju uloge IKT-a u tim procesima te u kojoj mjeri se, u promatranom kontekstu, formativno vrednovanje i povratne informacije pojavljuju u njihovom trenutnom obrazovanju. Rezultati su pokazali da budućí učitelji nisu najbolje upoznati s promatranim pojmovima, ali su, unatoč istaknutim nedostacima, uglavnom zadovoljni komunikacijom putem IKT-a. Razmotrena su ograničenja ovog istraživanja kao i implikacije za daljnja istraživanja.

*Ključne riječi:* povratna informacija, formativna procjena, sumativna procjena, informacijsko-komunikacijska tehnologija, učitelji



# 3.

## Approaches to teaching mathematics

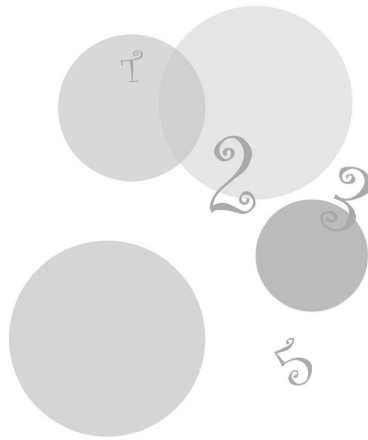



# Pass rates in mathematical courses: relationship with the state matura exams scores and high school grades

---

---

Dušan Munđar and Zlatko Erjavec

University of Zagreb, Faculty of Organization and Informatics, Varaždin, Croatia

*Abstract.* In this paper authors investigate relationship between scores in state Matura exams in mathematics, Croatian language, high school grades and success in some mathematical courses in the undergraduate study of “Information and Business Systems” at the University of Zagreb, Faculty of Organization and Informatics. Mathematical courses are often courses with the lowest pass rates and the lowest average grade. Therefore, identification of required knowledge for successful passage of mathematical courses influences success rate for the whole study. Methods used in the paper are primary statistical and data mining methods: descriptive statistics, logistic regression and others. Computation is done in the R programming language.

*Keywords:* study success rate, math-courses success rate, state Matura exam results, data mining methods, R programming

## 1. Introduction

State Matura is a set of exams that students of gymnasium are obliged to take in order to finish their secondary education in Croatia. Student of vocational and art schools are also eligible for state Matura exams, provided that they completed a 4-year program and that their secondary education ends with the production of final assignment. There are mandatory and elective state Matura exams, they are equal for all the candidates and all candidates take them in the same time. State Matura exams in Croatian language, math and foreign language can be taken in two levels: higher (A) and basic (B), while all other state Matura exams are taken on one level. There are only few relevant researches about State matriculation implementation in Croatia and academic success of students who are obligated to State matriculation exams. Statistically significant difference in the exam pass rate between the generations enrolled in 2009 and in 2010 is confirmed in [4].

Each higher institution decides on their own requirements for enrolment to its study programs, and on the breakdown of points. The requirements for the undergraduate study program “*Information and Business systems*” at the Faculty of Organization and Informatics are presented in Table 1:

Table 1. Requirements for enrolment to the study program.

Element of scoring	Percent in grading	Maximum of points
Average of all grades	35%	350
Math – A level	35%	350
Croatian language – B level	20%	125 (200)*
Informatics	10%	100
<i>Overall</i>	100%	925 (1000)

\*The exam result on the higher level (A) is multiplied by a coefficient of 1.6.

Students of the undergraduate study program “*Information and Business systems*” attend 2 math courses at the first year: *Mathematics 1* (in the first semester) and *Mathematics 2* (in the second semester). In *Mathematics 1* they were taught elements of mathematical logics, sets, functions and relations, and elements of linear algebra (matrices, determinants and systems of linear equations). In *Mathematics 2* they learned about functions, sequences, limits and elements of calculus of real functions of one variable (derivatives, integrals and their applications).

## 2. Data and methodology

We have data with observations for three year enrolment in study program “*Information and Business systems*” (2012, 2013, 2014) with total 830 students. Total 103 students of those students have incomplete documentation due to a variety of reasons, e.g. they enrolled the study based only on high school grades, they came to study from some other program, just enrolled those courses, etc. Those students are not included in analysis, so we have 263 students enrolled in year 2012, 179 in year 2013 and 275 in year 2014, so in total 717. Variables measured by the observation (student) are points achieved based on high school grades, percent of solved state Matura exams, which student took and passed, in Croatian (A or B level), Mathematics (A or B level) and Informatics.

Computation is done in R Studio, a user interface for R programming language, which is primarily used for statistical analysis. More about R studio and R is available on [www.rstudio.com](http://www.rstudio.com), and [www.r-project.org](http://www.r-project.org).

### 2.1. Distribution of sample by subject and level of state Matura exam

Table 2 presents number of students by subject and level of state Matura exam taken.

*Table 2.* Number of students by subject and level of Matura exam.

State Matura Exam Level					
Mathematics	A (higher)				
Croatian	A (higher)	A (higher)	B (lower)	B (lower)	
Informatics	Yes	No	Yes	No	Total
Ac. year 2012	73	48	111	31	263
Ac. year 2013	64	3	112	0	179
Ac. year 2014	72	49	128	26	275
Total	209	100	351	57	

## 2.2. Achieved points for enrolment to the study program

Students achieve points based on requirements for enrolment presented in Table 1.

Table 3 presents elements of descriptive statistics of points achieved by elements of scoring for whole sample.

*Table 3.* Requirements for enrolment to the study program.

Elements of scoring	Minimum	1 <sup>st</sup> Quartile	Median	Mean	3 <sup>rd</sup> Quartile	Maximum
High school grades	172.2	239.4	264.6	266.8	293.3	348.6
Matura exam – Croatian language	43.8	77.3	92.2	102.8	128.8	182.5
Matura exam – Mathematics	52.5	110.8	148.8	154.2	192.5	338.3
Matura exam – Informatics	15.0	37.5	47.5	49.2	62.5	95.0

Table 4 presents some elements of the descriptive statistics of points achieved by elements of scoring for two academic years: 2012/2013 and 2014/2015. Data indicates positive trend in number of points that enrolled students achieved during enrolment process. Students enrolled in 2014/2015 had better high school grades and Matura exam results than students enrolled in academic year 2012/2013.

*Table 4.* Some descriptive statistics for number of points by element of scoring – samples by year of enrolment.

Academic Year	2012/2013				2014/2015			
	1 <sup>st</sup> Q.	Median	Mean	3 <sup>rd</sup> Q.	1 <sup>st</sup> Q.	Median	Mean	3 <sup>rd</sup> Q.
High school grades	231.3	258.3	261.1	290.1	241.5	266.0	266.8	291.2
Matura exam – Croatian lang.	78.1	94.5	104.8	129.4	78.1	93.0	105.1	133.8
Matura exam – Mathematics	87.5	110.8	120.7	145.8	140.0	163.3	174.4	204.2
Matura exam – Informatics	32.5	42.5	43.8	52.5	42.5	52.5	54.1	67.5

### 2.3. Correlation among points achieved in elements of scoring

Table 5 presents Pearson's correlation coefficients among points achieved by each of scoring element in the enrolment process. It indicates high correlation among points in mathematics and informatics. Points achieved by high school grades are medium to low correlated to points achieved by results of Matura exams. The lowest correlation is observed by points achieved by Matura exam in Croatian and Informatics.

Table 5. Correlation among achieved points in elements of scoring.

Elements of scoring	High school grades	Matura – Mathematics	Matura – Croatian	Matura – Informatics
High school grades	1	0.295	0.286	0.278
Matura – Mathematics	0.295	1	0.189	0.762
Matura – Croatian	0.286	0.189	1	0.145
Matura – Informatics	0.278	0.762	0.145	1

### 3. Analysis of success in Mathematics 1

Figure 1 presents observations (students) who succeeded to pass Mathematics 1 exam (black colour), and those who didn't (grey colour) by points achieved by Matura exam in Mathematics, points achieved in Matura exam of Croatian and year of enrolment.

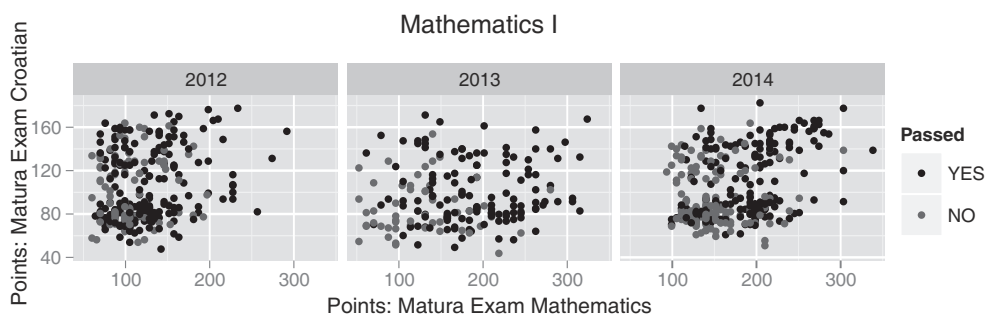

Figure 1. Success in Mathematics I based on points in Matura exam in Mathematics and Croatian by years.

Further on, we checked if there is statistically significant difference of means in achieved points between groups of students that passed Mathematics 1 (group A) and the group of students that did not pass (B group).

- State Matura Exam in Mathematics:

- Welch Two Sample t-test, gave t value of 8.80, on  $df = 670.6$ , which gives p-value smaller than  $2.23e-16$ . 95 percent confidence interval of the means difference is  $[26.5, 41.7]$ .

Difference between achieved points based on results of Matura exam in Mathematics of two groups of students: students that passed MAT1 and students that did not passed MAT1 is statistically significant.

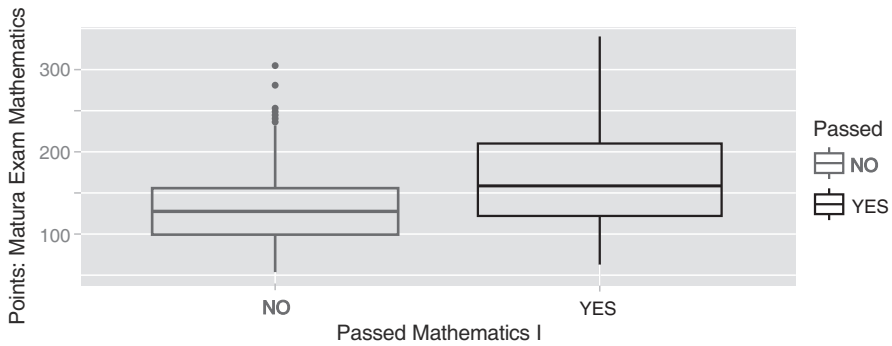

Figure 2. Boxplot of points (based on median) for two group of students: students that passed MAT1 and students that did not passed MAT1.

- State Matura Exams in Croatian:

- Welch Two Sample t-test, gave t value of 5.03, on  $df = 613.9$ , which gives p-value of  $6.368e-07$ . 95 percent confidence interval of the means difference is  $[6.9, 15.9]$ .

Difference between achieved points based on results of Matura exam in Croatian of two groups of students: students that passed MAT1 and students that did not passed MAT1 is statistically significant.

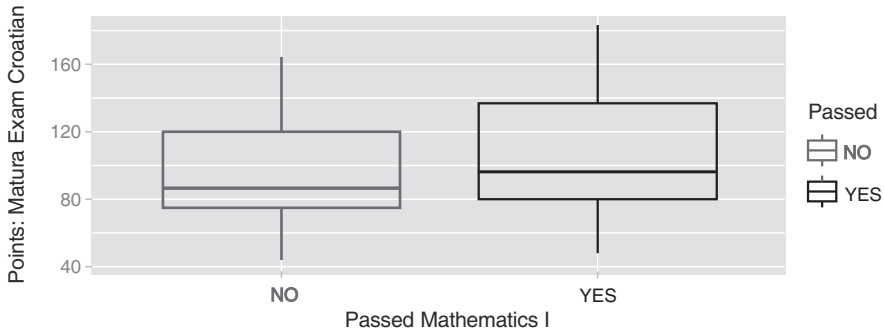

Figure 3. Boxplot of points (based on median) for two groups of students: students that passed MAT1 and students that did not passed MAT1.

- State Matura Exams in Informatics:
  - Welch Two Sample t-test, gave t value of  $-0.5337$ , on  $df = 360.261$ , which gives p-value of  $0.5938$ . 95 percent confidence interval of the means difference is  $[-5.6, 3.2]$ .
- High School Grades
  - Welch Two Sample t-test, gave t value of  $10.04$ , on  $df = 587.667$ , which gives p-value smaller than  $2.2e-16$ . 95 percent confidence interval of the means difference is  $[22.0, 32.7]$ .

Number of days from day of enrolment to pass the exam (days)

Table 6. Number of days from enrolment to pass of exam Mathematics 1.

Min	1 <sup>st</sup> Quartile	Median	Mean	3 <sup>rd</sup> Quartile	Maximum
111	189	192	234.4	194	922

More than 75% of students pass exam in Mathematics 1 in one year from enrolment.

### 3.1. Success prediction

Forthcoming analysis of success is done using logistic model. This model is used for assessment of probability for binary variable -success (passed exam in Mathematics 1). In other words, knowing the student results on Matura state exam and his/her high school grades, using the model, we can estimate probability that the student will pass exam in Math 1.

$$\ln \left( \frac{\text{Probability of success}(MAT1)}{1 - \text{Probability of success}(MAT1)} \right) = \beta_0 + \beta_1 \text{PointsMAT} + \beta_2 \text{PointsCRO} + \beta_3 \text{PointsSCHOOL}$$

Results:

Table 7. Results of logistic model for success in Mathematics 1 prediction.

exp(Estimate)	Values	Confidence interval (95%)		Pr(>  t )
		lower limit	upper limit	
$e^{\beta_0}$	0.0023	0.0006	0.0091	$< 2e-16$ ***
$e^{\beta_1}$	1.0010	1.0064	1.0135	$2.52e-08$ ***
$e^{\beta_2}$	1.0065	1.0007	1.0123	0.0269 *
$e^{\beta_3}$	1.0172	1.0123	1.0223	$9.98e-12$ ***



Table 7 presents that for every additional point in high school grades, with fixed values of other independent variables and coefficients, increase in odds ratio (i.e.  $p(\text{success})/(1-p(\text{success}))$ ) is about 1.7%. Second most influencing independent variable is number of points achieved based on State Matura in Mathematics.

Based on our model, odds ratio of the “average” student (the student which achieved median points, see Table 3) is 1.19 and corresponding probability that it will pass Mathematics 1 is 54.3%.

#### 4. Analysis of success in Mathematics 2

Figure 4 presents observations (students) who succeeded to pass Mathematics 2 exam (black colour), and those who didn’t (grey colour) by points achieved by Matura exam in Mathematics, points achieved in Matura exam of Croatian and year of enrolment.

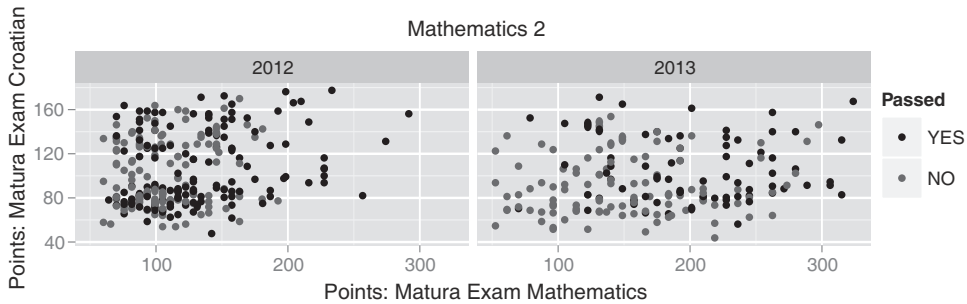

Figure 4. Success in Mathematics 2 based on points in Matura exam in Mathematics and Croatian by years.

We investigated if there is a statistically significant difference of means between those who passed Mathematics 2 and others in number of points obtained based on:

- State Matura Exams in Mathematics:
  - Welch Two Sample t-test, gave t value of 5.467, on  $df = 410.13$ , which gives p-value  $7.97e-08$ . 95 percent confidence interval of the means difference is  $[18.7, 39.7]$ .
- State Matura Exams in Croatian:
  - Welch Two Sample t-test, gave t value of 3.57, on  $df = 427.694$ , which gives p-value of 0.000396. 95 percent confidence interval of the means difference is  $[4.6, 16.0]$ .

- State Matura Exams in Informatics:
  - Welch Two Sample t-test, gave t value of  $-0.3902$ , on  $df = 357.135$ , which gives p-value of  $0.6966$ . 95 percent confidence interval of the means difference is  $[-5.8, 3.89]$ .
- High School Grades
  - Welch Two Sample t-test, gave t value of  $7.78$ , on  $df = 428.734$ , which gives p-value of  $5.502e-14$ . 95 percent confidence interval of the means difference is  $[22.7, 34.7]$ .

Time from day of enrolment to pass the exam (days)

Table 8. Number of days from enrolment to pass of exam Mathematics 2.

Min	1 <sup>st</sup> Quartile	Median	Mean	3 <sup>rd</sup> Quartile	Maximum
272	339	341	487.7	703	944

#### 4.1. Success prediction

Similar to the success prediction for Mathematics 1, analysis of success is done using logistic model. The goal is to assess the probability for binary variable – success (passed exam in Mathematics 2) knowing values of independent variables: points achieved based on State Matura in Mathematics, Croatian Language and High school grades.

$$\ln \left( \frac{\text{Probability of success}(\text{MAT2})}{1 - \text{Probability of success}(\text{MAT2})} \right) = \beta_0 + \beta_1 \text{PointsMAT} + \beta_2 \text{PointsCRO} + \beta_3 \text{PointsSCHOOL}$$

Results:

Table 9. Results of logistic model for success in Mathematics 2 prediction.

exp(Estimate)	Values	Confidence interval (95%)		Pr(>  t )
		lower limit	upper limit	
$e^{\beta_0}$	0.0027	0.0006	0.0131	$1.85e-13$ ***
$e^{\beta_1}$	1.0063	1.0025	1.0102	0.00129 **
$e^{\beta_2}$	1.0071	1.0003	1.0140	0.04001 *
$e^{\beta_3}$	1.0160	1.0102	1.0218	$5.46e-08$ ***

Table 9 presents that for every additional point in high school grades, with fixed values of other independent variables and coefficients, increase in odds ratio (i.e.  $p(\text{success})/(1-p(\text{success}))$ ) is about 1.6%. Number of points achieved based

on State Matura in Mathematics and Croatian are similarly influencing independent variables (influence of Croatian is more uncertain).

Based on the model, odds ratio of the “average” student (the student which achieved median points, see Table 3) is 0.88 and corresponding probability that it will pass Mathematics 2 is 46.9%.

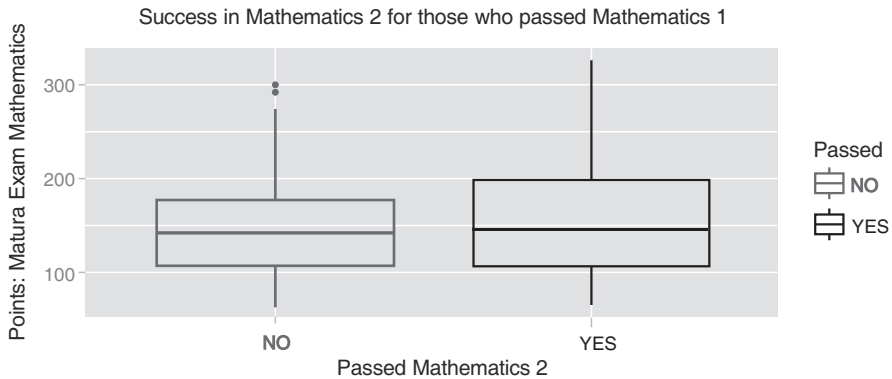

Figure 5. Points on Mathematics Matura Exam as predictor for success for Mathematics 2 for those who passed Mathematics 1.

Figure 5 presents that there is not big difference in points from Math Matura exam between students who passed and those who did not pass Mathematics 2, considering only students that passed Mathematics 1.

**Concluding remarks**

From presented analysis we conclude there is a positive correlation between the results of state Matura exam in Mathematics and pass rates in Mathematics 1 and 2. This result was expected. We also expected and confirmed in our analysis that results of Croatian language state Matura exam are the least important for passing Mathematics 1 and 2.

Significant impact of general high school GPA (grade point average) on pass rates in Mathematics 1 and 2 was somewhat unexpected. Better motivation and preparation associated with high GPA are possible explanation for better general success at university level, and specifically in mathematical courses.

No significant difference in state Matura exam impact on Mathematics 1 and Mathematics 2 success rate was observed. This contradicts student’s perception of Mathematics 2 being much harder than Mathematics 1. Student’s perception is probably influenced by the fact that Mathematics 1 is a prerequisite for Mathematics 2.

Future generations of students will provide more data allowing us to conduct further analysis and to validate our current results.

## Acknowledgement

The authors would like to thank the referee for the helpful suggestions.

## References

- [1] TEPIĆ, N., HABUD-KORBAR, A., *Gap between State Matura and School Grades*, Proceedings of the 33rd International Conference on Information Technology Interfaces, Cavtat, 2011.
- [2] Ministry of Science, Education and Sports, Agency for Science and Higher Education, National Center for External Evaluation of Education, Croatian Academic and Research Network CarNet: *Brochure for the candidates who have finished their secondary education abroad*, Zagreb, 2012.
- [3] State Matura exam reports for students of University of Zagreb, Faculty of Organization and Informatics enrolled in 2012–2014.
- [4] OBERMAN P. S., BOSANAC N., MATOTEK D., *Analysis of Efficacy of Studying of the First Generation of Students with National Matriculation*, Interdisciplinary management research X, Osijek, Croatia, 2014.

*Contact addresses:*

Dušan Munđar  
University of Zagreb  
Faculty of Organization and Informatics  
Pavlinska 2, 42 000 Varaždin, Croatia  
e-mail: [dusan.mundjar@foi.hr](mailto:dusan.mundjar@foi.hr)

Zlatko Erjavec  
University of Zagreb  
Faculty of Organization and Informatics  
Pavlinska 2, 42 000 Varaždin, Croatia  
e-mail: [zlatko.erjavec@foi.hr](mailto:zlatko.erjavec@foi.hr)

## **Prolaznost na matematičkim predmetima: povezanost s rezultatima ispita državne mature i ocjenama iz srednje škole**

---

---

Dušan Munđar i Zlatko Erjavec

Sveučilište u Zagrebu, Fakultet organizacije i informatike, Varaždin, Hrvatska

*Sažetak.* U članku se istražuje veza rezultata državne mature iz matematike, hrvatskog jezika i ocjena iz srednje škole sa uspjehom studenata na nekim matematičkim predmetima preddiplomskog studija “Informacijski i poslovni sustavi” Fakulteta organizacije i informatike Sveučilišta u Zagrebu. Obzirom da su matematički predmeti često predmeti s niskom stopom prolaznosti i niskim prosjekom ocjena, identifikacija predznaka bitnih za uspješno svladavanje matematičkih predmeta često utječe na uspješnost studiranja u cjelini. Metode korištene u članku su primarno metode statističke obrade podataka: deskriptivna statistika, logistička regresija i druge. Izračuni su rađeni u programskom jeziku R.

*Ključne riječi:* Stopa prolaznosti na studiju, stopa prolaznosti na matematičkim predmetima, rezultati ispita državne mature, rudarenje podataka, programiranje u R-u

## Approaches to teaching mathematics in lower primary education

---

---

Sead Rešić<sup>1</sup> and Ivana Kovačević<sup>2</sup>

<sup>1</sup>Faculty of Science, Department of Mathematics, University of Tuzla,  
Bosnia and Herzegovina

<sup>2</sup>Deseta osnovna škola Bijela, Brčko distrikt, Bosnia and Herzegovina

*Abstract.* This paper aims at establishing if primary school teachers in our schools apply innovative approaches in teaching mathematics to students in grades 1 to 5, with an emphasis on an integrated approach to teaching. A traditional approach to teaching still prevails in our educational system, especially in teaching mathematics. Modernization of the teaching process and introduction of innovative models of work into teaching mathematics is the primary task of educational system, but also of every individual teacher. Schools need to modernize, to use new, innovative models and ways of work, so that classes can become more efficient, creative and rational and that students can gain functional knowledge and abilities.

The first part of the paper provides explanations of basic theoretical terms related to this research topic, the second part introduces research methodology for the specified issue, while the third part presents the analysis and interpretation of the obtained results.

*Keywords:* teaching, mathematics, teacher, student, approaches to teaching, innovative models of teaching

### Introduction

With all the changes in society we live in, it is necessary to make changes in education system as well, which includes teaching of mathematics. Lately, the shortcomings of the existing education system and the need for changes are ever more emphasized. Modernization of the teaching process is certainly one of prerequisites of better education. Traditional approach to teaching, characterized by frontal manner of work, is still present in our education practice. Such traditional teaching of mathematics places strong emphasis on procedural knowledge, which is consequently reduced to ready-made recipes without understanding. In traditional

classrooms, students are insufficiently activate for work and they do not get opportunity to progress in according with their abilities and previous knowledge, what greatly affects students' motivation. If we take into account the fact that mathematics is not one of favorite school subjects of our students, it is easy to conclude that it is necessary to make certain changes in teaching. Students generally consider mathematics as difficult, hard to understand and abstract, so there is a need to work on improving the quality of teaching process.

Contemporary teaching of mathematics should be oriented towards students, which means that present dominant role of the teacher would be placed in the background. Teacher should no longer occupy the position of the main actor in knowledge transmission, but rather to be mentor, coordinator and organizer of the teaching process. Also, teachers should encourage students' activity, as well as make them responsible for their own success and advancement in mathematics. Introducing innovations and changes in mathematics classes, changes aims of traditional teaching that have been present so far, and, instead of operational abilities, new tasks in teaching become prominent: developing students' abilities of posing a problem and solving it using technology, then developing students' abilities of argumentation of mathematical ideas and discussion about possible solutions, using experimental approach and various interdisciplinary methods. Of course, inevitable tasks of teaching mathematics, such as developing abstract thinking, logical thinking and deduction, and applying mathematics in everyday life, still remain present, but with new content and new mathematical processes, using technology and experimenting in mathematics.

## **Theoretical background**

### **Traditional and innovative teaching of mathematics**

Primary school, especially teaching in lower primary classes, is the foundation of the entire school system. It is the first and extremely important level of education, and its successful mastering presupposes successful further education. This fact leads to the conclusion that it is necessary to work continuously on improvement of primary school teachers, and especially those at lower primary level. Education reforms are crucial issue everywhere in the world, while at the same time they present the condition for improving teaching. Students' success in mathematics is evidently lower in relation to other school subjects, especially when it comes to application of mathematics in concrete problem situations. Students mostly reproduce facts or do procedures, which they adopted without understanding, what should not be satisfy us as educators. It is necessary to work continuously on raising quality of mathematical knowledge and students' competencies on all levels (Rešić, 2013).

Traditional teaching is oriented towards mere transmission of knowledge, abilities and habits, where teacher has a role of information carrier, and as such is set above the students, while the student is only a passive object in the teaching process. Forms of work in traditional teaching are mostly frontal and individual, and methods are informational and reproductive, so the main characteristic of this kind

of teaching is memorizing and reproducing subject matter. In this type of teaching, students adopt knowledge learning it by heart, memorize and reproduce it, which certainly does not lead to permanent mastering of knowledge or its applicable value. The consequence of this is absence of interest and passivity of students.

Education reform has brought to our classrooms new, innovative models of work and teaching. Contemporary, innovative teaching implies creating conditions where the student becomes a subject in the teaching process. Student, from his/her role of secondary and passive factor, now becomes the central factor in the teaching process, acquiring a different role, and becomes a main task not only for the teacher, but for him/herself as well. The primary aim of innovative, contemporary teaching is development of students' competencies. What characterizes this teaching is democratic style, application of group work forms, problem oriented and reflexive teaching methods, learning through concrete work and real-life activities, problem situations, and exploration oriented thinking activities. In this setting, the teacher is an organizer, coordinator of the teaching process, consultant and assistant, while the students are motivated, interested and active. In this way, mathematics becomes close to students and can become more interesting and less abstract by employing various problem situations. Learning through concrete work and problem situations, students can understand why mathematics is necessary in their lives and what its significance is. What was abstract before, a definition hard to understand, written on paper, now becomes concrete and understandable content.

### **Innovative models in teaching mathematics**

The word 'innovation' is Latin in origin (Latin 'novus' – new, 'innovatio' – something new, a change) and refers to a novelty, something that is new. When innovation is mentioned in the context of teaching, it refers to novelties introduced in pedagogical reality with the aim to improve teaching practice. Innovations, therefore, imply advancing, modernizing and development. They do not necessarily have to bear the character of a new scientific discovery, but merely certain technological and organizational innovations are being applied in a new way, with a new aim to improve pedagogical practices (Vilotijević, 2000).

Innovative, contemporary teaching of mathematics gravitates toward breaking formalism in teaching, eliminating memorizing large amounts of facts, formulas and rules. It certainly implies developing students' abilities, but is not acquiring on meaningless and worthless mathematical content, rather, the basis is quality and educationally rich teaching content. This can be achieved through teaching dominated by unusual tasks and problem tasks, as well as tasks connected concrete life situations and problems. Teaching organized this way and tasks conceptualized in this manner arouse interest, motivation, ingenuity in students and they feel excitement because of their own engagement, which makes them feel important. Such experiences may create inclination for exploratory and intellectual work, which is one of the effects that leave a permanent mark on student's character. It is very important to develop individual logical thinking in students, and teachers achieve that when they arouse curiosity in their students, giving them tasks adequate for



their knowledge but also interesting and unusual. Innovative approaches to teaching mathematics are: integrated, project oriented, multimedia and problem oriented approach to teaching.

In our educational system, innovations are slowly implemented into the teaching process and a great number of teachers exhibit certain resistance toward innovative approaches to teaching mathematics.

There are numerous reasons for this, and the most important are:

- a) conservative teachers, who feel safer while implementing already tried, tested, traditional methods, rather than applying innovative methods, for the results of which they have doubts;
- b) insufficient financial support, that is, schools are not equipped with all necessary materials for conducting innovative teaching models and
- c) poor education of teachers for this model of work, which is caused by insufficient preparation for contemporary manner of work and application of innovative methods at universities, but also insufficient motivation of teachers for education and advancement.

Our experience shows us that the organization of various forms of innovative teaching, such as an integrated, multi-media, project and problem requires much more effort than organizing traditional teaching. In Bosnia and Herzegovina there is no national strategy or concept that requires or supports the implementation of innovative teaching models. This is one of the reasons why innovative teaching still is not sufficiently developed in our school system. Innovative teaching includes professional as well as on material support, what means that our teachers must be educated and trained for organizing innovative teaching and schools must be equipped with literature and didactic materials. As teachers in our schools do not have adequate rewards for their special effort or work, it is a bit difficult to motivate them to invest more effort in creating teaching process different from traditional, and this is something that innovative teaching certainly requires.

The teaching of mathematics in many of its themes can be connected very easy with other teaching areas. If we consider the fact that mathematics is still “bogey” to a large number of students, that they consider it incomprehensible and abstract, we can conclude that it is necessary to improve the organization of the teaching of mathematics, in terms of motivating students, and this can be achieved by just one of the innovative model of teaching – integrated teaching. It is necessary to connect mathematics with real-life situations to help students to improve their understanding. For instance, the best examples of interconnectedness between the contents of subject mathematics and subject science and society, beside the word problems, are reduced scale, geometric tasks, tasks with the size and orientation in space. Word problems can be customized to teaching various content i.e., various subjects. Based on our previous experience with an integrated approach to teaching, we can conclude that students are able to better acquire and master the content of mathematics if they can connect it with other activities and other subjects. Sometimes students do not actually recognize that some activities in fact

incorporate mathematical content. For example, mathematical content, such as relationships between objects can be easily connected with a physical education, the environment and my mother tongue (e.g. physical exercise, crouch-rise, who is bigger and who is smaller, the size of objects around us, imitating apple picking, fruit-orchard, describing apples and so on.). By connecting the content of mathematics with content of other subjects, we show students in a effective way that mathematics is present in our everyday life and connected with real life situations.

### Review of previous research

The need for educational reform, changes in the educational system, modernization of teaching and the introduction of innovations, as well as the specifics of teaching mathematics are topics that are the subject of research in recent years and which many authors write about.

Although mathematics was and still is one of the most important subjects at all educational levels, most students perform poorly in mathematics (see PISA or TIMSS results for this region). School grades in mathematics are getting worse by each year, students increasingly take private lessons, and select high schools and study programs at universities according to the amount of mathematics in their curriculum. Considering the results of students in mathematics in Bosnia and Herzegovina and the Croatian, poor ratings and negative attitude of most of society towards mathematics, Mišurac, Cindrić and Pejić (2013) examined the parameters that have an impact on the results of mathematical education, and one of the most important parameter is a teacher who teaches mathematics. With his methods of work and didactical competencies and skills, teacher greatly affects on their students and consequently on the results of students in mathematics. Results of aforementioned study showed that the majority of teachers tend to use contemporary teaching compared to traditional teaching, which is a good indicator of progress in teaching practices.

Quality teaching can be achieved only by quality staff. Teacher training is the foundation of successful teaching of mathematics. Results of research on the attitudes of students toward math in their teacher studies, conducted in the Republic of Croatia, showed that more than a third of prospective primary school teachers have negative associations with the word math (Mišurac, 2007). Those data lead us to the conclusion that it is necessary to work on improving the teaching process at teacher training colleges, in order to change the attitudes of future primary teachers toward mathematics.

In addition to the attitudes of teachers, the attitudes of students are very much essential for success in mathematics. Many researchers have studied the attitudes and beliefs of primary and secondary school students toward mathematics and their influence on success in mathematics (e.g. Arambašić, Vlahović-Štetić and Severinac, 2005). Research has shown that students' attitudes and beliefs have a significant impact on the success in mathematics. While at the beginning of education, most students have a positive or at least neutral attitudes toward mathematics, through schooling, their attitudes are becoming more negative and more students

start to consider mathematics as a difficult subject, which is difficult to learn and that subject they cannot master.

Study carried out in ten primary schools in Zagreb showed that students are aware of the role of mathematics in their education and life, but they continue to learn mathematics mainly because of grades (Benček Marenić, 2006). It turns out that the grade is the main and strongest motivation for learning, and mathematics in school is considered to be mostly boring.

From all this, we can conclude that it is necessary to work on the modernization of teaching mathematics. Poor results of students in mathematics are a fact, whether the reason are old traditional methods of teaching or the negative attitudes of teachers and students about math. A competent teacher, without prejudice or negative attitudes about mathematics is prerequisite and foundation of quality mathematics education. Such a teacher will be ready for the innovation and modernization of the teaching of mathematics, in order to improve the quality of mathematics education and student outcomes.

Changes are needed in the study programs that educate future teachers and in schools themselves. Teacher education colleges should pay more attention to innovation and modern methods of teaching mathematics to future teacher and motivate them for teaching mathematics. The schools can organize seminars and education on this subject, with as many concrete examples of teaching practice and less theorizing. Education of teachers must be maintained regularly in order to follow modern educational trends. To motivate students for teaching physical education, art or science and society with all its various facilities, is not nearly as challenging task as motivating students for learning mathematics. Therefore, this task can be very motivating for teachers, because it represents a challenge for every teacher.

## **Research aim**

Teaching process is a mutual activity of teachers and students, so the success of teaching Mathematics greatly depends on quality of that relationship, as well as quality of mutual activities. Mathematics teaching must be brought closer to students, modernize it and make it tempting and interesting. In the world of technological advancement, students have at their disposal various new sources of knowledge and information, so today they learn via the Internet, film and television as well. Therefore, school should be made modern by employing new, innovative models and manners of work, so that teaching can become more efficient, creative, rational and students are able to acquire functional knowledge and skills from mathematics.

The aim of this paper is to explore and interpret whether teacher employ innovative approaches to teaching Mathematics in subject teaching and if so, which of them, how often they use integrated approach to teaching Mathematics, and what are the causes of difficulties in applying integrated approach to teaching Mathematics.

## Methodology

Population in this research consists of lower primary teachers in Brčko District, Bosnia and Herzegovina. Village and town schools from Brčko District area are encompassed, namely Tenth Elementary school Bijela and Fourth elementary school Brčko. The research was conducted on a sample of 32 teachers in the second semester of academic year 2013/14.

The teachers filled out a questionnaire consisting of the set of statements, which aimed at exploring their tendencies in using innovative approaches in teaching mathematics:

1. In my work, I employ multimedia approach to teaching mathematics.
2. In my work, I employ project approach to teaching mathematics.
3. In my work, I employ problem approach to teaching mathematics.
4. In my work, I employ integrated approach to teaching mathematics.
5. I do not employ integrated approach to teaching mathematics often because it is demanding to prepare and organize this manner of work

## Analysis and interpretation of research results

Application of various approaches to teaching mathematics in lower primary school (multimedia, project, problem, integrated approach)

The first group of statements relates to the application of various approaches to teaching of mathematics in lower primary education. These statements were designed to determine whether teachers employ in their work various approaches to teaching mathematics, such as multimedia, project, problem and integrated approach.

The first question, that is, statement, "*In my work, I employ multimedia approach to teaching mathematics*" was confirmed by 26 (81.3%) teachers, they claim that they apply multimedia approach to teaching of mathematics in their work, while 6 (18.7%) teacher expressed negatively in this statement (Table 1).

Table 1. Multimedia approach.

<i>In my work, I employ multimedia approach to teaching mathematics</i>				
Teachers' responses	YES		NO	
	$\sum$	%	$\sum$	%
		26	81.3	6

Therefore, most teachers employ multimedia approach to teaching mathematics in their work, which is a good indicator of implementing innovations in teaching.

It is indicative that teachers who denied the statement, saying that they do not apply multimedia approach to mathematics teaching in their work, have over 30 years of teaching experience. Also, since multimedia teaching implies certain teaching aids, it is interesting to point out that these results speak of well-equipped schools with multimedia aids.

The second question provides information that most teachers do not employ project approach to teaching of mathematics in their work. The statement “*In my work, I employ project approach to teaching mathematics*” was confirmed by only 9 (28.1%) teachers who chose YES, while 23 (71.9%) teachers opted for NO as their response (Table 2).

Table 2. Project approach.

<i>In my work, I employ project approach to teaching mathematics</i>				
Teachers' responses	YES		NO	
	$\Sigma$	%	$\Sigma$	%
	9	28.1	23	71.9

It is interesting to note that all 9 teachers who confirmed the statement have less than ten years of working experience in teaching, what shows that younger teachers apply innovative approaches to teaching of mathematics more, that they are more open to innovative models of teaching and deviate more from traditional teaching.

Replies to the third question, that is, statement “*In my work, I employ problem approach to teaching mathematics*” show that 24 (75%) teachers do employ problem approach in teaching mathematics, while 8 (25%) participants do not employ this manner of work (Table 3).

Table 3. Problem approach.

<i>In my work, I employ problem approach to teaching mathematics</i>				
Teachers' responses	YES		NO	
	$\Sigma$	%	$\Sigma$	%
	24	75	8	25

It is important to emphasize that mathematics as a school subject is by the character of its content extremely specific and appropriate for application of problem approach, so more frequent use of this manner of work is expected.

The fourth statement “*In my work, I employ integrated approach to teaching mathematics*” provides information that 28 (87.5%) teachers employ integrated teaching in their work, while only 4 (12.5%) participants deny applying integrated teaching (Table 4).

Table 4. Integrated approach.

<i>In my work, I employ integrated approach to teaching mathematics</i>				
Teachers' responses	YES		NO	
	$\Sigma$	%	$\Sigma$	%
	28	87.5	4	12.5

This implies that most surveyed teachers employ integrated teaching of mathematics in their work. Four teachers who opted for a negative answer for this question have over 30 years of working experience in teaching, what indicates to the rigidity of older population of teachers towards implementing innovations in teaching.

Results of the first group of question in the questionnaire, which are related to the application of various approaches in teaching mathematics in lower primary education, show that teachers employ various approaches to teaching, mostly integrated approach, but also many of them employ multimedia and problem approach, while project approach is implemented the least. From the acquired data about working experience of teachers, it is possible to conclude that mostly older teachers, with 30 or more years of working experience, do not employ innovative approaches to mathematics teaching, and that younger teachers are more open to changes and application of innovations in teaching.

Preparing and organizing integrated teaching is demanding, what complicates application of integrated approach to mathematics teaching in lower primary education

The question (statement) *"I do not employ integrated approach to teaching mathematics often because it is demanding to prepare and organize this manner of work"* was confirmed by 15 (46.9%) participants, that is, they consider this approach too demanding, which is detrimental to application of integrated teaching. 8 (25%) participants opted for *NO*, while 9 (28.1%) participants believe that demands of lesson preparation for integrated approach is partly the reason why they find it difficult to apply that manner of work (Table 5).

Table 5. Demands of lesson preparation.

<i>I do not employ integrated approach to teaching mathematics often because it is demanding to prepare and organize this manner of work</i>						
Teachers' responses	YES		NO		PARTLY	
	$\Sigma$	%	$\Sigma$	%	$\Sigma$	%
	15	46.9	8	25	9	28.1

15 surveyed teachers (46.9%) believe that they do not employ integrated approach to teaching of mathematics often because of difficulty of this manner of

work, which confirms the fact that integrated teaching is indeed a complex process which demands thorough preparation and a competent teacher willing to work. The results of the questionnaire imply that precisely the fact that integrated teaching is demanding to prepare prevents teachers from applying this model of teaching.

## Conclusion

This paper explored whether teachers employ innovative approaches to teaching mathematics in lower primary education, which approaches they apply and what affects their ability to employ integrated approach to teaching mathematics.

Although the number of participants in the survey is not very large and the results cannot be highly generalizable, the results of this study are of great importance to Bosnian educational system. Based on acquired results, it can be concluded that teachers apply various approaches to teaching mathematics, mostly integrated approach, followed by multimedia and problem oriented approach, and they apply project oriented approach to teaching mathematics the least. Each of the above-mentioned innovative approaches to teaching is organizationally a lot more demanding than traditional way of teaching, but because of all the advantages contemporary teaching models offer, it is necessary that they find place in our education process. Today, school should be adapted more to needs of students in the contemporary world, with Internet and advanced technologies, which demand quick information analysis. Such students need dynamic and interesting teaching process, which will offer knowledge and competencies for the upcoming future. We can conclude that the majority of teachers tends to use contemporary teaching compared to traditional teaching, which coincides with the results of research on the parameters that have an impact on the results of mathematical education (Mišurac, Cindrić & Pejić, 2013), what we mentioned earlier in the work.

Examining the causes, that impede teachers in their application on integrated teaching of mathematics, we gained the insight that the most common cause is demanding lesson preparation, planning and organizing such manner of work. Teachers should be provided with continuous expert advancement, which will empower them to become competent for introduction of innovative approaches to teaching mathematics in their everyday teaching practice. It is obvious that they, regardless of their level of expertise and years of teaching practice, are not empowered enough for planning integrated teaching mathematics. Unfortunately, in our school system, those individuals who continuously improve their skills and work on implementing innovations are at the same level as passive participants in the teaching process. Overcoming these differences in work and devotion of teachers could be possible through legal regulation or official education strategy, which would enable realization of integrated approach to teaching mathematics, as well as other innovative teaching models, through an official curriculum. However, until the issue of innovative approaches to teaching mathematics becomes legally regulated, it is a moral obligation of teachers to apply and promote in every opportunity all kinds and forms of contemporary teaching and innovative models of work, so that mathematics becomes more interesting and likeable for students.

## References

- [1] ARAMBAŠIĆ, L., VLAHOVIĆ-ŠTETIĆ, V., SEVERINAC, A. (2005), *Je li matematika bauk? Stavovi, uvjerenja i strah od matematike kod gimnazijalaca*, Društvena istraživanja, 14 (6), 1081–1102.
- [2] BENČEK, A., MARENIĆ, M. (2006), *Motivacija učenika osnovne škole u nastavi matematike*, Metodički obzori, 1 (1), 104–117.
- [3] HADŽIĆ-SULJKIĆ, M. (2009), *Metodologija istraživanja u odgoju i obrazovanju*, Tuzla: PrintCom.
- [4] MARKOVAC, J. (2001). *Metodika početne nastave matematike*, Zagreb: Školska knjiga.
- [5] MIŠURAC ZORICA, I., REŠIĆ, S. (2011), *Standardi matematičkih kompetencija u nastavi matematike*, Tuzla: Grafotehna.
- [6] MIŠURAC ZORICA, I. (2007), *Attitudes of the students of teaching studies towards mathematics*, In M. Pavleković (Ed.), *How to teach and learn mathematics* (pp. 263–275), Zagreb: Element.
- [7] MIŠURAC ZORICA, I., CINDRIĆ, M., PEJIĆ, M. (2013), *Readiness of Primary Teachers to Apply Contemporary Math Teaching*, In M. Pavleković, Z. Kolar Begović & R. Kolar Šuper (Eds.), *Mathematics teaching for the future* (pp. 282–297), Zagreb: Element.
- [8] MUŽIĆ, V. (1999), *Uvod u metodologiju istraživanja odgoja i obrazovanja*, Zagreb: Educa.
- [9] POLJAK, V. (1985), *Didaktika*, Zagreb: Školska knjiga.
- [10] REŠIĆ, S. (2013), *Matematika I – Metodika početne nastave*, Tuzla: Papir karton.
- [11] VILOTIJEVIĆ, M. (2000), *Didaktika – Organizacija nastave, Opseg 3*, Beograd: Zavod za udžbenike i nastavna sredstva Učiteljski fakultet.

Contact addresses:

Sead Rešić  
Faculty of Science  
Department of Mathematics  
University of Tuzla  
Bosnia and Herzegovina  
e-mail: sresic@hotmail.com

Ivana Kovačević  
Deseta osnovna škola Bijela  
Brčko distrikt  
Bosnia and Herzegovina  
e-mail: tokicivana@hotmail.com



## Pristupi poučavanju matematike u razrednoj nastavi

---

---

Sead Rešić<sup>1</sup> i Ivana Kovačević<sup>2</sup>

<sup>1</sup>Prirodno-matematički fakultet, Univerzitet u Tuzli, Bosna i Hercegovina

<sup>2</sup>Deseta osnovna škola Bijela, Brčko distrikt, Bosna i Hercegovina

*Sažetak.* Ovim radom želimo utvrditi primjenjuju li učitelji u našim školama inovativne pristupe poučavanju matematike u razrednoj nastavi, sa naglaskom na integrirani pristup poučavanju. Našim obrazovnim sustavom, pa tako i nastavom matematike i dalje dominira tradicionalni pristup poučavanju. Osvremenjivanje nastavnog procesa i uvođenje inovativnih modela rada u nastavu matematike je primarna zadaća obrazovnog sustava ali i svakog učitelja ponaosob. Školu moramo učiniti suvremenom, upotrebljavajući nove, inovativne modele i načine rada, kako bi nastava postala efikasnija, kreativnija i racionalnija i kako bi učenici iz nje dobili funkcionalna znanja i umijeća.

U prvom dijelu rada pojašnjeni su temeljni teorijski pojmovi vezani za ovu istraživačku temu, drugi dio se odnosi na metodologiju istraživanja naznačenog problema, dok su u trećem dijelu predstavljeni analiza i interpretacija dobijenih rezultata.

*Ključne riječi:* nastava, matematika, učitelj, učenik, pristupi poučavanju, inovativni modeli nastave

# Issues in contemporary teaching of mathematics and teacher competencies

---

---

Zoran Horvat

Electrotechnical School Varaždin, Varaždin, Croatia

*Abstract.* In this paper, the author examines current problems in the teaching of mathematics and mathematics education and shows how theoretical and practical findings underestimate the role of the social dimension in the teaching of mathematics. Mathematical education is perceived in this research as a kind of a social construct in contrast to the traditional definition of (teaching) mathematics as a purely scientific discipline. The author focuses on students' emotional reactions, classroom environment and teacher competencies as indicators of quality in the teaching of mathematics. In the context of contemporary mathematics teaching, the author uses a critical approach to assess the way and content of teacher education as well as the required competencies in quality mathematics teachers. Taking into account the requirements and specifics of teaching mathematics that are in the domain of pedagogical theory and practice, the author emphasises teachers' pedagogical competencies and their definition from the pedagogical perspective. A review of relevant research has led the author to state that a stimulating classroom environment is one of the key assumptions of students' success in mathematics and that the didactic-methodological guidelines of teaching mathematics should be based on the individuality of students and the demands and difficulties they encounter in the classroom.

*Keywords:* teaching of mathematics, students' emotional reactions, classroom environment, mathematics teachers' pedagogical competencies

## 1. Introduction

As stated in numerous international studies (PISA, TIMSS, PIRLS and ESLC), educational systems across Europe are faced with low student achievements in mathematics, along with areas of other core competencies. For instance, thirty percent of our students did not acquire the basic mathematics skills (OECD, 2013). State Matura exam results additionally substantiate that a significant number of our

students have certain difficulties in math class and do not understand basic math concepts. By implication, success in mathematics is imperative for achievements in related fields (professions), including future profession selection, which is among other things manifested by avoiding faculties in fields such as mathematics, science and technology (Widmer and Chavez, 1982). Given that these matters have been recognized at European level as key components of educational policy for economic development (Eurydice Report, 2012), educational authorities in numerous European countries are undertaking various measures in order to increase the percentage of graduates in these fields. However, a comparative analysis on developing key competencies, conducted by the European Union, found that one third of European countries have not yet developed a national strategy for mother tongue, mathematics and science (Eurydice report, 2012). Among key competencies, mathematical competence is distinct in its specific features and has a prominent place amid the educational issues, and generates interest for educators, psychologists and other experts working in the educational system. Under the term mathematical competence we consider student's capacity for developing and applying mathematical thinking in order to solve problems in different everyday situations (NOK, 2011). Teaching quality, along with teacher's competencies, is critical for achieving mathematical competence. Terhart (2001), after reviewing relevant research, stated that the issue of teacher quality is equivalent to the search for the best method aimed at finding the best conditions for learning success. Students' low results are therefore attributed to teachers although teachers are not provided with constructive solutions. Usually teachers are instructed on the theoretical level in terms of what needs to be done, without clear guidelines and methods on how to achieve it in the specific circumstances. If we look at the issue of teacher training and didactic-methodological guidelines of teaching math, which practitioners currently take into consideration, it is obvious that the requirements of modern teaching go beyond the theoretical and practical basis of their education and professional training. In addition, teaching math is often identified with mathematical science, and is therefore approached as if it were a scientific discipline, in which the professional teachers' competencies and students' skills are most important for students' success. Consequently, mathematics is often put in the same sentence as innate abilities and talents, while not enough credit is given to the importance of social context in which it unfolds. Thus, the problem of math education is reduced to the central pedagogical problem – the problem of talent and education (Giesecke, 1993). Accordingly, in contrast to most other school subjects, many factors which affect school performance are not considered, still each grade in math is attributed to a lack of certain skills as if only skills determine success in mathematics. Additional importance is given to the whole extent of the problems in the fact that general opinions and beliefs see mathematics as a discipline for certain (gifted) students. The society often has certain stereotypes towards mathematics and perceives it as a logical, absolutist, rigid, cold, objective, inhuman and abstract science (Andrews, Rowland, Brindley et al., 2014). Therefore, research of math education at the end of the eighties in the twentieth century gradually focused on social and affective dimensions of teaching mathematics, and since then mathematics education has been increasingly considered as a social construct (Widmer and Chavez, 1982; Hembree, 1990; D' Ambrosio, 1999; Aschraft, 2002; Geist, 2010). Students face many challenging and stressful situations in the classroom and outside of the classroom on a daily basis, where they gather different emotions through experience towards all segments

of the educational process. Emotions are essential to student motivation as one of the fundamental presumptions of school success. Bearing in mind the difficulties that students face while learning mathematics and other specifics of math class, emotions are established as a crucial part of successful learning. After reviewing research, Arambašić et al. (2005) reported that students have positive or neutral attitudes and emotions towards mathematics at the beginning of their education, while emotions become more negative during the course of their education. There is also the belief that students are not successful in mathematics because their general class teachers have underdeveloped professional competencies for quality teaching. On the other hand, recent researches pinpointed the emotional sphere of the teaching process where it was demonstrated that general class teachers possess a high degree of anxiety toward mathematics (eg. Widmer and Chavez, 1982; Hembree, 1990; Vinson, 2001), and they transfer their anxiety to their students (Vinson, 2001; Peker, 2008). Some studies indicated that students acquire beliefs about mathematics through parents' upbringing practices (eg. Turner et al., 2002). In addition, there is currently a lot of disagreement concerning the competence profile of math teachers or determining the competency standards which can complement the teaching demands of contemporary math education. When discussing teacher's competencies, generally there is a lack of valid and empirically verifiable theories on teacher education and therefore special attention should be paid to relations between empirical research and theoretical considerations in the reform of teacher education (Palekčić, 2008). Considering the totality of factors influencing math education, this paper will focus its attention on emotions and classroom environment in teaching mathematics. Since these are the key components, as well as the underlying assumptions of quality teaching, the goal is to determine which competencies teachers need to acquire in order to create a positive classroom environment and eliminate difficulties and obstacles that students face in math class.

## **2. Challenges and requirements in teaching mathematics**

### **2.1. Student's emotional reactions**

Student's math competence is evaluated by testing acquired knowledge and skills, while frequently overlooking their emotions and attitudes, which are often both a cause and consequence of these results and a necessary part of any evaluation. Emotions occur as a personal reaction to a situation, and therefore instead of the term emotions we often use the term "emotional reaction" (Milivojević, 2007). The teaching process is saturated with emotional reactions from students and teachers, and due to the expansion and characteristics of the problem in math class, these observations should be seriously considered in any didactic-methodological lesson planning. Aschraft (2002) stated that in some cases the difference in students' achievements in math class is not due to the lack of ability or potential, but because of their fear of mathematics and students' overall emotions in the classroom. According to the guidelines of modern pedagogy which recognizes the individuality of the child and his social being, the starting point is the school as a social being (Previšić, 1999). Among the recent notions in pedagogy, it is the affective side of the educational process that is indicated as one of the most current topics

(Kolak and Majcen, 2011). In the recent couple of decades theoretical discussions about teaching mathematics have increasingly emphasized the importance of social and affective dimensions of teaching, which is why there is a growing number of studies concerning math education that study student's attitudes and emotions in the classroom. Kolak (2014) categorises emotional reactions in class as those directed towards the subjects of school and teaching processes (students, teachers and parents), the emotional reactions among students and the emotional reactions in reference to the teaching process. Besides the term emotional reactions, he also uses the term "academic emotions" referring to the emotions that are closely connected to the teaching process as well as to results of the learning process (Pekrun 2006). In teaching mathematics the same can be manifested through students emotions towards mathematics, his beliefs about mathematics and the overall attitude of students towards mathematics. Among them is essential to set aside emotional reactions related to the classroom environment, teacher-student relationship, student's general emotional state and emotions directly affecting him or which result from learning and teaching processes. The emotions that occur in the classroom are: anxiety, fear, boredom, shyness, (dis) satisfaction, curiosity, relaxation, nervousness, preoccupation, anger, sadness, self-esteem, self-confidence, insouciance, excitement, interest, pride, etc. Among the many emotions that students show in the classroom, the dominant emotion is often boredom (Kolak and Majcen, 2011). However, the fear of mathematics prevails in math class or as it is commonly referred to as "mathematical anxiety" in foreign literature (Geist, 2010; Sloan, 2010). Fear of mathematics by its definition relates to academic emotions and is defined as a feeling of tension and anxiety which makes it difficult to manipulate numbers and solve mathematical problems in everyday and school situations (Richardson and Suinn, 1972). Emotions and beliefs that individuals have towards mathematics influence their motivation which is why they avoid learning mathematics individually. On the other hand, self-confidence and self-esteem grow with each success and are mutually supportive and reinforcing. Accordingly, some authors determine the model of the success cycle in the development of mathematical ability (Koshy et al., 2009). This cycle consists of three key components: self-confidence in your abilities, positive beliefs about mathematics; hard work, perseverance and requests for challenging tasks; achievement and success in mathematics. The authors note that, while this cycle has no beginning and the components are cyclically interconnected, correspondingly emotions stay in constant interaction with the teaching process. Moreover, Price and Biggs (2001) describe the math anxiety cycle and math evasion in which unpleasant emotions affect the decreased motivation of students and the lack of independent learning. These emotions and beliefs about mathematics are associated with the lack of self-confidence and a sense of incompetence, which is why a lot of capable students avoid difficult tasks, invest little effort and give up easily when faced with difficulties (Arambašić et al., 2005). Emotions therefore influence the processes and outcomes of teaching and learning, while at the same time every new experience of the teaching process affects the emotions that a student has in context to a certain subject, and school in general. The position and role of emotions in teaching mathematics can be described using Bandura's theory of self-efficacy by which emotions and beliefs influence the goal selection and activities directed at a certain objective along with the effort and determination that an individual devotes to reaching them (Bandura, 1991). Consequently, the term "academic self-efficacy" is often used which refers to individual's belief on

his own merits in the context of a specific academic domains. Bandura (1989) emphasizes self-efficacy as learned behaviour that begins in early childhood and whose development is impacted by (not) successes in similar situations and emotions we experience at the same time, our learning by modelling successful people and imagining ourselves performing successfully. Furthermore, Pekrun's (2006) control-value theory of achievement emotions emphasized that emotions have a primary role in activating, maintaining or reducing students' motivation. Difficulties that students encounter in math class can be described with self-efficacy theory and also with control-value theory of achievement emotions, which indicates that emotions play an important and perhaps even a decisive role in learning and teaching mathematics. In conjunction with the social dimension of teaching mathematics, emotions are to be considered within the classroom environment in which the teacher creates conditions for a stimulating and motivating environment without fear, boredom and other emotions that are obstacles for successful learning.

## 2.2. Classroom environment in teaching mathematics

All the emotions that occur during teaching process, such as students' emotional state, teacher-student relationship, as well as the relationship between students, are part of the classroom environment. In class students have relatively permanent and specific models of behaviour, interrelationship, attitudes towards learning and participation in curricular activities, forms of mutual communication and social interaction with teachers (Jurčić, 2012). Thus, the author mentions the totality of teacher's life and work that comprises the classroom environment. Bognar and Dubovicki (2012) define emotional atmosphere as overall emotional state of all the participants in education process. Jurčić (2012) states teacher's support, (over)burdening of students with curriculum, class cohesion and fear of academic failure as determinants of classroom environment. Emotions that students experience within math class indicate the importance of regarding students' emotions in teaching process as equally important as the cognitive part and fundamental for successful teaching. Nevertheless, in education of mathematics teachers the prevalent approach in methodology is orientation towards the teacher instead of student (Matijević, 2010). Within that frame, methodology of teaching math is based on precise and concise presentation of lesson material in order to meet the scientific aspects of mathematics. In this scientific approach to mathematics teachers often fail in basic pedagogical approach to teaching and students in order to focus on teaching instead of explaining, that is, methods most appropriate considering the capabilities, former knowledge and emotional state of each student. Perception of teaching mathematics as a scientific discipline influences the content and manner of teacher education and training, which results in teacher-oriented methodology of math as well as expert qualifications on the top of teacher's competence scale. Research on emotions in teaching mathematics indicate classroom environment as priority in subject curriculum, while stating that teacher's competencies should be more oriented towards detecting students' emotional states. Some authors, therefore, point to "anti-anxiety curriculum" in teaching mathematics to diminish negative emotional student reaction (Geist, 2010). Accordingly, didactic-methodical aspects of teaching math should contain stimulating and encouraging classroom environment as integral feature of teacher performance. Elements in classroom environment

are only as relevant as their contribution to learning and teaching quality, as well as teacher and student satisfaction (Jurčić, 2012). Considering the prevalence of problems in teaching mathematics in the context of social and affective aspects of class, some authors claim that didactics of mathematics falls within the field of social sciences (Straesser, 2007), which raises one of the on-going issues in pedagogy regarding teacher competencies and manner and content of their education.

### 3. Competencies of mathematics teachers

Competence represents a person's acknowledged expertise and ability and refers to the scope of decision making authority of one person or institution as well as jurisdiction (Anić, Goldstein, 2004). In the context of teaching, competencies are referred to as combination of knowledge, skills, attitudes and values which enable individual to actively take part in a particular situation. Most authors diversify competence profile of a teacher to many sub-categories of competencies which derive from the nature of teaching profession: didactic-methodical, subject related, pedagogical, personal, communicational, social, intercultural, emotional, civic, reflexive etc. Taking into account the specific problems in teaching mathematics, as well as the increase in number of research in pedagogical competencies of mathematical teachers, it is only logical to ask if teachers of mathematics need to have better pedagogical competencies than teachers of other subjects. Namely, the challenges facing math teachers are not related to their field of work exclusively, but are also pedagogical issues which have more severe implications on educational values of students' (further) schooling. Another question that needs clarification is which competencies are required, in other words, what criteria does a competent teacher meet? Are pedagogical competencies only those relevant for educational purpose of teaching or do they have any other functions? From the scientific pedagogical perspective, pedagogically competent teacher questions the teaching subject within the matter and scientific frame, considers the concepts and contents and the way to process and acquire them, and finally the image teachers constructs about the subject and scientific discipline they teach (Palekčić, 2007). Accordingly, pedagogically competent teachers have to possess knowledge and skills which provide them with meta-theoretical understanding of their subject and set goals. Jurčić (2012) lists the pedagogical competencies of modern teacher as: personal, subject, communicational, didactic-methodical, reflexive, social, emotional, intercultural and civic. He also claims that for the successful teacher performance pedagogical competence in five areas is necessary: methodology of developing subject curriculum; organization and managing educational process; creating classroom environment; defining student's academic performance; developing a model of teacher-parent educational partnership. This way the author defines pedagogical competence as an individual's general competence whose sub-categories are competencies that most authors list when determining overall teacher competence profile. The concept of pedagogical competencies is sometimes used for setting the minimum professional standard a teacher should meet in order to act according to standards and requirements of teaching profession, and is mostly determined by law (Gluga, 2002). This way pedagogical performance of a teacher is actually brought to basic scientific approach to students and class, which is based on ascertained findings, and not on

personal convictions, instincts, values and other. Because of the prevailing negative perception of mathematics, the teacher should aim to develop confidence in students' own mathematical abilities. In order to manage students' competencies, the teacher must also learn to manage method of emotional meta-competence (Kolak and Majcen, 2011). Teaching process is, namely, filled with emotions which are in continuous interaction with student evaluation. In a given situation the teacher must prevent any unwanted emotions by giving support to the students in order to develop positive attitude towards mathematics and, lastly, towards students' own abilities and themselves as individuals. In practice, unfortunately, theoretical knowledge on emotions in teaching mathematics is insufficiently applied and poorly represented in mathematics teacher training and education. Along with that, some research has shown that math teachers consider having profound, conceptual understanding of math the only necessary factor for quality teaching (e.g. Patton et al., 2008). Theory, as well as practice, has confirmed the necessity of high expertise in mathematics, but not its exclusiveness in successful teaching (Turnuklu, Yesildere, 2007). On the other hand, math teachers do not have the possibilities for further education in postgraduate studies in field of mathematics education, while specialists in didactics and methodologists who educate them have scientific qualifications only in the field of the mathematics. There is lack of doctoral programs with focus on issues of learning, teaching and teacher education, curriculum and qualitative researches in mathematics education. This raises the question of qualifications of experts who educate teachers, which is one of the on-going pedagogical issues regarding continuous systematic scientific structure of vocational didactics (Lenzen, 1989; as cited in Gudjons, 1994). Whether vocational didactics/methods belong within the area of education science is not yet clear, which is not the case with particular vocations, providing all their specificities within the same educational system are encompassed in analyses. For example, the US has postgraduate doctoral studies for math teachers, and the lack of standardized programmes in the field of math education, which is an inadequacy itself, is considered a challenge in improving math teaching. (Hiebert et al., 2001). Prerequisite for quality teaching is a pedagogically competent teacher, which, due to pedagogical requirements of modern math teaching, indicates the need to incorporate vocational didactics studies within the education sciences. Accordingly, specialists in didactics/methodologists in teaching mathematics should, due to the level of pedagogical issues, also possess qualification expert of education, within the field of mathematics.

#### **4. Final considerations**

No consideration of issues in teaching mathematics should be restricted only to the domain of teaching process. Failures and accomplishments of teaching mathematics come intertwined with students' emotions and beliefs, which, interconnected with external factors such as family, society and school, effect student's success and further development. Considering social dimensions of mathematics education, successful teacher should develop adequate communicational, reflexive, social and emotional skills. Stimulating and cooperative environment, as well as competent teacher who employs effective pedagogical strategies and teaches in a way



that both encourages and motivates students, are necessary for successful teaching and learning mathematics. Students' emotional reactions, along with class environment, have proved to be one of the key factors in the successful teaching process. Mathematics teachers require a form of "hidden curriculum" in the subject teaching, which would continuously highlight the importance of practice, revision and persistence as keys to acquiring mathematics. The fundamental basis for this is encouraging class environment, where the teacher takes into consideration the emotional state of a student, especially regarding academic emotions. In order to achieve that, the teacher must possess the ability of emotional meta-competence to control and manage students' emotions. This type of programme ought to be implemented in every lesson and include solving tasks alongside with discussions on ways of thinking and abilities needed for specific tasks, as well as ways of ensuring that every student can achieve the desired result. Once this is accomplished, the existing lesson plans and programmes prescribed by curriculum will become attainable to every student and void of any restrictions which may impede their personal development and progress in other subjects as well. The challenging aspects of teaching mathematics are not reflected in clarifying the specific terminology, but in the ability of a teacher to expose students to and face them with mathematic content, in order to then facilitate resolving and overcoming possible difficulties students may encounter. This notion is the core of student-oriented curriculum, which requires pedagogical competence of the teacher. Teachers' pedagogical training should not be identified merely with educational purpose of teaching, but, for subjects such as mathematics, should focus on specificities of learning and teaching and, in that way, complement didactic-methodical aspects of teaching. It is, therefore, necessary to interpret pedagogical competencies correctly from the scientific pedagogical perspective and understand their importance in the overall teacher training process. Pedagogical competence is based on general scientific approach to teaching and students, and as such becomes crucial in teaching profession, especially in mathematics, where pedagogical problems occur frequently. Educational politics must provide conditions for quality mathematics teacher training and enable them further education in practical and scientific field with accent on connecting the pedagogical theory with teaching mathematics and challenges of mathematics education.

## References

- [1] ANIĆ, V., GOLDSTEIN, I. (2004), *Rječnik stranih riječi*, Novi Liber, Zagreb.
- [2] ANDREWS, P., ROWLAND, T., BRINDLEY, S., et al. (2014), *MasterClass in Mathematics Education: International Perspectives on Teaching and Learning*, Bloomsbury Academic.
- [3] ARAMBAŠIĆ, L., VLAHOVIĆ-ŠTETIĆ, V., SEVERINAC, A. (2005), *Je li matematika bauk? Stavovi, uvjerenja i strah od matematike kod gimnazijalaca*, Društvena istraživanja, Vol. 14, No. 6 (80).
- [4] ASCHRAFT, M. H. (2002), *Math anxiety: Personal, educational, and cognitive consequences*, Current Directions in Psychological Science, 11 (5), 181–185.

- [5] BANDURA, A. (1989), *Perceived self-efficacy in the exercise of personal agency*, The Psychologist: Bulletin of the British Psychological Society, 2, 411–424.
- [6] BANDURA, A. (1991), *Self-regulation of motivation through anticipatory and self-regulatory mechanisms*, In R. A. Dienstbier (Ed.), *Perspectives on motivation: Nebraska symposium on motivation* (Vol. 38, pp. 69–164), Lincoln: University of Nebraska Press.
- [7] BOGNAR, L., DUBOVICKI, S. (2012), *Emocije u nastavi*, Hrvatski časopis za odgoj i obrazovanje, Vol. 14, No. 1, 135–153.
- [8] D'AMBROSIO, U. (1999), *Literacy, Matheracy, and Tehnoracy: A trivium for today*, *Mathematical Thinking and Learning*, 1 (2), 131–154.
- [9] Europska Komisija/EACEA/Eurydice (2012), *Developing Key Competences at Schools in Europe: Challenges and Opportunities for Policy*, Eurydice Report, Luksemburg: Ured za publikacije Europske unije.
- [10] GEIST, E. (2010), *The Anti-Anxiety Curriculum: Combating Math Anxiety in the Classroom*, *Journal of Instructional Psychology*, 37 (1).
- [11] GIESECKE, H. (1993), *Uvod u pedagogiju*, Educa, Zagreb.
- [12] GLIGA, L. (2002), *Standarde profesionale pentru profesia didactica*, Bucuresti: M.E.C.
- [13] GUDJONS, H. (1994), *Pedagogija – temeljna znanja*, Zagreb: Educa.
- [14] HEMBREE, R. (1990), *The nature, effect and relief of mathematics anxiety*, *Journal for Research in Mathematics Education*, 21 (1), 33–46.
- [15] HIEBERT, J., KILPATRICK, J., LINDQUIST, M. M. (2001), *Improving U.S. doctoral programs in mathematics education*, In R. Reys, J. Kilpatrick, *One field, many paths: U.S. doctoral programs in mathematics education* (pp. 153–159), Washington, DC: Conference Board of the Mathematical Sciences.
- [16] JURČIĆ, M. (2012), *Pedagoške kompetencije suvremenog učitelja*, Recedo, Zagreb.
- [17] KOLAK, A., MAJČEN, M. (2011), *Emocionalne reakcije učenika u nastavnom procesu kao poticaj razvoju kreativnosti*, U: Gojkov-Rajić, A.; Grozdanka, G. (ur.), *The gifted in the process of globalization*, 337–360.
- [18] KOLAK, A. (2014), *Students' Emotional Responses Related to the Teaching Activity*, International Teacher Education Conference, Dubai.
- [19] KOSHY, V., ERNEST, P., CASEY, R. (2009), *Mathematically gifted and talented learners: theory and practice*, *International Journal of Mathematical Education in Science and Technology*, Vol. 40., No. 2, 213–228.
- [20] MATIJEVIĆ, M. (2010), *Između didaktike nastave usmjerene na učenika i kurikulumske teorije*, Zbornik radova Četvrtog kongresa matematike, Zagreb: Hrvatsko matematičko društvo i Školska knjiga, str. 391–408.
- [21] MILIVOJEVIĆ, Z. (2007), *Emocije*, Novi Sad: Psihopolis Institut.
- [22] Ministarstvo znanosti, obrazovanja i športa, RH (2010), *Nacionalni okvirni kurikulum za predškolski odgoj i obrazovanje te opće obvezno i srednjoškolsko obrazovanje*, Zagreb.

- [23] OECD (2013), PISA 2012 Results: *Ready to Learn*, Students Engagement, Drive and Self-Beliefs (Volume III), PISA, OECD Publishing.
- [24] OECD (2013), PISA 2012 Results: *What Makes Schools Successful?*, Resources, Policies and Practices (Volume IV), PISA, OECD Publishing.
- [25] PALEKČIĆ, M. (2007), *Od kurikula do obrazovnih standarda*, U: Previšić, V. (ur.), Kurikulum – Teorije, metodologija, sadržaj, struktura, Zagreb: Zavod za pedagogiju Filozofskog fakulteta u Zagrebu i Školska knjiga, 39–115.
- [26] PALEKČIĆ, M. (2008), *Uspješnost i/ili učinkovitost obrazovanja nastavnika*, *Odgojne znanosti*, 10 (2), 157–177.
- [27] PATTON, B. A., FRY, J., KLAGES, C. (2008), *Teacher Candidates' and Master Math Teachers' Personal Concepts about Teaching Mathematics*, *Education*, 128 (3), 486–497.
- [28] PEKER, M. (2008), *Pre-service teachers' teaching anxiety about mathematics and they learning styles*, *Eurasia Journal of Mathematics, Science & Technology Education*, 5 (4), 335–345.
- [29] PEKRUN, R. (2006), *The Control Value Theory of Achievement Emotions: Assumptions, Colloraries and Implications for Educational Research and Practice*, *Educ. Psychol. Rev.* 18: 315–341.
- [30] PREIS, C., BIGGS, B. T. (2001), *Can Instructors Help Learners Overcome Math Anxiety?*, *ATEA Journal*, 28 (4), 6–10.
- [31] PREVIŠIĆ, V. (1999), *Škola budućnosti: humana, stvaralačka i socijalna zajednica*, *Napredak*, 140 (1), 7–16.
- [32] RICHARDSON, F., SUIN, R. M. (1972), *Mathematics anxiety rating scale: Psychometric data*, *Journal of Counseling Psychology*, 19, 551–554.
- [33] SLOAN, T. R. (2010), *A quantitative and qualitative study of math anxiety among pre-service teachers*, *The Educational Forum*, 74 (3), 242–256.
- [34] STRAESSER, R. (2007), *Didactics of mathematics: more than mathematics and school!*, *ZDM Mathematics Education*, 39: 165–171.
- [35] TERHART, E. (2001), *Metode poučavanja i učenja*, *Educa*, Zagreb.
- [36] TURNER, J. C., MEYER, D. K., ANDERMAN, E. M., MIDGLEY, C., GHEEN, M., et al. (2002), *The classroom environment and students' reports of avoidance strategies in mathematics: A multimethod study*, *Journal of Educational Psychology*, 94 (1), 88.
- [37] TURNUKLU, E. B., YESILDERE, S. (2007), *The Pedagogical Content Knowledge in Mathematics: Pre-Service Primary Mathematics Teachers' Perspectives in Turkey*, *International Electronic Journal of Mathematics Education*, 6 (1), 40–59.
- [38] VINSON, B. M. (2001), *A comparison of pre-service teachers' mathematics anxiety before and after a methods class emphasizing manipulatives*, *Early Childhood Education Journal*, 29 (2), 89–94.
- [39] WIDMER, C. C., & CHAVEZ, A. (1982), *Math anxiety and elementary school teachers*, *Education*, 102 (3), 272–276.

Contact address:

Zoran Horvat  
Electrotechnical School Varaždin  
Hallerova aleja 5  
42000 Varaždin, Croatia  
e-mail: zhorva@gmail.com

## Izazovi suvremene nastave matematike i kompetencije nastavnika

---

---

Zoran Horvat

Elektrostrojarska škola Varaždin, Varaždin, Hrvatska

*Sažetak.* Autor u radu iznosi aktualne probleme vezane uz nastavu matematike i matematičko obrazovanje te ističe kako se u teorijskim i praktičnim razmatranjima podcjenjuje uloga društvene dimenzije nastave matematike. Sukladno tome percipira matematičko obrazovanje kao svojevrsni društveni konstrukt umjesto tradicionalnog određenja (nastave) matematike kao isključivo znanstvene discipline. Kao bitne odrednice kvalitetne nastave matematike izdvaja emocionalne reakcije učenika, razredno ozračje i kompetencije nastavnika. U kontekstu suvremene nastave matematike kritički pristupa pitanju načina i sadržaja osposobljavanja nastavnika te kompetencijama koje odlikuju kvalitetnog nastavnika matematike. Uvažavajući zahtjeve i specifičnosti nastave matematike koji su u domeni pedagoške teorije i prakse, ističe pedagoške kompetencije nastavnika i njihovo određenje sa pedagoškijske znanstvene perspektive. Pregledom relevantnih istraživanja navodi kako je poticajno razredno ozračje jedna od ključnih pretpostavki učeničkog uspjeha u matematici, te kako se didaktičko-metodičke smjernice nastave matematike moraju temeljiti na individualnosti učenika te zahtjevima i poteškoćama s kojima se oni susreću u nastavi.

*Ključne riječi:* nastava matematike, emocionalne reakcije učenika, razredno ozračje, pedagoške kompetencije nastavnika matematike

## Teaching Mathematics in early education: current issues in classrooms

---

---

Ksenija Romstein\*<sup>1</sup>, Stanislava Irović<sup>2</sup> and Mira Vego<sup>3</sup>

<sup>1</sup>Faculty of Education in Osijek, Josip Juraj Strossmayer University of Osijek, Croatia

<sup>2</sup>Faculty of Humanities and Social Sciences in Osijek, Josip Juraj Strossmayer University of Osijek, Croatia

<sup>3</sup>Kindergarten Osijek, Croatia

*Abstract.* Social perception of teaching mathematics in early education is often formally utilized, i.e. it is interpreted as irrelevant and inappropriate for children aged three to seven. In order to find out if mathematics is present in early education, a survey was conducted in 37 kindergartens in three Croatian counties and one canton in Bosnia and Herzegovina. For that purpose *Scale for assessing surroundings and interaction* was constructed (scale's Cronbach's alpha .93), and its subscale *Mathematics* was applied (subscales' Cronbach's alpha .78). The results show that the frequency of mathematical activities in classrooms correlates with preschool teachers' levels of formal education, chronological structure of a classroom, and overall number of children in a classroom. So, three-year-olds and mixed age groups have fewer opportunities for mathematical activities, while six-year-olds have mathematical activities on a daily basis. Also, in the groups with less than 15 children, and groups with more than 25 children, math activities are occasional. As far as the structure of materials and type of activities are concerned, preschool teachers organize such activities that allow younger kindergarten children to practice comparing quantity and recognizing patterns (concrete objects, mostly building blocks and jigsaw puzzles) while older kindergarten children can enjoy counting and measuring materials of diverse structures, and geometry. The results suggest that preschool teachers implicitly see mathematics as an academic activity, and therefore design it accordingly to the concept of school readiness. On a pragmatic level, results can be used as a turning point for math activities in the context of early education, i.e. an argument for questioning contemporary pedagogical practice regarding teaching mathematics, and scrutinizing the role of preschool teachers in that area.

*Keywords:* early education, math activities, preschool teachers, preschool children

*G. R. (boy, 5 yrs.) throwing stones in the water:  
"Look at this stone. When it drops into water,  
it gives its energy to the water. . ."*

---

\*Corresponding author.

## 1. Introduction

In a wider social context, early education is seen as a place for supporting young children's development and learning. This is a vague goal, based upon social policies and recommendations concerning early outcomes. In that context, preschool teachers tend to fulfill social expectations (including parents' needs) such as facilitating a child's language development, enhancing its cognitive abilities and social competences. Subsequently, language and speech development, social skills and cognitive abilities are in the center of attention of social factors (parents, policy-makers etc.), yet math is rarely seen as an important early education activity. Even if it is expressed as a desirable field of early learning, it is placed within a broader context of science and utilized for other purposes, and least for functional application in everyday life. This reduction of math could have long-term consequences since "providing young children with research-based mathematics and science learning opportunities is likely to pay off with increased achievement, literacy, and work skills in these critical areas" (Brenneman, Stevenson-Boyd and Frede, 2009, 1). Despite contemporary interpretation of early math learning, where the activities such as measuring, discovering spatial relations, recognizing patterns etc. are identified as prerequisite for efficient functioning in immediate environment, preschool teachers still use math selectively, according to their own opinion about the importance of math. Implications for math activities in early education could be found mostly in psychology and neuroscience due to a close connection of math and developmental processes. As Falk-Frühbrodt (2005, 21) states, math facilitates "visual and visual-spatial perception, tactile-kinesthetic perception, vestibular perception, auditory perception, language processing, and memory and thinking." These are important areas of human development and, if integrated, allow one's functioning in everyday life. Also, these processes shouldn't be confused with mathematical operations, because math is more than number manipulation and equations. According to Wittman (2006) math in early education is consisted of numbers and sizes (e.g. length, weight, volume etc.), geometry, spatial relations and recognizing patterns (e.g. inside/outside, up/down, spheres, triangles, rectangles etc.) and logic operations such as classification, seriation, grouping etc. Therefore, quality preschool programs should incorporate math activities since they can address young children, children with various knowledge and children from diverse backgrounds, including underprivileged children and children with disabilities (Sarama and Clements, 2009). This is possible due to the presence of math in everyday life, not just in formal education, which is considered to be one of the major arguments for implementing math activities in early education. Moreover, a traditional approach to math, where identification of numbers and counting were appreciated as core activities (Brenneman, Stevenson-Boyd and Frede, 2009) are nowadays substituted with developmental models of math learning. In this approach, math is scrutinized in accordance to the child's development. For Clements and Sarama (2009), math learning is a dynamic process with several phases, and its characteristics are changing over time. So infants and toddlers are in "the pre-mathematical reasoning" where the emphasis is put on manipulation with objects and shapes, and exploration of its properties; and gradually, children "mathematize" the experience of manipulation into abstract quantitative concepts such as numbers, equations etc. (Clements and Sarama, 2009, 205). It means that children's age couldn't be con-

sidered a reason for avoiding math activities in nurseries and kindergartens, since math is present in everyday life, regardless of the preschool teachers' intentions.

## 2. Methods

The purpose of this paper was to identify the main characteristics of preschool classrooms in relations to math activities and materials. For that purpose *Scale for assessing surroundings and interaction* was constructed and its subscale *Mathematics* was applied in preschool classrooms. Since Cronbach's  $\alpha$  for the entire scale was .93, and for its subscale *Mathematics* Cronbach's  $\alpha$  was .78, this subscale was considered to be appropriate for data analysis. Overall 37 early year classrooms in three Croatian counties (Counties of Osijek-Baranya, Vukovar-Syrmia, and Slavonski Brod-Posavina) and one canton in Bosnia and Herzegovina (Posavina Canton) were observed and assessed. As far as the geographic placement goes, 15 kindergartens were in rural areas, or in suburbia, while 22 were in urban area. The data was collected in May 2014, and afterwards analyzed in SPSS v.17 statistic package. Statistical analysis consisted of both descriptive and inferential statistics. In this way a classroom structure as well as the connection between factors could be interpreted in a more objective manner.

### 2.1. Participants

In accordance to overall number of classrooms observed, 37 preschool teachers were included in data collection. Although some of the classrooms have two preschool teachers involved, during data collection (8:00–12:00 o'clock) only one preschool teacher was present. As far as their level of formal education is concerned, 60% had BA (baccalaureus, i.e. EQF 6) level of education and 40% had MA (master, i.e. EQF7) level of education. Also, they varied in professional experience: 32.43% had less than 5 years of professional experience in early education, 27.02% had from 6 to 10 years of professional experience, 13.51% had from 11 to 15 years of professional experience, 16.21% had from 16 to 20 years of professional experience, 5.40% had from 21 to 25 years of professional experience, and 5.40% had more than 25 years of professional experience. All preschool teachers were females.

## 3. Results

Three hypotheses were addressed in this research:

H<sub>1</sub>: There is no relationship between the level of preschool teachers' formal education and the frequency of math activities in classrooms.

H<sub>2</sub>: There is no relationship between the chronological structure of children and the frequency of math activities in classrooms.

H<sub>3</sub>: There is no relationship between the overall number children and the frequency of math activities in classrooms.

### 3.1. Teachers' formal education and frequency of math activities in classrooms

The data on frequency of organizing math activities were collected from preschool teachers, i.e. they were asked how often they organized math activities.

Table 1. ANOVA table for level of preschool teachers' education.

ANOVA					
level of preschool teachers' education					
	Sum of Squares	df	Mean Square	<i>F</i>	Sig.
Between Groups	.910	3	.303	1.260	.345
Within Groups	2.167	9	.241		
Total	3.077	12			

First hypothesis “*There is no relationship between the level of preschool teachers' formal education and the frequency of math activities in classrooms*”, is rejected due to statistical analysis in ANOVA ( $F(3, 9) = 1.260, p = .345$ ). As data analysis showed, there is a relationship between the level of preschool teachers' formal education and frequency of math activities in classrooms.

In this research, preschool teachers had different levels of formal education. This is due to the fact that Croatia has introduced Bologna, and subsequently has two levels of education for preschool teachers: BA (baccalaureus, i.e. EQF level 6) and MA (master, i.e. EQF level 7).

Teachers were asked to estimate how often they organized math activities in their classrooms.

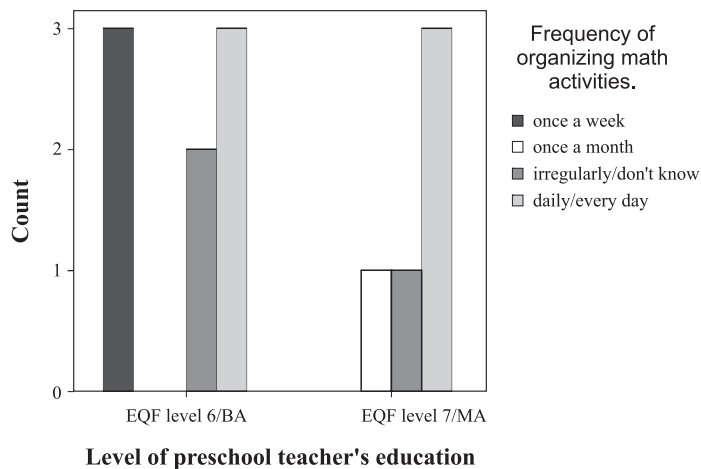

Figure 1. Crosstab for level of preschool teachers' level of education/frequency of organizing math activities in classrooms.



As this figure shows, preschool teachers with MA (EQF level 7) more often organize math activities on daily basis, if compared to other responds. However, preschool teachers with BA level of education (EQF level 6) are offering math activities weekly, and also very often on a daily basis. These results could be interpreted ambiguously: the level of formal education does have an impact on the prevalence of math activities, therefore preschool teachers with MA level more often organize math activities daily. Another interpretation is concerned with preschool teachers' understanding of math. I.e. BA teachers (maybe) organize math activities on a daily basis, but don't recognize them as math activities *per se*. If this is true, than the level of formal education has an impact on preschool teachers' meta-competence, which is an important aspect of the quality of early education.

### 3.2. Chronological structure of children and frequency of math activities in classrooms

The data about frequency of math activities was obtained by preschool teachers, while the data on chronological structure of classrooms were gathered from pedagogical documents.

Table 2. ANOVA table for chronological structure of children in classrooms.

ANOVA					
age					
	Sum of Squares	df	Mean Square	<i>F</i>	Sig.
Between Groups	.583	4	.146	.307	.867
Within Groups	4.750	10	.475		
Total	5.333	14			

Thus second hypothesis “*There is no relationship between the chronological structure of children and the frequency of math activities in classrooms*”, is rejected due to statistical analysis in ANOVA ( $F(4, 10) = .146, p = .867$ ). As far as chronological structure of the classroom is concerned, the results showed that children's age is connected with the frequency of math activities, prepared by preschool teachers.

An insight into pedagogical documents revealed the following: 19% of classrooms were for toddlers (age two and three), 27% for four and five-yrs-old children, 40% for preschoolers (age six and more), and 14% were for the mixed age groups. This diversity in the age structure of children emerged from a wide geographic placement of the observed classrooms. I. e. in Croatia and Bosnia and Herzegovina, every county has a freedom to organize its early education, according to its resources and the needs of families perceived by stake holders. Another factor that has an impact on the chronological structure of classrooms are the demographic trends, which have to be considered during the research and interpretation of results.

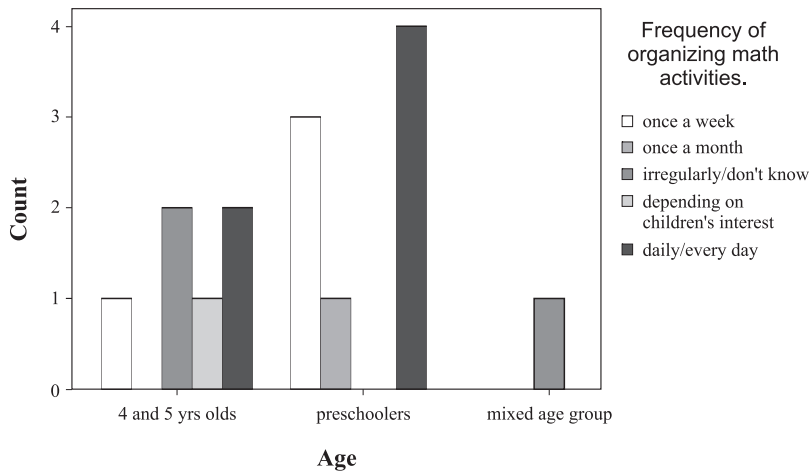

*Figure 2.* Crosstab for the chronological structure of the classroom (age of children)/frequency of organizing math activities.

Obviously, math activities on a daily basis are mostly offered to preschoolers (age six and on). In the classrooms for four and five-yrs-old children, the practice of math activities is diverse – teachers say they organize it irregularly, weekly, and daily. Sadly (but partially expected), math is least of all present in the mixed age groups, probably due to the fact that preschool teacher have to choose, very carefully, an activity which is to be offered to all children in the mixed age group. Alternatively, preschool teachers working in the mixed age groups could organize several activities for different age groups, but we suppose it is inconvenient for them. This brings us to previous findings where the level of preschool teachers' formal education has emerged as an important aspect for math in early education.

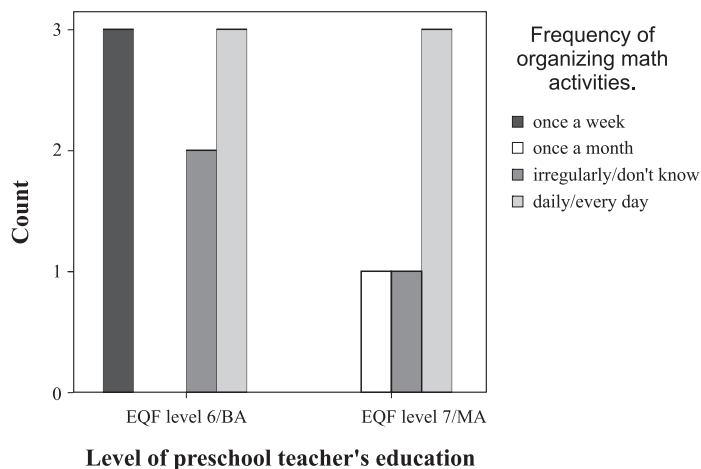

*Figure 3.* Crosstab for level of preschool teachers' education/frequency of organizing math activities.

Preschool teachers with MA level of education (EQF level 7), when compared to teachers with BA level of education (EQF level 6) are more regular in the organization of math activities. It looks like they recognize the presence of math in everyday activities. Also, teachers with BA level of education are organizing math weekly, which could be influenced by other factors such as program design and available resources.

### 3.3. Number of children in classrooms and frequency of math activities in classrooms

The data on overall number of children involved in particular classroom was gathered from pedagogical documents.

Table 3. ANOVA table for overall number of children in classrooms.

ANOVA					
number of children in classroom					
	Sum of Squares	df	Mean Square	<i>F</i>	Sig.
Between Groups	.000	4	.000	.000	1.000
Within Groups	6.000	10	.600		
Total	6.000	14			

The last hypothesis “*There is no relationship between the overall number children and the frequency of math activities in classrooms*”, is rejected due to statistical analysis in ANOVA ( $F(4, 10) = .000, p = 1.00$ ). Therefore, the overall number of children in the classrooms was proven to be an important factor for the organization of math activities in the classrooms.

As far as the number of children in particular classroom is concerned, 5.4% classrooms had less than 15 children enrolled, 24.3% had from 15 to 19 children enrolled, 48.6% had from 20 to 25 children enrolled, and 21.6% had more than 25 children enrolled. This variety in the overall numbers of children enrolled in early education is a reflection of two factors: one is the geographic placement of kindergartens – 15 of them (i.e. 40%) were in rural areas, or in suburbia, while 22 (i.e. 60%) were in urban areas. Subsequently, rural and suburban areas have either a smaller number of children in classrooms (less than 15) or a large number of children (more than 25). Classrooms from 20 to 25 enrolled children prevailed in the urban areas. Secondly, the chronological age of children affected the overall number of children enrolled, i.e. traditionally classrooms for toddlers are for a smaller number of children.

Interesting, children placed in classrooms of 20 to 25 children (which is in Croatia considered a standard number of children per classroom) have fewer opportunities for math activities than other groups. Preschool teachers offer them math irregularly, monthly, and weekly. However, according to preschool teachers’

claims, they observe classroom activities and offer math when they notice the children's interests in such activities. In relation to the previous findings, preschool teachers' meta-competence arises once again as a probable cause for this practices. I.e. preschool teachers' own notion of the importance of math in early years has an impact on organizing math activities in classrooms. We also find very interesting the fact that the classrooms with a small overall number of children, and those are mainly groups for toddlers, often have math activities (daily and weekly). This practice is also present in classrooms with more than 25 children, which brings us to the question of characteristics of math activities and materials in the early education. I.e. math in early education could be organized in various ways, yet preschool teachers have a leading role in that process.

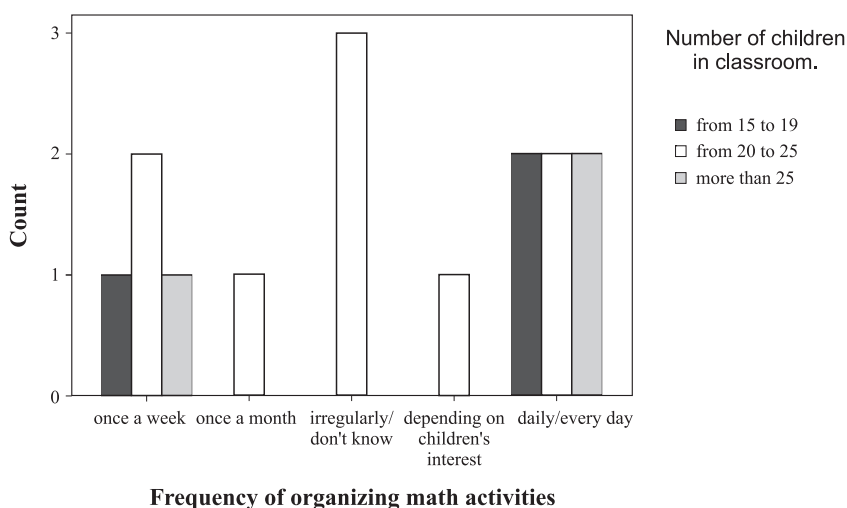

Figure 4. Crosstab for frequency of organizing math activities in the classrooms/number of children enrolled in particular classroom.

### 3.4. Materials for math activities in accordance to children's chronological age

As far as materials are concerned, we were curious to find out more about the chronological age of children and materials they have at their disposal. This issue is important, since math activities are more than a manipulation of numbers, numeric operations and equations. The data on structure of materials and activities were collected by observing a particular classroom. For that purpose subscale *Mathematics* was applied. It consists of 6 items:

1. Small objects adequate for *counting* (such as coins, marbles, buttons, bricks etc.) are available to children.
2. Objects for *measuring* fluids and solid materials (such as spoons, cups, thermometers, gauge glasses, ribbons, meters etc.) are available to children.

3. Objects for *comparing* quantities (such as diverse size toys and figures, bricks with various dimensions, graduated cylinders, graph charts, cards etc.) are available to children.
4. Objects for *recognizing patterns* (such as jigsaw puzzles, magnets, didactic puzzles etc.) are available to children.
5. Objects for *recognizing numbers* (such as rulers, scales, domino, lotto, telephones, clocks, books, cash-box, calendars, cards etc.) are available to children.
6. *Geometric bodies and shapes* made from diverse materials (wood, plastic, foam, cardboard etc.) are available to children.

These items were assessed with 4 points: 1 for insufficient/inadequate, 2 for minimal, 3 for excellent/sufficient and 4 for not applicable/not suitable for evaluation. The data was collected in May 2014.

### 3.4.1. Presence of materials adequate for counting

In this item, we observed whether small objects adequate for counting, such as coins, marbles, buttons, bricks etc., are present in classrooms and available for children's autonomous manipulation.

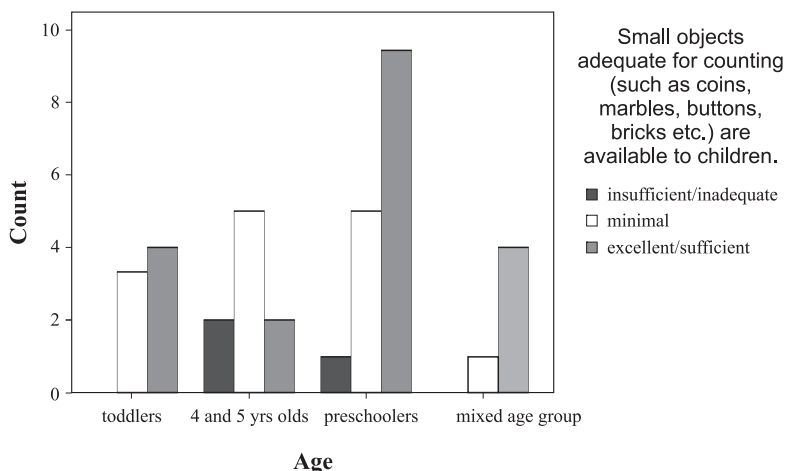

Figure 5. Crosstab for children's age/objects adequate for counting.

As this figure shows, the level of excellence is present in classrooms for preschoolers (age six and on). Surprisingly, small objects are more often present in classrooms for toddlers than in classrooms for 4 and 5 yrs-old. This could mean that preschool teachers organize math activities according to some other aspects of early curricula, not children's age. We still have to find out what are these aspects.

### 3.4.2. Presence of materials adequate for measuring

As far as measuring is concerned, it is one of the rare aspects of math which is expected to be highly present, due to the canon of psychology within preschool teachers' formal education (e.g. classification and seriation in Piaget's theory of cognitive development). For that purpose, we have observed whether the materials such as spoons, cups, thermometers, gauge glasses, ribbons, meters etc., suitable for measuring fluids and solid materials, are available to children.

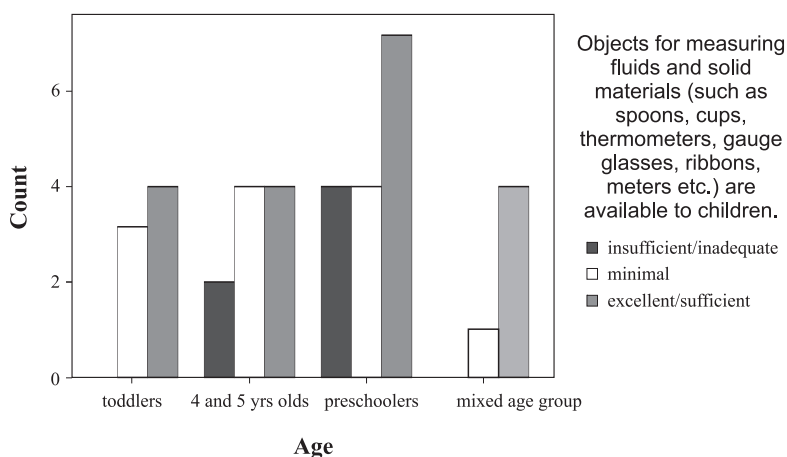

Figure 6. Crosstab for children's age/objects adequate for measuring.

As expected, these materials are widely present in all classrooms, for all ages, from toddlers to preschoolers and mixed age groups. It means that preschool teachers organize the measuring according to the estimated value of such activities. Since they learn about cognitive development in psychology, where Piaget's theory is one of the most important, maybe in the future, math could be taught more on an interdisciplinary manner, nested in other scientific fields such as pedagogy, art, and methodology, not only by itself, as it is the current practice.

### 3.4.3. Presence of materials adequate for comparing quantities

Similarly to measuring, comparing quantities is also present in the canon of psychology, and scrutinized in this scientific field. Comparing quantities presupposes the presence of certain cognitive abilities, which comes by experience and growth. Thus, it is expected that materials for comparing quantities would be mainly offered to preschoolers, i.e. children aged six and older. Materials and objects adequate for comparing quantities encompassed in this assessment were different sized toys, various sized bricks, graduated cylinders, graph charts, cards etc.

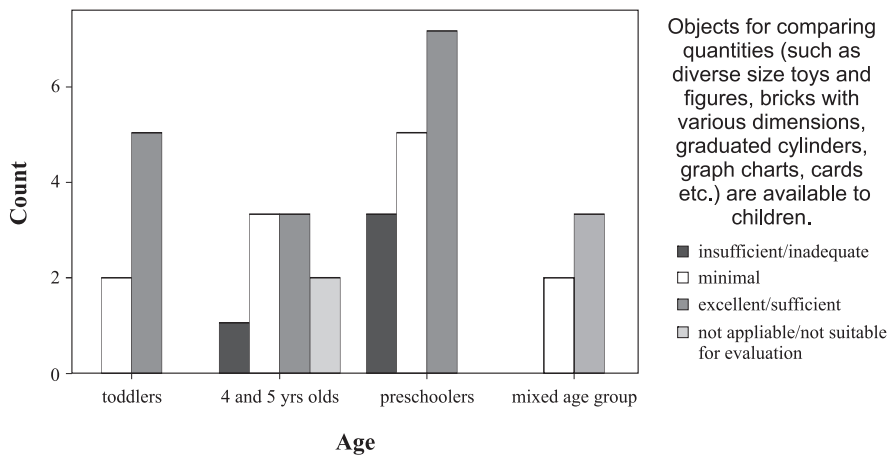

Figure 7. Crosstab for children's age/objects adequate for comparing quantities.

As expected, the objects for comparing quantities are mostly present in the classrooms for preschoolers, i.e. for children aged six and over. Surprisingly, these materials are quite often offered to toddlers, which draws two conclusions: first, preschool period is conceived to be a period of preparation for formal operations, within which comparing quantities is unavoidable. Secondly, we can conclude that the programs for toddlers are based on academic values, which could be argued as a competence approach to early learning. However, if we want to confirm these presumptions, further analysis of classrooms programs should be conducted.

#### 3.4.4. Presence of materials adequate for recognizing patterns

As it was stated in the introduction, math activities for early years encompass children's recognition of patterns, which can be offered to children quite early, even to toddlers. Recognizing patterns includes a manipulation of various objects, such as jigsaw puzzles, magnets, didactic puzzles etc. These objects could be made of different materials, and could be of different structure, which additionally facilitates the processes of classification and seriation. Since activities for recognizing patterns are present very early in child's life, we have expected them to be available to children of all chronological ages, from toddlers to preschoolers, and mixed age groups.

Objects for recognizing patterns are available to children of various age. However, they are prevailing in the classrooms for preschoolers. Interestingly, if we compare the level of excellence to other levels of availability, it is the leading category in every chronological age. This means that preschool teachers are oriented on children's cognitive processes, and give a priority to categorical thinking. High presence of objects adequate for recognizing patterns could be linked to its didactic utilization, i.e. patterns in early education are often inherent parts of games, and thus appropriate for children from an early age.

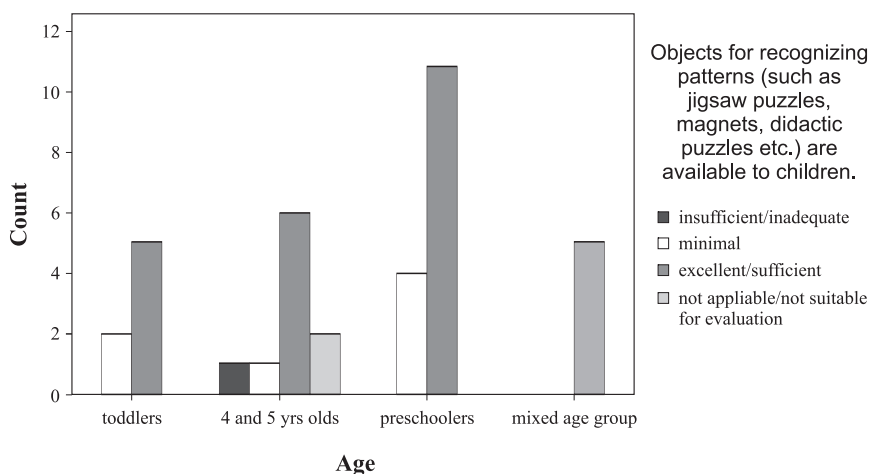

Figure 8. Crosstab for children's age/objects adequate for recognizing patterns.

### 3.4.5. Presence of materials adequate for recognizing numbers

Since numbers are symbols which represent a scientific field of mathematics, we were curious to find out something more about the presence of numbers in the classrooms. We have assessed the presence of rulers, scales, books, clocks, blocks, cards, calendars, dominos, lotto, telephone, etc. and its availability to children.

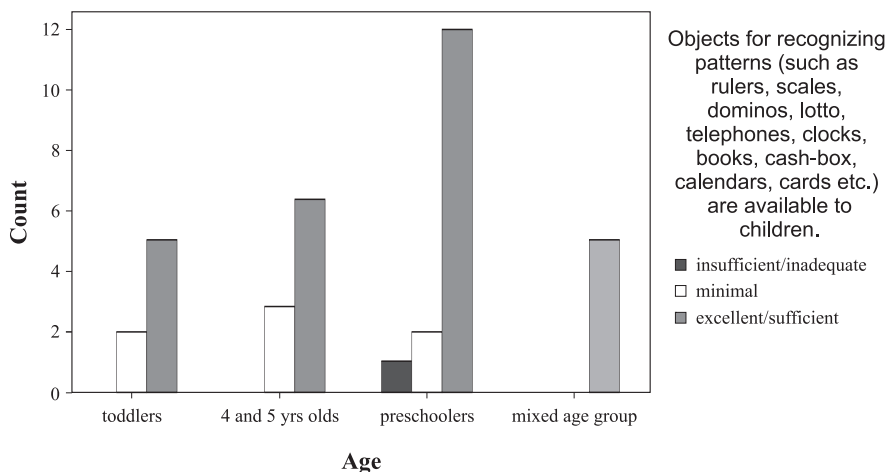

Figure 9. Crosstab for children's age/objects adequate for recognizing numbers.

As it was expected, objects adequate for recognizing numbers are mostly present in classrooms for preschoolers. If we look at the previous findings, preschool teachers design math activities according to children's age. Specifically, they offer numbers to preschoolers (six-yrs-old and older), which can be



interpreted as an academic activity suitable for the preparation for school. I.e. The social perception of school readiness encompasses the knowledge about numbers, and, thus is important to preschool teachers.

### 3.4.6. Presence of geometric bodies and shapes

We have anticipated that geometric shapes and bodies, as similar to patterns, would be present in classrooms for all chronological ages. This is due to the fact that toys, offered to children in early years, are diverse in shapes (rattles, balloons, balls, building blocks, etc.). For this purpose we have assessed the materials of which geometric bodies and shapes are made (e.g. wood, foam, plastic, cardboard etc.).

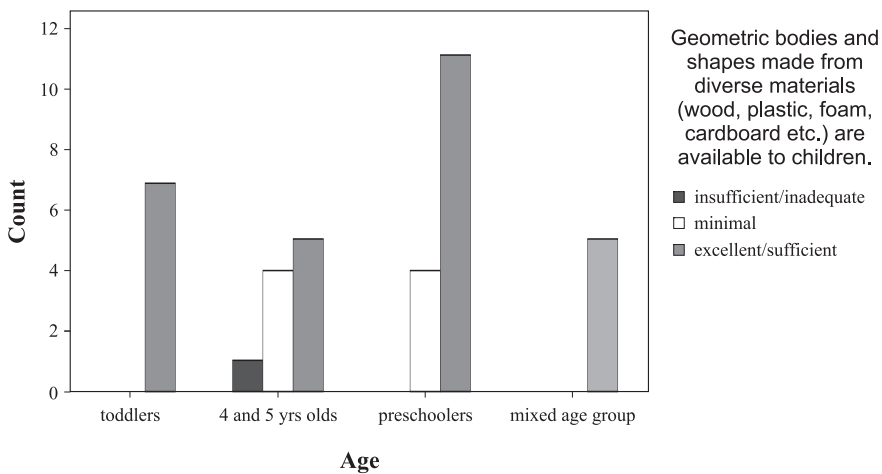

Figure 10. Crosstab for children's age/geometric bodies and shapes.

Obviously, geometric bodies and shapes made of diverse materials are mostly available to children aged six and over. This could be interpreted in two ways: one is the type of geometry offered to children. I.e. toddlers are offered jigsaw puzzles and didactic puzzles (as seen in previous findings), and preschoolers are offered "real" geometric materials such as spheres, pyramids, triangles etc. The last is very often present in working sheets for preschoolers as aspect of school readiness, and thus present in preschool classrooms. Secondly, geometry is all around us, it represents the aspect of space aesthetics and many didactic materials are based on geometry, and subsequently, present in classrooms.

## 4. Discussion

As this research has shown, current practices in preschool classrooms are various. It is almost as if we could say – as many as classrooms (or precisely, as many as teachers), as much as practice. Preschool teachers design math materials and

organize math activities in accordance with their notion of developmental abilities of children enrolled in a particular classroom. Although this research wasn't focused on preschool teachers' implicit pedagogy and their formal education, but rather on the current state of math within early education classrooms, some results highlighted the importance of preschool teachers' personal educational theories. That was visible in the arrangements of classroom environment, materials and activities offered to children. There are similar findings on the subject of the role of preschool teachers in relation to math activities in early education: (1) the level of preschool teacher's formal education is connected to quality of classrooms and math materials offered to children (Clements and Sarama, 2009), (2) preschool teachers' math-related talk is connected to the children's notion of math, i.e. math operations (Klibanoff et al., 2006), (3) preschool teachers' level of orientation on children is connected to the integration of math activities into the curriculum (Feiler, 2004), (4) preschool teachers' animosity towards math is closely connected to children's negative perception of math activities and fear of math in later school years (Adihou, 2011) etc. Therefore, preschool teachers should reconsider their role(s) in early education when it comes to math. Not just with the selection of materials and design of activities they would offer to children, but also when facing own emotions towards math.

## 5. Limitations

As the main limitation in this research we stress the time frame – the assessment was conducted on a one time basis, due to the overall numbers of classroom assessed. So, we have assessed those materials and activities which were available for observation at a particular moment. Another problem was the variety in the practice of early education in the field, i.e. preschool education in Croatia and Bosnia and Herzegovina is administered by the local government. This means that the didactic materials in classrooms varied due to finances, and not just preschool teachers' professional competence. And finally, the socioeconomic status of the children, as well as the presence of children with disabilities included in the early education classroom wasn't defined as a variable in this research, although they have an impact on the curriculum design and organization of classrooms.

## 6. Conclusion

Math in early education is characterized with a reductionist approach and is mainly applied within the concept of school readiness. Current practices of math activities in early education in Croatia and Bosnia and Herzegovina are focused on enhancing the developmental processes of classification and seriation for toddlers, and the manipulation of numbers and quantities for preschoolers. Preschool teacher's level of formal education, overall number of children enrolled in classrooms, and age of the children are proven to be significant factors for math activities in early education classrooms. Since preschool teachers in Croatia and Bosnia and Herzegovina

work in complex social and political conditions, we think that these findings could also be interpreted as preschool teachers' balance between social expectations, children's real interest in math activities and current conditions in early education. Nevertheless, math in early education is also influenced by social expectations, and until educational policy-makers design the standards and recommendations for math (and provide suitable educational conditions as well), based on scientific research, math will remain on the margins of early education.

## References

- [1] ADIHOU, A. (2011), *Enseignement-apprentissage des mathématiques et souffrance 'a l'ekole*, Les Collectifs du Cirp, **2** (1), 90–102.
- [2] BRENNEMAN, K., STEVENSON-BOYD, J., FREDE, E. C. (2009), *Math and Science in Preschool: Policies and Practice*, <http://nieer.org/resources/policybriefs/20.pdf> [Accessed 20/03/2015]
- [3] CLEMENTS, D. H., SARAMA, J. (2009), *Learning and Teaching early Math: The Learning Trajectory Approach*, New York: Routledge.
- [4] FALK-FRUHBRODT, C. (2005), *Mathematische Denkentwicklung in der frühen Kindheit – Früherkennung und Frühförderung von Rechenschwäche*, [http://www.iflw.de/ausbildungen/lerntherapie/Arbeiten/99/Abschlussarbeit\\_Schoenebaum.pdf](http://www.iflw.de/ausbildungen/lerntherapie/Arbeiten/99/Abschlussarbeit_Schoenebaum.pdf) [Accessed 18/03/2015]
- [5] FEILER, R. (2004), *Early Childhood Mathematics Instruction: Seeing the Opportunities Among the Challenges*, In Clements, D. H., Sarama, J. (Eds.), *Engaging Young Children in Mathematics: Standards for Early Childhood Mathematics Education* (pp. 393–401), New York: Lawrence Erlbaum Associates Pub.
- [6] KLIBANOFF, R. S. et al. (2006), *Preschool Children's Mathematical Knowledge: The Effect of Teacher "Math Talk"*, *Developmental Psychology*, **42** (1), 59–69.
- [7] SARAMA, J., CLEMENTS, D. H. (2009), *Early Childhood Mathematics Education Research: Learning Trajectories for Young Children*, New York: Routledge.
- [8] WITTMAN, E. CH. (2006), *Matematische Bildung*, In Fried, L., Roux, S. (Eds.), *Padagogik der frühen Kindheit* (pp. 205–211), Basel: Verlag.

Contact addresses:

Ksenija Romstein  
Faculty of Education  
Josip Juraj Strossmayer University of Osijek  
Cara Hadrijana 10, 31000 Osijek, Croatia  
e-mail: kromstein@foozos.hr, ksenijaromstein@yahoo.com

Stanislava Irović  
Faculty of Humanities and Social Sciences in Osijek  
Josip Juraj Strossmayer University of Osijek  
Lorenza Jäggera 9, 31000 Osijek, Croatia  
e-mail: sirovic@ffos.hr

Mira Vego  
Kindergarten Osijek  
Ivana Meštrovića 7, 31000 Osijek, Croatia  
e-mail: mira.vego@gmail.com

## Poučavanje matematike u ranom odgoju: postojeća praksa u odgojnim skupinama

---

---

Ksenija Romstein<sup>1</sup>, Stanislava Irović<sup>2</sup> i Mira Vego<sup>3</sup>

<sup>1</sup> Fakultet za odgojne i obrazovne znanosti, Sveučilište Josipa Jurja Strossmayera u Osijeku, Hrvatska

<sup>2</sup> Filozofski fakultet Osijek, Sveučilište Josipa Jurja Strossmayera u Osijeku, Hrvatska

<sup>3</sup> Dječji vrtić Osijek, Hrvatska

*G. R. (petogodišnji dječak) baca kamenje u vodu:*

*“Pogledaj ovaj kamen.*

*Kada upadne u vodu, onda daje svoju energiju vodi. . . ”*

*Sažetak.* Društvena percepcija poučavanja matematike u ranom odgoju često je formalizirana, tj. ona se vidi kao nebitna ili neprikladna aktivnost za djecu od tri do sedam godina. Kako bi se saznalo da li je matematika prisutna u ranom odgoju, provedeno je istraživanje u 37 dječjih vrtića na području tri županije u Republici Hrvatskoj i u jednom kantonu u Bosni i Hercegovini. U tu svrhu je konstruirana *Skala procjene okruženja i interakcije* (Cronbachova alfa .93), te je primijenjena njezina subskala *Matematika* (Cronbachova alfa .78). Rezultati pokazuju kako je učestalost organiziranja matematičkih aktivnosti povezana sa stupnjem formalnog obrazovanja odgojitelja, kronološkom strukturom odgojne skupine i ukupnim brojem djece u odgojnoj skupini. Tako, trogodišnjaci i dobnno mješovite odgojne skupine imaju manje prilike za matematičke aktivnosti, dok se šestogodišnjacima matematičke aktivnosti nude svakodnevno. Također, u odgojnim skupinama s manje od 15 djece i više od 25 djece, matematičke aktivnosti su sporadične. Što se tiče strukture materijala i vrsta aktivnosti, odgojitelji organiziraju aktivnosti koje mlađoj djeci omogućuju uspoređivanje količina i prepoznavanje oblika (na konkretnim materijalima, uglavnom kockama i umetaljkama), dok starija djeca mogu uživati u brojanju i mjerenju materijala različitih struktura te geometriji. Dobiveni rezultati ukazuju na to da odgojitelji implicitno vide matematiku kao akademsku aktivnost, te ju organiziraju u kontekstu priprema za polazak u osnovnu školu. Na pragmatičnoj razini, rezultati se mogu uporabiti kao startna pozicija za dizajniranje matematičkih aktivnosti u ranom odgoju, tj. kao argument u propitivanju postojeće pedagoške prakse poučavanja matematike i uloge odgojitelja na tom području.

*Ključne riječi:* stavovi, zaključivanje, budući učitelji, statistika, mjere centralne tendencije

# 4.

## Fostering geometric thinking

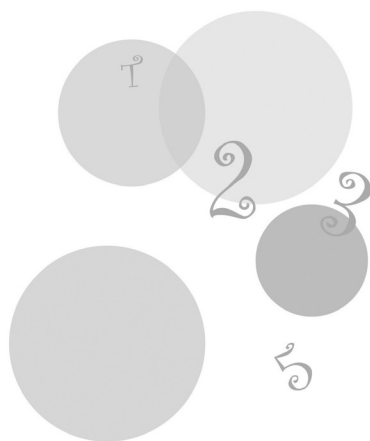



# Preservice mathematics teachers' problem solving processes when working on two nonroutine geometry problems

---

---

Doris Dumičić Danilović\* and Sanja Rukavina

Department of Mathematics, University of Rijeka, Croatia

*Abstract.* Educational researchers widely recognize the importance of the development of students' metacognitive strategies and problem solving skills in order to improve their mathematics achievement. However, the time dedicated to the study and development of preservice mathematics teachers' problem solving skills is minimal. The aim of this research is to provide the insight into the metacognitive behaviour of six preservice mathematics teachers, attending graduate teacher training courses at the Department of Mathematics of the University of Rijeka, while solving nonroutine geometry problems.

This study was designed as a multiple case study, a qualitative research method was employed. We observed some weaknesses in students' mathematical knowledge with particular focus on how they relate and transfer their conceptual and procedural knowledge to unfamiliar problem situations. Our intention was to explore problem solving process experienced by preservice teachers faced with nonroutine geometry problems, working individually within dynamic geometry environment (GeoGebra) or paper-pencil environment, and how the use of dynamic geometry software can influence on participant's decision-making, reflections and problem solving process.

*Keywords:* Problem solving process, Metacognition, Preservice mathematics teacher, Nonroutine geometry problem, Dynamic geometry environment

## Introduction

Problem solving process is a fundamental process for the mathematical development of students, recognized by experts, as it is stated in NCTM (2000), but there are still unanswered questions about it. Educational researchers widely recognize

---

\*Corresponding author.

the need to better prepare future teachers for the challenges they will face in mathematical classrooms (Brookhart and Freeman, 1992; Stuart and Thurlow, 2000), and there are many studies related to mathematical problem solving behaviour of preservice mathematics teachers (Demircioğlu, et al., 2010; Yimer and Ellerton, 2006; Wilburne, 1997). However, the time dedicated to the study and development of preservice teacher's metacognitive strategies is minimal. Furthermore, preservice teachers with poor skills in problem solving and high mathematical anxiety can become ineffective teachers, and a consequence is that they will produce new generations of pupils having unwanted attitudes (Clarke, et al., 1992).

The concept of metacognition was introduced by Flavell, as the knowledge that people have about their own cognition and the self-regulation processes (Flavell, 1976). Later, this definition was expanded to include the students' beliefs about themselves, mathematics, and about the strategies required by a given situation (De Corte, et al., 1996; Garofalo and Lester, 1985; Greeno, et al., 1996). Schoenfeld stated that metacognitive skills are essential elements that determine one's success or failure in problem solving (Schoenfeld, 1992). A person that is able to control its cognitive activity can make predictions, elaborate a plan before starting to implement it, and review, change, and abandon unproductive strategies or plans (Garofalo and Lester, 1985; Schraw and Graham, 1997). Mayer pointed out that a success is in the simultaneous coordination of three skills: domain specific knowledge, strategies on how and when to use and control knowledge, and motivation and task interest (Mayer, 1998). It has been noticed that, even if students possess the relevant mathematical knowledge, it is very difficult for them to use it in a new situation (Schoenfeld, 1985a; Santos Trigo, 1995). Irrespective of the richness of students' knowledge or skills to interpret the statement of a problem, their inefficient control mechanisms often mean that known mathematical knowledge is not accessed, and problem solving strategies are therefore not employed, which is a major obstacle during their problem solving (Carlson, 1999). Preservice teachers' lack of the problem solving skills, is a serious problem since it is important for teachers to be competent problem solvers (Battista, Wheatley, Grayson and Talsma, 1989; NCTM, 1991).

A lot of studies have been conducted to explore preservice mathematics teacher's problem solving skills in a dynamic geometry environment (Özen and Köse, 2013; Kuzle, 2011). "*Technology is essential in teaching and learning mathematics; it influences the mathematics that is taught and enhances student's learning*" (NCTM, 2000, p. 24). Dynamic geometry software (DGS) creates experimental environments in which students do their experiments easier than in a traditional paper-pencil environment, observe whether the mathematical relations change or not, verify their own hypothesis (Marrades and Gutiérrez, 2000; Straesser, 2001). The dragging and measuring tools of DGS can help students to understand the problems clearly and to explore the potential solutions of the given problem (Healy and Hoyles, 2001). However, users may tend to misuse the potential of DGSs, so that the software becomes a tool in the hands of the user, and the user relies heavily on its use to solve the problem for him or her taking away the cognition of mathematical thinking (Hoyles and Noss, 2003; Olive et al., 2010).



The purpose of this research is to provide the insight into metacognitive behaviour on a sample of six preservice teachers faced with two nonroutine geometry problems, working individually in a dynamic geometry environment or in a paper-pencil environment. It also investigated how does the use of dynamic geometry software (GeoGebra) influence participant's decision-making, reflections and problem solving process. Besides that, a comparison of the results obtained in Kuzle (2011), and the results obtained in this research for the Land Boundary Problem (Libeskind, 2008) is presented.

## Research design and methodology

The idea and design for this research is drawn from Kuzle (2011). This research was designed as a multiple case study, a qualitative research method, and it was conducted by a constructivist theoretical perspective. According to constructivism, knowledge is actively created in the minds of the learners, based on the interaction between their experiences and their ideas (Von Glasersfeld, 1982, 1984). The first aim of this research was to examine the participants' cognitive and metacognitive processes, when faced with nonroutine geometry problems (participant's reflections, decision-making, monitoring and regulating their own progress and activities, the way in which the participants consider and access the relevant mathematical content, and other problem solving strategies). The second objective of the study was to explore the effects of the use of dynamic geometry software on students' activities and achievements.

In order to analyze cognitive and metacognitive strategies that students use to solve two nonroutine geometry problems, we have used a framework relied on Schoenfeld's framework (Schoenfeld, 1985a), that was developed as a result of Schoenfeld's experimental studies conducted into four-stage problem solving Pólya's model (Pólya, 1945/1973). Problem solving process is parsed into episodes that present periods of time, during which a participant is engaged in a particular activity, such as reading, understanding, analysis, exploration, planning, implementation, verification, and transition. A transition episode is a junction between the other episodes and occurs when a solver evaluates the current problem solving situation and makes decisions about pursuing a new direction in solving the problem. Transition occurs when solvers use their metacognitive decisions (Garofalo and Lester, 1985).

The participants of the study were six preservice teachers attending graduate teacher training courses at the Department of Mathematics of the University of Rijeka, which have been chosen on a voluntary base. They have sufficient geometry content knowledge required for the research, because they attended the course "Using computers in teaching mathematics" during 2012/2013 spring semester, so they were enabled to prepare materials for learning and teaching mathematics in GeoGebra. All of the participants had the possibility to use dynamic geometry environment while solving the posed nonroutine geometry problems. We have tried to create an environment in which they felt comfortable, while interacting with the researcher. We were constantly encouraging the participants to thinking

aloud during their problem solving sessions. In order to collect the data we used different methods (descriptive and qualitative methods):

- preliminary interview
- audio taping of thinking aloud problem solving sessions,
- screen captures of the problem solving process in the GeoGebra environment,
- researcher's observations of the sessions,
- participant notes on a sheet of paper,
- clinical interview questions (*How do you get this result?, Can you explain why do you think this?, Do you have some idea? etc.*) and
- retrospective interview, that took place immediately after the problem solving (participant's views and experiences about the problem solving task)

To ensure the validity and reliability of the study, we used triangulation of sources and rich description of the participant's problem solving behaviour. In our research, the within-case data analysis was conducted, as it is described in Kuzle (2011), so the answers to the research questions were realized through the analysis of each case individually. Limitations of our study were: the representativeness of the sample of participants, the choice of the problem, the interventions (prompts) of the researcher, time limitation, and insufficient motivation of participants.

Each participant was engaged in solving one nonroutine geometry problem within two hours. They were solving the faced problem individually, having an opportunity to choose whether to work in dynamic geometry environment (GeoGebra) or paper-pencil environment, or using both of them. Two geometry problems, having multiple solution paths, chosen for our research are stated below. The Land Boundary Problem is taken from Kuzle (2011), while the Boat Position Problem we defined ourselves.

**Problem 1: The Land Boundary Problem – exploration problem**

*The boundary between two farmers' land is bent, and they would both like to straighten it out, but each wants to keep the same amount of land. Solve their problem for them. What if the common border has three segments? Justify your answers as best as you can.*

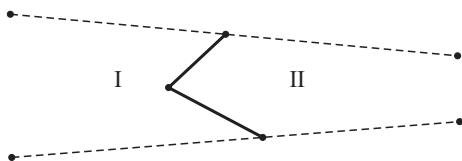

Figure 1. Land Boundary Problem: Part I.

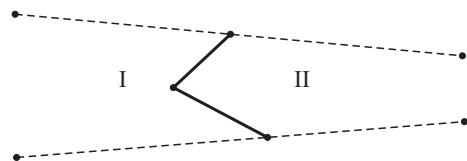

Figure 2. Land Boundary Problem: Part II.

**Problem 2: The Boat Position Problem –applied problem**

*The man sailed away from an island on his old boat, and was equipped with compass, spyglass and mobile phone (without GPS). After a while, the boat broke down, and the man informed the coast guard that he observed that the angle between the cathedral's tower and school's chimney is  $60^\circ$ . What can the coast guard conclude about his position on the sea? Formulate and prove your hypothesis.*

**Results**

The synthesis of the within-case data analysis of the participants' problem solving processes is presented below.

**Analysis of the four students who were given the Land Boundary Problem**

## Student 1

**Synthesis of the Land Boundary Problem Solving: Part I**

Solving the first part of the task was not a difficult challenge for the student. It took her approximately 25 minutes, and she successfully solved the problem in paper-pencil environment, despite the fact that she was not a very successful student during her college education, as she mentioned in the preliminary interview. She was monitoring very well the implemented procedures, throughout the problem solving process, managed the flow of her thoughts very well, and she consciously used the structural and systematic approach in the problem solving process, based on earlier experiences. Throughout each episode of problem solving process we noticed an intertwining of cognitive and metacognitive processes. That is also a consequence of the fact that the student likes to think aloud while working, as she mentioned in the preliminary interview. She does not use GeoGebra in problem solving, because of her previous negative experience in working with the technology; that is to say, the student believes she is clumsy when using any type of software, which she also mentioned in the preliminary interview, and even during her problem solving. This is a case where we would point out that the metacognitive processes (multiple reading of the problem statements aloud and in silence in order to fully understand the problem before attempting a solution, active monitoring and regulating of her own progress and implemented procedures, connecting new information to her former knowledge, planning and evaluating her thinking processes, engagement in internal dialog or self-questioning, verification of the reasonableness of the result), as well as the consideration and access to knowledge of the relevant mathematical concepts, were the key for a successful problem resolution. Selection and use of her problem solving strategy was based on thinking about her previous problem solving strategies, which is a metacognitive behaviour.

### Problem Solving Cycle (Figure 3)

After having read the problem statement for a few minutes in silence, in order to get a better understanding of the problem, the student clarified the conditions and aims of the problem aloud. She sketched the farmer's lands on a sheet of paper, which is a cognitive problem solving strategy, however use of that strategy was based on thinking about her previous problem solving strategies, which is a metacognitive behaviour. Because there were no given values in the task, which is the opposite to what she was used to, in order to get a better understanding of the problem, she raised a question: "Do I need to calculate something or just to explain the problem solving procedure?"

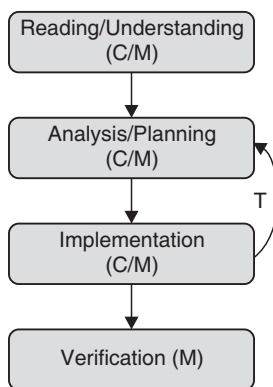

Figure 3. Student 1 – Problem Solving Cycle, Part I.

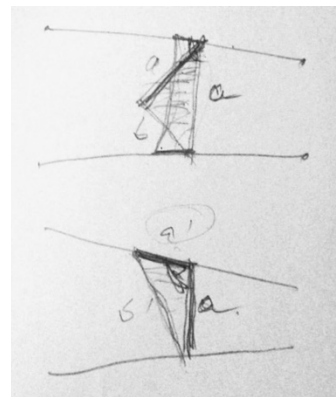

Figure 4. Student 1 – Part I: sketch of triangles.

Afterwards, she engaged into the analysis of the problem and the construction of a plan, which she explicitly carried out. She tried to focus her knowledge and thinking towards what could be done in this context, and she thought about the previous content-specific knowledge and experiences that might be helpful. In order to keep the area of the land the same and to determine the boundary between the farmers' lands as a straight line, she wanted to rearrange the two lands by outlining a new triangle with the same area as the first one on Figure 4. By interpreting the aim of the problem in mathematical terms, she immediately chose the perspective of calculating the area of the new triangle sketched on the paper, by using Heron's formula. She failed to reflect on the effectiveness of her plan, and continued with its implementation on a sheet of paper. However, as she implemented her plan, she reflected on the undertaken activity realizing this approach would not work (due to too many unknown side lengths of the triangle, which are denoted by  $a'$  and  $b'$  on Figure 4), so she considered the relevant mathematical knowledge she disposed of, and what should and could be done. Based on the previous problem solving experience, she abandoned the complex problem solving method (using Heron's formula), thinking that there must be an easier way (transition occurred). This episode highlights the importance of monitoring the progress of planned actions. She decided to take a step back, to change the perspective and to think which mathematical concept she could consider and relate to the posed problem. She

noticed that she could label the triangle's interior angle with  $\gamma$  (Figure 4), and use the following formula for the triangle area (according to the labels on Figure 4):

$$P = \frac{1}{2}a'c \sin \gamma \quad (1)$$

Later, during the interview, she explained the way she remembered that: “*Usually, in similar triangle area problems, an interior angle of a triangle appears, and recently I have used right triangle trigonometry to solve a triangle*”, so the formula was at hand. The student managed to successfully relate the required mathematical concepts and statements with the posed problem. The solution plan was clear and reflected the choice of perspective – find the side length  $a'$  of the triangle having the same area as the previous one (Figure 4). In planning and implementation episode, the cognitive and metacognitive processes were interweaving. Applying the formula (1), she expressed the side length  $a'$  of the triangle, which was sufficient to solve the triangle, i.e. determine the solution of the problem. The student checked the accuracy of the performed procedures from the implementation episode, by repeating the problem solving process aloud. She did that as she was aware of her rashness, as she stated in the retrospective interview.

### Analysis summary: Part II (Figure 5)

After having briefly read the problem, the student immediately moved into the plan construction. Based on the positive experience from the previous problem, she decided to use the same solving strategy. She clearly stated a plan that the two triangles would be transformed into one triangle, whose area is equal to the sum of the areas of the previous two, as it is shown in Figure 6.

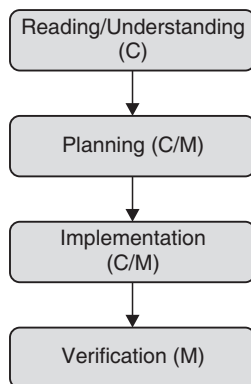

Figure 5. Student 1 – Problem Solving Cycle, Part II.

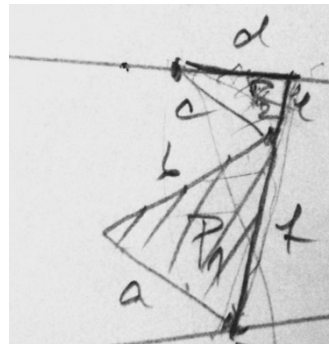

Figure 6. Student 1 – Part II: sketch of triangles.

She did not evaluate the efficiency of the plan, but promptly jumped into its implementation, by sketching the triangles on a new sheet of paper. After having solved the problem successfully, she checked the validity of the performed procedures, by repeating the whole problem solving process aloud. She was confident

she got the problem correct, relying on her proper mathematical reasoning. The key for her successful resolution was the continuous monitoring of the flow of thoughts and the presence of metacognitive processes.

## Student 2

### Synthesis of the Land Boundary Problem Solving: Part I

The student was not successful, after having worked on the problem for 102 minutes. She rashly approached the understanding of the posed problem. She consciously used the problem solving strategy, based on the trial and error method. She chose the perspective: “*Let’s see if I can solve it this way, and I’ll think about it when I get something new.*” Bad sketches led her to wrong reflections and conclusions. Metacognitive processes were barely visible. This is an example in which the use of GeoGebra does not encourage the student to a comprehension and mathematical thinking, and it takes away the cognition of mathematical thinking, as it was established in (Hoyles and Noss, 2003; Olive et al., 2010). The software did not become an instrument for finding a successful strategy in the problem solving process during two hours of work. The student reached for the software to test the conjectures, and besides that, to implement the strategy of the problem solving backwards, i.e. first she used the Move and Area Measurement Tool to get an approximate problem solution, and afterwards to find a mathematical explanation for the solution. The use of these tools is cognitive behaviour, but transforming the tool to a meaningful instrument allowing her to test and revise her conjectures is a metacognitive decision. With the help of GeoGebra, she came up with the solution, but not with the understanding.

### Problem Solving Cycle (Figure 7)

The student read the problem silently, and later emphasized the key words “*straight boundary*”. She did not emphasize that the farmers’ lands should keep the same areas, and also she did not evaluate whether she understands the goal and the terms of the problem correctly, but carried on with the plan construction. The perspective she chose is “*guessing that straight boundary between the lands*”, i.e. the approximation of the straight boundary’s position, by measuring the area of the constructed polygons (farmers’ lands) with GeoGebra tools. At this point,

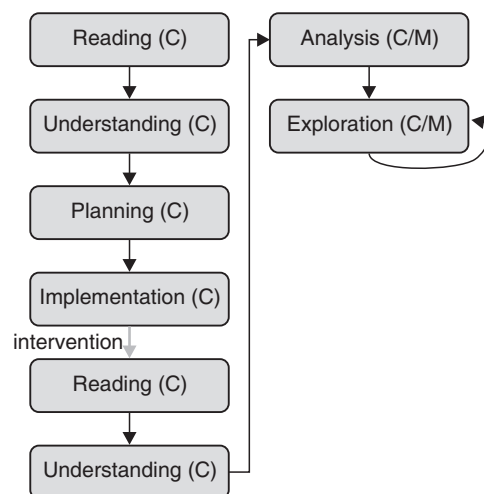

Figure 7. Student 2 – Problem Solving Cycle, Part I.

she demonstrated a lack of understanding, as she misunderstood the problem, i.e. she was certain that the total area of the farmers' land should be split into two parts with the same area, by the straight boundary. She was more focused on the task solution and jumped on the implementation of the plan in GeoGebra. She used GeoGebra tools for the construction of segment, polygon and for area measurement. At one time, we intervened and told her to reread the problem statement again, in order to review the terms of the problem, because we estimated that she would waste too much time working with the wrong comprehension of the task. After rereading the problem, the student emphasized: "No, they do not want to have the same amount of land, they want to retain the same area they had before, while the border between their lands is a straight line!" The key words she highlighted were "retain the same area". Encouraged to think in a different way, she decided to start over, and sketched the lands on a new sheet of paper, which is a metacognitive behaviour induced by our intervention. Afterwards, she started with the problem analysis based on previous experiences, and she was trying to relate the considered mathematical concepts (triangle, trapezium, parallel lines, and parallelogram) with the posed problem. She moved onwards in her research (exploration episode) using the trial and error method, in order to determine how to split the trapezoid in a way that the area which belongs to each of the farmers could remain preserved. The first perspective in her problem solving process was to split the problem on smaller parts, i.e. to make a simplification (Figure 8: the perspective of considering parallelogram inside the trapezoid, and Figure 9: the perspective of considering midline of trapezoid).

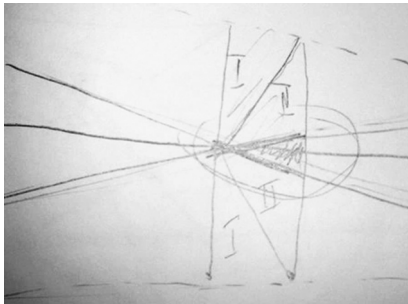

Figure 8. Trapezoid split into parallelogram and triangles

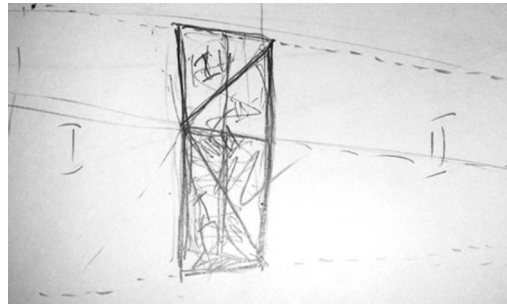

Figure 9. Midline of trapezoid.

The mentioned perspectives brought her to a situation where she was no longer in a condition to make some conclusions about the possible problem solution. The insufficient monitoring of the progress of her planned actions brought her to a failure. Besides that, she was too confident in her sketching, did not reflect on what is the problem's goal, she did not manage to access relevant mathematical concept, and her actions did not seem focused while she was promptly jumping into various attempts to solve the problem. One of the attempts was successful, after deciding to re-sketch the land on a new piece of paper. She wondered: "I have

to make a boundary segment within that trapezoid, so that the areas of farmers' lands remain the same! How will I do that?" She then added: "It can be placed as a trapezoid's diagonal or from some point on the trapezoid's leg". After she failed to prove the conjecture of the equality of the areas of the two triangles obtained by splitting the trapezoid by its diagonal, on a sheet of paper (Figure 10), she decided to check it by using GeoGebra tools (construction of triangles and measurement of their areas). Her conjecture proved to be true. For a further understanding and problem solving there was no more time.

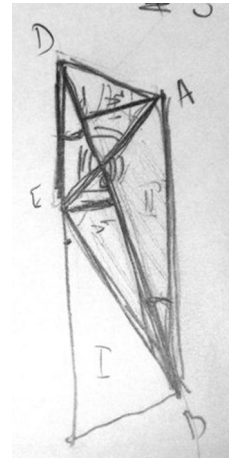

Figure 10. Trapezoid divided by its diagonal

### Student 3

#### Synthesis of the Land Boundary Problem Solving: Part I

After working for 60 minutes, the student gave up. Without the use of GeoGebra, the task would have been solved wrongly, due to an insufficient knowledge of the relevant mathematical concept approached. This is an example in which the lack of metacognitive behaviour, in particular, the weak linkage between the mathematical concepts and the problem context, as well as a personal negative attitude towards mathematical word problems (she thinks they are difficult), were the main reason for her failure. In the preliminary interview, the student mentioned: "I was not so successful and ambitious through my college education. I do not like to think aloud while solving a mathematical problem. I frequently seek help in problem solving, and I am not persistent." Also, in this case, she was insufficiently motivated for the problem solving, which is among the other factors, one of the reasons she gave up. During the problem solving, she relied on the trial and error method, with monitoring insufficiently her activities. This is an example where the student used GeoGebra, which she handles quite well, because she did not know how to solve the problem in a paper-pencil environment. During the exploration episode, the student used the dynamic nature of the software in order to find relevant information that could potentially be useful in the planning episode, and also to examine the accuracy of the assumptions on the potential problem solution. She relied on the precise constructions and dynamics of GeoGebra, to enable herself to get new insights, based on the previous positive experience while she was working in GeoGebra environment. Her problem solving strategies were mostly cognitive activities, and we were not completely sure what would be the approach for her future actions. The proof of her incorrect way of thinking on the possible problem solution was obtained by using the Construction and Area Measuring Tool.



### Problem Solving Cycle (Figure 11)

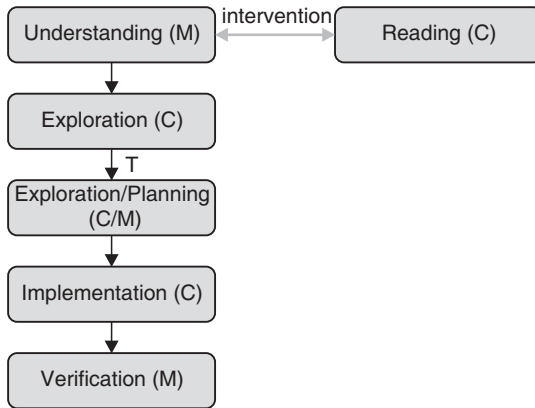

Figure 11. Student 3 – Problem Solving Cycle, Part I

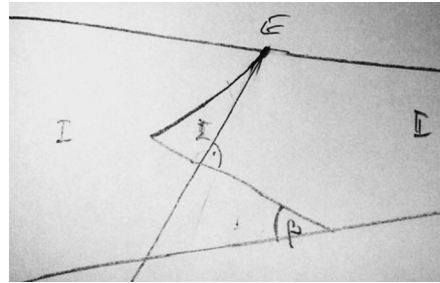

Figure 12. Straight boundary line through point E.

The student started her problem solving process by reading the problem statements silently, and after our question whether she understood the problem she explained aloud: “Ok, I have to divide the whole land into two equal parts so that each farmer gets a piece of land of the same area”, so we intervened to read the text again, but this time more carefully. After having misunderstood the problem and reread the text, the student clarified aloud the actual aim of the problem. She sat in silence for a few minutes, having no idea on how to deal with the problem and said that she had never seen a problem similar to this one. The exploration episode started, as she began using GeoGebra to make some constructions. She used the trial and error method in order to search for a solution plan. She was not successful, because she did not monitor sufficiently her progress, and did not use previous problem solving experience, as she should. She decided to change the perspective, as she was aware that the prior way of thinking was too abstract, and commenced a new exploration and planning episode in a paper-pencil environment (transition). Considering the possible straight border’s positions (solutions of the problem), after a few minutes of silence, she stated: “Congruent triangles have the same areas, and somehow I could transform the triangle  $\triangle EGF$  (Figure 13) into a new one, preserving the farmers’ land areas;’ She explicitly carried out the plan that the line through the point E in Figure 12, should split the land in order to make the corresponding triangles congruent. “I could construct the straight boundary line, by using GeoGebra tools, such that the two obtained triangles (Figure 13) match in all angles, which means the triangles are congruent, and that would be a solution of the problem!” The evaluation of the plan was not made. The implementation of the plan was conducted in GeoGebra, as it is shown in Figure 13. The inaccuracy of her solution plan was proved by using Construction and Area Measurement Tool. After a failure, she gave up.

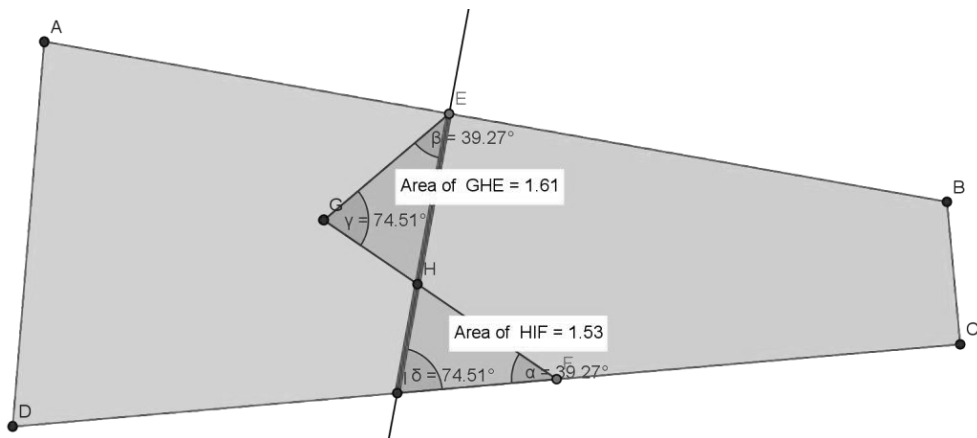

Figure 13. Student's construction of the straight boundary line in GeoGebra.

#### Student 4

#### Synthesis of the Land Boundary Problem Solving: Part I

Within the first 40 minutes of work, the student had a fair amount of the problem statement understanding. She exclusively used the trial and error method, working in GeoGebra environment, as well as an unstructured approach, without building a solution plan. She is very superficial and switches from one to another episode, without monitoring her activities and accessing relevant mathematical knowledge. In the preliminary interview, she stated: *"I do something, and then I see if it is good or not, rather than previously planning the problem solving!"* In her approach to problem solving, she also admitted being persistent and not giving up, as it was the case in this situation. Most of the time she worked in the GeoGebra environment, but after 73 minutes of work she had no success. The main reason was a lack of metacognitive behaviour and a superficial understanding of the problem statement. She used GeoGebra for the exploration and verification of various ideas. The software's dynamics lead her to a solution, but not to the understanding of it, within the given time. The use of GeoGebra's dragging and measuring tool is a cognitive behaviour, but her choice of using these tools as a strategy to help her formulate a conjecture or plan, and assess her ideas, shows the evidence of her metacognitive engagement.

#### Problem Solving Cycle (Figure 14)

She read the problem silently many times and afterwards aloud, in order to get a better understanding. Due to her superficiality, she had some problems understanding the task. She speculated where the straight boundary could be positioned, by visualizing it in her mind, and then sketched it on a sheet of paper. She used the trial and error method to establish the possible position of the boundary, which she

implemented through various construction efforts, and by testing her ideas in the GeoGebra environment. She was not mentally engaged while monitoring and focusing her activities, and after 40 minutes of work, she still did not understand the problem. Hence, the researcher intervened and directed her to read the text again. Having understood the problem, she started with new exploration episode in GeoGebra, and made the effort to access a relevant mathematical concept that could have helped her. After some unsuccessful explorations using the software, she reread the problem once more (transition), and sketched the farmers' lands on a new sheet of paper, in order to determine the problem's requirements, which represents a metacognitive behaviour. She returned to the previous parallel line perspective, which determined three triangles denoted by  $P_1$ ,  $P_2$  and  $P_3$  (Figure 15), for which holds that  $P_1 + P_2 = P_3$ , thus she stated the next plan: "I must determine the parallel line such that the above equality for triangle areas holds!" Since she did not know how to implement the solution plan by using a paper-pencil environment, she decided to use the dynamics of GeoGebra by moving the boundary line, in order to come up with a solution, in which she succeeded (Figure 16). Unfortunately, the time limit set for the problem solving, did not allow her to further understand the obtained solution.

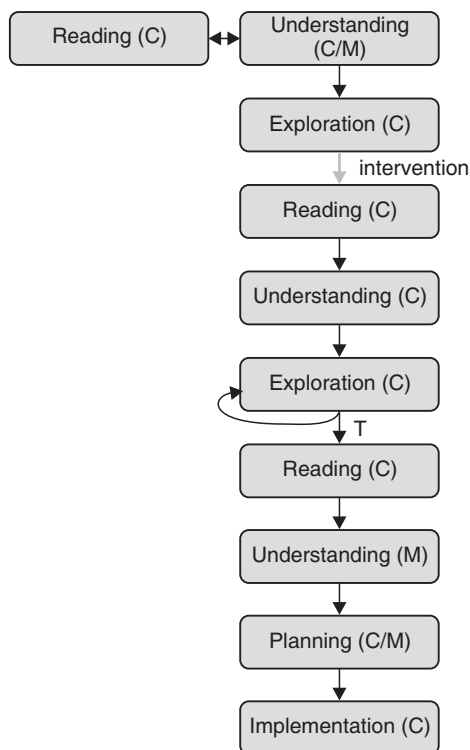

Figure 14. Student 4 – Problem Solving Cycle, Part I.

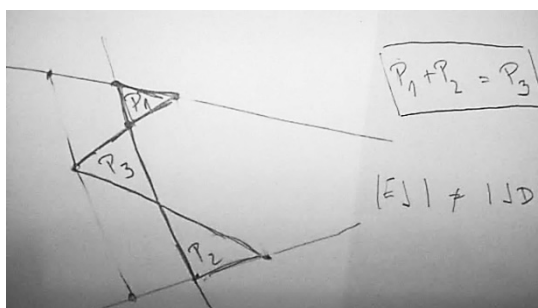

Figure 15. Student's sketch.

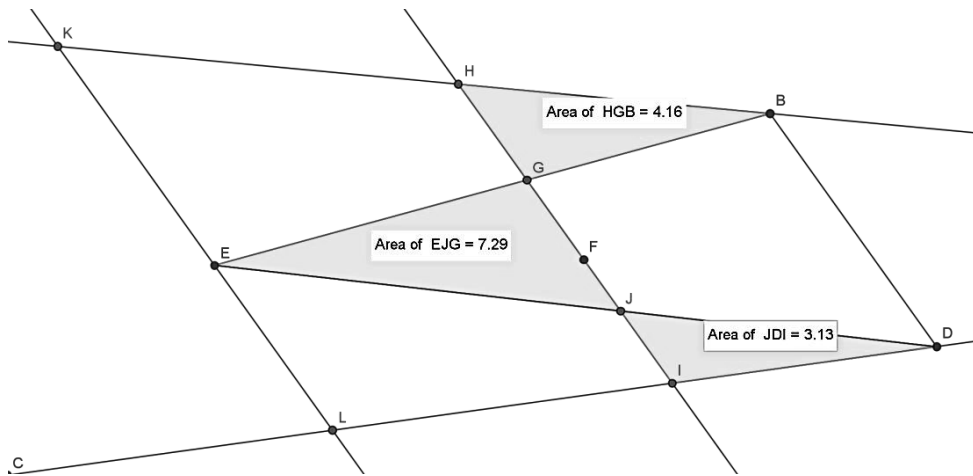

Figure 16. Guessing a solution.

## Synthesis of the Boat Position Problem Solving

### Student 5

The student managed to solve the problem with the help of GeoGebra after 38 minutes, but did not understand how to solve it on a paper-pencil environment. Metacognitive behaviour may be seen through student's decision about pursuing a new problem solving direction, consideration of relevant mathematical knowledge that can be applied in this context, directing her thinking as to what could be done. She used a cognitive problem solving strategy, interpreting the problem in mathematical terms, however selection and use of that problem solving strategy was based on thinking about previous problem solving strategies, which is a metacognitive behaviour. GeoGebra served as a tool for plan implementation, but moved away the cognitive processes from the mathematical thinking. We are dealing with a very good student who likes geometrical tasks, but not problem tasks, which she mentioned in the preliminary interview. She believes that it is very important to use a technology in teaching and learning mathematics. "When I have a geometric problem, I first try to resolve it myself, but I like to use the assistance of GeoGebra by checking something if I do not know how to solve or construct on a sheet of paper", which was the case here. She used GeoGebra to make a representation of the problem allowing her to visualize the problem and develop an understanding of it, which was a metacognitive behaviour.

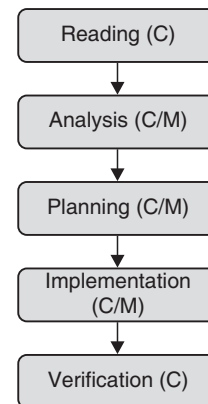

Figure 17. Student 5 – Problem Solving Cycle

### Problem Solving Cycle (Figure 17)

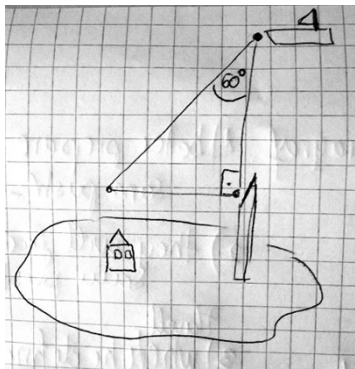

Figure 18. Student's sketch

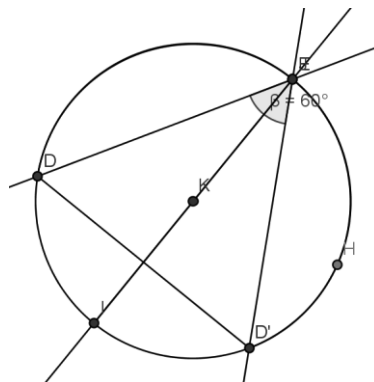

Figure 19. Student's construction in GeoGebra.

The student started her problem solving process by reading the problem statements silently. It was not clear whether the problem is understood or not. The student is not prone to thinking aloud, so some of the episodes could not be noticed. As soon as she began to talk, she moved onto the problem analysis. Based on the previous experiences in solving similar problems (she encountered a similar problem on a mathematical competition), she sketched a right triangle on a sheet of paper and explained that it was a particular solution for the boat position on the sea, as she stated: *“In this case, it is very simple to solve the triangle, by using the trigonometry of right triangles. But this does not have to be the only solution.”* (Figure 18). She examined the relationship between the conditions and goal of the problem, and tried to direct her thinking as to what could be done and to access the relevant mathematical concepts. She explained that the simplest solution for the boat position could be the vertex of the right triangle or of the equilateral triangle, but she was aware that it might not be so. By watching the sketch and by visualizing, she came to the conclusion that there could be multiple positions. Based on the previous experiences in problem solving, she came to a conclusion: *“Maybe the position of the boat is located on a certain circle.”* She was successfully engaged in the relevant mathematical concepts and their linkage to the posed problem, thus she explicitly carried out her plan: *“The boat could be located on the arc of a circle, and it is the application of the Inscribed Angles Conjecture, which states that in a circle, two inscribed angles with the same intercepted arc are congruent.”* The implementation of the plan was conducted by GeoGebra, i.e. by the application of the Construction and Angle Measurement Tool. She verified her conjecture in GeoGebra environment, by constructing and moving a point that represented the boat (Figure 19), and the accuracy of the solution was confirmed by her verbalizing the conducted procedures, mathematical claims and facts she used. She did not consider whether there were other solutions. She failed to understand how she could construct that circle in a paper-pencil environment. *“I don't know how to do it”*, she said and moved away from the task, although she already mentioned

everything she needed to reach this cognition. The reason for it may lay in time limitation, or insufficient motivation for further problem solving, after the problem is solved in GeoGebra environment. She believes that GeoGebra was very helpful in her problem solving.

### Student 6

#### Synthesis of the Boat Position Problem Solving

The student solved the problem successfully after 45 minutes, with a problem in understanding and recalling the necessary mathematical knowledge. She had a very good monitoring of her progress in the problem solving process. GeoGebra becomes an instrument, manages the flow of her thoughts, and encourages metacognitive behaviour. She used GeoGebra to make a representation of the problem allowing her to visualize the problem, to develop an understanding of it, to test and revise her conjectures, to evaluate her thinking processes, correct them and direct her thinking processes towards achieving her current goals, which was a metacognitive behaviour. In the preliminary interview, she mentioned: *“I have difficulties in remembering the mathematical knowledge I have not used for a while! I like solving geometrical problems, in which I am able to visualize the problem statement. In most cases, the feedback that the software provides, was helpful for consideration and approach to relevant mathematical concept, and was successful for taking faster and more elegant approach in problem solving.”*

#### Problem Solving Cycle (Figure 20)

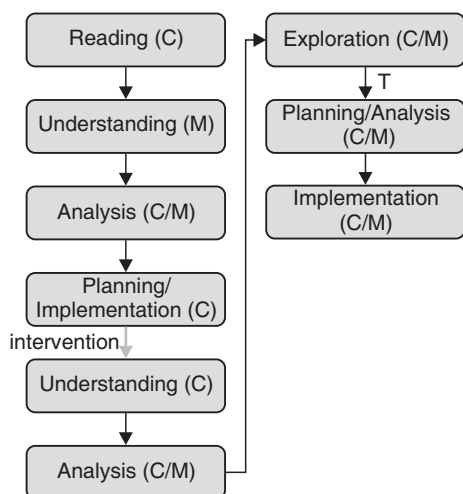

Figure 20. Student 6 – Problem Solving Cycle.

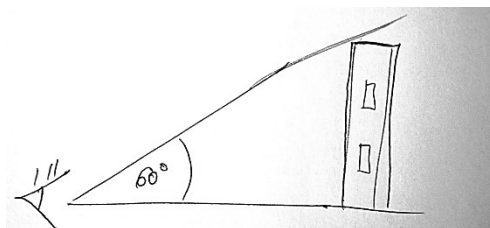

Figure 21. Student's sketch.

The student started her work reading the problem statement aloud. In order to get a better understanding, she sketched and interpreted the problem in mathematical terms (Figure 21). As she mentioned in the retrospective interview, the reason why she interpreted the problem in a different way is because she recently encountered a similar problem where it was stated that the mentioned angle is determined according to the man's visual angle. The researcher explained to her what the actual terms of the problem are. The understanding episode was conducted by visualizing the problem conditions, and by sketching the triangle on a sheet of paper. She continued with the analysis, explaining what are the problem conditions and goal, what has been done and what is to be done, which represent metacognitive behaviour. The researcher asked a question: "*Is the boat going to be exactly on one position?*", and she immediately started with the exploration episode in GeoGebra environment, using the software's dynamic nature, and its Construction and Angle Measurement Tool (Figure 22). The feedback information that was given to her, by use of the software, initiated cognitive processes and encouraged metacognitive behaviour (transition). GeoGebra enabled her to remember the relevant mathematical assertion (Inscribed Angle Conjecture). Finally, she successfully explained how to obtain the same solution without the application of the software, in a paper-pencil environment. The comment after problem solving was: "*The problem would be easier to resolve earlier, at the time I have been learning about the inscribed angle. Now, it is much harder to recall that. So, if the inscribed angle came to my mind, most likely I would not have used GeoGebra, but solved it on a sheet of paper. In this case, GeoGebra helped me a lot and affected my thinking and recalling of necessary mathematical concepts.*"

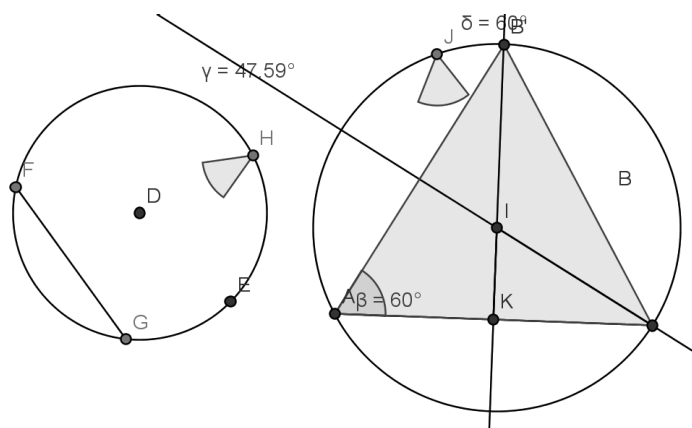

Figure 22. Student's construction in GeoGebra.

## Discussion and conclusions

Comparison of our findings for the Land Boundary Problem with those presented in Kuzle (2011) is present in the following table.

*Table 1.* Comparison of our findings for the Land Boundary Problem with those presented in Kuzle (2011).

Episode	Similarity	Difference
Reading	<ul style="list-style-type: none"> <li>– during the problem solving process, all of the examinees often reread the problem statements, in order to review the problem conditions or to check if they missed any information</li> <li>– although it is characterized as cognitive episode, in most of the examinees the metacognitive processes, such as reading the whole text aloud or highlighting the key words, were recorded</li> </ul>	
Understanding	<ul style="list-style-type: none"> <li>– raising questions, self-reflection,</li> <li>– restating and making sense of the problem information,</li> <li>– interpreting the problem in mathematical terms,</li> <li>– pausing to make sense of the problem</li> </ul>	<ul style="list-style-type: none"> <li>– superficiality and misunderstanding of the problem was often recorded in our examinees</li> </ul>
Analysis	<ul style="list-style-type: none"> <li>– decomposition of the problem into its basic elements,</li> <li>– examination the relationships between the given information,</li> <li>– search for the relevant mathematical knowledge that can be used, and analysis what needs and might be done,</li> <li>– considering content specific knowledge and strategies relevant to the problem,</li> </ul>	<ul style="list-style-type: none"> <li>– examinees in Kuzle's study were much more engaged in monitoring behaviour,</li> <li>– in some of ours examinees this episode has not even been recorded</li> </ul>
Exploration	<ul style="list-style-type: none"> <li>– mainly characterized as a cognitive episode,</li> <li>– research was carried out with the software's help, which allowed the bottom-up strategy where the participants took the problem as solved, and then tried to work backwards to obtain a solution</li> </ul>	<ul style="list-style-type: none"> <li>– often occurrence of this episode,</li> <li>– participants were mainly engaged in the trial and error strategies,</li> <li>– structure with a lack of metacognitive behaviour, with the focus set more on the solution rather than on solving process,</li> <li>– in some cases, the software did not become an instrument for finding a successful strategy in the problem solving process</li> </ul>
Planning/ Implementation	<ul style="list-style-type: none"> <li>– software was used for implementation or plan abandonment, except in one of our examinees,</li> <li>– examinees did not always evaluate a choice of perspective with respect to the effectiveness of their problem solving strategy or thinking</li> </ul>	<ul style="list-style-type: none"> <li>– our examinees had completely different perspective in the problem solving, and we have recorded their less metacognitive activities,</li> <li>– in most cases, our examinees did not reflect on the effectiveness of a plan</li> </ul>



Verification	<ul style="list-style-type: none"> <li>– evaluation of the conducted steps,</li> <li>– review and testing of the reasonability of a possible solution,</li> <li>– often use of GeoGebra tools for the measurement and construction in order to conduct the verification of conjectures and the reasonability of a possible solution</li> </ul>	<ul style="list-style-type: none"> <li>– relatively rare occurrence of this episode,</li> <li>– our examinees did not reflect upon the solution by evaluating a different approach in problem solving</li> </ul>
Transition	<ul style="list-style-type: none"> <li>– reflection on the current stage in problem solving is often the result of the feedback provided by using the software,</li> <li>– recorded a metacognitive behaviour: “<i>taking a step back</i>”, which redirected participant’s activities towards a new problem solving strategy</li> </ul>	

We need to highlight that two participants, selected for Kuzle’s research, were determined that would be ideal; not only they had been used to working in a dynamic geometry software, but worked well individually, were reflective thinkers who articulate their thinking well, and also had relevant mathematical background.

We have established that all of the participants passed through similar recursive phases as reading, understanding, analysis, exploration, planning, implementation, conjecture, validate, and justification in their problem solving process. In almost all cases, the participants used GeoGebra during the problem solving process. Like in the similar studies (Christou et. al., 2004; Laborde, 2000; Özen and Köse, 2013), it has also been noticed that a dynamic technology environment allows the participants to find the result more easily if they have no idea how to solve a problem in a paper-pencil environment, and are unable to successfully relate their knowledge to an unfamiliar problem solving context. On the other hand, the results of the study also indicated that problem solving in a dynamic technology environment does not necessarily allow focus on metacognitive processes (Hoyles and Noss, 2003; Olive et al., 2010). Also, we have found that there is no pattern in metacognitive behaviour with respect to academic achievement and type of problem, as it is pointed out in Demircioğlu, et al. (2010). Besides that, the affective behaviour influenced the success in problem solving, as it is was established in Kuzle (2013). Metacognitive behaviours, such as monitoring the plan implementation, seemed to be crucial and their absence was recorded in most of our examinees, and are similar to the behaviours defined in Schoenfeld (1981, 1985a). Cognitive actions, without the presence of an appropriate metacognitive action and controls over making decisions, lead to unproductive efforts, as it is pointed out in Kuzle (2011). The redirection and reorganization of thoughts towards a productive direction happened when the metacognitive activities lead the thinking process. The majority of participants had inadequate problem solving skills and lack of metacognitive activities. They possessed the knowledge about the required mathematics content and procedures, but it was difficult for them to use it during problem solving. Hence, we can conclude that more attention should be paid to the development of metacognitive skills in preservice teachers.

## References

- [1] BATTISTA, M. T., WHEATLEY, G. H., GRAYSON, H., & TALSMA, G. (1989), *Spatial visualization, formal reasoning, and geometric problem-solving strategies of preservice elementary teachers*, Focus on Learning Problems in Mathematics, 11 (4), 17–30.
- [2] BROOKHART, S. & FREEMAN, D. (1992), *Characteristics of entering teacher candidates*, Review of Educational Research, 62, 37–60.
- [3] CARLSON, M. P. (1999), *The mathematical behavior of six successful mathematics graduate students: Influences leading to mathematical success*, Educational Studies in mathematics, 40, 237–258.
- [4] CHRISTOU, C., MOUSOULIDES, N., PITTALIS, M., & PITTA-PANTAZI, D. (2004), *Proofs through Exploration in dynamic geometry environments*, International Journal of Science and Mathematics Education (2004) 2: 339–352.
- [5] CLARKE, D., SULLIVAN, P., AND SPANDEL, U. (1992), *Student Response Characteristics to Open-ended Tasks in Mathematical and Other Academic Contexts*, in B. Southwell, B. Perry and K. Owens (Eds.), Proceedings of the Fifteenth Annual Conference of the Mathematics Education Research Group of Australasia, Mathematics Education Research Group of Australasia, Richmond, New South Wales, 209–221.
- [6] DE CORTE, E., GREER, B., & VERSCHAFFEL, L. (1996), *Mathematics teaching and learning*, In D. C. Berliner & R. C. Calfee (Eds.), Handbook of educational psychology (pp. 491–549), New York, NY, Macmillan.
- [7] DEMIRCIOĞLU, H., ARGÜN, Z., BULUT, S. (2010), *A case study: assessment of preservice secondary mathematics teachers' metacognitive behaviour in the problem-solving process*, ZDM Mathematics Education 42, 493–502.
- [8] FLAVELL, J. H. (1976), *Metacognitive aspects of problem solving*, In L. B. Resnick (Ed.), The nature of intelligence (pp. 231–235), Hillsdale, NJ, Lawrence Erlbaum Associates.
- [9] GAROFALO, J., & LESTER, F. K. (1985), *Metacognition, cognitive monitoring, and mathematical performance*, Journal for Research in Mathematics Education, 16 (3), 163–176.
- [10] GREENO, J. G., COLLINS, A. M., & RESNICK, L. B. (1996), *Cognition and learning*, In D. Berliner and R. Calfee (Eds.), Handbook of Educational Psychology (pp. 15–41), New York, MacMillan.
- [11] HEALY, L. & HOYLES, C. (2001), *Software tools for geometrical problem solving: Potentials and pitfalls*, International Journal of Computers for Mathematical Learning, 6, pp. 235–256.
- [12] HOYLES, C. AND NOSS, R. (2003), *What can digital technologies take from and bring to research in mathematics education?*, In A. J. Bishop, et al. (Eds.), Second International Handbook of Mathematics Education. Dordrecht: Kluwer Academic Publishers.
- [13] KUZLE, A. (2011), *Preservice Teachers' Patters of Metacognitive Behavior During Mathematics Problem Solving in a Dynamic Geometry Environment*, Doctoral Dissertation. University of Georgia–Athens, GA.

- [14] KUZLE, A. (2013), *The interrelations of the cognitive, and metacognitive factors with the affective factors during problem solving*, In M. Pavleković, Z. Kolar-Begović and R. Kolar-Šuper (Eds.), *Mathematics Teaching for the Future* (str. 250–260), Osijek: Faculty of Teacher Education.
- [15] LABORDE, C. (2000), *Dynamical geometry environments as a source of rich learning contexts for the complex activity of proving*, *Educational Studies in Mathematics*, Vol. 44/1–2, Kluwer Academic Publisher.
- [16] LIBESKIND, S. (2008), *Euclidean and transformational geometry: A deductive inquiry*, Sudbury, MA: Jones & Bartlett.
- [17] MARRADES, R., & GUTIÉRREZ, A. (2000), *Proofs produced by secondary school students learning geometry in a dynamic computer environment*, *Educational Studies in Mathematics*, 44, pp. 87–125.
- [18] MAYER, R. E. (1998), *Cognitive, metacognitive, and motivational aspects of problem solving*, *Instructional Science*, 26 (1–2), 49–63.
- [19] National Council of Teachers of Mathematics (1991), *Professional standards for teaching mathematics*, Reston, VA: Author.
- [20] National Council of Teachers of Mathematics (2000), *Principles and standards for school mathematics*, Reston, VA: Author.
- [21] OLIVE, J., & MAKAR, K., (WITH HOYOS, V., KOR, L. K., KOSHELEVA, O., & STRÄSSER R.) (2010), *Mathematical knowledge and practices resulting from access to digital technologies*, In C. Hoyles & J.-B. Lagrange (Eds.), *Mathematics education and technology – Rethinking the terrain, The 17th ICMI Study* (pp. 133–177), New York: Springer.
- [22] ÖZEN, D. & KÖSE, N. Y. (2013), *Investigating pre-service mathematics teachers' geometric problem solving process in dynamic geometry environment*, *Turkish Online Journal of Qualitative Inquiry*, 4 (3), 61–74.
- [23] PÓLYA, G. (1973), *How to solve it: A new aspect of mathematical method*, Princeton, NJ: Princeton University Press. (Original work published in 1945).
- [24] SANTOS TRIGO, M. L. (1995), *Qué significa el aprender matemáticas? Una experiencia con estudiantes de cálculo*, *Educación Matemática*, 7 (1), 46–61.
- [25] SCHOENFELD, A. H. (1981), *Episodes and executive decisions in mathematical problem solving*, Paper presented at the Annual meeting of the American Educational Research Association, Los Angeles, CA (ERIC Documentation Reproduction Service No. ED201505).
- [26] SCHOENFELD, A. H. (1985), *Mathematical problem solving*, Orlando, FL: Academic Press.
- [27] SCHOENFELD, A. H. (1992), *Learning to think mathematically: Problem solving, metacognition, and sense making in mathematics*, In D. A. Grouws (Ed.), *Handbook of research on mathematics teaching* (pp. 334–370), New York, MacMillan Publishing.
- [28] SCHRAW, G., & GRAHAM, T. (1997), *Helping gifted students develop metacognitive knowledge*, *Roeper Review*, 20, 4–8.
- [29] STRAESSER, R. (2001), *Cabri-geometre: Does Dynamic Geometry Software (DGS) change geometry and its teaching and learning?*, *International Journal of Computers for Mathematical Learning*, Vol. 6, pp. 319–333.

- [30] STUART, C., THURLOW, D. (2000), *Making it their own: Preservice teachers' experiences, beliefs and classroom practices*, Journal of Teacher Education, 51, 113–121.
- [31] VON GLASERSFELD, E. (1982), *An interpretation of Piaget's constructivism*, Revue Internationale de Philosophie, 36 (4), 612–635.
- [32] VON GLASERSFELD, E. (1984), *An introduction to radical constructivism*, In P. Watzlawick (Ed.), *The invented reality* (pp. 17–40), New York: Norton (Originally published in P. Watzlawick (Ed.), *Die Erfundene Wirklichkeit*, Munich: Piper, 1981).
- [33] WILBURNE, J. M. (1997), *The effect of teaching metacognition strategies to preservice elementary school teachers on their mathematical problem solving achievement and attitude*. Doctoral dissertation, Temple University, Philadelphia.
- [34] YIMER, A., & ELLERTON, N. F. (2006), *Cognitive and metacognitive aspects of mathematical problem solving: An emerging model*, Conference Proceedings from MERGA 29 (pp. 575–582), Wairoonga, New South Wales, Australia: Mathematics Education Research Group of Australasia.

*Contact addresses:*

Doris Dumičić Danilović  
Department of Mathematics, University of Rijeka  
Radmile Matejčić 2, 51000 Rijeka, Croatia  
e-mail: ddumicic@math.uniri.hr

Sanja Rukavina  
Department of Mathematics, University of Rijeka  
Radmile Matejčić 2, 51000 Rijeka, Croatia  
e-mail: sanjar@math.uniri.hr

## **Kognitivni i metakognitivni procesi kod budućih nastavnika matematike prilikom rješavanja dva nerutinska problemska zadatka**

---

---

Doris Dumičić Danilović i Sanja Rukavina

Odjel za matematiku, Sveučilište u Rijeci, Hrvatska

*Sažetak.* Istraživači sve više prepoznaju važnost razvoja metakognitivnih strategija i vještina rješavanja problema kod učenika kako bi se poboljšao njihov uspjeh u matematici. Međutim, vrijeme posvećeno proučavanju i razvoju tih vještina kod studenata, budućih nastavnika matematike, je minimalno. Cilj ovog istraživanja je pružiti uvid u metakognitivne procese kod šest studenata nastavničkog smjera na diplomskom sveučilišnom studiju Matematika i informatika na Odjelu za matematiku Sveučilišta u Rijeci, prilikom rješavanja dvaju nerutinskih geometrijskih zadataka

Proveli smo kvalitativno istraživanje s višestrukim studijom slučaja. Promatrali smo koje se slabosti u znanju javljaju kod ispitanika, uz poseban naglasak na tome na koji način oni povezuju i primjenjuju svoje konceptualno i proceduralno znanje u nepoznatim problemskim situacijama. Naša namjera bila je istražiti koji se kognitivni i metakognitivni procesi javljaju kod ispitanika prilikom individualnog rješavanja nerutinskih geometrijskih zadataka, uz mogućnost korištenja softvera za dinamičnu geometriju (GeoGebra), te ispitati na koji način korištenje tog softvera može utjecati na njihovo razmišljanje, donošenje odluka i cjelokupan proces rješavanja problema.

*Ključne riječi:* rješavanje matematičkih problemskih zadataka, metakognicija, budući nastavnici matematike, nerutinski geometrijski problemski zadaci, softver za dinamičku geometriju

## Tendencies in identifying geometric shapes observed in photos of real objects – case of students of primary education

---

---

Karmelita Pjanić\*<sup>1</sup> and Sanela Nesimović<sup>2</sup>

<sup>1</sup>Faculty of Educational Sciences, University of Bihać, Bosnia and Herzegovina

<sup>2</sup>Faculty of Educational Sciences, University of Sarajevo, Bosnia and Herzegovina

*Abstract.* One of the tasks of initial teaching of geometry is developing students' spatial reasoning. Association of a geometrical content with real situations and objects is recommended for the realization of this task. Therefore, competencies related to spatial thinking, precisely spatial visualization, should be found among the competencies of the teachers. Among teachers' spatial visualization abilities, we can point out the ability to recognize geometric shapes met in different environments, and the ability to accurately and precisely describe these shapes using geometric terminology.

In this paper, we analyze (quantitatively and qualitatively) responses of 85 students of primary education in activity of identifying geometric shapes at 8 photos of real objects.

The analysis of students' answers is focused on the following objectives:

- to analyze the terms listed in the students' responses with special emphasis on accuracy, frequency and diversity of responses;
- to analyze and compare the use of plane geometry and solid geometry terms in students' answers;
- to classify students' incorrect answers.

Results indicate that each student stated 29 terms in average: 25 correct terms and 4 incorrect terms. There are eight different terms among the most frequent correct answers. The tendency in indicating plane figures more frequently than solids can be observed. More than two thirds of answers indicate 2D figures: 69.8% among all given answers and 70.9% of total correct answers. Even the results are satisfactory, the results point to the need for introducing tasks of this type in the training of future teachers.

*Keywords:* spatial visualization, geometric shape, plane figure, solid, identification

---

\*Corresponding author.

## 1. Introduction

In December 2006, the Parliament and the Council of the European Union's jointly brought Recommendations on key competences for lifelong learning. One of the eight key competences that is defined and discussed in this document is Mathematical competence and basic competences in science and technology. Mathematical competence is defined as the ability to develop and apply mathematical thinking in order to solve a range of problems in everyday situations. Building on a sound mastery of numeracy, the emphasis is on process and activity, as well as knowledge. Mathematical competence involves, to different degrees, the ability and willingness to use mathematical modes of thought (logical and spatial thinking) and presentation (formulas, models, constructs, graphs, charts).

In this paper we will focus to one segment of mathematical competence – spatial thinking. Taking into account that the teachers in primary education are those who systematically have to foster spatial thinking in children, there is a need to recognize this ability within primary education teachers as well. Main objective of this paper is to determine the extent to which students of primary education recognize geometric shapes on photographs of real objects and whether students correctly and accurately described shapes using geometric terminology.

## 2. Fostering spatial thinking in primary mathematics education

General goals of primary mathematics education in Bosnia and Herzegovina are aligned with the requirements for mathematical competence. One of the general goals is enabling students to abstract and spatial thinking and logical reasoning. Particularly, fostering spatial abilities and ability for recognition of geometrical properties is main objective in the domain of geometry and measurement in primary mathematics education. The Mathematics curriculum for primary education states that students should be able to distinguish geometrical solids from geometrical plane figures, to recognize and distinguish geometric solids: sphere, cube, cuboid, cylinder, pyramid and cone, to recognize and distinguish geometric plane figures: circle, square, rectangle and triangle, as well as to describe features of aforementioned geometric shapes. Furthermore, students should be able to recognize and distinguish shapes in their environment.

The geometry must serve the students to describe and organize their environment. Identifying geometric shapes among objects in the environment is the students' first step in the process of describing and organizing their own environment. On the other hand, geometric concepts appear with the process of abstraction of reality itself.

Thus, the development of students' spatial ability or spatial sense is one of the most important tasks of teaching in the domain of geometry and measurement. Spatial sense can be described as the ability to understand the outside world (Freudenthal, 1972). We will define spatial ability (spatial sense) as an intuitive sense for shapes in space, as well as a sense of geometrical aspects of the world that surrounds us and shapes that form the objects around us. It includes concepts of

traditional geometry, in particular the ability of recognition, visual representation and transformation of geometric shapes. On the other hand, it involves, for teaching geometry in Bosnia and Herzegovina, nonstandard views of the two-dimensional and three-dimensional shapes, such as tessellations, paper folding, drawing projections of geometric solids in square and triangular point network. Generally spatial ability includes abilities for spatial visualization and spatial orientation.

Spatial visualization includes the ability to imagine the movement of objects and spatial forms. These activities include the ability of mental moving of geometric representation (Bishop, 1980; Clements and Battista, 1992; Battista, 2007) or the ability to ‘make’ the object based on the transformation (Zacks et al., 2000). Clements (2004) uses term spatial orientation to describe our moving in the space. Children learn how to orient starting from different perspectives, describing routes, recognizing and understanding the shapes, proportion and relationship among objects in space.

Considering that the requirement for recognizing shapes in the real environment is among the goals of the curriculum, there is the challenge for teachers to meet this requirement. Certain studies show that some future teachers’ concepts and attitudes on the geometry are in a direct confrontation with the idea of geometry that describes a realistic environment. Particularly, future teachers see geometry as less important than arithmetic and tend to separate geometric content from other (Barrantes, Blanco, 2005). Such misconceptions about geometry and its role are consequence of inadequate geometry teaching at all levels. Namely, modest attention is paid to teaching geometry.

In addition, certain studies related to assessment of mathematical competence of future teachers (Tatto et al., 2008, Jerković et al., 2008), particularly studies focused on evaluating the level of adoption of geometric content (Romano et al., 2010) have shown that the level of geometric thinking of future primary education teachers is lower than the level desirable to perform the teaching profession.

A good teacher should be able to recognize geometric shapes in various everyday settings or in illustrations and to properly and accurately describe those shapes using geometric terminology. The aforementioned give teacher competence to assess, find, select the contents of learning which will lead to achieving objectives of initial teaching of geometry. Following previous considerations we come to the main task of our paper, that is, to determine the extent to which students of primary education recognize geometric shapes on photographs of real objects and whether students correctly and accurately described shapes using geometric terminology.

### 3. Method

The aim of the study is to examine the ability of primary education students to identify geometric shapes on photos of real objects.

The analysis of students’ answers is focused on the following objectives:

- to analyze the terms listed in the students’ responses with special emphasis on accuracy, frequency and diversity of responses;



- to analyze and compare the use of plane geometry and solid geometry terms in students' answers;
- to classify students' incorrect answers.

We analyze (quantitatively and qualitatively) answers of 85 primary education students during the activity of identifying geometric shapes in 8 photos of real objects. In order to fully accomplish the objectives of the study, special attention was paid to the selection of photos of real objects.

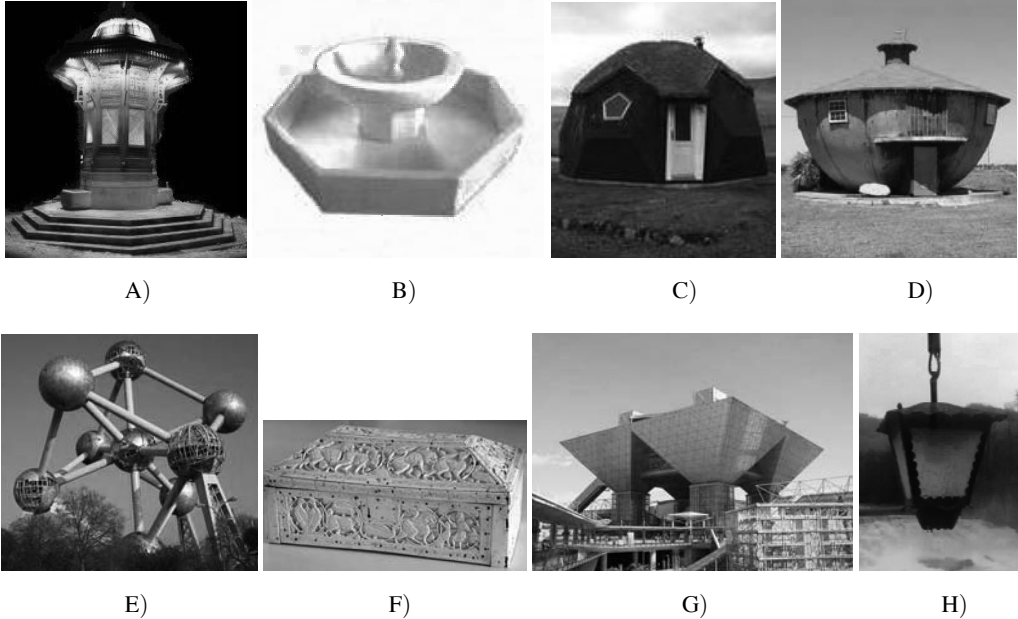

Figure 1. Photos of real objects: A) Sebilj, Sarajevo; B) fountain; C) house; D) house; E) Atomium, Brussels; F) casket, Berlin Museum; G) building, Tokyo; H) lamp<sup>1</sup>.

Photos were selected according to the following criteria:

- the abundance of geometric shapes on objects presented in photos,
- the presence of plane and solid shapes in the photos.
- the presence of “unusual” geometric shapes,
- the presence of perspective in photos.

Photos have been formatted (height: min. 6 cm (photo F) – max. 9 cm (photos A, H); width: min. 5 cm (photo H) – max. 9 cm (photo F)) and were printed in color. There were two images per page.

Participants had been students in four year baccalaurate program in primary education at two public universities in Bosnia and Herzegovina. In the sample

<sup>1</sup>Photos A), E), G), H) had been taken by the author. Sources of photos B), C), D) and F) are given in References.

of 85 students, there were 67 freshmen and 18 seniors. Mathematics curriculums in both universities are compatible. Geometry course is obligatory in the second semester. Topics about teaching geometry in primary school are included in program of Methodology of teaching mathematics which is compulsory course in 4th year of study. The survey was conducted in April 2014.

#### 4. Results and discussion

The first objective of our research is to analyse accuracy, frequencies and diversity of responses. The four most frequent correct answers for each of photos are given in Table 1.

Table 1. The most used correct answers.

photo A		photo B		photo C		photo D	
term	% of students	term	% of students	term	% of students	term	% of students
rectangle	100	rectangle	71.7	rectangle	85.9	rectangle	81.2
polygon	61.2	circle	61.2	pentagon	63.5	halfsphere	63.5
halfsphere	44.7	polygon	56.5	polygon	29.4	square	32.9
cube	35.3	square	31.8	trapezoid	28.2	circle	31.8
photo E		photo F		photo G		photo H	
term	% of students	term	% of students	term	% of students	term	% of students
sphere	85.9	rectangle	97.6	triangle	69.4	trapezoid	62.3
triangle	65.9	trapezoid	72.9	rectangle	54.1	triangle	29.4
cylinder	55.3	circle	50.6	square	41.2	cylinder	28.2
cube	38.8	square	44.7	cube	36.7	truncated pyramid	18.8

Analysis of the responses indicates that there are eight different terms among the most frequent correct answers. Rectangle is the most common term, followed by square. There is consistency in pointing out terms: rectangle, square, triangle, cube, sphere. If those shapes had been presented in photo, students identified them. On the other hand, there is no consistency in identification of truncated pyramid and trapezoid. Trapezoid is the most frequented term related to Photo H: 62.3% of all students (54.4% of freshmen and 78.6% of seniors) identified trapezoid. Even more students pointed out trapezoid in Photo F (72.9% of all students, 70.2% of freshmen and 78.6% of seniors). However, just 28.2% of all students (15% of freshmen and 77.7% of seniors) and 25.9% of all students (22.8% of freshmen and 50% of seniors) recognized trapezoid in Photo C and Photo G, respectively. Truncated pyramid is the fourth most used term used in Photo H (18.8% of all students; 12.2% of freshmen and 61.1% of seniors). At the same time, 27.2% of all students identified truncated pyramid in Photo G and only 7% of them in Photo F.

Comparing the answers of freshmen and seniors we find out that in the case of photos B, C, E and F the frequencies of correct terms are in the same order.

However, 95% of seniors indicate both circle and cylinder, but only 16% of freshman recognized cylinder. Differences in the responses of two groups of students related to the Photo G is most pronounced. Each senior indicated cuboid in Photo G and just 20% of freshman did the same thing. Similarly, 62% of seniors indicate truncated pyramid in Photo H compared to 18.8% freshmen.

Number of students compared to the number of different correct answers given is shown in Figure 2.

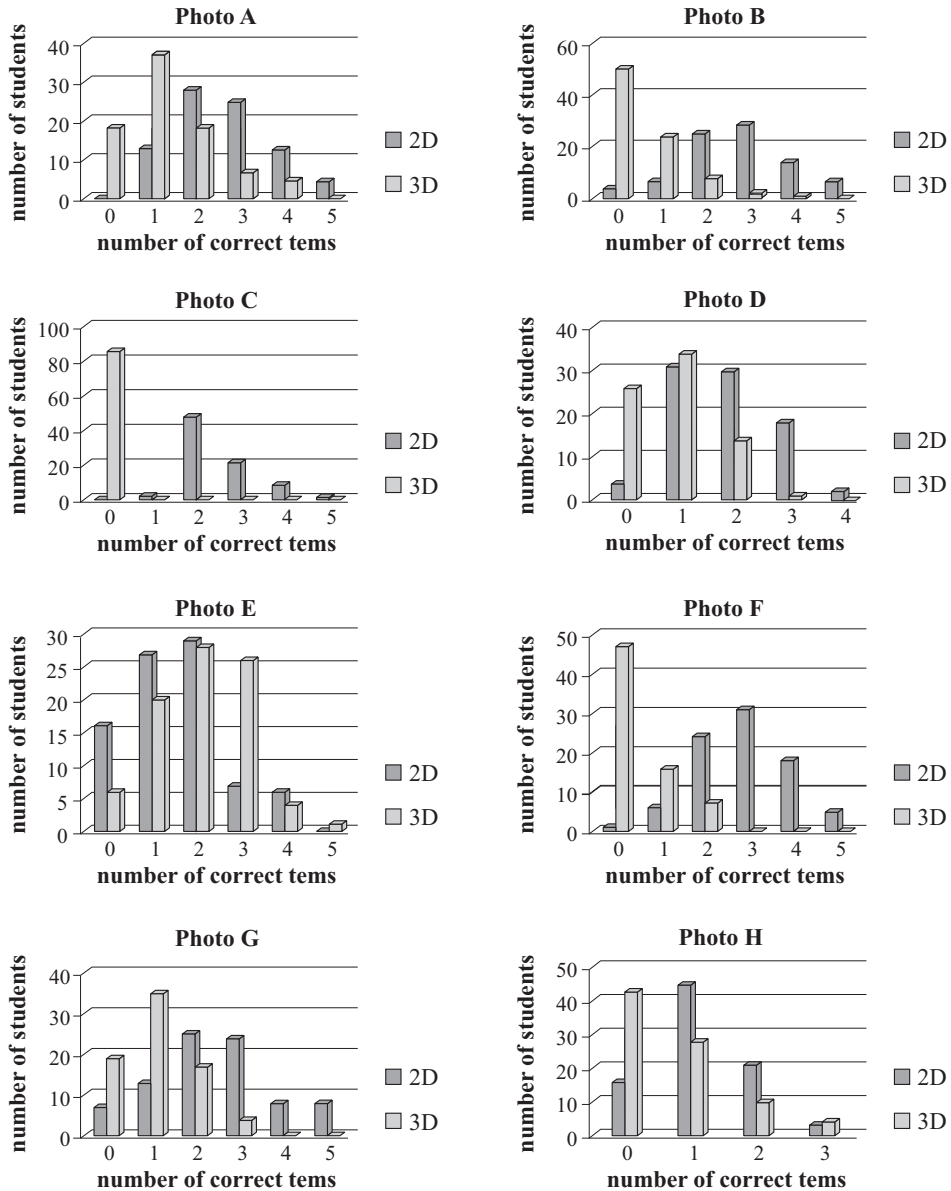

Figure 2. Number of students compared to the number of different correct answers given.

Number of correct terms used by each student varied from 0 to 9. At least one student identified 5 different types of figures in photos A, B, C, D, F i G. Four students identified 5 different types of solids in photo E. All students provided at least one correct term for photos A, C and F only. Majority of students identified at least 6 different shapes.

The most common incorrect answers are presented in Table 2.

Table 2. The most common incorrect answers.

photo A		photo B		photo C		photo D	
term	% of students	term	% of students	term	% of students	term	% of students
hexagon	17.6	hexagon	28.2	semisphere	20.0	square	28.2
sphere	4.7	cube	11.8	triangle*	7.1	triangle	21.2
photo E		photo F		photo G		photo H	
term	% of students	term	% of students	term	% of students	term	% of students
circle	17.6	square	8.2	pyramid	37.6	circle	14.1
rectangle	9.4	triangle	7.1	tetrahedron	1.8	rectangle	7.1

Number of different incorrect terms indicated in photos varied from 2 to 9. There were only two different incorrect terms in photos E and G, but nine different incorrect terms in photos A and C. The second most common wrong answer in photo C is triangle. We can notice triangle in photo C, however students' answers are not related to that triangle.

The second objective of our research is to analyze and the use of terms of plane and solid geometry. Results are presented Table 3.

Results presented in Table 3 indicate that in all photos, except photo E, there is more answers related to plane figures rather than solids. This is most evident in answers to photos C and F. Among answers to the photo C we observe almost eight times more 2D terms than 3D terms, similarly, among the answers to the photo F we observe almost six times more 2D terms than 3D terms. Also, in all photos, except photos D and H, students identified more types of plane figures than types of solids. We can spot similar ratio between 2D and 3D correct terms.

More than two thirds of answers indicate 2D figures: 69.8% among all given answers and 70.9% of total correct answers. In average, students identified 10 different 2D terms and 7.4 3D terms per image. There are 7 correct 2D terms and 4.4 correct 3D terms per image in average. There is no significant difference between freshmen and seniors in respect to this research task.

Finally, we will discuss types of wrong answers. We notice two main types of errors: those related to students' inability to recognize a shape, which is most obvious in the photo C where students could not recognize the shape of house and did not use term polyhedron, or in the photo D where they did not recognize the truncated pyramid in "upside down" position. The second type of error is the result

of an incorrect interpretation of the image, i.e. neglect of perspective. This type of error is most evident in answers to photos E and G.

Table 3. Numbers of 2D and 3D terms recognized in each photo.

		Total answers	Total terms	Answers %	Correct answers	Correct terms	Correct answers%
Photo A	2D	261	15	68.9	83	10	60.1
	3D	118	6	31.1	55	5	39.9
Photo B	2D	262	11	79.4	232	7	82.9
	3D	68	10	20.6	48	6	17.1
Photo C	2D	235	12	88.7	199	7	100
	3D	30	8	11.3	0	0	0
Photo D	2D	262	9	69.7	167	5	71.1
	3D	114	9	30.3	68	4	28.9
Photo E	2D	154	10	46.8	131	10	42.8
	3D	175	7	53.2	175	5	57.2
Photo F	2D	264	9	85.2	207	5	86.1
	3D	46	5	14.8	32	4	13.9
Photo G	2D	197	8	59.2	197	8	67.1
	3D	136	7	40.8	97	5	32.9
Photo H	2D	122	6	62.2	97	4	60.6
	3D	74	7	37.8	63	6	39.4
$\Sigma$	2D	1757		69.8	1313		70.9
	3D	761		30.2	538		29.1

## 5. Conclusion

One of the main tasks of teaching mathematics in primary school is to develop spatial sense of the pupils. In order to succeed in that task it is advisable to link the geometrical knowledge with the children's environment, among other things, to bring pupils into situations to recognize geometric shapes in their own environment. The success of the realization of such activities depends on the teachers, level of their spatial sense and of teachers' competencies in the area of developing spatial abilities of the pupils.

In this paper, we analyzed responses of 85 students of primary education in activity of identifying geometric shapes at 8 photos of real objects.

The obtained results lead to following conclusions: Each student stated 29 terms in average, 25 correct terms and 4 incorrect terms. Number of correct terms used by each student varied from 0 to 10 per photo. The tendency in indicating plane figures more frequently than solids can be observed. More than two thirds of answers indicate 2D figures: 69.8% among all given answers and 70.9% of total correct answers. In average, students identified 10 different 2D terms and 7.4 3D terms per image. There are 7 correct 2D terms and 4.4 correct 3D terms per image

in average. There is no significant difference between freshmen and seniors in respect to this research task. There are eight different terms among the most frequent correct answers. Rectangle is the most common term, followed by square. There is consistency in pointing out terms: rectangle, square, triangle, cube, sphere. If those shapes had been presented in photo, students identified them. On the other hand, there is no consistency in identification of truncated pyramid and trapezoid. Two types of errors are detected. The first type consists of errors related to the inability of students to appoint or recognize a shape. This type of error is best illustrated by an example of naming a polyhedron, or failure to recognize the truncated pyramid in “upside down” position. The second type of error is the result of an incorrect interpretation of the image, i.e. of ignoring perspective.

Since the students were not previously encountered with the tasks of this type, their results are satisfactory. At the same time, the results point to the need for introducing tasks of this type in the training of future teachers. In the wake of this research and the obtained results, future research with same objectives could be directed at population of pupils from elementary and secondary schools.

## References

- [1] BATTISTA, M. T. (2007), *The Development of Geometric and Spatial Thinking*, In Frank K. Lester (Ed.), *Second handbook of research of mathematics teaching and learning: a project of the National Council of Teachers of Mathematics*, 2nd edition, Charlotte, NC: Information Age. R.
- [2] BARNES, M., BLANCO, L. J. (2005), *Análisis de las concepciones de los profesores en formación sobre la enseñanza y aprendizaje de la geometría*, *Números*, 62, 33–44.
- [3] BISHOP, A. J. (2000), *Spatial abilities and mathematics achievement*, *Educational Studies in mathematics*, 11 (2000), 257–269.
- [4] CLEMENTS, D. H.; BATTISTA, M. T. (1992), *Geometry and Spatial Reasoning*, In D. A. Grouws, D. (Ed.), *Handbook of Research on Mathematics Teaching and Learning: a Project of the National Council of Teachers of Mathematics*, New York: Macmillan Publishing Company.
- [5] CLEMENTS, D. H. (2004), *Major themes and recommendations*, In: *Engaging young children in mathematics: standards for early childhood mathematics* (editors: D. H. Clements and J. Sarama), Mahwah, Lawrence Erlbaum Association, Inc, 7–75.
- [6] DUVAL, R. (1998), *Geometry from a cognitive point of view*, In: Mammana, C.; Villani, V. (Eds.), *Perspectives on the teaching of geometry for the 21st century* (New ICMI Study Series no. 5), Dordrecht, Holland: Kluwer, 37–52.
- [7] FREUDENTHAL, H. (1972), *Mathematics as an Educational Task*, Springer.
- [8] HO SIEW YIN (2003), *Young Children’s Concept of Shape: Van Hiele Visualization Level of Geometric Thinking*, *The Mathematics Educator*, 7 (2), 71–85.
- [9] JERKOVIĆ, I., GAVRILOV-JERKOVIĆ, V., MIHIĆ, I., PETROVIĆ, J. (2008), *Razvoj matematičkih kompetencija kod učitelja – problem početne tačke*, XIV skup Trendovi razvoja: Efikasnosti kvalitet bolonjskih studija, Kopaonik, [http://www.trend.uns.ac.rs/stskup/trend\\_2008/radovi/Tema5/T5-9.pdf](http://www.trend.uns.ac.rs/stskup/trend_2008/radovi/Tema5/T5-9.pdf) [Accessed 01/02/2014].

- [10] *Key competences for lifelong learning – a European reference framework, annex to Recommendation of the European Parliament and of the Council of 18 December 2006*, Official Journal of the European Union <http://eur-lex.europa.eu/legal-content/EN/TXT/?uri=celex:32006H0962> [Accessed 11/04/2014].
- [11] LANCIANO, N. (2005), *The processes and difficulties of teachers trainees in the construction of concepts, and related didactic material, for teaching geometry*, CERME 3, WG7.
- [12] *Okvirni nastavni plan i program za devetogodišnju osnovnu školu*, FMON, <http://www.skolegijum.ba/static/pdf/52df9345338c0.pdf> [Accessed 11/04/2014].
- [13] ROMANO D., TODIĆ, V., VINČIĆ M. (2010), *Jedno utvrđivanje geometrijskih kompetencija studenata studijskog programa za obrazovanje učitelja*, Istraživanje matematičkog obrazovanja (IMO) Vol. II (3), 33–45.
- [14] TATTO, M. T., SCHWILLE, J., SENK, S., INGVARSON, L., PECK, R., ROWLEY, G. (2008), *Teacher Education and Development Study in Mathematics (TEDS-M): Policy, practice, and readiness to teach primary and secondary mathematics*, Michigan: Teacher Education and Development International Study Center.
- [15] VINNER, S.; HESHKOWITZ, R. (1980), *Concept images and common cognitive paths in the development of some simple geometric concepts*, In R. Karplus (Ed.), *Proceedings of the Fourth International Conference for the Psychology of Mathematics Education*, Berkeley, CA: Lawrence Hall of Science, University of California, 177–184.
- [16] ZACKS, J. M., MIRES, J., TVERSKY, B., HAZELTINE, E. (2000), *Mental spatial transformations of objects and perspective*, *Spatial Cognition and Computation*, 2 (4), 315–332.

Sources of photos used in research:

Photo B – fountain

<http://www.google.com/imgres?imgurl=http://www.plantsforhire.com/images/Prod3Pics/LargeRomanFountain1.jpg&imgrefurl=http://www.plantsforhire.com/prod03.htm&h=607&w=601&tbnid=GnL39mQiP7C3FM:&zoom=1&dclid=NiTZcSBFF0ba9M&ei=sZTUVIySPN007QahYDYDQ&tbn=isch&ved=0CF4QMyhWMFY4yAE>, [Accessed 04/03/2014].

Photo C – polyhedron house

[http://www.google.com/imgres?imgurl=http://www.oddee.com/\\_media/imgs/articles/a328\\_h19.jpg&imgrefurl=http://www.oddee.com/item\\_96556.aspx&h=305&w=450&tbnid=VjFcalhM8iWhMM:&zoom=1&dclid=jL90LtIHKc4CwM&ei=mJDUV0ioJ4GU7Aab8IHgCA&tbn=isch&ved=0CGsQMyhAMEA](http://www.google.com/imgres?imgurl=http://www.oddee.com/_media/imgs/articles/a328_h19.jpg&imgrefurl=http://www.oddee.com/item_96556.aspx&h=305&w=450&tbnid=VjFcalhM8iWhMM:&zoom=1&dclid=jL90LtIHKc4CwM&ei=mJDUV0ioJ4GU7Aab8IHgCA&tbn=isch&ved=0CGsQMyhAMEA), [Accessed 04/03/2014].

Photo D – round house, retrieved on April 4th, 2014. from

[https://www.pinterest.com/timouskidi/my-house-is-round/&h=327&w=450&tbnid=S\\_xW8L8PDR2\\_uHM:&zoom=1&dclid=PrmlA5kDm\\_8KYeM&ei=mJDUV0ioJ4GU7Aab8IHgCA&tbn=isch&ved=0CFAQMyglMCU](https://www.pinterest.com/timouskidi/my-house-is-round/&h=327&w=450&tbnid=S_xW8L8PDR2_uHM:&zoom=1&dclid=PrmlA5kDm_8KYeM&ei=mJDUV0ioJ4GU7Aab8IHgCA&tbn=isch&ved=0CFAQMyglMCU), [Accessed 04/03/2014].

Photo F – Ivory casket, Museum of Islamic Art at the Pergamon Museum Berlin,

[http://www.discoverislamicart.org/database\\_item.php?id=object;ISL;de;Mus01;12;en](http://www.discoverislamicart.org/database_item.php?id=object;ISL;de;Mus01;12;en) [Accessed 04/03/2014].

Contact addresses:

Karmelita Pjanić

Faculty of Educational Sciences, University of Bihać,  
Luke Marjanovića b.b. Bihać, Bosnia and Herzegovina  
e-mail: kpjanic@gmail.com

Sanela Nesimović

Faculty of Educational Sciences, University of Sarajevo,  
Skenderija 72 Sarajevo, Bosnia and Herzegovina  
e-mail: nesimovicsanela@hotmail.com

## Identifikovanje geometrijskih oblika uočenih na fotografijama realnih objekata – slučaj studenata razredne nastave

---

---

Karmelita Pjanić<sup>1</sup> i Sanela Nesimović<sup>2</sup>

<sup>1</sup>Pedagoški fakultet Univerziteta u Bihaću, Bosna i Hercegovina

<sup>2</sup>Pedagoški fakultet Univerziteta u Sarajevu, Bosna i Hercegovina

*Sažetak.* Jedan od zadataka početne nastave geometrije je razvijanje prostornog zora kod učenika. Preporučljivo je ovaj zadatak ostvarivati na način da povezujemo geometrijske sadržaje sa realnim situacijama i objektima. Stoga bi se među osnovnim kompetencijama učitelja trebale naći i kompetencije vezane za prostorni zor, preciznije prostornu vizualizaciju što podrazumijeva sposobnost prepoznavanja geometrijskih oblika koje svakodnevno susrećemo u različitim okruženjima, te sposobnost tačnog i preciznog opisivanja tih oblika korištenjem geometrijske terminologije.

U radu analiziramo (kvantitativno i kvalitativno) odgovore 85 studenata razredne nastave tokom aktivnosti identifikovanja geometrijskih oblika na 8 fotografija realnih objekata. Analiza odgovora studenata usmjerena je na sljedeće ciljeve:

- analizirati termine navedene u odgovorima studenata s posebnim osvrtom na učestalost, tačnost i raznolikost odgovora;
- analizirati korištenje termina geometrije ravni nasuprot terminima geometrije prostora;
- razvrstati netačne odgovore studenata.

Analizom odgovora studenata ustanovljeno je da je svaki od ispitanika u prosjeku naveo 29 različitih pojmova, od toga je 25 tačnih, a 4 netačna. Među najučestalijim tačnim odgovorima uočeno je 8 različitih pojmova. Odgovori koji ukazuju na likove u ravni učestaliji su od odgovora koji ukazuju na geometrijska tijela. Više od dvije trećine odgovora ispitanih studenata odnosi se na likove u ravni: 69.8% svih odgovora, te 70.9% tačnih odgovora. Iako na zadovoljavajućem nivou, rezultati istraživanja ukazuju na potrebu uključivanja problema ovog tipa u metodičku izobrazbu budućih učitelja radi poboljšavanja njihovih kompetencija vezanih za prostorni zor.

*Ključne riječi:* prostorni zor, geometrijski oblik, likovi u ravni, geometrijska tijela, identifikacija



# Visual mathematics and geometry, the “final” step: projective geometry through linear algebra

---

---

Emil Molnár\*, István Prok and Jenő Szirmai

Budapest University of Technology and Economics, Institute of Mathematics, Hungary

*Abstract.* The renaissance painters, *Leonardo da Vinci* and *Albrecht Dürer* analysed first the viewing process in the so-called *practical perspective*, and introduced the concept of the *point at infinity* as *ideal common point of parallel lines*. Namely, such ideal points can have proper image points in the *horizontal line*. This process led 300-400 years later to the *projective geometry* as a base of different non-Euclidean geometries. At the same time the free-hand-drawing and painting got their scientific base. Then *optics* developed with fantastic tools as glasses, telescopes, microscopes, etc.

After a more popular introduction to the classical projective space, we will illustrate our topic more sketchily by figures. Mathematics helped this process by introducing *homogeneous coordinates* and so by  $d + 1$ -*dimensional vector spaces* for  $d$ -dimensional geometries. On this basis nowadays we can design complicated and attractive pictures, animate moving, make fantastic films by computer.

The first author gratefully remembers to his teacher of drawing *Dezső Horváth* who introduced him into this knowledge in a primary school in Győr. The third author's math teacher in this topic was *Zoltán Dunay*, even a student of the first author. The influence of a charismatic teacher is always important and decisive in the development of an interested student.

*Keywords:* Euclidean-projective visualization, projective plane and space by linear algebra

**Mathematics Subject Classification 2010:** 15A75, 51N15, 65D18, 68U10.

## 1. On the classical projective geometry in Euclidean space $E^3$

Analyzing the viewing process of a painter, Leonardo da Vinci and Albrecht Dürer (~1520) made the model of practical perspective in Fig. 1-2. Here the (one) eye  $S$  of a painter looks at a (say) horizontal base plane  $\Sigma$  (e.g. the triangle  $ABC$ ), and

---

\*Corresponding author.

describes it on a vertical (say first) *picture plane*  $\Pi$  imitating the light rays into his eye  $S$  trough  $\Pi$  which meet it in the image points  $A'$ ,  $B'$ ,  $C'$ , respectively.

We introduce the so-called *box model* with two additional planes through  $S$  with intersection line  $s$ : the *eye plane*, parallel to  $\Sigma$  meeting  $\Pi$  in the line  $l'$ , *horizontal line*, and the *support plane*, parallel to  $\Pi$  meeting  $\Sigma$  in the line  $t$ , *pedal line*. The intersection line  $x = \Sigma \cap \Pi$  is called *axis*, each of its points is fixed at this projection.

As a line  $e$  parallel to  $BC$  on  $\Sigma$  (in Fig. 1.a) shows, its image  $e'$  in  $\Pi$  intersects  $B'C'$  in  $l'$  on the horizontal line  $l'$ , so that  $SI' \parallel BC \parallel e$ . This insists us to introduce a new point of  $\Sigma$ , the *ideal point*  $I$ , common with lines  $BC$ ,  $e$  and  $SI'$ , so that  $I'$  is just the image of this ideal point  $I$  on  $l'$  at the projection from  $S$ . Thinking of other parallel lines (as in a pencil) of  $\Sigma$ , we can introduce their new ideal point and its analogous image on  $l'$  at this projection.

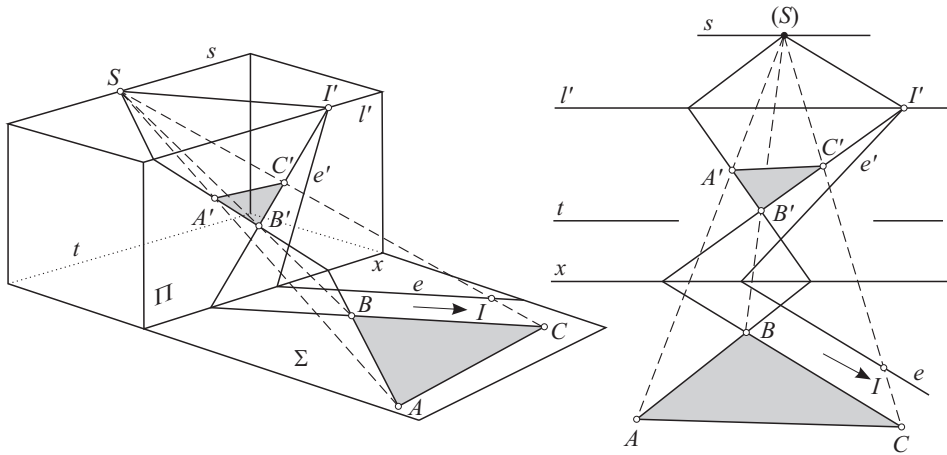

Figure 1. a, b Box model and the “pushing” procedure.

The next step in the abstraction is that we consider the collection of ideal points in  $\Sigma$  as belonging to a new ideal line  $l$  of  $\Sigma$ , so that the horizontal line  $l'$  is just the image of this line  $l$  at the projection from  $S$ . Parallel planes will have common ideal line, so as  $\Sigma$  and the eye plane through  $S$  have the common ideal line  $l$ . Analyzing further the above situation, we see that the above pedal line  $t$  of  $\Sigma$  and of the support plane can be considered as *preimage* of the ideal line  $t'$  of the picture plane  $\Pi$  at the projection from  $S$ . This latter mapping then becomes a bijective one  $\pi : \Sigma \cup l \rightarrow \Pi \cup t'$  between the extended planes, called them *projective planes*, with the same simpler notation.

Furthermore, any ideal line belongs to a parallel plane pencil. Then we unite all ideal lines to a unique *ideal plane* so that the Euclidean space  $\mathbf{E}^3$  extends to a *projective space*  $\mathcal{P}^3$ .

The box model in Fig. 1.a is, and will be, the base of our further considerations. E.g. “pushing” together the side planes around the lines  $x$ ,  $l'$ ,  $s$ ,  $t$  onto the picture

plane  $\Pi$  in Fig. 1.b, we get an important construction mapping of the united  $\Sigma := \Pi$  onto itself, from the above ones with the same notations

$$A \rightarrow A', B \rightarrow B', C \rightarrow C', I \rightarrow I', e \rightarrow e', l \rightarrow l', t \rightarrow t', \text{ etc.}$$

The derived mapping will be a *central axial collineation* with  $x$  as *axis*, where any line and its image line intersect; and with a *centre*  $(S)$ , where the rays  $AA', BB', CC', \dots, XX'$  meet, for any point  $X$  and its image  $X'$ . It turns out, from the above pushing procedure, that the centre  $(S)$  will be just the rotated image of the eye  $S$  about the horizontal line  $l'$  (compare Fig. 1.a,b).

Fig. 2.a shows, how to construct the picture of a cube under the above procedure. The height  $h$  of the cube is equal to the side of the rotated base square. The line  $x^h$  is the new axis for the upper face of the cube ( $x \parallel x^h$  in distance  $h$ ).

Fig. 2.b shows a principal procedure, used by the renaissance painters: For a given convex quadrangle  $A'B'C'D'$ , not a parallelogram, construct the eye point  $S$ , so that  $A'B'C'D'$  be a projection of a square  $ABCD$  from  $S$ . First the “horizontal” line  $l'$  can be constructed by the intersection points  $A'B' \cap D'C'$  and  $A'D' \cap B'C'$ . Then  $(S)$  will be the intersection of two Thales half-circles. Comparing with Fig. 1, we obtain  $S$  by a spatial construction, up to similarity.

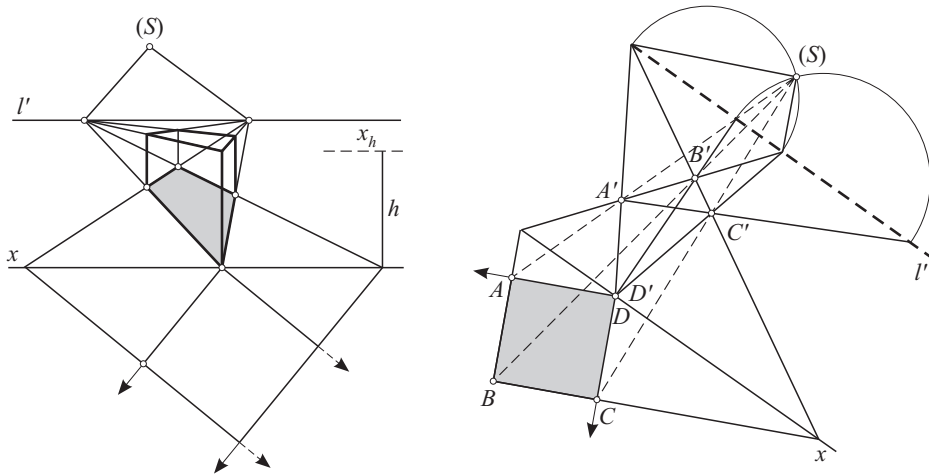

Figure 2. a: How to picture a cube; b: A quadrangle  $A'B'C'D'$  can be the image of a square  $ABCD$ .

The practical perspective above is called also *of two direction points*. The integer coordinate pairs of an *infinite chess board* of  $\Sigma$  will be preserved in the quadrangle net at the projection in Fig. 2.b. Imagine the origin at  $D$  (and  $D'$ ),  $DA$  is the coordinate axis (new)  $x$ ,  $DC$  is the  $y$  axis, so as  $D'A' \rightarrow x'$ ,  $D'C' \rightarrow y'$ , respectively. The repeated quadrangles accumulate near the horizontal line  $l'$ . The “other side” of  $l'$  and “near the ideal line  $t'$ ” the situation is not clear yet. This is why we shall prefer the so called homogeneous coordinate simplex later on (from Sect. 2).

At the cube picture in Fig. 2.a we can imagine also a spatial coordinate system, where the third  $z$ -axis is parallel to the picture plane  $\Pi$ . The so called *central*

or projective axonometry, or also called *perspective of three direction points* will generalize the previous method. These ideas were also known for the renaissance painters.

We look at Fig. 3.a the picture plane  $\Pi$ , the eye  $S$  in distance  $d$  with orthogonal projection  $S_0$ , the distance circle centred in  $S_0$  with radius  $d = SS_0$ . Space will be described by a Cartesian coordinate system. Its origin  $E_0$  shall be in  $\Pi$  for simplicity;  $E_1^\infty, E_2^\infty, E_3^\infty$  are the ideal points of the coordinate axes  $x, y, z$ , respectively.  $E_{10}, E_{20}, E_{30}$ , are the corresponding unit points. Our task is to describe the projections from  $S$  into  $\Pi$ , so that the spatial situation has to be reconstructed from the picture, as Fig. 4 indicates it.

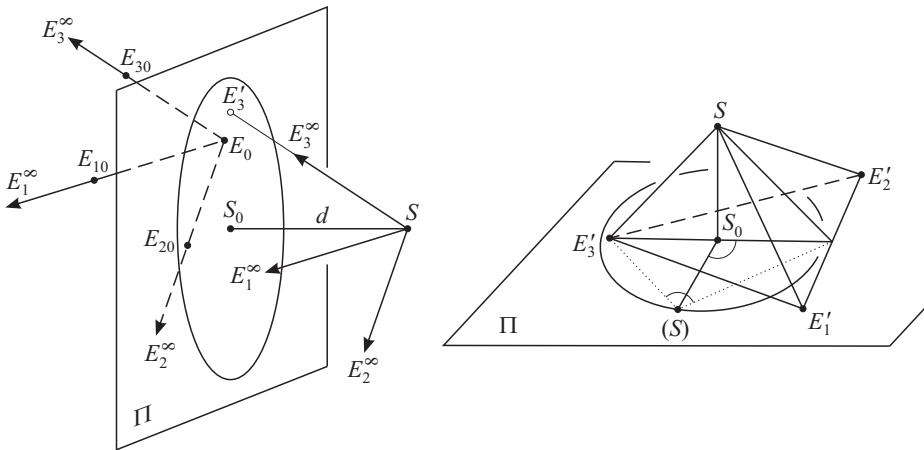

Figure 3. a: General projection of a coordinate system  $E_0, E_1^\infty, E_2^\infty, E_3^\infty$ ; b: Construction scheme for Fig. 4.

To this we translate the coordinate system to the eye  $S$ , so that  $E_0 \rightarrow S$  and we determine the images  $E'_1 = U'_x, E'_2 = U'_y, E'_3 = U'_z$  of the ideal (infinite = unendliche in German) points of the axes, first in Fig. 3.b, then in Fig. 4. Comparing these two figures, we see that a prescribed acute angle triangle  $E'_1 E'_2 E'_3$  will define the situation above. Namely, the orthocentre (height point) of this latter triangle will be just  $S_0$ , and the distance  $d = SS_0$  can be reproduced by the Thales half-circle over any height segment as diagonal (see Fig. 3.b; the construction is not indicated over  $E'_3 T_3$  in Fig. 4: e.g.  $dd = E'_3 S_0 \cdot S_0 T_3$ ).

The box model, now with not orthogonal base plane and picture plane can be applied also now for constructing the image unit points  $E'_{10}, E'_{20}, E'_{30}$ . By rotation of the coordinate plane, first  $E_0 E_1^\infty E_3^\infty$  with the eye plane  $SE'_1 E'_3$  about its horizontal line  $E'_1 E'_3$  and about axis through  $E_0 = E'_0$  (a parallel to  $E'_1 E'_3$ , not indicated in Fig. 4), we get the rotated  $(S)_2$  and  $E_0(E_{10})_2 \parallel (S)_2 E'_1$  and  $E_0(E_{30})_2 \parallel (S)_2 E'_3$ . Then we get  $E'_{10}$  on the line  $(S)_2(E_{10})_2$  and we get  $E'_{30}$  on the line  $(S)_2(E_{30})_2$ . Similar construction provides  $E'_{20}$  (and again  $E'_{30}$ ) from the rotation of the coordinate plane  $E_0 E_2^\infty E_3^\infty$  together with the eye plane  $SE'_2 E'_3$  about  $E'_2 E'_3$  and about its parallel through  $E_0 = E'_0$  (first we get  $(S)_1$  then  $E_0(E_{20})_1 \parallel (S)_1 E'_2$ , then  $E'_{20}$  on  $(S)_1(E_{20})_1$ ).

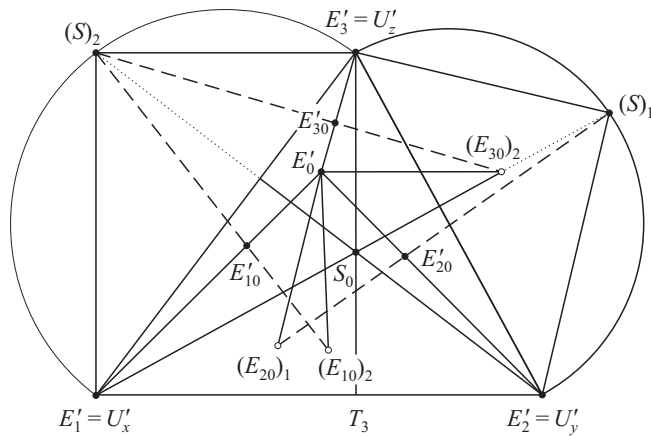

Figure 4. The basic constructions of central axonometry.

These classical drawing methods belong to mastership of an “old” architect. See e.g. the paper [16] of our architect colleague, *Mihály Szoboszlai*. Fig. 5 illustrates this construction by the computer program *AUTOCAD*. As an extra home work our *MSC* student, *Bettina Szukics* (2011) made a phantasy picture on the *Paris’ Triumphant Arch*. Nowadays computer algorithms, on the base of homogeneous coordinates by linear algebra, are much more effective. This modern machinery will be applied in the following, by shorter introduction for the interested reader.

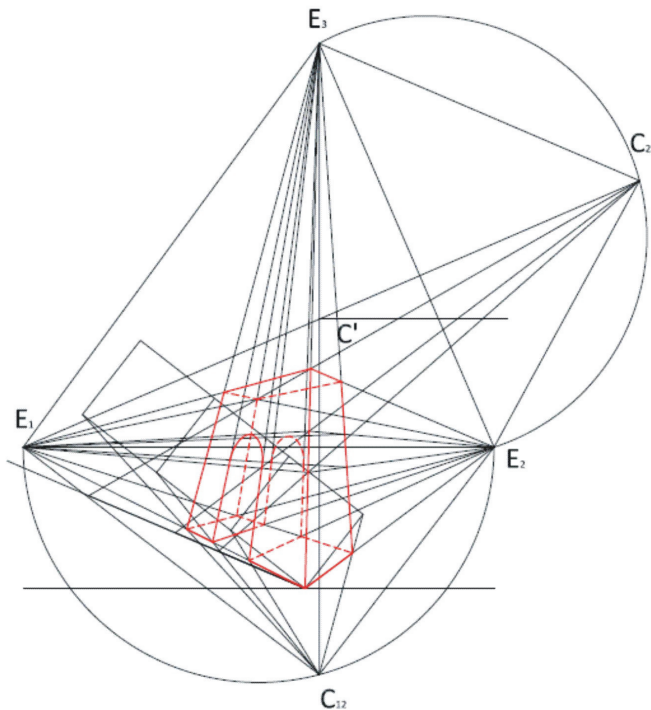

Figure 5. “The Triumphant Arch” in central axonometry.

## 2. The projective sphere and plane modelled in Euclidean 3-space

The projective space geometry and all the known non-Euclidean spaces (e.g. the 8 Thurston 3-geometries) can be uniformly modelled in the *projective spherical space*  $\mathcal{PS}^3$  that can be embedded into the affine 4-space so into the *Euclidean 4-space*.

Our main tool will be a 4-dimensional vector space  $\mathbf{V}^4$  over the real numbers  $\mathbf{R}$  with basis  $\{\mathbf{e}_0, \mathbf{e}_1, \mathbf{e}_2, \mathbf{e}_3\}$  (which is not assumed to be orthonormal, although this is easier). For constructing projective model of certain geometries, our goal will be to introduce *convenient additional structures* on  $\mathbf{V}^4$  and on its dual  $\mathbf{V}_4$  (e.g. specific scalar product).

The method will be illustrated and visualized first in dimensions 2 (Fig. 6) where  $\mathbf{V}^3$  is the embedding real vector space with its affine picture  $\mathcal{A}^3(O, \mathbf{V}^3, \mathbf{V}_3)$ , so in  $\mathbf{E}^3$ . Let  $\{O; \mathbf{e}_0, \mathbf{e}_1, \mathbf{e}_2\}$ , be a *coordinate system* in the affine 3-space  $\mathcal{A}^3 = \mathbf{E}^3$  with origin  $O$  and a (not necessarily orthonormal) vector basis  $\{\mathbf{e}_0, \mathbf{e}_1, \mathbf{e}_2\}$ , for  $\mathbf{V}^3$ , where our affine model plane

$$\mathcal{A}^2 = \mathbf{E}^2 \subset \mathcal{P}^2 = \mathcal{A}^2 \cup (i)$$

is placed to the point  $E_0(\mathbf{e}_0)$  with equation  $x^0 = 1$ . A non-zero vector

$$\mathbf{x} = x^0\mathbf{e}_0 + x^1\mathbf{e}_1 + x^2\mathbf{e}_2 + x^3\mathbf{e}_3 =: x^i\mathbf{e}_i$$

(the *sum index convention of Einstein-Schouten* will be used) represents a point  $X(\mathbf{x})$  of  $\mathcal{A}^2$ , but also a point of the *projective sphere*  $\mathcal{PS}^2$  after having introduced the following *positive equivalence*. For non-zero vectors

$\mathbf{x} \sim c.\mathbf{x}$  with  $0 < c \in \mathbf{R}$  represent the same point  $X = (\mathbf{x} \sim c.\mathbf{x})$  of  $\mathcal{PS}^2$ ;

$$\mathbf{z} \sim 0.\mathbf{e}_0 + z^1\mathbf{e}_1 + z^2\mathbf{e}_2 \text{ will be an ideal point } (\mathbf{z}) \text{ of } \mathcal{PS}^2 \text{ to } \mathcal{A}^2 \quad (1)$$

We write:  $(\mathbf{z}) \in (i)$ , where  $(i)$  is the ideal line (circle of  $\mathcal{PS}^2$ ) to  $\mathcal{A}^2$ , extending the affine plane  $\mathcal{A}^2$  into the projective sphere  $\mathcal{PS}^2$ . Here  $(\mathbf{z})$  and  $(-\mathbf{z})$ , and in general  $(\mathbf{x})$  and  $(-\mathbf{x})$ , are opposite points of  $\mathcal{PS}^2$ . Then *identification* of the opposite point pairs of  $\mathcal{PS}^2$  leads to the projective plane  $\mathcal{P}^2$ . Thus the embedding  $\mathcal{A}^2 = \mathbf{E}^2 \subset \mathcal{P}^2 \subset \mathcal{PS}^2$  can be formulated in the vector space  $\mathbf{V}^3$  in a unified way. We can present  $\mathcal{PS}^2$  (in Fig. 6) also as a usual sphere (of arbitrary radius) and think of the *celestial sphere* as the map of stars of the *Universe*. The equator ( $x^0 = 0$ ) represents the ideal points to  $\mathcal{A}^2$ , as ideal line (circle of  $\mathcal{PS}^2$ ). The *upper half sphere* describes  $\mathcal{A}^2 = \mathbf{E}^2$  with  $x^0 = 1$ . We also see how the *double affine plane* describes  $\mathcal{PS}^2$ , as the opposite direction in the abstraction (see also the lower plane  $x^0 = -1$  in Fig. 6).

**Remark 2.1** *The above 3-dimensional embedding of the Euclidean, or the more general affine plane, to characterize the ideal (infinite) points as well, comes from the previous practical perspective. But there are some surprising facts in*

the history of projective geometry which show that a 2-dimensional plane cannot always embed into a 3-dimensional space. This topic, on the role of Desargues theorem (axiom) in the 2-dimensional affine-projective geometry, illustrates also the barrier of visibility in geometry and in mathematics, in general. We do not mention more details in this paper.

The dual (form) space  $V_3$  to  $V^3$  is defined as the set of real valued linear functionals or forms on  $V^3$ . That means that we pose the following requirements for any form  $u \in V_3$ ;

$$u : V^3 \ni x \rightarrow xu \in \mathbf{R} \text{ with linearity}$$

$$(ax + by)u = a(xu) + b(yu) \text{ for any } x, y \in V^3 \text{ and for any } a, b \in \mathbf{R} \quad (2)$$

We emphasize our convention. The vector coefficients are written from the left, then linear forms act on vectors on the right (as an easy associativity law, analogous conventions will be applied also later on).

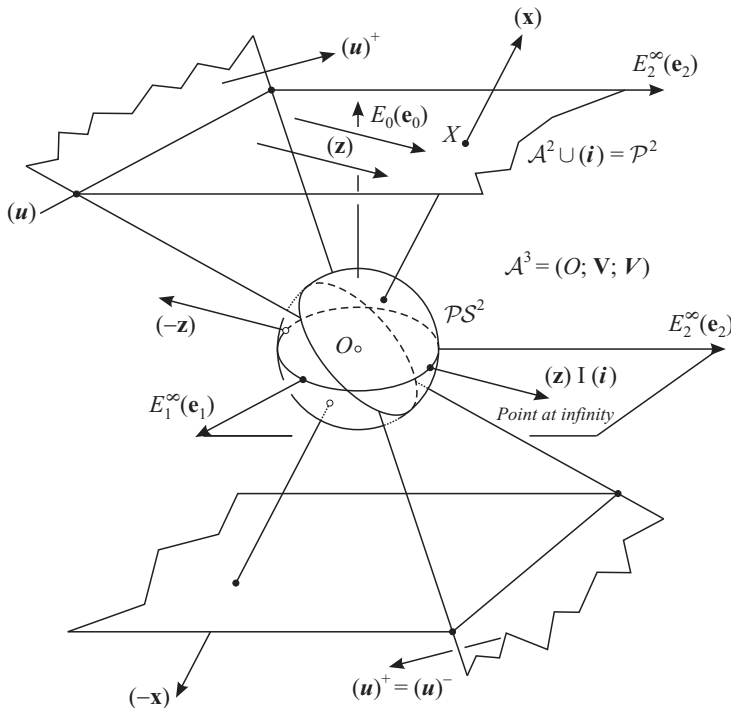

Figure 6. Our scene for dimensions 2 with projective sphere  $\mathcal{P}S^2$  embedded into the real vector space  $V^3$  and its dual  $V_3$ .

This “built in” linear structure allows us to define the addition  $u + v$  of two linear forms  $u, v$ , and the multiplication  $u \cdot c$  of a linear form  $u$  by a real factor  $c$ , both resulting in linear forms of  $V_3$ . Moreover, we can define for any basis  $\{e_i\}$  in

$\mathbf{V}^3$  the *dual basis*  $\{\mathbf{e}^j\}$  in  $\mathbf{V}_3$  by the Kronecker symbol  $\delta_i^j$ :

$$\mathbf{e}_i \mathbf{e}^j = \delta_i^j := \{1 \text{ if } i = j; 0 \text{ if } i \neq j; i, j = 0, 1, 2\}. \quad (3)$$

Furthermore, we see that the general linear form  $\mathbf{u} := \mathbf{e}^0 u_0 + \mathbf{e}^1 u_1 + \mathbf{e}^2 u_2 := \mathbf{e}^j u_j$  takes on the vector

$$\mathbf{x} := x^0 \mathbf{e}_0 + x^1 \mathbf{e}_1 + x^2 \mathbf{e}_2 := x^i \mathbf{e}_i$$

the real value

$$(x^i \mathbf{e}_i)(\mathbf{e}^j u_j) = x^i (\mathbf{e}_i \mathbf{e}^j) u_j = x^i \delta_i^j u_j = x^i u_j := x^0 u_0 + x^1 u_1 + x^2 u_2. \quad (4)$$

Thus, a linear form  $\mathbf{u} \in \mathbf{V}_3$  describes a *2-dimensional subspace*  $u$ , i.e. a vector plane of  $\mathbf{V}^3$  through the origin. Moreover, forms

$$\mathbf{u} \sim \mathbf{u}.k \text{ with } 0 < k \in \mathbf{R} \text{ describe the same oriented plane of } \mathbf{V}^3. \quad (5)$$

As in Fig. 6 a positive equivalence class of forms  $(\mathbf{u})$  gives an open *half-space*  $(\mathbf{u})^+$  of  $\mathbf{V}^3$ , i.e. the vector classes  $(\mathbf{x})$  for which

$$(\mathbf{u})^+ := \{(\mathbf{x}) : \mathbf{x}\mathbf{u} > 0\}. \quad (6)$$

This gives also a corresponding half-sphere of  $\mathcal{PS}^2$ , and a corresponding half-plane of  $\mathcal{A}^2$ . Note that *this is not so for the projective plane*  $\mathcal{P}^2$  which is not orientable, because the equivalence mapping  $\mathbf{x} \rightarrow -\mathbf{x}$  has negative determinant in  $\mathbf{V}^3$ !

In order to illustrate our topic with some applications, we introduce a *bijective linear mapping*  $\mathbf{T}$  of  $\mathbf{V}^3$  onto itself, i.e.

$$\begin{aligned} \mathbf{T} : \mathbf{V}^3 \ni \mathbf{x} &\rightarrow \mathbf{x}\mathbf{T} =: \mathbf{y} \in \mathbf{V}^3 \text{ with requirements} \\ x^i \mathbf{e}_i &\rightarrow (x^i \mathbf{e}_i)\mathbf{T} = x^i (\mathbf{e}_i \mathbf{T}) = x^i t_i^j \mathbf{e}_j =: y^j \mathbf{e}_j, \det(t_i^j) \neq 0 \end{aligned} \quad (7)$$

Assume that  $\mathbf{T}$  has the above matrix  $(t_i^j)$  with respect to basis  $\{\mathbf{e}_i\}$  of  $\mathbf{V}^3$  ( $i, j = 0, 1, 2$ ). Then  $\mathbf{T}$  defines a *projective point transformation*  $\tau(\mathbf{T})$  of  $\mathcal{PS}^2$  onto itself, which *preserves all the incidences of subspaces* of  $\mathbf{V}^3$  and so *incidences of points and lines* of  $\mathcal{PS}^2$ , respectively. The matrix  $(t_i^j)$  and its positive multiples  $(c.t_i^j) = (t_i^j.c)$  with  $0 < c \in \mathbf{R}$  (and only these mappings) define the same point transform  $\tau(\mathbf{T} \sim \mathbf{T}.c)$  of  $\mathcal{PS}^2$  by the above requirements. As usual, we define the composition, or product, of transforms  $\mathbf{T}$  and  $\mathbf{W}$  of vector space  $\mathbf{V}^3$  in this order (right action on  $\mathbf{V}^3$ ) by

$$\mathbf{T}\mathbf{W} : \mathbf{V}^3 \ni \mathbf{x} \rightarrow (\mathbf{x}\mathbf{T})\mathbf{W} = \mathbf{y}\mathbf{W} = \mathbf{z} =: \mathbf{x}(\mathbf{T}\mathbf{W}) \quad (8)$$

with matrices  $(t_i^j)$  and  $(w_j^k)$  to basis  $\{\mathbf{e}_i\}$  ( $i, j, k = 0, 1, 2$ ) as follows by our index conventions:

$$\mathbf{e}_i(\mathbf{T}\mathbf{W}) = (\mathbf{e}_i \mathbf{T})\mathbf{W} = (t_i^j \mathbf{e}_j)\mathbf{W} = (t_i^j)(w_j^k \mathbf{e}_k) = (t_i^j w_j^k) \mathbf{e}_k, \quad (9)$$



etc. with summation (from 0 to 2) for the occurring equal upper and lower indices. Moreover, we get the group of linear transforms of  $\mathbf{V}^3$  in the usual way, and so the group of projective transforms of  $\mathcal{PS}^2$  and  $\mathcal{P}^2$ , accordingly.

We also mention that the *inverse matrix class* of above  $(t_i^j)$ , now denoted by  $(t_i^j)^{-1} = (T_j^k) \sim (1/c).T_j^k$  with  $t_i^j T_j^k = \delta_i^k$ , induces the corresponding linear transform  $\mathbf{T}$  of the dual  $\mathbf{V}_3$  (i.e. for lines) onto itself, and its inverse  $\mathbf{T}^{-1}$ . That is in steps

$$\mathbf{T} : \mathbf{V}_3 \ni \mathbf{v} \rightarrow \mathbf{T}\mathbf{v} =: \mathbf{u} \in \mathbf{V}_3,$$

so that

$$\mathbf{y}\mathbf{v} = (\mathbf{x}\mathbf{T})\mathbf{v} = \mathbf{x}(\mathbf{T}\mathbf{v}) = \mathbf{x}\mathbf{u},$$

so especially

$$0 = \mathbf{x}\mathbf{u} = (\mathbf{x}\mathbf{T})(\mathbf{T}^{-1}\mathbf{u}) = \mathbf{y}\mathbf{v},$$

thus

$$0 = \mathbf{y}\mathbf{v} = (\mathbf{y}\mathbf{T}^{-1})(\mathbf{T}\mathbf{v}) = \mathbf{x}\mathbf{u}; \quad \mathbf{X}\mathbf{I}\mathbf{u} \leftrightarrow \mathbf{Y} := \mathbf{X}\mathbf{T}\mathbf{I}\mathbf{v} := \mathbf{T}\mathbf{u} \quad (10)$$

hold for the  $\tau$ -images of points and lines, respectively. We can see that the induced action on the dual  $\mathbf{V}_3$  is a *left action* and so is the induced action on the lines of  $\mathcal{PS}^2$ . This is according to our conventions, may be strange a little bit at the first glance, but we can utilize some benefits in the applications, e.g. projections with animations, optical mappings, etc.

We call your attention to our surveys [2], [7], [10] and other papers [4-6], [8] and [11-15] on non-Euclidean geometries.

#### **At the end we mention an amusing problem:**

*Let us given in the Euclidean plane a segment AB and its third dividing point H (say near A). Construct, exclusively with a lineal, the other third dividing point (near B).*

The problem is surprisingly hard. The *cross ratio*, as basic concept of projective geometry plays here a significant role!?

## **References**

- [1] BÖLCSKEI, A. AND MOLNÁR, E., *Classification and projective metric realizations of tile-transitive triangle tilings*, J. Geometry and Graphics **11/2** (2007), 137–163.
- [2] KATONA, J., MOLNÁR, E., PROK, I. AND SZIRMAI, J., *Higher dimensional central projection into 2-plane with visibility and applications*, Kragujevac Journal of Mathematics **35/2** (2011), 249–263.
- [3] KATONA, J., MOLNÁR, E., PROK, I. AND SZIRMAI, J., *Visualization with visibility of higher dimensional and non-Euclidean geometries*, Proceedings of the 16th International Conference on Geometry and Graphics, H-P. Schröcker, M. Husty (Ed.); Innsbruck University Press, Innsbruck (2014), # 60, 10 pages, ISBN: 978-3-902936-46-2.

- [4] MOLNÁR, E., *Polyhedron complexes with simply transitive group actions and their realizations*, Acta Math. Hung., (1991) **59/1-2**, 175–216.
- [5] MOLNÁR, E., *Combinatorial construction of tilings by barycentric simplex orbits ( $D$  symbols) and their realizations in Euclidean and other homogeneous spaces*, Acta Cryst. (2005) **A61**, 541–552.
- [6] MOLNÁR, E., *The projective interpretation of the eight 3-dimensional homogeneous geometries*, Beitr. Alg. Geom. (Contr. Alg. Geom.) (1997) **38/2**, 261–288.
- [7] MOLNÁR, E. AND SZIRMAI, J., *Symmetries in the 8 homogeneous 3-geometries*, Symmetry Cult. Sci. **21/1-3** (2010), 87–117.
- [8] MOLNÁR, E. AND SZILÁGYI B., *Translation curves and their spheres in homogeneous geometries*, Publ. Math. Debrecen. **78/2** (2011), 327–346.
- [9] MOLNÁR, E., PROK, I. AND SZIRMAI, J., *Classification of tile-transitive 3-simplex tilings and their realizations in homogeneous spaces*, A. Prékopa and E. Molnár, (Eds.). Non-Euclidean Geometries, János Bolyai Memorial Volume, Mathematics and Its Applications, Springer (2006) Vol. **581**, 321–363.
- [10] MOLNÁR, E., PROK, I. AND SZIRMAI, J., *The Euclidean visualization and projective modelling the 8 Thurston geometries*, Studies of the University of Žilina Mathematical Series 27/1, (2015), 35–62.
- [11] MOLNÁR, E., SZIRMAI, J. AND VESNIN, A., *Packings by translation balls in  $\sim \mathbf{SL}_2\mathbf{R}$* , J. Geometry **105/2** (2014), 287–306.
- [12] SCOTT, P., *The geometries of 3-manifolds*, Bull. London Math. Soc. **15** (1983), 401–487.
- [13] SZIRMAI, J., *The densest geodesic ball packing by a type of Nil lattices*, Beitr. Alg. Geom. (Contr. Alg. Geom.) (2007) **48/2**, 383–397.
- [14] SZIRMAI, J., *Lattice-like translation ball packings in Nil space*, Publ. Math. Debrecen, (2012) **80/3-4**, 427–440.
- [15] SZIRMAI, J., *A candidate to the densest packing with equal balls in the Thurston geometries*, Beitr. Algebra Geom. (Contr. Alg. Geom.) **55/2** (2014), 441–452.
- [16] SZOBOSZLAI, M., *Helicoids and their projection*, Katachi U Symmetry, Springer Verlag, Tokyo, (1996), 185–191.

Contact addresses:

Emil Molnár  
Budapest University of Technology and Economics,  
Institute of Mathematics, Department of Geometry  
H-1521 Budapest, Hungary  
e-mail: emolnar@math.bme.hu

István Prok  
Budapest University of Technology and Economics,  
Institute of Mathematics, Department of Geometry  
H-1521 Budapest, Hungary  
e-mail: prok@math.bme.hu

Jenő Szirmai  
Budapest University of Technology and Economics,  
Institute of Mathematics, Department of Geometry  
H-1521 Budapest, Hungary  
e-mail: szirmai@math.bme.hu

## Szemléletes matematika és geometria, az “utolsó” lépés: a projektív geometria bevezetése és a lineáris algebra

---

---

Emil Molnár, István Prok és Jenő Szirmai

Budapesti Műszaki és Gazdaságtudományi Egyetem, Matematika Intézet, Hungary

*Kivonat.* A reneszánsz kor festői, *Leonardo da Vinci* és *Albrecht Dürer* elemezték először a látási folyamatot, az úgy-nevezett *gyakorlati perspektívát*, és vezették be a *végtelen távoli pont* fogalmát, mint a párhuzamos egyenesek közös (*ideális*) pontját. Valóban, az ilyen ideális pontoknak *valódi képpontjai* lesznek a *horizont vonalon* (a *látóhatáron*). Ez a folyamat vezetett 300-400 évvel később a *projektív geometria* kialakulásához, amely különféle *nem-euklideszi geometriák* közös magjává vált. Egyidejűleg a *szabadkézi rajz* és a *festészet*, később az *optika* és fantasztikus eszközei, mint a *szemüveg*, *távcső*, *mikroszkóp* tudományos alapjai is kialakultak.

A klasszikus projektív tér fogalmának “népszerű” bevezetése után, vázlatosan, ábrákkal illusztráljuk témánkat. Matematikailag ez a folyamat a *homogén koordináták* bevezetésével,  *$d+1$ -dimenziós vektortér* segítségével írja le a  *$d$ -dimenziós geometriát*. Ez a módszer napjainkban lehetővé teszi, hogy bonyolult, szép rajzokat készítsünk, mozgásokat utánozzunk fantasztikus filmeket készítsünk számítógép segítségével.

Az első szerző hálával emlékszik rajztanárára, *Horváth Dezső* tanár úrra, aki ezekre az ismeretekre már az általános iskolában, Győrben megtanította. A harmadik szerzőt gimnáziumi matematika tanára, *Dunay Zoltán* vezette be ebbe a tárgykörbe. Ő éppen az első szerző egyetemi tanítványa volt. Talán ez is mutatja, hogy egy karizmatikus tanáregyéniség hatása mindig fontos, sőt döntő lehet az érdeklődő tanítványok fejlődésében.

*Kulcsszavak:* Euklideszi-projektív szemléltetés, projektív sík és tér lineáris algebrával.

**Mathematics Subject Classification 2010:** 15A75, 51N15, 65D18, 68U10.

## Is any angle a right angle?

Vladimir Volenec

Department of Mathematics, Faculty of Science, University of Zagreb, Croatia

*Abstract.* The explanation of the ostensible paradox, where it is shown that any angle is a right angle, is done by means of the well-known Descartes-Soddy's formula for the curvature of the four circles, which touch each other.

*Keywords:* triangle, circle, curvature, Soddy's formula

### 1. Introduction

Let the lengths of the sides of the given triangle  $ABC$  be labelled as follows:  $|BC| = b + c$ ,  $|CA| = c + a$ ,  $|AB| = a + b$ . Then the circles with the centers  $A, B, C$  and the radii  $a, b, c$  touch each other externally as in Figure 1. The circle with the center  $S$  and the radius  $r$ , which is touched internally by the three mentioned circles, is also presented in this figure.

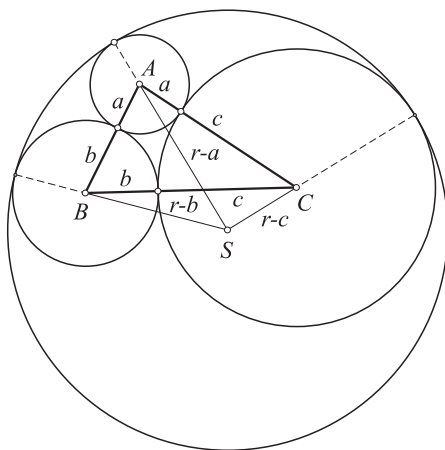

Figure 1.

The triangle  $ABC$  has a semiperimeter  $a + b + c$  and because of e.g.  $a + b + c - (b + c) = a$ , according to Heron's formula, its area is

$$p(ABC) = \sqrt{(a + b + c)abc}.$$

The triangle  $BCS$  has the lengths of the sides  $b + c$ ,  $r - b$ ,  $r - c$ , the semiperimeter  $r$ , and owing to Heron's formula, its area is

$$p(BCS) = \sqrt{rbc(r - b - c)}.$$

Similarly, the areas of the triangles  $CAS$  and  $ABS$  are

$$p(CAS) = \sqrt{rca(r - c - a)}, \quad p(ABS) = \sqrt{rab(r - a - b)},$$

respectively. Setting the obtained expressions in the obvious equality

$$p(ABC) + p(BCS) = p(CAS) + p(ABS),$$

we get an irrational equation for the unknown radius  $r$

$$\sqrt{(a+b+c)abc} + \sqrt{rbc(r-b-c)} = \sqrt{rca(r-c-a)} + \sqrt{rab(r-a-b)}. \quad (1)$$

Repeated squaring of (1) yields a very complicated equation of the eighth degree, which is in accordance with the fact that generally the problem of Apollonius has eight solutions. In our case, only two of these eight solutions are real and it would be hard to find them.

Fortunately, equation (1) has one obvious solution, i.e.,  $r = a + b + c$ . With this solution we now obtain

$$|BS| = r - b = a + c = |AC|, \quad |CS| = r - c = a + b = |AB|,$$

and  $ABSC$  is a parallelogram. However, we get

$$|AS| = r - a = b + c = |BC|,$$

and this parallelogram has equal diagonals, i.e., it is a rectangle. So,  $\sphericalangle BAC$  is a right angle! What's the catch?

## 2. Soddy's formula

An English physical chemist Frederick Soddy (1877–1965) received the Nobel prize in chemistry in 1921 for his research in the radioactive decay. He is the author of the words “an isotope” and a “chained reaction”. In [3] he published a poem under the title *The Kiss Precise*:

For pairs of lips to kiss maybe  
 Involves no trigonometry.  
 'Tis not so when four circles kiss  
 Each one the other three.  
 To bring this off the four must be  
 As three in one or one in three.  
 If one in three, beyond a doubt  
 Each gets three kisses from without.  
 If three in one, then is that one  
 Thrice kissed internally.

Four circles to the kissing come.  
 The smaller are the benter.  
 The bend is just the inverse of  
 The distance from the center.  
 Though their intrigue left Euclid dumb  
 There's now no need for rule of thumb.  
 Since zero bend's a dead straight line  
 And concave bends have minus sign,  
 The sum of the squares of all four bends  
 Is half the square of their sum.

To spy out spherical affairs  
 An oscular surveyor  
 Might find the task laborious,  
 The sphere is much the gayer,  
 And now besides the pair of pairs  
 A fifth sphere in the kissing shares.  
 Yet, signs and zero as before,  
 For each to kiss the other four  
 The square of the sum of all five bends  
 Is thrice the sum of their squares.

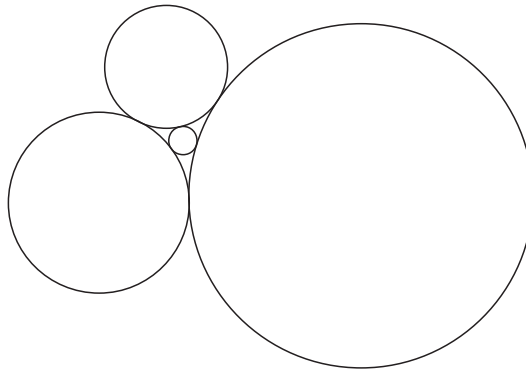

*Figure 2.*

We are most interested in the second strophe. The relationships between the radii of four circles, which touch each other externally as in Figure 2, are described therein. The word bend can be translated as the curvature, and it is in fact the reciprocal of the radius of the circle. If  $k_1, k_2, k_3, k_4$  are the curvatures of the four circles, then the so-called Soddy's formula

$$(k_1 + k_2 + k_3 + k_4)^2 = 2(k_1^2 + k_2^2 + k_3^2 + k_4^2) \quad (2)$$

holds.

If we consider the fourth circle, which is touched internally by the first three circles (as in Figure 1), then its curvature can be taken as negative. The third strophe describes an analogous formula for five spheres in a space, which touch each other mutually.

In the next year, in the same journal Thorold Gosset published the sequel to this poem, which gives a generalization of the given Soddy's formula for the case  $n + 2$  of the hypersphere, which touch each other in pairs in  $n$ -dimensional Euclidean space (see [2]).

### 3. Descartes' formula

"Soddy's" formula was known a long time ago before Soddy. In 1693, Rene Descartes proved formula (2) in a letter to the Czech princess Elizabeth. Indeed, he proved (2) in the form where instead of  $k_i$  the expression  $\frac{1}{r_i}$  comes for each  $i = 1, 2, 3, 4$ . This Descartes' formula was rediscovered by Phillip Beecroft in [1].

Let us prove Descartes' formula in the form (2).

Let us recall that Heron's formula for the area  $P$  of the triangle with the sides  $a, b, c$  can also be written in the form

$$16P^2 = 2b^2c^2 + 2c^2a^2 + 2a^2b^2 - a^4 - b^4 - c^4 = - \begin{vmatrix} 0 & c^2 & b^2 & 1 \\ c^2 & 0 & a^2 & 1 \\ b^2 & a^2 & 0 & 1 \\ 1 & 1 & 1 & 0 \end{vmatrix}.$$

Analogously, in the space, there is a formula for the volume  $V$  of the tetrahedron with the lengths of the edges  $d_{ij}$  for  $i, j \in \{1, 2, 3, 4\}$ ,  $i < j$ . It reads

$$288V^2 = \begin{vmatrix} 0 & d_{12}^2 & d_{13}^2 & d_{14}^2 & 1 \\ d_{12}^2 & 0 & d_{23}^2 & d_{24}^2 & 1 \\ d_{13}^2 & d_{23}^2 & 0 & d_{34}^2 & 1 \\ d_{14}^2 & d_{24}^2 & d_{34}^2 & 0 & 1 \\ 1 & 1 & 1 & 1 & 0 \end{vmatrix}.$$

Therefore, the determinant is equal to zero if and only if the considered four points (the vertices of the tetrahedron) lie on one plane.

The considered four circles touching each other can be taken as equatorial circles of four spheres touching each other, and their centres are coplanar. Then, the distances of their centres are  $d_{ij} = r_i + r_j$ , and the condition of the coplanarity gets the form

$$\begin{vmatrix} 0 & (r_1 + r_2)^2 & (r_1 + r_3)^2 & (r_1 + r_4)^2 & 1 \\ (r_1 + r_2)^2 & 0 & (r_2 + r_3)^2 & (r_2 + r_4)^2 & 1 \\ (r_1 + r_3)^2 & (r_2 + r_3)^2 & 0 & (r_3 + r_4)^2 & 1 \\ (r_1 + r_4)^2 & (r_2 + r_4)^2 & (r_3 + r_4)^2 & 0 & 1 \\ 1 & 1 & 1 & 1 & 0 \end{vmatrix} = 0.$$

If the last row (resp. column) is multiplied by  $r_i^2$  and if it is subtracted from the  $i$ -th row (resp. column) for each  $i = 1, 2, 3, 4$ , then we get

$$\begin{vmatrix} -2r_1^2 & 2r_1r_2 & 2r_1r_3 & 2r_1r_4 & 1 \\ 2r_1r_2 & -2r_2^2 & 2r_2r_3 & 2r_2r_4 & 1 \\ 2r_1r_3 & 2r_2r_3 & -2r_3^2 & 2r_3r_4 & 1 \\ 2r_1r_4 & 2r_2r_4 & 2r_3r_4 & -2r_4^2 & 1 \\ 1 & 1 & 1 & 1 & 0 \end{vmatrix} = 0.$$

Dividing the  $i$ -th row,  $i = 1, 2, 3, 4$  by  $2r_i$ , and the  $i$ -th column by  $r_i$ , and multiplying the last column by 2, we get the equality

$$\begin{vmatrix} -1 & 1 & 1 & 1 & k_1 \\ 1 & -1 & 1 & 1 & k_2 \\ 1 & 1 & -1 & 1 & k_3 \\ 1 & 1 & 1 & -1 & k_4 \\ k_1 & k_2 & k_3 & k_4 & 0 \end{vmatrix} = 0,$$

where  $\frac{1}{r_i} = k_i$ . Calculation of this determinant finally yields the equality

$$2k_1k_2 + 2k_1k_3 + 2k_1k_4 + 2k_2k_3 + 2k_2k_4 + 2k_3k_4 - k_1^2 - k_2^2 - k_3^2 - k_4^2 = 0,$$

and it is actually equality (2).

#### 4. The explanation of the ostensible paradox from the introduction

If the curvature of the required fourth circle is denoted by  $k_4 = x$ , then equality (2) can be written in the form of the equation

$$x^2 - 2(k_1 + k_2 + k_3)x + k_1^2 + k_2^2 + k_3^2 - 2(k_1k_2 + k_1k_3 + k_2k_3) = 0,$$

and it has the solutions

$$x = k_1 + k_2 + k_3 \pm 2\sqrt{k_1k_2 + k_1k_3 + k_2k_3}.$$



These solutions do not match with the solution which is offered in the introduction and actually given by  $-r = a + b + c$  (because of internal touching), i.e., by

$$\frac{1}{x} = - \left( \frac{1}{k_1} + \frac{1}{k_2} + \frac{1}{k_3} \right) = - \frac{k_1 k_2 + k_1 k_3 + k_2 k_3}{k_1 k_2 k_3}.$$

That “solution” of ours  $r = a + b + c$  cannot be realized in the plane, i.e., it is impossible to find four points  $A, B, C, S$  such that  $|BS| = |AC|$ ,  $|CS| = |AB|$ ,  $|AS| = |BC|$ . However, it can be realized in the space, i.e., there are tetrahedrons, whose opposite edges are equal. These are tetrahedrons with equal faces that are four congruent triangles.

## References

- [1] BEECROFT, H. (1846), *Properties of circles in mutual contact*, Lady’s and Gentleman’s Diary, 91–96; (1841) 51.
- [2] GOSSET, T. (1937), *The Kiss precise*, Nature 139, 62.
- [3] SODDY, F. (1936), *The kiss precise*, Nature 137, 1021.

*Contact address:*

Vladimir Volenec  
Department of Mathematics  
Faculty of Science  
University of Zagreb  
Bijenička cesta 30, 10 000 Zagreb, Croatia  
e-mail: volenec@math.hr

## Da li je moguće da je svaki kut pravi kut?

---

---

Vladimir Volenec

Prirodoslovno matematički fakultet, Matematički odsjek, Sveučilište u Zagrebu, Hrvatska

*Sažetak.* Primjenom poznate Descartes–Soddyjeve formule za zakrivljenosti četiriju kružnica, koje se međusobno diraju, objašnjava se prividni paradoks, u kojem se pokazuje da je bilo koji kut pravi kut.

*Ključne riječi:* trokut, kružnica, zakrivljenost, Soddyjeva formula

## An interesting analogy of Kimberling-Yff's problem

Zdenka Kolar-Begović<sup>1</sup>, Ružica Kolar-Šuper\*<sup>2</sup> and Vladimir Volenec<sup>3</sup>

<sup>1</sup>Department of Mathematics, Faculty of Education, Josip Juraj Strossmayer University of Osijek, Croatia

<sup>2</sup>Faculty of Education, Josip Juraj Strossmayer University of Osijek, Croatia

<sup>3</sup>Department of Mathematics, Faculty of Science, University of Zagreb, Croatia

*Abstract.* The existence of three circles touching the inscribed circle of an allowable triangle in an isotropic plane and going through two vertices of a considered triangle is proved in this paper. Some relations between these three circles of a triangle and elements of a triangle are investigated. Formulae for their radii are also given.

*Keywords:* isotropic plane, standard triangle, Kimberling-Yff's circles

By a suitable choice of coordinates, each allowable triangle in an isotropic plane can be set in the so-called *standard position*, i.e. such that its circumscribed circle has the equation  $y = x^2$  and its vertices are of the form  $A = (a, a^2)$ ,  $B = (b, b^2)$ ,  $C = (c, c^2)$ , where  $a + b + c = 0$ . By means of the labels  $p = abc$ ,  $q = bc + ca + ab$  it can be shown that the equality  $a^2 = bc - q$  is valid.

**Theorem 1.** *The circles  $\mathcal{K}_a, \mathcal{K}_b, \mathcal{K}_c$ , which touch the inscribed circle  $\mathcal{K}_i$  of the standard triangle  $ABC$  and pass through the given pairs of points  $B, C$ ;  $C, A$ ;  $A, B$ , respectively, have the equations*

$$\begin{aligned} \mathcal{K}_a \dots (q + 3bc)y &= (3bc - 2q)x^2 - 3aqx - 3bcq, \\ \mathcal{K}_b \dots (q + 3ca)y &= (3ca - 2q)x^2 - 3bqx - 3caq, \\ \mathcal{K}_c \dots (q + 3ab)y &= (3ab - 2q)x^2 - 3cqx - 3abq, \end{aligned} \quad (1)$$

and the points

$$D = \left( \frac{2q}{3a}, \frac{q^2}{9a^2} - q \right), \quad E = \left( \frac{2q}{3b}, \frac{q^2}{9b^2} - q \right), \quad F = \left( \frac{2q}{3c}, \frac{q^2}{9c^2} - q \right) \quad (2)$$

---

\*Corresponding author.

are the points of contact (Figure 1).

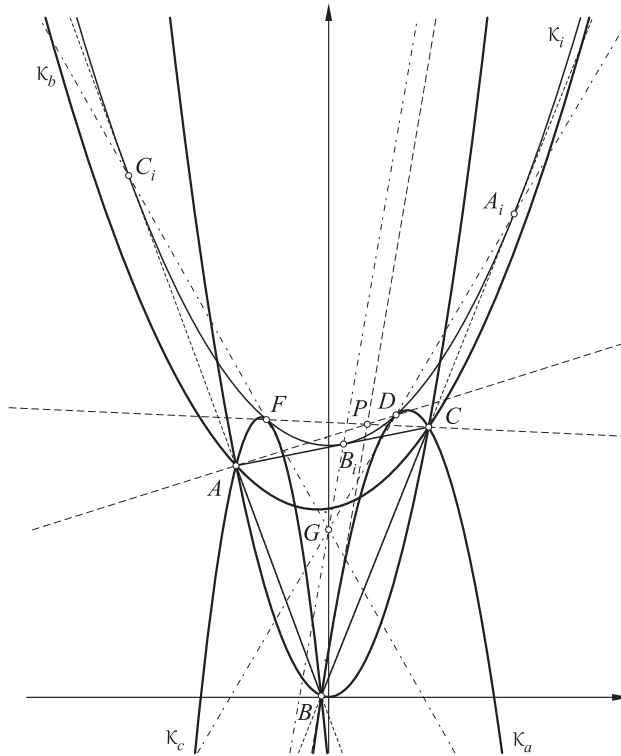

Figure 1.

*Proof.* According to [1], the inscribed circle  $\mathcal{K}_i$  of the standard triangle  $ABC$  has the equation  $y = \frac{1}{4}x^2 - q$ . Owing to this equation and the first equation in (1) we get the equation

$$(q + 3bc)(x^2 - 4q) = 4[(3bc - 2q)x^2 - 3a qx - 3bcq],$$

from where the abscissas of the intersections of the circles  $\mathcal{K}_i$  and  $\mathcal{K}_a$  will be obtained. This equation achieves the form

$$9(bc - q)x^2 - 12a qx + 4q^2 = 0,$$

i.e.  $(3ax - 2q)^2 = 0$ , and  $x = \frac{2q}{3a}$  is its double solution. Along with this abscissa of the point of contact, we get

$$y = \frac{1}{4} \left( \frac{2q}{3a} \right)^2 - q = \frac{q^2}{9a^2} - q$$

for its ordinate. □

**Theorem 2.** *By means of the labels in Theorem 1 the lines  $AD$ ,  $BE$ ,  $CF$  (Figure 1) pass through a point*

$$P = \left( \frac{27pq^2}{27p^2 - 5q^3}, \frac{135p^2q - 16q^4}{15q^3 - 81p^2} \right). \quad (3)$$

*Proof.* The point  $A = (a, a^2)$  and the points  $D$  and  $P$  from (2) and (3) lie on the line with the equation

$$3a(2q - 3a^2)y = (q^2 - 9ap)x + 15a^3q - aq^2$$

because of

$$\begin{aligned} & 3a(2q - 3a^2)a^2 - (q^2 - 9ap)a - 15a^3q + aq^2 \\ &= 9a^3(bc - q - a^2) = 0, \\ & 3a(2q - 3a^2) \left( \frac{q^2}{9a^2} - q \right) - (q^2 - 9ap) \frac{2q}{3a} - 15a^3q + aq^2 \\ &= 6aq(bc - q - a^2) = 0. \end{aligned}$$

But, we have also

$$\begin{aligned} & 3a(2q - 3a^2)(135p^2q - 16q^4) + (q^2 - 9ap)81pq^2 - (15a^3q - aq^2)(15q^3 - 81p^2) \\ &= 81aq^4(bc - q - a^2) = 0, \end{aligned}$$

i.e. the point  $P$  lies on the line  $AD$ , as well as on the lines  $BE$  and  $CF$ .  $\square$

In Euclidean geometry, statements analogous to this statement from Theorem 2 were obtained by C. Kimberling and P. Yff in [2]. This is the reason why the circles  $\mathcal{K}_a, \mathcal{K}_b, \mathcal{K}_c$  from Theorem 1 are called *Kimberling-Yff circles* of the triangle  $ABC$ , and the point  $P$  from Theorem 2 is called the *Kimberling-Yff point* of that triangle.

From (1) it follows that e.g. the circle  $\mathcal{K}_a$  has the radius

$$\frac{1}{2} \cdot \frac{q + 3bc}{3bc - 2q} = \frac{(b - c)^2}{2(c - a)(a - b)} = \frac{BC^2}{CA \cdot AB} R,$$

where  $R = \frac{1}{2}$  is the radius of the circumscribed circle  $\mathcal{K}$  of the triangle  $ABC$  with the equation  $y = x^2$ . So, we have the following:

**Theorem 3.** *The radii  $\rho_a, \rho_b, \rho_c$  of Kimberling-Yff circles  $\mathcal{K}_a, \mathcal{K}_b, \mathcal{K}_c$  of the allowable triangle  $ABC$  satisfy the equations*

$$\rho_a = \frac{BC^2}{CA \cdot AB} R, \quad \rho_b = \frac{CA^2}{AB \cdot BC} R, \quad \rho_c = \frac{AB^2}{BC \cdot CA} R, \quad \rho_a \rho_b \rho_c = R^3,$$

where  $R$  is the radius of the circumscribed circle  $\mathcal{K}$  of the triangle  $ABC$  (Figure 1).

**Theorem 4.** *If the points  $A_i, B_i, C_i$  are the points of contact of the inscribed circle of the allowable triangle  $ABC$  with its sides, and  $D, E, F$  are the points of contact of this circle with Kimberling-Yff circles of that triangle, then the lines  $A_iD, B_iE, C_iF$  pass through the centroid  $G$  of the triangle  $ABC$  (Figure 1).*

*Proof.* According to [1], the point  $A_i$  is of the form  $A_i = (-2a, bc - 2q)$ . This point and the point  $D$  from (2) lie on the line with the equation

$$y = \frac{1}{6a}(q - 3a^2)x - \frac{2}{3}q \quad (4)$$

since

$$\begin{aligned} \frac{1}{6a}(q - 3a^2)(-2a) - \frac{2}{3}q &= a^2 - q = bc - 2q, \\ \frac{1}{6a}(q - 3a^2) \frac{2q}{3a} - \frac{2}{3}q &= \frac{q^2}{9a^2} - q, \end{aligned}$$

i.e. it is the line  $A_iD$ . According to [3], we have the point  $G = \left(0, -\frac{2}{3}q\right)$  which obviously lies on line (4).  $\square$

The power of the point  $(x_0, y_0)$  with respect to the circle with the equation  $2\rho y = x^2 + ux + v$  is equal to  $x_0^2 + ux_0 + v - 2\rho y_0$ , see [4]. As the first equation in (1) can be written in the form

$$\frac{q + 3bc}{3bc - 2q}y = x^2 - \frac{3aq}{3bc - 2q}x - \frac{3bcq}{3bc - q},$$

then the power of the centroid  $G = \left(0, -\frac{2}{3}q\right)$  with respect to the circle  $\mathcal{K}_a$  has the value

$$-\frac{3bcq}{3bc - q} + \frac{2}{3}q \frac{q + 3bc}{3bc - 2q} = \frac{2q^2 - 3bcq}{3(3bc - 2q)} = -\frac{q}{3},$$

which is equal to the power of the point  $G$  with respect to the circles  $\mathcal{K}_b$  and  $\mathcal{K}_c$ , too. Because of that we get the following:

**Theorem 5.** *The centroid of an allowable triangle is the potential center of its Kimberling-Yff circles, and medians of this triangle are the radical axes of pairs of these circles (Figure 1).*

## References

- [1] BEBAN-BRKIĆ, J., KOLAR-ŠUPER, R., KOLAR-BEGOVIĆ, Z., VOLENEC, V. (2006), *On Feuerbach's Theorem and a Pencil of Circles in the Isotropic Plane*, Journal for Geometry and Graphics **10**, 125–132.
- [2] KIMBERLING, C., YFF, P. (1998), *Problem 10678*, Amer. Math. Monthly **105**, 666.
- [3] KOLAR-ŠUPER, R., KOLAR-BEGOVIĆ, Z., VOLENEC, V., BEBAN-BRKIĆ, J. (2005), *Metrical relationships in a standard triangle in an isotropic plane*, Mathematical Communications **10**, 149–157.
- [4] KOLAR-ŠUPER, R., KOLAR-BEGOVIĆ, Z., VOLENEC, V. (2008), *Apollonius Circles of the Triangle in an Isotropic Plane*, Taiwanese Journal of Mathematics **12**, 1239–1249.

*Contact addresses:*

Zdenka Kolar-Begović  
Faculty of Education  
Cara Hadrijana 10  
Department of Mathematics  
Trg Ljudevita Gaja 6  
Josip Juraj Strossmayer University of Osijek  
31000 Osijek, Croatia  
e-mail: zkolar@mathos.hr

Ružica Kolar-Šuper  
Faculty of Education  
Josip Juraj Strossmayer University of Osijek  
Cara Hadrijana 10, 31000 Osijek, Croatia  
e-mail: rkolar@foozos.hr

Vladimir Volenec  
Department of Mathematics  
Faculty of Science  
University of Zagreb  
Bijenička cesta 30, 10 000 Zagreb, Croatia  
e-mail: volenec@math.hr

## Zanimljiva analogija Kimberling-Yffovog problema

---

---

---

Zdenka Kolar-Begović<sup>1</sup>, Ružica Kolar-Šuper<sup>2</sup> i Vladimir Volenec<sup>3</sup>

<sup>1</sup>Fakultet za odgojne i obrazovne znanosti, Odjel za matematiku, Sveučilište Josipa Jurja Strossmayera u Osijeku, Hrvatska

<sup>2</sup>Fakultet za odgojne i obrazovne znanosti, Sveučilište Josipa Jurja Strossmayera u Osijeku, Hrvatska

<sup>3</sup>Prirodoslovno matematički fakultet, Matematički odsjek, Sveučilište u Zagrebu, Hrvatska

*Sažetak.* U radu je dokazano postojanje triju kružnica koje prolaze kroz dva vrha dopustivog trokuta i diraju tom trokutu upisanu kružnicu. Razmatrane su relacije koje postoje između tri spomenute kružnice i elemenata zadanog trokuta. Formule za radijuse kružnica su također navedene.

*Ključne riječi:* izotropna ravnina, standardni trokut, Kimberling-Yffove kružnice



# 5.

## Attitudes toward and beliefs about mathematics and teaching mathematics

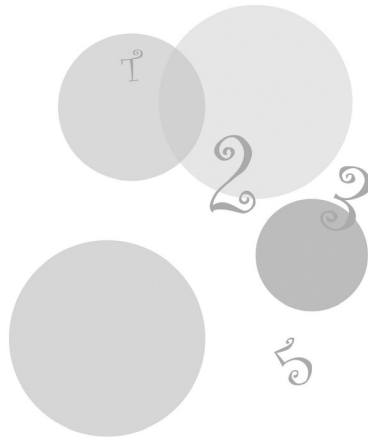



# Pre-service teachers and statistics: an empirical study about attitudes and reasoning

---

---

Ljerka Jukić Matić\*<sup>1</sup>, Ana Mirković Moguš<sup>2</sup> and Marija Kristek<sup>1</sup>

<sup>1</sup>Department of Mathematics, Josip Juraj Strossmayer University of Osijek, Croatia

<sup>2</sup>Faculty of Education, Josip Juraj Strossmayer University of Osijek, Croatia

*Abstract.* In this paper, we will discuss pre-service elementary teachers' attitudes towards statistics, as we believe that these attitudes have a key role in the teaching and learning process. The attitudes were examined using the Scale of Attitudes Towards Statistics and the analysis of results showed pre-service elementary teachers' neutral attitude toward statistics. Also, we examined their statistical reasoning in measures of center, using several items from Quantitative Reasoning Quotient Test. This analysis showed that pre-service teachers' statistical reasoning is inconsistent from item to item, or topic to topic, depending on the context of the problem. Results of both assessment instruments indicate that pre-service teachers lack awareness of the usefulness of statistics in everyday life and lack of experience of solving everyday problems. Since the attitudes have a significant effect on the learning process, we believe that not knowing where, why and when statistics can or will be used, influenced on pre-service elementary teachers' statistical reasoning.

*Keywords:* attitudes, reasoning, pre-service teachers, statistics, measures of center

## Introduction

Being statistically literate became an imperative in education around the world. More and more data are available to inform making of decisions in everyday life, what made statistical literacy and reasoning important for a functioning in the contemporary world. For example, according to the American Statistical Association and the National Council of Teachers of Mathematics, statistics should be a key

---

\*Corresponding author.

and component part of all levels and orientations of education (Barkley, 1995; according to Kesici, Baloğlu & Deniz, 2011).

Statistics in school is usually taught by mathematics teachers (Jacobbe & Fernandes de Carvalho, 2011). Teachers' attitudes towards statistics, as well as their understanding of statistical concepts, play an important role in achieving a success when implementing statistical curriculum. In Croatia, statistics is being taught as part of a primary school mathematics in grade 7 as of 2006, through a couple of hours (Glasnović Gracin & Vuković, 2010), but new national curriculum outlines, written in 2010, emphasize more significant role of statistics in recent future. The research on pre-service and in-service teachers' statistical attitudes is still scarce, even though it was detected that these attitudes significantly effect on teacher's activities in mathematics classrooms (Jacobbe & Fernandes de Carvalho, 2011). Also, the research on statistical learning (e.g. Kesici, Baloğlu & Deniz, 2011) highlights that greater emphasis is placed on cognitive aspects and considerably less on attitudes and emotions. Therefore, we initiated a study where we investigated pre-service elementary teachers' attitudes towards statistics as well as their reasoning in measures of central tendency. The question is: are our future teachers ready to deal with upcoming changes?

## Theoretical background

### Attitudes

Various studies showed that attitudes significantly affect on teaching and learning. In this paper, we will use the term attitude in accordance with Philipp (2007), who described attitudes as manners of acting, feeling or thinking that show a person's disposition or opinion about any topic. Attitudes are relatively stable, resistant to change, and consist of a larger cognitive component and less emotional intensity than emotions. They develop as repeated positive or negative emotional responses and are automatized over time (Gal, Ginsburg & Schau, 1997). Studies that investigated teachers' attitudes dealt with three different themes: (a) measuring teachers' global attitudes towards statistics (Estrada, 2002; Estrada, Batanero, Fortuny, & Diaz, 2005; Chick & Pierce, 2008) and comparing these attitudes with those of undergraduate students in other fields (Onwuegbuzie, 2003); (b) focussing on a specific *role as continuing learners of statistics* (Lancaster, 2008) and (c) analyzing teachers' attitudes in relation to the teaching of statistics (Watson, 2001).

### Measures of central tendency: mean and median

*Statistical reasoning* denotes the way people reason with statistical ideas and make sense of statistical information. Statistical reasoning may involve connecting one concept to another (e.g., center and spread) or may combine ideas about data and chance. Statistical reasoning also means understanding and being able to explain statistical processes, and being able to interpret statistical results (Garfield, 2002). On the other hand, statistical reasoning can be viewed as the mental representations and connections that students have regarding statistical concepts.

Groth and Bergner (2006) investigated 46 pre-service elementary and middle school teachers' understanding of the mean, median and mode. Their report addressed responses to one question that asked teachers to explain how the statistical concepts of mean, median, and mode were different or similar. Using SOLO taxonomy, they identified pre-service teachers' knowledge belonging mostly to the multistructural/concrete symbolic level of thinking. Another challenge in developing understanding of measures of center is choosing the best measure of center from several alternatives. In study by Zawojewski & Shaughnessy (2000), results confirmed that students frequently make poor choices in selecting measures of center to describe data sets. When asked to choose between the mean and the median for describing sets of data, students predominantly chose the mean, even when outliers within the sets of data made the mean less indicative of center than the median. Jacobbe (2007) conducted a case study of three elementary school teachers' understanding of the average. The findings revealed that although some of the teachers had difficulty in applying the algorithm to various contexts, they were able to use the shape of a distribution (balancing) to determine when one data set would have a greater mean, median, and mode than another. Pfannkuch and Wild (2004) discuss how current methods of teaching have often focused on the development of skills and have failed to instill the ability to think statistically. Most instructors of statistics find that students have difficulty with statistical contents, especially with statistical reasoning while many of the concepts used in statistics are abstract in nature, unfamiliar, so reasoning about abstract content is difficult for many (delMas, 2004). The sources of abstraction could be found in mathematical content of statistics. Cobb and McClain (2004) emphasize five aspects of the classroom environment that proved to be critical in supporting the students' statistical learning: the focus on central statistical ideas, the instructional activities, the classroom activity structure, the computer-based tools the students used, and the classroom discourse.

## Research questions

Taking into account the importance of the previously mentioned, our research questions have arisen from above mentioned literature review. We formed following research questions: What are pre-service elementary teachers' attitudes toward statistics? What characterizes their statistical reasoning skills and competencies? The importance of this study is especially manifested in the fact that such study has not been conducted in Croatian educational context.

## Methodology

### Participants, context and procedure

The study was conducted individually, via computer. We used two instruments to collect quantitative data about students' attitudes toward statistics (Scale of Attitudes Towards Statistics, shortly EAEE) and their reasoning in basic statistical

concepts (Quantitative Reasoning Quotient, shortly QRQ). We asked students what their grades from previous mathematics courses were, and to estimate how many hours per week they spend on learning statistics. Participants were pre-service elementary teachers from the Faculty of Education, University of Osijek. 71 participants filled out EAEE questionnaire, while 51 filled QRQ questionnaire. Filling out the questionnaire was voluntary, so some students rejected filling the other questionnaire regarding it as difficult. However, we still possess enough data to obtain valid conclusions about pre-services' attitudes and reasoning in statistics.

Students were given instruments at the end of statistics course, in two lectures. The statistics course is a one semester course of a fifth year of study consisted of overall 30 hours of lectures and seminars. Statistics course is organized as a combination of traditional and modern approach (with a support of online learning management system Moodle). Although students had formal lectures where they were taught about statistical concepts and procedures, the exercises contained a variety of tasks, including explorations, investigations, problems, projects, and exercises, using technology.

## Instruments

Estrada (2002) proposed and developed a Scale of Attitudes Towards Statistics (EAEE), based on two scales which are the most commonly used in an international context: the Statistics Attitude Survey (SAS) developed by D.M. Roberts & E.W. Bilderback, and the Attitudes Towards Statistics Scale (ATS) developed by S. L. Wise. However, we adapted four items to relate more to our participant group (Items 7, 12, 15, 16). For instance, the original item 7 was "I have fun in classes in which I teach statistics", and our item was worded "I had fun in the course where I learned statistics". Instrument comprised of 23 statements, to which the respondents marked their level of agreement or disagreement on a five-point Likert type scale (from 1: strongly disagree, through 3: neither agree nor disagree, to 5: strongly agree). Of the 23 items, 13 were positively worded (Items 2, 4, 5, 7, 8, 10, 12, 13, 15, 16, 17, 21, 22) and 10 were negatively worded (Items 1, 3, 6, 9, 11, 14, 18, 19, 20, 23). For the 10 negatively worded items, the scale was reversed when the responses were analyzed, meaning that the pre-service teachers' attitudes towards statistics could be measured in terms of the total score for all of their answers. The minimum score was 23, and the maximum was 115, with a midpoint of 69. The items can be categorized into two categories: teaching and anthropological component (Table 1). Teaching category consists of three components: (a) affective: feelings about the object in question, (b) cognitive: refers to expressions of thoughts, conceptions and beliefs about the object attitude to, in this case, of statistics, and (c) behavioural: the person's inclination to act toward the attitude object in a particular way. Anthropological category consists of three components: (a) social: perception of the value of statistics in society, (b) educational: interest in learning and teaching statistics and (c) instrumental: perceptions of the use of statistics in other areas.

Table 1. EAEE items categories.

Teaching component	Anthropological component		
	Social	Educational	Instrumental
Affective	1, 11, 23	7, 12, 20	10, 13, 15
Cognitive	2, 18, 19	4, 6, 16	3, 21
Behavioral	9, 17	8, 14, 22	5

Sundre (2003) developed Quantitative Reasoning Quotient (QRQ) assessment method which is a revision of a Garfield's 20-item Statistical Reasoning Assessment that assessed 8 correct reasoning skills and 8 misconceptions. QRQ is comprised of items, where students were requested to indicate whether they agreed or disagreed with the reasoning. The instrument contains 40 multiple-choice items that assessed the 11 correct quantitative reasoning scales and 15 misconceptions and skills. The score means can be scaled to a range of 0-2 points for comparison purposes. In this study, we will address only those items that are assessing the correct interpretation of measures of central tendency and misconceptions involving averages.

## Results

### Scale of Attitudes Towards Statistics

The mean value (M) and standard deviation (SD) were computed for a positive scale (Table 2, see Appendix). That way all scores can be comparable. If the score is closer to five, this denotes stronger indication of a positive attitude toward statistics. Similarly, the scores closer to one indicate a negative attitude toward statistics. However, there are many items with the lower mean scores ( $< 2.5$ ). Those are 3, 5, 7, 8, 13, 16. The overall mean of the Scale of Attitudes Towards Statistics (EAEE) is 3.07.

According to a brief analysis of the respondents' mean scores according to the components of attitudes (Table 3), none of the components – teaching or anthropological, presented high ( $> 4.5$ ), or low mean score ( $< 2.5$ ). Nonetheless, a low mean score can be obtained by crossing behavioural component of teaching with instrumental anthropological component (2.18).

Table 3. Main descriptive results of EAEE categories.

Teaching component	Anthropological component			
	Social	Educational	Instrumental	Total
Affective	3.50	2.77	2.65	2.97
Cognitive	3.64	3.08	2.87	3.2
Behavioral	3.85	2.67	2.18	2.9
Total	3.66	3.08	2.57	

Looking at the grades, most students (61%) have an average grade of previously passed mathematical exams good (3) or enough (2) on a scale from 1 (failed) to 5 (excellent). Students have also assessed their weekly amount of time spent on learning statistics. Results have shown that most students learn statistics less than an hour per week (46.5% of students) and around a third (32.4%) of students learn statistics between one to three hours per week. Just a fifth of students (21.1%) is learning statistics more than three hours per week. These factors (students' previous mathematical grades and average weekly time learning of statistics) correlate to their attitudes toward statistics. Specifically, item *Statistics in the course was easy* significantly correlates to average students' score in previous mathematics courses (Spearman's correlation coefficient  $R = 0.364077$ ). Also items *I usually explained statistics problems to my colleague* ( $R = 0.264181$ ), *When I read, I avoid statistical information* ( $R = 0.245659$ ) correlate to average students' score in previous mathematics courses. Further, item *Statistics helps people to make better decisions* correlates to students average weekly time of learning statistics ( $R = 0.282676$ ).

### QRQ questionnaire

Analysis of proportions of correct and incorrect answers to questions related to measures of central tendency is shown as follows.

*Question 1.* Nine students in a science class separately weighed a small object on the same scale. The weights (in grams) recorded by each student are shown below.

6.2 6.0 6.0 15.3 6.1 6.3 6.2 6.329 6.2

The students want to determine as accurately as they can the actual weight of this object. Of the following methods, which would you recommend they use?

Table 4. QRQ questionnaire – Question 1 results.

Answers:	N	%
a. Use the most common number, which is 6.2.	9	18
b. Use the 6.329 since it includes more decimal places.	2	4
c. Add up the 9 numbers and divide by 9.	24	47
d. Throw out the 15.3, add up the other 8 numbers and divide by 8.	16	31

In Question 1 (Table 4), 31% of pre-service elementary teachers understood how to select appropriate average, while 65% (a & c) showed misconceptions involving averages. Only 4% (b) assumed that more decimal places indicate greater accuracy.

*Question 2.* The following message is printed on a bottle of prescription medication: **WARNING:** For application to skin areas there is a 15% chance of developing a rash. If a rash develops, consult your physician.



Table 5. QRQ questionnaire – Question 2 results.

Which of the following is the best interpretation of this warning?	N	%
a. Don't use the medication on your skin – there's a good chance of developing a rash.	2	4
b. For application to the skin, apply only 15% of the recommended dose.	0	0
c. If a rash develops, it will probably involve only 15% of the skin.	2	4
d. About 15 of 100 people who use this medication develop a rash.	45	88
e. There is hardly a chance of getting a rash using this medication.	2	4

In Question 2 (Table 5), 88% of pre-service teachers correctly interpreted measures of central tendency, while the smaller part (a & c & e) was not able to interpret probability.

*Question 3.* The Meteorological and Hydrological Service wanted to determine the accuracy of their weather forecasts. They searched their records for those days when forecasts had reported a 70% chance of rain. They compared their forecasts to records of whether or not it actually rained on those particular days. The forecast of 70% chance of rain can be considered very accurate if it rained on:

Table 6. QRQ questionnaire – Question 3 results.

Answers:	N	%
a. 95% – 100% of those days.	12	24
b. 85% – 94% of those days.	9	18
c. 75% – 84% of those days.	0	0
d. 65% – 74% of those days.	30	58
e. 55% – 64% of those days	0	0

In *Question 3* (Table 6), 58% of pre-service teachers correctly interpreted probabilities, while 42% (a & b) showed outcome orientation misconception.

*Question 4.* A teacher wants to change the seating arrangement in her class in the hopes that it will increase the number of comments her students make. She first decides to see how many comments students make with the current seating arrangement. A record of the number of comments made by her 8 students during one class period is shown below.

Students initials								
Number of comments	AA	RF	AG	JG	CK	NK	JL	AW
	0	5	22	3	2	2	1	2

She wants to summarize this data by computing the typical number of comments made that day. Of the following methods, which would you recommend?

Table 7. QRQ questionnaire – Question 4 results.

Mark Y for the statements you agree with and N for the statements you disagree with	Yes	No
a. Use the most common number, which is 2.	18	33
b. Add up the 8 numbers and divide by 8.	34	17
c. Throw out the 22, and then add up the other 7 and divide by 7.	26	25
d. Throw out the 0, add up the other 7 numbers and divide by 7.	14	37

In Question 4 (Table 7), 52% (a & b) of pre-service teachers understood how to select appropriate average, while 39% (c & d) failed to distinguish between sample and population.

*Question 5.* The school committee of a small town wanted to determine the average number of children per household in their town. They divided the total number of children in the town by 50, the total number of households. Indicate which statements must be true if the average number of children per household is exactly 2.2.

Table 8. QRQ questionnaire – Question 5 results.

Mark Y for the statements you agree with and N for the statements you disagree with.	Yes	No
a. More households in the town have 3 children than have 2 children.	38 (75%)	<b>13 (25%)</b>
b. There are 110 children in the town.	<b>28 (55%)</b>	23 (45%)
c. There are 2.2 children in the town for every adult.	27 (53%)	<b>24 (47%)</b>
d. The most common number of children in a household is 2	42 (82%)	<b>9 (16%)</b>
e. More households in the town have 2 children than have 3 children.	38 (75%)	<b>13 (25%)</b>

In Question 5 (Table 8), the proportion of pre-service teachers who correctly interpreted measures of central tendency varied according to given statements between 16% and 55% (bold in the table).

The above results can be presented in the following way: we managed to assess three quantitative reasoning skills with given questions: understanding how to select appropriate average ( $M = 0.89$ ), correct interpretation of measures of central tendency ( $M = 1.03$ ) and correct interpretation of probabilities ( $M = 1.18$ ). Also, given question enabled us to assess three misconceptions: misconception involving average ( $M = 1.17$ ), orientation outcome misconception ( $M = 0.45$ ) and failure to distinguish the difference between a sample and a population ( $M = 0.78$ ).

## Discussion and conclusion

The study set out to determine the attitudes of pre-service mathematics teachers towards statistics as well as their reasoning in basic statistical concepts as mean and median.

As for the first goal in research, it can be concluded that students assess items related to statistics around 3 ( $M = 3.07$ ) what means that their attitude toward statistics is not pointed to a positive nor negative direction yet mostly in the middle, and can be denoted as neutral. The items students, mostly agree on are that through statistics, one can manipulate reality (59.2%), that statistics is fundamental to the basic training of future citizens (59.2%) and students also find it easier to understand the results of elections when they are shown using graphics (67.6%). On the other hand, students mostly do not solve day-to-day problems using statistics (57.7%), they do not agree that they should not teach statistics in schools (50.7%), they also do not agree they had fun in the course where they learned statistics (54.9%). Students do not find that statistical problems are easy (66.2%), they understand the statistical information that appears in the media (64.8%) and they do not like serious work that involves statistical analysis (54.9%). Students disagree that statistics in course was easy (56.3%), they also disagree with the facts that statistics does not require the use of technology (83%), statistics is only good for people in scientific areas (64.8%) and that statistics is worthless (62%).

If we thoroughly investigate the teaching category of attitude toward statistics, the lowest mean score achieved a behavioral component and slightly higher mean score achieved an affective component. However, both mean scores are around 3, what shows neutral, undetermined, not positive nor negative feelings about statistics as the object in question, or affinity to act toward statistics in a particular way, for instance, using it or meeting it in the real life situations. When it comes to pre-service teachers' perception of their knowledge skills or competence when applying statistics, they also showed neutral attitude, indicating they are not certain if they would be able to actually apply statistical concepts or not. Examining the anthropological category of attitude, we can see that the social component had the highest mean score among all anthropological components, indicating that pre-service teachers have moderate positive attitude toward perception of the use of statistics in a society. This means that they are aware that statistics is used, however the instrumental component had the lowest mean score, indicating that pre-service teachers do not know in which areas statistics is used or what one can meaningfully do with the statistics.

Estrada (2002) obtained similar results when she investigated the attitudes towards statistics in Spanish in-service and pre-service primary school teachers. Also, Lancaster (2008) detected that attitudes of prospective primary school teachers affected their willingness to participate in activities related to statistics in the future. In this light, how can we interpret our results? In their teaching experience which is an important part of their preparation program, pre-service teachers met mathematics curriculum which does not have any statistical concepts in primary

school mathematics (grades 1 to 4). Also, they, as school students, did not meet statistical concepts in primary and secondary school, but at the very end of their initial teacher education. Therefore, it seems that pre-service teachers lack awareness why this course is important and what future changes bring into their teaching.

Various studies in statistics education have shown that students, teachers and other people often fail to use the methods learned in statistics courses when they interpret or make decisions when statistical information are involved (Garfield, 2002). These results show that inappropriate reasoning about statistical ideas is widespread and persistent, almost the same regardless of a person's age and difficult to change. Considering the second goal of our research, to examine the reasoning in basic statistical concepts as mean and median, pre-service teachers showed that their statistical reasoning is inconsistent from item to item or topic to topic, depending on the context of the problem. This could be also connected with their experience with the context. For instance, in Question 2, most pre-service teachers interpreted correctly measures of central tendency, while in Question 5, this number significantly varied across all items. Similarly, when we compare proportions of students who understood how to select appropriate average, we see that this number significantly varies in Question 1 and Question 4.

Averages are regarded as the most common number (the value that occurs more often than the others), but students often believe that to find an average one should always add up all the numbers and divide by the number of data values, regardless of outliers (Garfield, 2002). And this could be seen among pre-service teachers' answers in Question 1, where 47% have chosen answers that corresponds to this misconception. On the other hand, a mean is frequently viewed as the same measure as a median, what was clearly visible among answers in Question 5, especially item d., where 82% of pre-service teachers have chosen wrong response.

In the case of the outcome orientation, it seems that quite many pre-service teachers made yes or no decisions about single events rather than looking at the series of events. For instance, in the Question 3 with a weather, forecaster predicts the chance of rain to be 70% for 10 days and to 42% of pre-service teachers, this means it should rain. This means that 42% of pre-service teachers have misconception regarding the outcome orientation, but it is comforting to realize that 58% was able to interpret the probability in the right way.

The studies have shown that attitudes towards statistics have a strong relation to achievements on statistics and that statistical reasoning abilities are more strongly tied to mathematics outcomes than to statistics outcomes (e.g. Onwuegbuzie, 2003). However, our results also detected correlation between previous mathematical achievements and attitudes toward statistics, showing that pre-service elementary teachers in our study, considered statistics as another mathematics course, not differing mathematics as a discipline of numbers from statistics as a discipline of numbers in context.

In order to ensure statistically literate students with minimal misconceptions, the statistics module should be 'carefully' designed at the university level as well

as in earlier education (Nikiforidou et al, 2010). Pre-service teachers need to be prepared to facilitate discussions with students around the expectations that promote statistical reasoning (Newton et al., 2011). Kesici, Baloğlu and Deniz (2011) indicate the importance of using cognitive and metacognitive learning strategies in relation to achieve more positive attitudes toward statistics. In other words, pre-service teachers need to develop and learn about their and future students' self-regulated learning skills which include metacognitive, motivational and behavioural regulation of learning. The role of such learning strategies is very important and can increase the likelihood of success and anxiety control. This can be a cause of statistics difficulties (Kesici, Baloğlu & Deniz, 2011), which are associated also with students and pre-service teachers' self-efficacy, emotions and approaches, and thus attitudes. Hence, teaching issues should be elaborated more profoundly by taking into account the synergy of content, pedagogy and technology (Moore, 1997). Blalock (1987, in Kesici, Baloğlu & Deniz, 2011) emphasizes dealing with students' attitudinal problems, like anxiety, as the first goal of statistics education. Another important goal for the start of learning statistics is matching (self-regulated learning) strategies to the material (Kesici, Baloğlu & Deniz, 2011). Some of them are deep-processing, planning and monitoring. In the end, we should consider the inclusion of all participants in the educational process, within mathematics curricula as well as outside the school – students, teachers, peers and other members of the social support like family.

Although the current statistics course combines direct teaching and exploratory learning, further research should help determine how instructional methods and materials may optimally be used to help pre-service elementary teachers to develop correct statistical reasoning. But besides developing statistical reasoning, it is important to influence on pre-service teachers' attitudes making them more positive. These attitudes are driving forces in mathematics classrooms, but also influence on latter students' achievements.

## **Limitations and future directions**

There are few limitations that needed to be mentioned. Since our study is partly based on participants' self-reports, we must be careful in our conclusions. Pre-service teachers' engagement in their own learning is only their estimation, so it might be only their tendency for ideal response, or miscalculation of their own learning process. Therefore, future research should devise a different approaches to verify the above. Furthermore, it should go in direction of cause-and-effect conclusions. Ultimately, future research should include not only our pre-service teachers as participants, but also sample with the possibility of better generalization of results.

## Appendix

Table 2. Descriptive statistics of positive scale of EAEE.

	Items	M	SD
1.	Some statistical information transmitted in television programs bothers me.	3.50	1.17
2.	Statistics helps me to understand today's world.	3.1	1.07
3.	Through statistics, one can manipulate reality.	2.40	1.24
4.	Statistics is fundamental to the basic training of future citizens.	3.52	1.05
5.	I solve day-to-day problems using statistics.	2.18	1.15
6.	We should not teach statistics in schools.	3.52	1.08
7.	I had fun in the course where I learned statistics.	2.48	1.26
8.	I find that statistical problems are easy.	2.04	0.98
9.	I do not understand the statistical information that appears in the media.	3.78	1.068
10.	I like statistics, because it helps me to fully understand the complexity of certain issues.	2.61	1.15
11.	I feel intimidated by statistical data.	3.51	1.22
12.	I find the world of statistics more interesting than other branches of mathematics.	2.65	1.47
13.	I like serious work that involves statistical analysis.	2.48	1.17
14.	When I attended statistics classes, I did not fully understand what was said.	2.78	1.25
15.	I like statistics because it helps me to view problems objectively.	2.85	1.13
16.	Statistics in course was easy.	2.21	1.04
17.	I find it easier to understand the results of elections when they are shown using graphics.	3.93	1.05
18.	Statistics is only good for people in scientific areas.	4.00	0.97
19.	Statistics is worthless.	3.83	1.11
20.	If I could eliminate some course from my study program, it would be statistics.	3.19	1.39
21.	Statistics helps people to make better decisions.	3.34	0.94
22.	I usually explained statistics problems to my colleagues if they did not understand.	3.20	1.33
23.	When I read, I avoid statistical information.	3.49	1.04

## References

- [1] CHICK, H. L., & PIERCE, R. U. (2008), *Teaching statistics at the primary school level: Beliefs, affordances, and pedagogical content knowledge*, In Batanero, C., Burrill, G., Reading, C., & Rossman, A. (Eds.), Paper presented in Joint ICMI /IASE Study Statistics Education in School Mathematics.
- [2] COBB, P., & MCCLAIN, K. (2004), *Principles of instructional design for supporting the development of students' statistical reasoning*, In D. Ben-Zvi & J. B. Garfield (Eds), *The Challenge of Developing Statistical Literacy, Reasoning and Thinking*, (pp. 375–396). Dordrecht, The Netherlands: Kluwer.

- [3] DELMAS, R. C. (2004), *A comparison of mathematical and statistical reasoning*, In D. Ben-Zvi & J. B. Garfield (Eds.), *The Challenge of Developing Statistical Literacy, Reasoning and Thinking*, (pp. 79–96), Dordrecht, The Netherlands, Kluwer.
- [4] ESTRADA, A. (2002), *Análisis de las actitudes y conocimientos estadísticos elementales en la formación del profesorado (Analysing attitudes and elementary statistical knowledge in the training of teachers)*. Unpublished Ph.D. dissertation, Spain: Universidad Autónoma de Barcelona.
- [5] ESTRADA, A., BATANERO, C., FORTUNY, J. M., & DIAZ, C. (2005), *A structural study of future teachers' attitudes towards statistics*, In Bosch, M. (Ed.), *Proceedings of the Fourth Congress of the European Society for Research in Mathematics Education* (pp. 508–517), Barcelona, Spain.
- [6] GAL, I., GINSBURG, L., & SCHAU, C. (1997), *Monitoring attitudes and beliefs in statistics education*, In Gal, I., & Garfield, J. B. (Eds.), *The assessment challenge in statistics education* (pp. 37–51), Voorburg, The Netherlands: IOS Press.
- [7] GARFIELD, J. (2002), *The challenge of developing statistical reasoning*, *Journal of Statistics Education*, 10 (3), <http://www.amstat.org/publications/jse/v10n3/garfield.html>
- [8] GLASNOVIĆ GRACIN, D., & VUKOVIĆ, P. (2010), *The Requirements in Statistics Education Comparison of PISA Mathematical Tasks and Tasks from the Mathematical Textbooks in the Field of Statistics*, *Teaching Mathematics and Computer Science*, 8 (2), 263–275.
- [9] GROTH, R. E., & BERGNER, J. A. (2006), *Preservice elementary teachers' conceptual and procedural knowledge of mean, median, and mode*, *Mathematical Thinking and Learning*, 8, 37–63.
- [10] JACOBBE, T. (2007), *Elementary school teachers' understanding of essential topics in statistics and the influence of assessment instruments and a reform curriculum upon their understanding*. [www.stat.auckland.ac.nz/~iase/publications](http://www.stat.auckland.ac.nz/~iase/publications) [Accessed 02/02/2015].
- [11] JACOBBE, T., & FERNANDES DE CARVALHO, C. (2011), *Teachers understanding of average*, In Batanero, C., Burrill, G., Reading, C., & Rossman, A. (Eds.), *Teaching Statistics in School Mathematics – Challenges for Teaching and Teacher Education*, New York, NY: Springer.
- [12] KESICI, Ş., BALOĞLU, M., & DENIZ, M. E. (2011), *Self-regulated learning strategies in relation with statistics anxiety*, *Learning and Individual Differences*, 21 (4), 472–477.
- [13] LANCASTER, S. (2008), *A study of preservice teachers' attitudes toward their role as students of statistics and implications for future professional development in statistics*, In Batanero, C., Burrill, G., Reading, C., & Rossman, A. (Eds.), *Paper presented in Joint ICMI /IASE Study Statistics Education in School Mathematics*.
- [14] MOORE, D. S. (1997), *New pedagogy and new content: The case of statistics*, *International Statistical Review*, 65, 123–165.
- [15] NEWTON, J., DIETIKER, L., & HORVATH, A. (2011), *Statistics Education in the United States: Statistical Reasoning and the Statistical Process*, In Batanero, C., Burrill, G., Reading, C., & Rossman, A. (Eds.), *Teaching Statistics in School Mathematics – Challenges for Teaching and Teacher Education*, New York, NY: Springer.
- [16] NIKIFORIDOU, Z., LEKKA, A., & PANGE, J. (2010), *Statistical literacy at university level: the current trends*, *Procedia Social and Behavioral Sciences*, 9, 795–799.

- [17] ONWUEGBUZIE, A. J. (2003), *Modelling statistics achievement among graduate students*, Educational and Psychological Measurement, 63, 1020–1038.
- [18] PFANNKUCH, M., & WILD, C. J. (2004), *Towards an Understanding of Statistical Thinking*, In D. Ben-Zvi & J. B. Garfield (Eds), *The Challenge of Developing Statistical Literacy, Reasoning and Thinking*, (pp. 17–46), Dordrecht, The Netherlands: Kluwer.
- [19] PHILIPP, R. A. (2007), *Mathematics teachers' beliefs and affects*, In Lester, F. (Ed.), *Second handbook of research on mathematics teaching and learning* (pp. 257–315), Charlotte, NC: Information Age Publishing and National Council of Teachers of Mathematics.
- [20] SUNDRE, D. L. (2003), *Assessment of quantitative reasoning to enhance educational quality*, Paper presented in A. O'Connell (Chair), *Assessment of Statistical Reasoning to Enhance Educational Quality*, a symposium conducted at the American Educational Research Association, Organized by D. L. Sundre: Chicago, IL.
- [21] WATSON, J. M. (2001), *Profiling teachers' competence and confidence to teach particular mathematics topics: The case of chance and data*, Journal of Mathematics Teacher Education, 4 (4), 305–337.
- [22] ZAWOJEWSKI, J. S., & SHAUGHNESSY, J. S. (2000), *Data and chance*, In Silver, E. A., & Kenney, P. A. (Eds.), *Results from the seventh mathematics assessment of the national assessment of educational progress* (pp. 235–268), Reston, VA: National Council of Teachers of Mathematics.

*Contact addresses:*

Ljerka Jukić Matić  
Department of Mathematics  
Josip Juraj Strossmayer University of Osijek  
Trg Lj. Gaja 6, HR-31000 Osijek, Croatia  
e-mail: ljukic@mathos.hr

Ana Mirković Moguš  
Faculty of Education  
Josip Juraj Strossmayer University of Osijek  
Cara Hadrijana 10, HR-31000 Osijek, Croatia  
e-mail: amirkovic@foozos.hr

Marija Kristek  
Department of Mathematics  
Josip Juraj Strossmayer University of Osijek  
Trg Lj. Gaja 6, HR-31000 Osijek, Croatia  
e-mail: mkristek@mathos.hr



## Budući učitelji i statistika: empirijska studija o stavovima i zaključivanju

---

---

Ljerka Jukić Matić<sup>1</sup>, Ana Mirković Moguš<sup>2</sup> i Marija Kristek<sup>1</sup>

<sup>1</sup>Odjel za matematiku, Sveučilište Josipa Jurja Strossmayera u Osijeku, Hrvatska

<sup>2</sup>Fakultet za odgojne i obrazovne znanosti, Sveučilište Josipa Jurja Strossmayera u Osijeku, Hrvatska

*Sažetak.* U ovom radu, razmatrat ćemo stavove budućih učitelja razredne nastave prema statistici, jer vjerujemo da ti stavovi imaju ključnu ulogu u procesu učenja i podučavanja. Stavovi su ispitivani pomoću Skale Stavova prema Statistici (*Scale of Attitudes Towards Statistics*), a analiza rezultata pokazala je da budući učitelji razredne nastave imaju neutralan stav prema statistici. Također, ispitali smo njihovo statističko zaključivanje, koristeći nekoliko stavki iz Testa o Kvocijentu Kvantitativnog Zaključivanja (*Quantitative Reasoning Quotient Test*). Ova analiza pokazala je da je statističko zaključivanje budućih učitelja razredne nastave nekonzistentno od stavke do stavke, odnosno od teme do teme, ovisno o kontekstu problema. Rezultati oba instrumenta procjene pokazuju da budući učitelji uglavnom nemaju svijest o korisnosti statistike u svakodnevnom životu s obzirom na to da im nedostaje iskustva u rješavanju svakodnevnih problema. Stavovi imaju značajan utjecaj na proces učenja, stoga vjerujemo da je na razvoj statističkog zaključivanja budućih učitelja razredne nastave utjecalo nepoznavanje mogućnosti primjene statistike.

*Ključne riječi:* stavovi, zaključivanje, budući učitelji, statistika, mjere centralne tendencije

# **Beliefs about mathematics and mathematics teaching of students in mathematics education programme at the Department of Mathematics, University of Zagreb**

---

---

Aleksandra Čizmešija and Željka Milin Šipuš

Department of Mathematics, Faculty of Science, University of Zagreb, Croatia

*Abstract.* TEDS-M (Teacher Education and Development Study in Mathematics) is an international comparative study of mathematics teacher education. It is concerned with the context, structure, and quality assurance of mathematics teacher education and was recently conducted in 17 countries. Motivated by this study and in order to compare the programme of mathematics teacher education at the Department of Mathematics, University of Zagreb, with the findings obtained in TEDS-M study, we have conducted a survey based on the (adapted) instrument of the TEDS-M. The survey was carried out in 2014 on the population of the fifth year mathematics education students. We have addressed the following two main topics: beliefs about mathematics and mathematics teaching, and opportunities to learn during the teacher education program. The questionnaire contained questions about students' beliefs on nature of mathematics, learning of mathematics, mathematics achievement, preparedness for teaching mathematics, program effectiveness and coherence, as well as on opportunities to learn school and university-level mathematics, mathematics didactics, general education, pedagogy and how to teach, and to gain school experience and field practice.

In this communication, we present our view on the actual mathematics teacher education program at the Department, some findings of our survey and their comparison with the results of the TEDS-M participating countries.

*Keywords:* mathematics teacher education, mathematical and pedagogical knowledge relevant to teaching, beliefs and perspectives on content and pedagogy, opportunities to learn, TEDS-M

## References

- [1] BLÖMEKE, S., HSIEH, F.-J., KAISER, G., SCHMIDT W. H. (Eds.) (2014), *International perspectives on Teachers Knowledge, Beliefs and Opportunities to Learn, TEDS-M Results*, Springer.
- [2] PHILIPP, R. A. (2007), *Mathematics teachers' beliefs and affect*, In F. K. Lester (Ed.), *Second handbook of research on mathematics teaching and learning* (pp. 257–315), Charlotte, NC: National Council of Teachers of Mathematics & Information Age Publishing.
- [3] STAUB, F. C., STERN, E. (2002), *The nature of teachers' pedagogical content beliefs matters for students' achievement gains: Quasi-experimental evidence from elementary mathematics*, *Journal of Educational Psychology*, 94(2), 344–355.
- [4] LESTER, F. K. (Ed.) (2007), *Second handbook of research on mathematics teaching and learning*, Charlotte, NC: National Council of Teachers of Mathematics & Information Age Publishing.

*Contact addresses:*

Aleksandra Čižmešija  
Department of Mathematics  
Faculty of Science  
University of Zagreb  
Bijenička 30, Zagreb, Croatia  
e-mail: cizmesij@math.hr

Željka Milin Šipuš  
Department of Mathematics  
Faculty of Science  
University of Zagreb  
Bijenička 30, Zagreb, Croatia  
e-mail: zeljka.milin-sipus@math.hr

## Stavovi o matematici i poučavanju matematike studenata nastavničkog smjera diplomskog studija matematike na Matematičkom odsjeku Sveučilišta u Zagrebu

---

---

Aleksandra Čizmešija i Željka Milin Šipuš

Prirodoslovno-matematički fakultet, Matematički odsjek Sveučilišta u Zagrebu, Hrvatska

*Sažetak.* TEDS-M (Teacher Education and Development Study in Mathematics) je međunarodna komparativna studija sveučilišnog inicijalnog obrazovanja učitelja matematike. Istražuje kontekst, strukturu i osiguranje kvalitete obrazovanja učitelja matematike i nedavno je provedena u 17 zemalja. Potaknuti tim istraživanjem, te kako bismo usporedili karakteristike sveučilišnog programa obrazovanja nastavnika matematike na Matematičkom odsjeku Prirodoslovno-matematičkog fakulteta Sveučilišta u Zagrebu s rezultatima dobivenim u TEDS-M studiji, proveli smo istraživanje na temelju (prilagođenog) instrumenta navedene studije. Istraživanje je provedeno 2014. godine i uključilo je sve studente pete godine nastavničkog studija matematike. Poseban naglasak stavljen je na dvije teme: uvjerenja o matematici i poučavanju matematike te mogućnosti učenja za vrijeme sveučilišnog obrazovanja. Instrument stoga sadrži pitanja o uvjerenjima studenata o prirodi matematike, učenju matematike, matematičkim postignućima, spremnosti za poučavanje matematike, o učinkovitosti i usklađenosti sveučilišnog programa, kao i o mogućnostima za učenje školske i visokoškolske matematike, metodike matematike, odgojno-obrazovnih znanosti, odnosno vještina poučavanja, te o iskustvu rada u školi i metodičkoj praksi.

Na osnovi dobivenih rezultata i njihove usporedbe s rezultatima zemalja koje su sudjelovale u TEDS-M studiji, u ovom ćemo predavanju iznijeti svoj osvrt na postojeći program obrazovanja učitelja i nastavnika matematike na Matematičkom odsjeku.

*Ključne riječi:* obrazovanja učitelja i nastavnika matematike, matematičko i pedagoško znanje relevantno za poučavanje, stavovi i pogledi na sadržaj i pedagogiju, mogućnosti za učenje, TEDS-M

## Self-reported creativity of primary school teachers and students of teacher studies in diverse domains, and implications of creativity relationships to teaching mathematics in the primary school

---

---

Željko Rački\*, Ana Katalenić and Željko Gregorović

Faculty of Education, Josip Juraj Strossmayer University of Osijek, Croatia

*Abstract.* Primary school teachers' and students' of teacher studies self-reported creativity in diverse domains and relationships of domain-specific creativity to self-ratings of the creativity in teaching mathematics, language, physical education, visual arts, music, and science, were explored in this study. Teachers in primary schools ( $N = 105$ ) and students of teacher studies ( $N = 111$ ) were the study participants (sample age ranged 21–64 years;  $M = 31.2$ ,  $SD = 11.6$ ; 95.4% women). Sixty-two lesson plans for teaching mathematics in grades 1–4 written by students of teacher studies, were analyzed regarding their contents (i.e. chosen activities that map onto different creativity domains). The results show that when the students of teacher studies rated themselves as generally creative, they also rated themselves as creative to a different degree, for example, the area that had the lowest and not significant correlation with general creativity ratings was mathematics. This internally experienced subjective structure of creativity in students, as well as the meaning of being creative (excluding mathematics), may have implications in teaching mathematics in primary school, such as the choice of activities during mathematics lessons. Age- and expertise-related differences between teachers and students of teacher studies were found as well, bringing up numerous questions on (creative) teaching of mathematics and its relationship to teaching excellence and student outcomes.

*Keywords:* mathematics teaching, creativity domains, implicit theories, lesson preparations, art bias

---

\*Corresponding author.

## Introduction

Research on creativity of primary school teachers and students of teacher studies creativity in diverse domains, with implications of creativity relationships for teaching in general in primary schools, and specifically for teaching mathematics as one of the school subjects, is currently lacking. What is considered creative, both in teachers and in pupils, may be influenced by the implicit theories on creativity that teachers share. These shared implicit theories on creativity could have profound consequences for educational work performed for and with children, resulting in equal or biased education.

The operationalization of the construct of creativity in general, and creativity in teaching, are both under the influence of the developing body of knowledge on the interplay of personal creativity and how creativity is used, developed or extinguished in the social context, as in this case, in the primary school. Implicit theories act as prototypes against which behavior is compared, and they may be involved whenever an individual makes a decision about his or her behavior or the behavior of others (Runco, 1990, p. 235). Relationships of implicit theories of creativity and intelligence (Sternberg, 1985), implicit creativity domains (Runco, 1999; Runco & Bahleda, 1987), and similarities of implicit theories across cultures (Chan & Chan, 1999; Ramos & Puccio, 2014), provide insight into what is considered creative. What is considered creative in children is of highest importance because of the *Pigmalion* effect, in other words teachers' beliefs may also have influence on children's creativity (e.g., Beghetto, 2008; Saracho, 2012). Overall, what is generally considered creative, and how does one define creativity, creative teaching and teaching creativity?

Creativity is usually defined as the ability to generate an idea or a product that is original, valuable (Sternberg, 1996), and useful (Csikszentmihalyi, 1988) in a given social context (Amabile, 1982), as a result of the combined effects of personality, social, cultural, motivational factors and ecological conditions, including chance (Amabile, 1982; Csikszentmihalyi, 1988; Simonton, 2000; Sternberg & Lubart, 1991). Research has shown that creativity is partially domain-specific (Baer, 1998; Conti et al., 1996; Diakidoy & Spanoudis, 2002; Han, 2003; Ivčević, 2005; James & Asmus, 2000–2001; Milgram & Livne, 2005; Plucker, 1999; Runco & Bahleda, 1986; Silvia et al., 2009; Simonton, 2003), and that it can be divided into three broad but not completely distinct domains, called: (a) everyday, (b) scientific, and (c) artistic creativity (Andrews, 1965; Carson et al., 2005; Eiduson, 1958; Feist, 1999, 1998; Guastello & Schissler, 1994; Hu & Adey, 2002; Ivcevic, 2007; Lloyd, 1979; Milgram, 2003; Richards, 1993; Richards et al., 1988; Roy, 1996; Runco & Bahleda, 1986; Simonton, 2003; Stumpf, 1995; Wai et al., 2005). According to Kaufmann & Baer (2004), even those who argue for the existence of domain-transcending, all-purpose creative thinking skills recognize that people's creativity varies across domains. Representing those who support this theory, Root-Bernstein & Root-Bernstein (2004, 2006) suggests that, learning how to manipulate the creative process in one discipline appears to train the mind to understand the creative process in any discipline. They provide evidence that the most creative scientists not only have the psychological profiles of artists, but more often than not, are artists.

A teacher's creativity lies not in performing as an artist, musician, inventor or researcher but in creating learning environments that foster curiosity, bold ideas, risk taking, interaction and independence of thought, also recognizing, encouraging and evaluating each individual's progression and creativity (Nadjafikhah et al., 2012; Baer, 2013). If teaching is nevertheless considered an art form, or is associated with creativity, according to Lilly & Bramwell-Rejskind (2004), and if in primary schools in Croatia, the number of women working full-time as basic school teachers has increased steadily, from 78.9% in school-year 2000/01, to 85.1% in school-year 2011/12 (*Women and Men in Croatia 2014*, Croatian Bureau of Statistics), and if women on average in comparison to men display a somewhat different set of abilities (Hyde & Linn, 1988; Lubinski, 2004), traits (Byrnes et al., 1999; Feingold, 1994), knowledge and skills (Voyer & Voyer, 2014), and interests (Su et al., 2009), it would make sense to learn more about this relationship of creativity and (*art of*) teaching in women. For instance, Kaufman & Baer (2004) found that the university students', most of whom were young women studying to become elementary school teachers, implicit theories on creativity were closely aligned to being creative in arts and crafts, slightly less associated with being creative in communication, and very little related to being creative *in math or science*. This "Art Bias" (e.g., Glăveanu, 2014), refers to closer links between creativity and artistic activities in lay people's conceptions of what constitutes creativity. But, students of teacher studies and teachers are not lay people – they are developing and practicing experts, daily involved in the creation and performance of individual teaching acts.

Theory discerns creative teaching and teaching creativity. The former means that the teacher is choosing and implementing different, innovative, imaginative approaches to make learning more attractive and efficient (Baer, 2013). Teaching creativity means that students are educated to value and develop their creative competencies; also, creative teaching has positive impact on overall learning processes, hence encourages students' creativity (Baer, 2013). Bolden et al. (2009) question how pre-service teachers experience and interpret creativity in mathematics teaching. The participants stated general ideas about creativity and perceptions of creative endeavors during a mathematics lesson. Their conceptions were organized in two large categories: creative teaching and creative learning, each with two subcategories. Pre-service teachers recognize creative behavior in mathematics lessons more from the aspect of teaching than learning and find teachers creative when using resources or establishing connection of mathematics to the real context (Bolden et al., 2009). Such teaching strategies are considered valuable for motivating and amusing pupils rather than exploiting resources or examples to gain mathematical insight (Bolden et al., 2009).

The goal of the present research is to take a closer look at the relationship between creativity and teaching. Self-assessments of creativity in primary school teachers and students of teacher studies were explored for creativity inter-correlations to see what insights they can provide regarding how domain-specific creativities relate to one another in educational generalists, i.e., teachers in primary schools who teach both artistic and scientific subjects (e.g., mathematics, visual arts, music, language). In particular, relationships between creativity self-assessments in creativity domains and prepared lesson activities were examined, with the focus on teaching one specific school subject, and that is mathematics.

## Study 1

### Method

### Participants

The study participants have been primary school teachers (group A;  $N = 105$ ), and students of teacher studies ( $N = 111$ ; in their fourth and fifth year of study out of five, 76% and 24%, respectively). Sample age ranged 21–64 years ( $M = 31.2$ ,  $SD = 11.6$ ). Women formed the sample majority (95.4%;  $N = 206$ ), with only ten men (4.6%) in this sample, in line with the Croatian state statistics on women and men as teachers, as well as the students of teacher studies. Mean age for teachers was 40.8 (age range 24–64 years;  $SD = 10.04$ ), and for students the mean age was 22.3 years (age range 21–26 years;  $SD = 0.75$ ). The teachers were approached during in-service training meeting, and students of teacher studies in Osijek and Slavonski Brod after their lectures. Anonymous and voluntary participation was followed by debriefing and answers on research questions posed by the participants.

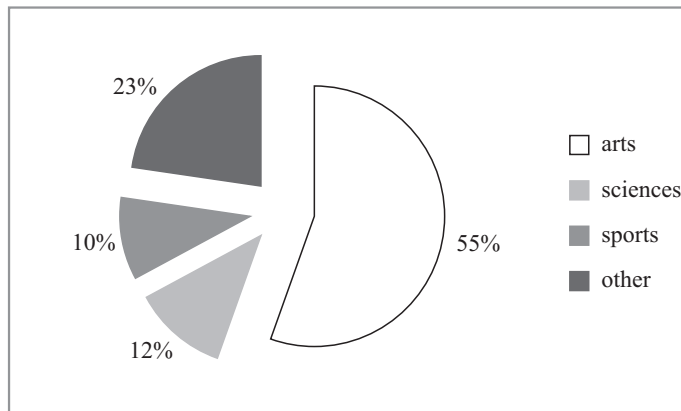

Figure 1. Types of extracurricular activities offered free of charge to children at primary schools in the current school year, based on teachers' reports.

An additional sample of 80 primary school teachers (group B) of advanced vocational status (mentors and advisors) in the eastern region of Croatia were contacted by e-mail and asked to participate in an anonymous online survey, with 60 of them filling the survey in, due to the fact that part of the teachers worked at the same school. They were asked to group extracurricular activities (EA), that the schools they worked in provided for children in the current school year, in four domains: arts, sciences, sports, and other. EA's are considered and used as creativity outlet. Out of 873 listed extracurricular activities offered free of charge to children in grades 1–4 in their schools, based on the teachers' reports, 484 belonged to the arts (e.g., drama, literary, music, design etc.), 102 to sciences (e.g., mathematics, computer science, robotics, inventions/modeling etc.), 89 to sports, and by teachers unclassified "other" numbered 198 activities. These numbers differed,  $\chi^2(3, N = 873) = 463.93$ ,  $p = .001$ , with twice as many extracurricular activities



belonging to arts than what would have been expected if all categories were equal. The provision of extracurricular activities to children in the sampled schools, when number and type of activity is taken into account, is currently biased towards the domain of arts. These differences are shown in Figure 1.

### Instruments and procedures

The teachers (group A) and the students were asked to anonymously and voluntarily rate their own creativity on the 1–5 scale, from 1 (“low”) to 5 (“high”), in the following activity types: play and play-like activities, drawing/painting, modeling/sculpting, mathematics, research, inventions/modeling, computer science, robotics, singing/playing music, dance, acting/puppetry, writing, design/fashion, physical education/sports, photography, cooking, and humor (i.e., *personal creativity*). In addition to this, the students were asked to rate their own general creativity. Because all participants, students and teachers, had teaching experience, either through study (and/or volunteer extra-study work in schools) or employment, they were also asked to rate their own general creativity *in teaching* of the following subjects: Croatian language, visual arts, music, mathematics, nature and society, physical education (i.e., *creativity in teaching*). In this way, self-assessments of personal creativity (17 activity types), self-assessment of general creativity in teaching, and self-assessments of creativity in teaching six separate subjects, were available for each study participant.

### Results

Descriptive statistics for all measures, listed according to their descending means, are shown in Table 1. With principal component analysis (PCA) applied to all 17 personal creativity indicators, five components were extracted with eigenvalues 4.17, 2.12, 1.57, 1.21 and 1.06. With PCA and varimax rotation, two interpretable components were retained, explaining 37.0% of the common variance. The congruence coefficients in two subsamples, students and teachers, for these two components were +.82 and +.80. These independent, extracted factor scores, shown in Table 2, were correlated with self-assessments in creativity in teaching (Table 3), and were named, according to their contents: I) Scientific (Sciences; in literature also named intellectual, mathematical, or technical), and II) Artistic (Arts; in literature also termed emotional, expressive or performing) creativity domain.

Mean age difference was significant, Mann-Whitney  $U = 8.50, p = .000$ , with teachers being on average 18.6 years older than the students of the teacher studies. This roughly rounds the difference in the teaching experience of students and teachers into teaching of five pupil generations [(grades 1–4)  $\times$  5]. Nevertheless, there is no difference between the teachers’ ( $M = 4.09, SD = 0.54$ ) and the students’ self-assessments of general creativity in teaching ( $M = 4.10, SD = 0.59$ ), regardless of age or experience. But, when we take a look at the individual school subjects, teachers ( $M = 4.14, SD = 0.68$ ) in comparison to students ( $M = 3.66, SD = 0.90$ ) had higher values for creativity in teaching mathematics,  $U = 4093.0, z = -4.13, p = .000$ . This means that teachers either, through experience that students currently lack, learn how to teach mathematics more creatively, or they may

be averaging all self-assessments into one global positive image. Table 3 presents correlations between the self-assessments of creativity in two domains (Scientific and Artistic creativity) with creativity in teaching different subjects.

Table 1. Descriptive statistics and correlations for self-assessments of personal and creativity in teaching.

Creative activity type	N	Possible range	Observed range	M	SD	General creativity $r_s(111)$	General creativity in teaching $r_s(216)$
<b>Personal creativity</b>							
Humor	216	1–5	1–5	3.88	0.89	.41**	.22**
Dance	216	1–5	1–5	3.87	1.02	.23*	.14*
Drama/acting/puppetry	216	1–5	1–5	3.84	0.98	.34**	.23**
Cooking/culinary	216	1–5	1–5	3.80	1.07	.21*	.26**
Physical/sports	216	1–5	1–5	3.80	1.02	.33**	.21**
Play/play-like/games	216	1–5	2–5	3.80	0.66	.46**	.35**
Music	216	1–5	1–5	3.78	1.00	.16	.20**
Writing	216	1–5	1–5	3.72	0.98	.28**	.17*
Mathematics	216	1–5	1–5	3.48	0.99	.06	.09
Photography	216	1–5	1–5	3.40	1.11	.51**	.36**
Drawing/painting	216	1–5	1–5	3.37	1.07	.29**	.19**
Design	216	1–5	1–5	3.32	1.17	.45**	.29**
Research	216	1–5	1–5	3.31	0.91	.27**	.23**
Informatics	216	1–5	1–5	3.25	1.03	.25**	.22**
Modeling/sculpting	216	1–5	1–5	3.07	1.01	.33**	.24**
Inventions/modeling	216	1–5	1–5	2.63	1.00	.25**	.27**
Robotics	216	1–5	1–4	1.75	0.89	.16	.24**
General creativity (only students)	111	1–5	1–5	3.80	0.71	–	.49**
<b>Creativity in teaching</b>							
Nature and society	216	1–5	3–5	4.28	0.63	.34**	.41**
Language	216	1–5	1–5	4.11	0.69	.40**	.38**
Music	216	1–5	2–5	4.05	0.80	.29**	.35**
Visual arts	216	1–5	2–5	4.05	0.78	.39**	.27**
Physical education	216	1–5	1–5	3.97	0.88	.38**	.31**
Mathematics	216	1–5	1–5	3.89	0.84	.15	.29**
General creativity in teaching	216	1–5	3–5	4.09	0.56	.49**	–

Note. \*\* $p < .01$ . \* $p < .05$ . Spearman's rho.

Table 2. Varimax rotated factors based on a principal components analysis for self-assessed creativity.

Creative activity type	Creativity domains	
	I	II
<b>Personal creativity</b>		
Inventions/modeling	<b>.80</b>	.09
Research	<b>.74</b>	-.05
Robotics	<b>.67</b>	.17
Computer science	<b>.63</b>	.05
Mathematics	<b>.63</b>	-.12
Modeling/sculpting	<b>.45</b>	.37
Physical activities/sports	.38	.16
Play/play-like/games	.36	.29
Drama/acting/puppetry	.04	<b>.76</b>
Dance	-.13	<b>.64</b>
Design	.21	<b>.64</b>
Music	-.08	<b>.58</b>
Literary	.10	<b>.57</b>
Photography	<b>.42</b>	<b>.45</b>
Drawing/painting	.25	.38
Humor	.27	.36
Cooking/culinary	.30	.31
<i>Eigenvalue</i>	3.34	2.95
<i>% of total variance</i>	19.62	17.38

Note. Loadings  $\geq .40$  are printed in bold.

In general, personal creativity domains, Sciences and Arts, mapped onto self-assessed creativity in teaching the corresponding school subjects. The Sciences factor correlated more strongly with creativity in teaching mathematics, nature and society, and physical education. The Arts factor correlated more strongly with the self-assessed creativity in teaching visual arts, music, and language. Additionally, as can be observed in Table 3, for students Arts (factor II) correlated somewhat more strongly with the self-assessments of both the general personal creativity,  $r_s(111) = .47, p = .00$ , and general creativity in teaching,  $r_s(111) = .43, p = .00$ , in comparison to Sciences,  $r_s(111) = .36, p = .00$ , and  $r_s(111) = .37, p = .00$ . For teachers it was the opposite; their self-assessments of general creativity in teaching correlated more strongly with the Sciences,  $r_s(105) = .35, p = .00$ , than with Arts,  $r_s(105) = .26, p = .00$ . Of importance is the finding that creativity in teaching mathematics correlated only with domain of Sciences, both for teachers and for students,  $r_s(105) = .40, p = .00$ , and  $r_s(111) = .39, p = .00$ , speaking for divergent validity and usefulness of the personal creativity domains in predicting domain specific creative behavior or teaching different school subjects, regardless of age and the teaching experience.

Table 3. Correlations between two factor scores for self-reports of personal creativity and creativity in teaching different subjects for subsamples of teachers and students of teacher studies.

	Creativity domains			
	I		II	
	Teachers	Students	Teachers	Students
<b>Creativity in teaching</b>				
Nature and society	.31**	.30**	.22*	.23*
Language	.28**	.15	.28**	<b>.40**</b>
Music	.13	.05	<b>.53**</b>	<b>.44**</b>
Visual arts	.15	.00	<b>.52**</b>	<b>.45**</b>
Physical education	<b>.45**</b>	.27**	.00	.23*
Mathematics	<b>.40**</b>	.39**	-.07	-.08
General creativity in teaching	.35**	.37**	.26**	<b>.43**</b>
General creativity (only students)	–	.36**	–	<b>.47**</b>

Note. Factor one corresponds to the domain of the Sciences, and factor two to the Arts. Spearman's rho. Correlations  $\geq .40$  are printed in bold.

In more detail, regarding creativity in teaching mathematics, the personal creative activity types that are most strongly correlated with it, include: personal creativity in mathematics [ $r_s(216) = .62, p = .00$ ], research [ $r_s(216) = .32, p = .00$ ], invention/modeling [ $r_s(216) = .27, p = .00$ ], computer science [ $r_s(216) = .20, p = .00$ ], play/games [ $r_s(216) = .18, p = .00$ ], and physical and creativity in sports [ $r_s(216) = .15, p = .026$ ], and *no* activity types from the Arts factor, implying lack of cross-domain transfer of domain relevant creativity skills.

When combined into single measures [Sciences=(invention/modeling, research, robotics, computer science, mathematics, modeling/sculpting, physical activities/sports, play/play-like/games)/8], [Arts=(drama/acting/puppetry, dance, design, music, writing, photography, drawing/painting, humor, cooking/culinary)/9], general personal creativity in students more strongly corresponded to the creativity in Arts,  $r_s(111) = .52, p = .00$ , than to that in Sciences,  $r_s(111) = .43, p = .00$ . General creativity in teaching, in students, was displayed in the same order; for Arts it was  $r_s(111) = .51, p = .00$ , and for Sciences,  $r_s(111) = .40, p = .00$ . For teachers, general creativity in teaching correlated similarly with Sciences,  $r_s(105) = .39, p = .00$ , as with Arts,  $r_s(105) = .33, p = .00$ . Both the students' and the teachers' self-assessments of personal creativity were overall higher for Arts ( $M = 3.66, SD = 0.58$ ), than for Sciences ( $M = 2.73, SD = 0.50$ ), with paired samples  $t(216) = -23.27, p = .00$ .

Additionally, based on the  $z$ -transformed Arts and Sciences variables, and  $K$ -means cluster analysis, four interpretable clusters of participants were identified, with 62, 62, 56 and 36 participants respectively, with students and teachers equally represented, in groups highS-highA, highS-lowA, lowS-highA, and lowS-lowA,

and compared on their self-assessed creativity in teaching mathematics. Mean values were, in the same group order:  $M = 4.15$ ,  $SD = 0.72$ ;  $M = 4.10$ ,  $SD = 0.62$ ;  $M = 3.66$ ,  $SD = 0.66$ ;  $M = 3.47$ ,  $SD = 1.05$ ; with mean ranks significantly different, based on Kruskal-Wallis' test,  $\chi^2(3, N = 216) = 19.72$ ,  $p = .00$ . Based on the follow-up Mann-Whitney  $U$  tests with Holm's sequential Bonferroni approach, the first two groups and the last two groups were equal in themselves, but differed significantly across, favoring the highS-highA and highS-lowA as participants with the highest self-assessments in creativity in teaching mathematics (124 participants; 55% teachers). Of course, those in the highS-highA and highS-lowA groups, in comparison to the rest, assessed themselves more creative in teaching all other school subjects except visual arts, reflecting generally higher self-assessments in teaching creatively.

## Discussion

The currently unbalanced provision of extracurricular activities in primary schools is in line with the self-assessed higher creativity in artistic activities both among the teachers and the students of teacher studies, moderate loadings of creativity in teaching mathematics on the Sciences factor of personal creativity coupled with the negative loadings on the Arts factor, and the lack of a significant correlation between general personal creativity and creativity in mathematical activities and teaching mathematics in students together point to the fact that the current and future educational staff are anchored more firmly in the particular artistic activities, and the Arts domain in general. This, in itself, is very positive on its own for the development of arts, but also points to the asymmetry of both offered activities and ascribed creative involvement and comparative creativity in teaching sciences, mathematics included. The students' self-reported general creativity had the lowest correlation *of all* with the self-reported personal creativity in mathematics (.06). In general, students and teachers judged themselves to be more personally creative in arts, and students judged themselves to be more creative in teaching all subjects *other than* mathematics. The positive trend for mathematics seems to be barely perceptible, for, in line with the acquired teaching expertise, the teachers' self-assessments ( $M = 4.14$ ,  $SD = 0.68$ ) in comparison to the students' ( $M = 3.66$ ,  $SD = 0.90$ ) differed more favorably towards creativity in teaching mathematics. In conclusion, these results help to better understand the implicit structure of creativity and how it changes, and add to our understanding of what general personal creativity means to students of teacher studies, and that does not include mathematics. The existing research corroborates the finding that mathematics is perceived as not creative (e.g., Bolden et al., 2009; Kaufman & Baer, 2004).

Study 2 aims to clarify what types of activities are offered during mathematics lessons in order to achieve the lesson's goals, as well as to explore whether there is any regularity in the choice of activities offered during mathematics lessons in line with the findings from Study 1 on personal creativity and creativity in teaching.

## Study 2

### Method

#### Instruments and procedures

Lesson plans for teaching mathematics, done by the students of teacher studies in academic years 2013/14, and 2014/15, were analyzed for their contents. Students were instructed to prepare their lesson in mathematics as a part of their regular study, so they were inclined to produce quality lessons in order to receive a higher grade. Each lesson had to consist of three parts: the introduction, the main part, and the conclusion, altogether lasting 45 minutes. Three university professors independently read through 62 students' of teacher studies lesson preparations for teaching mathematics in grades 1, 2, and 3 (around 10 pages per lesson preparation) identifying (marking) 459 individual teaching activities that the students proposed and prepared. The teaching activities were defined as individually discernible tasks singled out by displaying their goal and used during a single lesson, for example, the task of forming different line shapes using a ball of yarn, or reading a short story on *Number 2*. Activities that some students prepared consisted of a sequence of mathematical tasks, irrespective of three lesson parts (a student-teacher prepares a lesson in which she/he demonstrates and then pupils work out the mathematical task on the blackboard in front of the class, or in their notebooks). Other students prepared mathematics teaching activities making use of different domains for teaching mathematics, such as drawing, playing, and physical activities, or through the use of humor, aimed at mathematics' lesson goal achievement, varying in domain usage according to the lesson parts. In this way, the focus of Study 2 was to elaborate and provide support to the self-assessments of students, the future teachers, on creativity, through provision of data on students' actual use of the contents from the domains other than mathematics in teaching mathematics. The activities in mathematics' lessons were coded as involving only mathematics or play and play-like activities, drawing/painting, modeling/sculpting, research, inventions/modeling, computer science, robotics, singing/playing music, dance, acting/puppetry, writing/literary/storytelling, design/fashion, physical education/sports, photography, cooking, and humor. Inter-raters' agreements on activity nominations were calculated using the Fleiss' kappa, averaging for 3 raters and 459 activities, in 1377 decisions in total, at  $\kappa = .94$ , and pairwise average agreement of 97.4%. The remaining disagreements were resolved through later discussion and consensual agreement.

Besides the type of activities used during a mathematics lesson, available information on students' lessons included three additional variables: the grade for which the lesson was prepared, the number and type of activities in each of the three lesson parts, and the total number of activities used in the entire lesson.

## Results and discussion

In 62 lesson plans, with 459 activities, 122 were performed in the introductory part, 234 in the main part, and 103 in the concluding part. Almost seventy percent (69.7%) were mathematical activities without content from other domains, for example, demonstrating procedures, repetition of already covered content, or solving various tasks. When mathematical activities were saturated with other content, physical activities/sports were chosen most often (12.2%), followed by play-like/games (9.4%), drawing/painting (3.7%), and literary activities (2.6%), as listed in Table 4. When findings from Study 1 are taken into account, students seem to have used, in their lesson preparations and teaching performance, personal creative activity types that are most strongly correlated with their own belief what constitutes creativity in teaching mathematics, but in line with their inclination towards the arts, and that is the use of physical activities and play (see Tables 1 and 2). No activities were chosen coming from other STEM disciplines, which are thematically more strongly tied to mathematics (e.g., computer science, robotics, engineering, research). These activity types can be used to practically and visually demonstrate mathematical concepts. With inherent beauty in their presentation (e.g., use of spiroterals applications; as an example of addition, step size change, and orientation), they can satisfy pupils' aesthetic needs as well, as those artistically oriented could find them appealing. Their non-existence can be partly explained through comparatively lower self-assessed personal creativity in these STEM activity types among participants of the study. It may seem as if students chose physical activities and play in teaching mathematics according to their self-assessed personal creativity in these activity types, and the finding that these types are general enough to be adapted and applied to mathematics. Other activities that may be included, like puppetry or singing, may seem too artistic to students, or are judged as not appropriate within a mathematics lesson, and are therefore used less frequently. Following this line of reasoning, in need of further research, it may be that the poor mathematics teaching may actually reflect general asymmetry and mismatch between students' domain specific knowledge, preferences or personal strengths, such as Arts, and mathematics' teaching requirements (i.e., Sciences).

Figure 2 depicts the summary of usage of different activity types in three lesson parts (introduction, main part, conclusion). The group "other" includes drawing/painting, literary, drama/acting/puppetry, modeling/sculpting, music, and the use of humor in teaching mathematics, namely the *artistic* activities. The activity types represented point to stability of proportion of use of number of individual games and physical activities/sports, mostly in the concluding lesson part in all grades. The percentage of mathematical activities without contents from other domains, in grades 1, 2, and 3, increases, with 66.85, 68.96, and 72.87%, respectively. On average, one third of mathematical activities performed during mathematics lessons, incorporates physical activities and games in teaching, with the auxiliary use of the arts mainly in introduction and the conclusion of lessons limited to grades 1 and 2.

Table 4. Frequency and percentage of types of activities used during mathematics lessons.

Types of activities used in mathematics' lessons	N	%
Mathematics (without contents from other domains)	320	69.7
Physical activities/sports	56	12.2
Play/play-like/games	43	9.4
Drawing/painting	17	3.7
Literary	12	2.6
Drama/acting/puppetry	6	1.3
Modeling/sculpting	3	0.7
Music	1	0.2
Humor	1	0.2
Invention/technics	0	0
Research	0	0
Robotics	0	0
Computer science	0	0
Dance	0	0
Design	0	0
Photography	0	0
Cooking/culinary	0	0

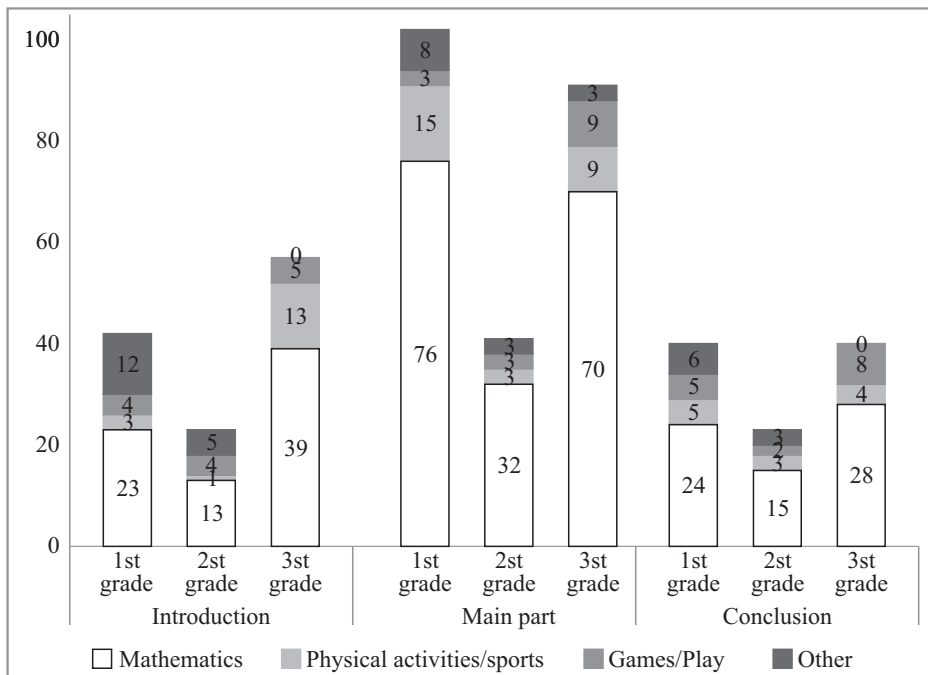

Figure 1. Number and types of activities used in three lesson parts while teaching mathematics in grades 1–3.



## General discussion

As is evident in Figure 2, the overall predominant usage of physical, play, play-like or game-like activities in teaching mathematics, sometimes tangentially tied to the lesson's goals, may be considered developmentally appropriate for children of the age encompassed in this research (6–9 year olds). Close relationships between creativity, playfulness and art in children were noted by Vygotsky (2004), creativity in children is facilitated by playing (Garaigordobil, 2006; Howard-Jones et al., 2002), and playfulness is predictive of creativity (Bateson & Nettle, 2014; Russ, 1993, 1998, 2003). But, when detached from the lesson goals, these activities may serve at their best as amusement, or for appeasing pupils, and at their worst – as a distraction. Play-like activities change into scientific and/or artistic activities in children as they mature, so they can be, with the age and grade advancement, supplemented by more structured, meaningful and mathematical skill-acquisition related, but equally enticing activities strongly reliant on everyday mathematics use such as different mathematical activities embedded in computer science, robotics, research, and invention/modeling. There is little to explain the use of the same schematic general physical activity or game in teaching mathematics in the same proportion with acceding grades. It could easily lead to the perception of mathematics as arid and repetitive, lacking in innovation, novelty and unexpectedness during lessons, let alone beauty. This is surely to be avoided, and it can be achieved by means of presenting creativity in mathematics as perceived and practiced by creative mathematicians and mathematics educators (e.g., Polonijo, 1990, 2002, 2003).

What is concerning is the lack of association between the students' of teacher studies ratings of their general creativity and their creativity in mathematics, as well as creativity in teaching mathematics. When asked to rate their own general creativity, they displayed irrelevance of creativity in mathematics for their overall creativity self-assessments. This finding is in line with previous research on partial domain-specificity of creativity. However, educational consequences of partial domain-specificity of creativity become obvious when we demand that a single person teaches many different subjects equally well (i.e., mathematics, but also language, visual arts, sports, etc.), as well as to offer extracurricular activities aimed at the development of different creativities in children. This is a very challenging task for anyone, even for contemporary creative renaissance types of individuals (i.e., artists *and* scientists), of which there are not many around. If students find their creativity as something different or removed from mathematics, they may also signal that mathematics is not what they consider an accessible venue for their own creativity display. This conclusion stems from the lowest creativity ratings in teaching given to mathematics, and translates into the students' skewed subjective interpretation of which school subjects are more available, or more malleable, for creative teaching, presenting a very serious threat to the sustainable mathematics education.

If creativity in mathematics is dependent on mathematical knowledge (e.g., Sak & Maker, 2006), then the lack of mathematical knowledge can act as a constraining variable, both in pupils *and* in their teachers. It is necessary to educate about creativity, especially creativity in mathematics, as a process available to all pupils, not just the gifted ones. For prospective teachers it is important to know how different

resources and examples can be used to better access mathematical knowledge and which activities and tasks promote the development of mathematical competencies along with mathematical creativity. Students of teacher studies, when preparing and organizing lessons in mathematics chose either demonstration and exercise in mathematical content and procedures, or activities connected mainly to those domains in which they evaluated themselves as creative. Activities in mathematics lessons are rarely connected to the domains of research and innovation, but also are not inquiry-based, open-ended or problem-contextualized. The experience of mathematics as an acquisition of rules and procedures, the art-bias on creativity and not knowing how to recognize and evaluate creativity can be found responsible for the lack of creativity in mathematics education (Bolden et al., 2009). Thus, educating about mathematical creativity is vital to improving creative teaching in mathematics (Nadjafikhah et al., 2012), and Morais and Azevedo (2011) find this should be done via a practical rather than theoretical approach.

If all these findings are taken into account, supplemented by the fact that there is a negative selection of students for teacher studies based on high school mathematics' achievement and abilities (i.e., presently, the lower level in mathematics is required for the enrollment into teacher studies), these first four years of mandatory education may serve to shape an uncreative taste of mathematics in the children's minds. As Kaufman & Baer (2004) stated, perhaps we should not be surprised to find that the society that does not value mathematical ability (add., *in its teachers*) also does not associate creativity with mathematics.

So, the question remains – how does one make students and teachers aware that they can extend their space of personal creativity and creativity in teaching into mathematics as well? The relevance of the teachers' preparatory education, specifically in teaching mathematics to children, as well as the improvement of the current mathematical knowledge to be used in creative teaching, may need to be revealed through future research. Taking the characteristics of students of teacher studies into the equation, such as gender preferences, educating for creative teaching in mathematics would probably include deliberate work with what students already possess, and inspiring teaching, modeling, and mentoring for deliberate creativity in mathematics.

Of course, at a certain point in children's development and age, what primary teachers as generalists provide may not appeal to the developing creative mathematical minds of individual pupils – and this is a positive and expected developmental progression. In order to provide, for promising pupils and teachers, a transition to the subsequently advanced mathematical niches, the advanced specialized academic experts in mathematics will need to take part in the primary education as well.

## Conclusion

In conclusion, this research contributes to the growing research base on creativity as manifested among the teaching staff, and use of creativity in teaching school subjects with the focus on teaching mathematics. The findings from this research suggest that more attention should be paid to the partial domain-specificity issues

inherent in the creativity construct, and implications of relationships of creativity domains to teaching mathematics in primary schools, in order to take the necessary educational steps to wisely guide and improve students', as well as teachers', everyday mathematics teaching and learning.

## Limits and implications

The beliefs of students of teacher studies and teachers about their own creativity (and about teaching mathematics creatively) may be, and probably are, different than the actual cognitive structure and processes of creativity in the domains of arts and sciences, in (mathematical) educational and the general social context. In addition, there are limitations inherent in this sample that caution to over-generalize the results – the relatively small number of participants, and specific, nationally tied educational circumstances. Our self-assessment scores for personal creativity as well as creativity in teaching were based on single questions (creative activity types, and single school subjects), which may cause reliability concerns.

## Acknowledgements

We wish to thank the teachers and the students of teacher studies for devoting their time to participate in this research.

## References

- [1] AMABILE, T. M. (1982), *Social psychology of creativity: A consensual assessment technique*, *Journal of Personality and Social Psychology*, 43 (5), 997–1013, doi: 10.1037/0022-3514.43.5.997.
- [2] ANDREWS, F. M. (1965), *Factors affecting the manifestation of creative ability by scientists*, *Journal of Personality*, 33 (1), 140–152, doi: 10.1111/j.1467-6494.1965.tb01377.x.
- [3] BAER, J. (1998), *The case for domain-specificity of creativity*, *Creativity Research Journal*, 11, 173–177, doi: 10.1207/s15326934crj1102\_7.
- [4] BAER, J. (2013), *Teaching for Creativity: Domains and Divergent Thinking, Intrinsic Motivation, and Evaluation*, In M. B. Gregerson, J. C. Kaufman, & H. T. Snyder (Eds.), *Teaching Creatively and Teaching Creativity* (pp. 175–181). Springer New York. Retrieved from [http://link.springer.com/chapter/10.1007/978-1-4614-5185-3\\_13](http://link.springer.com/chapter/10.1007/978-1-4614-5185-3_13).
- [5] BATESON, P., & NETTLE, D. (2014), *Playfulness, ideas, and creativity: A Survey*, *Creativity Research Journal*, 26 (2), 219–222, doi: 10.1080/10400419.2014.901091.
- [6] BEGHETTO, R. A. (2008), *Prospective teachers' beliefs about imaginative thinking in K-12 schooling*, *Thinking Skills and Creativity*, 3 (2), 134–142, doi: 10.1016/j.tsc.2008.06.001.

- [7] BOLDEN, D. S., HARRIES, T. V., & NEWTON, D. P. (2009), *Pre-service primary teachers' conceptions of creativity in mathematics*, *Educational Studies in Mathematics*, 73 (2), 143–157. <http://doi.org/10.1007/s10649-009-9207-z>.
- [8] BYRNES, J. P., MILLER, D. C., & SCHAFER, W. D. (1999), *Gender differences in risk-taking: A meta-analysis*, *Psychological Bulletin*, 125 (3), 367–383, doi: 10.1037/0033-2909.125.3.367.
- [9] CARSON, S., PETERSON, J. B., & HIGGINS, D. M. (2005), *Reliability, validity, and factor structure of the Creative Achievement Questionnaire*, *Creativity Research Journal*, 17 (1), 37–50, doi: 10.1207/s15326934crj1701\_4.
- [10] CHAN, D., & CHAN, L. K. (1999), *Implicit theories of creativity: Teachers' perception of student characteristics in Hong Kong*, *Creativity Research Journal*, 12 (3), 185–195, doi: 10.1207/s15326934crj1203\_3.
- [11] CONTI, R., COON, H., & AMABILE, T. M. (1996), *Evidence to support the componential model of creativity: Secondary analyses of three studies*, *Creativity Research Journal*, 9 (4), 385–389, doi: 10.1207/s15326934crj0904\_9.
- [12] CSZIKSZENTMIHALYI, M. (1988), *Motivation and creativity: Toward a synthesis of structural and energistic approaches to cognition*, *New Ideas in Psychology*, 6 (2), 159–176, doi: 10.1016/0732-118X(88)90001-3.
- [13] DIAKIDOY, I. N., & SPANOUDIS, G. (2002), *Domain specificity in creativity testing: A comparison of performance on a general divergent-thinking test and a parallel, content specific test*, *Journal of Creative Behavior*, 36 (1), 41–61, doi: 10.1002/j.2162-6057.2002.tb01055.x.
- [14] EIDUSON, B. T. (1958), *Artist and nonartist: a comparative study*, *Journal of Personality*, 26 (1), 13–29, doi: 10.1111/j.1467-6494.1958.tb01567.x.
- [15] FEINGOLD, A. (1994), *Gender differences in personality: A meta-analysis*, *Psychological Bulletin*, 116 (3), 429–456, <http://dx.doi.org/10.1037/0033-2909.116.3.429>.
- [16] FEIST, G. J. (1998), *A meta-analysis of personality in scientific and artistic creativity*, *Personality and Social Psychology Review*, 2 (4), 290–309, doi: 10.1207/s15327957pspr0204\_5.
- [17] FEIST, G. J. (1999), *The influence of personality on artistic and intellectual creativity*, In R. J. Sternberg (Ed.), *Handbook of creativity* (pp. 273–298), Cambridge, UK: Cambridge University Press.
- [18] FELDHUSEN, J. F. (2002), *Creativity: the knowledge base and children*, *High Ability Studies*, 13 (2), 179–183, doi: 10.1080/1359813022000048806.
- [19] GARAIGORDOBIL, M. (2006), *Intervention in creativity with children aged 10 and 11 years: Impact of a play program on verbal and graphic-figural creativity*, *Creativity Research Journal*, 18 (3), 329–345, doi: 10.1207/s15326934crj1803\_8.
- [20] GLĂVEANU, V. P. (2014), *Revisiting the “Art Bias” in lay conceptions of creativity*, *Creativity Research Journal*, 26 (1), 11–20, doi: 10.1080/10400419.2014.873656.
- [21] GUASTELLO, S. J., & SHISSLER, J. E. (1994), *A two factor taxonomy of creative behavior*, *The Journal of Creative Behavior*, 28 (3), 211–221, doi: 10.1002/j.2162-6057.1994.tb01192.x.
- [22] HAN, K. (2003), *Domain-specificity of creativity in young children: How quantitative and qualitative data support it*, *Journal of Creative Behavior*, 37 (2), 117–142, doi: 10.1002/j.2162-6057.2003.tb00829.x.

- [23] HOWARD-JONES, P. A., TAYLOR, J. R., & SUTTON, L. (2002), *The effect of play on the creativity of young children during subsequent activity*, *Early Child Development and Care*, 172 (4), 323–328, doi: 10.1080/03004430212722.
- [24] HU, W., & ADEY, P. (2002), *A scientific creativity test for secondary school students*, *International Journal of Science Education*, 24 (4), 389–403, doi: 10.1080/09500690110098912.
- [25] HYDE, J. S., & LINN, M. C. (1988), *Gender differences in verbal ability: A meta-analysis*, *Psychological Bulletin*, 104 (1), 53–69, doi: 10.1037/0033-2909.104.1.53.
- [26] IVČEVIĆ, Z. (2005), *Creativity or creativities: Domain generality and specificity in creativity* (Unpublished doctoral dissertation), University of New Hampshire, New Hampshire, USA.
- [27] IVCEVIC, Z. (2007), *Artistic and everyday creativity: An act-frequency approach*, *Journal of Creative Behavior*, 41 (4), 271–290, doi: 10.1002/j.2162-6057.2007.tb01074.x.
- [28] JAMES, K., & ASMUS, C. (2000–2001), *Personality, cognitive skills, and creativity in different life domains*, *Creativity Research Journal*, 13 (2), 149–159, doi: 10.1207/S15326934CRJ1302\_3.
- [29] KAUFMAN, J. C., & BAER, J. (2004), *Sure, I'm Creative – But Not in Mathematics!: Self-Reported Creativity in Diverse Domains*, *Empirical Studies of the Arts*, 22 (2), 143–155, <http://doi.org/10.2190/26HQ-VHE8-GTLN-BJJM>.
- [30] LILLY, F. R., & BRAMWELL-REJSKIND, G. (2004), *The dynamics of creative teaching*, *Journal of Creative Behavior*, 38 (2), 102–124, doi: 10.1002/j.2162-6057.2004.tb01235.x.
- [31] LLOYD, A. M. A. (1979), *Convergent-divergent thinking and arts-science orientation*, *British Journal of Psychology*, 70, 155–163, doi: 10.1111/j.2044-8295.1979.tb02154.x.
- [32] LUBINSKI, D. (2004), *Introduction to the special section on cognitive abilities: 100 years after Spearman's (1904) "General intelligence", Objectively determined and measured"*, *Journal of Personality and Social Psychology*, 86 (1), 96–111, doi: 10.1037/0022-3514.86.1.96.
- [33] MILGRAM R. M. (2003), *Challenging out-of-school activities as a predictor of creative accomplishments in art, drama, dance and social leadership*, *Scandinavian Journal of Educational Research*, 47 (3), 305–315, doi: 10.1080/00313830308599.
- [34] MILGRAM, R. M., & LIVNE, N. L. (2005), *Creativity as a general and a domain-specific ability: The domain of mathematics as an exemplar*, In J. C. Kaufman, & J. Baer (Eds.), *Creativity across domains: Faces of the muse*, London: Lawrence Erlbaum Associates Publishers.
- [35] MORAIS, M. F., & AZEVEDO, I. (2011), *What is a Creative Teacher and What is a Creative Pupil? Perceptions of Teachers*, *Procedia – Social and Behavioral Sciences*, 12, 330–339, <http://doi.org/10.1016/j.sbspro.2011.02.042>.
- [36] NADJAFIKHAH, M., YAFTIAN, N., & BAKHSHALIZADEH, S. (2012), *Mathematical creativity: some definitions and characteristics*, *Procedia – Social and Behavioral Sciences*, 31, 285–291, <http://doi.org/10.1016/j.sbspro.2011.12.056>.
- [37] PLUCKER, J. A. (1999), *Is the proof in the pudding? Reanalyses of Torrance's (1958 to present) longitudinal data*, *Creativity Research Journal*, 12 (2), 103–114, doi: 10.1207/s15326934crj1202\_3.

- [38] POLONIJO, M. (1990), *Matematički problemi za radoznalce*, Zagreb: Školska knjiga.
- [39] POLONIJO, M. (2002), *Matematičke zavrzlamе: priručnik za kreativne matematičare*, Zagreb: Profil International.
- [40] POLONIJO, M. (2003). *Matematički upitnici*, Zagreb: Alfa.
- [41] RAMOS, S. J., & PUCCIO, G. J. (2014), *Cross-cultural studies of implicit theories of creativity: A comparative analysis between the United States and the main ethnic groups in Singapore*, Creativity Research Journal, 26 (2), 223–228, doi: 10.1080/10400419.2014.901094.
- [42] RICHARDS, R. (1993), *Everyday creativity, eminent creativity, and psychopathology*, Psychological Inquiry, 4 (3), 212–217, doi: 10.1207/s15327965pli0403\_12.
- [43] RICHARDS, R., KINNEY, D. K., BENET, M., & MERZEL, A. P. (1988), *Assessing everyday creativity: Characteristics of the everyday creativity scales and validation with three large samples*, Journal of Personality and Social Psychology, 54, 467–485, doi: 10.1037/0022-3514.54.3.476.
- [44] ROOT-BERNSTEIN, M., & ROOT-BERNSTEIN, R. (2006), *Imaginary worldplay in childhood and maturity and its impact on adult creativity*, Creativity Research Journal, 18 (4), 405–425, doi: 10.1207/s15326934crj1804\_1.
- [45] ROOT-BERNSTEIN, R. S., & ROOT-BERNSTEIN, M. (2004), *Artistic scientists and scientific artists: The link between polymathy and creativity*, In R. J. Sternberg, E. L. Grigorenko, & J. L. Singer (Eds.), *Creativity: From potential to realization* (pp. 127–151), Washington, DC: American Psychological Association.
- [46] ROY, D. D. (1996), *Personality model of fine artists*, Creativity Research Journal, 9 (4), 391–394, doi: 10.1207/s15326934crj0904\_10.
- [47] RUNCO, M. (1999), *Implicit theories*, In M. Runco, & S. Pritzker (Eds.), *Encyclopedia of creativity*, Vol. 2 (pp. 27–30), San Diego, CA: Academic Press.
- [48] RUNCO, M. A. (1990), *Implicit theories and ideational creativity*, In M. A. Runco & R. S. Albert (Eds.), *Theories of creativity* (pp. 234–252), Newbury Park, CA: Sage.
- [49] RUNCO, M., & BAHLEDA, M. (1986), *Implicit theories of artistic, scientific, and everyday creativity*, Journal of Creative Behavior, 20 (2), 93–98, doi: 10.1002/j.2162-6057.1986.tb00423.x.
- [50] RUSS, S. W. (1993), *Affect and creativity: The role of affect and play in the creative process*, Hillsdale, NJ: Lawrence Erlbaum Associates.
- [51] RUSS, S. W. (1998), *Play, creativity, and adaptive functioning: Implications for play interventions*, Journal of Clinical Child Psychology, 27 (4), 469–480, doi: 10.1207/s15374424jccp2704\_11.
- [52] RUSS, S. W. (2003), *Play and creativity: developmental issues*, Scandinavian Journal of Educational Research, 47 (3), 291–303, doi: 10.1080/00313830308594.
- [53] SAK, U., & MAKER, C. J. (2006), *Developmental variation in children's creative mathematical thinking as a function of schooling, age, and knowledge*, Creativity Research Journal, 18 (3), 279–291, doi: 10.1207/s15326934crj1803\_5.
- [54] SARACHO, O. (2012), *Creativity theories and related teachers' beliefs*, Early Child Development and Care, 182 (1), 35–44, doi: 10.1080/03004430.2010.535899.
- [55] SILVIA, P. J., KAUFMAN, J. C., & PRETZ, J. E. (2009), *Is creativity domain-specific? Latent class models of creative accomplishments and creative self-descriptions*, Psychology of Aesthetics, Creativity, and the Arts, 3 (3), 139–148, <http://dx.doi.org/10.1037/a0014940>.

- [56] SIMONTON, D. K. (2000), *Creative development as acquired expertise: Theoretical issues and an empirical test*, *Developmental Review*, 20, 283–318, doi: 10.1006/drev.1999.0504.
- [57] SIMONTON, D. K. (2003), *Scientific creativity as constrained stochastic behavior: The integration of product, person, and process perspectives*, *Psychological Bulletin*, 129 (4), 475–494, doi: 10.1037/0033-2909.129.4.475.
- [58] STERNBERG, R. J. (1985), *Implicit theories of intelligence, creativity, and wisdom*, *Journal of Personality and Social Psychology*, 49 (3), 607–627, doi: 10.1037/0022-3514.49.3.607.
- [59] STERNBERG, R. J. (1996), *Cognitive psychology*, Fort Worth: Harcourt Brace & Company.
- [60] STERNBERG, R. J., & LUBART, T. I. (1991), *An investment theory of creativity and its development*, *Human Development*, 34, 1–31, doi: 10.1159/000277029.
- [61] STUMPF, H. (1995), *Scientific creativity: A short overview*, *Educational Psychology Review*, 7 (3), 225–241, doi: 10.1007/BF02213372.
- [62] SU, R., ROUNDS, J. & ARMSTRONG, P. I. (2009), *Men and things, women and people: A meta-analysis of sex differences in interests*, *Psychological Bulletin*, 135 (6), 859–884, doi: 10.1037/a0017364.
- [63] VOYER, D., & VOYER, S. D. (2014), *Gender differences in scholastic achievement: A meta-analysis*, *Psychological Bulletin*, 140 (4), 1174–1204, doi: 10.1037/a0036620.
- [64] VYGOTSKY, L. S. (2004), *Imagination and creativity in childhood*, *Journal of Russian and East European Psychology* [English translation], 42 (1), 7–97.
- [65] WAI, J., LUBINSKI, D., & BENBOW, C. P. (2005), *Creativity and occupational accomplishments among intellectually precocious youth: An age 13 to age 33 longitudinal study*, *Journal of Educational Psychology*, 97 (3), 484–492, doi: 10.1037/0022-0663.97.3.484.

Contact addresses:

Željko Rački  
Faculty of Education  
Department of Social Sciences  
Josip Juraj Strossmayer University of Osijek  
Cara Hadrijana 10  
31 000 Osijek, Croatia  
e-mail: zracki@foozos.hr

Ana Katalenić  
Faculty of Education  
Department for Lifelong Learning  
Josip Juraj Strossmayer University of Osijek  
Cara Hadrijana 10  
31 000 Osijek, Croatia  
e-mail: akatalenic@foozos.hr

Željko Gregorović  
Faculty of Education  
Department of Natural Sciences  
Josip Juraj Strossmayer University of Osijek  
Cara Hadrijana 10  
31 000 Osijek, Croatia  
e-mail: zgregorovic@foozos.hr

## Samoprocjene kreativnosti u učitelja i studenata razredne nastave u različitim domenama i implikacije odnosa kreativnosti za poučavanje matematike u osnovnoj školi

---

---

Željko Rački, Ana Katalenić i Željko Gregorović

Fakultet za odgojne i obrazovne znanosti, Sveučilište Josipa Jurja Strossmayera u Osijeku, Hrvatska

*Sažetak.* Cilj je ovoga rada bio kod učitelja i studenata razredne nastave istražiti odnose samoprocijenjene kreativnosti u različitim domenama i metodičke kreativnosti tj. kreativnosti u poučavanju: matematike, jezika, tjelesne i zdravstvene kulture, likovne kulture, glazbene kulture i prirodoslovlja. Sudjelovali su učitelji u osnovnim školama ( $N = 105$ ) i studenti Učiteljskoga studija ( $N = 111$ ) u dobi od 21 do 64 godine ( $M = 31.2$ ,  $SD = 11.6$ ; 95.4% žena). Sudionici su ispunili upitnike, a šezdeset dvije pisane studentske pripreme za izvođenje sata matematike od 1. do 4. razreda osnovne škole su analizirane s obzirom na njihov sadržaj (tj. vrstu odabranih aktivnosti tijekom sata matematike, a koje konsenzusno pripadaju različitim domenama kreativnosti). Rezultati pokazuju da kada su se studenti ocijenili opće kreativnima, ocijenili su se kao različito kreativni u različitim domenama. U studentskom uzorku, domena koja je imala najnižu i neznčajnu korelaciju sa samoprocjenom opće kreativnosti jest samoprocjena osobne kreativnosti u matematici, ali i samoprocjena kreativnosti u poučavanju djece u matematici. Utvrđena internalna iskustvena struktura samoprocjena kreativnosti kod studenata, kao i razumijevanje što je kreativnost (tj. kao nešto što isključuje matematiku), može imati implikacije za nastavu matematike u osnovnoj školi odnosno izbor aktivnosti tijekom sata nastave iz matematike. Utvrđene su i dobne i po iskustvu u poučavanju razlike u ispitivanim varijablama, otvarajući brojna pitanja o (ne)kreativnoj nastavi matematike i njezinom odnosu s učeničkim postignućima i izvrsnosti.

*Cljučne riječi:* nastava matematike, domene kreativnosti, implicitne teorije, nastavne pripreme, pristranost u vrjednovanju umjetnosti



## How Croatian mathematics teachers organize their teaching in lower secondary classrooms: differences according to the initial education

---

---

Ljerka Jukić Matić\*<sup>1</sup> and Dubravka Glasnović Gracin<sup>2</sup>

<sup>1</sup>Department of Mathematics, Josip Juraj Strossmayer University of Osijek, Croatia

<sup>2</sup>Faculty of Education, University of Zagreb, Zagreb, Croatia

*Abstract.* Initial education of mathematics teachers is important for teaching and learning mathematics in school classrooms. Some studies showed that there exists a relation between students' achievement and teachers' mathematical and pedagogical content knowledge. In Croatian lower secondary education, there are mathematics teachers who significantly differ in their initial education. In this paper, we examine teaching practices of two groups of mathematics teachers; those who finished former pedagogical academies and those who obtained their degrees from departments of mathematics. Using qualitative methods as observations and interviews, we investigated the teaching practice of 12 lower secondary mathematics teachers with special reference to the utilization of the textbook. Results showed that these two groups of teachers differ in the use of textbooks, but also in some other parts of teaching practice.

*Keywords:* mathematics teacher, initial education, textbook, teaching practice, qualitative study

### Introduction

Recently, initial education of future mathematics teachers came under public scope. This emerged in times when many countries around the world are coping with mathematics curriculum reforms, examining the factors that significantly influence on teaching and learning mathematics in school classrooms. The international study called Teacher Education and Development Study in Mathematics (TEDS-M) investigated mathematics education programs and the mathematical content

---

\*Corresponding author.

and pedagogical content knowledge of future teachers depending on their initial education. When it comes to future lower-secondary teachers, future teachers prepared in secondary programs outperformed those teachers in the other programs by a substantial amount. This means that future teachers whose programs prepared them to teach at the lower and upper-secondary grades had higher achievement than those trained for the lower-secondary level only. The study showed also that the countries with programs providing the most comprehensive opportunities to learn university mathematics and school-level mathematics tended to have higher scores on the TEDS-M tests (Tatto et al., 2012). When it comes to preparation of lower secondary teachers in the top achieving countries, about half of the courses are related specifically to the study of university mathematics. The other half are allocated to either didactics of mathematics (30%) – which focuses on how students learn mathematics and how it is best taught – or general pedagogy (20%) which includes instructional design, classroom management as well as the basic courses related to schooling (Blömeke, Hsieh, Kaiser & Schmidt, 2014). The TEDS-M study also correlated teachers' results in TEDS-M items with students' results of TIMSS items indicating that teacher's initial education has impact on later students' achievement.

Mathematics teachers with different initial education teach also in Croatian lower secondary schools (grades 5-8). Their differences range from the content they learned, i.e. high-level and school-level mathematics during their study, courses taken in didactics of mathematics and general pedagogy, years of studying to the obtained degree etc. Domović, Glasnović Gracin and Jurčec (2012) examined teaching practices of such teachers through questionnaires. The results showed differences between two main groups of mathematics teachers in the Croatian mathematics classroom in lower secondary school: mathematics teachers who obtained a degree at former pedagogical academies and those who graduated at mathematics departments. For instance, mathematics teachers who completed former pedagogical academies (PA Teachers) claimed that they often practiced individualized work, adapting it to the needs of students. They lean on the textbooks to a greater extent in comparison to their colleagues with degrees from departments of mathematics (Math Teachers). These participants devoted a great attention to mathematical accuracy of textbook content (Domović et al., 2012). The study reported in this paper is a follow-up of aforementioned quantitative study. We base our study also on results of another study that showed some differences between the two groups of mathematics teachers according to their initial education (PA Teachers and Math Teachers). The National exams for mathematics conducted in school year 2006/07 (Institut društvenih znanosti Ivo Pilar, 2007) showed some differences in the students' achievement according to their teachers' initial education. Interestingly, the students taught by the PA Teachers showed slightly better performance in mathematics in comparison to the students taught by Math Teachers. In the 1980s, the study for mathematics teachers was terminated at the former pedagogical academies and moved to the departments of mathematics on the university level. This happened also for other lower secondary subjects (Croatian language, science, arts, music, and physical education). One of the main reasons for that was the idea of better initial education of future teachers. This means also better education for their students as well. Since the results from National exams in mathematics showed lower performance of students taught by university teachers, we raise questions about the classroom teaching practice of the PA and Math

Teachers. In this research, we investigated qualitatively and more in-depth the use of textbooks and teaching practice of these two groups of mathematics teachers.

## Theoretical background

### The use of textbooks in the classroom

Throughout the history, mathematics textbooks have had important role in mathematics education (e.g. Love & Pimm, 1996). Research carried out in different countries around the world showed similar results of teachers' use of mathematics textbooks: it is the teacher who decides which textbook to use, when and how it is used, which parts to use and in what order, and when and to what extent the students will work with the textbook (Pepin & Haggarty, 2001). The mathematics taught in the classroom is significantly influenced by the textbook content (e.g. Johansson, 2006). For instance, in lesson preparation, teachers rely heavily on textbooks. Also, teachers use textbooks as a source for exercising and homework (e.g. Pepin & Haggarty, 2001), and as a guide for instruction, i.e. what to teach, which instructional approach to follow, and how to present content (Valverde et al., 2002).

Traditionally, mediating between the students and textbook has always been the teacher's function (Luke et al, 1989). According to Rezat (2011), there are three dimensions of mediation of textbook use: direct and indirect, specific and general, obligatory and voluntary. In direct mediation, teacher explicitly refers to the textbook, while indirect mediation of textbook use is usually not planned by the teacher and often is not under his/her attention. Specific and general mediation of textbook use can only appear in combination with direct mediation. In general mediation, references to the textbook are general. Teacher does not refer to any specific sections, but draws attention to the textbook in a general way. Specific mediation of the textbook use relates to the specific parts of the textbook. In voluntary mediation, the teacher reminds the students that they can use the textbook in order to get assistance, but the students do not have to use the textbook if they do not need assistance. In obligatory mediation of textbook use, the students do not have a choice to use the textbook or not. They are supposed to work on the assigned tasks and problems.

### Classroom teaching practice

Saxe (1999) states that teaching practices may be regarded as recurrent and socially organized everyday life activities. Also, teacher's practice may be characterized as the activity developed by the teacher that unfolds in actions established according to an action plan (Jaworski & Potari, 2009). An important aspect of teachers' practice is how they use curriculum materials in classrooms (Ponte & Chapman, 2006; Remiliard, 2009).

Various studies, that documented teacher's practices, used different methods to collect data like teachers'/students' reports, lesson observations, questionnaires or interviews etc. Johansson (2006) investigated videotaped lessons from three

Swedish teachers at lower secondary level with an emphasis on the textbook use. She used the framework with four main coverage codes of the lessons: classroom interaction, content activity, organization of students and textbook influence. Coverage codes were used to code a lesson or defined period of a lesson.

*Classroom interaction* covers public interaction, private interaction, and mixed interaction. A public interaction denotes situation where a teacher stands in front of the class, directing classroom discourse. Students are supposed to listen or participate occasionally. A private interaction denotes situation where students are working in their seats, they may discuss tasks with one another and the teacher may assist them. Mixed interaction is the type of interaction where the teacher or students present information in public, but in this type of interaction students do not have to pay attention strictly to what was happening in the classroom. *Organization of students* denotes whether students are working individually, in pairs or in groups, in parts of lessons with private or mixed interaction. *Content activity* describes the three, mutually exclusive categories of activities: non-mathematical work, mathematical organization, and mathematical work. Mathematical organization refers to a part of the lesson which is somehow connected to mathematics (e.g. mathematics tools, resources, homework, tests), but it does not explicitly and directly contain a mathematical content. The category of mathematical work is structured around some mathematical content.

According to Johansson (2006), the code *textbook influence* investigates three aspects of the textbook use: textbook is used directly, the textbook is used indirectly and the textbook is absent. Textbook direct describes an open and explicit use of the textbook: for instance, students working individually or in the groups on tasks from the textbook, or the teacher reads the text directly from the textbook. Textbook indirect describes situations where the teacher solves a worked example from the textbook on the board, or uses motivation examples similar to those from the textbook, or talks about mathematical statements the same way as in the textbook, but the teacher does not refer explicitly to it. Textbook absence describes a situation in which it is clear that the textbook was not included in the lesson. For instance: teacher introduces a new topic differently than it is in the textbook or gives exercises which are not from textbook nor similar to those in the textbook.

Johansson (ibid.) also directed her attention to the teachers' activities and how often specific events like problem solving, assignment of homework, assessment, goal statements, and summary of lessons occurred within a lesson.

This research involves the investigation of the Croatian teaching practice. The research instrument is partly influenced by the here described framework developed by Johansson (2006).

### Croatian setting

The study conducted by Glasnović Gracin (2011) encompassed the survey of around a thousand Croatian mathematics teachers in lower secondary education, examining their teaching practice and the use of textbook. The results showed that more than four fifths of Croatian teachers surveyed confirmed reliance on the textbook structure to a great extent (sequence of textbook contents, of examples

and exercises, etc.) and that according to that structure they carry out their teaching practice. The teachers followed a sequence of textbook contents, and used worked examples and exercises in the exact order as in the textbooks. Also, 97% of teachers confirmed that their students use the mathematics textbook for doing exercises and 99% of participants stated that they give homework from the textbook. When it comes to teaching practice, results showed that 87% of teachers used frontal work for teaching a new topic. Further, 84% of the surveyed teachers stated that they often or almost always use methods and approaches suggested by the textbook.

Domović et al. (2012) analyzed these results according to the initial teacher education. Their results show that PA Teachers rely more on the textbook and follow the textbooks content and structure more closely than their colleagues who finished university mathematics studies. The National exams for mathematics (Institut društvenih znanosti Ivo Pilar, 2007) showed that the students taught by the PA Teachers showed slightly better performance in mathematics in comparison to the students taught by Math Teachers. These issues raised questions on the teaching practice according to the initial teacher education.

## Research questions

Examining and comparing teaching within a culture allows educators to examine their own teaching practices from various perspectives, widening known possibilities in a quite similar way as examining and comparing teaching between cultures does (Hiebert et al., 2003). This comparison can reveal alternatives and stimulate choices being made within a country. It is also important to know what actually teaching looks like, so that national discussions can focus on what most students experience (Gunnarsdóttir & Guðbjörg, 2015). The main purpose of this study is to portray mathematics teaching in some Croatian classrooms and reveal teachers' practices. Therefore, we formed the following research questions: How do the teachers organize their teaching in mathematics classrooms in lower secondary school? When and how the textbooks are used in the mathematics classrooms? Are there any differences in teaching practices among teachers according to their initial education and what are they?

## Methodology

### Participants

The study involved 12 mathematics teachers from lower secondary education in Croatia (grades 5 to 8). All the participants were qualified to teach mathematics. Six of them are experienced teachers with more than 30 years teaching experience. They are graduates of former pedagogical academies which educated teachers for lower secondary grades until the 1980s. The other six participants are teachers with 12 to 25 years of teaching experience. They are university graduates with a degree in mathematics (mathematics teachers) who started their study after 1980. Within this paper the first group of teachers will be called PA Teachers because they finished their studies for mathematics teachers at former pedagogical academies. They are educated for teaching only in the grades 5 to 8. The second group is

named Math Teachers because they finished their studies on the departments for mathematics. They are educated for teaching mathematics in the grades 5 to 12.

## Methods

In this study, we used classroom observations and interviews with teachers. The combination of two qualitative and a previous quantitative method provides triangulation of the obtained data (Patton, 1990).

The observations encompassed 3 to 4 lessons by each of the 12 teacher participants, making a total of 45 observed lessons. It was chosen to observe only three or four lessons since, according to methodological research findings; no significant information is obtained by observing more than three lessons (Hill et al., 2008). Participants were observed during October 2013. The choice of grades and content units was left up to the participant teachers, as it comes with the curricular plan and program. For the purposes of observation, we designed observation categories that can be seen in Table 1.

Table 1. Observational questions.

Categories	Observational questions
<i>Impact of the textbook structure on instruction</i>	Minutes of using textbooks during lesson unit (direct, indirect, not use). What is the influence of textbooks content and structure on instruction? Does the instruction follow the textbook page by page? What is taken from the textbook?
<i>Teaching, exercising, homework</i>	How is new content introduced? How does the exercise lesson look like? Which sources are used for exercising and homework?
<i>Differentiation</i>	Does the teacher use individualization in class with respect to the different abilities and needs of students (e.g. differentiated utilization of textbook and textbook assignments, special worksheets etc.)
<i>Technology</i>	Is the technology used? What kind and how?

After the classroom observations, we conducted a semi-structured interview with each of the participants. The interview questions come under three main categories (Table 2), but the interviewer could ask additional questions based on the observed lessons or could expand upon an interesting point arising during the interview. All the interviews were audio taped and then transcribed for analysis.

Table 2. Interview questions.

Categories	Interview questions
<i>Impact of the textbook structure on instruction</i>	Describe how you usually prepare for mathematics lesson. Does the textbook, in your opinion, influence the structure of your instruction, e.g. using the same title, definitions, language, symbols, sequence, didactical approach, worked examples, figures? Explain.
<i>Teaching, exercising, homework</i>	Describe your typical lesson with learning new content. Describe your typical lesson with emphasis on exercising. Describe how you choose homework activities and from which sources. Describe how you prepare your students for examination.
<i>Differentiation</i>	Do you use differentiation in classroom? Describe how and when.

## Data analysis

In our data analysis we used Johansson's (2006) coverage codes of *textbook influence*, *classroom interaction* and *organization of students* to code defined periods of a lesson in observation tables. Then the data from the observation tables was analysed using content analysis. According to Cohen, Manion and Morrison (2007), content analysis takes texts and analyses, reduces and interrogates them into summary form through the use of both pre-existing categories and emergent themes in order to generate or test a theory. In all, it defines the process of summarizing and reporting written data – the main contents of data and their messages. Anderson and Arsenault (in Cohen et al., 2007) indicate the quantitative nature of content analysis stating that at its simplest level the content analysis involves counting concepts, words or occurrences in documents and reporting them in tabular form. In a similar way, we analysed transcribed interviews, and supplemented the data obtained from the observations.

## Results

### Impact of textbook content and structure on teaching

In total, we observed 45 lessons; 22 of them were observed in Math Teachers classrooms and 23 in PA Teachers' classrooms. In 51% of observed lessons, teachers blindly followed mathematics textbook page by page, and in further 16% of observed lessons, the textbook was followed partly. Looking at the observed lessons in terms of two groups of teachers, the textbook dominated in 78% of lessons of PA Teachers and in 59% of Math Teachers' lessons. The textbook was completely absent in 10 observed lessons, and 7 of these 10 lessons were at Math Teachers' classrooms.

On average, in PA Teachers' classrooms, students used the textbook directly for 31 minutes, and in Math Teachers' classroom, the students used the textbook for 22.5 min on average. Math Teachers showed more flexibility in changing teaching methods and using other resources for instructional practice besides textbook.

When asked whether textbook structure influences their teaching, one PA Teacher said that textbook largely reflects only her exercise lessons, while other five clearly stated that the textbook has impact on all their lessons, on teaching and exercising as well:

PA3: "I believe it must have impact on the lesson. . . What is the use of the textbook if it is closed, not used?"

However, only three out of six Math Teachers indicated that they refer to the textbook for some parts of the lessons, like title or definition, but they did not accept the textbook structure as the template for their lessons.

MT1: "Well, I like that title is the same as in the textbook. The definition does not have to be [. . .] I also like to improvise with other textbooks."

### Teaching, exercising, homework

More than half of observed lessons did not have motivational part in the beginning of the lesson. If we examine types of lessons according to the main activity, 30% of lessons with teaching new topic did not have motivation, and 75% of lessons focused on exercising did not have motivation at all. Looking at two groups of teachers, one can see that there is no difference between Math Teachers and PA Teachers in this issue.

The observations encompassed 20 lessons with the emphasis on teaching new topic. Math Teachers conducted 8 out of those 20 lessons and PA Teachers conducted 12 out of those 20 lessons. PA Teachers used only teacher-centred teaching, standing in front of the class, unlike Math Teachers, who occasionally used other student-centred teaching strategies like working in groups and individual seat work. PA Teachers tended to use worked examples from the textbook in their teaching lessons more than Math Teachers. In the interview, one PA Teacher elaborated why she uses worked examples:

PA1: “So, I work according to the textbook. I do not make my own examples... they [students] are not very careful... they do not copy everything from the board they should. So they would have in the textbook all that we did in the lesson. If someone was absent, or sick... they can work according to the book.”

However, one Math Teacher had the opposite opinion, what mainly reflects what other four Math Teachers think about using worked examples from the textbook in the lessons:

MT2: “No, no, no... I never use worked examples from the textbook [...]. I think it's silly that they [students] have the same task solved three or five times”

The observations encompassed 25 lessons with the emphasis on exercise activities. Some of them were revision lessons. Math Teachers conducted 14 out of 25 lessons and 11 were conducted by PA Teachers. It was observed that the textbook was used as the important source for exercising. And this was confirmed also by participants in the interview. However, we noticed the distinction between Math Teachers and PA Teachers. In 72% of observed lessons of PA Teachers, the textbook was the main source for exercising, and only in 36% of observed lessons at Math Teachers. Additionally, Math Teachers used other sources for exercising, like self-made worksheets, tasks from un-official or older textbooks, tasks and problems from the internet. Traditional style of exercising prevailed in 2/3 of observed exercise lessons. This means that students worked individually in their seats and afterwards solutions of (several) tasks were shown on the blackboard. This type of exercise was dominant in lessons observed at PA Teachers (88% of observed exercise lessons). Although Math Teachers used this type of practice as well, it was observed in 64% of their exercising lessons, and in 29% of their exercising lessons they used working in pairs or groups.

In the interviews, four PA Teachers described their exercising lessons as detected in the observation. For instance:



PA2: “Usually, I use tasks from textbooks, students work independently, and then we check the solution on the board, or I assess them . . . they do a short five tasks in their notebooks, for ten to fifteen minutes, and then I call someone to show me the notebook and we comment the solved tasks.”

Math Teachers partly confirmed in interview what was observed in the exercising lessons; one teacher pointed out coming to the blackboard as the main component of exercising lessons, while three participants pointed out various forms of organizing students as the most influential aspect of exercising.

In 71% of observed lessons, it was observed that teachers assigned homework from the textbooks. Here we did not detect difference between two groups of teachers. All interviewed PA Teachers emphasized the textbook as the only source for assigning homework, but in the case of Math Teachers, only one teacher mentioned the textbook as the only source for homework. The other Math Teachers mentioned that they also give self-made worksheets or internet pages with various tasks for homework. For instance:

MT 5: “Mainly [the homework is] from the textbook. But sometime I give [them] worksheets that they have to attach to the notebooks.”

MT 6: “I give homework mainly from the textbook, but I also direct students to other sources for homework like links to web pages with various tasks. . . Most of them usually go [to the webpage] and do [those tasks].”

## Examination

The teachers were also asked to describe how they prepare students for examination and how they make exams. We detected no difference in responses between PA Teachers and Math Teachers related to the exam preparation. They all claimed they used various resources for preparation, not only official textbook. But the difference, we detected, is connected with the exam itself. Five out of six PA Teachers claimed they use ready-made exams from textbooks publishers.

PA 6: “Well, I believe those exams coming with the textbooks are safe. They must have been tested on some student population.”

However, one Math Teacher claimed she used ready-made tests, and other five said they make exams themselves:

MT 6: “I make my exams according to the students’ abilities and level that we attained during practicing mathematical content.”

The participants also mentioned the problem that some students get the ready-made tests and go through them before the test at home.

## Differentiation in the classrooms

During classroom observations it was detected that teachers did not differentiate students according to their abilities, and even if they did, this differentiation was

only for students with difficulties in learning mathematics. In 76% of observed lessons, there was no visible differentiation. However, in the interview almost all participants claimed that they tend to differentiate students according to their abilities depending on the mathematical content. Only one participant acknowledged that she does not use differentiation in her class because she considers all her students have equal abilities.

MT 5: “I do not differentiate them according to their abilities. They all can do those tasks, depending how much effort they invest. . .”

In 17% of observed lessons in PA Teachers’ classrooms, there was present some kind of differentiation according to students’ abilities and in 32% of observed lessons in Math Teachers classrooms. But in the interview, we detected that all teachers do not consider the term “differentiation” in the same way. Some teachers connected differentiation only with average and poor achieving students, and others with highly achieving and average students. Two teachers (one Math Teacher and one PA Teacher) did not connect differentiation with students’ abilities but with different classroom interaction: in pairs, in groups and individually.

### The use of technology

In 58% of observed lessons there was no use of technology, while in other lessons technology was used mainly for teachers’ presentation and not for students’ exploration or discovering mathematical concepts or procedures. Technology was used more in the exercise lessons, than in lessons with emphasis on teaching new mathematical content. The technology was used in only 5 out of 23 lessons given by PA Teachers. This was observed only at two teachers, while others used traditional tools and resources. On the other hand, in 14 out 22 lessons given by Math Teachers the modern technology was used. Only one teacher did not use it in any of her observed lessons.

## Discussion and conclusion

In this study we wanted to examine differences in teaching practices between mathematics teachers according to their initial education. We relied on results from large-scale study of Domović et al. (2012), where survey showed that such differences exist. We wondered if teachers in the survey gave socially acceptable answers that differed from their real teaching practice, since teachers’ self-reports of their teaching practice cannot be assumed to correspond exactly with what they do in the actuality of the classroom (Bretscher, 2015). Our qualitative study enabled us to investigate deeper teaching practices between two groups of mathematics teachers that we called PA Teachers and Math Teachers. Given that our sample of teachers is small, and that such qualitative study cannot provide generalizations of results, we combine our findings with results of aforementioned large-scale survey what enables us the triangulation of data.

Our study showed that differences between two groups of teachers are present and visible in Croatian mathematical classrooms in lower secondary schools. This

supports and extends earlier findings of Domović et al. (2012) about the textbook use. The teachers in both groups used official textbook for lesson preparation, teaching, exercising, and homework assignments. With the observations, we were able to examine how the textbooks are used, how often they were used in mathematics classrooms, and especially in what and how many parts of the lessons; whether the textbooks are used directly, indirectly, or they were not used at all. The results showed that PA Teachers used textbooks to a greater extent, directly and indirectly, than Math Teachers. These results correspond with the findings of Domović et al. (2012). In terms of textbook use, Math Teachers showed more independence; they also used other resources for teaching new mathematical content, exercising and homework. The classroom observations showed that worked examples from the textbook have impact on the lessons. Some teachers used exactly the same worked examples, while others tended to change values originally taken from the textbook example. However, PA Teachers relied on worked examples more closely than Math Teachers.

Although our results showed that both groups of teachers positioned themselves as mediators of the textbook, deciding what will be used from the textbook, when and how the textbook will be used in the lessons, the PA Teachers acted as the mediators between the textbook and students in more occasions. This mediation was direct, obligatory and specific in both groups of teachers, but PA Teachers explicitly referred to the specific parts of the textbook in more instances than Math Teachers. However, we also detected indirect teacher mediation in PA Teachers' classrooms, what was inferred from students' utilization of the textbook. Students opened the textbooks on their own initiatives, without any teacher's instructions, what indicates "that the teacher has a major influence on the selection of sections from the book even when he does not refer to the book explicitly" (Rezat, 2011, p. 237). The students were used to the indirect use of textbook, and they knew that the teacher follows the textbook content and structure.

The reason why PA Teachers rely more on the textbook than Math Teachers can be twofold. One reason might lie in the authority of textbook. Pepin and Haggarty (2001) describe two kinds of mathematics textbook authority: "authority associated with the mathematics; and authority over negotiation of the text" (p. 164), i.e. the authority of the mathematics content itself, the authority of given methods and the authority of the written text. In another words, the textbook deals with the authorized version of society's knowledge (Olson, in Pepin and Haggarty, 2001). The Croatian official textbooks go through the revision procedure of the state board established by the Minister of education. That gives the textbooks additional guarantee about the authorized mathematics knowledge and approved methodological approaches. Also, for many decades, the mathematics textbooks in Croatian education system were usually written by professional university mathematicians, therefore teachers knew that mathematical content in the textbook was mathematically correct. The reliance on textbook can also be connected with teachers' initial education, where PA Teachers did not have as many mathematics courses as Math Teachers. On the other hand, this can be a reason why Math Teachers relied to the textbook to lesser extent. Their initial education provided them richer mathematical knowledge, so they feel comfortable to adjust definitions and other contents from the textbook or to use approaches for teaching new concepts other than suggested in the textbook. For instance, this was visible in answer of one Math

Teachers who said that mathematical description in the official textbook differed from that she knew: “it was written that a graph of proportional dependence is a ray, and in other textbook, that it is a line. So I re-checked [ . . . ]”.

The PA Teachers relied more on the ready-made exam sheets provided by textbook publishers. This result can be connected with authority of the textbooks and all its associated components such as exams.

Math Teachers also used new technologies in the classroom, unlike their older PA colleagues who finished their studies before 1980s. It might have been that PA Teachers were not educated enough on the use of new technology or they did not see the benefit of technology in terms of didactical contribution to mathematics learning. From the observed lessons and conducted interviews, we can conclude that PA Teachers used more traditional approach to teaching and learning mathematics. Significant utilization of textbook as traditional resource coincided with traditional teaching, where teacher stands in front of the class explaining and after that students are solving tasks individually in their seats. Math Teachers showed slightly different view on mathematical discourse, which is closer to contemporary approach in mathematics education. Some of them had traditional approach as well, but several Math Teachers used discovery elements. Students working and discussing in pairs or in groups to discover new concepts or to practice new content is a paradigm of exploratory learning, and this was visible in some of Math Teachers' classrooms.

The results obtained in the study of Domović et al. (2012) showed that the PA Teachers approach their students individually and adapt to their needs. Our study however showed that both groups of participants do not use individualization to a significant extent. Interestingly, 11 out of 12 participants claim that they use individualization according to the students' needs, but the observations showed that it is not so. Interview results also indicate that teachers differently understand the term of “individualization” and “differentiation” according to the students' needs, as reported in the results section. These findings raise the question: What did the participants of the survey in Domović et al. (2012) understand under the term of individualization? It might be that different initial education implies different terminology.

As mentioned in the introduction part, we also tried to put light on the results of the National exam 2006/07 in mathematics, where the students taught by PA Teachers showed better performance than those taught by Math Teachers (Institut Ivo Pilar, 2007). The results of our qualitative study showed some differences in the teaching practice which might help in explaining such result. The classroom observations showed that the PA Teachers required more discipline in the classroom, and during the periods where students individually worked with the text material (mainly the textbook exercises) the PA Teachers were constantly walking through the classroom helping students. Sometimes their demands were pretty high. Further, the insight into the exam content reveals traditional requirements in the test (emphasis put on the procedural skills). As mentioned in Domović et al. (2012, p. 251), the better performance of students taught by PA Teachers might indicate the emphasis on the traditional and procedural requirements of mathematics education.

This study revealed that the textbook has important role in mathematics education in Croatia. Similar results are found in other countries (Robitaille & Garden,

1989; Johansson, 2006). The qualitative approach confirmed the previous quantitative results about the teaching practice, but still the result about the differentiation according to students' abilities differ from the questionnaire results. Interviews and classroom observations helped in having a better insight into the teaching practice between two groups of mathematics teachers in Croatia, PA and Math Teachers. The results indicate that it is reasonable to reflect on the programs for future mathematics teachers.

## References

- [1] BLÖMEKE, S., HSIEH, F. J., KAISER, G., & SCHMIDT, W. H. (2014), *International Perspectives on Teacher Knowledge, Beliefs and Opportunities to Learn: TEDS-M Results*, Dordrecht, The Netherlands: Springer.
- [2] BRETSCHER, N. (2014), *Exploring the Quantitative and Qualitative Gap Between Expectation and Implementation: A Survey of English Mathematics Teachers' Uses of ICT*, In A. Clark-Wilson, O. Robutti, & N. Sinclair (Eds.), *The Mathematics Teacher in the Digital Era* (pp. 43–70), Netherlands: Springer.
- [3] COHEN, L., MANION, L., & MORRISON, K. (2007), *Research Methods in Education*, Abingdon, UK: Routledge.
- [4] DOMOVIĆ, V., GLASNOVIĆ GRACIN, D. & JURČEC, L. (2012), *Uporaba matematičkih udžbenika s obzirom na inicijalno obrazovanje učitelja*, *Sociologija i prostor*, 50 (2), 237–256, in Croatian.
- [5] GAINSBURG, J. (2012), *Why new mathematics teachers do or don't use practices emphasized in their credential program*, *Journal of Mathematics Teacher Education*, 15 (5), 359–379.
- [6] GLASNOVIĆ GRACIN, D. (2011), *Requirements in mathematics textbooks and PISA assessment*, (Doctoral dissertation, University of Klagenfurt), Klagenfurt: University of Klagenfurt.
- [7] GUNNARSDÓTTIR, G. H., & GUÐBJÖRG, P. (2015), *Instructional Practices in mathematics classrooms*, Paper presented at 9<sup>th</sup> Congress of European Research in Mathematics Education, <http://www.cerme9.org/products/wg19/> [Accessed 03/16/2105].
- [8] HIEBERT, J., GALLIMORE, R., GARNIER, H., GIVVIN, K. B., HOLLINGSWORTH, H., JACOBS, J., et al. (2003), *Understanding and improving mathematics teaching: Highlights from the TIMSS 1999 video study*, *Phi Delta Kappan* 84 (10), 768–775.
- [9] HILL, H. C., BLUNK, M. L., CHARALAMBOUS, C. Y., LEWIS, J. M., PHELPS, G. C., SLEEP, L., & BALL, D. L. (2008), *Mathematical knowledge for teaching and the mathematical quality of instruction: An exploratory study*, *Cognition and Instruction*, 26 (4), 430–511.
- [10] Institut društvenih znanosti Ivo Pilar (2007), *Eksperimentalno vanjsko vrednovanje obrazovnih postignuća u osnovnim školama u Republici Hrvatskoj*, Zagreb: Institut društvenih znanosti Ivo Pilar, [http://dokumenti.ncvvo.hr/Dokumenti\\_centra/NI2007/izvjestaj-os07.pdf](http://dokumenti.ncvvo.hr/Dokumenti_centra/NI2007/izvjestaj-os07.pdf), [Accessed 2/12/2009]
- [11] JAWORSKI, B., & POTARI, D. (2009), *Bridging the macro- and micro-divide: Using an activity theory model to capture sociocultural complexity in mathematics teaching and its development*, *Educational Studies in Mathematics*, 72, 219–236.

- [12] JOHANSSON, M. (2006), *Teaching mathematics with textbooks: a classroom and curricular perspective*, Unpublished doctoral thesis. Luleå: Luleå University of technology.
- [13] LOVE, E. & PIMM, D. (1996), "This is so": a text on texts, In A. J. Bishop, K. Clements, C. Keitel, J. Kilpatrick, & C. Laborde (Eds.), *International handbook of mathematics education*, Vol. 1. (pp. 371–409), Dordrecht: Kluwer.
- [14] PATTON, M. Q. (1990), *Qualitative evaluation and research methods* (2nd ed.), Newbury Park, London, New Delhi: Sage Publications.
- [15] PEPIN, B. & HAGGARTY, L. (2001), *Mathematics textbooks and their use in English, French and German classrooms: a way to understand teaching and learning cultures*, *ZDM – The International Journal on Mathematics Education*, 33 (5), 158–175.
- [16] PONTE, J. P., & CHAPMAN, O. (2006), *Mathematics teachers' knowledge and practices*, In A. Gutierrez & P. Boero (Eds.), *Handbook of research on the psychology of mathematics education: Past, present and future* (pp. 461–494), Roterdham: Sense.
- [17] REMILLARD, J. T. (2009), *Considering what we know about the relationship between teachers and curriculum material*, In J. T. Remillard, B. A. Herbel-Eisenmann, & G. M. Lloyd (Eds.), *Mathematics teachers at work: Connecting curriculum materials and classroom instruction* (pp. 85–92), New York: Routledge.
- [18] REZAT, S. (2011), *Interactions of teachers' and students' use of mathematics textbooks*, In G. Gueudet, B. Pepin, & L. Trouche (Eds.), *From Text to 'Lived' Resources, Mathematics Curriculum Materials and Teacher Development* (pp. 231–246), New York: Springer.
- [19] ROBITAILLE, D. F., & GARDEN, R. A. (Eds.) (1989), *The IEA study of mathematics II: Context and outcomes of school mathematics*, Oxford: Pergamon Press.
- [20] SAXE, G. B. (1999), *Professional development, classroom practices, and students' mathematics learning: A cultural perspective*, In O. Zaslavsky (Ed.), *Proceedings of 23rd International Conference for the Psychology of Mathematics Education*, 3, 121–128, Haifa, Israel.
- [21] TATTO, M. T., SCHWILLE, J., SENK, S. L., INGVARSON, L., ROWLEY, G., PECK, R., BANKOV, K., RODRIGUEZ, M., & RECKASE, M. (2012), *Policy, practice, and readiness to teach primary and secondary mathematics in 17 countries: Findings from the IEA Teacher Education and Development Study in Mathematics (TEDS-M)*, Amsterdam: IEA.
- [22] VALVERDE, G. A., BIANCHI, L. J., WOLFE, R. G., SCHMIDT, W. H., & HOUANG, R. T. (2002), *According to the book – Using TIMSS to investigate the translation of policy into practice through the world of textbooks*, Dordrecht: Kluwer.

Contact addresses:

Ljerka Jukić Matić  
 Department of Mathematics  
 Josip Juraj Strossmayer University of Osijek  
 Trg Lj. Gaja 6, HR-31000 Osijek, Croatia  
 e-mail: ljukic@mathos.hr

Dubravka Glasnović Gracin  
 Faculty of Education, University of Zagreb  
 Savska cesta 77, HR-10000 Zagreb, Croatia  
 e-mail: dubravka.glasnovic@ufzg.hr

## **Kako hrvatski učitelji matematike organiziraju nastavu u višim razredima osnovne škole: razlike s obzirom na početno obrazovanje**

---

---

Ljerkica Jukić Matić<sup>1</sup> i Dubravka Glasnović Gracin<sup>2</sup>

<sup>1</sup>Odjel za matematiku, Sveučilište Josipa Jurja Strossmayera u Osijeku, Hrvatska

<sup>2</sup>Učiteljski fakultet, Sveučilište u Zagrebu, Zagreb, Hrvatska

*Sažetak.* Početno obrazovanje učitelja matematike važno je za podučavanje i učenje matematike u školskim učionicama. Neke studije pokazale su da postoji povezanost između obrazovnih postignuća učenika i učiteljevog matematičkog i pedagoškog znanja. U hrvatskom osnovnoškolskom obrazovanju postoje učitelji matematike koji se značajno razlikuju obzirom na početno obrazovanje. U ovom radu, ispitali smo nastavnu praksu dviju skupina učitelja matematike; onih koji su završili bivše pedagoške akademije i onih koji su stekli diplome sveučilišnih odjela za matematiku. Koristeći kvalitativne metode, opservacije i intervjue, istražili smo nastavnu praksu 12 učitelja matematike u višim razredima osnovne škole, s posebnim osvrtom na korištenje udžbenika. Rezultati su pokazali da se ove dvije skupine nastavnika razlikuju u korištenju udžbenika, ali i u nekim drugim dijelovima nastavne prakse.

*Ključne riječi:* učitelj matematike, početno obrazovanje, udžbenik, nastavna praksa, kvalitativna studija

# Structures of Croatian mathematics textbooks

---

---

Goran Trupčević\*<sup>1</sup> and Anđa Valent<sup>2</sup>

<sup>1</sup>Faculty of Teacher Education, University of Zagreb, Croatia

<sup>2</sup>University of Applied Sciences, Zagreb, Croatia

*Abstract.* Textbooks can be seen as a teaching tool with a wide potential use in school, but also as the intermediaries between the planned and implemented curriculum. They greatly affect the way in which the intended mathematical content is transformed into actions and educational opportunities inside classrooms. As such they are conceptualized as part of the potentially implemented curriculum in the TIMSS curriculum framework. Thus it is important to analyze the structure of textbooks in order to see the potential pedagogical implications.

We use TIMSS mathematics framework to study structure of textbooks for the last grade of secondary school in Croatia (Population 3 in TIMSS analysis). Also we try to investigate variability of these textbooks inside the timeframe of the past 20 years.

*Keywords:* TIMSS, textbooks, structure, mathematics, secondary school

## Introduction

Textbooks play an important role in every mathematics classroom. On one side, they are an important tool in teaching and learning mathematics. Especially since mathematics learning in schools is mostly done through solving different types of exercises that exemplify various mathematical concepts and build connections between them. In this sense, they are student books. On the other side, textbooks can also be viewed as teacher books. They often represent a model of content selection and presentation, as well as a model of teaching, exercise and activities selection. Through this they influence the actual teaching that goes on in the classroom (Pepin & Haggarty, 2001; Glasnović Gracin & Domović, 2009; Domović, Glasnović Gracin & Jurčec, 2012). For this reasons, it would be interesting to describe the structure of mathematics textbooks.

---

\*Corresponding author.



## Literature review

Field of mathematics textbook research is a rich area of investigation. One can study their discourse, their structure, content (and its course of development), cognitive demands of exercises, usage inside classrooms, etc. There are also numerous international studies and comparisons of mathematics textbooks in different countries. For a detailed overview of research on this subject we turn the reader to papers of Glasnović-Gracin (2014) and of Fan, Zhu & Miao (2013). Different studies on the usage of mathematics textbooks in classrooms have shown a great impact textbooks have on actual teaching that goes on in schools (Pepin & Haggarty, 2001; Haggarty & Pepin, 2002; Fan & Kaeley, 2000). This is also the case in Croatian classrooms, at least at the level of primary schools (Glasnović Gracin & Domović, 2009; Domović, Glasnović Gracin & Jurčec, 2012; Glasnović Gracin & Jukić Matić, 2014).

As we have said earlier, an analysis of textbook structure can give an idealized vision of actual teaching in classrooms. Rezat's (2006) analysis of microstructure of eight German mathematics textbooks describes their typical elements and their sequencing in different textbooks. Furthermore he compares these with the two dominant German theories of instruction – Herbart's formal theory of instruction and Roth's model of the learning process. Herbart's theory divides instruction into the following six steps: objective, preparation, presentation, association (assimilation), generalization (conceptualization) and application. Roth's model has the following six phases: motivation, difficulties (cognitive dissonance), solution (with scaffolding), execution, memorizing and practising and integration. The analysis revealed that the structure of German textbooks follows the structure of Herbart's theory. Only two textbooks combined Herbartian elements with elements of difficulties and solution that are central to Roth's theory.

In the study that analyzed educational systems, textbook structure and teaching in three different countries – France, Germany and England (Pepin & Haggarty, 2001; Haggarty & Pepin, 2002), there were found differences in textbook structures in three traditions. In French textbooks every section was divided into three parts: introductory activities (investigations, practical or cognitive activities), the main part with worked examples, and exercises. In German textbooks sections started with introductory exercises, followed by the main part together with worked examples and ending with exercises, which represent the majority of the section. These textbooks were complex and coherent, especially regarding mathematical logic and structure, but they also appeared “dry” in presentation. In English textbooks sections start with introduction to new ideas and techniques, followed by worked examples and exercises. Most of the exercises asked for an application of demonstrated routines, and rarely required more complex cognitive processes, in which case they were marked as more demanding. The main difference between French textbooks and the German and English ones were the activities parts. Pepin and Haggarty (2001) argued that this “softer” approach to teaching mathematics draws on “Piaget's notions of constructivism and their associated teaching approaches” (Pepin and Haggarty, 2001, p. 167).

As a part of the Third International Mathematics and Science Study, a comprehensive cross-national study of mathematics and science textbooks from 48 countries has been carried (Valverde et al., 2002). In their model they view textbooks as mediators between intended and implemented curriculum. Hence their study of curriculum assumes four-parts model – the intended, potentially implemented, implemented and attained curriculum. To describe a textbook as a part of potentially implemented curriculum their analytical framework considers its macrostructure (size, length, dots) but also a complex description of textbook microstructure or “morphology”. For this, they have sequenced a textbook into separate blocks which are then coded by block type, mathematical content, presentation expectations and a wider perspective on the subject. In this way they have described wide variations in textbook structures across different school systems.

### **Croatian secondary educational system**

Secondary education in Croatia is organized through two types of schools: grammar schools (gymnasiums), which prepare students for university, and vocational secondary schools. Grammar schools are further divided into general, philological, classical, science oriented and mathematics and science oriented. The main curricular document for grammar schools is the Curricular outlines written in 1994 (Nastavni progami za gimnazije, 1994). It allocates 3-4 hours per week for mathematics in general, philological, science oriented and classical grammar schools, and for the mathematics and science oriented grammar schools it allocates 4 hours per week in the first two grades, and 5 hours per week in the last two grades. Curricular outlines mainly prescribes mathematical themes that are supposed to be covered in each grade, with scarce reference to other learning outcomes (affective, metacognitive, mathematical processes). In the fourth grade, students are supposed to learn the basic notions of calculus (numbers, sequences, functions, derivations, calculation of area and integration).

### **Research question**

In this study we examine the following question: *What is the structure of Croatian mathematical textbooks intended for the fourth grade of mathematics and science grammar schools, and what are the possible pedagogical implications of their structure?*

### **Methodology**

For the analysis, we have chosen three textbooks written after the adoption of the Course of study in 1994. These are

1. Kraljević, Šikić. (1995).
  - a. Matematika IV: brojevi, funkcije, infinitezimalni račun, udžbenik za četvrti razred gimnazija i tehničkih škola. Zagreb: Profil.

- b. Matematika IV: brojevi, funkcije, infinitezimalni račun, zbirka zadataka za četvrti razred gimnazija i tehničkih škola. Zagreb: Profil.
2. Antoliš, Copić. (2007). Matematika 4, udžbenik sa zbirkom zadataka za četvrti razred prirodoslovno-matematičke gimnazije. Zagreb: Školska knjiga.
3. Dakić, Elezović. (2014). Matematika 4, udžbenik sa zbirkom zadataka za četvrti razred prirodoslovno-matematičke gimnazije. Element. Zagreb.

All three textbooks were published by major publishing companies. We chose to look at the differences between books from different authors rather than looking at differences between different editions of the book by the same authors. We believed that this kind of analysis will reveal wider range of possible structures of textbooks. However, it would be interesting to analyze the differences between different editions of the same publisher. We leave this problem for future work.

We have not analyzed the whole books, but have chosen to focus only on the chapters on functions and derivations. We chose these chapters because we have expected that these two topics could offer opportunities for richer treatment regarding context and student activities.

To address the research question, we adopt the TIMSS analytical framework described by Valverde et al. (2002). We divide each section into smaller functional units called blocks, which present the basic unit of analysis. Each block is described from several aspects – its type, content and performance expectation. The first variable determines the rhetorical strategy of the block (narrative, graphical, exercise set, worked example, etc.). The second variable describes mathematical content presented in the block. The last variable describes what could be expected of students to do with the presented content. The categories for these variables are listed in a TIMSS Mathematical Framework document (Valverde et al. (2002); Robitaille et al. (1993)). We have slightly adapted these categories by adding a category “kernel” for block type, modeled on Rezat’s analysis of textbook structure (2007). We list these categories in the Appendix A of this paper.

## Results

First, we describe qualities of each textbook.

### 1. Kraljević, Šikić (1995)

In this textbook functions and derivations have been covered through three chapters, in sections 3.1–3.3, 5.1–5.3, 7.1, and 7.3. Total number of blocks registered was 338. Each section starts with a narrative block typically followed by alternating between narrative blocks, examples and exercises. Unlike with other textbooks, in this one exercise are in a separate book, so these blocks were treated

as if they were placed at the end of each unit. Most of the book is written in form of blocks of the following types: narrative, graphics, exercises and worked examples. Sections are regularly starting with a narrative block, followed by alternating narrative parts, worked examples and exercises. Most of the content of the observed sections concerns topics on functions, limits and derivations with some parts that are connected with coordinate geometry. Most of the textbook requires of a student to read and recall information or to perform a simple or routine procedure. More complex performances are not regularly required, and are more often elicited in sections on applications of derivatives to problems situated in context.

## **2. Antoliš, Copic (2007)**

Topics on functions and derivations were covered in this textbook in two chapters, chapters 6 and 7. Chapter 6 is subdivided into five sections, and chapter 7 into four sections. Last sections of both chapters contain sets of exercises and a chapter summary. A typical section from this book starts with a motivational example. The rest of the section is further subdivided into subsections which regularly contain narrative part, examples and a small exercise block. Each section ends with a set of exercises. Total number of blocks detected in this textbook was 638. Most of the content concerns topics on functions, limits and derivations, whilst other topics are rarely touched upon. As for the performance expectations, knowing and performing procedures dominate the whole book, and more complex performances are very rarely required, and are usually situated in the final parts of sections.

## **3. Dakić, Elezović (2014)**

This textbook also covers topics on functions and derivations in two chapters, chapters 5 and 6. Chapter 5 is divided into seven sections, and chapter 6 into nine. Sections regularly start with a narrative block, followed by alternating narrative parts, worked examples, and only occasionally exercises. Sections end with sets of exercises. In the analyzed part we have distinguished 637 blocks. Like in Kraljević and Šikić (1995) book, most of the content covers topics on functions, limits and derivations, which are sometimes connected with coordinate geometry. Most of the book requires a student to understand the material or to perform simple or complex procedures, but there is also a considerable amount of blocks that require more complex mathematical performances. These blocks are settled in the last part of sections that contain exercises set of various complexity.

Figures 1-3 illustrate the spatial dynamics of block type, content and performance expectations over the length of these books (or what Valverde et al. (2002) call morphology of textbooks).

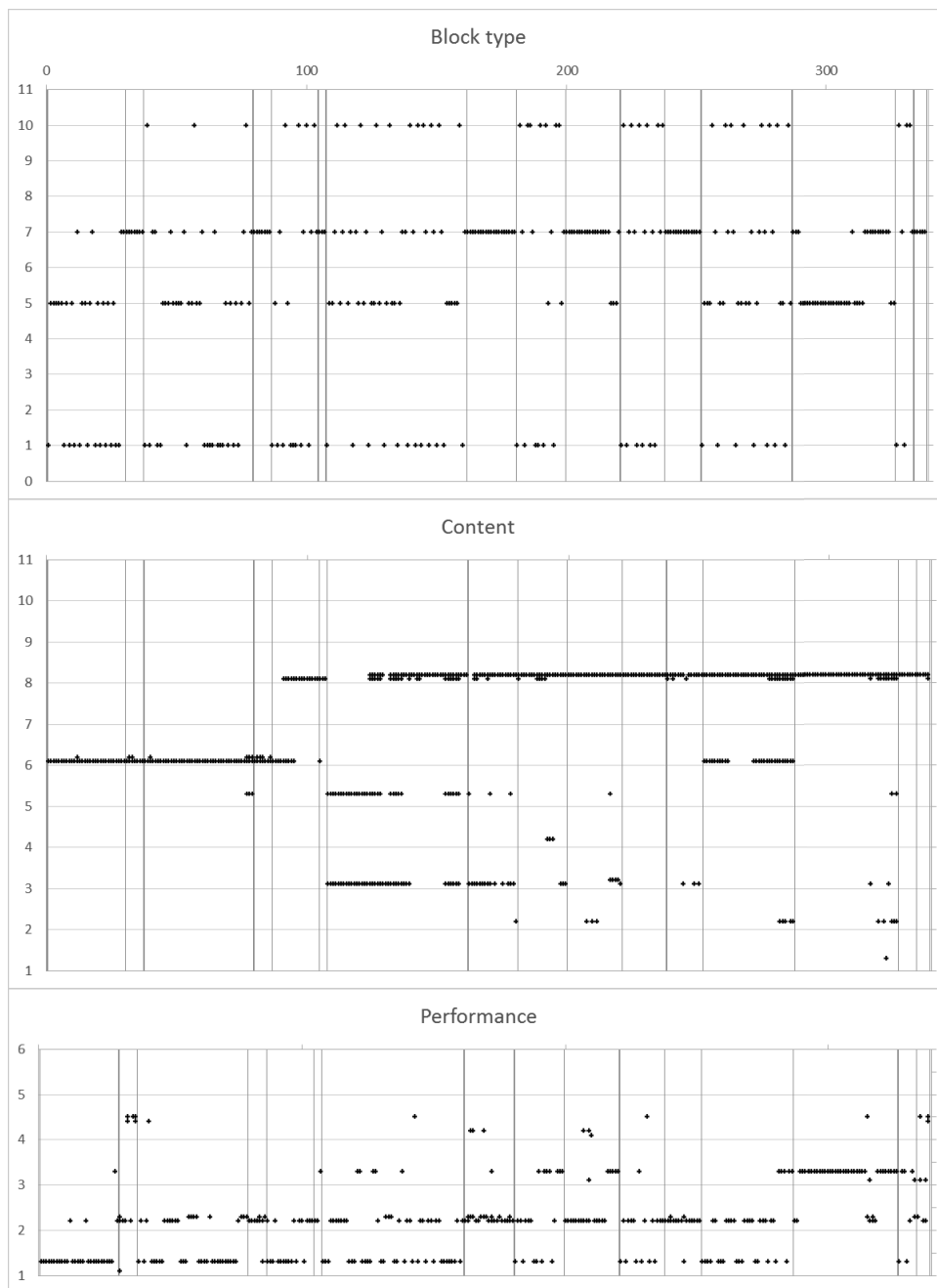

Figure 1. Schematic representation of structure of Kraljević, Šikić (1995) textbook.

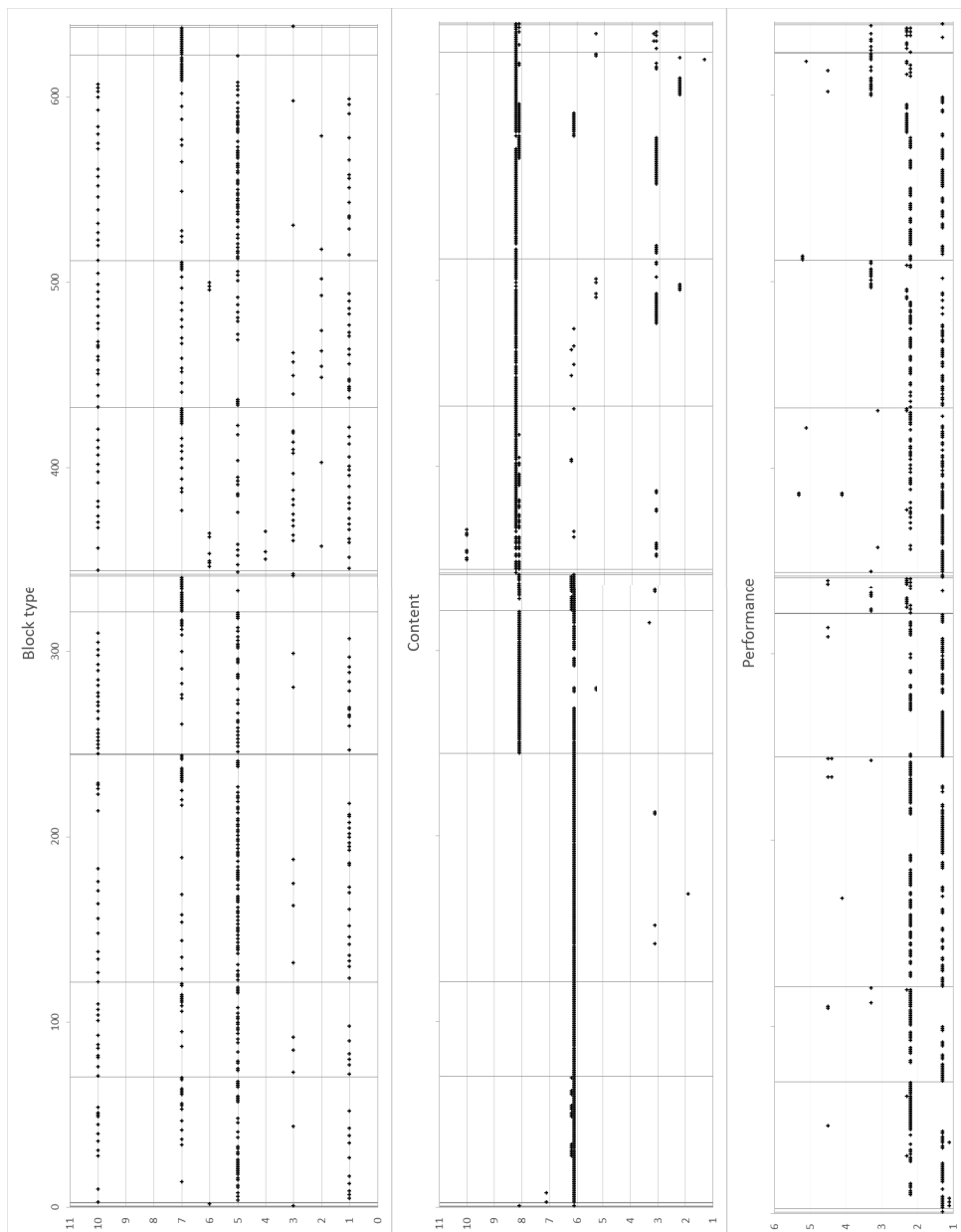

Figure 2. Schematic representation of structure of Antoliš, Copic (2007) textbook.

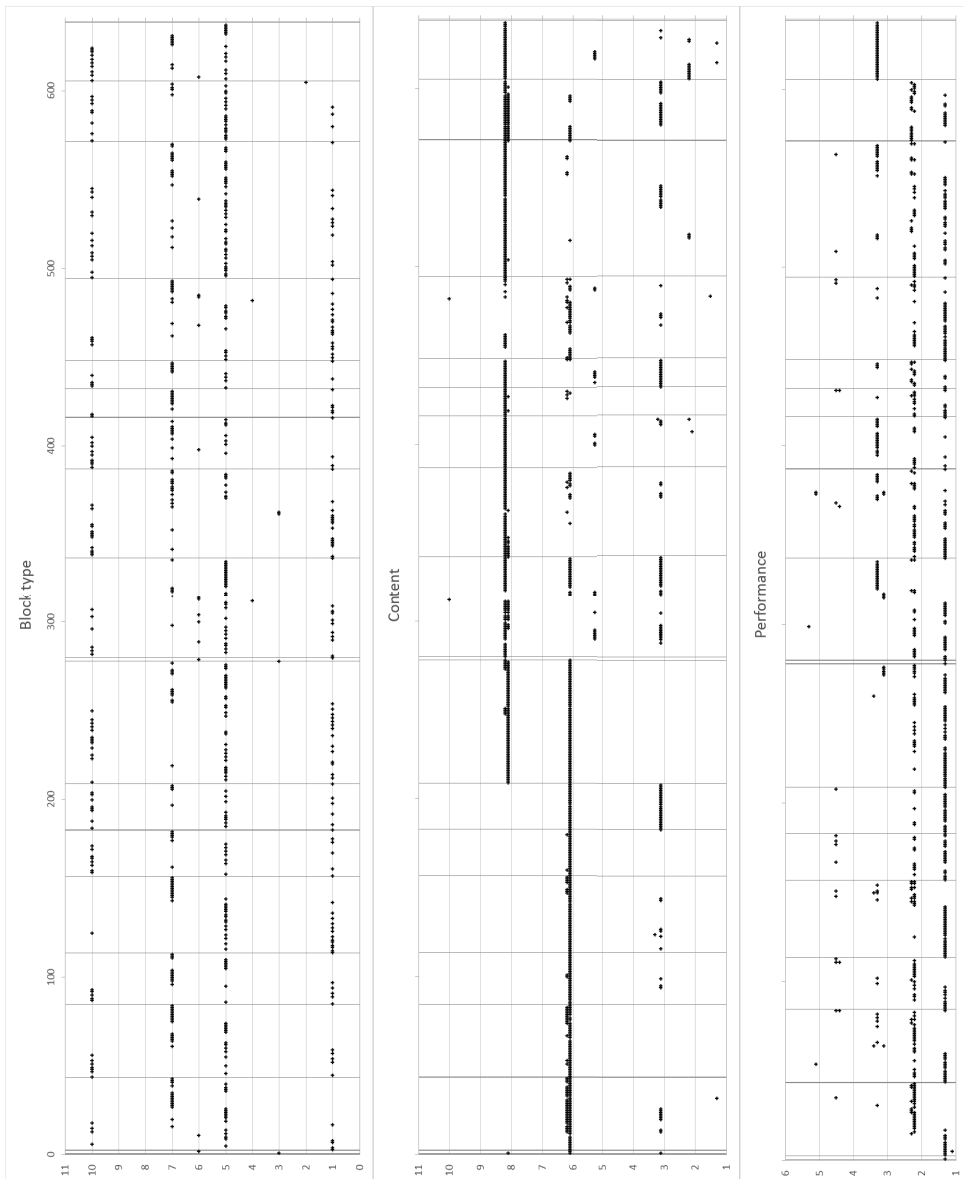

Figure 3. Schematic representation of structure of Dakić, Elezović (2014) textbook.

Table 1 shows overall comparisons of textbooks based on block types, content and performance expectation. When we consider block types, we see that narratives, graphics, exercises and worked examples prevail in all three textbooks. What needs to be taken into consideration is that some worked examples in textbooks are really narratives (e.g. calculation of certain formulas for derivation, etc.). Content topics in all three books is similar, concentrated on functions and derivations, with Kraljević, Šikić (1995) and Dakić, Elezović (2014) books more explicitly connect-

ing these with coordinate geometry. As for performance expectations, knowing and procedures prevail in all three books, with complex performances elicited more often in Kraljević, Šikić (1995) and Dakić, Elezović (2014).

*Table 1.* Overall structure of textbooks (percentages are given with respect to the total number of blocks in a given textbook).

		KŠ	AC	DE
Block type	Narrative	20.12%	15.20%	18.52%
	Graphics	27.81%	35.11%	35.32%
	Exercise set	39.64%	23.67%	24.93%
	Worked examples	12.43%	17.08%	17.90%
Content	Coordinate geometry	18.05%	11.60%	22.61%
	Functions	36.09%	52.66%	54.63%
	Equations and formulas	3.25%	5.96%	10.99%
	Infinite processes	19.82%	25.08%	19.62%
	Change	62.13%	42.48%	50.24%
Performance expectation	Knowing	35.21%	47.02%	44.58%
	Procedures	47.04%	50.31%	41.60%
	Problem solving	20.12%	6.90%	18.68%
	Mathematical reasoning	5.33%	2.51%	3.30%
	Communicating	0%	1.10%	1.10%

## Discussion and conclusion

The aim of our study was to examine and compare the structure of Croatian mathematical textbooks intended for the fourth grade of mathematics and science grammar schools. Our analysis shows that the structure of Croatian textbooks is similar to the German ones (Rezat, 2006; Pepin and Haggarty, 2001; Haggarty and Pepin, 2002) which means that a typical section starts with the exposition of section theme through narrative parts and worked examples followed by the set of exercises. It is expected from students to read and recall information and practice procedures. We did not register investigations elements typical for French textbooks (Pepin and Haggarty, 2001; Haggarty and Pepin, 2002) whose purpose is to engage the students more actively and to motivate the students to pose and deal with so far unknown problems. From schematic representations of analyzed textbooks it is evident that higher performance expectations are usually moved to the very end of sections and chapters. If they want to offer to their students opportunities to engage in more complex performances, teachers need to include these problems into their lessons.

We haven't found a significant time trend in the structure of Croatian mathematics textbooks. Hence, we believe that reasons for differences between structures of observed textbooks are of more complex nature. It would be interesting to see what kind of results one would obtain when comparing these textbooks with textbooks issued before the last change of curriculum in 1994.



## Appendix A

List of codes adapted from Valverde et al. 2002.

Block type	
1. Narrative	7. Exercise Set
2. Related Narrative	8. Unrelated Exercise Set
3. Kernel	9. Activity
4. Unrelated Instructional Narrative	10. Worked example
5. Related Graphic	11. Other
6. Unrelated Graphic	
Content	
1 Numbers	3 Geometry: Position, visualization, and shape
1.1 Whole numbers	3.1 Two-dimensional geometry: Coordinate geometry
1.1.1 Meaning	3.2 Two-dimensional geometry: Basics
1.1.2 Operations	3.3 Two-dimensional geometry: Polygons and circles
1.1.3 Properties of operations	3.4 Three-dimensional geometry
1.2 Fractions and decimals	3.5 Vectors
1.2.1 Common fractions	4 Geometry: Symmetry, congruence, and similarity
1.2.2 Decimal fractions	4.1 Transformations
1.2.3 Relationships of common and decimal fractions	4.2 Congruence and similarity
1.2.4 Percentages	4.3 Constructions using straightedge and compass
1.2.5 Properties of common and decimal fractions	5 Proportionality
1.3 Integer, rational, and real numbers	5.1 Proportionality concepts
1.3.1 Negative numbers, integers, and their properties	5.2 Proportionality problems
1.3.2 Rational numbers and their properties	5.3 Slope and trigonometry
1.3.3 Real numbers, their subsets, and their properties	5.4 Linear interpolation and extrapolation
1.4 Other numbers and number concepts	6 Functions, relations, and equations
1.4.1 Binary arithmetic and/or other number bases	6.1 Patterns, relations, and functions
1.4.2 Exponents, roots, and radicals	6.2 Equations and formulas
1.4.3 Complex numbers and their properties	7 Data representation, probability, and statistics
1.4.4 Number theory	7.1 Data representation and analysis
1.4.5 Counting	7.2 Uncertainty and probability
1.5 Estimation and number sense	8 Elementary analysis
1.5.1 Estimating quantity and size	8.1 Infinite processes
1.5.2 Rounding and significant figures	8.2 Change
1.5.3 Estimating computations	9 Validation and structure
1.5.4 Exponents and orders of magnitude	9.1 Validation and justification
2 Measurement	9.2 Structuring and abstracting
2.1 Units	10 Other content
2.2 Perimeter, area, and volume	10.1 Informatics
2.3 Estimation and errors	
Performance Expectations	
1 Knowing	4 Mathematical reasoning
1.1 Representing	4.1 Developing notation and vocabulary
1.2 Recognizing equivalents	4.2 Developing algorithms
1.3 Recalling mathematical objects and properties	4.3 Generalizing
2 Using routine procedures	4.4 Conjecturing
2.1 Using equipment	4.5 Justifying and proving
2.2 Performing routine procedures	4.6 Axiomatizing
2.3 Using more complex procedures	5 Communicating
3 Investigating and problem solving	5.1 Using vocabulary and notation
3.1 Formulating and clarifying problems and situations	5.2 Relating representations
3.2 Developing strategy	5.3 Describing/discussing
3.3 Solving	5.4 Critiquing
3.4 Predicting	
3.5 Verifying	

## References

- [1] ANTOLIŠ, COPIĆ (2007), *Matematika 4*, udžbenik za četvrti razred prirodoslovno-matematičke gimnazije, Zagreb: Školska knjiga.
- [2] DAKIĆ, B., ELEZOVIĆ, N. (2014), *Matematika 4*, udžbenik za četvrti razred prirodoslovno-matematičke gimnazije, Element, Zagreb.
- [3] DOMOVIĆ, V., GLASNOVIĆ GRACIN, D., & JURČEC, L. (2012), *Use of Mathematical Textbooks with Regard to Sex and Years of Service of Mathematics Teachers*, Napredak: časopis za pedagoškijsku teoriju i praksu 153 (2), 187–202.
- [4] FAN, L., & KAELEY, G. S. (2000), *The influence of textbooks on teaching strategies: An empirical study*, Mid-Western Educational Researcher, 13 (4), 2–9.
- [5] FAN, L., ZHU, Y., & MIAO, Z. (2013), *Textbook research in mathematics education: development status and directions*, ZDM: The International Journal on Mathematics Education, 45 (5), 633–646.
- [6] GLASNOVIĆ GRACIN, D. (2014), *Mathematics Textbook as an Object of Research*, Croatian journal of education 16 (3), 211–237.
- [7] GLASNOVIĆ GRACIN, D. & DOMOVIĆ, V. (2009), *Using maths textbooks in lower secondary education*, Odgojne znanosti 11 (2), 297–317.
- [8] GLASNOVIĆ GRACIN, D., & JUKIĆ MATIĆ, LJ. (2014), *Schulbuch als Teil des implementierten Curriculums*, 48. Jahrestagung der Gesellschaft für Didaktik der Mathematik, Koblenz, 431–435.
- [9] HAGGARTY, L., & PEPIN, B. (2002), *An Investigation of Mathematics Textbooks and Their Use in English, French and German Classrooms: Who Gets an Opportunity to Learn What?*, British Educational Research Journal, 28 (4), 567–590.
- [10] KRALJEVIĆ, H., ŠIKIĆ, Z. (1995), *Matematika 4*, udžbenik za četvrti razred prirodoslovno-matematičke gimnazije, Zagreb: Profil.
- [11] KRALJEVIĆ, ŠIKIĆ (1995), *Matematika 4*, zbirka zadataka za četvrti razred prirodoslovno-matematičke gimnazije, Zagreb: Profil.
- [12] NASTAVNI PROGRAMI ZA GIMNAZIJE, (1994), Glasnik Ministarstva kulture i prosvjete.
- [13] PEPIN, B., & HAGGARTY, L. (2001), *Mathematics textbooks and their use in English, French and German classrooms: A way to understand teaching and learning cultures*, ZDM: The International Journal on Mathematics Education, 33 (5), 158–175.
- [14] REZAT, S. (2006), *The structure of German mathematics textbooks*, ZDM: The International Journal on Mathematics Education, 38 (6), 482–487.
- [15] ROBITAILLE, D. F., MCKNIGHT C., SCHMIDT, W. H., BRITTON, E., RAIZEN, S. & NICOL, C. (1993), *Curriculum frameworks for mathematics and science*, TIMSS monograph No. 1, Vancouver: Pacific Educational Press.
- [16] VALVERDE, G. A., BIANCHI, L. J., WOLFE, R. G., SCHMIDT, W. H., & HOUANG, R. T. (2002), *According to the book: Using TIMSS to investigate the translation of policy into practice through the world of textbooks*, Dordrecht: Kluwer.

Contact addresses:

Goran Trupčević  
Faculty of Teacher Education  
University of Zagreb  
Savska cesta 77, Zagreb, Croatia  
e-mail: goran.trupcevic@ufzg.hr

Anđa Valent  
University of Applied Sciences  
Konavoska 2, Zagreb, Croatia  
e-mail: avalent@tvz.hr

## Strukture hrvatskih matematičkih udžbenika

---

---

Goran Trupčević<sup>1</sup> i Anđa Valent<sup>2</sup>

<sup>1</sup>Učiteljski fakultet, Sveučilište u Zagrebu, Hrvatska

<sup>2</sup>Tehničko veleučilište u Zagrebu, Hrvatska

*Sažetak.* Na udžbenike se može gledati kao na nastavno sredstvo s širokom potencijalnom upotrebom u školi, ali i kao na posrednike između planiranog i provedenog kurikula. Oni u velikoj mjeri utječu na način na koji se planirani matematički sadržaj transformira u događanja i obrazovne prilike unutar učionice. Kao takve ih se, unutar TIMSS-ovog konceptualnog okvira za istraživanje kurikula, smatra kao dio potencijalno provedenog kurikula. Stoga je važno analizirati strukture udžbenika kako bi otkrili njihove potencijalne pedagoške implikacije.

Koristeći TIMSS-ov analitički okvir za područje matematike, proučavamo strukture udžbenika za posljednji razred srednje škole u Republici Hrvatskoj (populacija 3 u TIMSS-ovoj analizi). Također ćemo istražiti varijabilnost tih udžbenika unutar posljednjih 20 godina.

*Ključne riječi:* TIMSS, udžbenici, struktura, matematika, srednja škola



## Index

---



---

- Abdullah, H. H. , 110  
 Abdullah, Z. , 100  
 Adams, B. , 56  
 Adey, P. , 299  
 Adihou, A. , 201  
 Ahmad, N. , 110  
 Akgun, O. E. , 127  
 Amabile, T. M. , 297, 298  
 Anderman, E. M. , 185  
 Andrei, C. , 126  
 Andrews, F. M. , 297  
 Andrews, P. , 183  
 Angel, E. , 92  
 Anić, V. , 183  
 Ansell E. , 56  
 Anthony, G. , 4  
 Antoliš, N. , 328  
 Apte, C. , 110  
 Arambašić, L. , 174, 183  
 Argün, Z. , 224  
 Armstrong, P. I. , 301  
 Aschraft, M. H. , 183  
 Asghar, K. , 110  
 Asmus, C. , 299  
 Avram, E. M. , 110  
 Ayub, A. F. M. , 126  
 Azevedo, I. , 299  
 Bölcskei, A. , 247  
 Baer, J. , 297, 299  
 Baesens, B. , 126  
 Bahleda, M. , 300  
 Bai, H. , 127  
 Bakar, K. A. , 126  
 Bakhshalizadeh, S. , 299  
 Ball, D. L. , 5, 315  
 Baloğlu, M. , 277  
 Bandura, A. , 184  
 Bankov, K. , 316  
 Baradwaj, B. K. , 110  
 Barnes, M. , 236  
 Batanero, C. , 276, 277  
 Bateson, P. , 297  
 Batiste, S. J. , 127  
 Battista, M. T. , 224, 236  
 Beban-Brkić, J. , 261  
 Beecroft, H. , 255  
 Beghetto, R. A. , 297  
 Behzad, M. , 110  
 Belavić, D. , 139  
 Bell, B. , 148  
 Benček, A. , 174  
 Benbow, C. P. , 301  
 Benet, M. , 300  
 Bergner, J. A. , 277  
 Bergqvist, E. , 4  
 Bergqvist, T. , 4  
 Bianchi, L. J. , 316, 328  
 Biggs, B. T. , 185  
 Bishop, A. J. , 236  
 Blömeke, S. , 5, 281, 315  
 Blanco, L. J. , 236  
 Blanco, M. , 139  
 Blunk, M. L. , 315  
 Boesen, J. , 4  
 Bognar, L. , 184  
 Bolden, D. S. , 298  
 Bosanac, N. , 162  
 Bosch, P. , 127  
 Boud, D. , 148  
 Bramwell-Rejskind, G. , 299  
 Brenneman, K. , 201  
 Bretscher, N. , 315  
 Brindley, S. , 183  
 Britton, E. , 328  
 Brookhart, S. , 224  
 Brumec, M. , 140  
 Bruner, J. S. , 80  
 Bulut, S. , 224  
 Buyukozturk, S. , 127  
 Byrnes, J. P. , 298  
 Cakan, H. , 127  
 Cakmak, E. K. , 127  
 Cannataro, M. , 110  
 Carless, D. , 149  
 Carling, E. , 92  
 Carlson, M. P. , 224  
 Carroll, J. B. , 69  
 Carpenter T. P. , 56, 255  
 Carson, S. , 298  
 Casey, R. , 184  
 Castillo, J. , 127  
 Cepeda, N. J. , 92  
 Chan, D. , 298  
 Chan, L. K. , 298  
 Chang, C. C. , 110  
 Chapman, O. , 316  
 Charalambous, C. Y. , 315  
 Chavez, A. , 185  
 Cheng, S. , 110  
 Chick, H. L. , 276  
 Christou, C. , 224  
 Cindrić, M. , 56, 174

- Ciosek, M. , 38  
 Clarke, D. , 224  
 Clements, D. H. , 201, 236  
 Cobb, P. , 276  
 Cocea, M. , 126  
 Cockburn, A. D. , 38  
 Cohen, L. , 315  
 Collins, A. M. , 224  
 Conti, R. , 298  
 Coomans, D. , 110, 127  
 Coon, H. , 298  
 Copic, A. , 328  
 Cowie, B. , 148  
 Cramer, K. , 80  
 Cramp, A. , 149  
 Cropley, A. J. , 39  
 Csikos, Cs. , 69  
 Cszikszentmihalyi, M. , 298  
 Čuvidić, M. , 140  
 D' Ambrosio, U. , 184  
 Dakić, B. , 328  
 Davis, N. , 149  
 De Corte, E. , 224  
 Debrenti, E. , 69  
 Dejaeger, K. , 126  
 delMas, R. C. , 277  
 Demircioğlu, H. , 224  
 Demirel, F. , 127  
 Deniz, M. E. , 277  
 Deris, M. M. , 110  
 Diakidoy, I. N. , 298  
 Diaz, C. , 277  
 Dietiker, L. , 277  
 Divjak, B. , 140  
 Dobi Barišić, K. , 140, 149  
 Doering, A. , 149  
 Dogan, N. , 128  
 Domović, V. , 315, 328  
 Dreyfus, T. , 69  
 Dubovicki, S. , 184  
 Duval, R. , 236  
 Đeri, I. , 110, 149  
 Đurđević Babić, I. , 110  
 Đurđević, I. , 110, 140  
 Eazi, M. , 110  
 Edu, T. , 110  
 Eiduson, B. T. , 298  
 Eisenberg, T. , 69  
 Elezović, N. , 328  
 Ellerton, N. F. , 226  
 Ellison, N. B. , 126  
 Erdős, E. , 127  
 Ernest, P. , 184  
 Estrada, A. , 277  
 Evans, C. , 149  
 Fábíán, M. , 69  
 Falk-Fruhbrodt, C. , 201  
 Fan, L. , 328  
 Feiler, R. , 201  
 Feingold, A. , 298  
 Feist, G. J. , 298  
 Feldhusen, J. F. , 298  
 Fennema E. , 56  
 Fernández-Alonso, R. , 127  
 Fernandes de Carvalho, C. , 277  
 Fidalgo, P. , 140  
 Findell, B. , 56  
 Flavell, J. H. , 224  
 Fortuny, J. M. , 277  
 Franke M. L. , 56  
 Frede, E. C. , 201  
 Freeman, D. , 224  
 Freudenthal, H. , 56, 236  
 Fry, J. , 185  
 Gagne, R. , 80  
 Gainsburg, J. , 315  
 Gal, I. , 277  
 Gale, V. , 149  
 Gallimore, R. , 315  
 Garaigordobil, M. , 298  
 García, E. , 111  
 García, T. , 127  
 Garcia, J. , 80  
 Garden, R. A. , 316  
 Garfield, J. , 277  
 Garnier, H. , 315  
 Garofalo, J. , 244  
 Gasco, J. , 126  
 Gavrilov-Jerković, V. , 236  
 Geist, E. , 184  
 Gerek, I. H. , 127  
 Gheen, M. , 185  
 Giangreco, A. , 126  
 Giesecke, H. , 184  
 Gikandi, J. , 149  
 Gilbert, L. , 149  
 Ginovart, M. , 139  
 Ginsburg, L. , 277  
 Githua, B. N. , 126  
 Givvin, K. B. , 315  
 Glăveanu, V. P. , 298  
 Glasnović Gracin, D. , 277, 315, 328  
 Gliga, L. , 184  
 Goñi, A. , 126  
 Goethals, F. , 126  
 Goldin, G. , 69  
 Goldstein, I. , 183  
 Gong, W. , 110  
 Gorunescu, F. , 127  
 Gosset, T. , 255  
 Graham, T. , 225  
 Grayson, H. , 224  
 Greeno, J. G. , 224  
 Greer, B. , 224  
 Griffiths, M. , 80  
 Groth, R. E. , 277  
 Guðbjörg, P. , 315  
 Guastello, S. J. , 298  
 Gudjons, H. , 184

- Gunnarsdóttir, G. H. , 315  
Gutiérrez, A. , 255  
Guzzi, P. H. , 110  
Haapasalo, L. , 38, 80  
Habud-Korbar, A. , 162  
Hadžić-Suljkić, M. , 174  
Haggarty, L. , 316, 328  
Han, J. , 110, 111  
Han, K. , 298  
Hanaysha, J. , 110  
Harasim, L. , 149  
Harries, T. V. , 298  
Hart, K. M. , 56  
Hartas, D. , 38  
Hast, A. , 92  
Hazeltine, E. , 237  
Healy, L. , 224  
Hegarty, M. , 70  
Hembree, R. , 184  
Herawan, T. , 110  
Hershkovitz, A. , 127  
Heshkowitz, R. , 237  
Hiebert, J. , 56, 80, 184, 315  
Higgins, D. M. , 298  
Hill, H. C. , 5, 315  
Hirumi, A. , 127  
Ho, S. Y. , 236  
Hodnik Čadež, T. , 39  
Hollingsworth, H. , 315  
Hong, K. S. , 110  
Horvath, A. , 277  
Houang, R. T. , 316, 328  
Howard-Jones, P. A. , 298  
Hoyles, C. , 224  
Hoyos, V. , 185  
Hsieh, F. J. , 5, 281, 315  
Hsu, C. W. , 110  
Hu, W. , 299  
Hyde, J. S. , 299  
Ibrahimpašić, B. , 80  
Ingvarson, L. , 237, 316  
Ishak, S. , 111  
Ivčević, Z. , 274  
Ivcevic, Z. , 299  
Izabela, V. P. , 126  
Jacobbe, T. , 277  
Jacobs, J.,, 315  
James, K. , 299  
Jaworski, B. , 315  
Jerković, I. , 236  
Johansson, M. , 316  
Jugo, G. , 140  
Jukić Matić, L. , 149, 328  
Jukić Matić, Lj. , 140, 328  
Jurčec, L. , 315, 328  
Jurčić, M. , 184  
Jurado, R. G. , 100  
Köse, N. Y. , 225  
Kadijevich, Dj. , 80  
Kaeley, G. S. , 328  
Kaiser, G. , 5, 281, 315  
Kamber, M. , 110  
Kamruzzaman, S. M. , 111  
Kaput, J. , 69  
Karadeniz, S. , 127  
Katona, J. , 247  
Kaufman, J. C. , 299, 300  
Kazan, E. E. , 127  
Kebritchi, M. , 127  
Kelemen, R. , 69  
Kesici, Ş. , 277  
Kilpatrick, J. , 56, 184  
Kimberling, C. , 261  
Kinney, D. K. , 300  
Kirkley, J. , 38  
Klages, C. , 185  
Klibanoff, R. S. , 201  
Kolak, A. , 184  
Kolar-Begović, Z. , 261  
Kolar-Šuper, R. , 261  
Kor, L. K. , 225  
Kosheleva, O. , 225  
Koshy, V. , 184  
Kozhevnikov, M. , 70  
Kraljević, H. , 328  
Kruetskii, V. A. , 38  
Kurz, T. , 80  
Kuzle, A. , 224, 225  
Laborde, C. , 225  
Laine, A. , 39  
Lajos, J. , 69  
Lampe, C. , 126  
Lancaster, S. , 277  
Lanciano, N. , 237  
Lapointe, J. M. , 127  
Lefevre, P. , 56, 80  
Legault, F. , 127  
Lekka, A. , 277  
Lester, F. K. , 224, 281  
Lewis, J. M. , 5, 315  
Libeskind, S. , 225  
Lilly, F. R. , 299  
Lin, C. J. , 110  
Lindquist, M. M. , 184  
Linn, M. C. , 299  
Lipowsky, F. , 5  
Lithner, J. , 4  
Liu, X. , 127  
Livne, N. L. , 299  
Lloyd, A. M. A. , 299  
Love, E. , 316  
Luan, W. S. , 126  
Lubart, T. I. , 301  
Lubinski, D. , 299, 301  
Ma, L. , 56  
Maimon, O. , 127  
Maj-Tastis, B. , 38  
Majcen, M. , 184  
Makar, K. , 225  
Maker, C. J. , 300  
Malaspina, U. , 5

- Manfreda Kolar, V. , 39  
 Manion, L. , 315  
 Mareníć, M. , 174  
 Markovac, J. , 174  
 Marrades, R. , 225  
 Matijević, M. , 184  
 Matotek, D. , 162  
 Matotek, J. , 140  
 Mayer, R. , 70  
 Mayer, R. E. , 225  
 McClain, K. , 276  
 McKeachie, W. J. , 127  
 McKnight C. , 328  
 Merzel, A. P. , 300  
 Meyer, D. K. , 185  
 Mišurac Zorica, I. , 56, 174  
 Miao, Z. , 328  
 Midgley, C. , 185  
 Mihić, I. , 236  
 Milano, M. , 110  
 Milgram, R. M. , 299  
 Milivojević, Z. , 184  
 Miller, C. , 149  
 Miller, D. C. , 298  
 Mires, J. , 237  
 Mistikoglu, G. , 127  
 Moenikia, M. , 127  
 Mola, L. , 126  
 Molnár, E. , 247, 248  
 Moore, D. S. , 277  
 Morais, M. F. , 299  
 Morrison, K. , 315  
 Morrow, D. , 149  
 Mousoulides, N. , 224  
 Mužić, V. , 174  
 Muñiz, J. , 127  
 Mueller, P. A. , 92  
 Mwangi, J. G. , 126  
 Nachmias, R. , 127  
 Nadjafikhah, M. , 299  
 Narvekar, M. , 110  
 Naushad, P. , 111  
 Naveri, L. , 39  
 Negricea, C. I. , 110  
 Nemes, E. , 70  
 Nemes, I. , 70  
 Nettle, D. , 297  
 Newton, D. P. , 298  
 Newton, J. , 277  
 Nicol, C. , 328  
 Nikiforidou, Z. , 277  
 Noss, R. , 224  
 Oberman P. S. , 162  
 Olasz, T. , 69  
 Olive, J. , 225  
 Ollila, M. , 90  
 Olosz, E. , 70  
 Olosz, F. , 70  
 Onwuegbuzie, A. J. , 277  
 Oppenheimer, D. M. , 92  
 Özen, D. , 225  
 Ozyildirim, F. , 128  
 Pólya, G. , 70, 225  
 Pal, S. , 110  
 Palekčić, M. , 184, 185  
 Palhang, M. , 110  
 Palm, T. , 4  
 Palmberg, B. , 4  
 Pange, J. , 277  
 Patton, B. A. , 185  
 Patton, M. Q. , 316  
 Pavleković, M. , 110, 140  
 Paz, J. , 140  
 Peck, R. , 237, 316  
 Pedrycz, W. , 127  
 Peharda, P. , 140  
 Pehkonen, E. , 39  
 Pejić, M. , 174  
 Peker, M. , 185  
 Pekrun, R. , 185  
 Pepin, B. , 316, 328  
 Perez-Kallens, J. , 127  
 Perić, A. , 140  
 Peterson, J. B. , 298  
 Petković, D. , 140  
 Petrović, J. , 236  
 Pettersson, T. , 140  
 Pfannkuch, M. , 278  
 Phelps, G. C. , 315  
 Philipp, R. A. , 278, 281  
 Piaget, J. , 80  
 Pierce, R. U. , 276  
 Pimm, D. , 316  
 Pintrich, P. R. , 127  
 Pitta-Pantazi, D. , 224  
 Pittalis, M. , 224  
 Pjanić, K. , 80  
 Plucker, J. A. , 299  
 Poljak, V. , 174  
 Polonijo, M. , 299, 300  
 Ponte, J. P. , 316  
 Post, T. , 80  
 Potari, D. , 315  
 Prado, T. M. , 39  
 Preis, C. , 185  
 Pretz, J. E. , 300  
 Previšić, V. , 185  
 Prok, I. , 247, 248  
 Puccio, G. J. , 300  
 Put, R. , 110, 127  
 Questier, F. , 110, 127  
 Quinlan, J. R. , 111  
 Rahman, C. M. , 111  
 Raizen, S. , 328  
 Ramalu, S. S. , 111  
 Ramos, S. J. , 300  
 Razak, A. Z. A. A. , 111  
 Rešić, S. , 174  
 Reckase, M. , 316  
 Remillard, J. T. , 316  
 Resnick, L. B. , 224  
 Rezat, S. , 291, 316, 328



- Richards, R. , 300  
Richardson, F. , 185  
Robitaille, D. F. , 316, 328  
Robotham, H. , 127  
Rodriguez, M. , 316  
Rokach, L. , 127  
Romano D. , 237  
Romeike, R. , 92  
Romero, C. , 111  
Root-Bernstein, M. , 300  
Root-Bernstein, R. , 300  
Root-Bernstein, R. S. , 300  
Rounds, J. , 301  
Rowland, T. , 183  
Rowley, G. , 237, 316  
Roy, D. D. , 300  
Runco, M. , 300  
Runco, M. A. , 300  
Russ, S. W. , 300  
Rzejak, D. , 5  
Sadh, A. S. , 111  
Sadler, R. , 149  
Sagadin, J. , 39  
Sak, U. , 300  
Sana, F. , 92  
Santos Trigo, M. L. , 225  
Santos, F. L. , 140  
Saracho, O. , 300  
Sarama, J. , 201  
Saxe, G. B. , 316  
Schafer, W. D. , 298  
Scharber, C. , 149  
Schau, C. , 277  
Schmidt, W. H. , 4, 281, 315, 316, 328  
Schoenfeld, A. H. , 39, 225  
Schraw, G. , 225  
Schwille, J. , 237, 316  
Scott, P. , 248  
Seipel, S. , 92  
Senk, S. , 237  
Senk, S. L. , 316  
Severinac, A. , 174, 183  
Sharp, J. , 56  
Shaughnessy, J. S. , 278  
Shissler, J. E. , 298  
Shukla, N. , 111  
Silvia, P. J. , 300  
Simonton, D. K. , 300, 301  
Skemp, R. R. , 56  
Sleep, L. , 5, 315  
Sloan, T. R. , 185  
Smith, D. A. , 127  
Soddy, F. , 255  
Sohel, F. A. , 111  
Spandel, U. , 224  
Spanoudis, G. , 298  
Staub, F. C. , 281  
Steinfeld, C. , 126  
Stern, E. , 281  
Sternberg, R. J. , 301  
Stevenson-Boyd, J. , 201  
Sträßer R. , 225  
Straesser, R. , 185, 225  
Stuart, C. , 225  
Stumpf, H. , 301  
Su, R. , 301  
Suárez-Álvarez, J. , 127  
Suin, R. M. , 185  
Sullivan, P. , 224  
Sundre, D. L. , 278  
Sutton, L. , 298  
Swafford, J. , 56  
Syed, S. F. , 110  
Szilágyi B. , 248  
Szirmai, J. , 247, 248  
Szitányi, J. , 69  
Szoboszlai, M. , 248  
Šikić, Z. , 328  
Török, T. , 70  
Talsma, G. , 224  
Taras, M. , 149  
Tarmizi, R. A. , 126  
Tastis, K. , 38  
Tatto, M. T. , 237, 316  
Taylor, J. R. , 298  
Tepić, N. , 162  
Terhart, E. , 185  
Thurlow, D. , 225  
Todić, V. , 237  
Turner, J. C. , 145  
Turmuklu, E. B. , 185  
Tversky, B. , 237  
Usmen, P. M. , 127  
Valentina, Z. , 126  
Vallejo, E. , 5  
Valverde, G. A. , 316, 328  
Van Hiel, P. M. , 57  
Vander Heyden, Y. , 110, 127  
Ventura, S. , 111  
Verschaffel, L. , 224  
Vesnin, A. , 248  
Vidákovich, T. , 69  
Villarroel, J. D. , 126  
Vilotijević, M. , 174  
Vinčić, M. , 237  
Vinner, S. , 237  
Vinson, B. M. , 185  
Vlahović-Štetić, V. , 174, 183  
Volenc, V. , 261  
Von Glasersfeld, E. , 226  
Voyer, D. , 301  
Voyer, S. D. , 301  
Vregnaud G. , 57  
Vuković, P. , 277  
Vygotsky, L. S. , 301  
Wai, J. , 301  
Walczak, B. , 110, 127  
Walshaw, M. , 4  
Wang, X. , 127  
Warokka, A. , 110

- Watson, J. M. , 278  
Wei, C. C. , 111  
Weibelzahl, S. , 126  
Weisbeck, L. , 56  
Weiss, S. , 110  
Wempen, F. , 149  
Weston, T. , 92  
Wheatley, G. H. , 224  
Whitelock, D. , 149  
Widmer, C. C. , 185  
Wieczerkowski, W. , 39  
Wilburne, J. M. , 226  
Wild, C. J. , 278  
Winstone, L. , 110  
Wittman, E. Ch. , 201  
Wittmann, E. C. , 70  
Wolfe, R. G. , 316, 328  
Yaftian, N. , 299  
Yang, J. , 111  
Yavuz, G. , 128  
Yesildere, S. , 185  
Yff, P. , 261  
Yim, J. , 57  
Yimer, A. , 226  
Yu, H. , 111  
Yunus, N. K. Y. , 111  
Zacks, J. M. , 237  
Zahed-Babelan, A. , 127  
Zawojewski, J. S. , 278  
Zazkis, R. , 80  
Zdravkovic, V. , 92  
Zekić-Sušac, M. , 110  
Zhang, L. , 127  
Zhu, Y. , 328  
Zimmerman, B. , 39

## Acknowledgment to sponsors

---

---

*The Scientific Committee would like to thank the following sponsors*

**Ministry of Science, Education and Sports of the Republic of Croatia**  
Minister of Science, Education and Sports, Dr Vedran Mornar, Full Professor  
[www.mzos.hr](http://www.mzos.hr)

**Osijek – Baranja County**  
Perfect Vladimir Šišljagić, Ph. D.  
[www.obz.hr](http://www.obz.hr)

**Osijek – City Government**  
Ivan Vrkić, dipl. iur.  
[www.osijek.hr](http://www.osijek.hr)

**Osijek Mathematical Society**  
Head Dr Kristian Sabo, Associate Professor  
[www.mathos.hr/ums](http://www.mathos.hr/ums)

**Tvornica reklama d.o.o., Osijek**  
Krešimir Kulić, direktor  
[www.tvornicareklama.com](http://www.tvornicareklama.com)

*Publisher:*

ELEMENT d.o.o., Zagreb, Menčetićeva 2  
www.element.hr  
element@element.hr

*Design:*

Franka Miriam-Brueckler  
Ines Matijević

*Technical editor:*

Sandra Gračan, dipl. inž.

*Prepress and printed by:*

ELEMENT, Zagreb

A CIP catalogue record for this book is available from the National and University Library in Zagreb under 000907008.

**ISBN 978-953-197-586-5**

