



**Association for  
Institutional Research**

# Professional File

Number 123, Winter 2012

**Association for Institutional Research**  
Supporting quality data and decisions for higher education.  
*Professional Development, Informational  
Resources & Networking*

## *Institutional Dashboards: Navigational Tool for Colleges and Universities*

Dawn Geronimo Terkla, Tufts  
University

Jessica Sharkness, Tufts University

Margaret Cohen, George Washington  
University, Emeritus

Heather S. Roscoe, Simmons College

Marjorie Wiseman, Northeastern  
University, Retired

### **Institutional Dashboards: Navigational Tool for Colleges and Universities**

In an age in which information and data are more readily available than ever, it is critical for higher education institutions to develop tools that can communicate essential information to those who make decisions in an easy-to-understand format. One of the tools available for this purpose is a dashboard, a one- to two-page document that presents critical information (indicators) in a succinct, visually appealing format. Just as an automobile dashboard with its speedometer, odometer, tachometer, fuel gauge, temperature gauge, engine warning, and myriad other indicators, is designed to help the driver navigate the highway, an institutional dashboard is a tool designed to help management guide an organization. Or, as Doerfel and Ruben (2002) put it, a dashboard can be seen as a set of indicators that “reflect key elements of [an organization’s] mission, vision, and strategic direction...[that can be used] to monitor and navigate the organization in much the same way a pilot and flight crew use the array of indicators in the cockpit to monitor and navigate an airplane” (p. 18). Regardless of the analogy employed, at a basic level a college or university’s institutional dashboard is a management tool that succinctly informs its viewers of the current state of affairs, provides information with which the

viewer can evaluate performance, and thereby helps decision-makers strategically move the institution.

In this article, we take an in-depth look at dashboards in practice. First, we describe a variety of dashboards in use at institutions across the country, paying special attention to the indicators that comprise these dashboards. Next, we take a nuts-and-bolts look at the dashboard of one institution, Tufts University, explaining how its dashboard evolved over the years, as well as how it was created and maintained. We next describe how Tufts incorporated peer data into its dashboarding process. The article concludes with a brief discussion of general administrative issues relating to dashboards.

### ***Dashboard Survey***

In order to examine the array of dashboards that have been created on college and university campuses, in the fall of 2005 we collected samples of institutional dashboards from our colleagues at institutions across the country. Examples were solicited electronically from the following institutional research resources: (a) Association for Institutional Research newsletter—*Electronic AIR*, (b) Northeast Association for Institutional Research (NEAIR) list serve, (c) Southern Association for Institutional Research (SAIR) newsletter, and (d) the Higher Education Data Sharing Consortium (HEDS) list serve. In addition, some examples were obtained via a Google search. In total, we collected 66 dashboards from public and private institutions, which range from small colleges to major research universities. Below, we provide a summary of the indicators that institutions chose to display on their dashboards, grouping them by thematic category and discussing the most commonly used measures. Following this, we discuss the visual presentation of institutional dashboard information as it varied from school to school.

***Dashboard indicators.*** The common denominator of all dashboards is that each consists of a set of strategic indicators. Selecting which indicators to display—the first step in creating a dashboard—is the most critical component of the dashboarding process, and the institutions in our sample clearly chose their indicators thoughtfully. In general, best practices for dashboard indicator selection suggest that indicators should be (a) easy to understand, (b) relevant to the user, (c) strategic, (d) quantitative, (e) up-to-date with current information, and (f) not used in isolation (Yonezawa & Kaiser, 2003). In addition, the data underlying the indicators must be reliable. True to best practices, the indicators included in the 66 dashboards we collected included a variety of measures that appeared integrally related to the strategic missions of the institutions developing the dashboards. The number of indicators displayed by each school varied greatly, however—this number ranged from as few as three in the Fort Hays State University Student Learning Dashboard to as many as 68 in Illinois State’s Educating Illinois Report Card. Over all of the samples we collected, the average number of indicators used was approximately 29, while the mode was 25. The specific measures included on each dashboard also varied substantially across institutions.

In order to better understand the types of information presented in our sample of dashboards, we grouped all of the observed indicators into the following 11 broad categories (ordered by frequency of use): (a) financial indicators, (b) admissions statistics, (c) enrollment statistics, (d) faculty data, (e) student outcomes, (f) student engagement, (g) academic information, (h) physical plant, (i) satisfaction, (j) research, and (k) external ratings (Table 1). Within each of these categories, we further classified indicators into subgroups, which ranged from one to five. Each of these subgroups, in turn, consisted of anywhere from 6 to 100 different indicators or measures. Table 1 shows

the 11 broad categories, the subgroups within these categories and the proportion of dashboards that contained indicators in each subgroup.

Interestingly, there were very few specific indicators that were common to all dashboards, supporting the idea that institutions select dashboard indicators thoughtfully based on their specific strategic goals and management processes.

Below, we discuss the composition of each of the major indicator categories, noting the most common sub-groupings observed and the most prevalent indicators that comprise each.

**Financial indicators.** Over 80% of the dashboards we examined contained financial indicators (Table 2). Finance represents the most widely used category, and common financial

**Table 1**  
**Indicator Group Usage Ranking by Category**

Category	Indicator Group	Number of Dashboards Using (N=66)	Percent of Dashboards Using
<b>Financial Indicators</b>	Endowment & Expenses Data	53	<b>80.3%</b>
	Advancement	48	72.7%
	Financial Aid Figures	42	63.6%
	Tuition/Fees Data	31	47.0%
<b>Admissions</b>	Admissions Scores	52	<b>78.8%</b>
	General Admissions Data	47	71.2%
	Graduate Admissions	14	21.2%
<b>Enrollment</b>	Enrollment Figures	51	<b>77.3%</b>
	Enrollment Figures (Special Population)	47	71.2%
<b>Faculty</b>	Faculty – General	51	<b>77.3%</b>
	Faculty Composition – Special Population	22	33.3%
<b>Student Outcomes</b>	Graduation Rates	48	<b>72.7%</b>
	Retention Rate	47	71.2%
	Measures of Success	27	40.9%
	Completions and Awards	15	22.7%
	Graduation Rates – Special Population	10	15.2%
<b>Student Engagement</b>	Student Body – Engagement	38	<b>57.6%</b>
<b>Academic Information</b>	Student/Faculty Contact	36	<b>54.5%</b>
	Academic Information	31	47.0%
<b>Physical Plant</b>	Physical Plant	25	<b>37.9%</b>
<b>Satisfaction</b>	Student Satisfaction	23	<b>34.8%</b>
	Employer/Staff, Other Satisfaction	7	<b>10.6%</b>
	Faculty Satisfaction	3	4.5%
<b>Research</b>	Research	23	<b>34.8%</b>
<b>External Ratings</b>	Peer Assessment Data	14	<b>21.2%</b>

indicators include measures of endowment and expenses (80%), advancement (73%), financial aid (64%), and tuition and fees (47%). In terms of measures of endowment and expenses, we observed 100 different indicators over the 66 collected dashboards, but the most frequently used three were the market value of the endowment, endowment per FTE student, and endowment return or annual growth rate. Under the broad category of advancement, the three most frequently used indicators were alumni giving, total gifts

received, and alumni gifts. With respect to financial aid, institutions most commonly displayed tuition discount rates, the percentage of students receiving aid, and the proportion receiving institutional grants. Finally, in addition to indicators of overall tuition and fees, some institutions elected to include net tuition measures and/or tuition for specific student levels or programs.

**Admissions indicators.** Seventy-nine percent of the dashboards we collected included some undergraduate admissions-related indicators. As

**Table 2**  
*Financial Indicators*

Group (Number of indicators in group)	Number of Dashboards Using (N=66)	Percent of Dashboards Using
<b>Endowment &amp; Expenses (100)</b>	<b>53</b>	<b>80.3%</b>
Endowment market value	34	51.5%
Endowment per FTE student	16	24.2%
Endowment return/growth	12	18.2%
<b>Advancement (31)</b>	<b>48</b>	<b>72.7%</b>
Alumni giving rate	38	57.6%
Total gifts/voluntary giving	26	39.4%
Alumni gifts	9	13.6%
<b>Financial Aid (42)</b>	<b>42</b>	<b>63.6%</b>
% tuition discount/tuition reliance	21	31.8%
% of students receiving aid	18	27.3%
% receiving institutional grants	10	15.2%
<b>Tuition/Fees (25)</b>	<b>31</b>	<b>47.0%</b>
Tuition and fees	16	24.2%
Net tuition per student	6	9.1%
Undergraduate tuition	5	7.6%

shown in Table 3, the most frequently reported measures were yield—the percentage of those who were admitted who matriculated (64%), admit rate—the percentage of those who applied who were offered acceptance (50%), average SAT scores (50%), number of applications (47%), and percentage of students in the top 10% of the

high school class (41%). In addition, a little over 20% of the institutional dashboards we examined used measures of graduate admissions. These graduate-specific most often included number of applications, number of acceptances, yield, and graduate admissions test scores.

**Table 3**  
**Admissions Indicators**

Group (Number of indicators in group)	Number of Dashboards Using (N=66)	Percent of Dashboards Using
<b>Admissions Scores (34)</b>	<b>52</b>	<b>78.8%</b>
Average SAT	33	50.0%
% in top 10% of HS class	27	40.9%
Average entering GPAs	13	19.7%
<b>General Admissions Data (16)</b>	<b>47</b>	<b>71.2%</b>
Yield rate	42	63.6%
Admit rate	33	50.0%
No. of applicants	31	47.0%
<b>Graduate Admissions (7)</b>	<b>14</b>	<b>21.2%</b>
Graduate admissions test scores	7	10.6%
No. of applicants accepted	4	6.1%
Graduate rankings	4	6.1%

**Enrollment indicators.** Over 77% of our collected dashboards contained some type of enrollment measure (Table 4). These included undergraduate enrollment, graduate enrollment, first-year enrollment, transfer enrollment, enrollment by college or degree program, summer session enrollment, credit and non-credit

enrollment, and distance education enrollment. Additionally, 47 institutions (71%) included one or more measures describing special populations, splitting out groups of students by citizenship, race/ethnicity, gender, full-time/part-time status, geographic diversity, religious affiliation, and age.

**Table 4**  
**Enrollment Indicators**

Group (Number of indicators in group)	Number of Dashboards Using (N=66)	Percent of Dashboards Using
<b>General Enrollment Data (29)</b>	<b>51</b>	<b>77.3%</b>
Undergraduate enrollment	44	66.7%
Graduate headcount	10	15.2%
No. of new freshmen	7	10.6%
<b>Enrollment (Special Population) (33)</b>	<b>47</b>	<b>71.2%</b>
% minority students	34	51.5%
% of international students	24	36.4%
% of female/male students	11	16.7%

**Faculty indicators.** Many institutional dashboards (77%) included indicators that were intended to describe faculty (Table 5). These encompassed many of the various methods of counting faculty at an institution (i.e., the number of full-time equivalent faculty, the number of tenured/tenure-track faculty, the number of faculty with terminal degrees, and part-time faculty headcount).

Some institutions were also interested in ratios of full-time to part-time faculty, the percentage of faculty who are female, minority, or international, or the percentage of faculty who receive national awards. A small portion of institutions provided measures of faculty compensation, using indicators such as compensation by rank, compensation compared to peers, and percentage salary increases.

**Table 5**  
**Faculty Indicators**

Group (Number of indicators in group)	Number of Dashboards Using (N=66)	Percent of Dashboards Using
<b>Faculty – General (65)</b>	<b>51</b>	<b>77.3%</b>
Faculty FTE	15	22.7%
% of faculty with terminal degree	11	16.7%
Average Professor compensation	9	13.6%
Associate Professor compensation	9	13.6%
Assistant Professor compensation	9	13.6%
<b>Faculty Composition – Special Population (19)</b>	<b>22</b>	<b>33.3%</b>
% minority	15	22.7%
% female/male	9	13.6%
% female/male by tenure	4	6.1%

**Student outcomes.** Of the 66 dashboards collected, graduation and retention rates were found in over three-quarters (77%). As shown in Table 6, the most frequently utilized measure in this category was the freshmen retention rate (61%), followed very closely by the six-year graduation rate (59%). Additional measures that appeared in some dashboards, though less frequently, were graduation or retention rates for specific populations (i.e., minorities, liberal arts candidates, student athletes), and retention in specific degree programs (i.e., master’s, doctoral, graduate professional).

Another commonly included subcategory of student outcomes was measures of student success. About 41% of the dashboards we collected displayed one or more measures of student success at the end of college. Such measures were varied—there were 83 different indicators in this sub-category—but many related to student employment status after graduation, the numbers of graduates pursuing further education, and/or passage rates on professional exams. Numbers of completions and awards were found on approximately one in five dashboards—23% included counts of degrees and certificates awarded at various levels.



**Table 6**  
**Student Outcomes**

Group (Number of indicators in group)	Number of Dashboards Using (N=66)	Percent of Dashboards Using
<b>Graduation Rates (6)</b>	<b>48</b>	<b>72.7%</b>
6-year graduation rate	39	59.1%
Graduation rates	5	7.6%
4-year graduation rate	3	4.5%
5-year graduation rate	3	4.5%
<b>Retention Rates (18)</b>	<b>47</b>	<b>71.2%</b>
Freshman retention rate	40	60.6%
Fall-to-fall retention	7	10.6%
Retention rate by ethnic group/race	3	4.5%
<b>Measures of Success (83)</b>	<b>27</b>	<b>40.9%</b>
% employment/unemployment	5	7.6%
% of graduates working in their field	5	7.6%
% of seniors going to graduate school	4	6.1%
<b>Completions and Awards (14)</b>	<b>15</b>	<b>22.7%</b>
# doctoral degrees awarded	9	13.6%
# master’s degrees awarded	8	12.1%
# bachelor’s degrees awarded	6	9.1%
<b>Graduation Rates – Special Population (8)</b>	<b>10</b>	<b>15.2%</b>
6-year graduation rate for minorities	2	3.0%
6-year graduation rate for student athletes	2	3.0%
Graduation rate for Liberal Arts	2	3.0%

**Student engagement.** Thirty-eight of the 66 dashboards that we examined (58%) contained one or more of 39 different indicators of student activities and engagement. Institutions were most commonly interested in the numbers of students who study abroad, participate in honors programs, live on campus, engage in research, and/or participate in service learning opportunities (Table 7).

**Academic information.** Academic information, found on over half of the collected dashboards, could be divided into two general groups: student/faculty contact and general academics (Table 8). Fifty-four percent of dashboards contained indicators from the student/faculty contact

group, which was comprised of nine different measures related primarily to course or section size and student/faculty ratio. The second group, general academic information, was made up of 68 different measures, which were found on 31 of the 66 dashboards. These more general indicators varied considerably by institution and covered a broad area. Some examples include the number of course sections offered, a ranking of the library by the Association of Research Libraries (ARL), the number of graduate assistantships, the number of undergraduate majors by school, articulation/affiliation agreements with other institutions, and the number of online, video, and site-based courses.

**Table 7**  
**Student Engagement**

Group (Number of indicators in group)	Number of Dashboards Using (N=66)	Percent of Dashboards Using
<b>Student Body Engagement (39)</b>	<b>38</b>	<b>57.6%</b>
Study abroad	8	12.1%
Honors in major	5	7.6%
% of undergraduates living on campus	4	6.1%

**Table 8**  
**Academic Information**

Group (Number of indicators in group)	Number of Dashboards Using (N=66)	Percent of Dashboards Using
<b>Student/Faculty Contact (9)</b>	<b>36</b>	<b>54.5%</b>
Student/faculty ratio	36	54.5%
Classes < 20 students	19	28.8%
Classes > 50 students	12	18.2%
<b>Academic Information (68)</b>	<b>31</b>	<b>47.0%</b>
No. of fellowships	4	6.1%
Course sections offered	3	4.5%
ARL ranking of library	3	4.5%

**Table 9**  
**Physical Plant**

Group (Number of indicators in group)	Number of Dashboards Using (N=66)	Percent of Dashboards Using
<b>Physical Plant (46)</b>	<b>25</b>	<b>37.9%</b>
Plant reinvestment rate	4	6.1%
Seat/stations utilization	4	6.1%
Space utilization	3	4.5%

**Physical plant.** Almost 38% of the dashboards contained indicators related to the institution’s physical plant (Table 9). Among the measures of interest in this category were records of the plant investment rate, seat/stations utilization, space utilization, facilities condition index, network system and speed, and room occupancy.

**Satisfaction.** The types of satisfaction measures included on institutional dashboards could be divided into three types according to whose satisfaction was being measured: student, employer/employee, or faculty (Table 10). Not surprisingly, student satisfaction measures were the most prevalent of the three, with 35% of



the amassed dashboards using one or more of the 55 different indicators observed. Primarily, these indicators were measures of overall student satisfaction or of satisfaction with specific aspects of students’ college experience (such as instruction, academic life, social life, support/academic/ administrative services, classrooms, and decisions to enroll). Additional indicators reported on the satisfaction of special groups such as minority students.

Only seven dashboards (11%) utilized employer or employee satisfaction metrics, and even fewer—just three—displayed faculty satisfaction

metrics. The former included measures of employer satisfaction, employee/staff satisfaction, and employee satisfaction with specific aspects of the work environment. The few institutions concerned with faculty satisfaction elected to display measures reflecting faculty satisfaction with a variety of issues, including salary and benefits, the quality of the student body (both graduate and undergraduate), the institution as a good place to work, and clerical and technical support.

**Research.** Almost 35% of the institutional dashboards we collected displayed indicators that related to research. As shown in Table 11,

**Table 10**  
**Satisfaction**

Group (Number of indicators in group)	Number of Dashboards Using (N=66)	Percent of Dashboards Using
<b>Student Satisfaction (55)</b>	<b>23</b>	<b>34.8%</b>
% of undergraduate satisfaction	11	16.7%
Alumni satisfaction	8	12.1%
Student satisfaction – instruction	7	10.6%
<b>Employer/Staff/Other Satisfaction (10)</b>	<b>7</b>	<b>10.6%</b>
Employer satisfaction	4	6.1%
Employee/staff satisfaction	3	4.5%
Community satisfaction	2	3.0%
<b>Faculty Satisfaction (12)</b>	<b>3</b>	<b>4.5%</b>
Overall Faculty satisfaction	1	1.5%
Overall Faculty satisfaction by race	1	1.5%
Overall Faculty satisfaction by gender	1	1.5%

**Table 11**  
**Research**

Group (Number of indicators in group)	Number of Dashboards Using (N=66)	Percent of Dashboards Using
<b>Research (38)</b>	<b>23</b>	<b>34.8%</b>
Expenditures/total research support	16	24.2%
# of patents awarded	6	9.1%
Total externally funded research	5	7.6%

the most frequently used indicator, a measure of expenditures/total research support, was found on 24% of the dashboards. Other indicators used by more than one institution included the number of patents awarded, number of patent applications filed, royalty/license income, total externally funded research, number of income-generating licenses, number of grant submissions, grant revenue generated, and cost of a research assistant.

**External ratings.** Finally, external ratings or peer assessment measures appeared on 21% of the dashboards examined (Table 12). Interestingly, of the six observed indicators in this category, all were related to *U.S. News & World Report* (USNWR) rankings. As might be expected, the most prevalent indicators were the institution’s USNWR tier and its academic reputation score (the peer assessment score).

**Table 12**

**External Ratings**

Group (Number of indicators in group)	Number of Dashboards Using (N=66)	Percent of Dashboards Using
<b>Peer Assessment Data (6)</b>	<b>14</b>	<b>21.2%</b>
<i>U.S. News &amp; World Report</i> tier	7	10.6%
<i>U.S. News &amp; World Report</i> peer assessment score	5	7.6%
<i>U.S. News &amp; World Report</i> rating	3	4.5%

**Visual presentation.** As mentioned earlier, the dashboards shared with us by our colleagues differed substantially from one another in terms of visual presentation. First among the differences was the amount of information, or number of indicators displayed. Almost 58% of the dashboards we examined had between 10 and 30 indicators, while 9% had 10 or fewer and 5% had more than 50. Length varied as well; 38% were one page documents, 15% were two pages, and the rest varied from 3 to a 50 pages. Seventy-eight percent contained trend data.

The actual visual style of the dashboards was also dramatically different across institutions. Some dashboards were a series of graphs, while others were simply matrices of numbers. Many incorporated symbols and color, often to present recent trends in data. Indeed, 53% used color to indicate positive or negative trends. Trends were presented in other ways as well; for example, 20% of dashboards used arrow indicators to display the direction of trends, and one presented a complex

summary of the past six years of data, displaying the highest, lowest, and current values for the time period as well as an arrow indicating the change from the prior year (higher, lower, or no change). The color of this arrow reflected performance (green is better, red is worse, black is neutral).

At times, dashboards have been criticized because they have not included comparative peer data. We found at least eight among our 66 collected dashboards that contained comparative data, although peer data was presented differently in all of these dashboards. The most complicated and data-rich dashboard including peer data presented its institution’s current year data, with arrows indicating significant change over the prior six-year period and a notation indicating whether the institution is significantly above or below the mean value of its peers (“above peers” or “below peers”; “mid of peers” indicated not significantly different from the mean). This same dashboard used color to represent the status of peer comparisons, with green for a positive trend/

comparison, red for a negative trend/comparison, and black for a neutral trend/comparison. Additionally, this dashboard was posted online, and provided drill-down links to graphs and tables for more detail.

### The Technical Side: The Tufts Dashboard

In 2002, the Tufts Board of Overseers and top members of the Tufts administration agreed on a set of metrics to use to evaluate the overall performance of the university (Allen, Bacow, & Trombley, 2011). This set of metrics was given to the Institutional Research office, which was tasked with collecting and managing the relevant data, as well as the creation and visual look of the dashboard. Since its initial creation, the Tufts dashboard has gone through several iterations. What follows is a

discussion of some of the major changes made to the dashboard, along with explanations about why and how the changes were implemented.

There are six basic pieces of information that are shown on the Tufts dashboard: the name of the indicator/variable, the highest value for this variable during the previous six years, the lowest value during the previous six years, the current value, and an arrow or dot, the shape/direction of which indicates whether the current value is higher than, lower than, or the same as the previous year's value, and the color of which indicates whether this change is good, bad, or neutral (see Figure 1). The raw data that serve as a basis for all of this information are stored in a large data sheet with a row for each variable and a column for each year.

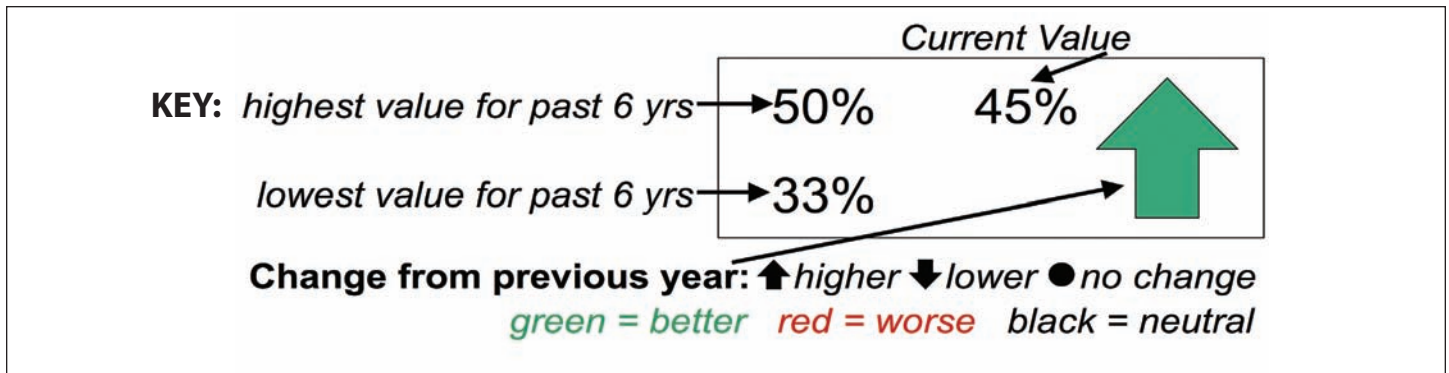

Figure 1. Basic dashboard layout for each indicator.

At Tufts, the data for the dashboard and the dashboard itself are stored in Microsoft Excel workbooks. Tufts produces three versions of its dashboard each year, in the fall, winter, and spring. The three versions share the majority of their information, but each also has its own unique aspects. When the dashboard was first produced, three separate Excel workbooks were created annually for the different dashboards. This seemed like a logical way to construct the individual dashboards, as each is slightly different from the others, but it ended up causing a good deal of confusion. The majority—but not all—of the data

was duplicated from one workbook to another, so the data in each workbook were similar but not identical. As a result, it was hard to carry the templates over from year to year: to create a new fall dashboard, we had to copy the formatting of the previous year's fall dashboard, but the data from the spring dashboard.

There were other problems with the way the original dashboards were set up, as well. The biggest problem was that the dashboard Excel sheets referenced the data directly, meaning that the data displayed in the dashboard reflected the results obtained from a formula that referenced

the sheet that contained the relevant data (see Figure 2). This strategy was problematic for several reasons. First, because the order of the data as it was presented on the dashboard did not match the order of the data in the data sheet, it was extremely tedious to check the formulas in the dashboard to ensure they contained the correct cell ranges. It was also difficult to update the formulas when new data were added, since it was not obvious where

the correct cells were located on the dashboard pages. Further, storing the final dashboards as worksheets in an Excel workbook with dynamic cell values was suboptimal, as the possibility existed that the dashboards could inadvertently be altered, for example if the data (or a formula) on the worksheet were accidentally changed. If something like that happened, the final dashboard, as it was presented to the trustees, would be lost.

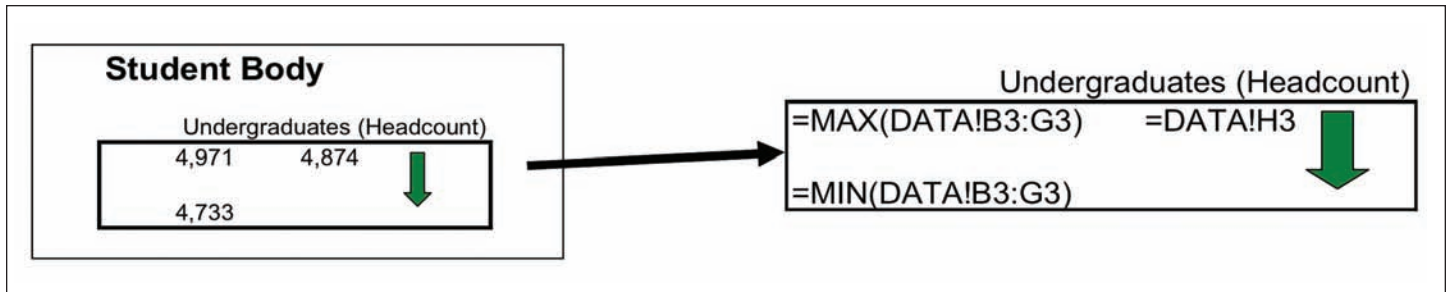

Figure 2. Original dashboard references data sheet directly.

Finally, the original Tufts dashboard was not visually pleasing (see Figure 3). Not only did the dashboard have to be printed on legal-size paper, which was awkward to print, view, and store, but the document was also not aesthetically pleasing. Specifically, the column widths were not the same, many of the arrows were different lengths and widths, the key was on the bottom of the page and was hard to read, and the different subject areas (i.e., student body, finances) were not well bounded.

To remedy the problems described above, a new dashboard workbook/template was created, which is still in use as of the time we write this article. This new workbook/template contains all three versions of the dashboard for a given year (fall, winter, and spring) in separate worksheets, and also contains the relevant data, both historical and current. Apart from the many cosmetic changes (these will be discussed later), the main change in the new dashboard template was the addition of

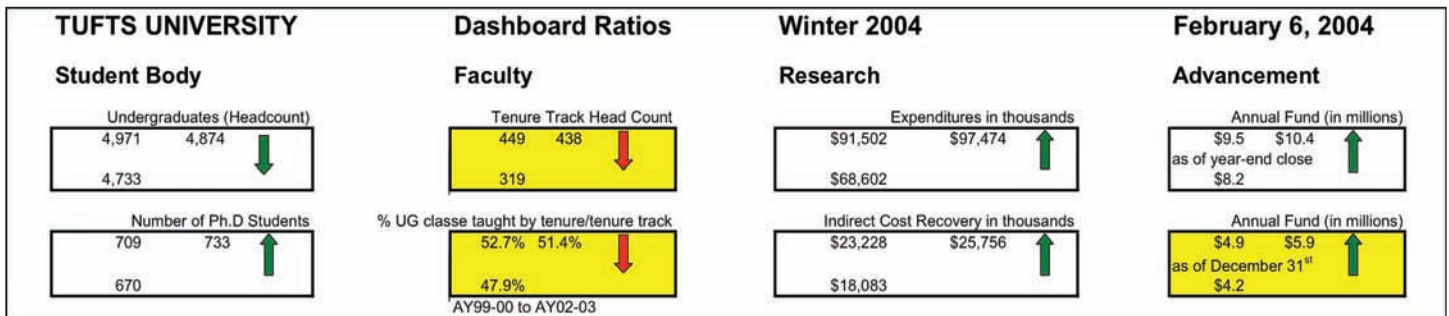

Figure 3. Original dashboard was not visually pleasing.



an “indicators” sheet. This indicators sheet acts as a mediator between the dashboard and the data; it contains the formulas that generate the different pieces of dashboard information (i.e., highest value for the past six years, lowest value for the past six years, current value, etc.). The indicators sheet mirrors the data sheet exactly—each line of data on the indicators sheet corresponds to the same line of data on the data sheet, and vice versa. Setting up the indicators sheet in this manner has made it much easier to locate the correct formulas to update when new data are added, since the line of data that gets updated on the data sheet will be the exact same line that should be updated on the indicators sheet. Meanwhile, the sheets with the

dashboards themselves simply have to reference the indicators sheet. This means that the cell references in the actual dashboards only need to be set once—they will no longer change from year to year—and that the data on the dashboard are automatically updated when the indicators sheet is updated (see Figure 4.)

The new indicators sheet also has an additional column of information that contains formulas showing whether the current year’s data points are higher or lower than the previous year’s (see Figure 5). While this comparison can be done manually, the formulas on the sheet give a quick and handy indication as to which way the arrows on the dashboard should be pointed.

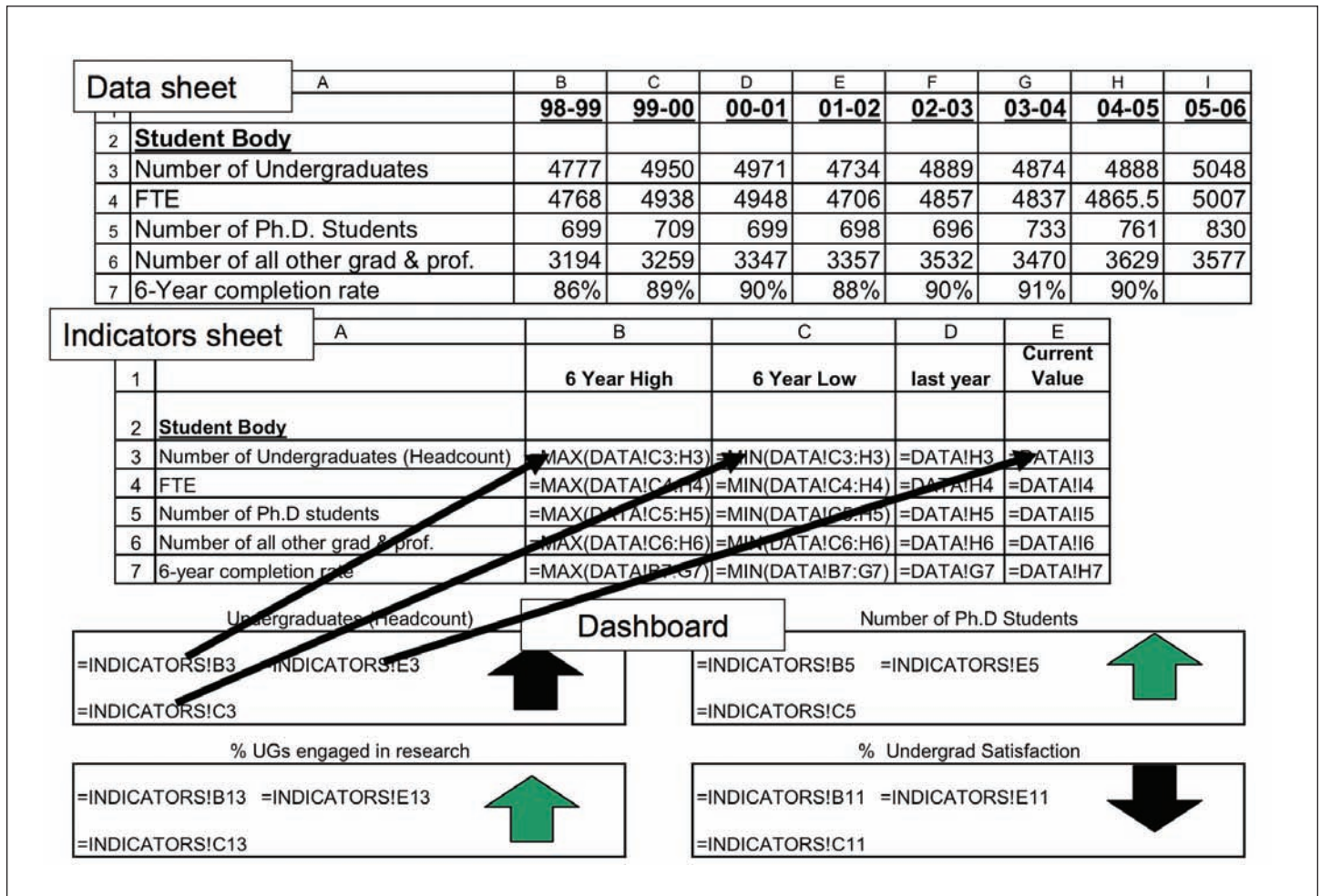

Figure 4. Data sheet, indicators sheet, and dashboard.

1	<b>Current Value Higher/ Lower?</b>	<b>Current Value Higher/ Lower?</b>
2		
3	=IF(E3>D3,"HIGHER",IF(E3=D3,"Same", IF(E3<D3,"LOWER")))	HIGHER
4	=IF(E4>D4,"HIGHER",IF(E4=D4,"Same", IF(E4<D4,"LOWER")))	HIGHER
5	=IF(E5>D5,"HIGHER",IF(E5=D5,"Same", IF(E5<D5,"LOWER")))	HIGHER
6	=IF(E6>D6,"HIGHER",IF(E6=D6,"Same", IF(E6<D6,"LOWER")))	HIGHER
7	=IF(E7>D7,"HIGHER",IF(E7=D7,"Same", IF(E7<D7,"LOWER")))	HIGHER

Figure 5. Indicators sheet shows if current value is higher or lower.

A few minor points regarding the new dashboard setup should be noted. Given that all the dashboard templates are in one workbook and that they all reference the same indicators sheet, when the data are updated for newer versions of the dashboard (e.g., winter and/or spring) and the indicators sheet is changed accordingly, the old versions of the dashboard (e.g., fall and/or winter) will change. To solve this problem, and to provide a snapshot of the dashboard exactly as it was presented, we make sure to create a PDF version of each seasonal dashboard when it is finalized. A printout of the PDF can be distributed to those who use the dashboard, and an electronic copy can be archived along with the dashboard workbook for posterity. The other thing to note is that the direction and color of the arrows on the dashboard must be updated manually. The indicators sheet shows which way the arrow should be pointing, but we manually point the arrows in that direction, as well as manually color them. We do not see this manual process as a negative, however; by updating the arrows individually, we in Institutional Research are able to make the ultimate decision about the direction and color of each arrow. Such decisions cannot really be automated, because they are inherently subjective and must be made in the context of the institution. For example, is a 1% change significant or irrelevant? Is an increase in the value of an indicator good or bad? Answers to these questions can vary from institution to

institution as well as from indicator to indicator, and must therefore be made thoughtfully.

Finally, perhaps the most obvious changes that were made to the old dashboard were cosmetic. As mentioned above, the layout of the new Tufts dashboard was altered slightly to make it more visually appealing. Specifically, column widths were standardized, arrows were made larger and easier to see, the key was moved to the top of the page, each subject area on the dashboard was bounded by a grey border, and the dashboard now fits on standard 8½ x 11" paper instead of legal-size paper (see Figure 6).

### Peer Data

As was previously mentioned, many dashboards have been criticized because they have not included comparative peer data. In the survey of the 66 dashboards described above, only eight contained comparative data. Tufts' Office of Institutional Research was interested in finding out whether peer data could be added to its dashboard in order to provide context for Tufts' numbers. The University already had an established list of peers to which it regularly compares itself in different contexts, and the office felt that adding peer data to the dashboard would provide a succinct way to examine how Tufts was performing in comparison to these peers.

Some of the sources that are commonly used to find peer data are the *U.S. News & World Report*,



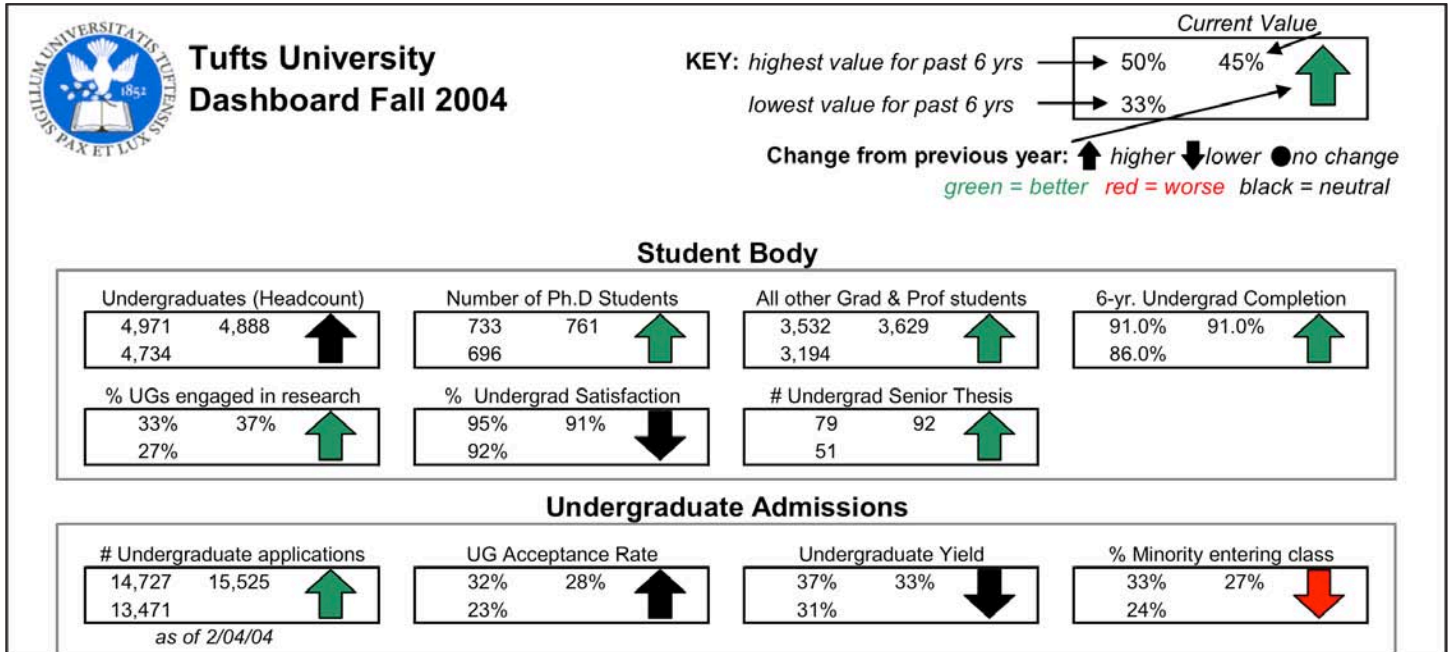

Figure 6. New Look of the Tufts University dashboard.

College Board Annual *College Handbook*, IPEDS Peer Analysis System, and a variety of other databases maintained by NSF and NCES. Many of the items that currently exist on the Tufts dashboard were the same as or very similar to items within IPEDS, so Tufts selected the IPEDS Peer Analysis System as the vehicle by which peer data would be obtained.

The way we created peer measures was as follows. Within the IPEDS Peer Analysis System, a "Comparison Group" of Tufts' peer institutions was created. Next, the most recent IPEDS data available for each relevant dashboard item were identified, and "Ranking Reports" that ranked each institution for each item were produced. In cases where items were not readily available in the format that was needed, "Calculated Variables" were created. For example, Tufts was interested in looking at the percentage of minority faculty at each institution. IPEDS has items available regarding the total number of faculty, and also items about the total number of minority faculty, but it contains no item regarding the percentage of minority faculty. Thus, a calculated variable was created by instructing

the IPEDS Peer Analysis System to divide the number of minority faculty by the total number of faculty, thereby creating the parameter of interest. All calculated variables were included in the ranking reports described above. These ranking reports formed the basis for the peer comparison dashboard.

A special peer dashboard template was created, and the peer institutions were listed in the upper left corner. The same general layout as the original dashboard was utilized in order to make the peer comparisons readily understandable. Specifically, the Tufts data were formatted exactly the same, but a label specifying that it was "TUFTS" data was added to the top of each section for clarity. We then added a new box directly below the Tufts box that contained peer data. The same technical cell-referencing techniques described in the previous section were used. At the top of the peer comparison box, the peer data source and year of data were specified. Below this was listed the highest ranked peer name and its value on the measure, and the lowest ranked peer name and its

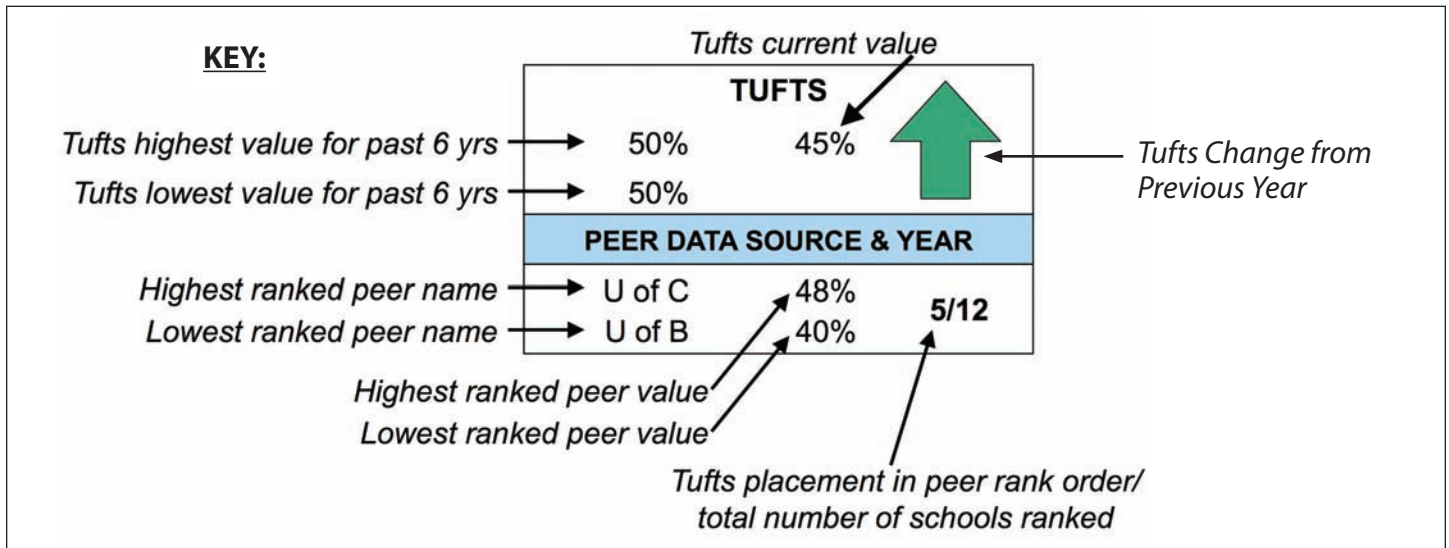

Figure 7. The general layout of items on the peer dashboard.

value. In the bottom right corner, Tufts’ placement in the peer rank order was given, along with an indication of how many peers were included in the comparison (see Figure 7).

The resulting peer dashboard can be seen in Figure 8. Unfortunately, this version of the dashboard did not gain traction with the upper administration and in the end was not adopted as a management tool. Nevertheless, we view its creation as a useful exercise, as we are now poised to incorporate comparative data into the dashboard if and when the administration requests it.

### Administrative Aspects of Dashboards

After analyzing the collection of dashboards we amassed, we realized that we still had questions related to administrative aspects of the dashboards. Specifically, we were interested in finding out who initially requested the dashboard, the primary audience, whether the dashboard was paper or electronic, whether access was open or restricted, the frequency of updates, and, finally, the number of dashboards the institution had developed. We sent a short survey to about half of the initial respondents with these and other questions, and 71% responded.

In almost all cases, the President, Provost, or Board of Trustees had initially requested the creation of their institution’s dashboard, although at one institution the impetus came from a HEDS presentation. The primary audience for all institutions was upper management, namely the Board, the President, and/or the Deans. Most dashboards were presented and stored electronically, though some were available in print only. Several institutions that had paper-only versions indicated plans to implement electronic versions in the near future. Seventy percent of our respondents restricted access to their dashboards. Three-quarters of the responding institutions had a single dashboard. Some examples of multiple dashboards among the remaining quarter include (a) one with student indicators and one with financial indicators, (b) one for the institution as a whole and one for athletic indicators, (c) one for the institution as a whole and one for academic affairs, and (d) one for each school/college within the institution.

Overall, it seems while there is a great variety in the numbers and types of indicators institutions use on their dashboard(s), there is less difference in the reasons for creating the dashboard, its availability, and its primary users. It seems that

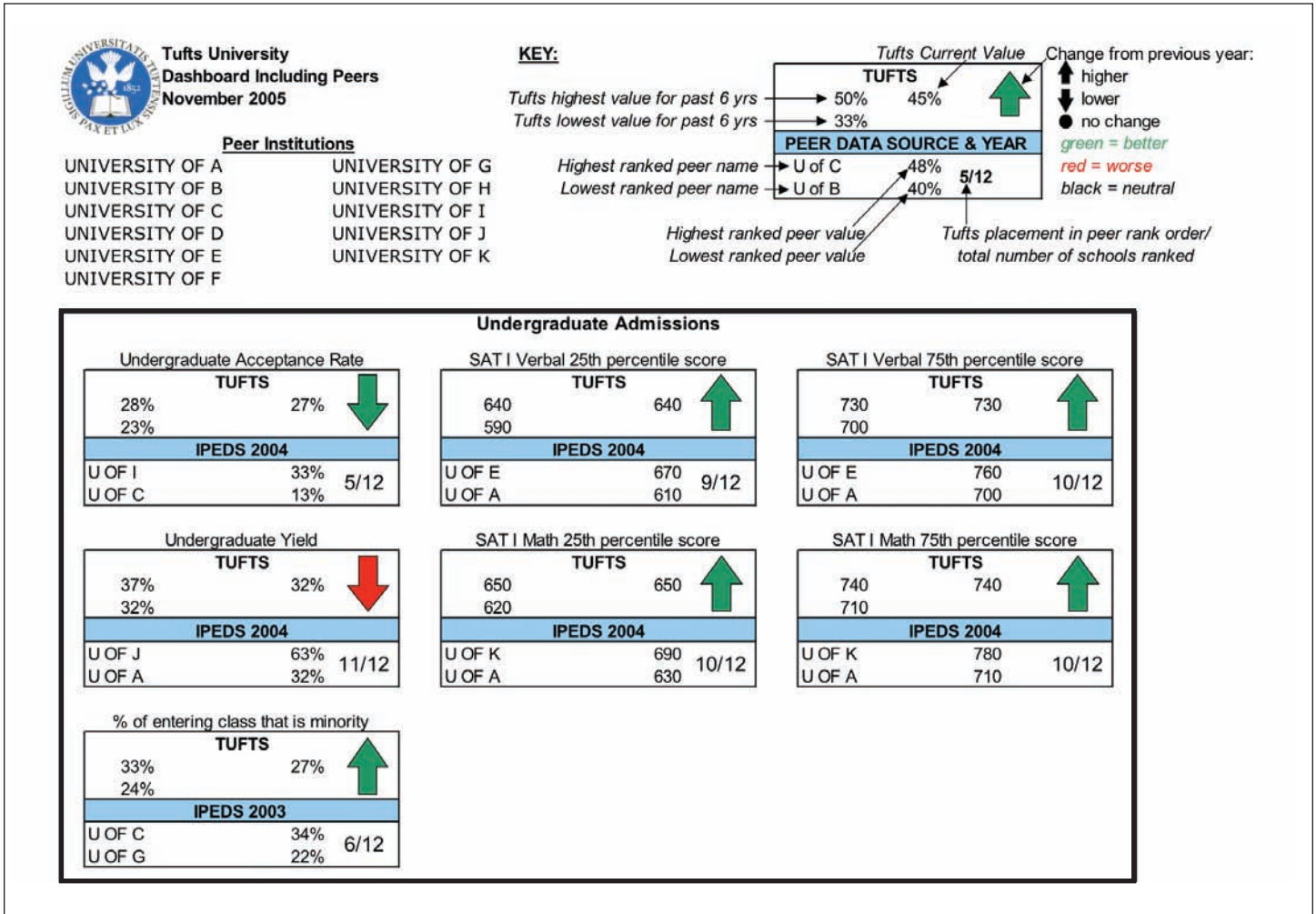

Figure 8. The Tufts peer dashboard.

most dashboards are an essential ingredient of institutional strategic plans—which is perhaps not surprising, as many are created specifically to evaluate the progress of strategic planning and other initiatives (Allen et al., 2011).

### Conclusion

Although this paper has only scratched the surface of what might be said about dashboards, it seems clear that individuals who have an interest in displaying measures that show the state of the institution in a succinct, easily understood, visually

appealing format should consider developing an institutional dashboard. Not only can dashboards help focus attention on the state of the institution as it stands now, but they can also focus attention on the future. Dashboards are valuable—some might say invaluable—tools for the management and strategic governance of institutions. *Note: The following list of references and bibliographic resources was compiled to support this study. While most are not cited directly in this paper, they are included because the authors felt that they are helpful in understanding dashboards and/or that they provide important information to support future research on the topic.*



## Reference List

- Allen, C., Bacow, L. S., & Trombley, L. S. (2011). Making metrics matter: How to use indicators to govern effectively. *Trusteeship*, 1(19), 9–14.
- Baldrige National Quality Program. (2004). *2005 education criteria for performance excellence*. Gaithersburg, MD: National Institute of Standards and Technology.
- Bates College Institutional Planning and Analysis. (2003). *25 dashboard indicators list*. Retrieved from <http://cms.bates.edu/x34725.xml>
- Borden, V. M. H., & Bottrill, K. V. (1994). Performance indicators: History, definitions, and methods. *New Directions for Institutional Research*, 82, 5–21. doi: 10.1002/ir.37019948203
- Bourne, B., Gates, L., & Cofer, J. (2000). Setting strategic directions using critical success factors. *Planning for Higher Education*, 28(4), 10–18.
- Doerfel, M. L., & Ruben, B. D. (2002). Developing more adaptive, innovative, and interactive organizations. *New Directions for Higher Education*, 118, 5–28. doi: 10.1002/he.53
- Few, S. (2006). *Information dashboard design: The effective visual communication of data*. Sebastopol, CA: O'Reilly Media.
- Florida Atlantic University, Office of Institutional Effectiveness & Analysis. (2011). *Dashboard indicators (D.D.I.) 2004 program review*. Retrieved from <http://iea.fau.edu/inst/review.htm>
- Higher Education Statistics Agency. (2004). *Performance indicators in higher education in the UK 2002/03* (September 2004; updated December 2004). Retrieved from <http://www.hesa.ac.uk/pi/>
- Houghton College. (2004). *Dashboard indicators: The top mission-critical indicators for Houghton College*. Retrieved from [http://campus.houghton.edu/orgs/ipo/hottopics/dashboard%2003-04/Dash\\_bd\\_Ind.htm](http://campus.houghton.edu/orgs/ipo/hottopics/dashboard%2003-04/Dash_bd_Ind.htm)
- Lawrence University. (2010). *Dashboard indicators*. Retrieved from <http://www.lawrence.edu/dept/ora/dashboards.shtml>
- Pennsylvania State University, Office of Planning & Institutional Assessment. (2008). *Strategic indicators: Measuring and improving university performance*. Retrieved from <http://www.psu.edu/president/pia/indicators/indicators2008.pdf>
- Rohm, H., & Halbach, L. (2005). *Developing and using balanced scorecard performance systems* (white paper). Raleigh, NC: Balanced Scorecard Institute. Retrieved from [http://www.biasca.com/archivos/for\\_downloading/management\\_surveys/Mgmt\\_Balanced\\_Scorecards\\_balancingact.pdf](http://www.biasca.com/archivos/for_downloading/management_surveys/Mgmt_Balanced_Scorecards_balancingact.pdf)
- Sapp, M. M., & Liu, P. (2005, May). *A dashboard report with value added through peer comparisons, statistical significance, and drill-downs*. Tallahassee, FL: Association for Institutional Research.
- Taylor, B. E., & Massy, W. F. (1996). *Strategic indicators for higher education*. Princeton, NJ: Peterson's.
- Wisn, G. (2002, November). *Assessment and assisting the college president steer the ship: An analytic comparison of dashboard indicators, the balanced scorecard, performance measures, and Six Sigma in the college and university setting*. Proceedings of the North East Association for Institutional Research Annual Meeting, Annapolis, MD.
- Yonezawa, A., & Kaiser, F. (Eds.). (2003). *System-level and strategic indicators for monitoring higher education in the twenty-first century*. Bucharest, Romania: United Nations Educational, Scientific, & Cultural Organization.



**Association for  
Institutional Research**

## The AIR Professional File—1978-2011

A list of titles for the issues printed to date follows. Most issues are “out of print,” but are available as a PDF through the AIR Web site at <http://www.airweb.org/publications.html>. Please do not contact the editor for reprints of previously published Professional File issues.

- Organizing for Institutional Research (J.W. Ridge; 6 pp; No. 1)
- Dealing with Information Systems: The Institutional Researcher's Problems and Prospects (L.E. Saunders; 4 pp; No. 2)
- Formula Budgeting and the Financing of Public Higher Education: Panacea or Nemesis for the 1980s? (F.M. Gross; 6 pp; No. 3)
- Methodology and Limitations of Ohio Enrollment Projections (G.A. Kraetsch; 8 pp; No. 4)
- Conducting Data Exchange Programs (A.M. Bloom & J.A. Montgomery; 4 pp; No. 5)
- Choosing a Computer Language for Institutional Research (D. Strenglein; 4 pp; No. 6)
- Cost Studies in Higher Education (S.R. Hample; 4 pp; No. 7)
- Institutional Research and External Agency Reporting Responsibility (G. Davis; 4 pp; No. 8)
- Coping with Curricular Change in Academe (G.S. Melchiori; 4 pp; No. 9)
- Computing and Office Automation—Changing Variables (E.M. Staman; 6 pp; No. 10)
- Resource Allocation in U.K. Universities (B.J.R. Taylor; 8 pp; No. 11)
- Career Development in Institutional Research (M.D. Johnson; 5 pp; No. 12)
- The Institutional Research Director: Professional Development and Career Path (W.P. Fenstemacher; 6pp; No. 13)
- A Methodological Approach to Selective Cutbacks (C.A. Belanger & L. Tremblay; 7 pp; No. 14)
- Effective Use of Models in the Decision Process: Theory Grounded in Three Case Studies (M. Mayo & R.E. Kallio; 8 pp; No. 15)
- Triage and the Art of Institutional Research (D.M. Norris; 6 pp; No. 16)
- The Use of Computational Diagrams and Nomograms in Higher Education (R.K. Brandenburg & W.A. Simpson; 8 pp; No. 17)
- Decision Support Systems for Academic Administration (L.J. Moore & A.G. Greenwood; 9 pp; No. 18)
- The Cost Basis for Resource Allocation for Sandwich Courses (B.J.R. Taylor; 7 pp; No. 19)
- Assessing Faculty Salary Equity (C.A. Allard; 7 pp; No. 20)
- Effective Writing: Go Tell It on the Mountain (C.W. Ruggiero, C.F. Elton, C.J. Mullins & J.G. Smoot; 7 pp; No. 21)
- Preparing for Self-Study (F.C. Johnson & M.E. Christal; 7 pp; No. 22)
- Concepts of Cost and Cost Analysis for Higher Education (P.T. Brinkman & R.H. Allen; 8 pp; No. 23)
- The Calculation and Presentation of Management Information from Comparative Budget Analysis (B.J.R. Taylor; 10 pp; No. 24)
- The Anatomy of an Academic Program Review (R.L. Harpel; 6 pp; No. 25)
- The Role of Program Review in Strategic Planning (R.J. Barak; 7 pp; No. 26)
- The Adult Learner: Four Aspects (Ed. J.A. Lucas; 7 pp; No. 27)
- Building a Student Flow Model (W.A. Simpson; 7 pp; No. 28)
- Evaluating Remedial Education Programs (T.H. Bers; 8 pp; No. 29)
- Developing a Faculty Information System at Carnegie Mellon University (D.L. Gibson & C. Golden; 7 pp; No. 30)
- Designing an Information Center: An Analysis of Markets and Delivery Systems (R. Matross; 7 pp; No. 31)
- Linking Learning Style Theory with Retention Research: The TRAILS Project (D.H. Kalsbeek; 7 pp; No. 32)
- Data Integrity: Why Aren't the Data Accurate? (F.J. Gose; 7 pp; No. 33)
- Electronic Mail and Networks: New Tools for Institutional Research and University Planning (D.A. Updegrave, J.A. Muffo & J.A. Dunn, Jr.; 7pp; No. 34)
- Case Studies as a Supplement to Quantitative Research: Evaluation of an Intervention Program for High Risk Students (M. Peglow-Hoch & R.D. Walleri; 8 pp; No. 35)
- Interpreting and Presenting Data to Management (C.A. Clagett; 5 pp; No. 36)
- The Role of Institutional Research in Implementing Institutional Effectiveness or Outcomes Assessment (J.O. Nichols; 6 pp; No. 37)
- Phenomenological Interviewing in the Conduct of Institutional Research: An Argument and an Illustration (L.C. Attinasi, Jr.; 8 pp; No. 38)
- Beginning to Understand Why Older Students Drop Out of College (C. Farabaugh-Dorkins; 12 pp; No. 39)
- A Responsive High School Feedback System (P.B. Duby; 8 pp; No. 40)
- Listening to Your Alumni: One Way to Assess Academic Outcomes (J. Pettit; 12 pp; No. 41)
- Accountability in Continuing Education Measuring Noncredit Student Outcomes (C.A. Clagett & D.D. McConochie; 6 pp; No. 42)
- Focus Group Interviews: Applications for Institutional Research (D.L. Brodigan; 6 pp; No. 43)
- An Interactive Model for Studying Student Retention (R.H. Glover & J. Wilcox; 12 pp; No. 44)
- Increasing Admitted Student Yield Using a Political Targeting Model and Discriminant Analysis: An Institutional Research Admissions Partnership (R.F. Urban; 6 pp; No. 45)
- Using Total Quality to Better Manage an Institutional Research Office (M.A. Heverly; 6 pp; No. 46)
- Critique of a Method For Surveying Employers (T. Banta, R.H. Phillippi & W. Lyons; 8 pp; No. 47)
- Plan-Do-Check-Act and the Management of Institutional Research (G.W. McLaughlin & J.K. Snyder; 10 pp; No. 48)
- Strategic Planning and Organizational Change: Implications for Institutional Researchers (K.A. Corak & D.P. Wharton; 10 pp; No. 49)
- Academic and Librarian Faculty: Birds of a Different Feather in Compensation Policy? (M.E. Zeglen & E.J. Schmidt; 10 pp; No. 50)
- Setting Up a Key Success Index Report: A How-To Manual (M.M. Sapp; 8 pp; No. 51)

## The AIR Professional File—1978-2011

- Involving Faculty in the Assessment of General Education: A Case Study (D.G. Underwood & R.H. Nowaczyk; 6 pp; No. 52)
- Using a Total Quality Management Team to Improve Student Information Publications (J.L. Frost & G.L. Beach; 8 pp; No. 53)
- Evaluating the College Mission through Assessing Institutional Outcomes (C.J. Myers & P.J. Silvers; 9 pp; No. 54)
- Community College Students' Persistence and Goal Attainment: A Five-year Longitudinal Study (K.A. Conklin; 9 pp; No. 55)
- What Does an Academic Department Chairperson Need to Know Anyway? (M.K. Kinnick; 11 pp; No. 56)
- Cost of Living and Taxation Adjustments in Salary Comparisons (M.E. Zeglen & G. Tesfagiorgis; 14 pp; No. 57)
- The Virtual Office: An Organizational Paradigm for Institutional Research in the 90's (R. Matross; 8 pp; No. 58)
- Student Satisfaction Surveys: Measurement and Utilization Issues (L. Sanders & S. Chan; 9 pp; No. 59)
- The Error Of Our Ways; Using TQM Tactics to Combat Institutional Issues Research Bloopers (M.E. Zeglin; 18 pp; No. 60)
- How Enrollment Ends; Analyzing the Correlates of Student Graduation, Transfer, and Dropout with a Competing Risks Model (S.L. Ronco; 14 pp; No. 61)
- Setting a Census Date to Optimize Enrollment, Retention, and Tuition Revenue Projects (V. Borden, K. Burton, S. Keucher, F. Vossburg-Conaway; 12 pp; No. 62)
- Alternative Methods For Validating Admissions and Course Placement Criteria (J. Noble & R. Sawyer; 12 pp; No. 63)
- Admissions Standards for Undergraduate Transfer Students: A Policy Analysis (J. Saupe & S. Long; 12 pp; No. 64)
- IR for IR—Indispensable Resources for Institutional Researchers: An Analysis of AIR Publications Topics Since 1974 (J. Volkwein & V. Volkwein; 12 pp; No. 65)
- Progress Made on a Plan to Integrate Planning, Budgeting, Assessment and Quality Principles to Achieve Institutional Improvement (S. Griffith, S. Day, J. Scott, R. Smallwood; 12 pp; No. 66)
- The Local Economic Impact of Higher Education: An Overview of Methods and Practice (K. Stokes & P. Coomes; 16 pp; No. 67)
- Developmental Education Outcomes at Minnesota Community Colleges (C. Schoenecker, J. Evens & L. Bollman; 16 pp; No. 68)
- Studying Faculty Flows Using an Interactive Spreadsheet Model (W. Kelly; 16 pp; No. 69)
- Using the National Datasets for Faculty Studies (J. Milam; 20 pp; No. 70)
- Tracking Institutional leavers: An Application (S. DesJardins, H. Pontiff; 14 pp; No. 71)
- Predicting Freshman Success Based on High School Record and Other Measures (D. Eno, G. W. McLaughlin, P. Sheldon & P. Brozovsky; 12 pp; No. 72)
- A New Focus for Institutional Researchers: Developing and Using a Student Decision Support System (J. Frost, M. Wang & M. Dalrymple; 12 pp; No. 73)
- The Role of Academic Process in Student Achievement: An Application of Structural Equations Modeling and Cluster Analysis to Community College Longitudinal Data1 (K. Boughan, 21 pp; No. 74)
- A Collaborative Role for Industry Assessing Student Learning (F. McMartin; 12 pp; No. 75)
- Efficiency and Effectiveness in Graduate Education: A Case Analysis (M. Kehrhahn, N.L. Travers & B.G. Sheckley; No. 76)
- ABCs of Higher Education—Getting Back to the Basics: An Activity-Based Costing Approach to Planning and Financial Decision Making (K. S. Cox, L. G. Smith & R.G. Downey; 12 pp; No. 77)
- Using Predictive Modeling to Target Student Recruitment: Theory and Practice (E. Thomas, G. Reznik & W. Dawes; 12 pp; No. 78)
- Assessing the Impact of Curricular and Instructional Reform - A Model for Examining Gateway Courses1 (S.J. Andrade; 16 pp; No. 79)
- Surviving and Benefitting from an Institutional Research Program Review (W.E. Knight; 7 pp; No. 80)
- A Comment on Interpreting Odds-Ratios when Logistic Regression Coefficients are Negative (S.L. DesJardins; 7 pp; No. 81)
- Including Transfer-Out Behavior in Retention Models: Using NSC EnrollmentSearch Data (S.R. Porter; 16 pp; No. 82)
- Assessing the Performance of Public Research Universities Using NSF/ NCES Data and Data Envelopment Analysis Technique (H. Zheng & A. Stewart; 24 pp; No. 83)
- Finding the 'Start Line' with an Institutional Effectiveness Inventory (S. Ronco & S. Brown; 12 pp; No. 84)
- Toward a Comprehensive Model of Influences Upon Time to Bachelor's Degree Attainment (W. Knight; 18 pp; No. 85)
- Using Logistic Regression to Guide Enrollment Management at a Public Regional University (D. Berge & D. Hendel; 14 pp; No. 86)
- A Micro Economic Model to Assess the Economic Impact of Universities: A Case Example (R. Parsons & A. Griffiths; 24 pp; No. 87)
- Methodology for Developing an Institutional Data Warehouse (D. Wierschem, R. McBroom & J. McMillen; 12 pp; No. 88)
- The Role of Institutional Research in Space Planning (C.E. Watt, B.A. Johnston. R.E. Chrestman & T.B. Higerd; 10 pp; No. 89)
- What Works Best? Collecting Alumni Data with Multiple Technologies (S. R. Porter & P.D. Umback; 10 pp; No. 90) Caveat Emptor: Is There a Relationship between Part-Time Faculty Utilization and Student Learning Outcomes and Retention? (T. Schibik & C. Harrington; 10 pp; No. 91)
- Ridge Regression as an Alternative to Ordinary Least Squares: Improving Prediction Accuracy and the Interpretation of Beta Weights (D. A. Walker; 12 pp; No. 92)
- Cross-Validation of Persistence Models for Incoming Freshmen (M. T. Harmston; 14 pp; No. 93)
- Tracking Community College Transfers Using National Student Clearinghouse Data (R.M. Romano and M. Wisniewski; 14 pp; No. 94)
- Assessing Students' Perceptions of Campus Community: A Focus Group Approach (D.X. Cheng; 11 pp; No. 95)
- Expanding Students' Voice in Assessment through Senior Survey Research (A.M. Delaney; 20 pp; No. 96)



## The AIR Professional File—1978-2011

- Making Measurement Meaningful (J. Carpenter-Hubin & E.E. Hornsby, 14 pp; No. 97)
- Strategies and Tools Used to Collect and Report Strategic Plan Data (J. Blankert, C. Lucas & J. Frost; 14 pp; No. 98)
- Factors Related to Persistence of Freshmen, Freshman Transfers, and Nonfreshman Transfer Students (Y. Perkhounkova, J. Noble & G. McLaughlin; 12 pp; No. 99)
- Does it Matter Who's in the Classroom? Effect of Instructor Type on Student Retention, Achievement and Satisfaction (S. Ronco & J. Cahill; 16 pp; No. 100)
- Weighting Omissions and Best Practices When Using Large-Scale Data in Educational Research (D.L. Hahs-Vaughn; 12 pp; No. 101)
- Essential Steps for Web Surveys: A Guide to Designing, Administering and Utilizing Web Surveys for University Decision-Making (R. Cheskis-Gold, E. Shepard-Rabadam, R. Loescher & B. Carroll; 16 pp; No. 102)
- Using a Market Ratio Factor in Faculty Salary Equity Studies (A.L. Luna; 16 pp; No. 103)
- Voices from Around the World: International Undergraduate Student Experiences (D.G. Terkla, J. Etish-Andrews & H.S. Rosco; 15 pp; No. 104)
- Program Review: A tool for Continuous Improvement of Academic Programs (G.W. Pitter; 12 pp; No. 105)
- Assessing the Impact of Differential Operationalization of Rurality on Studies of Educational Performance and Attainment: A Cautionary Example (A. L. Caison & B. A. Baker; 16pp; No. 106)
- The Relationship Between Electronic Portfolio Participation and Student Success (W. E. Knight, M. D. Hakel & M. Gromko; 16pp; No. 107)
- How Institutional Research Can Create and Synthesize Retention and Attrition Information (A. M. Williford & J. Y. Wadley; 24pp; No. 108)
- Improving Institutional Effectiveness Through Programmatic Assessment (D. Brown; 16pp; No. 109)
- Using the IPEDS Peer Analysis System in Peer Group Selection (J. Xu; 16pp; No. 110)
- Improving the Reporting of Student Satisfaction Surveys Through Factor Analysis (J. Goho & A Blackman; 16pp; No. 111)
- Perceptions of Graduate Student Learning via a Program Exit Survey (R. Germaine & H. Kornuta; 16pp; No. 112)
- A Ten-Step Process for Creating Outcomes Assessment Measures for an Undergraduate Management Program: A Faculty-Driven Process (S. Carter; 18pp; No. 113)
- Institutional Versus Academic Discipline Measures of Student Experience: A Matter of Relative Validity (S. Chatman; 20pp; No. 114)
- In Their Own Words: Effectiveness in Institutional Research (W. E. Knight; 20pp; No. 115)
- Alienation and First-Year Student Retention (R. Liu; 18 pp; No. 116)
- Estimating the Economic Impact of Higher Education: A Case Study of the Five Colleges in Berks County, Pennsylvania (M. D'Allegro & L. A. Paff; 17 pp; No. 117)
- Improving the Way Higher Education Institutions Study Themselves: Use and Impact of Academic Improvement Systems (K. K. Bender, J. L. Jonson & T. J. Siller; 23pp; No. 118)
- Top-Down Versus Bottom-Up Paradigms of Undergraduate Business School Assurance of Learning Techniques (R. Priluck & J. Wisenblit; 15pp; No. 119)
- The Rise of Institutional Effectiveness: IR Competitor, Customer, Collaborator, or Replacement? (C. Leimer; 17pp; No. 120)
- Keeping Confidence In Data Over Time: Testing The Tenor Of Results From Repeat Administrations Of A Question Inventory (E. Boylan; 14pp; No. 121)
- First, Get Their Attention: Getting Your Results Used (C. Leimer; 17pp; No. 122)



**Association for  
Institutional Research**



Association for  
Institutional Research

The AIR Professional File is intended as a presentation of papers which synthesize and interpret issues, operations, and research of interest in the field of institutional research. Authors are responsible for material presented. The AIR Professional File is published by the Association for Institutional Research.

## MANAGING EDITOR:

### Dr. Randy L. Swing

Executive Director  
Association for Institutional Research  
1435 E. Piedmont Drive  
Suite 211  
Tallahassee, FL 32308  
Phone: 850-385-4155  
Fax: 850-385-5180  
[air@airweb.org](mailto:air@airweb.org)

Dr. Gerald McLaughlin provided editorial oversight for the production of this manuscript.

## AIR PROFESSIONAL FILE EDITORIAL BOARD

### Dr. Trudy H. Bers

Senior Director of  
Research, Curriculum and Planning  
Oakton Community College  
Des Plaines, IL

### Dr. Stephen L. Chambers

Director of Institutional Research  
and Assessment  
Coconino Community College  
Flagstaff, AZ

### Dr. Anne Marie Delaney

Director of  
Institutional Research  
Babson College  
Babson Park, MA

### Mr. Jacob P. Gross

Associate Director for Research  
Indiana University/Project on Academic Success  
1900 E 10th Ste 630  
Bloomington, IN

### Dr. Ronald L. Huesman Jr.

Assistant Director,  
Office of Institutional Research  
University of Minnesota  
Minneapolis, MN

### Dr. David Jamieson-Drake

Director of  
Institutional Research  
Duke University  
Durham, NC

### Dr. Julie P. Noble,

Principal Research Associate  
ACT, Inc.  
Iowa City, Iowa

### Dr. Gita W. Pitter

Associate VP, Institutional Effectiveness  
Florida A&M University  
Tallahassee, FL 32307

### Dr. James T. Posey

Director of Institutional Research & Planning  
University of Washington  
Tacoma, WA 98402

### Dr. Harlan M. Schweer

Director, Office of Institutional Research  
College of DuPage  
Glen Ellyn, IL

### Dr. Jeffrey A. Seybert

Director of  
Institutional Research  
Johnson County Community College  
Overland Park, KS

### Dr. Bruce Szelest

Associate Director of  
Institutional Research  
SUNY-Albany  
Albany, NY

### Mr. Daniel Jones-White

Analyst  
University of Minnesota  
Minneapolis, MN