



Holding onto the GREEN ZONE

Action Guide

A Youth Program for the Study and Stewardship of Community Riparian Areas



A Joint Project of the Bureau of Land Management, the University of Wisconsin-Extension, and the USDA Cooperative State Research, Education, and Extension Service

Holding onto the GREEN Zone Action Guide
A Youth Program for the Study and Stewardship of Community Riparian Areas
2008

Photos are courtesy of BLM unless otherwise noted.

Publication Index Number
BLM/WO/GI-07/019+8600
EE8007B

TABLE OF CONTENTS



Welcome	1
Unit 1 – Get a Clear Picture	5
Unit 2 – Solve the Puzzle	13
Station 1 – Shaping the GREEN Zone.	15
Station 2 – Water Quantity and Soils in the Zone	27
Station 3 – Water Quality and Plants in the Zone	35
Station 4 – Land Uses in the Zone: Working Toward a Healthy Balance.	45
Conclusion	51
Unit 3 – Get into the Zone.	53
Water Ecologist Field Guide	57
Soil Scientist Field Guide.	71
Biologist Field Guide	83
Physical Geographer Field Guide.	95
Unit 4 – Putting the Pieces Together	105
Unit 5 – Tell the News	109
Glossary	113

WELCOME

Scientists call the land along the edges of a river, stream, or lake a riparian zone. We call it the GREEN Zone.



Have you ever noticed how the land along the banks of a river or stream, or the shores of a lake often looks different from the surrounding area? As you approach a stream on a hot, sunny day, for instance, you might move from bright sunshine to deep shade. The temperature seems cooler, and the sound of birds singing might fill the air. Scientists have a special name for these areas. They call them riparian zones.

In this guide, we call the riparian zone the GREEN Zone. If you look at the cover of this guide, you'll understand why. **Riparian zones make up only a small part of land in the United States. But they are very important.** They protect water quality and quantity, supply food and shelter for fish and wildlife, and provide many other services.

Do you have a riparian zone or GREEN Zone in your community? Do you know what you can do to keep it healthy? With the

help of The GREEN Zone Action Guide, you'll be able to sharpen your vision and learn to recognize the key pieces of the riparian zone. You'll find out how you can get involved to make sure that:

- the water in your community will remain clean and abundant;
- the plants and animals in the water and nearby will remain healthy; and
- you, your family, and friends can continue to enjoy the riparian zones in your community.



Bullock's Oriole. Photo courtesy of U.S. Fish & Wildlife Service

The GREEN Zone Action Guide

Observe,
measure, dig,
get wet,
get dirty –
have fun!

This guide will help you explore what GREEN Zones are and why they are important. It's filled with fun activities that will help you learn the skills you'll need for investigating a local GREEN Zone. This is an opportunity to get into the Zone for a closeup look. Observe, measure, dig, get wet, get dirty – have fun!

You'll have an opportunity to put your investigation skills to the test indoors (Unit 2) and on a field trip to a riparian zone (Unit 3).

Work with your leader or teacher to determine a plan of action. If possible, try to invite one or more scientists or other natural resource professionals to help with your investigations.

On the next page is an outline of the steps involved in your GREEN Zone adventure. Review them with your leader or teacher. Then create a timetable like the one at the bottom of the page to help you keep on track.



Green frog in a riparian zone of the Stonehouse Wilderness Study Area, BLM Burns District, Oregon

Holding onto the GREEN Zone

Planning Your GREEN Zone Adventure

Unit 1 GET A CLEAR PICTURE –

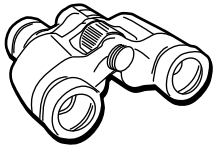

This unit will help you discover the secrets of the GREEN Zone – what it is and why it is important.

focus on a different scientific specialty. If available, a local natural resource professional may join you on your trip to provide information and guidance.

Unit 2 SOLVE THE PUZZLE –

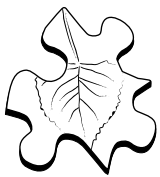

Determining the health of a riparian zone is like solving a jigsaw puzzle – to see the big picture clearly, you need to figure out how all the pieces fit together. Your challenge is to identify the important parts and functions of the GREEN Zone and then explore what makes a riparian zone healthy or unhealthy. Activities at four science stations provide important clues.

Unit 4 PUTTING THE PIECES TOGETHER –

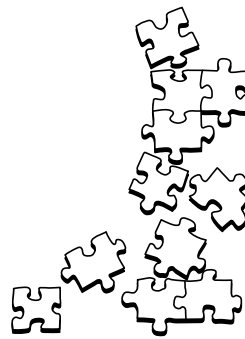

Back in the classroom or home base, your management team will study the information you collected on your field trip. What is the state of your GREEN Zone right now? Can you predict what it might be like in the future? What can you and the people in your community do to maintain or improve this vital resource?

Unit 3 GET INTO THE ZONE –



Choose a stream or river in your community to explore on a field trip. You will be part of a student land management team that will collect information about your riparian zone. Each team will

Unit 5 TELL THE NEWS –

Finally, decide how to share what you learned about the GREEN Zone with community leaders and residents.



TIMETABLE

Unit	Estimated Starting Date	Date Completed
1 GET A CLEAR PICTURE	March 14	March 16
2 SOLVE THE PUZZLE	March 17	April 16
3 GET INTO THE ZONE	April 24	May 3
4 PUTTING THE PIECES TOGETHER	May 4	May 19
5 TELL THE NEWS	May 20	May 27

Holding onto the GREEN Zone

Get Organized



Take Good Notes



Keep Data Organized



Follow Scientific Methods

Your results will be more meaningful if you take good notes and follow scientific methods. So it's important to keep your notes, materials, and data organized; a "Zone

Notebook" will be very helpful.

To help you stay organized, watch for the following symbols throughout the guide:



Activity

This symbol means it's time for an experiment or demonstration. Look for the symbol to see what materials you need and how you should proceed.

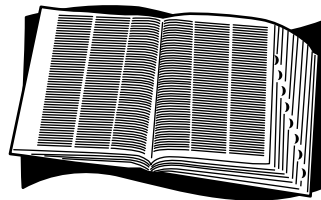

Zone Words

Zone Words are key terms found in each unit. These words are defined in the text and in the glossary at the end of this booklet.

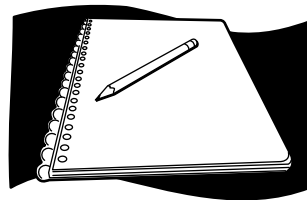

Zone Notes

Reflect on what you've learned and record your observations.

Pay particular attention to the Zone Notes symbol. It reminds you to take notes or answer questions. Use your Zone Notebook to organize your Zone Notes pages, field trip data, maps, and other resources that define the GREEN Zone. The Notebook will be your personal journal of your GREEN Zone adventure.

UNIT 1 - Get a Clear Picture



Introduction

It is remarkable how green and lush riparian zones can be, even in arid lands such as those found in the western United States. The areas adjacent to rivers, streams, and lakes are special places that take up very little space in our landscapes. Yet they provide us with an amazing number of services and benefits.

Riparian zones store and purify water, reduce damage from floodwaters, and provide habitat for wildlife and people—to name just a few.

But healthy riparian zones have been slipping out of our hands. Scientists estimate that “...on average, the lower 48 states have lost more than 60 acres of riparian/wetland areas for each hour that has passed

between the 1780s and 1980s.”¹

What do riparian zones look like? What makes them so special? How can you tell whether a riparian zone is healthy or not? These are just a few of the questions you’ll examine in Unit 1. After you “Get a Clear Picture,” you’ll be on your way to answering another important question: How do we hold on to a healthy, productive GREEN Zone?

Chances are, even though you might not have heard the term “riparian,” you probably have spent some time in a riparian zone. Try the activity on page 6 to find out what you’ve already observed about these special places.

¹ Paul L. Hansen and others, *Classification and Management of Montana’s Riparian and Wetland Sites* (Missoula: University of Montana, 1995)

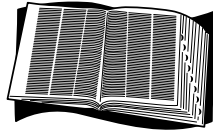

Zone Words

ecosystem: a system or area defined by a community of living organisms (animals, plants, bacteria) and their environment working together. A meadow, forest, and wetland are all different types of ecosystems.

ecotone: a natural area where two ecosystems overlap. In an ecotone there is a gradual transition from the plants and animals found in one ecosystem to the plants and animals found in the other.

proper functioning condition: a term used to describe a healthy riparian zone and the way in which its component parts—especially the water, plants, soil, and landforms—work together to provide a variety of services and benefits.



Unit I, Activity I – On the Edge

You will need:

Pictures of streams, rivers, or lakes and the land along them. (These can be from magazines or they can be photographs of places you have been.)



Directions

Take turns talking about the picture or pictures you've brought. Describe

what they show. If you've been to the place in the picture, describe what you remember about the area. What did you do there? Did you spend time in the water...along the water's edge? What were other people doing? What was the water like? Were there rocks or dirt along the shore or banks? What types of plants did you see? Trees, shrubs, grasses? Did you see birds or other animals there?



Zone Notes – On the Edge

Look at all the pictures together. Make a list in your Zone Notes of some characteristics these places have in common.

Finding the GREEN Zone

When looking for the GREEN Zone, natural resource professionals might study the land along some of the nation's largest rivers and lakes—the Hudson, Mississippi, or Columbia Rivers; or Lakes Champlain, Superior, or Tahoe. They might also study the area surrounding the small pond down the road or the

stream that runs by the local playground. No matter what the size of the area they are examining, these scientists will look for certain common characteristics that tell them they've found the riparian zone. In the following activity, you and a partner will try to find the GREEN Zone.



Unit 1, Activity 2 – Zone Search

You will need:

- The photos of riparian zones shown on this page

Directions

1. Look closely at each of the photos with your partner.
2. Find the riparian zone in each photo.
3. Use your finger to outline where you think the edges of the riparian zone are in each picture.
4. Talk about the clues you used to locate the riparian zones.



Zone Notes – Zone Search

In your Zone Notebook, list the clues you and your partner used to locate the zones. Then answer the following questions:

- What things (living and non-living) do you think might be found in these zones?
- What characteristics do these two riparian zones have in common?

When One + One = More Than Two

Now that you know what riparian zones look like, you might wonder what makes them such special places. You could say that a riparian zone is something like a peanut butter and jelly sandwich. Peanut butter tastes good, and jelly tastes good. But if you combine the two, many would say you've got a treat that tastes even better.

Riparian zones combine the characteristics of two ecosystems—land and water. They are places where you will find a wide variety of plants and animals that come from the two ecosystems. Scientists call the place where two ecosystems combine an **ecotone**. Make your own representation of an ecotone in the activity below.



Unit 1, Activity 3 – Ecotone Explorations

You will need:

- A piece of white paper
- Two highlighting markers, preferably blue and yellow (water colors will also work)

Directions

1. On a single piece of paper, draw two large spots with your highlighting markers – one blue and one yellow.
2. Make each spot larger and larger until they overlap. What happens where they touch? What color do you see?



Zone Notes – Ecotone Explorations

- Imagine that the color blue represents a pond or a stream. The color yellow represents a meadow. Label the circles on your paper with these names.
- Now label the overlapping area. What name could you give to the area of overlap (the green area)? Hint: There could be several answers.
- What would represent the upland ecosystem and the aquatic ecosystem in your drawing? Look in the Glossary if you need help with these words, and then label your ecotone painting.
- Tape or glue your painting in your Zone Notebook.

Healthy or Not?

Riparian zones can only perform their important functions if they are healthy. Scientists call this “proper functioning condition.” They have developed checklists to help them determine if riparian zones are functioning properly or working well. These checklists cover such things as the types and variety of plants in the

zone, the characteristics of the soil and water, and the appearance of the stream channel. Assessing the health of a riparian zone can be a complicated process; it’s not always easy to tell just from looking at the zone. But in the following activity, you’ll be able to notice a few differences between a healthy and an unhealthy riparian zone.



Unit I, Activity 4 – Texas Creek Gets Better

Your challenge is to compare the Texas Creek stories and photos from 1976 with those from 1987, and discuss the differences. The “news articles” describe what land managers and ranchers actually did to hold onto Texas Creek in south central Colorado.

You will need:

- The photos of Texas Creek on page 10
- A copy of the news clippings (page 10) for your group to read

Directions

1. Read the news articles and compare the photos of Texas Creek from 1976 and 1987.

2. Discuss with your group:

- a. How did scientists know that Texas Creek was an unhealthy stream in 1976?
- b. Could they tell if Texas Creek was healthy or unhealthy just by looking? Why or why not?
- c. What did land managers and ranchers do to change the situation?
- d. What benefits can Texas Creek now offer to local residents?



Zone Notes – Texas Creek Gets Better

Reflect on the Texas Creek stories and your group discussion. What do you think are some of the differences between a healthy and an unhealthy riparian zone? Write down your ideas.

TEXAS CREEK NEWS

SEPTEMBER, 1976



Texas Creek Flunks the Test Scientists brought in by concerned ranchers declared Texas Creek unhealthy this week. Results of recent tests show that the creek and adjacent riparian zone are unstable with damage from improperly managed livestock grazing. This small, cold-water stream flows 24 miles in south-central Colorado from the Sangre de Cristo Mountains to the Arkansas River. It is on public lands managed by the Bureau of Land Management (BLM).

According to scientists, the stream's riparian zone has poor water quality and quantity, and degraded fish and wildlife habitats. The brown trout population is well below this stream's potential. Livestock forage is minimal. A BLM team will work with community members and ranchers to collect data and use the information to develop stream improvement methods for Texas Creek.

TEXAS CREEK NEWS

JULY, 1987



Small Changes Score Big for Area Creek Local ranchers are celebrating the full recovery of Texas Creek this month, a dozen years after scientists declared it unhealthy. They credit a 1977 riparian management plan for the creek's improvement. Better fencing and changes in grazing practices made a big difference.

It took just two years for the riparian habitat to start getting better. One indicator was that the stream's brown trout population more than doubled. The creek was noticeably healthier, but still didn't meet its potential for wildlife habitat, livestock forage, and recreation. Rangeland managers were concerned about too much bare soil and lower quality vegetation in the riparian zone.

These days, Texas Creek is healthy thanks to continuing care. Lush vegetation with strong roots covers and holds the soil. Erosion has decreased while water quality and quantity have increased. Bighorn sheep and brown trout now thrive, as do many other species of wildlife. Livestock forage is plentiful. Small changes in riparian management practices have scored big for Texas Creek.

_____	_____
_____	_____
_____	_____
_____	_____
_____	_____

Lifelines

Riparian zones are sometimes called lifelines, because plants thrive in the types of soil and the abundance of water found there. The plants, in turn, provide food and shelter for a variety of animals.

They also shade the stream, keeping water temperatures more suitable for aquatic life. In arid parts of the West, riparian zones can be critical to the survival of

many creatures. Scientists estimate, for example, that more than half of all bird species in the southwestern United States are completely dependent on riparian zones. In the following activity, you can learn about some of the birds that inhabit the riparian zone surrounding the San Pedro River in southern Arizona and northern Mexico.



Unit 1, Activity 5 – Lifelines of the West

You will need:

- The “Nature’s Lifelines” poster displayed by your teacher or leader
- A bird field guide
- Access to the Internet or the library

Directions

1. Describe the riparian zone you see in the poster as well as the surrounding area.
2. In the field guide, look up one of the following bird species, a few of the many that spend all or part of the year near the San Pedro River: Vermilion Flycatcher, Yellow

Warbler, Bell’s Vireo, Bullock’s Oriole, Common Yellowthroat.

3. Choose one of the species and, using the Internet or reference material in the library, prepare a brief report on its behavior and its habitat needs.



Zone Notes – Lifelines of the West

Answer the following questions in your Zone Notebook:

- What attracts birds to riparian zones?
- List other living things that are attracted to riparian zones. What creatures might feed in, rest in, or travel through these areas?
- Think about riparian zones in your community. What animals are attracted to these zones?
- Explain why you think riparian zones are sometimes called “lifelines.”

Next Time

Now you know what a riparian zone looks like and at least some of the reasons why they are so important. Do you know where to look for a GREEN Zone in your community?

Next you'll sharpen your view by looking at some of the important characteristics and functions of riparian zones. You'll see that a riparian zone resembles a complex puzzle with many interrelated pieces.

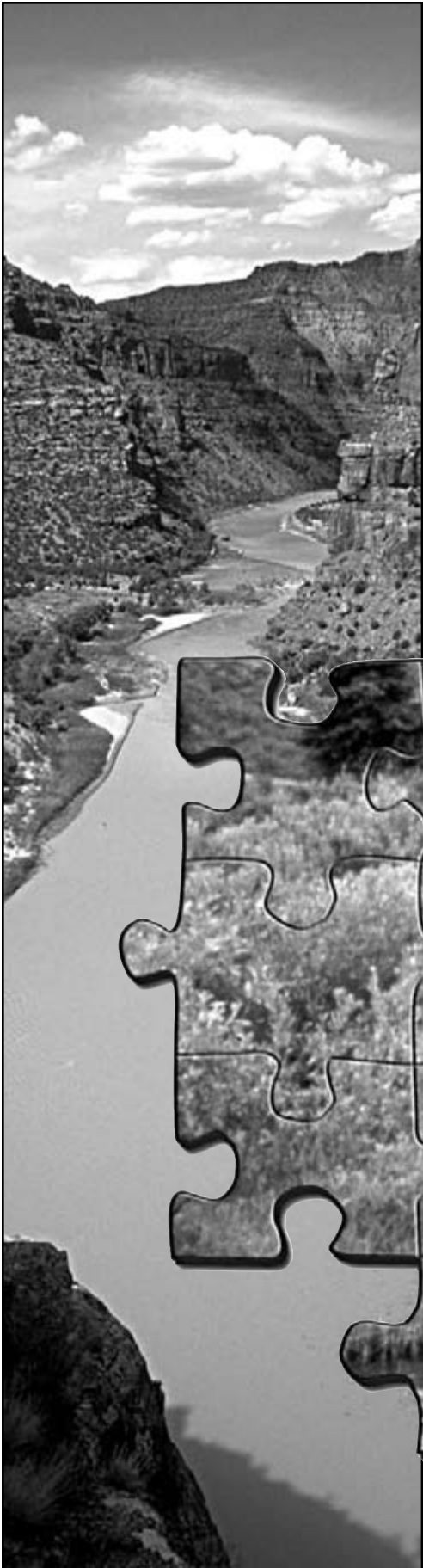

UNIT 2 - Solve the Puzzle



Introduction

Understanding the GREEN Zone is like putting together a jigsaw puzzle—you need to look carefully at many different pieces to see the big picture. Can you imagine trying to put together a puzzle with pieces that change? That’s more or less what riparian land managers do. Their work is challenging because the GREEN Zone is a dynamic ecosystem—it is constantly changing.

Water is the most important piece of the GREEN Zone puzzle, but you may not always see it. Some streams may slow to a trickle or dry up entirely at certain times of the year. The water may still be apparent, though, because vegetation in the zone often remains lush and green, and wildlife may be abundant.

There are other important pieces of the GREEN Zone puzzle, including the plants, the soil, and the surrounding land—not only the shape of the land but the way it is used. If you can understand how all these puzzle pieces fit together, you can begin

to understand how the riparian zone functions. And you will also begin to see how a healthy GREEN Zone can provide a variety of services and benefits to your community.

A riparian zone actually has many jobs, or functions. To name just a few, it:

- slows the speed of high, fast-moving water, which helps to reduce erosion;
- traps sediment, keeping it out of the water and adding to the soil in the surrounding floodplain;
- stores flood water and recharges groundwater;
- supports root masses that strengthen stream banks;
- creates areas in the water that are calm and deep, providing habitat for fish, waterfowl, and other aquatic animals; and
- supports greater numbers and varieties of plants and animals.



Natural resource specialists say that a healthy riparian zone is in **proper functioning condition**; in other words, if it can do its job, a riparian zone is considered healthy.

To assess whether a GREEN Zone is functioning properly (is healthy), natural resource specialists investigate the following areas:

- Water quality and quantity

- Soil qualities
- Plant characteristics
- Stream shape, slope, and speed
- Stream erosion and deposition
- Land uses – human, livestock, and wildlife

Solving the GREEN Zone Puzzle: Study Stations

To help you investigate these areas, your teacher/leader has set up four study stations. Your group will be divided into teams to complete the activities at each station.

STATION 1 – Shaping the GREEN Zone

STATION 2 – Water Quantity and Soils in the Zone

STATION 3 – Water Quality and Plants in the Zone

STATION 4 – Land Uses in the Zone: Working Toward a Healthy Balance

Each station has activities or demonstrations for your team to complete. Take notes, answer questions, and reflect on your results in your Zone Notes. When everyone has completed all four stations, your group will work together to explain how the pieces of the GREEN Zone fit together and will begin making plans to study a GREEN Zone in your community.

Unit 2 - Station 1

SHAPING THE GREEN ZONE



As you've already discovered, water is a key part of any riparian zone. It creates a "lifeline" by helping plants to grow. But water also plays an important role in shaping the land you see in and around the zone.

The stream in a healthy riparian zone:

- moves water and sediment in balance;
- can spread out over the surrounding floodplain; and
- flows between banks that are protected by riparian vegetation.

The shape, or **topography**, of the riparian zone is constantly changing as a stream moves across the land. The stream may begin as a rush of water over rocks on a steep mountain slope but may eventually empty onto a wide, flat valley. Rushing water carries away soil and rock—called **sediment**—and washes them downstream (**erosion**). As the water slows down, the sediment falls out (**deposition**), forming new layers of soil. These natural processes shape riparian landscapes.

When a fast-moving stream floods and overflows its banks, the water spreads out over the land and slows down. When the water recedes, it leaves behind some of its load of soil and nutrients. Riparian plants and crops, and the animals that depend on them, benefit from the rich soil left behind.

Slowing water down is an important function of the GREEN Zone. Not only does slow-moving water deposit soil and nutrients, but the water itself can soak more easily into the surrounding land, which has added benefits for the GREEN Zone, as you'll see in Station 2.

Plants provide shade, cover, and food for animals, but they also play an important role in shaping riparian zones. Plants filter sediment, which aids deposition. In addition, leaves, stems, and roots create resistance that slows fast-moving waters, decreasing the effects of erosion. Even dead trees can play a role in shaping the GREEN Zone. When trunks and branches fall into stream channels, the slope of the stream can change and the speed of flowing water is reduced.



When the processes of erosion and deposition occur in balance, riparian zones remain healthy. When the balance is tipped by nature or poor land use decisions, riparian health suffers.

In a healthy riparian zone, the landforms:

- provide places for floodwaters to spread

out and sink in to recharge groundwater supplies;

- reduce the speed of rushing water; and
- create habitat with rich soils where riparian plants can take root.

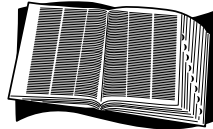

Zone Words

deposition: the process that occurs when sediment (sand, clay, gravel, cobble) falls out of the water, wind, or ice that carries it. A process that builds (or deposits) soil, deposition is the opposite of erosion, a process that carries soils away.

erosion: the wearing away or separation of soil and rock from the land by water, wind, ice, or gravity.

sediment: soil, rock fragments, and other material transported and deposited by water, wind, or other forces.

At this station, you will:

- observe how landforms are created by the movement of water;
- demonstrate how the shape of the land affects the speed of water in a stream; and
- examine how riparian vegetation affects the ability of water to shape the land.



This section of the Yellowstone River in Wyoming is an example of a natural straight stream. There is no floodplain development—all of the stream energy is slowly cutting the streambed deeper.

Photos courtesy of bigskyfishing.com



In flatter terrain with softer soils, the Yellowstone River created this wide valley and the floodplain on the valley floor.

River Profiles

From the stream channel to the upland area, there are several types of landforms that are commonly found in riparian zones.

Floodplains and Terraces

After snowmelt, spring rains, and summer storms, we expect to see high, fast-moving water in streams and rivers. These events often result in streams overflowing onto, or flooding, adjacent lands. In mountain streams, where the banks are steep and armored by hard rock surfaces, floodwaters shoot downhill much as water shoots through the tubes of a water slide.

In areas with more gradual slope, floodwaters overflow

the banks, covering the land next to the stream. When the water recedes, the sediment and rock it carried are left on the surrounding land. Over time, these rich deposits create flat areas in the GREEN Zone called **floodplains**.

Floodplains provide several important services. They:

- reduce erosion by allowing water to spread out and slow down;
- slow water enough so it can seep into soil and recharge groundwater; and
- collect sediment that settles from the water, building deep, rich soils.

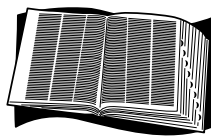

Zone Words

floodplain: a flat area on either or both sides of a stream or river that is created by periodic flooding.

meander: the “S” shape of many streams and rivers.

point bar: an area found on the inside of a river meander where sediment

is deposited after falling out of slow-moving water.

stream channel: the bed where a natural stream of water runs or may run.

terrace: a stair-like landform that is a former floodplain of a stream.

upland: the higher ground in a watershed, away from the stream, river, or lake. Uplands are usually drier than riparian zones.

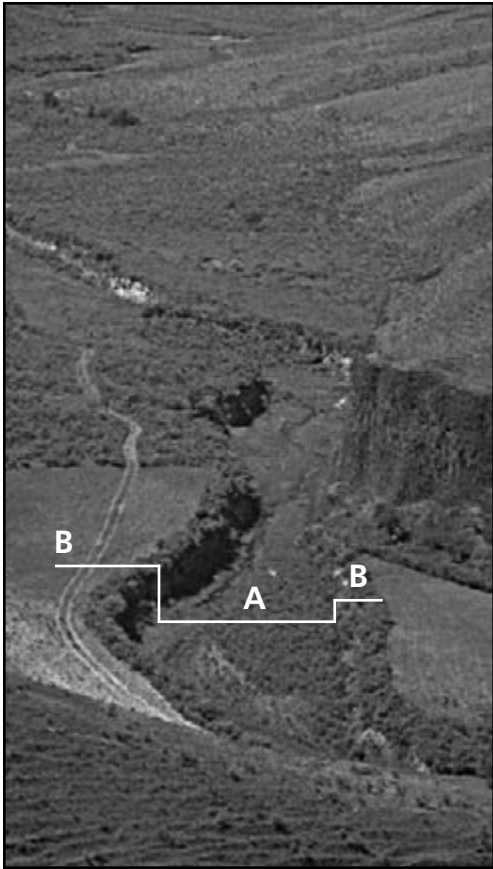

This stream in Oregon has a floodplain flanked by terraces, where an old floodplain used to be. A = current floodplain and stream channel; B = older floodplain

Slow-flowing water on the inside of meander curves deposits sediment that can lead to the creation of point bars. A = slower water deposits sediments here; B = faster water erodes soil here



Holding onto the GREEN Zone - Unit 2, Station 1

Where a stream has cut through an old floodplain, terraces are created. These flat areas adjacent to, and higher than, floodplains indicate the location of older floodplains.

When a stream cuts deeply into the soil or when people replace its banks with cement walls, the stream may not overflow onto its floodplain. This can mean that the plants in the GREEN Zone don't get the water they need to survive. It can also result in greater quantities of water flowing downstream, which can cause more severe flooding, increase erosion, and reduce water quality.

Meanders and Point Bars

Erosion and deposition occur naturally along stream banks, particularly in the soft soils of floodplains. As streams move across flat terrain, the processes of erosion and deposition create curvy, S-shaped forms called **meanders**. A small rock caught in the flowing waters of a stream might experience a ride similar to a car going around a sharp curve. As the rock approaches a curve, it shoots toward the outside bank where the water is flowing most rapidly. For this reason, it is normal for erosion to occur along the outer bank of a stream curve. Pools, areas of deeper, cooler water, are formed as rushing water scours the outside bends of stream banks.

At the inside of a curve, where the flow is slower, the stream will drop some of its load of sediment. Where enough sediment is deposited to rise out of the stream, **point bars** are created. This is how curves and bends of meanders are created and re-created and how floodplains are maintained. Over time, natural stream channels will meander across the floodplain.



Unit 2, Station 1, Activity 1 – River Profiles

In this activity, you and your team members will use diagrams to describe landforms in a river valley.

Your team will need:

- Aerial photo of river valley with landforms labeled (below)
- Diagram of a river valley in cross-section (one for each team member— your leader will provide)

Directions

1. Look at the aerial photo of the river valley and note the labeled landforms.

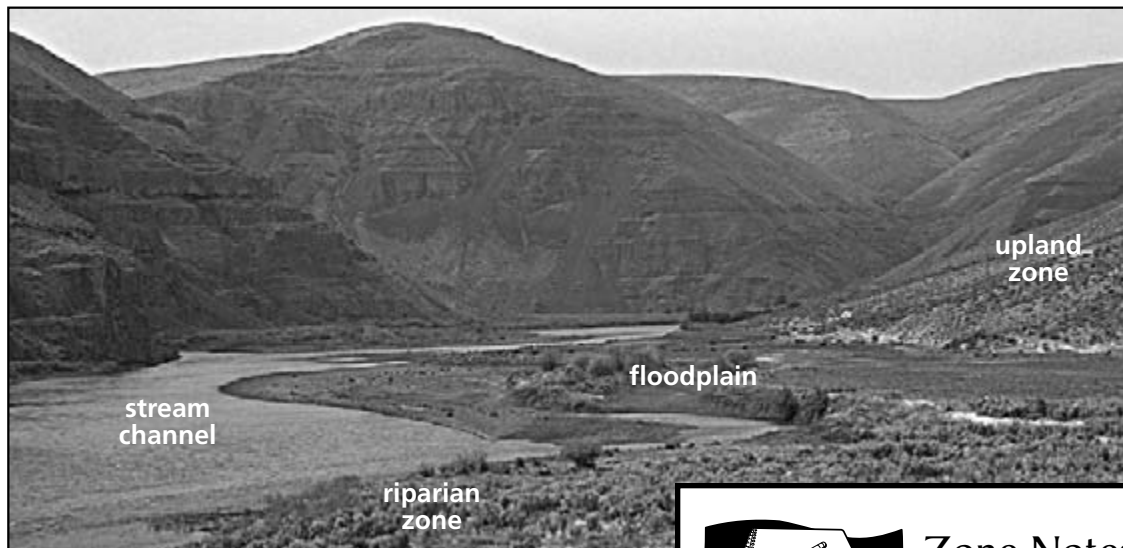
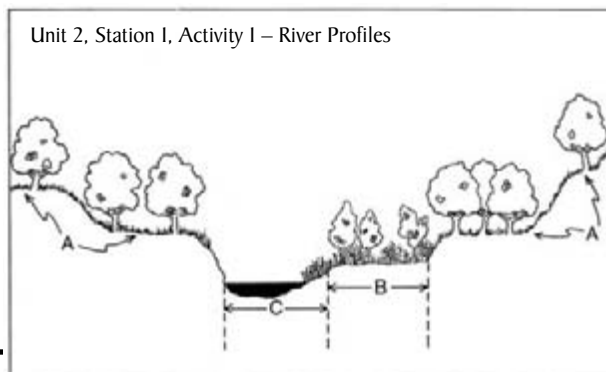

Photo courtesy of Natural Resources Conservation Service



2. Next, refer to the diagram that shows a river valley in cross-section.
3. Try to locate the following features of the river valley in the diagram: stream channel, floodplain and riparian zone, and upland zone. Fill in the blanks in the diagram with the appropriate titles.
4. Add your labeled diagram to your Zone Notebook after completing this activity.



Zone Notes - River Profiles

- How would you recognize a floodplain in the GREEN Zone?
- If a stream's floodwaters cannot access the floodplain, how do you think this would affect the surrounding riparian vegetation? How would the flow of water downstream be affected?



Putting on the Brakes

In nature, the speed of water in a stream depends on many things, including

- the shape of the stream;
- the slope of the streambed;
- the amount of water in the channel; and
- the resistance created along the banks and the streambed by such things as rocks and vegetation.

Slowing water down is an important function of the riparian zone. But how does this occur? Let's look more closely at one possibility.



Photo courtesy of Natural Resources Conservation Service



Unit 2, Station 1, Activity 2 – Putting on the Brakes

In this activity, your team will explore ways in which the flow of water in a stream can be slowed by the shape of the stream. A marble will represent the water and a shoe box will represent the channel and banks of your stream. If possible, work in teams of two.

Your team will need:

- Ruler (cm)
- Stopwatch
- Paper and pencil
- Large shoe box
- Scissors
- Marble
- Assorted materials such as paper, cardboard, cotton swabs, cotton balls, glue, paper clips, tacks, staples, tape (masking, duct, etc.)

Directions

1. Construct your stream model by making a hole in the middle of a narrow end of the shoe box. Make sure the hole is big enough to drop a marble through without touching the box. Elevate the end of the box with the hole in it by approximately 2-3 cm, as seen in the diagram at right.

2. Measure the inside length of the box, as shown. In your Zone Notes, create a chart, like the one below, to record your data.

3. One team member will be the timer, who operates the stopwatch, while the other will release the marble. After counting down “3-2-1-GO,” the timer starts the stopwatch and the second team member releases the marble through the hole. When the marble reaches the end of the box, the timer should stop the stopwatch and note the number of seconds in the chart. Calculate the velocity.

4. Your challenge is to slow your marble down by at least half its original speed, using the materials supplied to create a winding path. Chart your marble’s velocity each time you test a different idea. Keep track of what you used, keeping in mind that your challenge is to slow the marble down—not stop it completely.

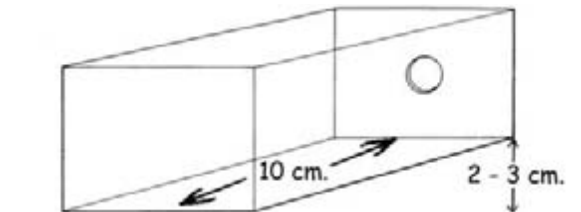

Unit 2, Station 1, Activity 2 – Putting on the Brakes

Trial Number	1	2	3, etc.
Materials Used	None		
Length of Box (Distance)			
Number of seconds marble took to roll from one end to the other (Time)			
Velocity of the Marble (D/T = ____ cm/sec)	This is your Baseline		



Zone Notes - Putting on the Brakes

- Include the chart describing each speed test in your notebook. Make sure you label your chart.
- Describe how you slowed the marble in your shoe-box stream.
- In nature, what slows down the water in a stream? Think of as many ideas as you can and list them.



Brookgrass, with its above-ground horizontal stems and many shallow roots, traps sediment and is a good colonizer. Photo by Gary Larson



Nebraska sedge is a riparian plant with long, strong roots for holding power—a good stabilizer.



Fast waters caused excessive erosion at this site, which destroyed the stream bank and altered the shape of the land. Roots of plants in a healthy riparian zone prevent this type of damage by slowing water, holding soil, and shielding the bank from the force of rushing water. Photo courtesy of Natural Resources Conservation Service

Plant Power

Plants in the riparian zone thrive on the water that exists there. They perform many important services for wildlife, livestock, and people. **By filtering and slowing water in the channel and during times of flooding, plants play a major role in shaping the GREEN Zone.**

Building Soil

The first European settlers in the New World (America) established colonies and were known as colonizers. In the same way, the first plants to grow on bare soil along a stream bank are sometimes called **colonizers**. Colonizers send out stems sideways above ground to take root and grow new plants in other places. This enables them

to spread quickly in newly deposited soils.

Colonizing plants are important to the riparian zone because they trap sediments, including those that are very fine and flour-like. This helps build soils where more permanent, stabilizing plants can become established.

Stabilizers are plants that commonly have binding roots with many interconnected branches that spread down through the soil. Many have coarse leaves, woody stems, and strong crowns—the part of the plant where the stems and roots come together. These characteristics combine to help stabilizing plants protect stream banks from the forces of erosion.¹

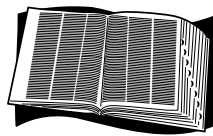

Zone Words

colonizers: plants that are the first to grow in bare areas where streambeds and banks have been disturbed.

crown: the part of a plant where the stems and roots come together.

stabilizers: plants with strong crowns and roots that anchor the soil along stream banks.

¹ Alma H. Winward, *Monitoring the Vegetation Resources in Riparian Areas*. Gen. Tech. Rep. RMRS - GTR-47. (USDA Forest Service, 2000)



Shaping Streambeds and Banks

What happens when fast-moving water shoots through a stream that has healthy streamside vegetation? The stems, leaves, and roots create resistance that helps slow the water. Strong roots also hold onto the soil along stream banks. The

banks erode below the roots, shaping the banks and streambed like a bowl. Undercut banks and shade from overhanging vegetation help to moderate water temperatures on hot summer days and provide habitat for aquatic life. Riparian vegetation—particularly the stabilizers with their long, strong roots—helps hold the GREEN Zone together.



The undercut banks and overhanging vegetation in this Oregon stream (above) help to moderate water temperatures and make the stream habitat better for fish and other aquatic organisms.



Unit 2, Station 1, Activity 3 – Plant Power

In this activity, you will look at illustrations of several species of plants and rate them according to whether they have characteristics that can help maintain a healthy riparian zone.

Your team will need:

- Plant Characteristics Sheet for the Nebraska Sedge, Broadleaf Cattail, Oxeye Daisy, and Common Dandelion (see next page)
- Plant Power Chart, like the one below

Directions

Look at the illustrations and read the plant characteristics information for each of the plants. Create a Plant Power Chart, like the one below, in your Zone Notes. Use what you know about colonizers and stabilizers to fill out the chart. Use the following scale to rate each of the plants according to the characteristics listed; then add the numbers in each column.





- 1 = undesirable or low value
- 2 = somewhat desirable or medium value
- 3 = very desirable or high value

Plant Power Chart				
Plant characteristics	Nebraska Sedge	Broadleaf Cattail	Oxeye Daisy	Common Dandelion
Root type				
Strength of crown				
Thrives in continually wet soils (water-saturated soils)				
Totals				



Zone Notes - Plant Power

- According to your rating system, which of the plants would be the most effective at holding onto soils in the riparian zone? Why?
- Sometimes scientists will assess a very green riparian zone and find that it's not functioning properly—stream banks have collapsed into the water and water quality is poor. What are some reasons that the plants didn't do the job they were expected to do?

Plant Characteristics	Type and Strength of Crown	Root type	Minimum root depth	Height at maturity	Tolerance of continually wet soils
Nebraska sedge <i>(Carex nebrascensis)</i> 	Rhizomatous—underground stems sprout additional stems above ground and dense underground roots	Fibrous—dense roots branch and spread sideways and down	25 cm	.9 m	High
Broadleaf cattail <i>(Typha latolia)</i> 	Rhizomatous	Fibrous	35 cm	1.5 m	High
Oxeye daisy <i>(Leucanthemum vulgare)</i> 	Bunch—upright growth with spaces between each bunch	Horizontal stems below the surface form roots	20 cm	40 cm	Low
Dandelion <i>(Taraxacum officinale)</i> 	Single crown	Tap—one large thick root like a carrot	15 cm	15 cm	None

Unit 2 - Station 2

WATER QUANTITY AND SOILS IN THE ZONE

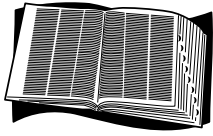

Zone Words

aquifer: an underground layer of sand, gravel, or permeable rock where water collects.

bedrock: solid rock that is underneath soil.

groundwater: water that collects underground in the spaces between particles of sand and gravel or in cracks in bedrock.

permeable: having openings that allow liquids to pass through.

surface water: water found on the surface of the Earth in lakes, streams, and rivers.

Water in the GREEN Zone may be found above ground (**surface water**) and below ground (**groundwater**). We are all familiar with surface water—lakes, streams, and rivers, for example. But groundwater is not so easy to see.

When precipitation falls onto land areas, some of it seeps into the ground. The water moves through spaces between soil particles and into **aquifers**. These underground layers of sand, gravel, or **permeable** rock allow water to move

freely and collect above an **impermeable** layer of rock.

Whether it's on the surface or under ground, water in the GREEN Zone is vitally important to the plants, animals, and people who live nearby. And it's **the soil in the GREEN Zone that serves as a water "bank," saving water that has been "deposited" after rains, snowmelt, and floods.** Just as people can withdraw money from a bank, plants can slowly "withdraw" water from the soil during a dry period.

Water moves underground through spaces between soil particles.

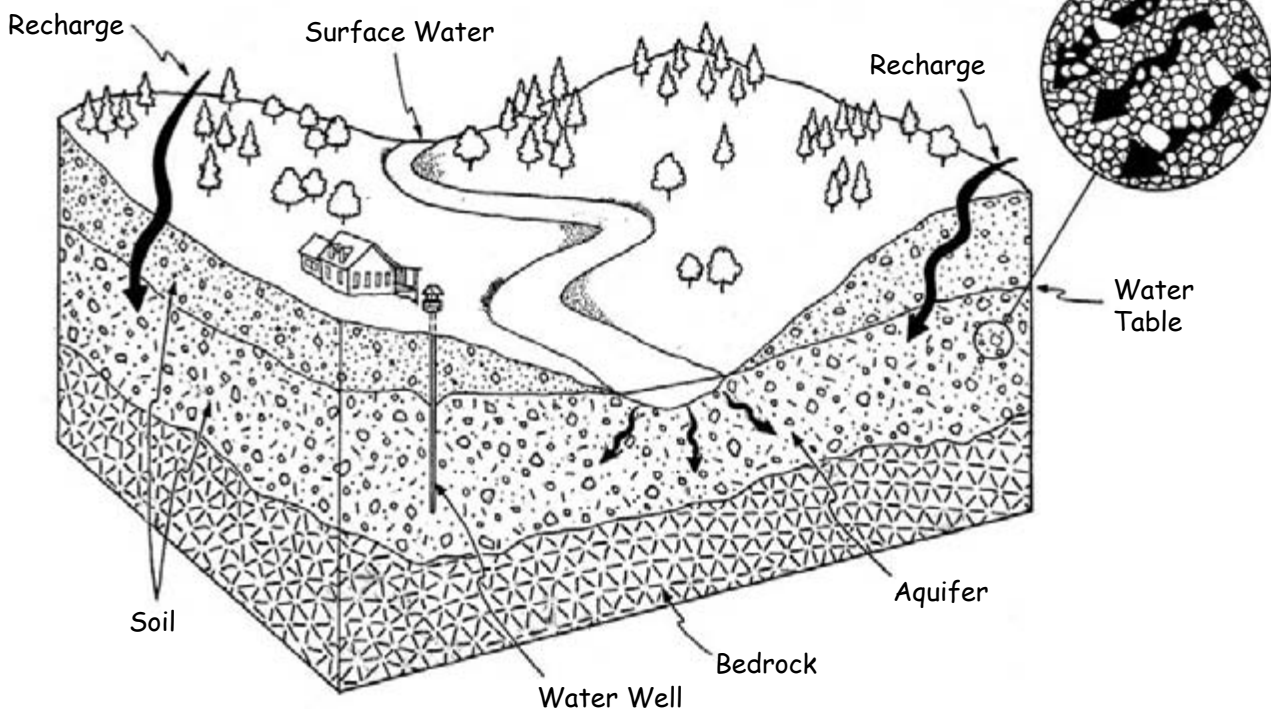



But what is soil...and what affects its ability to store water and to release it? Soils vary considerably from place to place because they are a mix of different things. Sediment, along with decomposed plants and animals, builds soils that have different textures, mineral content, and ways of holding and moving water. **Soils play a key role in riparian zones by determining which plants grow, how much water runs off the land, and how susceptible the land is to erosion.**¹

Soils in a healthy riparian zone are frequently wet or damp. Wet or damp soils have special characteristics. Examining soil characteristics can help scientists determine where upland and aquatic ecosystems blend to form the ecotone we call the GREEN Zone.



At this station, you will:

- demonstrate how water is stored underground;
- explore interactions between surface water and groundwater; and
- determine how different soil characteristics affect the ability of soil to hold and transmit water.

¹ Thomas Murdoch, Martha Cheo, and Kate O’Laughlin, *Streamkeeper’s Field Guide: Watershed Inventory and Stream Monitoring Methods* (Everett, WA: The Adopt-A-Stream Foundation, 2001)

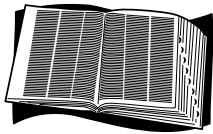

Zone Words

discharge: to flow from or past. Scientists use the term to describe the flow of water from groundwater into streams, and also the volume of water that passes through a channel during a specific time period.

recharge: to refill or replenish. Melting snow in the spring helps recharge groundwater supplies.

water table: the top of the underground area that is filled with groundwater.

Angel Food Aquifer

An aquifer, the underground region where groundwater collects, is like a sponge in the way it can hold water. In this region, water fills in all the spaces among the soil particles. The **water table** is like the top of the sponge. Water table depths can vary because of climate, seasonal change, precipitation or flooding events, and human use. In many areas, people get their water by pumping it from aquifers.

Seasonal dry spells, drought, or land use practices can cause stream levels to fall. In many cases some flow continues because groundwater **discharges**,

or seeps, into the stream (Diagram A). Plants in the riparian zone also benefit from groundwater resources in dry times. They can remain green and healthy by taking up groundwater through their roots. The process works in the other direction, too. When groundwater levels are low, water in an adjacent stream can enter and help replenish, or **recharge**, the aquifer (Diagram B). **Surface water and groundwater in the GREEN Zone are closely linked in a give-and-take relationship.** As the water table rises and falls, so does the stream level.



*Even though the stream has dried up, plants in this Utah riparian zone continue to thrive because of groundwater that remains in the soil.
Photo by Kate Reilly*

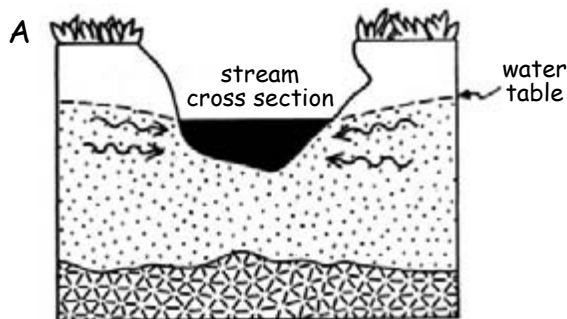

This stream is gaining water from the aquifer.

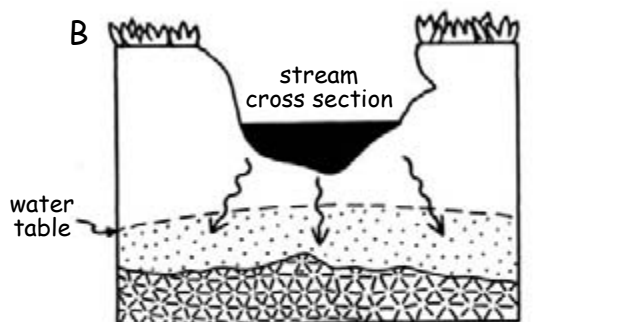

This stream is losing water to the aquifer.





Unit 2, Station 2, Activity 1 – Angel Food Aquifer

In this activity, you have a simple, and tasty, demonstration of how:

- water is stored underground;
- water levels in a stream or lake interact with an adjacent groundwater supply; and
- people access groundwater supplies.

Your team will need:

- A slice of angel food cake, approximately 25 cm in diameter and 5 cm thick
- 2-liter bottle of clear soda
- Crushed ice
- Large, clear mixing bowl, approximately 25 cm in diameter
- Large, clean spray bottle
- Drinking straws
- 2 washable markers, different colors

Directions

1. Fill the mixing bowl $\frac{3}{4}$ full with crushed ice. Carefully place the slice of cake on top of the crushed ice in the bowl. You've just completed your groundwater model.
2. One member of your team will pour soda THROUGH THE HOLE in the center of the angel food cake slice until the soda in the ice is about 1 cm below the cake.
3. Find the "water" table in your groundwater model. Use one of your colored markers to make a small line on the bowl where the top of the water table is in your model.
4. How does water get into an aquifer? Fill the spray bottle with soda. Rain on your model by spraying the ground (cake). Try out different possibilities with your team. Does the water table rise? Continue to rain on the riparian zone until the hole in the cake is half full. Use the other colored

marker to draw a line where the water table is after you're done spraying.

5. "Drill" a well into your aquifer by gently pushing the straw through the cake and into the crushed ice below. Your model represents a lake surrounded by a riparian zone. The lake is in the hole in the angel food cake. The riparian zone is the cake itself. What are the different components of the aquifer shown in the diagram on page 26? Make a chart in your Zone Notes like the one below. Match each part in the diagram with the corresponding part in the aquifer model you made.

Unit 2, Station 2, Activity 1 – Angel Food Aquifer

My Aquifer Model	Real Aquifer
	Soil below the water table
Soda	
	Soil above the water table
Straw	

6. Pretend that your team members all live in the city of Crawdaddy Creek. The city is planning to use your aquifer for drinking water. The Municipal Water Department of your city has drilled a well into the aquifer. How will the city get the water out of the aquifer? Have one person use the well to try to pump water from the aquifer model. What is the best way to do it? Watch what happens to the water level of the lake as you "pump" your well. What happens to the water table?



Zone Notes – Angel Food Aquifer

- How are the levels of the aquifer and the lake related in your model?
- If an aquifer is drained, can it be refilled (recharged)? How?
- List two ways that a healthy riparian zone can help to conserve groundwater.

The Scoop on Soil - Texture and Percolation

The characteristics of soil in a riparian zone affect how the zone functions because they determine how much water can be stored in a particular area and how fast the groundwater can be recharged or discharged.

What happens to water when it passes through soil depends on many things: the composition of the soil, the size of the soil particles, how the particles are arranged, how tightly they're packed, and the attraction between the soil particles and the water.

Decaying riparian plants play an important role in creating organic matter, which helps water to sink quickly into the soil and helps hold it too. This explains why riparian soils

can reduce the impact of flooding during a storm event. The presence of organic matter also gives plants a better chance of using water in the soil. Other types of soil may let the water run through so quickly that riparian plants are not able to thrive. Still other soils may keep the water out, causing it to run off the surface. None of these soil types is better than the other; they are simply different.²

In the following two activities, you will experiment with different soil characteristics and then try to determine which types would help the GREEN Zone to capture, store, and release water.

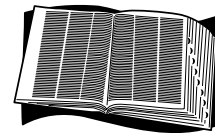

Zone
Word

percolate: to pass through or drain through a substance, as water percolates through sandy soils.

² Adapted from "Just Passing Through (Beginner Version)," a GLOBE Learning Activity.



Unit 2, Station 2, Activity 2– Texture Test³

Soil plays an important role as a “water bank” in the riparian zone. Explore the characteristics of different soil types in the texture test below.

Your team will need:

- 3 containers – one containing a sample of sand, one containing a sample of clay, and one containing a sample of local soil
- Squeeze bottle full of water
- 3 spoons
- Texture Test chart like the one below (one for each team member—your leader will provide)

Directions

Watch carefully as your leader demonstrates the method you’ll use to determine different soil textures; then proceed with your own texture test. Follow steps 1 - 4 with each of the three soil samples.

Unit 2, Station 2, Activity 2

The Scoop on Soil –Texture Test	Sand	Clay	Local Soil
Can you form a ball?			
Can you form a ball and then roll the ball into a snake?			
Can you form a ring with the snake shape you made?			
Does your sample feel gritty or sandy?			
Does your sample feel smooth, like flour?			
Does the sample feel neither gritty nor smooth?			
What color is the soil?			

1. Each team member should take a sample of soil about the size of a large marble. Put the sample on your palm and add a few drops of water.

2. Try to form a ball.

3. Try to make the other shapes listed in the Texture Test chart to determine some of the characteristics of each soil type.

4. Enter your discoveries on the chart and add the chart to your Zone Notebook; then answer the Zone Notes questions.



Zone Notes - Texture Test

- Describe each soil’s characteristics. Write and finish each sentence below:
 - I would know I had a SANDY soil if it _____.
 - I would know I had a CLAY soil if it _____.
 - I think our local soil is most like (sand or clay) _____.
- Soil stores water in the spaces between the soil particles. Which soil type do you think could store more water? How did you decide?
- Do we want riparian zones to be able to store water? Why? How did you decide?

³ Adapted from “What’s Soil Got To Do With It?” *4-H Wetland Wonders* (Oregon State University Extension Service)



Unit 2, Station 2, Activity 3 – Percolation Test⁴

A healthy riparian zone stores water above and below

the ground. You've just observed differences among some soil types. In this activity, you'll see how **soil characteristics in the GREEN Zone can also determine how water moves through it.**

Percolation is a word that describes the movement of a liquid through a substance. If you have ever watched coffee being made, you probably have seen percolation. Water is poured through the coffee grounds and is collected in the pot.

Soil scientists perform percolation tests to determine how water moves through soil in a particular area. Why would scientists be interested in percolation test results in a riparian zone? Before you get started, discuss this question with your team.

In this activity your team will:

- time the flow of water through different soils;
- measure the amount of water held in these soils; and
- discover the ability of soils to filter water.

Your team will need:

- 3 clear 2-liter bottles with the bottoms cut off
- 3 clear 500-ml wide-mouth beakers or similar containers (See diagram)
- 1 clear 500-ml measuring container marked in milliliters to pour and catch water
- Soil samples (sand, clay, and a local soil)
- Extra container of sand
- 3 pieces of window screen or other fine mesh cut into circles, each approx. 10 cm in diameter

- Water
- Timer or clock with a second hand
- Black and red washable markers
- One color of food dye
- Percolation Test chart (one for each member — your leader will provide)

Directions

Your leader will provide three containers of different types of soil including sand, clay, and a local soil. Since you've already completed the Texture Tests, you are familiar with some of each soil's characteristics. Now you'll perform a percolation test on each one.

1. Hold each of the soda bottles upside down and put a circle of screen inside each

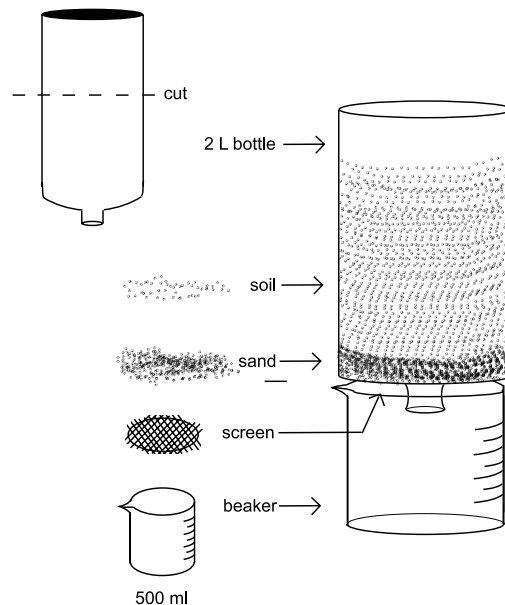

bottle neck so the screen sits on the bottom and completely covers the opening.

2. Pour 3-4 cm of sand onto the screen for each bottle. The sand will keep the screen from becoming clogged.

⁴ Adapted from "Just Passing Through (Beginner Version)," a GLOBE Learning Activity.

3. Balance each bottle, mesh side down, in a beaker or clear container.

4. Pour 1.2 liters of soil into the bottle over the sand, using a different type of soil in each bottle.

5. Fill a 500-ml beaker or other clear container with 300 ml of water. Add 2 drops of food dye. Notice what the water looks like at this time.

6. Predict what will happen when you pour the water onto each type of soil. Using the Percolation Test chart, write down your predictions and explain them (shaded areas of chart).

7. Now get ready to take notes about what happens when water percolates through the soil. Pour the water onto the soil and begin timing. As you pour the water, use the questions in the unshaded areas of the chart to help you record your observations.

Unit 2, Station 2, Activity 3 – Percolation Test

(Note: Your prediction should go in shaded areas; your observation hand column to explain your predictions and observations.)

Prediction/Observation	Sand	
Will the water run out through the bottom of the bottle? Yes/No		
The water ran out of the bottom of the bottle. Yes/No		
How much water will run out?		
How many mL of water percolated through?		
How many seconds will it take for the water to pass through the soil?		
The time it took for the water to pass through the soil was...		
What will the water look like when it comes through? Clear, murky, very dirty, etc.		
The water was...(Describe its appearance.)		

8. Once the water has stopped dripping from the bottom of the bottle, remove the soil bottle and hold up the beaker

of water that has passed through the soil. How does the water look?

9. Pour the water back into the original container. How much water did you start with? How much water is missing? Enter your data in the chart.

10. REPEAT STEPS 5 THROUGH 9 FOR EACH SOIL BOTTLE.

11. Add the Percolation Test chart to your Zone Notebook and answer the other Zone Notes questions.



Zone Notes - Percolation Test

- Which of the soil types allowed water to move through most quickly—sand, clay, or local soil? How did you decide?
- Which of the soil types absorbed the most water—sand, clay, or local soil? How could you tell?
- Which soil type absorbed the most food dye? Which soil type might filter more pollutants in the GREEN Zone? Explain your answer.
- Predict what would happen to an aquifer after a flood in the GREEN Zone if the soil is: a) sand; or b) clay. What would happen if the soil included a mixture of sand, clay, and decayed plant material, which is good at absorbing water?
- Animals and people can compact (squeeze or press down) the soil in a riparian zone. If you compacted the soils before performing the percolation tests, do you think your actions would change the results? Why or why not? How might compacted soils affect water movement and plants in the GREEN Zone?

Unit 2 - Station 3

WATER QUALITY AND PLANTS IN THE ZONE

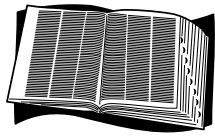

Zone Words

nonpoint source pollution: contamination that cannot be traced to a single source. Oil, gasoline, brake fluid, trash, fertilizers, pesticides, and animal waste that wash into waterways and degrade water quality are considered nonpoint source pollution.

pollutant: any substance that degrades the quality of soil, water, or air.

runoff: water from precipitation that flows over the land surface into rivers, streams, marshes, and other water bodies.

sediment: soil, rock fragments, and other material transported and deposited by water, wind, or other forces.

turbid: muddy or cloudy because of sediment, algae, or other small particles floating in the water.

You've already seen how plants in the GREEN Zone can help slow water down in a stream. In this station, you'll explore how the plants in the zone can help improve water quality in the stream. In addition to pollutants that can enter water from a variety of sources, floating sediment can lead to muddy (**turbid**) water, which can cause serious problems for aquatic life. **Riparian plants are important for healthy riparian zones because they're good traps. Plants slow down runoff, keeping soil and other pollutants out of the water.** And when trunks or branches of dead trees fall into stream channels, they can reduce the speed of rushing water and trap sediment as well.

When precipitation falls on land, it can evaporate, it can soak into the ground,

or it can run off the land and into bodies of water. As this "**runoff**" travels across parking lots and down streets, across farm fields and feedlots, and over ranchlands, it collects a variety of **pollutants**. A pollutant can be any biological, chemical, or physical substance that lowers the quality of the water. When runoff enters a body of water, it carries pollutants with it. This type of pollution, called **nonpoint source pollution**, is the main cause of water quality problems in the United States.

To find out if a riparian zone is suffering from nonpoint source pollution, natural resource specialists look at the kinds of plants that grow there and perform a variety of tests to measure the quality of the water.



At this station, you will:

- demonstrate how plants can filter pollutants from water;
- examine how plants can help keep sediment out of the water; and
- explore how macroinvertebrates can be studied to evaluate water quality.



Filter Plants

By slowing down runoff, plants in the riparian zone help water stay around longer, allowing it to soak into the ground. Once in the ground, some pollutants in the water attach to soil particles or are broken down into less harmful substances. And the plants themselves act as a water filter by taking some of the pollutants in through their root systems.

As you saw in Station 2, water can travel back and forth between groundwater and surface waters. This helps to explain why, with the help of “filter plants,” riparian zones play such an important role in protecting not only the quantity, but also the quality, of both surface water and groundwater.



Holding onto the GREEN Zone - Unit 2, Station 3



Unit 2, Station 3, Activity 1 – Filter Plants¹

In this activity, you will conduct a demonstration to observe how plants can help remove pollutants from water. You will also be able to determine whether the following statement is true or false: Clear water is always clean, unpolluted water.

Your team will need:

- 2 stalks of fresh celery with leaves
- 2 plastic water cups
- Masking tape
- Red food coloring
- White vinegar
- 2 measuring cups
- Paring knife or plastic knife
- Ruler (cm) or meter stick
- Paper towel
- Piece of notebook paper

Directions

1. Rinse off the celery and trim the bottom end off each stalk. No stalk should be longer than 25 cm.
2. Use masking tape to label the cups “A” and “B.”
3. In cup A put: $\frac{3}{4}$ cup water, 3-4 drops red food coloring, and $\frac{1}{4}$ cup vinegar. Add a trimmed celery stalk.
4. In cup B put: 1 cup water, 3-4 drops red food coloring, and a trimmed celery stalk.

5. Let the cups sit for at least 4 hours—overnight, if possible.

6. What do you think will happen to the celery’s color, taste, smell, and texture? Will results in the two cups differ? Write your predictions in your Zone Notes.

7. Once the celery has soaked for at least 4 hours, begin your observations, starting with cup B. First, make a chart like the one below in your Zone Notes.

- a. Remove the celery from cup B and dry it with a paper towel. This will be celery B.
- b. Place the stalk lengthwise on a piece of notebook paper, lining up the bottom end of the stalk with the bottom of the paper. Use the ruler to measure along the celery stalk, making a mark on the paper next to the stalk at every 1 cm.
- c. Beginning at the bottom end, slice the celery stalk at every 1 cm mark until the red color is no longer visible in the stalk. Mark this spot on the paper. Measure the distance from the bottom of the paper to the spot. This is how far the color traveled. Record the distance in your chart.
- d. Have one volunteer from your team smell the celery and then take a taste of it where there is no red color in the stalk. Take note of the celery stalk’s texture. Record these observations in your chart.

Unit 2, Station 3, Activity 1 – Filter Plants

Filter Plants—Observations	Celery A	Celery B
How far up the stalk did the color travel?		
How does the celery smell?		
How does the celery taste?		
What is the celery stalk’s texture? Firm and crisp? Limp?		

¹ Adapted from “In the Water: In the Plants,” *4-H Wetland Wonders* (Oregon State University Extension Service)

8. Repeat steps a-d for the celery in cup A, which will be known as Celery A.

9. Discuss the following questions with your group: In the activity, what does the red food coloring represent? What does the vinegar represent? What happened to the food coloring in each stalk? What happened to the vinegar in Celery A? How can you tell? Compare Celery A and Celery B. How are they alike and how are they different?

10. Use the Zone Notes questions to help you summarize what you've observed.



Zone Notes - Filter Plants

- Is clear water always clean or unpolluted? Explain your answer.
- How can the presence of vegetation in a riparian zone affect the quality of drinking water in a community?
- Riparian vegetation can remove some, but not all, pollutants. List ways your community might prevent pollution in riparian zones before they become contaminated. Share your list with your group.



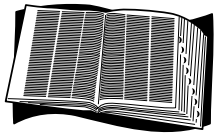

Zone Words

deposition: the process that occurs when sediment (sand, clay, gravel, cobble) falls out of the water, wind, or ice that carries it. A process that builds (or deposits) soil, deposition is the opposite of erosion, a process that carries soils away.

erosion: the wearing away or separation of soil and rock from the land by water, wind, ice, or gravity.

Erosion in the Zone

All types of soils in the GREEN Zone are subject to **erosion** – the movement of soil by wind or water.

Erosion is a natural process that is constantly changing the GREEN Zone. It can be a benefit or a problem depending on the amount of soil being moved. Erosion is a benefit if sediment is deposited, building soil for

greater water storage and more plant life. Plants can help this process, called **deposition**, by trapping sediment that is in the water. Erosion can be a problem if large quantities of sediment muddy the streambed. In those cases, water quality and aquatic habitat can be harmed.



Erosion



Deposition





Unit 2, Station 3, Activity 2 – Erosion in the Zone

In this activity, you will explore ways in which plants play important roles in trapping sediment in the GREEN Zone. By keeping soil out of the water, a healthy riparian zone can help make rivers and streams better places for fish and other aquatic life. (**Note:** You will need to conduct Steps 1-4 in the activity at least a couple of weeks before you can complete the other steps. An alternative would be to use a piece of sod from a garden shop.)

Your team will need:

- Two large plastic trays (such as kitty litter boxes)
- A portable hand drill with 3/8" drill bit
- Measuring cup
- A watering can with a sieve-style head
- Soil mix (soil, sand, and gravel)
- Grass seed (rapid growth) - or see "Note" above
- Two coffee filters and coffee filter holders or fine strainers
- Two large empty coffee cans
- Duct tape
- Two empty juice cans or cartons of about 240 ml capacity
- Wooden blocks to support the trays
- Water

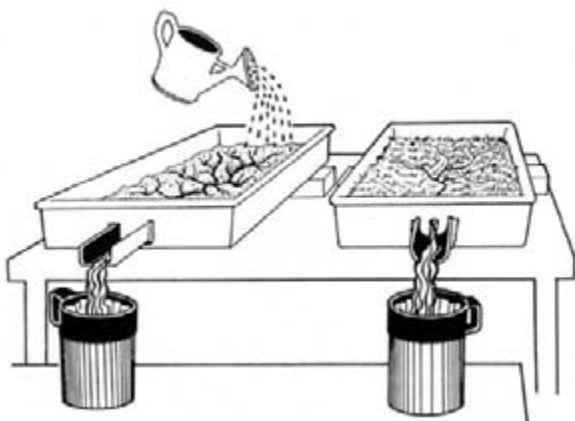

Directions

1. Drill a small hole at the end of each tray at the center just above a line 2.5 cm from the top.
2. Measure equal amounts of soil mix and add the mix to the two trays, filling them to just below the drilled holes. Pack the soil mix slightly, but don't overdo it.
3. Leave one tray as it is, containing just the soil. For the second tray, spread evenly a thin layer of rapid-growth grass seed over the entire area. Gently press the seed into the soil; then place the seeded tray on a sunny windowsill.
4. Using the watering can, gently water the grass seed daily. When the grass is firmly rooted, you are ready to conduct the experiment.
5. Place both trays side-by-side on a table with the ends with the holes lined up near the table edge. Place a wooden block under each tray at the end opposite the one with the hole. Place a bench at the end of the table to serve as a platform for two coffee cans, which will serve as water catchments for water draining from the two trays.
6. Rest a coffee filter holder or strainer inside each coffee can. Place a coffee filter in each filter holder. Using waterproof tape, attach small "troughs" made from empty juice cartons or cans to the ends of the trays to guide the runoff from the trays to the filters.
7. Using the watering can, gently pour about 500 ml of water over the tray containing just the soil. When the water stops draining through the coffee filter, scrape the soil from the filter into the measuring cup. Measure the amount of soil that was lost due to runoff. Note the results in your Zone Notebook.

8. Next, pour the same quantity of water over the tray planted with grass seed. Measure the amount of soil runoff from this tray and record these results in your Zone Notebook. Compare results from the two trays. Which one lost more soil?

9. As a group, discuss how rivers and other bodies of water can be affected by surrounding areas with and without plant cover.



Zone Notes - Erosion in the Zone

- What do you think would happen to soil along a stream that had no plants growing along the banks?
- Deposition of sediment or soil in a riparian zone can be beneficial or harmful. List at least one example of each. Describe how riparian vegetation can promote deposition that helps the zone.
- What are some advantages of keeping soil in or adding soil to the riparian zone — for living things in the zone? for water quality in the zone?



This creek in south-central Wyoming had serious erosion along its banks (above) until land managers and community members worked together to solve the problem. Less than 10 years later, a much healthier riparian zone was the result (right).



Testing Water Quality

As you saw in the “Filter Plants” activity, it’s not always easy to tell whether water in a stream is clean or polluted. Scientists rely on several methods for testing water quality:

- **Water clarity testing**
– involves checking how easily light passes through the water. Clear water has little sediment or suspended soil. Murky or cloudy water has a lot of sediment.
- **Chemical testing**
– involves measuring such things as water temperature, the amount of oxygen in the water (dissolved oxygen), the amount of nutrients in the water, and pH (how acidic or basic the water is).

- **Biological testing**
– involves surveying **macroinvertebrates** in the water. These small animals without backbones are visible to the naked eye and include such creatures as water insects, worms, clams, crayfish, and snails. Some of these organisms are more sensitive to pollutants than others. That means if too much pollution is present, the organisms either move, fail to reproduce, or die. If scientists find a number of the sensitive organisms in their field-testing, it would be an indication that a particular body of water is healthy.

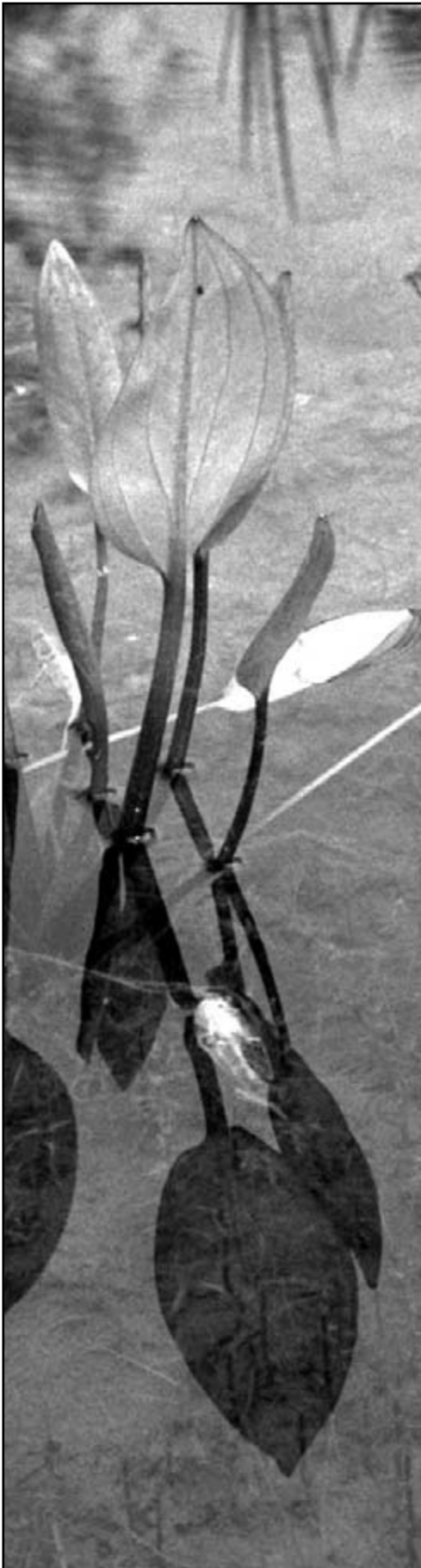

Holding onto the GREEN Zone - Unit 2, Station 3



Unit 2, Station 3, Activity 3 - Critter Cube Count²

In this activity, you will learn about macroinvertebrates so you will be able to do your own biological testing when you take a trip to the GREEN Zone in Unit 3.

The object of the Critter Cube Count is to determine a water quality score for an imaginary stream. The game simulates the steps followed to check the water quality of a local stream using macroinvertebrates. To actually use this method, you would go to a stream, collect macroinvertebrates (or “water critters”) in a net, and then identify them. You would record the types and numbers of critters in a formula on the Macroinvertebrate Tally Sheet. The results can help you predict if your stream is healthy or polluted.

Your team will need:

- “Macroinvertebrate Tally Sheet” and “Key to Macroinvertebrate Life in the River”—your leader will provide both
- Four “Critter Cubes”
- An ice cream bucket or similar container
- A clear, flat surface like a card table or a clear area on the floor

Directions

1. The “Macroinvertebrate Tally Sheet” shows pictures of macroinvertebrates grouped according to their sensitivity to pollutants. Group 1 is the most sensitive; group 4 is the least sensitive. On the back of the tally sheet, see how to calculate the

health of the stream by sampling the critters found there.

2. Now play the game:
 - a. Place four Critter Cubes into the container provided by your leader.
 - b. Shake the bucket so the cubes are mixed.
 - c. Dump them onto a flat surface.
 - d. Use the “Key to Macroinvertebrate Life in the River” and tally sheet to identify the macroinvertebrate pictures that are face up on each of the dice.
3. Circle the corresponding pictures on the tally sheet and enter the total number of animals you circled for each group in the boxes. Follow the directions on the form to determine the score for the imaginary stream you just “sampled.”
4. How healthy was your stream? Answer this and other questions in your Zone Notes. Don’t forget to put your notes and your tally sheet in your Zone Notebook when you’ve finished.



Zone Notes - Critter Cube Count

- How healthy was the “stream” in your game?
- Where would you be more likely to find critters sensitive to pollution: in a stream that is surrounded by riparian vegetation or in a stream with little or no vegetation along its banks? Why?

² Adapted in part from *Water Action Volunteers—Volunteer Monitoring Factsheet Series*. (Univ. of Wisconsin—Extension and Wisconsin Dept. of Natural Resources, 2001)

Unit 2 - Station 4

LAND USES IN THE ZONE: WORKING TOWARD A HEALTHY BALANCE



Stations 1, 2, and 3 highlight the functions and characteristics that make riparian zones special places. At this station you will explore the ways in which the GREEN Zone is related to the natural and human-made communities that surround it. Natural resource specialists define the location of the riparian zone from the stream bank to its edge in the uplands; then they look beyond the zone to its function in the **watershed**.

What is a watershed? A watershed is all the land that water flows across or through to get to a lake, stream, or river. Watersheds come in many shapes and sizes, and a large watershed is likely to contain many smaller ones. A watershed includes all the living and

non-living things within its area.

Why do we care what happens on the land in a watershed? Everything we do in a watershed affects water resources – groundwater, marshes, ponds, streams, rivers, and lakes. Anything dumped on the ground in a watershed can end up in its water bodies. If we aren't careful, soil, debris, and chemicals on the land may be carried by runoff, polluting our waters and those of communities downstream. Land uses can have profound effects on the health of people, plants, and animals that live in our watershed. Land uses can also affect the health of the riparian zones that are found there.

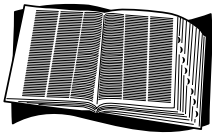

Zone Words

community: a group of people or other living things that live in a common location. You may be a part of many communities: school, neighborhood, church.

runoff: water from precipitation that flows over the land surface into rivers, streams, marshes, and other water bodies.

watershed: the land area that drains into a stream, river, or other body of water.



At this station, you will:

- examine how your community watershed and riparian zone are related;
- demonstrate how one species of animal can affect the health of the GREEN Zone; and
- explore how land use activities can affect water quality in the zone.



The land area that drains into a stream, river, or other body of water is called a watershed. The area outlined here is one watershed, but it contains many other smaller watersheds. Land uses in a watershed affect the quantity and quality of its water resources.



Unit 2, Station 4, Activity 1 - Where is my Watershed?

Your challenge is to outline the boundaries of your community watershed and to locate the riparian zones in the watershed. The next step will be to identify all the human-made features of your watershed. With your leader's help, your group will select one of the community riparian zones to study on your GREEN Zone field trip.

Your team will need:

- A copy of a street map and/or topographic map that includes your watershed and your community (one map for each team member)
- Colored pencils
- Pencil with eraser for each person
- Information about the location of your watershed and, if possible, the location of the major aquifers in your community that will be provided by your leader

Directions

1. On your map trace all the streams, rivers, and lakes with a blue colored pencil.
2. Using a green pencil, outline each body of water by drawing green lines along its edges. What are these green areas called?
3. Outline the borders of your watershed in pencil. Look at the example provided by your leader for guidance.
4. With the help of your teacher or leader, outline the locations of the major aquifers in your watershed with a colored pencil. Locations of municipal pumping stations for drinking water will be provided, if available. Mark these on your map, too.

5. Find and mark the local human-made features of your watershed: schools, churches, malls, factories, etc. If these landmarks are not already found on your map, draw them in the appropriate places. Don't forget to label your drawings.

6. Draw your house or neighborhood location on your map.

7. Name the largest body of water in your watershed.

8. Where does your family get its drinking water? (Your leader or parents can help you with this question. Choose a or b.):

- a. A municipal water system
- b. A private well

Try to locate the municipal water reservoir or well on your map.

Now you have an idea of what the landscape in your watershed looks like and how the riparian zones fit into that view.



Zone Notes - Where is my Watershed?

- What is the major source of drinking water in your community?
- List three major human activities that you think might affect the riparian zones in your watershed.
- Which stream or river in your watershed would you like to choose as a field trip destination for a riparian zone study? Explain why.

A Diversity of Life

The GREEN Zone's wealth of water and water-loving plants attracts many wildlife species because food and habitat choices are abundant. People also like to use these areas for recreation and many other purposes.

A healthy GREEN Zone is a productive place that supports a diverse population of plants and animals. It may have a dense growth of deep-rooted grasses and sedges, layers of shrubs, and trees of all

ages. Stream channels that are narrow and deep provide homes for trout, salmon, and a variety of other aquatic animals. Wildlife is attracted by vegetation that offers abundant food and a diversity of habitats for raising young. Cattle and other livestock also find food, water, and shelter in a healthy riparian zone. In arid regions and during dry seasons or periods of drought, riparian zones become even more attractive to wildlife and livestock.





Unit 2, Station 4, Activity 2 - Wildlife in the Zone

Land managers may find that animals affect the health of a riparian zone in both positive and negative ways. In this activity, you will study how one type of animal, the beaver, affects the GREEN Zone.

Beavers, like many other types of wildlife, are attracted to riparian zones for the food, water, and shelter found there. Beavers cut down trees in riparian zones to build dams, which slow the flow of water. Water spreads out behind the dams creating wetlands and ponds where the beavers can store food, build lodges, and move safely. The dams capture sediment, which helps to improve water quality downstream. Dams also reduce erosion by slowing the flow of streams. Over long periods of time, beaver activities can create wider, more productive riparian zones. In the short term, these changes sometimes conflict with human uses of the GREEN Zone.

Your team will need:

- Poster board
- Poster paint
- Plastic container (at least 10 cm deep)
- Modeling clay
- Glue
- Markers, crayons, pencils
- A grab bag of materials collected by your leader
- Small pitcher of water
- Print material on beavers, with pictures or diagrams of beaver dams and lodges
- Jar of water/sand mix (500 ml of water and $\frac{1}{4}$ cup of sand)

Directions

Your teacher will provide resources for you to read about beaver dams and how they are built. Then, try it yourself. Build a beaver dam model in a plastic container.

1. You will be supplied with a variety of materials for constructing your beaver dam. Choose the materials you think will work best to build the dam. Try to make it watertight.
2. Test your model by pouring water on one side of the dam while tilting the container. See if the dam stops the flow of water.
3. Shake the jar of water and sand. Then add the water/sand mixture to the pond side of your dam. Wait 10 minutes then tip the container to allow a slow stream of water to pour over the top of your dam. Does the water going over the dam appear cleaner than the water from your jar? Why?



Zone Notes - Wildlife in the Zone

- Why do beavers build dams in the riparian zone?
- Make a list of positive and negative impacts you think beavers might have in the riparian zone.
- What other large animals, wild or domestic, use the GREEN Zone? Make a list with your group. Describe changes in the zone that are caused by these animals.

Unit 2 - Conclusion

SOLVE THE PUZZLE – PUTTING THE PIECES TOGETHER



Now that you have completed the four study stations, do you understand how the GREEN Zone works? Test yourself. Can you describe a riparian zone to someone who hasn't heard the term before? Put yourself in the shoes of a natural resource specialist

who wants to determine the boundaries of a riparian zone. How would you do this? The questions below will help you review what you've learned. Answer them in your Zone Notes, and then discuss your answers with other members of your group.



Zone Notes - Putting the Pieces Together

1. Write a one-sentence description of a riparian zone.
2. When we want to know if a riparian zone is healthy, we usually investigate at least six major areas or characteristics of the zone. What are they?
3. Name at least four functions that a healthy riparian zone performs.
4. Cite at least three examples of how a change in one zone characteristic could affect a function of the zone.
5. Natural resource specialists describe the health of the riparian zone by making observations and measurements. Now that you have studied the parts of the GREEN Zone, what information can be used to indicate whether the riparian zone is healthy or not? What features would you observe or measure? How would you do it? (Hint: Look back at the water, plants, and soils information in Unit 2.) Organize your thoughts by creating a chart like the one below in your Zone Notes; then record your answers.

What to Measure	How to Measure



Next Time

For the next unit, you will take a trip to a riparian zone to put your ideas and new skills to work. Your group will take on the role of a team of natural resource specialists that is going to explore a local riparian zone. You will join a team of water ecologists, soil scientists,

physical geographers, or biologists. The group leader will help you decide which specialty to choose. Your team's job will be to complete a checklist. The combined checklists of all the teams will describe your riparian zone and the area surrounding it.



Holding onto the GREEN Zone - Unit 2, Conclusion

Unit 3 - Get into the Zone



Introduction

A riparian land management team is a group of natural resource specialists who combine their expertise and efforts to find ways to hold onto the GREEN Zone. Natural resource specialists are scientists who have training in such fields as water ecology, soil science, biology, and physical geography.

The team collects information about a particular site to determine if the riparian zone is healthy and functioning properly. Many of the specialists collect their information along a transect line, a line across the zone that marks where to take samples for recording, mapping, or studying. This allows scientists to observe changes as they move away from the stream bank. Observing changes over time is also important. That's why information is collected at different times of the year, and often over a period

of several years. Then, the specialists combine their information to recommend ways to maintain a healthy riparian zone or restore an unhealthy one.

In this unit you will be a member of a team of natural resource specialists that is going to explore a local riparian zone. You choose which specialist you'd like to be: water ecologist, soil scientist, biologist, or physical geographer. While in the field, your team will collect information and perform some of the many tests that riparian land management teams perform. You will record information on team data sheets and answer questions in your Zone Notebook.

The GREEN Zone Field Guide packet will be your map to an outdoor adventure. Your day will involve observing, mapping, measuring, digging, collecting, recording, and having fun.



Choose a “Career”

Read the following descriptions of the four “careers” for your field trip day. Work with your leader so that everyone in your class or group is assigned to a specialist team, making sure that each team has enough members to get the job done. Pick up a Field Guide for your specialist team.

Water Ecologist

The water ecologist team will:

- measure, test, record, and describe different characteristics of the water in your riparian zone;
- conduct several water quality tests; and
- make observations about the quantity and speed of water in your stream.

Soil Scientist

The soil scientist team will:

- observe, record, and describe the soils that are found in your riparian zone;
- describe the condition of the stream bank and look for evidence of erosion; and
- observe streambed deposits and the shape of the stream channel.

Biologist

The biologist team will:

- observe, record, and describe the plant and animal life of your riparian zone, including changes in vegetation;
- describe ways in which the plants in your zone provide habitat for birds, fish, and other wildlife; and
- look for ways in which plants and animals have an impact on your zone—either positive or negative.

Physical Geographer

The physical geographer team will:

- measure, test, record, and describe different characteristics of the land and water in your riparian zone;
- observe the impacts of animal and human activities on your zone; and
- make a base map for use by the other specialist teams.



Stay Safe!

Please follow the safety precautions your leader talks about before the trip. You should also pay attention to the safety checklist in your Field Guide. Be safe and be prepared to have fun as you GET INTO THE ZONE!

Keys to Success in the Zone

Field Guides: Each specialist team will receive a step-by-step guide for collecting and recording data. Some teams will use a transect line, which your leader will set up perpendicular to the stream bank.

Work Assignments: Depending on how much time and how many team members you have, you might want to divide up responsibilities to collect all the data you need. Different sub-teams could be responsible for one or more of the activities or different team members could divide up tasks within each of the activities. One person should also be designated

as the team equipment manager.

Step by Step: Before you begin each activity, make sure your team understands the instructions. Your leader, guest natural resource professional, or parent volunteers can help you. It's a good idea to fill in the data sheets as completely as you can, because it will be hard to remember what you've observed once you've left the site. Each Field Guide has questions to answer in your Zone Notes. Your teacher/leader will let you know if this is to be done while on the field trip or later at your home base.





Things to Bring on Your Outdoor Adventure

In addition to the specific items listed in the Field Guide for your specialist team, here are some things that everyone should bring on the field trip:

- Old clothes that are appropriate for the weather
- Shoes and socks you can get muddy and wet
- A dry pair of shoes and socks in a plastic bag. Use the bag for wet stuff after you change.
- Old towel for drying off and cleaning up
- Lunch, drink, and a snack
- Extra drinking water
- Clean-up supplies—water, soap, towels, or wipes
- Insect repellent
- Sunscreen
- Backpack to carry everything

UNIT 3 - Water Ecologist

FIELD GUIDE FOR THE GREEN ZONE



Preparing for Field Work

What you will do:

- **measure, test, record, and describe different characteristics of the water in your riparian zone**
- **conduct several water quality tests**
- **make observations about the quantity and speed of water in your stream**

water in the GREEN Zone helps scientists to determine whether the zone can do its job. Water helps shape the zone through the processes of erosion and deposition. Erosion can also affect the quality of water in your stream, which in turn affects whether your zone can provide habitat for fish, waterfowl, and other aquatic life. Your team's investigations will help you assess the quantity and quality of the water in your zone.

Unlike some of the other teams, you will do most of your work in or by the water. You won't be using the transect line. All the information you need to do your job is in this packet.

As you learned in Unit 2, information about the quality and quantity of

Once you've completed your field observations and data collection, you will answer some questions in your Zone Notebook. And after all four specialist teams finish collecting their data—the key pieces of the GREEN Zone puzzle—all the teams will combine their information to create a detailed picture of the area.

Things to Know Before You Go!

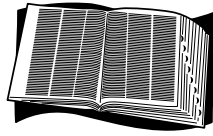

Zone Words

nutrients: substances that promote growth. In a stream or other body of water, fertilizers, animal waste, or decaying leaves and grasses can be considered nutrients.

pH: the measure of the acidity and alkalinity of a solution based on a scale from 1 (most acidic) to 14 (most alkaline).

riffle: shallow, fast-moving water where the flow is broken by a bed of gravel, cobbles, or boulders.

turbid: muddy or cloudy because of sediment, algae, or other small particles floating in the water.

Measurement Conversions

30.5 centimeters (cm) = 1 foot

$^{\circ}\text{C} \times 9/5 + 32 = ^{\circ}\text{F}$

$^{\circ}\text{F} - 32 \times 5/9 = ^{\circ}\text{C}$



What you will learn:

- whether the quality and quantity of the water support plant and animal life in the zone
- ways in which water helps to shape the GREEN Zone

Water Ecologist Checklists

1. Materials

Your team will use these items in the field. Your leader has collected all the materials and will give you a large plastic container. Check off each item as you put it into the container. Go through this checklist again before you leave the riparian site so you don't leave anything behind.

- | | |
|--|--|
| <input type="checkbox"/> Key to Macroinvertebrate Life in the River | <input type="checkbox"/> Thermometer |
| <input type="checkbox"/> Macroinvertebrate Tally Sheet | <input type="checkbox"/> pH test kit |
| <input type="checkbox"/> White bucket or tray | <input type="checkbox"/> 3 apples or 3 oranges |
| <input type="checkbox"/> White ice cube trays | <input type="checkbox"/> Other |
| <input type="checkbox"/> Magnifying glass | _____ |
| <input type="checkbox"/> Plastic cups | _____ |
| <input type="checkbox"/> Tweezers | _____ |
| <input type="checkbox"/> Spoons | _____ |
| <input type="checkbox"/> A fine-meshed net with a long handle | _____ |
| <input type="checkbox"/> Clipboard | _____ |
| <input type="checkbox"/> 2 pencils with erasers | _____ |
| <input type="checkbox"/> Tape measure (meters) | _____ |
| <input type="checkbox"/> 4 marker flags | _____ |
| <input type="checkbox"/> Timer (stopwatch or watch with a second hand) | _____ |
| <input type="checkbox"/> Meter stick | |

2. Safety

A safe trip will be a fun trip for everyone. Read the safety tips below and put a check next to each one so your teacher/leader knows you've read it.

- If you plan to work in the water, make sure you have a buddy and an adult supervisor present.
- Check with an adult before entering the water, and stay out of streams with fast-moving water.
- When you wade into water, stop when it reaches your knees.
- Work carefully on stream banks. They may crumble or be slippery.
- Know the poisonous plants in the area. (Ask your leader.)
- Watch out for broken glass, rusty cans, barbed wire, and other hazards that you may find at your test site.
- Wear goggles and gloves when you work with chemicals or with water you think might be polluted.
- Wash your hands before touching your face or food if you have been working in the water or soil or with chemicals.
- Stay in the testing area. Don't wander away from the group.

Water Quantity - Observations and Data

As you make some brief observations about the quantity and flow of water in your riparian zone, keep in mind some of the important functions of the zone:

- slowing the speed of high, fast-moving water, which helps to reduce erosion;
- storing floodwater and recharging groundwater; and
- creating deep, calm areas in the water that provide habitat for fish, waterfowl, and other aquatic animals.

Type of Stream in a Normal Year

Depending on where you live, the stream you are studying may not have water in it throughout the year. Scientists have several terms they use to describe streams, based on their observed flow. Circle the term in the data sheet below that best describes your stream. Ask your guest natural resource specialist or other adult if you're not sure of the correct answer.

Stream Type Data Sheet		
Perennial Usually flows through the entire year	Intermittent Usually does not flow during dry seasons	Ephemeral Only flows for a short time after a storm

Water Levels

Water levels in a stream can be affected by a variety of factors, including recent precipitation or drought. Do you see signs of variation, such as indications of high water or flooding, at your site? If yes, describe and/or sketch what you see below.

Stream Velocity

How fast is the water in your stream moving? Taken together, the speed or velocity and the amount of water in a stream make up the flow of the stream. Stream flow can affect the concentration of various substances in the water, including pollutants. It can also have a great impact on how much erosion and deposition can take place. In addition, flow helps to determine the kinds of plants and animals that can inhabit any particular stretch of the stream. By testing your stream's velocity, you can gain a better idea of the stream's flow and of how that flow affects the functions of your riparian zone.

Work with your leader to find a safe place where your team can test your stream's velocity. You will need an access point, such as a bridge or a point bar, and a second place 3 meters downstream where a timekeeper with a stopwatch has a clear view of the stream. Then follow the steps below:

1. The person at the "top" point (upstream) should gently toss an orange or apple at least 2 meters upstream of where he or she is standing. The "tossers" should try to throw it into the middle of the stream. As the object passes the point, a spotter should yell "start." This is the signal for the timekeeper to start timing.
2. When the object passes the location 3 meters downstream, a spotter there should yell "time." The timekeeper should stop timing and record the time in seconds.
3. Repeat the process 2 more times. Do not count any trials where the float gets stuck in debris, along the bank, or in an eddy.
4. Use the formulas provided in the data sheet to figure out the velocity of the stream.

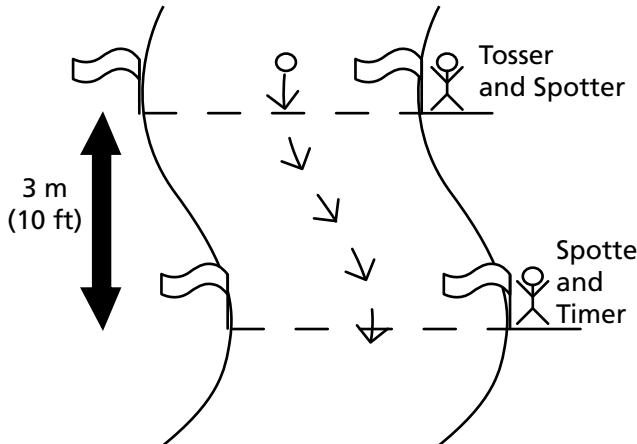
Stream Velocity Data Sheet	
Trial 1: _____ sec + Trial 2: _____ sec + Trial 3: _____ sec = Total of _____ sec divided by 3 = an average travel time of _____ sec.	<p>The length of the test site divided by the average travel time equals the velocity.</p> 
3 m distance traveled divided by _____ avg. travel time = _____ velocity (m/sec).	

Water Quality - Observations and Data

You already know that water has to be clean before you can drink it safely. It must also have certain chemical and physical characteristics to sustain healthy plants and animals. Human activities can cause undesirable changes in water that can harm living organisms. The things we add to water that cause these changes are called pollutants. Animal waste, excessive sediment, and hazardous chemicals, such as fertilizers and weed killers, are examples of pollutants that can affect water quality in the riparian zone.

Scientists rely on a variety of tests and observations to evaluate water quality. Here are a few that you and your team members can perform in your zone.

Water Appearance

Do you see any signs of water pollution? Check the term(s) in the data sheet that best describes the physical appearance of the water in the stream.

Water Appearance Data Sheet

- Clear: colorless, transparent.
- Turbid: cloudy-brown due to silt or plant material in the water.
- Milky: cloudy-white or gray; may be natural or due to pollution.
- Foamy: caused by excessive nutrients from either natural sources or from pollution.
- Dark Brown: may indicate that acids are being released into the stream by decaying plants.
- Oily Sheen: a multi-colored reflection; can occur naturally or it may indicate oil or other petrochemicals in the stream.
- Reddish: may indicate acids draining into the water or iron bacteria.
- Green: caused by algae that may indicate excess nutrients being released into the stream.

Water Odor

What do you smell? Water odor may be an indication that water is polluted. Check those indicators that apply.

Water Odor Data Sheet

- No odor
- Odor present. Rank the strength (circle one): weak strong overwhelming
 - Sewage: May indicate the presence of human waste or livestock manure. If you smell sewage/manure or a rotten egg smell, please do not touch or enter the water. Check with your leader before proceeding.
 - Chlorine: May indicate that a sewage treatment plant is using too much chlorine and discharging it into the stream; also a component of milkhouse cleaning.
 - Fishy: May indicate the presence of dead fish or excessive algae.
 - Rotten Eggs: A sulfurous smell may indicate muck soils or sewage/manure pollution. Hydrogen sulfide gas is a product of organic decomposition.
 - Petroleum: May indicate an oil spill from boats and personal watercraft, land, or storm drains.

Litter Evaluation

Litter in or near the water is another form of pollution. Examine your site and note the types of litter you see. See the data sheet below for an example of how to describe the litter.¹

Litter Data Sheet		
Type of Litter	Description/Quantity	Location
Paper		
Small trash		
Cans		
Bottles		
Tires		
Cars		
Other		

EXAMPLE

Litter Data Sheet		
Type of Litter	Description/Quantity	Location
Paper	<i>newspaper</i>	<i>At the edge of the water, 8 meters upstream from transect site 0</i>
Small trash	<i>fast food wrappers</i>	<i>On the stream bank, across the stream from transect site 0</i>
Cans	<i>4 soda cans</i>	<i>On the stream bank, across the stream from transect site 0</i>
Bottles		
Tires		
Cars		
Other	<i>Hat</i>	<i>Floating in the water 3 meters downstream of transect site 0.</i>

¹ From *Water Action Volunteers—Volunteer Monitoring Factsheet Series* (Univ. of Wisconsin—Extension and Wisconsin Dept. of Natural Resources, 2001)

pH

pH is a measurement of the alkalinity or acidity of a substance on a scale from 1 (most acidic) to 14 (most alkaline). Some streams are more acidic or more alkaline than others, and aquatic organisms in a particular stream are adapted to life in that stream's range of pH. Water with a pH range of 6.5-8.6 will have little effect on most organisms. If the pH of a stream falls unnaturally below 5 (becomes more acidic) or increases unnaturally above 9 (becomes more basic), the health of aquatic life will be in jeopardy.

Use the pH test kit for your measurement. Follow the directions provided by your leader. Once you determine the pH of your stream, put an arrow on the chart in the data sheet below.

Keep in mind that you are testing the pH of your stream at one point in time. In order to assess the health of a riparian zone, scientists look for changes and trends over time.

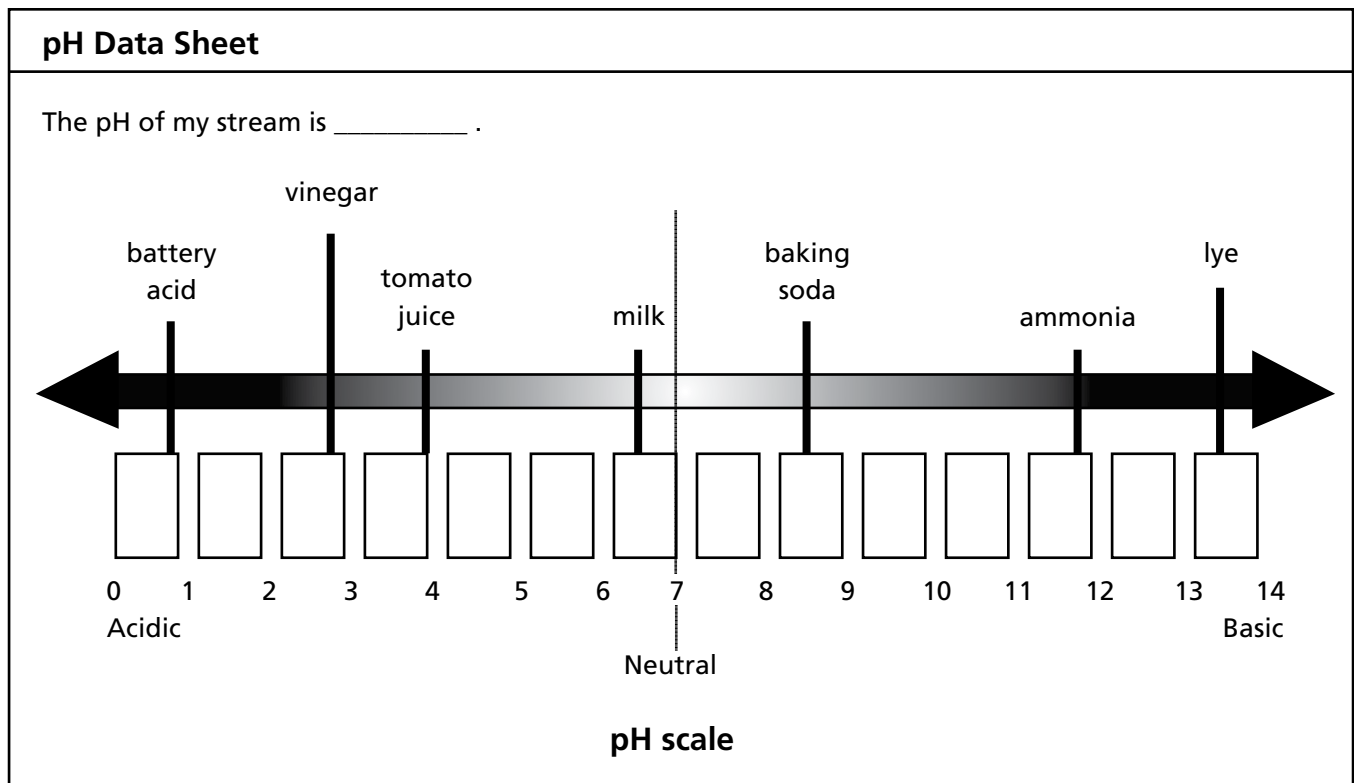

Water Temperature

Monitoring water quality involves more than just checking on pollution. The temperature of the water is also important to aquatic organisms. The temperature can affect organisms in several ways:

- Warm water holds less oxygen than cold water and triggers more plant growth.
- Most aquatic organisms have adapted to living within a range of water temperatures. Trout and salmon, for example, require very cool water, while bass and carp thrive in warm water.
- Extreme temperature fluctuations can make fish and macroinvertebrates more susceptible to disease, parasites, and the harmful effects of pollutants.

Check with your leader to make sure it is safe. Then follow the steps below to determine the temperature of the water and of the surrounding air. Start with the air temperature.

1. Place your thermometer in a location out of direct sunlight, and after a few minutes, note the temperature of the air.
2. Then lower the thermometer about 10 cm below the surface of the water, as close as possible to the middle of the stream.
3. Leave the thermometer underwater until the reading has stabilized. This usually takes about two minutes. Try to take the reading with the base of the thermometer still underwater. Remember to note whether you've measured the temperature in degrees Fahrenheit (F) or Celsius (C).

Temperature Data Sheet	
Air _____ °C/F (circle one)	Water _____ °C/F (circle one)
List three things besides air temperature that might affect water temperature.	

Macroinvertebrate Survey²

Scientists also rely on some small aquatic creatures to tell them whether water is polluted. Macroinvertebrates are organisms that have no backbone, spend at least part of their life cycles in water, and can be seen without a microscope. Some macroinvertebrates are more sensitive to pollution than others. By tallying the types of macroinvertebrates in your stream, you and your team members can gain more information about the quality of the water in the zone. Use the “Macroinvertebrate Tally Sheet” to conduct your survey.

The “Macroinvertebrate Tally Sheet” separates organisms into four groups based on their sensitivity to pollution:

Group 1 – These organisms are very sensitive; they can’t live in polluted water. If pollution increases, the number of these organisms will decrease.	Group 2 – These organisms are somewhat sensitive; they can be found in either very clean or mildly polluted water.
Group 3 – These creatures are fairly tolerant of pollution. Organisms in this group can be found in either clean or somewhat polluted water.	Group 4 – These organisms are found in poor water quality. Organisms in this group are very tolerant of polluted water, but they can still be found in clean water. As pollution worsens, tolerant organisms become more abundant.

A healthy stream will have many different organisms—both pollution-tolerant and pollution-sensitive. Follow the steps below to complete the “Macroinvertebrate Tally Sheet” and give your stream a water quality score.

1. Choose a site for monitoring in an area near the 0 point of the transect line that has been set up for the other teams. You should choose a site with shallow water (8-30 cm) that is moving fast over a stony or gravelly bottom. Areas like this are called riffles. Remember, in the spring the water may be a bit deeper and faster than at other times of the year, so you should be especially careful working in the stream.
2. Before you begin, rinse the net and check that it doesn’t contain any debris from the last time it was used. Fill your basins or buckets with about 3 cm of clean stream water. If you find you have too much water or if the water is too muddy, pour the excess/muddy water through your net into another bucket so you don’t lose any organisms. If necessary, add some clean water to the original sample. Check the net and water in the second bucket for any organisms and return them to the first bucket.
3. At the riffle, place the net downstream from where you are standing so the water current passes you first and then flows into the net. Be sure that the bottom of the net fits tightly against the streambed so no water can flow underneath it.

² From *Water Action Volunteers—Volunteer Monitoring Factsheet Series* (Univ. of Wisconsin—Extension and Wisconsin Dept. of Natural Resources, 2001)

Water Ecologist Macroinvertebrate Tally Sheet

Group 1: These are sensitive to pollutants. Circle each animal found.

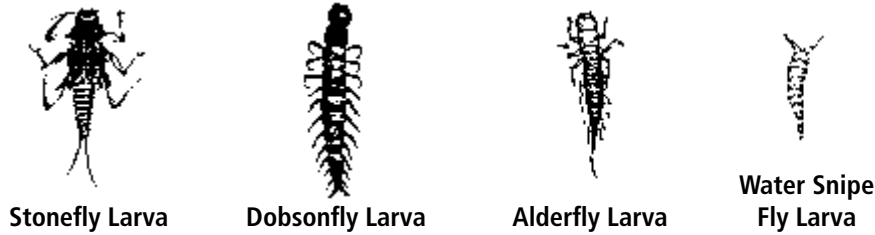

Relative Size Key:

= larger than picture = smaller than picture

Number of group 1 animals circled:

Group 2: These are semi-sensitive to pollutants. Circle each animal found.

Caddisfly Larva*

*All Caddisfly Larva = 1

Dragonfly Larva

Water Penny

Crawfish

Crane Fly Larva

Freshwater Mussel or Fingernail clam

Mayfly Larva

Damselfly Larva

Riffle Beetle Larva*

Riffle Beetle Adult*

*All Riffle Beetles = 1

Damselfly tail (side view)

Number of group 2 animals circled:

Group 3: These are semi-tolerant of pollutants. Circle each animal found.

Black Fly Larva

Non-Red Midge Larva

Snails: Orb or Gilled (right side opening)

Amphipod or Scud

Number of group 3 animals circled:

Group 4: These are tolerant of pollutants. Circle each animal found.

Pouch Snail (left side opening)

Isopod or Aquatic Sowbug

Bloodworm Midge Larva (red)

Leech

Tubiflex Worm

Number of group 4 animals circled:

© Spring 2004 University of Wisconsin. This publication is part of a seven-series set, *Water Action Volunteers – Monitoring Factsheet Series*. All record forms are free and available from the WAV coordinator. WAV is a cooperative program between the University of Wisconsin-Cooperative Extension & the Department of Natural Resources. For more information, call (608) 265-3887 or (608) 264-8948. Download and print data sheets from clean-water.uwex.edu/wav.



Macroinvertebrate Tally Sheet ²

Name: _____ Date: _____

Stream Name: _____ Time: _____

Do not count individual animals. Instead, focus on the types of animals found in each group. The variety of animal types and their tolerance to pollution provide clues about the quality of the water you are testing.

Number of animals from Group 1: Sensitive _____ x 4 = _____

Number of animals from Group 2: Semi-sensitive _____ x 3 = _____

Number of animals from Group 3: Semi-tolerant _____ x 2 = _____

Number of animals from Group 4: Tolerant _____ x 1 = _____

TOTAL NUMBER OF ANIMALS (A) _____ TOTAL VALUE (B) _____

Index score (C) = The total value (B) divided by the total number of animals (A)
(C = B / A)

My stream had an index score of: _____

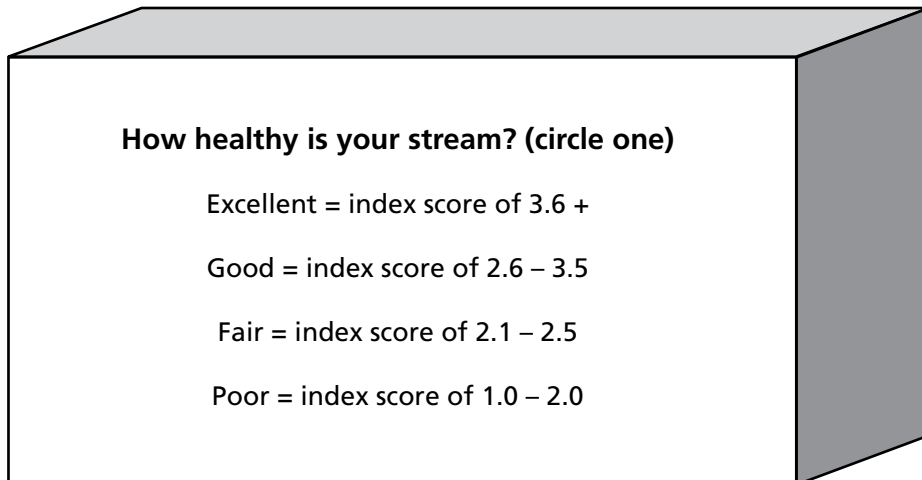

How healthy is your stream? (circle one)

Excellent = index score of 3.6 +

Good = index score of 2.6 – 3.5

Fair = index score of 2.1 – 2.5

Poor = index score of 1.0 – 2.0

² Adapted from *Water Action Volunteers*, Univ. of Wisconsin - Extension and Wisconsin Dept. of Natural Resources, 2001.

4. Kick the rocks and gravel on the bottom of the streambed. This will dislodge critters that live on or under rocks, allowing them to float downstream into your net. Use your hands to “scrub” some of the rocks, too. Scrubbing will help dislodge even more organisms.
5. After kicking, carefully remove the net from the stream. Use a scooping motion to bring it toward you without losing anything that’s caught in the net.
6. Place about 3 cm of water in each white tray or basin and empty the contents of your net into them. Look for anything that moves. Sift through the debris (leaves, algae, sediment) to make sure you don’t miss anything. Little animals are more abundant than big ones such as fish and crayfish.
7. Repeat Steps 3-6 until you have collected about 100 organisms in your basin or tray.
8. On the stream bank, fill the ice cube trays with stream water. Separate the organisms into look-alike groups in different sections of the trays. Use the spoons and tweezers to pick up the organisms. Then using the “Key to Macroinvertebrate Life in the River,” do your best to carefully identify your catch.
9. Use the “Macroinvertebrate Tally Sheet” to record the kinds of animals that were collected from your site.
10. Calculate your stream’s water quality score using the formulas on the tally sheet and enter this information on the data sheet below.
11. Return the organisms to the water after you’ve identified them.

Macroinvertebrate Survey Data Sheet			
My stream’s water quality score is _____.			
My Macroinvertebrate Tally score indicates that the water quality of the stream is:			
(circle one)			
Over 3.5	Excellent	2.6 - 3.5	Good
		2.1 - 2.5	Fair
		1 - 2	Poor



Water Ecologist Zone Notes

Use your observations and data to answer the following questions in your Zone Notes:

1. Did erosion in the GREEN Zone have an effect on the water quality of the stream you tested? What evidence did you see that supports your opinion?

- Did the speed of your stream contribute to erosion in the zone? How can you tell?

2. Do you think the temperature of the stream or the quality of the water could have any effects on the plants and animals in the riparian zone? Cite some specific examples you observed.

- Will the pH level in your stream support aquatic life?
- Do you think the quality of the water affects human activities around your stream? How?

3. What effects do you think vegetation has on the temperature and the quality of the water in your riparian zone? Explain your answer.

- Did you observe any evidence of human or animal activity affecting the quality of water in the riparian zone? If so, cite some examples.

4. What natural features or events might increase or decrease the speed of the stream in your riparian zone? What about human actions? Make a list with your team.

5. How do you think the quantity of water in your stream affects the plants and animals that live in your riparian zone?



UNIT 3 - Soil Scientist

FIELD GUIDE FOR THE GREEN ZONE



Preparing for Field Work

What you will do:

- observe, record, and describe the soils that are found in your riparian zone
- describe the condition of the stream bank and look for evidence of erosion
- observe streambed deposits and the shape of the stream channel

You will be conducting many of your investigations along a transect line that your teacher/leader will set up. All the information you need to do your job is in this guide.

What can you determine by examining riparian soils and their characteristics? For one thing, the soils can help

you to define the borders of your GREEN Zone. If you've already completed Unit 2 in the Action Guide, think back to the soil activities. In the Scoop on Soil activities (Texture Test and Percolation Test), you learned how to identify different soil characteristics. You will use the same sampling techniques to examine the soils in your riparian zone. If you haven't completed the indoor soil activities, you might want to do so before heading out on the field trip.

Once you've completed your field observations and data collection, you will answer some questions in your Zone Notebook. And after all four specialist teams finish collecting their data—the key pieces of the GREEN Zone puzzle—all the teams will combine their information to create a detailed picture of the area.

Stream bars are islands of sediment surrounded by the flowing water of a stream or river. Stream bars can form when stream flow goes down. They also occur when there is too much sediment for the stream to move. Stream bars sometimes occur where stream banks have soft soils and are easily eroded. When many stream bars are created, the stream is said to be braided.

Things to Know Before You Go!

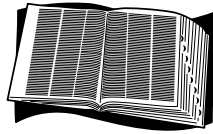

Zone Words

braided stream: stream with many stream bars surrounded by flowing water. (See “stream bars” below.)

point bar: an area found on the inside of a river meander where sediment is deposited after falling out of slow-moving water.

riffle: shallow, fast-moving water where the flow is broken by a bed of gravel, cobbles, or boulders.

runoff: water from precipitation that flows over the land surface into rivers, streams, marshes, and other water bodies.

stream bars: islands of soil, gravel, cobbles, or boulders that form in the middle of a stream or river.

Measurement Conversions

2.54 centimeters (cm) = 1 inch

30.5 centimeters = 1 foot

0.305 meters = 1 foot



What you will learn:

- if your GREEN Zone has the soil characteristics that will help it capture, store, and release water
- where the zone begins and ends

Soil Scientist Checklists

1. Materials

Your team will use these items in the field. Your leader has collected all the materials and will give you a large plastic container. Check off each item as you put it into the container. Go through this checklist again before you leave the riparian site so you don't leave anything behind.

- | | |
|---|--------------------------------|
| <input type="checkbox"/> Garden spade | <input type="checkbox"/> Other |
| <input type="checkbox"/> Meter stick | _____ |
| <input type="checkbox"/> Calculator | _____ |
| <input type="checkbox"/> Clipboard | _____ |
| <input type="checkbox"/> 2 pencils with erasers | _____ |
| <input type="checkbox"/> 10-meter-long string | _____ |

2. Safety

A safe trip will be a fun trip for everyone. Read the safety tips below and put a check next to each one so your teacher/leader knows you've read it.

- If you plan to work in the water, make sure you have a buddy and an adult supervisor present.
- Stay out of streams with fast-moving water.
- When you wade into water, stop when it reaches your knees.
- Work carefully on stream banks. They may crumble or be slippery.
- Ask your leader to show you poisonous plants in the area.
- Watch out for broken glass, rusty cans, barbed wire, and other hazards that you may find at your test site.
- Wear goggles and gloves when you work with chemicals or with water you think might be polluted.
- Wash your hands before touching your face or food if you have been working in the water or soil or with chemicals.
- Stay in the testing area. Don't wander away from the group.

Soil Characteristics - Observations and Data

The types of soil in a riparian zone can provide you with clues about the zone and its boundaries, and about the way the zone functions. As you move along the transect line, you may observe surprising changes in the soil. You may notice variations in texture, for example, which can indicate that soils were deposited at different times or came from different sources. Differences in color can indicate whether water and organic material are plentiful in a particular area or not. Some soils are more typical of riparian zones, while others are more likely to be found in drier upland areas. Follow the steps below to investigate soil characteristics in your GREEN Zone.

1. Start this investigation at the transect line. Use a spade to dig a hole about 60 cm deep at three transect sites: 0 m, 20 m, and 50 m. Use the spade to make a clean cut in the side of the hole so you can clearly see the soil layers (called soil horizons).
2. Repeat the following procedure at each of the depths indicated on the data table (20, 40, and 60 cm):
 - a. Take a handful of soil and form a soil ball about 4-5 cm in diameter.
 - b. Examine the outside of the soil ball and then break it into pieces to examine the inside.
 - c. Make observations of the soil characteristics using words like those in the descriptions below.
 - d. Record your descriptions on the data sheet (next page).
3. After completing this activity, please remember to fill the holes.

Answer the questions below to help describe the soil characteristics. The words listed after each question are just suggestions; there are many other words that might be appropriate for describing your soil sample.

How does the soil feel?

Texture: Is it sticky, slippery, gritty, full of coarse pieces?

Water content: Is it dry, moist, wet, sloppy? Make a note if water appears in the hole. If so, at the end of your soil observations, record the distance from the top of the hole to the top of the water level. This would indicate where the water table is located.

What does the soil look like?

Color: black, brown, tan, orange

Tone: light, medium, dark

Pattern: blotchy, striped, spotty

Other observations

Are there living organisms in the soil (worms, “bugs”)?

Is there non-living matter in the soil (rocks, decayed plant matter)?

Does the soil have an odor?

Soil Characteristics Data Sheet			
Transect site - 0 m			
Soil depth	Describe how the soil feels	Describe what the soil looks like	Other observations
20 cm			
40 cm			
60 cm			
Transect site - 20 m			
Soil depth	Describe how the soil feels	Describe what the soil looks like	Other observations
20 cm			
40 cm			
60 cm			
Transect site - 50 m			
Soil depth	Describe how the soil feels	Describe what the soil looks like	Other observations
20 cm			
40 cm			
60 cm			
Example:			
Soil depth	Describe how the soil feels	Describe what the soil looks like	Other observations
20 cm	sticky, moist	light brown, orange, blotchy	worms

Erosion - Observations and Data

Erosion is a natural process. Even though plant roots in a riparian zone hold the soil, it is natural for portions of a healthy stream bank to erode a small amount each year due to the force of water flow during flood events. When sediment drops out of the water—is deposited—it creates rich soils that are an important part of a healthy riparian zone. Erosion is considered harmful when it destroys the stream bank, lowering water quality and reducing the amount of land available for wildlife habitat, livestock foraging, and other uses.¹ Follow the steps below to investigate erosion in the zone.

1. Standing at the 0 transect mark, look upstream and downstream. Use the first part of the data sheet below to guide your observations.
2. Next, look for evidence of erosion on the banks, such as exposed soils and disturbed areas. Start at the 0 transect mark and walk along the transect line. Survey the area within 10 m on either side of the line. Use a 10-m-long string to determine these limits.
3. Use the information on the second part of the data sheet (next page) to guide your survey. Record your data in the appropriate boxes.

Signs of Erosion in the Stream Data Sheet			
Is the stream clear or muddy?	Circle one Clear Muddy	If muddy, list possible causes.	
Are stream bars present?	Circle one	If yes, indicate location (how many meters from transect site 0?)	Source of excessive sedimentation (if evident)
	Yes		
	No		

¹ Adapted from *Montana Stream Management Guide for Landowners, Managers and Stream Users* (Montana Department of Environmental Quality, 1998)

Signs of Erosion on the Banks Data Sheet

Look for:	Where along transect? (Identify site in meters)	Description or sketch of erosion site	What do you think caused the erosion?
<p>Exposed soil Examples:</p> <ul style="list-style-type: none"> • Mud along stream bank • From construction or flood event 			
<p>Disturbed areas Examples:</p> <ul style="list-style-type: none"> • Trampling • Road construction • Agricultural activities 			
<p>Other evidence of erosion Examples:</p> <ul style="list-style-type: none"> • Runoff carrying sediment • Gullies cut in soil • Collapsing stream bank 			

Stream Characteristics - Observations and Data

Streambed Deposits²

The kind of materials you find on the streambed can give you clues about the flow of water in your stream. Streambed deposits also affect the habitat available for aquatic creatures. Check with your leader to make sure it is safe to proceed; then follow the steps below to identify streambed deposits and estimate the percentage of each.

1. If possible, enter the stream from the 0 transect site.
2. Use the descriptions on the data sheet to help you identify the types of bed material in your stream.
3. Estimate the percentage of streambed materials that you find at the 0 transect site. Choose from 0, 25, 50, 75, or 100 percent. The total percentages of all the types should add up to 100 %.

Streambed Deposits Data Sheet	
Types of Bed Materials	Percent (circle)
silt, clay These substances have a sticky feeling. The particles are fine. The spaces between the particles hold a lot of water, making the sediments feel like ooze.	0% 25% 50% 75% 100%
sand (<0.2 cm in diameter) A sandy bottom is made up of tiny, gritty particles of rock that are smaller than gravel but coarser than silt (gritty, smaller than a grain of rice).	0% 25% 50% 75% 100%
gravel (0.2-7.5 cm in diameter) A gravel bottom is made up of stones ranging from tiny 2-mm pebbles to rocks of about 7.5 cm (fine gravel – rice size to marble size; coarse gravel – marble to ping pong ball size).	0% 25% 50% 75% 100%
cobbles (7.5-25 cm in diameter)	0% 25% 50% 75% 100%
stones (25-60 cm in diameter)	0% 25% 50% 75% 100%
boulders (>60 cm in diameter)	0% 25% 50% 75% 100%
bedrock (solid)	0% 25% 50% 75% 100%
TOTAL (should add up to 100%)	

² Adapted from “Habitat Assessments: The Parts Equal the Whole,” *Water Action Volunteers—Volunteer Monitoring Factsheet Series* (Univ. of Wisconsin-Extension and Wisconsin Dept. of Natural Resources, 1999)

Stream Channel

The channel is the part of the stream that holds the main flow of water. The shape of the channel can tell you a lot about how much water and sediment the stream carries. Circle the diagram in the data sheet below that best illustrates your stream channel shape.

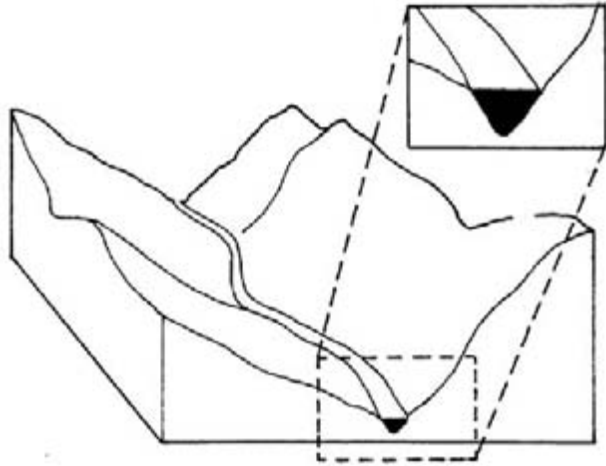
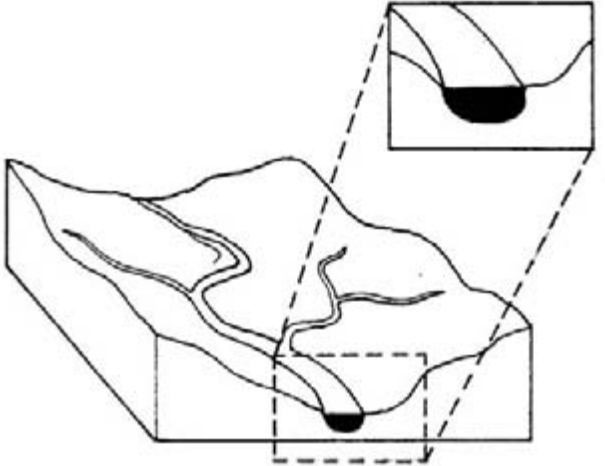
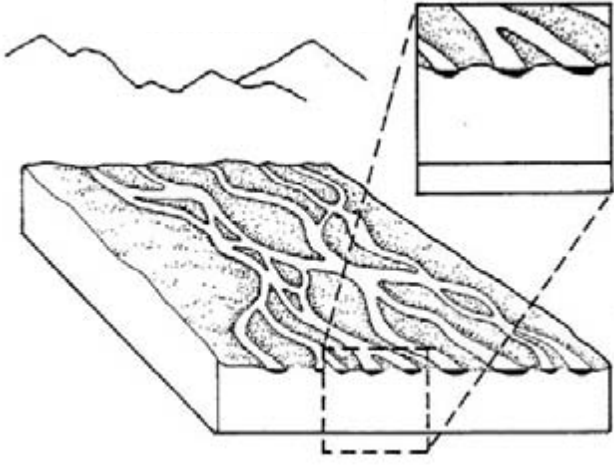
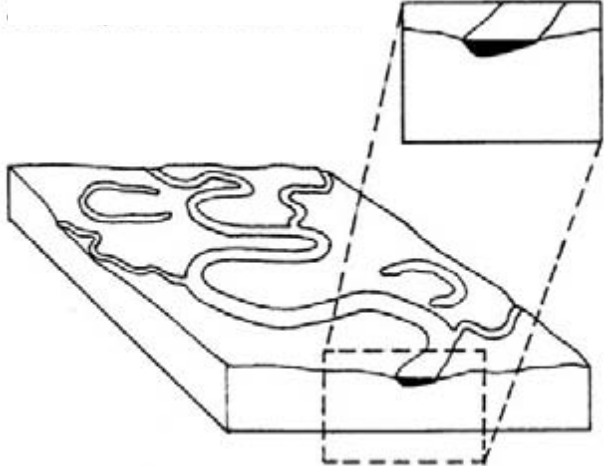
Stream Channel Data Sheet	
<p>V-shape</p> 	<p>U-shape</p> 
<p>Braided</p> 	<p>Wide and Shallow</p> 

Stream Bank

The shape and appearance of the stream bank in your riparian zone can supply you with more clues about the forces of erosion that are at work in the zone. You will also be able to get some ideas about whether your zone is providing habitat for fish and other aquatic animals. Stand at the 0 transect point and look upstream and downstream. First, observe how much vegetation covers the banks of the stream; then note other characteristics of the stream bank. Check the appropriate boxes in each section of the data sheet.

Stream Bank Data Sheet	
Which description best fits the bank of your stream? (check one)	<input type="checkbox"/> Most of the stream bank surfaces are covered by vegetation. <input type="checkbox"/> About half of the stream bank surfaces are covered by vegetation. <input type="checkbox"/> Very little of the stream bank surfaces are covered by vegetation. <input type="checkbox"/> None of the stream bank surfaces are covered by vegetation.
Whether or not the stream bank is vegetated, what other characteristics apply to it? (check all that apply)	<input type="checkbox"/> Eroded <input type="checkbox"/> Rocky <input type="checkbox"/> Trampled (vegetation broken or crushed) <input type="checkbox"/> Compacted (hardened from being pressed together) <input type="checkbox"/> Undercut





Soil Scientist Zone Notes

Use your observations and data to answer the following questions in your Zone Notes:

1. What soil types did you find in the riparian zone? Were they mostly clay, sand, silt, or a combination?

- Would these soil types help slow water during flooding? Why or why not?
- Predict how these soil types might affect groundwater recharge.

2. One of the purposes of the field trip is to define the boundaries of your riparian zone.

- Did the types of soil you sampled change as you moved away from the stream? If so, make a list of the changes you observed.
- Were you able to determine where the riparian zone ends and the upland begins? How? Discuss the clues you used with your team.

3. Does your stream show evidence of upland or streamside erosion creating too much sediment for the water to carry? How can you tell?

- What factors did you observe that might contribute to erosion in your stream?

4. Did you see evidence that vegetation in your riparian zone affects the movement of soil? Cite specific examples of what you observed.

5. Did you see evidence that erosion is affecting the plant life in your riparian zone? If so, describe the evidence you saw.

6. If you saw evidence of excessive erosion in your riparian zone, list animal and/or human activities that might be contributing to this erosion. If you saw little or no evidence of erosion, can you explain why?

7. What effects do you think erosion in the zone might have on animal and/or human activities there?



UNIT 3 - Biologist

FIELD GUIDE FOR THE GREEN ZONE



Preparing for Field Work

What you will do:

- observe, record, and describe the plant and animal life of your riparian zone, including changes in vegetation
- describe ways in which the plants in your zone provide habitat for birds, fish, and other wildlife
- look for ways in which plants and animals have an impact on your zone—either positive or negative

You will do most of your work along a transect line set up by your teacher or leader. All the information you need to do your job is in this guide.

From stabilizing stream banks and reducing erosion to providing food and

shelter for wildlife and livestock, native riparian vegetation performs many important functions in the GREEN Zone. As you saw in Unit 2, plants can help to improve water quality and contribute in other ways to the overall health of the zone. Animals, too—both wildlife and livestock—can have an effect on the way the riparian zone functions. The observations your team makes about the plants and animals in the riparian zone will help your team to suggest where the boundaries of the zone are and to assess the ability of the zone to do its job.

Once you've completed your field observations and data collection, you will answer some questions in your Zone Notebook. And after all four specialist teams finish collecting their data—the key pieces of the GREEN Zone puzzle—all the teams will combine their information to create a detailed picture of the area.

Things to Know Before You Go!

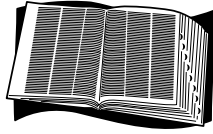

Zone Words

canopy: the parachute-shaped cover provided by shrubs and trees.

habitat: the place where an organism finds the food, water, shelter, and space it needs to survive.

nutrients: substances that promote growth. In a stream or other body of water, fertilizers, animal waste, or decaying leaves and grasses can be considered nutrients.



What you will learn:

- how to determine where the riparian zone begins and ends
- whether the zone is providing habitat for plants and animals

Measurement Conversions

30.5 centimeters (cm) = 1 foot

0.305 meters = 1 foot

$^{\circ} C \times 9/5 + 32 = ^{\circ} F$

$^{\circ} F - 32 \times 5/9 = ^{\circ} C$

Biologist Checklists

1. Materials

Your team will use these items in the field. Your leader has collected all the materials and will give you a large plastic container. Check off each item as you put it into the container. Go through this checklist again before you leave the riparian site so you don't leave anything behind.

- | | |
|---|--------------------------------|
| <input type="checkbox"/> Clipboard | <input type="checkbox"/> Other |
| <input type="checkbox"/> 2 pencils with erasers | _____ |
| <input type="checkbox"/> 50 cm of rope | _____ |
| <input type="checkbox"/> Tape measure (meter) | _____ |
| <input type="checkbox"/> Ruler (meter) | _____ |
| <input type="checkbox"/> Ocular tube or toilet paper roll | _____ |
| <input type="checkbox"/> Field guide to local plants | _____ |
| <input type="checkbox"/> Field guide to local animals | _____ |

2. Safety

A safe trip will be a fun trip for everyone. Read the safety tips below and put a check next to each one so your teacher/leader knows you've read it.

- If you plan to work in the water, make sure you have a buddy and an adult supervisor present.
- Stay out of streams with fast-moving water.
- When you wade into water, stop when it reaches your knees.
- Work carefully on stream banks. They may crumble or be slippery.
- Ask your leader to show you poisonous plants in the area.
- Watch out for broken glass, rusty cans, barbed wire, and other hazards that you may find at your test site.
- Wear goggles and gloves when you work with chemicals or with water you think might be polluted.
- Wash your hands before touching your face or food if you have been working in the water or soil or with chemicals.
- Stay in the testing area. Don't wander away from the group.

Vegetation - Observations and Data

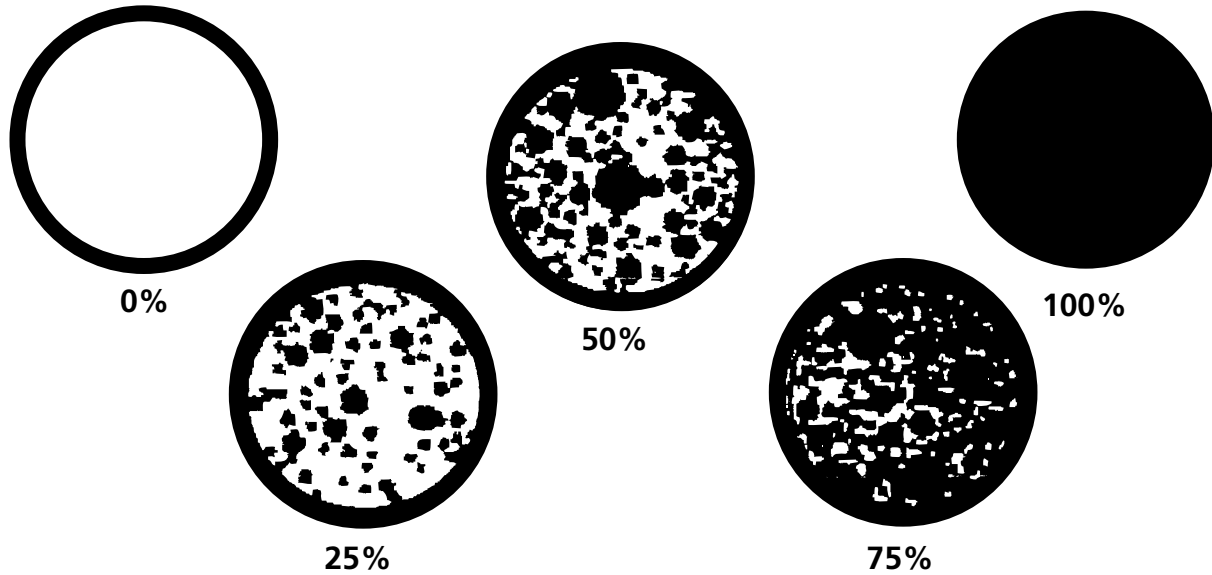

Canopy Cover

Whether a riparian zone has trees, shrubs, herbaceous (non-woody) plants, or a mix of all three, the vegetation provides cover to the soil, protecting against the energy of raindrop impact. The branches and leaves of riparian plants create an umbrella- or parachute-shaped cover over the ground. By reducing the impact of raindrops, this vegetation canopy can reduce erosion in the GREEN Zone. Less erosion means less sediment in the water, which benefits the spawning and growth of fish. In addition, shade from the canopy of trees helps to moderate water temperatures, which also improves habitat for aquatic creatures.

How much of your riparian zone is covered by vegetation? Stand at each of the transect sites listed below. Using one eye, look up at the sky through the ocular tube (or toilet paper roll). As you look, have a partner make sure the tube is straight up and down, not tilted. Estimate the percentage of canopy cover at that site by deciding how much of the area visible through the tube is covered by vegetation. See the diagram above for examples. Mark your estimate for each transect site on the canopy cover data sheet below.

Canopy Cover Data Sheet					
Transect Site	Canopy Cover	Canopy Cover	Canopy Cover	Canopy Cover	Canopy Cover
0 m	0%	25%	50%	75%	100%
5 m	0%	25%	50%	75%	100%
20 m	0%	25%	50%	75%	100%
35 m	0%	25%	50%	75%	100%
50 m	0%	25%	50%	75%	100%

Plant Diversity

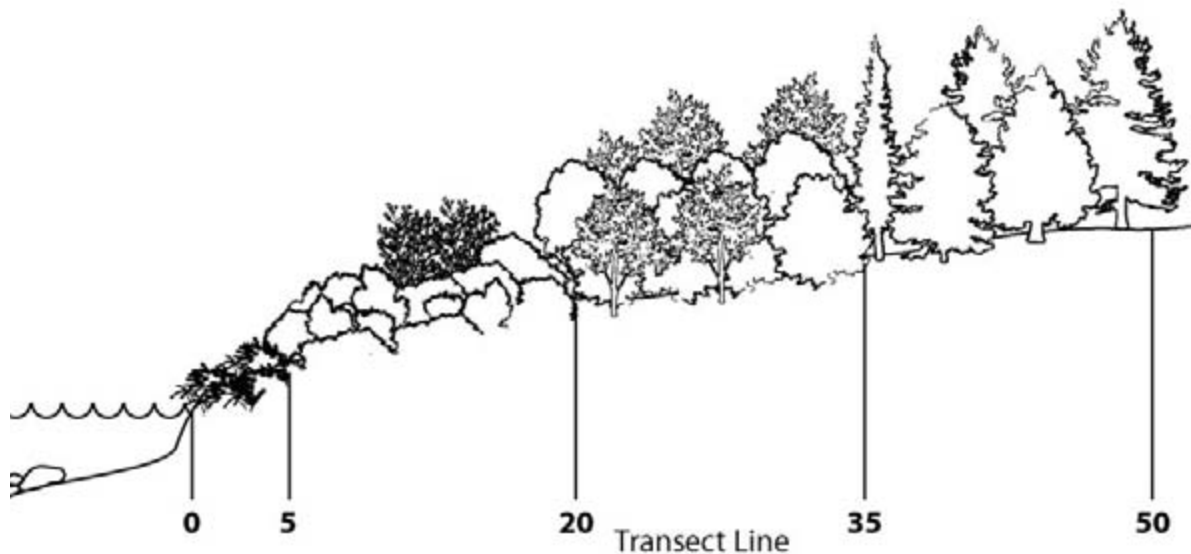

A healthy GREEN Zone supports a wide variety of riparian vegetation that performs many important functions. In Unit 1, you discovered that the riparian zone is an **ecotone** – a place where ecosystems blend together. Ecotones are characterized by a rich diversity of life, so you would expect to find a variety of both upland plants and aquatic plants in your riparian zone. By surveying the diversity of plants in your zone, your team should find evidence of the transition between aquatic and upland species. Follow the steps below to conduct your survey and enter your observations on the data sheet on the next page.

1. At each transect site use a 50-cm piece of rope to help you estimate a circle 1 m in diameter.
2. In the second column of the data sheet, estimate the percentage of the ground in each 1-m circle that is covered by vegetation. Use the diagrams on page 84 as a guide.
3. If the ground at a site does have vegetation, note how many different kinds of trees, shrubs, and herbaceous (non-woody) plants you see within the circle. Mark your answers in the third column.
 - Trees are plants with trunks bigger than 8 cm in diameter.
 - Shrubs are plants with many woody stems smaller than 8 cm in diameter.
 - Herbaceous plants include sedges, grasses, and other non-woody plants.
4. What plant type is dominant at this site? Use a field guide or ask an adult to help you identify the plant. Write your answers in the fourth column.
5. As you walk along the transect line, take note of places where the vegetation changes. Describe these transitions in column five, along with the location on the transect line where they occur. See the example at the bottom of the data sheet.

Plant Diversity Data Sheet					
Transect site	Percentage of ground covered by vegetation	Number of trees, shrubs, non-woody plants		Most abundant plant type at this site	Transitions observed and location
0 m		Trees			
		Shrubs			
		Non-woody plants			
5 m		Trees			
		Shrubs			
		Non-woody plants			
20 m		Trees			
		Shrubs			
		Non-woody plants			
35 m		Trees			
		Shrubs			
		Non-woody plants			
50 m		Trees			
		Shrubs			
		Non-woody plants			
Example	75%	Trees	1	Sedges	Sedges thinning out, more willows -7 m
5 m		Shrubs	3		
		Non-woody plants	4		

The Water's Edge - Observations and Data

As you know, many factors contribute to the condition of the stream banks. This data sheet will help you focus on the area closest to the water. What does it look like? Are there rocks or eroded banks close to the stream? Do the plants there have deep and binding roots that hold onto the soil and reduce erosion? Keep in mind that not all plants provide the same benefits to the zone. Think back to Unit 2 and the characteristics to look for in riparian vegetation. Follow the steps below to survey the water's edge.

1. Stand at the water's edge at the 0 transect point and look upstream. How would you describe the stream bank? On the data sheet, check any of the descriptions that apply for as far as you can see.
2. Next, observe the area on each side of the stream up to about 5 meters from the water's edge. Review your plant diversity data sheet to note the plants that are most abundant at transect points 0 and 5 m. Use your field guide or check with your natural resource professional to determine if any of those plants are invasive species.

Water's Edge Data Sheet	
	Banks breaking off or eroding
	Banks with rock
	Banks of sand and silt
	Undercut banks
	Banks with overhanging shrubs and trees (like willows, dogwood, alders)
	Banks with desirable native grasses and sedges (Ask your guest natural resource professional for help.)
	Banks with other non-woody plants (knapweed, leafy spurge, dandelion, Canada thistle)
	Banks with signs of disturbance (trampling, beaver activity). Describe what you see.
<div style="border: 1px solid black; min-height: 200px; width: 100%;"></div> <p>In the space below, make a sketch of the water's edge.</p>	
Holding onto the GREEN Zone - Unit 3 - Biologist	

Animal Life - Observations and Data

Both in the water and along the water's edge, healthy and diverse riparian vegetation helps to sustain bird and fish populations as well as populations of game species such as elk and deer. Riparian plants provide food and cover from predators. Even in the water, fallen trees and branches shelter aquatic animals. Is your riparian zone doing its job of providing food and shelter for a large variety of animals? Try the following techniques to find out. Keep in mind that one visit to a riparian zone will not give you a complete view of animal life in the zone. And don't forget to keep quiet as you work to avoid scaring animals away.

Animal Sounds

As you walk your transect line, stop and listen at each site listed on the data sheet. Do you hear any animal sounds? If so, list them in the data sheet.

Animal Sounds Data Sheet					
Transect Site	Type of animal sound (vocal, tapping, movement)	Describe the sound.	How often did you hear it?	Was it up high or down low?	Can you see the animal making the sound? If so, try to identify it.
0 m					
5 m					
20 m					
35 m					
50 m					

Animal Sightings

Walk along the transect line. Stop at each transect site and look around. Pick up rocks or branches, if you can, and look under them. Just don't forget to put them back. Do you see any animals from that spot? Try to identify the animals with the help of your field guide or your natural resource professional. Use the data sheet to describe what you see.

Animal Sightings Data Sheet				
Transect Site	Animal seen	Describe or draw the animal.	Where was it seen? (Above ground, under a shrub, etc.)	Abundance (How many did you see?)
0 m				
5 m				
20 m				
35 m				
50 m				

Animal Signs

Do you see any signs of animals at each of the transect sites? Look for tracks; scat (animal droppings); webs or nests; fur or hair on branches; feathers; plants that have been dug up, bitten off, or chewed on; holes in the ground; piles of sticks, grasses, or branches.

Animal Signs Data Sheet				
Transect Site	What sign did you find? Describe it.	What animal do you think left the sign?	Where did you see it?	How many signs did you see?
0 m				
5 m				
20 m				
35 m				
50 m				



Biologist Zone Notes

Use your observations and data to answer the following questions in your Zone Notes:

1. Does the soil in your zone support a wide variety of plant types? How can you tell?

2. Do you think the vegetation in your GREEN Zone helps to provide erosion control?

- Cite specific evidence you observed to support your answer.
- How could erosion affect aquatic life?
- Why is erosion control important for the stream's aquatic life?

3. Do you think the plant canopy cover at your site is helping to moderate water temperatures? Why or why not?

4. Did you see any evidence that humans have affected the plant life in your riparian zone? If so, list some examples.

5. Did you observe any impacts from wildlife or livestock on your riparian zone? Cite examples you saw.

- Do you think these impacts are helping or harming the zone? Explain your answer.
- Did you notice more animals (wildlife or livestock) in one part of your site than another? Where? Why?

6. Do you think this site provides good nesting and food choices for birds? Why or why not?

7. Did you observe changes in the vegetation as you moved along the transect line in your zone? If so, describe those changes.

8. Were you able to suggest where the riparian zone ends and the upland begins? How? Discuss clues you used with your team.



UNIT 3 - Physical Geographer

FIELD GUIDE FOR THE GREEN ZONE



Preparing for Field Work

What you will do:

- **measure, test, record, and describe different characteristics of the land and water in your riparian zone**
- **observe the impacts of animal and human activities on your zone**
- **make a base map for use by the other specialist teams**

You will do some of your work near the stream, but you will also take a brief walking tour of the surrounding area. All the information you need to do your job is in this guide.

A physical geographer is a scientist who studies the surface features of the land and the processes that shape these features. Physical geographers also examine

ways in which human activities affect the land.

In Unit 2, you learned how “water shapes the GREEN Zone,” and saw photos illustrating floodplains and terraces. You might want to review this section (Unit 2, Station 1) before you go on your field trip, because once you’re “in the zone” you will be looking for similar features. You and your team are also responsible for collecting base information that will be used to create a site map—one that all the teams will use to help summarize their findings.

Once you’ve completed your observations, data collection, and mapping, you will answer some questions in your Zone Notebook. And after all four specialist teams finish collecting their data—the key pieces of the GREEN Zone puzzle—all the teams will combine their information to create a detailed picture of the area.

Things to Know Before You Go!

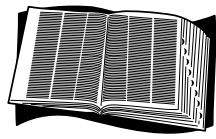

Zone Words

bankfull flow: the width of a stream when the channel is full and about to spill over onto the floodplain.

floodplain: a flat area on either or both sides of a stream or river that is created by periodic flooding.

gradient: the degree to which something slopes upward or downward.

point bar: an area found on the inside of a river meander where sediment is deposited after falling out of slow-moving water.

riffle: shallow, fast-moving water where the flow is broken by a bed of gravel, cobbles, or boulders.

topography: the shape of the land.

wetted edge: the point at the edge of a stream where the water touches the stream bank.

Measurement Conversions

1 foot = 0.305 meters

1 acre = 4,047 square meters (m²)

1 hectare = 10,000 square meters (m²)

1 kilometer = .62 miles = 1,094 yards



What you will learn:

- where the zone begins and ends
- how the shape of the land affects other key parts of the riparian zone
- how human activities have affected the ability of the zone to do its job

Physical Geographer Checklists

1. Materials

Your team will use these items in the field. Your leader has collected all the materials and will give you a large plastic container. Check off each item as you put it into the container. Go through this checklist again before you leave the riparian site so you don't leave anything behind.

- | | |
|---|---|
| <input type="checkbox"/> Spade | <input type="checkbox"/> Poster paper for site map drawing |
| <input type="checkbox"/> Clipboard | <input type="checkbox"/> Optional: Digital or 35 mm camera and film or video camera and videotape |
| <input type="checkbox"/> 2 pencils with erasers | <input type="checkbox"/> Other |
| <input type="checkbox"/> Tape measure (meters) or length of clothesline (10 m length) | _____ |
| <input type="checkbox"/> 2 stakes (approx. 30 cm long) | _____ |
| <input type="checkbox"/> Mallet | _____ |
| <input type="checkbox"/> 2 meter sticks | |
| <input type="checkbox"/> Level | |
| <input type="checkbox"/> Compass | |
| <input type="checkbox"/> Colored pencils or markers for site map | |

2. Safety

A safe trip will be a fun trip for everyone. Read the safety tips below and put a check next to each one so your teacher/leader knows you've read it.

- If you plan to work in the water, make sure you have a buddy and an adult supervisor present.
- Stay out of streams with fast-moving water.
- When you wade into water, stop when it reaches your knees.
- Work carefully on stream banks. They may crumble or be slippery.
- Ask your leader to show you poisonous plants in the area.
- Watch out for broken glass, rusty cans, barbed wire, and other hazards that you may find at your test site.
- Wear goggles and gloves when you work with chemicals or with water you think might be polluted.
- Wash your hands before touching your face or food if you have been working in the water or soil or with chemicals.
- Stay in the testing area. Don't wander away from the group.

Lay of the Land - Observations and Data

Slope of the Stream

How steep is your stream? Steepness or gradient measurements indicate a change in elevation over a certain distance. The gradient or slope of the stream affects how fast the water flows and how much soil the stream can move downstream.

Scientists usually measure stream gradient in terms of feet per mile, or they use specialized equipment to measure the slope. But you can estimate the gradient of your stream by listening. Use your ears and the sound of the water to estimate slope as you stand on the bank at 0 on the transect line. Circle the percent slope that applies.

Stream Slope Estimate Data Sheet		
Gentle Slope < 2% I can't hear water flowing.	Moderate Slope = 2-4% I can hear water flowing.	Steep Slope > 4% The stream seems very loud - I can hardly talk over it!

Topography

Stand on the bank at transect site 0 facing upstream. Look as far to the left and right as you can. What is the shape or topography of the riparian zone? Circle the drawing in the data sheet below that best illustrates the topography of your study area. If none applies, draw the shape of your zone in the "other" box.

Topography Data Sheet				
Flat	Terraces	Rolling hills	Canyon	Other

Meanders

Stream slope and topography influence the creation of meanders—or curves—in a stream channel. Can you observe any meanders when you stand at the 0 transect point? Look upstream and downstream. Pretend you are looking at your stream from a bird's-eye view. Circle the view that looks most like your stream in the data sheet below.

Meanders Data Sheet		
Straight	Slightly meandering	Very curvy (meandering)

Width of the Stream

How wide is the stream channel in your riparian zone? You will actually take this measurement at two points, the bankfull flow and the wetted edge. **Bankfull flow** describes the width of the stream when the channel is full and about to spill over onto the floodplain. The **wetted edge** is the place where the stream bank and water line meet. Depending on the topography and conditions at your stream, it may be difficult to recognize the distinction between bankfull flow and wetted edge. Check with your natural resource professional for help.

Measurements will be taken across the stream and perpendicular to the flow of water. Your ability to determine the width will depend on the size of the stream and your ability to access both banks. Talk to your leader about the best and safest way to take this measurement. Follow the steps below to determine your stream's width.

1. Start at transect site 0. To measure the bankfull flow width, find the point at the top of the stream bank where the water would leave the stream channel and spill onto the floodplain. Drive a stake in the ground at that point.
2. Cross the stream (only with the permission of your leader) and drive a stake in the ground at bankfull flow on the other side of the stream.
3. Using a tape measure or length of clothesline, measure the distance between the two stakes. Try to have the line taut and level (parallel) to the ground when you measure. Write your findings on your data sheet.
4. Next measure the width of the stream at the wetted edge. One team member should hold a meter stick at the point where the water touches the stream bank near transect site 0. This person should hold one end of the tape measure or clothesline.
5. A second team member should cross the stream (with your leader's permission), taking along a meter stick and the other end of the tape measure or clothesline.
6. Measure the distance between the two meter sticks. Try to have the tape or clothesline taut and as level as possible when you take the measurement. Mark your findings on your data sheet.

Stream Width Data Sheet

At transect site 0 the stream in my riparian zone is _____ meters wide at bankfull flow.

At transect site 0 the stream in my riparian zone is _____ meters wide at the wetted edge.

Use of the Land - Observations and Data

Land uses near the stream and throughout a watershed can have dramatic effects on a riparian zone. By surveying your site and the surrounding area, you can look for evidence of land uses and their impacts on your GREEN Zone.

Channel Alteration

Human activities can affect riparian zones in many ways. The data sheet below includes a list of some of the ways in which humans can change a stream channel. As you stand at the 0 transect site, look upstream and downstream. Do you see any signs of these activities? Use the data sheet to note your observations. Check all that apply.

Channel Alteration Data Sheet
Yes, this section of the stream has been:
<input type="checkbox"/> Straightened
<input type="checkbox"/> Dredged (deepened)
<input type="checkbox"/> Dammed
<input type="checkbox"/> Altered by bridge abutments (the base of the bridge)
<input type="checkbox"/> Diverted into a concrete channel
<input type="checkbox"/> Reconstructed with materials such as cobble, boulders, fencing, logs, etc.
<input type="checkbox"/> Reinforced with plant materials
<input type="checkbox"/> Other _____
<input type="checkbox"/> No, I see no change to the stream channel caused by people.

Signs of Disturbance

Start at the 0 transect site and take a walk with your team—and an adult leader—into the surrounding area. Go upstream for about 400 m (.4 km)—about the length of 4 football fields. Then proceed away from the stream for about the same distance. Look for any “Signs of Disturbance” listed on the data sheet on the next page, and check any that are present. Can you determine if these disturbances are having a clear impact on the riparian zone? Make a note in the “Clear Impact” box about what you think the impact is. (An example of a clear impact would be “increased erosion from housing construction.”)

Signs of Disturbance Data Sheet		
Present	Clear Impact	Residential buildings
		Single-family housing
		Multi-family housing
		Lawns
		Commercial/institutional buildings
Present	Clear Impact	Roads and related structures
		Paved roads
		Unpaved roads
		Bridges
		Culverts
		Other stream-crossing mechanisms
Present	Clear Impact	Construction under way on:
		Housing development
		Commercial development
		Culvert repair or upgrade
		Bridge construction/repair
		Road construction/repair
Present	Clear Impact	Agricultural activity
		Grazing land
		Feed lots or animal holding areas
		Cropland
		Inactive agricultural land/fields
		Hoof damage from livestock
Present	Clear Impact	Recreation
		Camping
		Golfing
		Power boating
		Swimming/fishing/canoeing
		Hiking/paths
		Horseback riding
		Park/picnic area/playground
Present	Clear Impact	Wildlife
		Beaver dam
		Heavily browsed vegetation
		Hoof damage (elk or deer)
Present	Clear Impact	Other
		Mining or gravel pits
		Logging
		Industry
		Oil and gas drilling
		Trash dump
		Landfill
		Other _____

Map of the Land

Make a Site Map

Your team is responsible for making the site map of your riparian zone. You may need to do this activity indoors, but while you're in the field make a rough sketch of the area to transfer to your site map later. Start at the 0 transect site and measure 30 m in each direction. Use the compass to determine the orientation of your map. And don't forget to include a scale on your rough drawing. See the example illustrated below.

Mark on your map the following things:

- Vegetation types (grasses, shrubs, trees)
- Areas where vegetation has been removed because of land uses such as logging, housing developments, or livestock grazing
- Physical features in the stream and on land – meanders, riffles, point bars, boulders, terracing, and eroded banks
- Structures made by humans – roads, bridges, culverts, buildings, fences
- Effects of animals such as beaver activity, livestock use

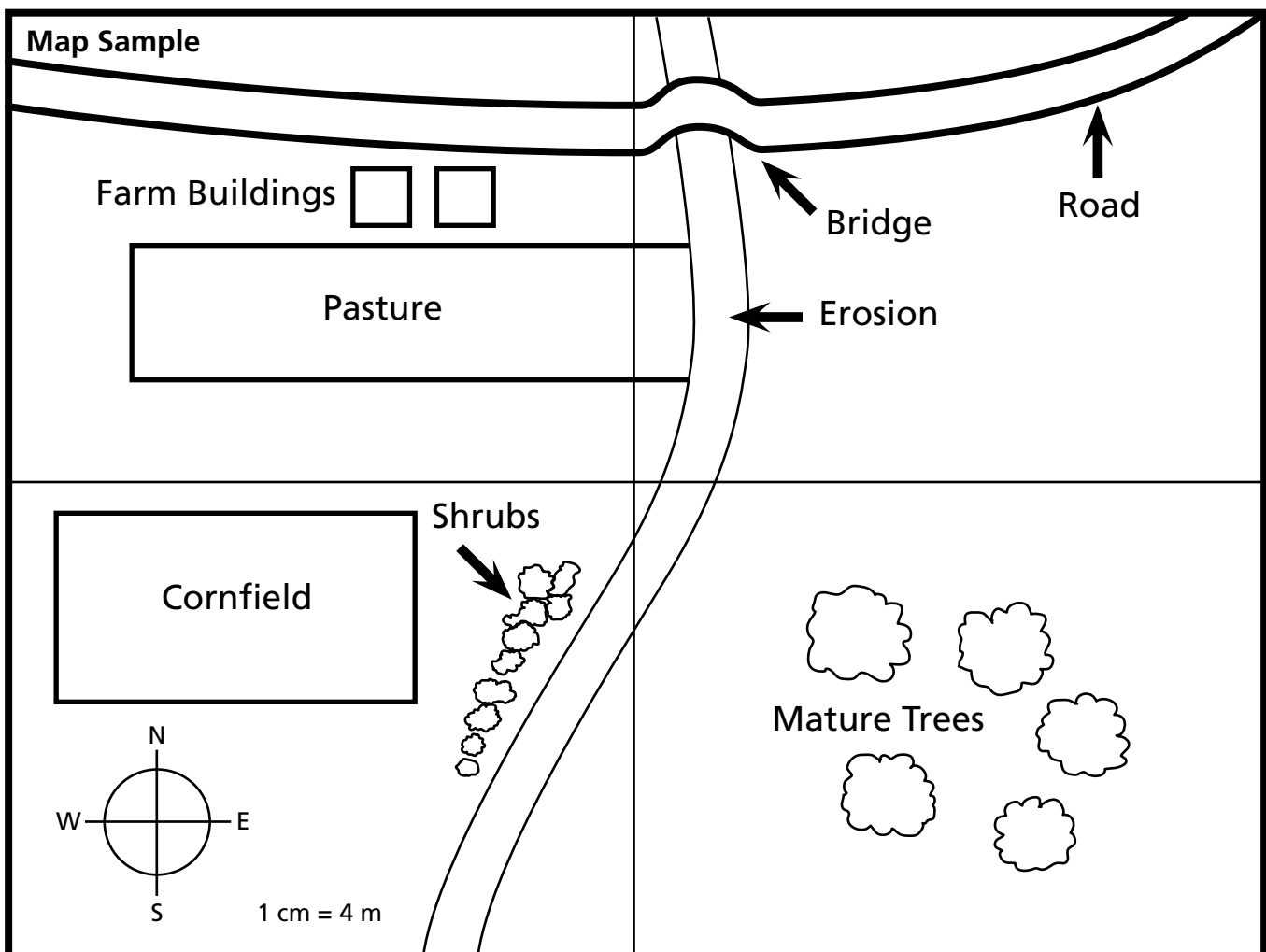



Physical Geographer Zone Notes

Use your observations and data to answer the following questions in your Zone Notes:

1. How do the slope of the stream and the topography of your study area affect the shape of the stream? Cite specific examples you observed.
2. How does the movement of water in your stream affect the topography of your riparian zone?
 - Did you see evidence of erosion, terracing, etc.?
3. Was there a difference between bankfull flow and wetted edge?
 - What do your observations tell you about the quantity of water in the stream?
 - Have storm events or fast-moving water eroded the stream bank? Cite specific examples you observed.
4. What evidence did you see of human activities that are affecting your riparian zone? Make a list of ongoing activities and those that occurred in the past.
5. How does the topography of your study area affect the living components of your riparian zone?
 - How do livestock and wildlife make use of the zone?
6. What effects do these living components have on your riparian zone? Cite specific examples you observed.
7. Were you able to determine where the riparian zone ends and the upland begins? How? Discuss the clues you used with your team.



Holding onto the GREEN Zone - Unit 3 - Physical Geographer

UNIT 4 - Putting the Pieces Together



What is a Healthy Riparian Zone?

You've heard of bus service or phone service or electrical service, but did you know that earth's ecosystems also perform services? When a riparian zone is healthy and doing its job, it performs many services. It stores and purifies water; reduces damage from floodwaters; and provides a home and food for plants, animals, and people—to name just a few. Natural resource specialists say that the zone is healthy if it is in proper functioning condition; in other words, it's healthy if it can do its job.

- Erosion and deposition
- Land uses – human, livestock, and wildlife

You've learned about the important features of a riparian zone and you've gathered GREEN Zone data in the field. On your field trip, your specialist teams focused on water, soil, vegetation and wildlife, and physical geography. In this unit, your team will present its findings to your entire class or group. After you hear what the other three teams discovered, you will be able to form a more complete picture of your riparian zone.

What does this picture look like? Does it show a riparian zone that benefits your community? Do plants and animals also benefit from the riparian zone? By following the steps below, you and your team will be able to organize your observations and put the pieces of the riparian puzzle together.

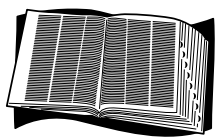

Zone Word

biodiversity: a variety or richness of life on Earth. A key part of healthy ecosystems, biodiversity refers to the number of plants or animals within a single species, the variety of the species themselves, and the variety of ecosystems. Diversity strengthens the potential of populations and species to respond or adapt to changing environmental conditions.

To determine whether the riparian zone is healthy and can do its job, natural resource specialists investigate these factors:

- Water quality and quantity
- Soil qualities
- Plant characteristics
- Stream shape, slope, and speed



Activity - Specialist Team Presentations

Your specialist team will need:

- Completed specialist checklists
- Zone Notes from each team member
- Your natural resource partner, if available
- Copy of the map produced by the physical geographer team
- Copies of the “Key Pieces of the Puzzle” chart (one for each team member—your leader will provide)

Part 1—Planning the Presentation

1. Finish all the calculations on your team’s data sheets and review your specialist Zone Notes. Try to answer all the questions. Your natural resource partners and field trip volunteers should be able to help you.

2. Use the copy of the map produced by the geographers’ team to help summarize your team’s data and explain your results. Make sure your notes and drawings are clear.

3. With your team members, decide how your specialty team will present its results to the class/group. Besides the map, will you need any additional visual aids? Which team member(s) will produce them? Which team member(s) will serve as spokespersons?

4. Refer to the questions on the “Key Pieces of the Puzzle” chart. Decide which questions apply to your team’s area of study. Make

sure your team addresses these questions in your presentation.

5. In addition, each team should try to answer the following questions. Be sure you’re able to explain how your team information supports your answers.

- Describe the upland ecosystem at your site: What does it look like? What lives there? How is it used?
- Describe the aquatic ecosystem: Is it a river, stream, lake, or pond? What living organisms did you see in or near the water? How is the water used?
- Where are the borders of your riparian zone? How did you decide?
- How would you describe the diversity of life in your GREEN Zone? What relationships between living and non-living things in the zone support a diversity of life there? For instance, plant roots hold onto soil, which helps stabilize stream banks, which in turn helps to control erosion, keeping the water cleaner for aquatic organisms. Look at your “Key Pieces of the Puzzle” chart for additional ideas.

Key Pieces of the Puzzle What the data tell us about our GREEN Zone			Key Pieces of the Puzzle What the data tell us about our GREEN Zone	
Characteristics	Questions	My Observations	Characteristics	My Observations
Water Quality and Quantity	<ul style="list-style-type: none"> • Is there enough water above and below the ground to sustain a diversity of life? • Is the water clear? 			
Soil Quality	<ul style="list-style-type: none"> • Can the soil in the zone hold water? • Will it support plants with roots that can hold onto soil? 			
	<ul style="list-style-type: none"> • Are there riparian plants with strong, soil-holding 			

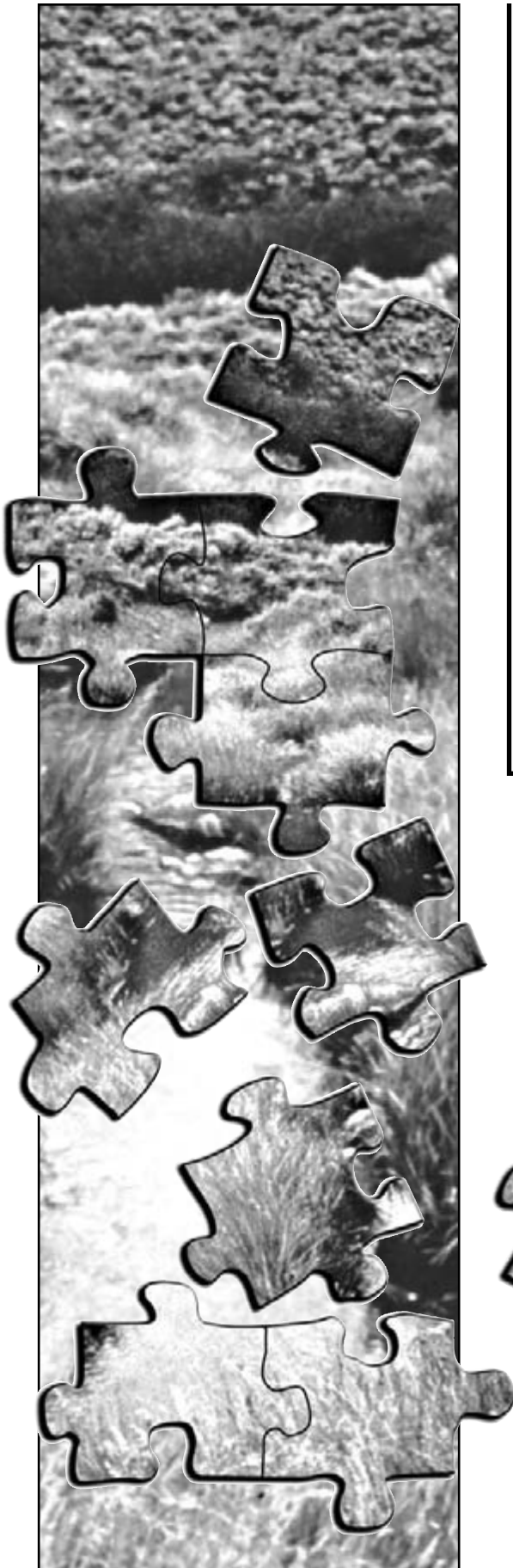

Part 2—The Presentations

Now it's time for each team to present its data. As you listen to the other presentations, keep in mind the questions on the "Key Pieces of the Puzzle" chart. Take notes during each of the presentations and add them to your copy of the chart.

Putting the Pieces Together

Following the team presentations, discuss the questions on the chart with the entire

group. Keep in mind that you and your group have made just one visit to your riparian zone. You have learned some important characteristics to keep observing over time, which is how you gain experience and learn more.

Unlike natural resource specialists who study riparian zones over long periods of time, you've been able to collect only a limited amount of data. Based on your limited observations, what do you think: Can your riparian area do its job? Why or why not?

NEXT TIME

In the next unit, you will take a final look at the benefits a healthy riparian zone provides, and then you will TAKE ACTION to let others in your community know what you've learned about your GREEN Zone.

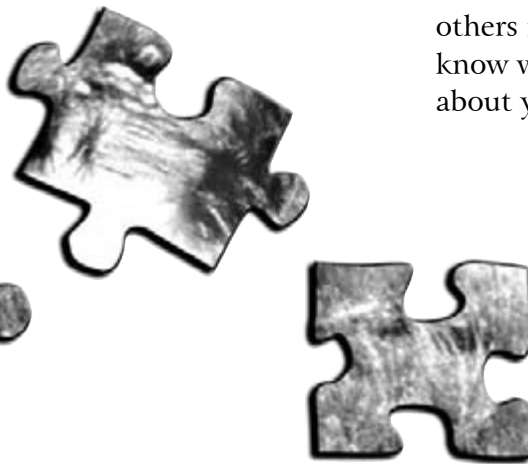

UNIT 5 - Tell the News



Professional natural resource specialists, like water ecologists, soil scientists, biologists, and geographers, often work together on a team to determine if a riparian zone is healthy. They collect data about a particular site to determine if the riparian zone is healthy and functioning properly. The information is collected from many transect lines, at different times of the year, and over a period of time. Then, the specialists combine their information to recommend future action. This team, sometimes called a land management team:

- outlines a management plan to either maintain a healthy zone or restore an unhealthy zone to a healthier condition; and
 - enlists the help of local land users (ranchers, farmers, business/industry leaders, cities, towns) to put the management plan into action.
- You have combined data gathered by your specialist teams and have described your GREEN Zone according to your observations. Now your specialist teams will come together as a larger group, the GREEN Zone Land Management Team.
- analyzes data collected by all the specialists studying the area;



A riparian land management team is a group of natural resource specialists who combine their expertise and efforts to find ways to hold onto the GREEN Zone.



Unit 5, Activity 1 - Tales of our GREEN Zone Adventure

Who would you like to tell about your GREEN Zone adventure? Your family, school, church group, community leaders? What would you like to tell them?

What did you do and what did you learn? Use your site map, pictures, posters, and demonstrations to tell people about your adventure.

Directions

1. Choose a presentation method:

- A talk in front of a group
- An exhibit for use in a school, library, or community-room display case
- Video, slide show, or PowerPoint presentation
- Other _____

2. Reserve a room or display space for the event.

3. Decide how to let people know about your presentation—letter, flyers, posters, announcements.

4. Arrange to have the equipment you need (VCR, TV monitor, slide projector, computer projector, projection screen, microphone, special lighting, etc.).

Planning a GREEN Zone Presentation

You worked hard and gathered important information as you studied your local GREEN Zone. In this unit your class or group will develop a presentation about what it learned. You will then share information with members

of your community about the benefits healthy riparian zones provide. Discuss with your class or group your ideas for telling others about your work. The following activities present just a few options.





Unit 5, Activity 2 – Meet with the Pros

Present your results to a group of professional natural resource specialists. You can learn a lot by talking with people from the community whose work includes managing the GREEN Zone.

Directions

1. Plan a meeting to describe the activities of your GREEN Zone Land Management Team and the results of your investigations.
2. Decide who should be invited. Ask your teacher or leader for help. Give them an agenda for the meeting that includes the date, time, and location, as well as a list of questions you have about your riparian zone.
3. At the meeting, begin by introducing yourselves to your guests. Explain that you have been exploring a riparian zone and would like more information about what your findings mean.
4. Present what you have found. Show your site maps and the other materials you have created. Tell them about the most interesting things you learned.
5. Ask for information and feedback. See if the conclusions you gave are accurate. You might ask other questions like:
 - How do people affect the quality of our riparian zone?
 - How do you work to manage riparian zones?
 - If part of your job is working with riparian zones, what projects are you working on in the riparian zone?
 - Are there land use decisions being made that may impact my riparian zone in the future?
6. Thank your guests for sharing their time and expertise.



Zone Notes

Check what you've learned:

- If you had to describe a riparian zone to someone, what would you say?
- Why are riparian zones important places for plants, wildlife, and people?
- What else would you like to learn about riparian zones? What additional research could you do to learn more about your riparian zone?
- Look at the cover of your GREEN Zone Action Guide. Explain why you think the title of the guide is "Holding onto the GREEN Zone." What are some actions people can take to preserve riparian areas?

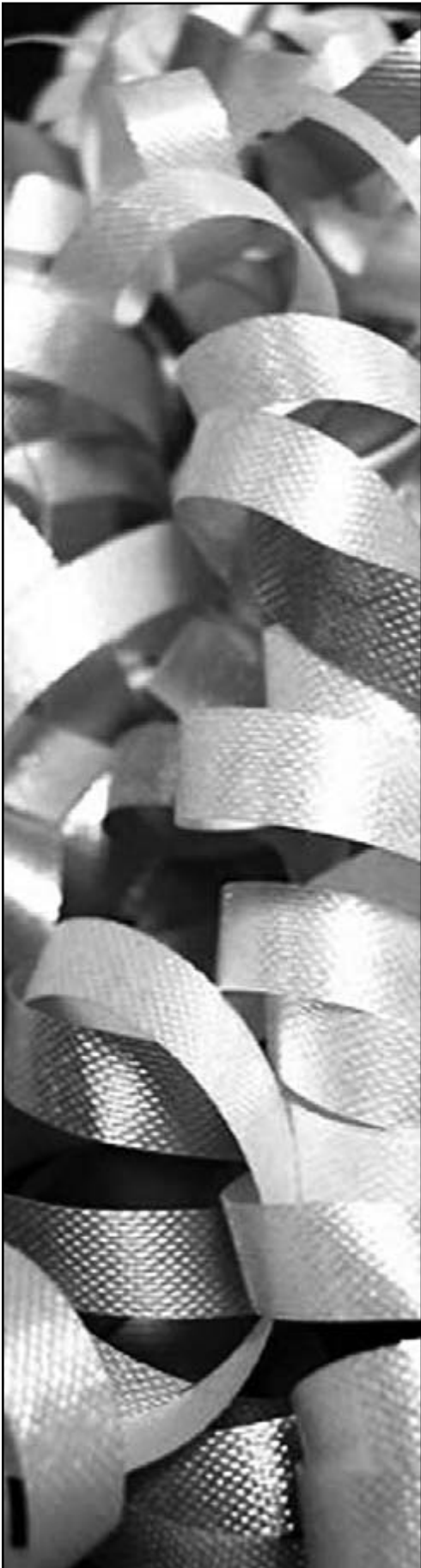

Then, CELEBRATE!

After all of your hard work collecting data and discovering riparian zones, it's nice to celebrate. Not only is celebration fun, but it's also a good way to say thank you to people who helped out.

You may want to have your celebration at your meeting with the experts. Here are some ideas for your celebration:

- Hold a pizza party or picnic.
- Make t-shirts for group members with the name of your group or riparian zone.
- Hold a fair, with displays showing what you have learned about riparian zones.
- Invite friends, family, classmates, and neighbors on a tour of your riparian zone.
- Use your imagination. It's your celebration!

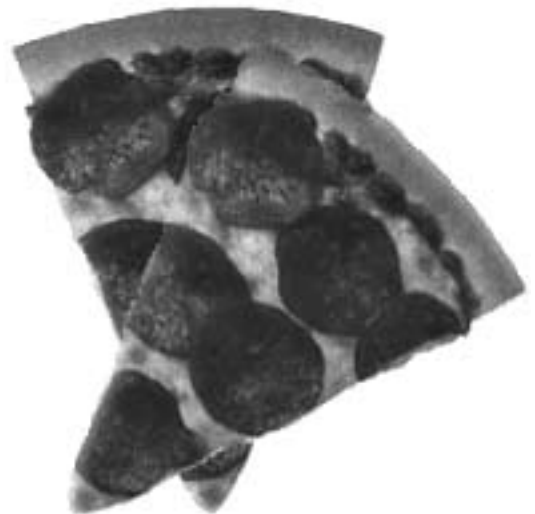

Glossary

aquatic: of or in water.

aquifer: an underground layer of sand, gravel, or permeable rock where water collects.

bankfull flow: the width of a stream when the channel is full and about to spill over onto the floodplain.

bedrock: solid rock that is underneath soil.

biodiversity: a variety or richness of life on Earth. A key part of healthy ecosystems, biodiversity refers to the number of plants or animals within a single species, the variety of the species themselves, and the variety of ecosystems. Diversity strengthens the potential of populations and species to respond or adapt to changing environmental conditions.

braided stream: stream with many stream bars (see below) surrounded by flowing water.

canopy: the parachute-shaped cover provided by shrubs and trees.

colonizers: plants that are the first to grow in bare areas where streambeds and banks have been disturbed.

community: a group of people or other living things that live in a common location. You may be a part of many communities: school, neighborhood, church.

crown: the part of a plant where the stems and roots come together.

deposition: the process that occurs when sediment (sand, clay, gravel, cobble) falls out of the water, wind, or ice that carries it. A process that builds (or deposits) soil, deposition is the opposite of erosion, a process that carries soils away.

discharge: to flow from or past. Scientists use the term to describe the flow of water from groundwater into streams, and also the volume of water that passes through a channel during a specific time period.

ecosystem: a system or area defined by a community of living organisms (animals, plants, bacteria) and their environment working together. A meadow, forest, and wetland are all different types of ecosystems.

ecotone: a natural area where two ecosystems overlap. In an ecotone there is a gradual transition from the plants and animals found in one ecosystem to the plants and animals found in the other.

erosion: the wearing away or separation of soil and rock from the land by water, wind, ice, or gravity.

floodplain: a flat area on either or both sides of a stream or river that is created by periodic flooding.

gradient: the degree to which something slopes upward or downward.

groundwater: water that collects underground in the spaces between particles of sand and gravel or in cracks in bedrock.

habitat: the place where an organism finds the food, water, shelter, and space it needs to survive.

macroinvertebrates: organisms without a backbone that can be seen with the naked eye.

meander: the “S” shape of many streams and rivers.

nonpoint source pollution: contamination that cannot be traced to a single source. Oil, gasoline, brake fluid, trash, fertilizers, pesticides, and animal waste that wash into waterways and degrade water quality are considered nonpoint source pollution.

nutrients: substances that promote growth. In a stream or other body of water, fertilizers, animal waste, or decaying leaves and grasses can be considered nutrients. When present in excess amounts, nutrients can become pollutants.

percolate: to pass through or drain through a substance, as water percolates through sandy soils.

permeable: having openings that allow liquids to pass through.

pH: the measure of the acidity and alkalinity of a solution based on a scale from 1 (most acidic) to 14 (most alkaline).

point bar: an area found on the inside of a river meander where sediment is deposited after falling out of slow-moving water.

pollutant: any substance that degrades the quality of soil, water, or air.

proper functioning condition: a term used to describe a healthy riparian zone and the way in which its component parts—especially the water, plants, soil, and landforms—work together to provide a variety of services and benefits.

recharge: to refill or replenish. Melting snow in the spring helps recharge groundwater supplies.

riffle: shallow, fast-moving water where the flow is broken by a bed of gravel, cobbles, or boulders.

runoff: water from precipitation that flows over the land surface into rivers, streams, marshes, and other water bodies.

sediment: soil, rock fragments, and other material transported and deposited by water, wind, or other forces.

stabilizers: plants with strong crowns and roots that anchor the soil along stream banks.

stream bars: islands of soil, gravel, cobbles, or boulders that form in the middle of a stream or river.

stream channel: the bed where a natural stream of water runs or may run.

surface water: water found on the surface of the Earth in lakes, streams, and rivers.

terrace: a stair-like landform that is a former floodplain of a stream.

topography: the shape of the land.

transect line: a line across an area that marks where to take samples for recording, mapping, or studying.

turbid: muddy or cloudy because of sediment, algae, or other small particles floating in the water.

upland: the higher ground in a watershed, away from the stream, river, or lake. Uplands are usually drier than riparian zones.

water table: the top of the underground area that is filled with groundwater.

watershed: the land area that drains into a stream, river, or other body of water.

wetted edge: the point at the edge of a stream where the water touches the stream bank.

