

NASA Education Recommendation Report

EDUCATION DESIGN TEAM 2011



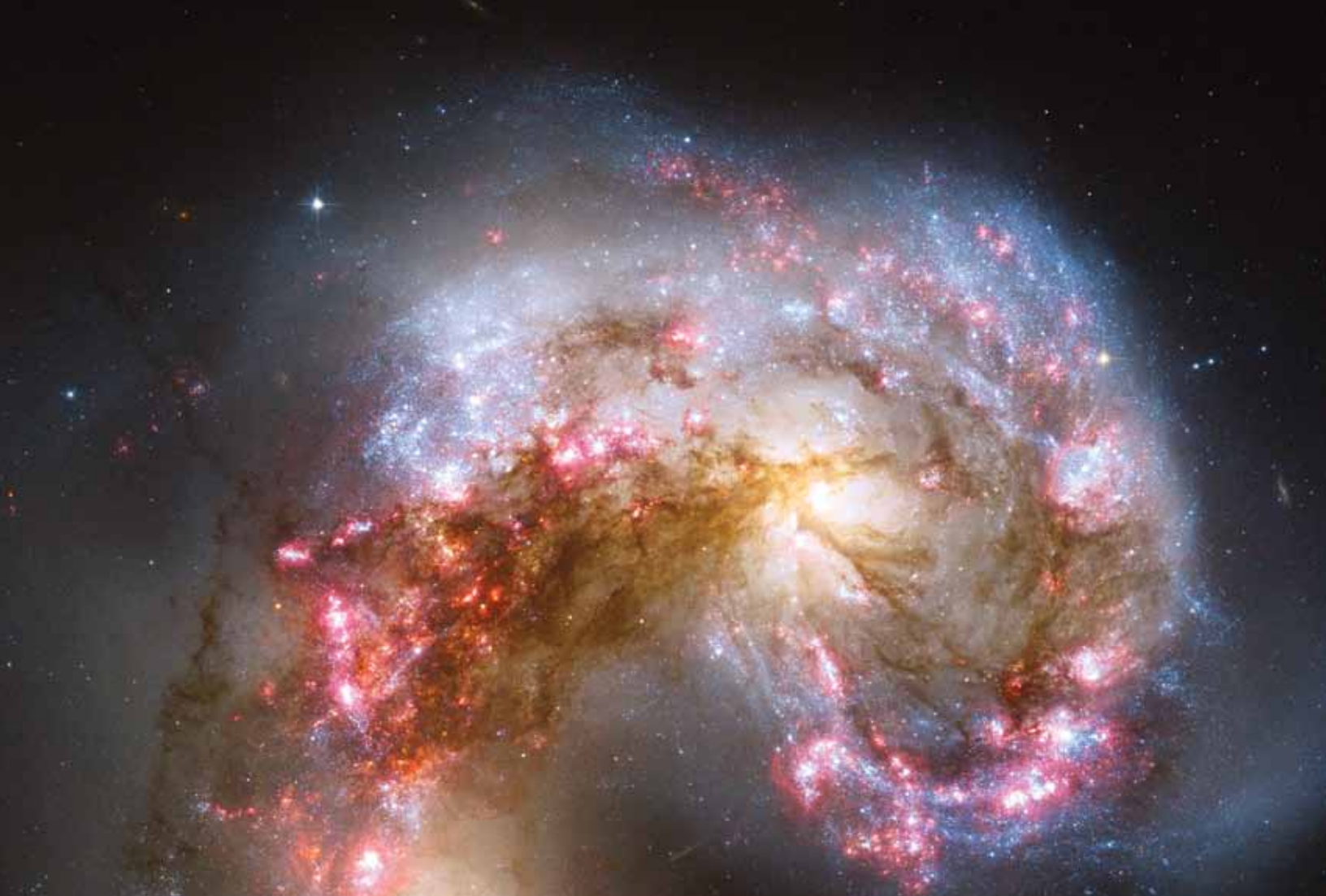

Table of Contents

INTRODUCTION	3
Executive Summary	3
Systems Design Approach	4
Information Gathered	7
Reports.....	7
Expert Testimony	8
Survey	10
Program Evaluation Data	11
Preliminary Recommendations	11
Education Design Team Outreach	11
RECOMMENDATIONS	13
SUMMARY AND NEXT STEPS	47
APPENDICES	48
Terms and Definitions	48
Reference Documents	51
Survey Questions	54
Experts Consulted	55
Education Design Team	57
Endnotes.....	58



Note: Footnotes, found at the bottom of the page, are parenthetical notes numbered using roman numerals. Endnotes, listed at the back of this report, are used for citations and references and are numbered using Arabic numerals.



“If all the interrelated components can be made consistent with the reformed element, the change is accepted, the system re-stabilizes, and a type of synergy, or effectively directed smooth functioning of the system, results. Engineers have long known that in building a bridge, supports can be placed in a number of ways, but if they are placed synergistically, the total support will be greater than the sum of each support.”

A SYSTEMS APPROACH TO EDUCATION, RONALD CROMWELL AND JOHN SCILEPPI 1995

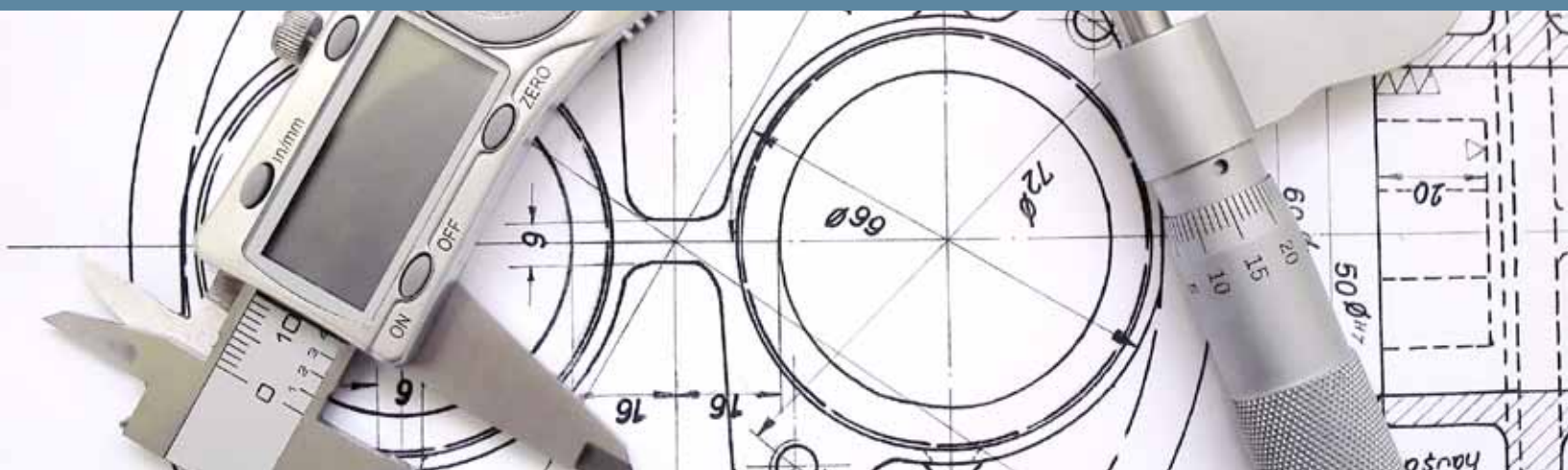

Introduction

EXECUTIVE SUMMARY

NASA people are passionate about their work. NASA's missions are exciting to learners of all ages. And since its creation in 1958, NASA's people have been passionate about sharing their inspiring discoveries, research and exploration with students and educators.

When retired Marine Corps General and astronaut Charlie Bolden first toured NASA's Centers as the new NASA Administrator, he and Deputy Administrator Lori Garver saw this passion for education in hundreds of education projects conducted across the Agency. The son of two middle school educators, Bolden is passionate about education, but was concerned by the abundance of education projects with seemingly no focused goal.

In May 2010, Bolden and Garver chartered an Education Design Team composed of 12 members chosen from the Office of Education, NASA's Mission Directoratesⁱ and Centers for their depth of knowledge and education expertise, and directed them to evaluate the Agency's programⁱⁱ in the context of current trends in education. By improving NASA's educational offerings, he was confident that the Agency can play a leading role in inspiring student interest in science, technology, engineering and mathematics (STEM) as few other organizations can. Through its unique workforce, facilities, research and innovations, NASA can expand its efforts to engage underserved and underrepresented communities in science and mathematics. Through the Agency's STEM education efforts and science and exploration missions, NASA can help the United States successfully compete, prosper and be secure in the 21st century global community.



ⁱ NASA's Mission Directorates include the Agency's new Office of the Chief Technologist (OCT), Aeronautics Research Mission Directorate (ARMD), Science Mission Directorate (SMD), and Space Operations Mission Directorate (SOMD).

ⁱⁱ For the purpose of this study, the NASA Education Program includes activities sponsored by the Office of Education and other NASA organizations.

After several months of intense effort, including meeting with education experts; reviewing Administration policies, congressional direction and education research; and seeking input from those passionate about education at NASA, the Education Design Team made six recommendations to improve the impact of NASA's Education Program:

- ▶ **Focus the NASA Education Program to improve its impact on areas of greatest national need**
- ▶ **Identify and strategically manage NASA Education partnerships**
- ▶ **Participate in National and State STEM Education policy discussions**
- ▶ **Establish a structure to allow the Office of Education, Centers and Mission Directorates to implement a strategically integrated portfolio**
- ▶ **Expand the charter of the Education Coordinating Committee to enable deliberate Education Program design**
- ▶ **Improve communication to inspire learners**

SYSTEMS DESIGN APPROACH

NASA is a systems engineering organization. Systems engineering can simply be described as an interdisciplinary approach to identify and manipulate the properties of a system as a whole, which in complex engineering projects may greatly differ from the sum of the parts' properties. NASA's Apollo program is a leading example of a systems engineering project.

External experts considering NASA's many different educational offerings advised the Agency to do what it does best: take a systems design approach to education by considering all of its education programs and how they operate together as a system to achieve a goal. To do this, those designing NASA's education program have to be deliberate and consider requirements, trades and performance outcomes.

In classic systems engineering, a mission design team starts by considering the environment, requirements and constraints and then performs a requirements analysis. As they do this, they are informed by risk analysis, trade studies and performance measures. A

The Education Design Team consists of:

- ▷ Two co-chairs
- ▷ 12 selected members from across the NASA Office of Education, Mission Directorates, and Centers
- ▷ 46 years of combined in-classroom teaching experience
- ▷ 145 years of combined K-12 program experience
- ▷ 92 years of combined program evaluation, metrics and research experience

top level system design is then broken into various subsystems, with requirements to be met allocated to specific system levels and with defined interfaces. Designers often consider many different system trades, evaluating overall system performance against various combinations of subsystem characteristics (e.g., subsystem performance, mass, power requirements, etc.) until they feel they have reached an optimum solution to meet the requirements, given the constraints. The result of this deliberate design process includes a system configuration, specifications and a baseline plan.

NASA Education is comprised of numerous components across the Agency. NASA's Centers, Mission Directorates, and the Office of Education are the primary organizations encompassing the Agency's education community. The community also includes all NASA staff that help educate the public on the Agency's missions and scientific and technological advances.

The organizations are each responsible for a part of the NASA Education portfolio, and make a specific contribution to the broader NASA Education mission. Historically, the organizations of NASA's education community have operated with relative autonomy. While each individual component has been successful in its ability to align its efforts to overall Agency strategic goals, produce high-quality products and engage the public through both formal and informal education activities, the efficiencies and synergies that could increase the activities' impact on STEM education in the United States remain largely

unrealized. To see how the impact of NASA's education program could be improved, the Education Design Team decided to take a systems approach.

The Team identified top-level education requirements set by the highest level of government, the Office of the President. Education is a top priority of President Barack Obama. His National Security Policy directs the government to improve education at all levels and invest in STEM education. In his 2011 State of the Union Address, the President stated that, "Over the next ten years, nearly half of all new jobs will require education that goes beyond a high school education. And yet, as many as a quarter of our students aren't even finishing high school. The quality of our math and science education lags behind many other nations. America has fallen to ninth in the proportion of young people with a college degree. And so the question is whether all of us — as citizens, and as parents — are willing to do what's necessary to give every child a chance to succeed." In 2009, the President launched an Educate to Innovate campaign to improve the participation and performance of students in STEM disciplines. This campaign extends beyond the federal government to include the efforts of leading

The White House has undertaken a number of public-private partnerships and initiatives to advance STEM education, including NASA's Summer of Innovation. The President sponsored an Astronomy Night in October 2009 on the White House lawn and encouraged 200,000 federal scientists and engineers to get involved in STEM education on National Lab Day.

In 2009, the Administration established Race to the Top, a \$4.35 billion competitive grant program designed to encourage and reward states that are creating the conditions for education innovation and reform. In 2010, this Recovery Act initiative was incorporated into the Administration's education blueprint, the Elementary and Secondary Education Act, asking states to adopt college- and career-ready standards and reward schools for producing dramatic gains in student achievement.

The Education Design Team took these top priority policies and initiatives as top-level requirements, and next examined guidance from the Department of Education. Michael Lach, Special Assistant for Science, Technology, Engineering, and Mathematics

White House sponsored initiatives advancing STEM education:

- ▷ Intel Science and Math Teachers Initiative
- ▷ Expansion of the National Math and Science Initiatives UTeach Program
- ▷ Public University Presidents Commit to Train 10,000 Math and Science Educators annually by 2015
- ▷ Woodrow Wilson Teaching Fellowships in Math and Science
- ▷ Department of Education's Teacher Initiatives
- ▷ NASA's Summer of Innovation



corporations, foundations, non-profit organizations and science and engineering societies focused on helping students across the country to excel in science and math.

Education, painted a fairly grim STEM student performance picture when he met with NASA's Education Coordinating Committeeⁱⁱⁱ and the Education Design Team. He summarized data from the Trends in International Mathematics and Science Study,^{iv} the Program for International Student Assessment,^v and

ⁱⁱⁱ NASA's Education Coordinating Committee consists of representatives of the Office of Education, Mission Directorates, Mission Support Offices, and the Center Education Offices. The Committee is a collaborative body that supports NASA's education strategy by coordinating education efforts across the Agency.

^{iv} International assessment of mathematics and science knowledge of fourth- and eighth-grade students around the world.

^v Worldwide assessment of 15-year old students' scholastic performance.

TABLE 1: STEM Education Data

Trends in International Mathematics and Science Study (mathematics and science content) ¹	In this international comparison, the U.S. is in the middle of the pack. (Average U.S. eighth grade mathematics scores are higher than 27 of 47 countries in 2007.)
	U.S. performance in mathematics is increasing over time. Science performance is flat.
Program for International Student Assessment (mathematics and science content and application) ²	On average, U.S. students scored lower than the Organisation for Economic Co-operation and Development ^{vii} average on the mathematics literacy scale (487 vs. 496) in 2009. In science, the U.S. is in the middle of the pack.
	Performance is flat over time.
National Assessment of Education Progress (mathematics and science content) ³	Few students are proficient in mathematics or science (32 percent of eighth graders were proficient in mathematics in 2009.)
	Mathematics scores are generally increasing over time.
	Science scores are flat over time.

the National Assessment of Education Progress,^{vi} represented in Table 1.

Lach articulated the severity of the STEM education challenge facing the country. In the example he presented, of 4 million ninth graders, only 4 percent earn STEM bachelor’s degrees and most students are not proficient in STEM at the end of high school.⁴ As part of the Department of Education’s overall STEM strategy, Lach encouraged the Agency to support STEM education in two specific areas:

- ▶ Motivating and inspiring students by creating instructional materials focused on interesting and exciting content, connecting educators and students to scientists and engineers
- ▶ Enhancing the capacity of educators, leaders and schools by encouraging the development of state-driven college- and career-ready science standards

Lach also urged the Team to consider the relative size of NASA’s investment in education, which is only 5 percent of the total federal investment in STEM, as illustrated in Figure 1, and the need to focus that investment for maximum benefit. A total of \$3.6 billion was spent on STEM education programs in the FY 2009 federal budget.

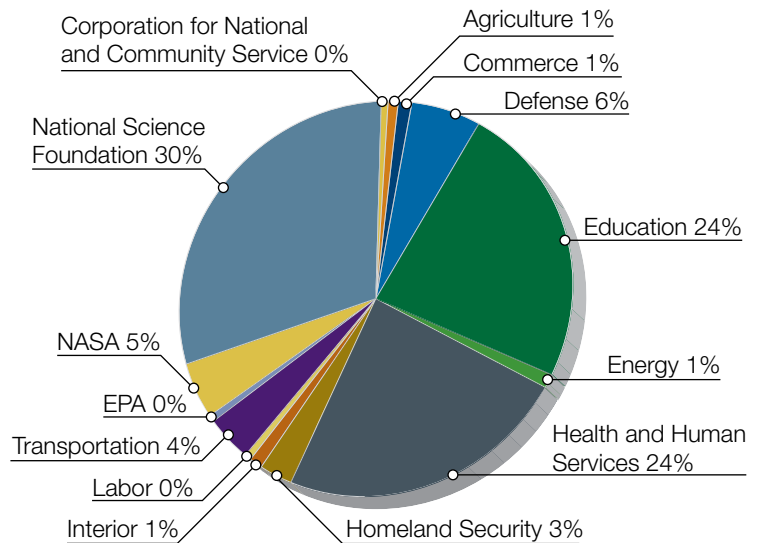

FIGURE 1: 2009 Percentage Of Federal STEM Funding By Department Or Agency

Source: Executive Office of the President, Office of Science and Technology Policy, *Preparing Our Children for the 21st Century Economy: Science, Technology, Engineering, and Mathematics Education in the 2010 Budget (May 2009)*

Due to rounding, percentages less than 1 are shown as 0 percent.

^{vi} National Center for Education statistics conducts a periodic assessment of U.S. student progress in subjects including mathematics, reading, writing, science and more. Results are released as “The Nation’s Report Card.”

^{vii} Organisation for Economic Co-operation and Development’s mission is to promote policies that will improve the economic and social well-being of people around the world.

The Team then considered the Agency's 2011 strategic goals and outcomes for education and outreach, and the Administrator's public speeches and statements:

- ▶ **Strategic Goal:** Enable program and institutional capabilities to conduct NASA's aeronautics and space activities
 - ▶ *Outcome:* Identify, cultivate and sustain a diverse workforce and inclusive work environment that is needed to conduct NASA missions
- ▶ **Strategic Goal:** Share NASA with the public, educators and students to provide opportunities to participate in our mission, foster innovation and contribute to a strong national economy
 - ▶ *Outcome:* Improve retention of students in STEM disciplines by providing opportunities and activities along the full length of the education pipeline
 - ▶ *Outcome:* Promote STEM literacy through strategic partnerships with formal and informal organizations
 - ▶ *Outcome:* Engage the public in NASA's missions by providing new pathways for participation
 - ▶ *Outcome:* Inform, engage and inspire the public by sharing NASA's missions, challenges and results

In less than a year, Administrator Bolden gave 20 speeches and congressional testimony on STEM education,^{viii} from which the Team derived an additional set of requirements. Administrator Bolden charged NASA to:

- ▶ Inspire students to study mathematics and science and pursue careers in aerospace-related fields
- ▶ Capture student interest in middle school before students have closed their minds to fields of study that would enable them to pursue a STEM career
- ▶ Reach out to educators and help them teach STEM subjects effectively
- ▶ Strive to include underrepresented and underserved communities in NASA's Education Program
- ▶ Partner with non-profit organizations, industry and community groups

In every speech at his countless public appearances in support of education, Administrator Bolden stressed the need to inspire today's youth and help educators better teach STEM subjects. He further directed NASA to clarify its education goals and determine the effectiveness of its program when measured against these goals; partner with others in the government and in the private sector; and take risks to pursue innovations in education that will have a maximum impact on STEM excellence as well as provide equity for underserved students and communities.

Having identified the system requirements, the Education Design Team then gathered additional information to consider in designing an Education Program for optimal impact.

INFORMATION GATHERED

REPORTS^{ix}

The Education Design Team reviewed current STEM literature describing the challenges facing the nation, perhaps best characterized by Norman Augustine, retired Chairman and Chief Executive Officer of the Lockheed Martin Corporation and Chair of The National Academies Committee on Prospering in the Global Economy of the 21st Century. The Committee's report, *Rising Above the Gathering Storm: Energizing and Employing America for a Brighter Economic Future*, concludes that the country's future competitiveness and standard of living are being increasingly and seriously challenged in the global marketplace, and future prosperity depends in large part on the quality of jobs that Americans are able to hold.⁵

While many of the Committee's recommendations focused on the country's commitment to research, making the U.S. attractive to the world's top talent, changing laws to enable those graduates to remain in the U.S., and enabling innovation, a primary recommendation dealt with education. The Committee charged the nation with increasing America's talent pool by vastly improving K-12 science and mathematics education.

^{viii} Reference Appendix B Section 3 for a list of the Administrator's speeches.

^{ix} Reference Appendix B Section 2 for a comprehensive list of reports and legislation reviewed by the Team.

The Team also reviewed additional national education reports and policy statements for guidance, including *Elementary and Secondary Education Program: Review and Critique*,⁶ *Rising Above the Gathering Storm Two Years Later: Accelerating Progress Toward a Brighter Economic Future*,⁷ *Rising Above the Gathering Storm, Revisited: Rapidly Approaching Category Five*,⁸ *Learning Science in Informal Environments*, and *Disrupting Class: How Disruptive Innovation Will Change the Way the World Learns*.⁹ In particular, the Team reviewed the report of the President's Council of Advisors on Science and Technology (October 2010), *Prepare and Inspire: K-12 Education in Science, Technology, Engineering, and Math (STEM) for America's Future*.¹⁰

From this literature review, the Team identified the following critical needs:

- ▶ Improve K-12 STEM education
- ▶ Prepare and inspire all students in STEM through learning opportunities inside and outside the classroom
- ▶ Provide access to exciting individual experiences and to STEM education opportunities inside and outside of schools through collaborations in discovery and invention and by connecting what students learn in school with what they do outside of school
- ▶ Make a deep and sustained commitment to innovation and research-driven decision making in K-12 education

The Team also reviewed the reports documenting several recent internal and external reviews of NASA's Education Program and relevant legislation, including:

- ▶ NASA Engagement in STEM Education: Innovation in Education for Sustainable Achievement (Teaching Institute for Excellence in STEM), 2009¹¹
- ▶ A Review of the NASA Education Program: Education Team Report, 2005¹²
- ▶ NASA's Elementary and Secondary Education Program Review and Critique, 2008¹³
- ▶ America COMPETES Act of 2007 (H.R. 2272, Title II – Creating Opportunities to Meaningfully Promote Excellence in Technology, Education, and Science)¹⁴

- ▶ The National Aeronautics and Space Administration Authorization Act of 2010, H.R. 3729¹⁵
- ▶ Memorandum for the Record: Markup of the NASA 2011 Authorization bill, Executive session of the Senate, Commerce, Science, and Transportation Committee, H.R. 5781¹⁶
- ▶ House Armed Services Committee Report Language on Basic Research, STEM Education, STEM Workforce, H.R. 5136¹⁷

EXPERT TESTIMONY

More than 40 education experts — leaders in education, policy makers, NASA education project managers, researchers, and individuals and groups engaged in STEM education reform — met with the Team and provided a broad range of perspectives on the challenges facing STEM education. The Team also sought input from additional experts including Jan Morrison and Norman Augustine, who authored some of the reports the Team reviewed.

The meetings with Mr. Augustine and Ms. Morrison were excellent sources of information because they allowed these experts to provide additional context around their reports and update the Team on changes in STEM education since their release. The timing of the Team's interview with Mr. Augustine coincided with the release of his update to *Rising Above the Gathering Storm* and his testimony before Congress, enabling him to provide his most current thinking on how NASA can leverage its strengths to address national STEM education needs.

Experts Dr. Antoinette Mitchell, Associate Dean of Trinity Washington University,^x and Zipporah Miller of the National Science Teachers Association, provided unique perspectives on how best to ensure that there are enough educators who are well qualified and prepared to teach STEM subjects. Both experts come from institutions that are deeply committed to STEM education reform. They encouraged the Agency to use its unique and inspiring content to advance STEM education.

Dr. Anita Krishnamurthi, Director for STEM policy at the Afterschool Alliance, and Rita Carl, Director of Education at the Challenger Centers, described the unique opportunities informal settings present for

^xThe Trinity Washington University School of Education, located in Washington, DC, offers advanced degrees in Counseling, Educational Administration, a Master of Arts in Teaching, and a Master of Education, as well as in-service and pre-service educator training and professional development.

STEM education. Both experts stressed the importance of making inspiring and current content readily available in appropriate forms and establishing partnerships between NASA and informal STEM education organizations wherever possible.

Other expert discussions enabled the Team to clearly understand the challenges facing educators in the classroom. Kristen Edwards, a fellow in the Albert Einstein Distinguished Educator Fellowship Program and former Teach for America science educator, described the challenges facing STEM students in rural Arkansas. Currently assigned to the NASA Office of Education to bring an educator's perspective to NASA's Education Program, Ms. Edwards underscored the inspirational value of NASA's mission, the need for systemic STEM education reform and the great potential for informal science environments to open the minds of students who may have few role models working in STEM fields. Dr. Allison Powell, of the International Association for K-12 Online Learning, explained how existing and emerging technologies can benefit both educators and students. Dr. Stephanie Shipman, of the Government Accountability Office, stressed the importance of having appropriate methods for project evaluation and the need to be inclusive, disseminate results across the education community and establish a program in which all projects are periodically evaluated.

Dr. Carl Wieman, Associate Director of the Office of Science and Technology Policy, discussed the need to develop focused pilot efforts that can be thoroughly evaluated before being taken to scale. He encouraged NASA to continue to develop strong ties with local communities near NASA's Centers and use them as test beds for NASA innovations in STEM support. Kumar Garg, policy analyst with the Office of Science and Technology Policy, elaborated on current Administration STEM policy and the various ways in which NASA could significantly improve its program. Mr. Garg echoed the President's sentiment that STEM

EXPERT SPOTLIGHT: Kristen Edwards, an Einstein Fellow, shared her experiences as a former Teach for America educator with the Team.

Ms. Edwards joined Teach for America in 2000 and was assigned to the Mississippi Delta region. She spent nine years teaching science at Lee High School in Marianna, Arkansas, first as the science laboratory coordinator (designing and implementing hands-on laboratory activities for every science class in the school), and then as a biology, pre-advanced placement biology, advanced placement biology, and human anatomy and physiology instructor. She also coached, co-coached and sponsored numerous activities, including National Honor Society, National Beta Club, Quiz Bowl and Trojans Against Destructive Decisions (the school's Safe and Drug-Free Schools club). Ms. Edwards also taught in her school's extended-day recovery and remediation and summer school programs.

education reform is an effort that requires a coordinated and collective effort in which NASA can play a unique role. He also discussed the value of well-structured and supported volunteerism and how NASA's greatest resource – its passionate people – can help bring NASA's content to formal and informal education settings.

Some experts echoed the advice given to NASA in several external studies, producing the following recommendations:

- ▶ Leverage NASA's unique content to inspire students and open the door to STEM learning
- ▶ Establish a coherent overall plan for education program evaluation
- ▶ Partner with curriculum developers, ensuring materials address standards
- ▶ Provide hands-on learning experiences to inspire the next generation of scientists and explorers, and build on the best practices of student-educator collaborators
- ▶ Focus on educators and help them gain the confidence to teach science and math
- ▶ Maintain close links between NASA's Education Programs and the Agency's recruiting and hiring activities

- ▶ Maintain or increase the Agency's commitment to underrepresented and underserved students and educators
- ▶ Support the Minority University Research and Education Program (MUREP) and strive to increase the number of underrepresented students pursuing STEM careers
- ▶ Use technology to increase program impact and provide educator professional development online
- ▶ Seek educator input on the usefulness of NASA's materials and programs
- ▶ Streamline and simplify NASA's wealth of education opportunities, making content and professional development opportunities easier to find

Other experts gave the Education Design Team new ideas to consider:

- ▶ Use the power of the NASA brand to support STEM education reform
- ▶ Design programs that are flexible enough to survive constant shifting budget profiles (based on the history of the NASA Office of Education budget and congressionally directed spending)
- ▶ Encourage innovation by lowering bureaucratic barriers
- ▶ Partner strategically, partner with innovators and establish partnerships that can provide impact data
- ▶ Partner educators with mentors and track their progress
- ▶ NASA's content aligns well with the professional development needs of middle school educators. Help them understand the science, engineering and math behind NASA content so that they can better inspire and engage students at the age when they're starting to make decisions that will impact their future career direction
- ▶ Explore and build on the best practices of the NASA-NOAA collaboration
- ▶ Systemic STEM reform will take many elements of society working together; NASA should support systemic STEM education reform
- ▶ NASA should focus on content that helps change practices and not just provide information

- ▶ Consider programs that cut across Mission Directorate efforts and use existing infrastructure whenever possible
- ▶ Partner with communications, outreach is essential to inspire students
- ▶ Consider longer duration evaluation to measure the impact of higher education programs
- ▶ Consider the degree to which it is possible to incorporate the efforts of the Space Grant consortia in NASA's program; take advantage of the reach of the Space Grant network and involve directors in developing NASA's innovative programs
- ▶ Evaluate the current portfolio against new goals and be prepared to end programs that no longer fit

Through some 40 meetings and discussions, the Team gained valuable perspective on successful solutions to STEM education challenges and gained insight into different stakeholder groups and their specific needs, including those of underserved and underrepresented students. These discussions were critical to understanding the nation's STEM education needs and how NASA can best address those needs.

SURVEY^{xi}

To ensure the Education Design Team's recommendations were grounded in practice, the Team conducted an online survey to capture information from a wide spectrum of the NASA education community.

The 16-question survey was distributed to 283 recipients in the NASA education community as identified by members of the Education Coordinating Committee, including both civil servants and contractors. The Team received 132 responses, a 47 percent response rate. The survey included a combination of rank order and open-ended essay questions to gather quantitative as well as qualitative feedback. The questions were formulated to solicit responses that:

- ▶ Capture respondents' perspectives on the current state of the NASA Education program
- ▶ Are measurable and quantitative in nature
- ▶ Provide demographic data about the respondents

^{xi} See Appendix C for the Education Design Team Survey Questions.

Some demographic highlights from the survey showed respondents:

- ▶ Had a wide range of NASA education experiences
- ▶ Were comprised of 60 percent NASA civil servants, 33 percent contractors, and 7 percent other
- ▶ Are highly knowledgeable about the NASA education portfolio

SURVEY HIGHLIGHTS: The NASA education community relied on its diverse and collectively extensive education experience when answering the Team's survey questions.

- ▷ Nearly 85 percent agree that NASA's education projects align with the Agency's goals to strengthen NASA's and the nation's workforce, attract and retain students in STEM disciplines and/or engage Americans in NASA's mission
- ▷ When asked what types of programs are most critical to achieving Education goals, 77 percent responded teacher training
- ▷ Nearly 84 percent agree that NASA should partner in systematic education reform

PROGRAM EVALUATION DATA

NASA Education project managers and education and public outreach leads have been collecting performance metrics and evaluation data on the effectiveness of their projects and the stakeholders they serve for the past nine years. Over the past two years, project managers have begun using the Office of Education Performance Measurement system to collect data; prior to that, they used the NASA Education Evaluation Information System, Consortium Management Information System, and the Performance Outcome Student Tracking System. While the Team reviewed this growing body of data, the evaluations were not conducted in ways that would enable the effectiveness of one project to be compared to that of another, and the current portfolio lacked the deliberate design to enable it to be

evaluated as a whole. For this reason, Team members relied on the views expressed by external education experts and the education community to identify where NASA can have the most impact on national STEM education.

PRELIMINARY RECOMMENDATIONS

The Team took the broadest Administration initiatives as top level requirements and linked them to lower level requirements as represented in the direction given to NASA by the Administration, Congress, education experts and the NASA Administrator. The Team then developed a set of preliminary recommendations that address these defined requirements, considered how hard or easy they would be to implement and identified new elements that might need to be added to NASA's education portfolio. Because an in-depth portfolio review to examine how each project in the Agency's current portfolio would address new program goals will take several months to complete, the Team noted implementation challenges and took steps to obtain feedback on the preliminary recommendations. The Team sought NASA's approval on final recommendations before charging the Education Coordinating Committee with the responsibility to commission an intensive portfolio review, supported by the Office of Education.

EDUCATION DESIGN TEAM OUTREACH

In a final data gathering effort, the Team conducted an outreach effort to gauge the NASA education community's perception of, and identify opportunities to improve, the Team's preliminary recommendations. Team members served as liaisons for this effort, providing the community with a copy of the preliminary recommendations and some background information on the Team's findings. Individuals across the community, as well as several experts external to the Agency, provided feedback on the recommendations. This enabled the Team to review how the education community as a whole viewed the recommendations and where they identified common issues. Finally, the Team spoke with, and received input from, every NASA Center Director and Mission Directorate Associate Administrator whose office would be impacted by the implementation of these recommendations.



“Over the next 10 years, nearly half of all new jobs will require education that goes beyond a high school education. And yet, as many as a quarter of our students aren’t even finishing high school. The quality of our math and science education lags behind many other nations. America has fallen to ninth in the proportion of young people with a college degree. And so the question is whether all of us—as citizens, and as parents—are willing to do what’s necessary to give every child a chance to succeed.”

PRESIDENT OF THE UNITED STATES BARACK OBAMA, 2011 STATE OF THE UNION ADDRESS



Recommendations

1 Focus the NASA Education Program to improve its impact on areas of greatest national need

In response to the Administrator’s direction to improve NASA’s Education Program to make the greatest possible impact on STEM education, the Education Design Team recommends that the Agency create a more tightly focused Education Program. Education experts, policy makers, and NASA Education employees (as expressed through responses to the Team survey) provided input that fully supports the program’s need for focus.

In the past, NASA strove to create its own unique education pipeline: inspiring, engaging, educating and then employing students as members of the aerospace workforce after graduation. As a result, the current portfolio is very diverse and serves many stakeholders. Currently, many of the Agency’s K-12 projects are small, operate in relative isolation and cannot be effectively scaled to reach larger numbers of participants.

Throughout the Education Design Team’s deliberations, members asked experts, “How can NASA Education make the biggest impact in STEM education?” Of those who responded, most encouraged NASA to focus its K-12 efforts on middle school, and, for best leverage, to focus on middle school educator professional development.

Before having to decide which courses to take in high school, students are already making up their minds about math and science. This makes it difficult to get on a track to take foundational courses that would enable students to pursue a degree and a career in a STEM field.

Experts described middle school as a time when students begin to ask questions, form opinions, and make decisions such as:

“Why do I need to study math?”

“What am I going to do with science?”

“Math is boring.”

“Science is hard.”

“I don’t see people like me doing math.”

“I don’t like science.”

“I’m not good at math.”



Based on the personal experiences of education experts managing STEM projects, these experts recommended to the Team that NASA can have the biggest impact on students by focusing its efforts on helping STEM educators improve their content knowledge. As educators become more confident in their mastery of science and engineering topics, they are able to use NASA's exciting content to inspire students. Additionally, the Education Design Team's survey helped gauge the NASA education community's position on how best to focus the portfolio. The respondents, when asked to prioritize NASA's efforts on students and educators, agreed in both cases that the focus should be on middle school (see Figure 2).

NASA's higher education efforts, particularly internships, are beginning to be aligned to Agency goals through the One Stop Shopping Initiative,¹⁸ a single portal to all NASA internships, but an overarching Agency strategy is still absent. Each funding organization's programs address the undergraduate and graduate needs of their organization, rather than contributing to overarching Agency education goals.

While projects in the overall portfolio are well aligned with current Agency goals, education activities are still largely developed within individual funding organizations. Many projects are limited to serving their current stakeholders and can only increase their impact by adding people (civil servants or contractor support) and resources. The Agency does not have a strategy for offering education projects that have proven to be highly effective to partners willing to make long-term investments to grow and sustain them. Such a strategy would allow NASA to focus some of its limited resources on small, innovative pilot projects.

The intent of this recommendation is to ensure that the portfolio is structured to make the greatest impact possible given NASA's limited education resources, even if it means that some products and services NASA Education provides to students and educators today may not be available in the future. As illustrated in Figure 3, NASA's education portfolio covers a broad spectrum of audiences. However, NASA's limited resources can have a much greater impact if focused, and the Agency partners strategically to leverage its resources with the education community.

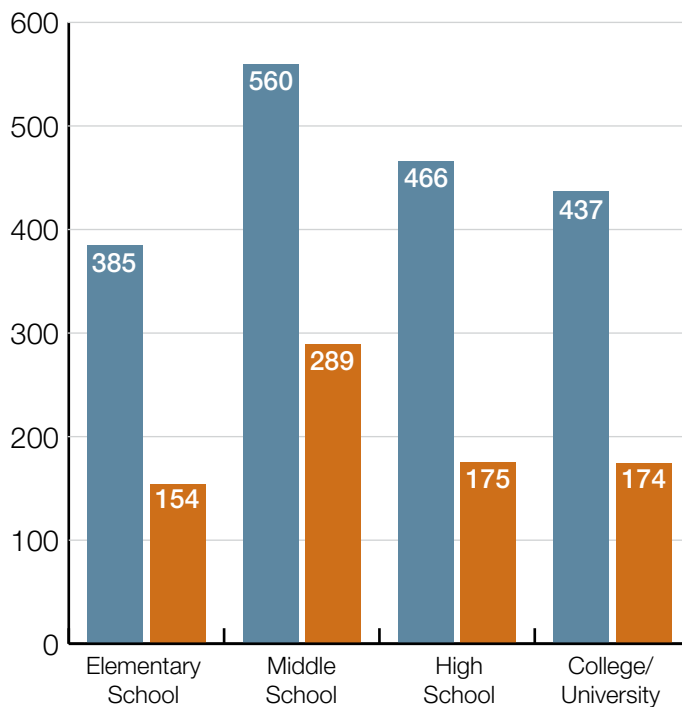

FIGURE 2: Education design survey ranking of priority of education programs designed for Students and Educators.

The data was analyzed using the Borda Count Method whereby each first priority vote received a point score equal to the number of options. In this instance, four points were awarded for each first place vote; second priority votes received three points, and so on.



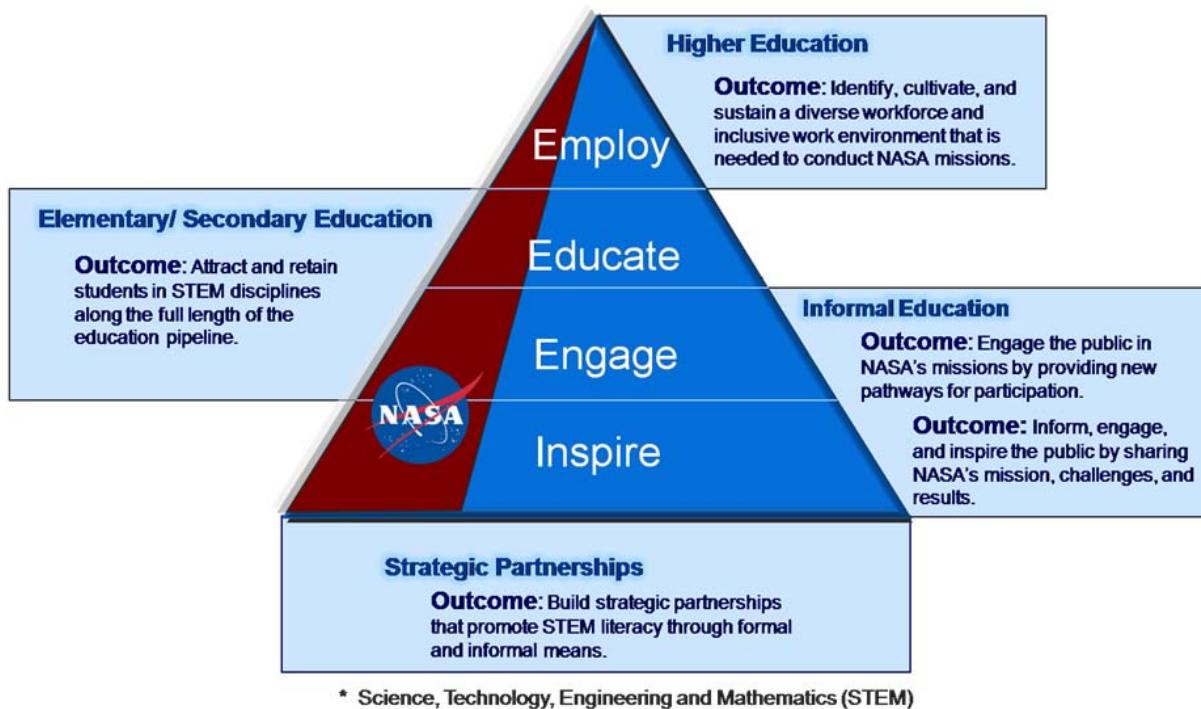

FIGURE 3: NASA Education Framework

In the past, NASA Education has attempted to address the entire STEM education spectrum. This graphic shows how NASA's education portfolio will be more tightly focused going forward. To ensure the entire spectrum is addressed, NASA will look to partner with organizations who can support the blue section. The red portion represents the area of the STEM education spectrum in which NASA's education efforts will be focused.

Refocusing the Agency's education portfolio is a significant undertaking that will require thoughtful planning and flexibility to adapt when unintended consequences are discovered. To ensure effective implementation of this recommendation, the Education Design Team recommends that the Associate Administrator for Education direct the Education Coordinating Committee to commission an independent portfolio review to be conducted by an external evaluator. As part of the review, project managers should be required to document the obstacles and risks implementing the newly focused program presents for each Center and Mission Directorate. The review will identify those projects within the portfolio that are not aligned to the new program goals and should be considered for restructuring, transition to a qualified partner or phased out.

Implementing this recommendation cannot, and will not, happen overnight. For many of the Agency's current educational offerings, NASA has developed long-term, mutually beneficial relationships with stakeholders that need to be carefully considered. As NASA focuses its Education Program, it will increasingly rely on strategic partners who share

similar goals to address topics, content and stakeholders that NASA can no longer directly support. The implementation of the recommendation should be deliberate, not sudden or disruptive.

RECOMMENDED ACTIONS

1.1. NASA K-12 education programs should be focused to address the professional training and development of educators working with middle-school age students. Through pre-service and in-service STEM educator training, the Agency will support building STEM competencies and enable educators to inspire students at a critical time in their education when they are making choices that will affect their ability to pursue STEM careers. NASA should have a single unifying strategy for this effort that guides the investments of the Office of Education, Centers and Mission Directorates. This focus will help NASA Education make a greater impact addressing national STEM educational needs and priorities.

Focusing the Agency's programs will enable NASA to redirect investments to innovative pilot programs, and allow the Agency to

develop fewer, but larger projects with greater scale and impact. As part of the portfolio review, projects that can be transitioned to strategic partners for future implementation should be identified, and special emphasis placed on programs that will increase interest in STEM disciplines by members of underserved/underrepresented communities.

- 1.1.1. *NASA should conduct programs to support educator professional development in partnership with nationally respected stakeholders and content providers in a systematic way, to have the greatest impact.*
- 1.1.2. *NASA should use proven and emerging collaborative technologies to scale and increase educator development and certification programs.*
- 1.1.3. *NASA should partner with professional development organizations to impact greater numbers of educators than can be reached through development offered on a school-by-school basis.*
- 1.1.4. *NASA should only fund direct service to K-12 students when unique Agency assets and facilities are involved and no other partner can deliver a comparable experience.*
- 1.1.5. *Mission Directorates now providing curriculum support materials should focus future efforts on developing high quality, inquiry-based materials for use by educators working with middle school-aged students.*

NASA should conduct efforts to support educator professional development in partnership with recognized experts and content providers in a systematic way to have the greatest impact. Rather than individually scheduled workshops and attempts to support middle school educators one school at a time, NASA needs to develop a scalable program that can be implemented at district or state levels. Collaborations with colleges of education will allow

the Agency to assist with the development of pre-service educators on a much larger scale than currently possible. Increased reliance on digital learning networks is critical for the Agency to implement a program on a national scale.

The intended outcomes of focusing on educator professional development at the middle school level are:

- ▶ Improving STEM literacy and inspiring more students through educators than could be reached through direct student involvement
- ▶ Contributing to the creation of a more competent educator workforce capable of inspiring and educating students in STEM disciplines
- ▶ Concentrating NASA's efforts in ways to enable a clear demonstration of NASA's impact on STEM education

The Agency should continue to have a role in direct service programs for students in situations where unique Agency assets and facilities are required and no other partner can deliver a comparable experience. For example, internships at NASA facilities, interacting with hardware and astronauts on board the International Space Station or pointing spacecraft cameras at the surface of Mars are all uniquely enabled by NASA.

Mission Directorates currently providing curriculum support materials should focus future efforts on continuing to develop high-quality, inquiry-based materials for use by educators working with middle school-aged students. Aligning both education projects and curriculum support materials to the same stakeholder creates a synergy within NASA education. Those developing curriculum support materials will have projects through which their material can be distributed, and those managing projects will have a clear source of proven, peer-reviewed support materials. While the Mission Directorates focus on developing content, the education offices can focus on identifying the appropriate stakeholders, partnerships and training opportunities to fully use that content.

1.2. The Office of Education should refocus its high school and higher education offerings on providing experiential opportunities (e.g., hands-on activities, hardware design and data analysis), internships and scholarships for students. A significant portion of the NASA Office of Education's commitment to higher education should be addressed through its management of the National Space Grant College and Fellowship Program. While refocusing higher-education, NASA Education must sustain its commitment to underserved and underrepresented communities.

1.2.1. *Mission Directorates should maintain their commitment to provide graduate and faculty fellowship opportunities as part of their education programs.*

1.2.2. *The Office of Education should develop the next Space Grant request-for-proposals in alignment with the Agency's new education goals. To accelerate alignment of Space Grant with the new priorities, the Office of Education and Office of Procurement should consider the Agency's option to advance the next competition in order to insert newly defined requirements into Space Grant agreements.*



Education statistics illustrate that the shortage of pre-service educators continues despite a growing U.S. student population.

In the United States in the early 1970s and 1980s, public school enrollment was on the decline as the number of teachers was increasing. The trend has since reversed where only 103,000 Bachelor degrees in Education were conferred in 2008, a 3 percent decline from 1998.

By 2015, there will be 52.346 million K-12 students in public school and 3.53 million public school educators in the United States.

According to the estimates, the nation will need to hire 435,000 educators per year to keep up with the need.

While it may be feasible for NASA to impact a portion of pre-service educators, it is not feasible for NASA to reach all K-12 students and educators.

Source: National Center for Education Statistics

NASA has research and development needs that can only be met by a highly qualified and educated workforce. Higher education efforts have always contributed to preparing students for careers in the nation's aerospace industry, but without an Agency-wide approach to higher education that leverages the inherent strengths of each Agency organization, the program may not be as effective as possible. The Education Design Team's recommendation for higher education employs a strategy that refocuses the Office of Education's efforts to simultaneously address both NASA and national needs, and seeks to collaborate with the higher education community, other government agencies and NASA Mission Directorates to ensure there are increased opportunities for undergraduate and graduate students.

Mission Directorates should maintain their commitment to providing content to improve the teaching of undergraduate and graduate students. They should also provide graduate and faculty fellowship opportunities, especially because this

creates closer ties between those needing research experience and those seeking assistance in conducting research. The Office of Education's new focus will provide more opportunities for undergraduate students to compete for and obtain scholarships, engage in experiential activities or gain real-world experience through a NASA internship. Additionally, internships and hands-on opportunities for high-school students will continue through projects such as INSPIRE.

Interdisciplinary National Science Project Incorporating Research and Education Experience (INSPIRE)

INSPIRE is a multi-tier year-round program designed for students in ninth to 12th grade who are interested in STEM education and careers. Through the INSPIRE Online Learning Community, the centerpiece of the INSPIRE Project, students from across the nation have the opportunity to interact with their peers, NASA experts, and education specialists 24 hours a day, seven days a week. Members of the Online Learning Community discover new knowledge while exploring their interests through:

- ▷ Unique activities and challenges
- ▷ Connecting with subject matters experts through weekly chats and blogs
- ▷ Interacting with peers through an exclusive discussion board
- ▷ Gaining access to resources designed to help students and information about other NASA competitions/opportunities including internships

Since 1989, NASA has supported the National Space Grant College and Fellowship Program. With over 850 affiliates, including 500 universities and colleges, the program is one of the most powerful education resources the Agency has at its disposal. NASA's relationship with the Space Grant Consortia has provided opportunities for educators and students to engage in aeronautics, engineering, and science activities, which in turn helps prepare students for STEM careers. As the Agency focuses its portfolio, the Space Grant program should also be directly

aligned with NASA's new education goals. The Agency aligns the consortia's work through its annual budget call and multi-year solicitation released every five years. As part of the education portfolio review, the activities of the consortia should be assessed against these recommendations and NASA can use the budget call to begin aligning the future work of the consortia. If significant gaps exist, the Agency may consider accelerating the development of a new multi-year solicitation.

1.3. Partnering with informal learning providers enhances NASA's ability to help scale up informal learning. NASA's Informal Education program should focus on those partners providing hands-on experiences based on NASA content and/or educator professional development opportunities. The program should continue to support partners focused on providing educator professional development.

1.3.1. The Education Coordinating Committee, responsible for coordinating informal education, and the Communications Coordinating Committee, responsible for coordinating Agency outreach, should develop NASA specific definitions for informal education and outreach. The two committees should release consistent policy guidance to the Agency establishing the definitions and use this guidance to ensure educational and outreach activities align with Agency goals.

1.3.2. The Education and Communications Coordinating Committees should develop a systematic way of coordinating efforts to ensure informal education and outreach are properly recognized, credited and evaluated no matter the funding source.

1.3.3. The Office of Education should develop an appropriate systemic evaluation model to assess and evaluate the impact of NASA-supported informal education projects.

1.3.4. The delivery of NASA content by partner informal program providers should be based on current education research and practices for informal, after-school and summer environments.

Examples of Informal Education Projects

- ▷ **The Museum Alliance** is a community of practice comprising informal science educators at museums, science centers, planetariums, observatory visitor centers, NASA visitor centers, zoos, aquariums, parks and nature centers who wish to share NASA information with their visitors.
- ▷ **Earth to Sky** is a partnership between NASA's Space and Earth Science disciplines, the U.S. National Park Service and U.S. Fish and Wildlife Service. NASA actively fosters collaboration between its science and interpretation/education communities and those of the U.S. National Park Service and the U.S. Fish and Wildlife Service, with the ultimate goal of enriching the experiences of millions of park visitors.
- ▷ **Beginning Engineering Science and Technology** designs activity guides to bring the principles of engineering alive for younger audiences and teach them the engineering design process. Guides were created for grades K-2, 3-5 and 6-8, but all follow the same set of activities that teach students about humans' endeavor to return to the moon: how we investigate the moon remotely (part 1), the modes of transportation to and on the moon (part 2) and humans living and working on the moon (part 3).

Within the NASA Education portfolio, informal education projects provide unique opportunities for students and educators, and heavily influence one of NASA's great strengths in education – inspiration. Inspiring students to be interested and ultimately competent in STEM disciplines has always been a cornerstone of NASA's informal education projects. The combination of NASA's exciting content with interesting venues and distribution channels creates a "wow factor" that is difficult to quantify, but clearly evident.

When asked what NASA's greatest strengths were, experts who briefed the Education Design Team continually cited NASA's inspirational content and passionate employees. The National Academies, in their 2008 review of the NASA K-12 program reached a similar conclusion, stating, "The exciting nature of NASA's mission gives particular value to projects whose primary goal is to inspire and engage students' interest in science and engineering, and NASA's education portfolio should include projects with these goals."¹⁹ In order to have a bigger impact and inspire more students, NASA Education should seek partners who can use NASA's content to inspire students in informal settings. In addition to increasing the capacity of museums, science centers and planetariums to use NASA content, the Agency should have a strategy for engaging community-based organizations, media

outlets and others who can use NASA content to inspire and engage youth. A coordinated NASA Education-wide effort to seek out and engage partners will put NASA's inspirational content into more high-quality programs and enable qualified partners to inspire more students and learners of all ages.

Expanding NASA's informal education partnerships will require the development of clear definitions of informal education and outreach to ensure efforts are managed and evaluated appropriately. Clear definitions will also enable the Offices of Education and Communications to understand where their efforts overlap and how to best collaborate to meet the needs of informal and outreach program providers.

NASA Summer of Innovation

NASA's Summer of Innovation project was started in the summer of 2010 to strengthen efforts by providers to engage underrepresented and underserved middle school students in STEM learning using exciting and rigorous NASA-based instructional resources, experiences and support tailored to local needs.

NASA Education must develop an appropriate evaluation model for informal education. Currently the Agency does not have a unified approach to evaluating informal education. Some projects use criteria developed for the Agency's formal education projects, while others have developed their own evaluation metrics, some of which are not grounded in evaluation best practices.

In the past year, the National Science Foundation released the study, *"Learning Science in Informal Environments: People, Places, and Pursuits."*²⁰ The Agency should develop a comprehensive approach for how it plans to evaluate its informal education efforts based upon this National Science Foundation study.

An informal education evaluation model will enable a review of informal education projects against criteria that are appropriate and provide data that can be used to inform NASA education leaders

1.4. The Office of Education should improve accessibility and usability of NASA online content to enable educators to more easily incorporate it into their curriculum and programs.

The wealth of information provided to educators and students through NASA's website has grown dramatically over time. While there have been recent efforts to make all teaching materials available through a searchable online database, more can be done to

Example of a Federal STEM Resource

ScienceEducation.gov is a single online source for federal science agencies' science, technology, engineering and mathematics education content, supporting cyber-learning and open participation.

ScienceEducation.gov
Supporting Science, Technology, Engineering, and Mathematics Education for America

Help | Site Map | Contact Us | My Account | SHARE

Home | About | FAQ | Feedback | Sign In

Search ScienceEducation.gov

Find it Fast
DOE NASA NIH NOAA NSDL USGS USDA Agency Resource Portals
Ask A Scientist Careers Classroom Activities Curricula Data Source
Education Research and Policy E-Mentors Field Trips Funding
Opportunities Internships Lesson Plans Online Interactive and Games
Professional Development Scholarships Science Competitions Science
Fairs Speakers Topic Presentations Unit Plans

Become a member (it's free).
Tag, rate, and comment on Scienceeducation.gov resources

LifeWorks
Browse jobs and read about real people in health and medical science careers that at Lifeworks, an interactive career exploration web site for middle and high school students.

USDA Healthy Meals
TeamNutrition: RT @USDA: Order up! Vote for your favorite #SchoolLunch recipe in our #R4HK challenge thru May 15 http://bit.ly/voteR4HK #LetsMove Mar 09, 2011
TeamNutrition: RT @USDA: Order up! Vote for your favorite #SchoolLunch recipe in our #R4HK challenge thru May 15 http://bit.ly/voteR4HK #LetsMove
Taste Test

Events
March 2011

Sun	Mon	Tue	Wed	Thu	Fri	Sat
		1	2	3	4	5
6	7	8	9	10	11	12
13	14	15	16	17	18	19
20	21	22	23	24	25	26
27	28	29	30	31		

More to Explore
National Lab Day
Bringing discovery-based science experiences to students...
ERIC
Unlimited access to more than 1.3 million bibliographic records related to education...
National Science Digital Library
A national network dedicated to advancing STEM teaching and learning...

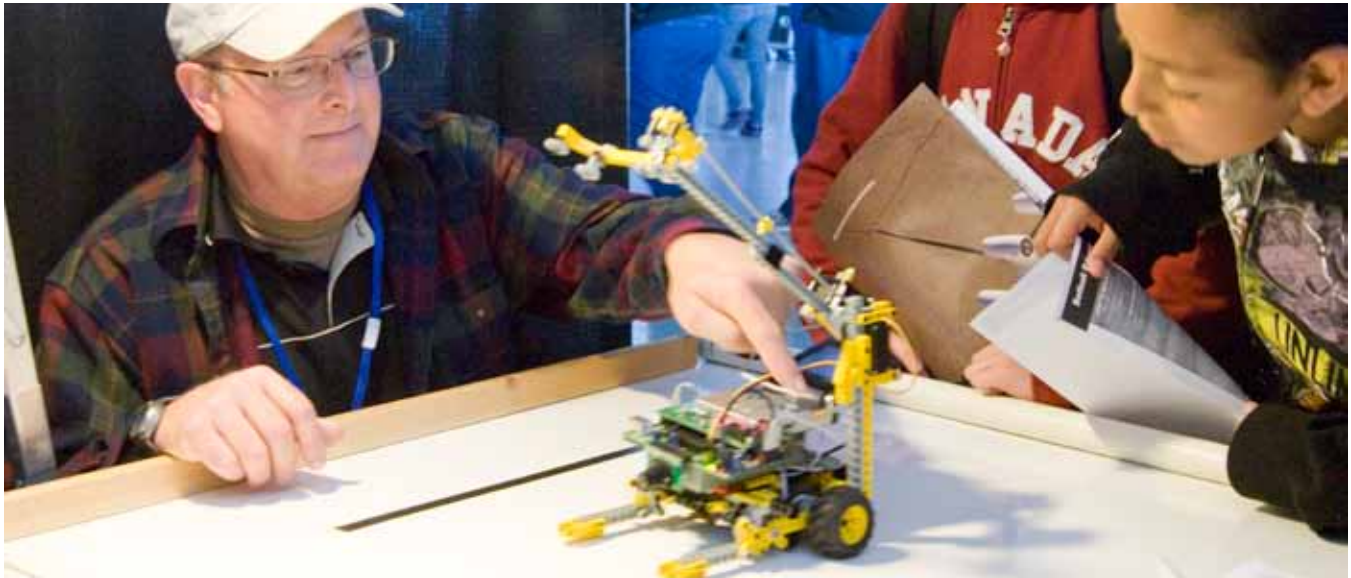

improve accessibility and usability. Zipporah Miller, a representative of the National Science Teachers Association, informed the Education Design Team that providing easier access to online NASA content would be extremely beneficial to science educators and help them inspire students.

In the future, NASA Education should have a website that is easier for educators to navigate and a more thoughtful approach to publicizing NASA's content. Additionally, NASA should continue to engage in collaborations with the Department of Education and National Science Foundation to make federal STEM resources more accessible through activities like ScienceEducation.gov.

1.5. The Office of Education should shift the responsibility for the Experimental Program to Stimulate Competitive Research (EPSCoR) to an appropriate NASA organization that can provide sufficient technical oversight (e.g., the Office of the Chief Technologist) in coordination with the Office of Management and Budget and Congress. This organization should have responsibility for research and technology development efforts and will serve as the best source of information and guidance to EPSCoR grantees. This change will enable the Office of Education to concentrate its efforts on its newly focused program.

EPSCoR establishes partnerships with government, higher education and industry designed to promote lasting improvements in a state's or region's research infrastructure, research and development capacity and competitiveness. The program is directed at those jurisdictions that have not in the past participated equitably in competitive aerospace and aerospace-related research activities. The two main elements of the Program – the Research Infrastructure Development Program and Research Cooperative Agreement Notice – create opportunities to build the infrastructure necessary to conduct research and provide research grants for work that addresses NASA-specific research and technology development needs respectively.

While the Office of Education focuses its resources on ensuring that undergraduates have access to scholarships and internships that will support them in obtaining their undergraduate degrees in STEM disciplines, research infrastructure awards should be aligned within an Agency office that can better support the goals of EPSCoR.



“The exciting nature of NASA’s mission gives particular value to projects whose primary goal is to inspire and engage students’ interest in science and engineering, and NASA’s education portfolio should include projects with these goals.”

NATIONAL ACADEMIES, 2008 REVIEW OF THE NASA K-12 PROGRAM



Recommendations

2 Identify and strategically manage NASA Education partnerships

NASA partners extensively with industry, academia, non-profits and other organizations to design and conduct educational activities. Many of these partnerships were developed in response to NASA program needs, while others have grown out of opportunities related to STEM education or NASA's mission partners. While NASA's Office of Education, Mission Directorates and Centers regularly work with many different partners on STEM education activities, the Agency has not typically been deliberate in its choice of partners or evaluation of the resources required to develop and sustain partnerships.

Partnerships represent NASA's greatest opportunity to expand both the national reach and impact of its STEM education efforts, given the Agency's limited education resources. NASA's well known brand gives the Agency the power to bring together interested parties concerned with STEM education. In turn, partners provide unique capabilities and access to stakeholder communities. Partnerships require resources to develop and maintain, but can provide an extension of NASA's reach into STEM education activities and can help sustain or grow programs by harnessing the resources of a number of like-minded organizations. Given the great potential in partnerships, it is important to focus efforts on developing relationships that best align with NASA Education objectives.



External education experts briefing the Education Design Team strongly recommended NASA work through partners whose interests are strategically aligned with the Agency's interests. These experts described a powerful pairing of NASA's inspiring and exciting mission content with organizations that focus their efforts on understanding and addressing the needs of STEM educators. Possible benefits resulting from partnerships can include:

- ▶ Creating a broader continuum of programs and services
- ▶ Serving greater numbers of people on a wider geographic scale
- ▶ Increasing program/service availability to greater numbers of underserved/ underrepresented populations
- ▶ Creating operational economies of scale and efficiencies
- ▶ Combining a broad array of funding sources to better sustain programs

- ▶ Providing for a greater awareness of available offerings
- ▶ Leveraging expertise, reducing risk and fostering teaming among like-minded organizations
- ▶ Leveraging existing investments
- ▶ Creating new solutions to old problems and/or coupling existing ideas into programs that address new challenges

NASA should be deliberate in developing an education partnership strategy to ensure the Agency's education goals are properly addressed; specific benefits and outcomes are defined; partnerships leverage each organization's resources appropriately; and the resulting program benefits all engaged parties. The Agency should enter into partnerships that produce an education product or service not otherwise available in that existing form, and/or result in the sharing of expertise, resources, services or products. Partnerships can also be used to develop new programs, or scale or replicate current successful efforts with new stakeholders. Parties can include not



only private sector organizations, but also public sector entities such as municipalities, states or other federal agencies. The partnership strategy should inform and guide Centers, Mission Directorates, Mission Support Offices such as the Offices of International and Intergovernmental Relations and Communications, as well as the Office of Education.

RECOMMENDED ACTIONS

- 2.1. The Office of Education should develop a strategy for education partnerships that includes the development of partnership criteria: clearly defined outcomes, the roles and responsibilities of all partners, measures of success, the partnership lifecycle and documents (e.g., Space Act Agreement, Memorandum of Agreement, etc.) necessary to capture the partnership agreement.
- 2.1.1. *The Office of Education should seek partnerships to enhance the effectiveness or broaden the reach of education programs and projects. As an example, NASA should develop partnerships to expand the distribution of its materials, provide direct service to students and educators, and to evaluate improvement in student performance.*
- 2.1.2. *The Office of Education should determine which partnerships can be developed and sustained at a local/center level and which partnerships the Office of Education, Office of Communications or Mission Directorates should manage at Headquarters.*
- 2.1.3. *The Office of Education should evaluate existing NASA education partnerships based on the criteria (established in action 2.1) to validate these relationships, identify the need for new partnerships and phase out those no longer serving Agency education goals.*

The intended outcome of this partnership strategy is to expand reach, fill pipeline gaps and ensure that programs have sustainability beyond NASA resources. Adopting this strategy will allow NASA Education to focus on its intended middle school student and educator professional development emphasis, while working with partners to ensure that other areas of the STEM pipeline (e.g., kindergarten through third grade, high school, etc.) are not neglected.

NASA's Summer of Innovation project collaborates with the Foundation for the Advancement of Women Now

NASA's Summer of Innovation project and Mary J. Blige's Foundation for the Advancement of Women Now collaborated to encourage young women to pursue careers in science. The young women received on-the-job training from NASA's Science, Engineering, Mathematics and Aerospace Academy project at York College of the City University of New York. The participants then used what they learned and delivered NASA content to the New York City Housing Authority Van Dyke Community Center and Harlem Children's Zone Promise Academy in the summer of 2010.



2.2. The Office of Education should develop a means to strategically manage the Agency's education partnerships, and consider using existing Agency tools before investing in new tool development.

2.2.1. The Office of Education in developing their partnership management function should collaborate with the Office of Communications and the Office of the General Counsel to take advantage of their lessons learned.

Once specific partnership criteria are set, the Office of Education will be able to assess existing and potential partners to determine the level of resources necessary to support joint activities (e.g., funding, personnel, NASA materials, and facilities) and the appropriate means to document a partnership (e.g., Memorandum of Understanding, Space Act Agreement). Additionally, the Office of Education should investigate existing Agency tools or knowledge management systems that can help manage partnership agreements, data and performance.

2.3. The Office of Education should take advantage of joint solicitations with other agencies to coordinate content delivery and program participation, particularly with the National Science Foundation and Department of Education.

Many organizations in both the government and the private sector share the goal of advancing STEM education. NASA is a member of the National Science and Technology Council Committee on STEM Education,^{xii} which provides a venue for NASA to collaborate on STEM education priorities with other government science and technology organizations. The Department of Education and others have a variety of mechanisms to disseminate STEM education information which NASA should leverage to make stakeholders aware of the Agency's activities and opportunities for collaboration. In turn, the Office of Education should open some of its Education Program initiatives to other federal agencies. Each National Science and Technology Council member has a different level of funding to support its STEM



^{xii} This Cabinet-level Council is the principal means within the executive branch to coordinate science and technology policy across the diverse entities that make up the federal research and development enterprise. Chaired by the President, the membership of the organization is made up of the Vice President, the Director of the Office of Science and Technology Policy, Cabinet Secretaries and Agency Heads with significant science and technology responsibilities, and other White House officials. The Administrator represents NASA to the National Science and Technology Council, and the Associate Administrator for Education represents the Agency on the Committee on STEM Education.

education initiatives, making collaboration an efficient approach to advance national STEM education goals.

National Science and Technology Council Education Committee Membership

- ▷ Department of Agriculture
- ▷ Department of Commerce
- ▷ Department of Defense
- ▷ Department of Education
- ▷ Department of Energy
- ▷ Department of Health & Human Services
- ▷ Department of the Interior
- ▷ Department of Transportation
- ▷ Environmental Protection Agency
- ▷ NASA
- ▷ National Science Foundation
- ▷ Domestic Policy Council
- ▷ National Economic Council
- ▷ Office of Management and Budget
- ▷ Office of Science and Technology Policy

2.4. The Office of Education should expand the STEM education content available to partners in order to capitalize on their potential to use NASA STEM content with students, educators, and the general public.

NASA should use partnerships to expand the distribution reach of its exciting and inspiring content. The Agency’s opportunity to reach students and educators can grow exponentially by making new content available to partners willing to distribute it through their unique channels, and committing to continue the flow of new learning modules as researchers advance technology and make new discoveries.

2.5. The Office of Education should develop partnerships with organizations that make NASA content useable and responsive to national and state standards.

Effective education often requires customizing resources to address the needs of specific stakeholders at a local level. NASA should leverage the expertise of partners to co-develop and implement STEM education programs addressing the needs of specific stakeholders. Education standards vary widely from state to state and school district to school district, so working with organizations that understand these differences will help ensure that NASA content can be distributed broadly but in ways that make it useful to educators. This could allow for inclusion of NASA content in local curricula and specific learning modules to make it more interesting for students to learn STEM disciplines.





“ I still get a highly positive reaction from kindergarteners, first and second graders. But somewhere after that time, we lose them. Studies show that by the time they have reached high-school, kids have made up their minds about whether they are going to pursue a career in math, science or engineering. Study after study shows we are losing them in the middle grade school years.”

REMARKS BY NASA ADMINISTRATOR CHARLES BOLDEN IN A SPEECH TO THE NATIONAL ASSOCIATION OF INVESTMENT COMPANIES, OCTOBER 20, 2009



Recommendations

3 Participate in National and State STEM Education policy discussions

RECOMMENDED ACTIONS

3.1. The Office of Education should develop an Agency position on STEM education topics such as the need for common core standards and the development of an engineering curriculum for high school students, to enable staff to consistently provide input to STEM policy discussions and debates.

3.2. The Office of Education should provide guidelines and training on how, when, and to what extent the Center education staff should engage in STEM education policy discussions.

3.2.1. The Center Education Directors' responsibilities should include engaging with his/her region's education leaders.

3.3. The Office of Education should identify opportunities for NASA STEM subject matter experts to participate in key STEM education advisory boards, STEM-related committees, and other organizations addressing STEM education.

The NASA education community provides an invaluable service to educators and students across the country through its projects and programs. It also has played a role in working with states to improve their curricula and define policy. External education experts, including Michael Lach of the Department of Education, Angela Baber of the National Governor's Association Education Division, and Zipporah Miller from the National Science Teachers Association, consistently recommended that as a future employer of scientists, technicians, engineers and mathematicians, NASA should play a more active role in the national STEM education policy discussion. Potential policy discussions include topics such as the need for national standards in STEM subjects, teaching engineering at the high school level, and certification and evaluation of STEM educators. Currently, NASA's position on education policy and legislation is not clearly articulated, disseminated or communicated across the Agency. Furthermore, there are no specialized Agency professional development opportunities to train NASA employees who are interested in participating in STEM education policy discussions.



The Education Design Team is aware that such policy-related work is already occurring within the Agency, but recognizes that greater impact may be possible by adopting a consistent Agency message and position as well as more broadly supporting state systemic education reform initiatives. This recommendation represents an expansion of the role of NASA Headquarters and Centers in the education field, and requires new resources and staff competencies for successful implementation. It also suggests that the Office of Education should coordinate staff professional development with the Office of Human Capital Management and provide guidance and training on how, when and to what extent to engage in state-level STEM education policy discussions.

NASA Detailee Impacts Virginia Science Education

As part of a six month detail, Jim Batterson, from the Langley Research Center, was sponsored by NASA and Virginia's Secretary of Education to lead three panels of practicing scientists and engineers to review the Commonwealth's Standard of Learning framework for Sciences. The panels presented their recommendations to Virginia's Secretary of Education, including a revised 2010 Science Standard curriculum framework, and proposed a standing committee of practicing scientists and engineers to prepare an annual Global State of STEM Report. Mr. Batterson's work in improving Virginia education is an example of NASA's effort to stay abreast of STEM education trends.

The Office of Education should identify opportunities for NASA experts to participate in key STEM education advisory boards, STEM-related communities of practice, and other national organizations addressing STEM education. An example of an effective policy effort of this kind was started in May 2009 by Lesa Roe, the Director of the NASA Langley Research Center (see sidebar). Ms. Roe assigned Jim Batterson, an engineer and former educator on her staff, to serve as a panel lead in a six-month assignment with the Virginia Secretary of Education to review the state's core science curriculum. Mr. Batterson led a panel of experts that developed a new science curriculum and proposed the creation of an annual *Global State of STEM Report* for the Commonwealth of Virginia. This is just one example of how NASA has been helping to shape the future of STEM education.^{xiii} Other examples of opportunities for NASA STEM subject matter experts include:

- ▶ Serving on Accreditation Board for Engineering and Technology^{xiv} panels for college and university programs in applied science, computing, engineering and technology
- ▶ Serving on advisory boards for National Science Foundation STEM grants
- ▶ Becoming members of STEM education-related societies such as the American Society of Engineering Education

^{xiii} http://www.nasa.gov/centers/langley/news/researchernews/rn_batterson.html

^{xiv} Accreditation Board for Engineering and Technology is an accreditor for college and university programs in applied science, computing, engineering and technology.

It is essential for Center Education Directors to play a central role in building the groundwork for successful implementation of this recommendation. They can do this by leveraging their extensive education networks, particularly those in their geographic regions, to communicate a unified Agency message and ensure that the STEM experts resident at their Centers have access to the requisite information and resources to support STEM education policy initiatives. Currently Center Education Directors and Program/Project Managers may not have the most recent information about the Agency's STEM policy position, may be overly cautious in their interactions with state or local representatives or may be unaware of communication strategies that can help the Agency achieve its goals.

To address this concern, the Office of Education should articulate strategies for constructive engagement supported through discussions with the Education Coordinating Committee and with key stakeholders, such as professional associations, other federal agencies, STEM education industry leaders, and state and local representatives.

Overall, the feedback from NASA's education community suggests that this recommendation for the Agency to participate in state and national STEM education policy discussions would be welcomed.





“The most important thing we can do is inspire young minds and to advance the kind of science, math and technology education that will help youngsters take us to the next phase of space travel.”

JOHN GLENN



Recommendations

4 Establish a structure to allow the Office of Education, Centers and Mission Directorates to implement a strategically integrated portfolio

The Office of Education, Centers and Mission Directorates should consider how well their current staffing, budget and program structures enable them to lead and manage a more focused program and well coordinated portfolio. While education is an important part of NASA's mission, education professionals do not have an established career path and development program that parallels the way the Agency develops and continually improves the skills of its scientific and engineering staff. In addition, an expansion of Headquarters' roles and responsibilities will be required to support the Agency's efforts to increase its national impact on STEM education. Current Headquarters staff members are responsible for large portfolios including programs and enabling capabilities that leave no time to take on new responsibilities. In order to focus NASA's Education Program, participate in STEM systemic reform initiatives and other new activities, the Office of Education should review its organizational structure, staffing and employees' skills to ensure the Office's form supports its new functions. This review should also consider whether additional roles and responsibilities can be delegated to Centers and what resources they would need to take on new requirements.

The Education Design Team recognizes that a focused program will require deliberate program design. NASA manages its technical programs with rigorous program/project management requirements. A similar level of rigor and discipline should apply to the Agency's education programs, scaled appropriately to the size and complexity of the programs.

An increase in training opportunities, improvements in program management and updated project design criteria will ensure consistency across NASA Education and ultimately allow for a more integrated portfolio. To evolve from projects funded in isolation to an integrated portfolio will require a change in behaviors and a more transparent planning and implementation process across all organizations supporting the NASA Education Program.



RECOMMENDED ACTIONS

- 4.1. The NASA Office of Education should be responsible for the professional development of education program/project staff throughout NASA. This responsibility includes assessing current staff capabilities, developing needed skills, partnering with the Office of Human Capital Management to develop new position descriptions as needed and create career paths for education professionals, identifying critical competencies, and routinely offering developmental opportunities around the Agency to better develop education leaders.

Human capital development is an essential part of any organization's future success and growth. Providing a robust career path to engage staff, create developmental opportunities and provide essential training will lead to increased productivity and motivation and allow staff to perform their job functions more effectively. To work with state and local education agencies, education staff members will require specific skills and knowledge. While the Centers and the Office of Education have made significant progress in improving the education proficiency of staff members, if NASA wants to improve STEM education, it is essential that the Agency's education community has the expertise to be catalysts for change.



The Agency does not necessarily need to develop this specialized training on its own; rather, it should partner with the Department of Education, National Science Foundation and organizations involved in systemic STEM reform to increase and augment the skills of the education staff.

- 4.2. The NASA Office of Education should review its Headquarters organization and adjust roles, responsibilities, skills and structure to accommodate new initiatives and recommendations.

4.2.1. The Office of Education should dedicate resources to manage and sustain partnerships.

Currently, the Outcome Managers in the Office of Education also serve as Program Directors for the congressionally appropriated budget assigned to the Office. Both are full-time roles and cannot be effectively managed by a single individual. Outcome management of the entire Agency portfolio is critical to ensuring that education investments effectively align to an integrated portfolio and requires individuals focused full time on performance. Program direction of the national programs in the Office of Education's budget is also a full-time endeavor and should be staffed accordingly. Office leaders should consider separating these two functions.

As noted in Recommendation 2, partnerships are critical to the success of the new framework and direction. NASA should be deliberate in developing an education partnership strategy to ensure the Agency's Education mission and vision are properly addressed, specific benefits and outcomes are defined, partnerships leverage each organization's resources appropriately and the resulting program benefits all engaged parties. The Agency needs to sufficiently staff a partnership management function to ensure that partnerships are well supported.



4.3. The Office of Education should be responsible for tailoring NASA Information Technology and Institutional Infrastructure Program and Project Management Requirements, NPR 7120.7, by creating an appendix with specific guidance for education program and project managers.

4.3.1. *The Office of Education should establish the criteria for those educational investments that will be held to Agency project management requirements, the requirements for new programs or projects seeking to enter the portfolio, and the criteria for evaluating education programs and projects during regular review cycles.*

4.3.2. *The Office of Education should develop a transition plan to bring existing programs and projects into compliance with these requirements.*

The Education Design Team recognizes the need for deliberate program design and supports creating new requirements for NASA education programs in an education program-specific appendix to the Agency's project management requirements. NASA's Education Program investments should be considered important and visible enough to warrant project management rigor, reporting and oversight. The Office of Education has already begun work with the Office of the Chief Engineer to tailor and adapt an appendix to the Agency requirements document, and determine reasonable criteria for assessing which education projects should be governed by the new requirements.

Once the updated education-specific appendix is approved, the Office of Education should consider which programs and projects in the Agency's education portfolio should be held to the new requirements and establish expectations for compliance.

4.4. The Office of Education should continue to serve as an Agency advocate for education, encouraging Mission Directorates to invest in and provide support for education efforts aligned with their programmatic content.



Mission Directorates take different approaches to their education efforts. The Science Mission Directorate sets aside a portion of each project's budget, while the Exploration Systems Mission Directorate and Aeronautics Research Mission Directorate establish an education budget at the directorate level. Space Operations Mission Directorate has a small education budget but provides significant in-kind support for downlinks from the International Space Station, astronaut appearances in schools and informal science venues, and flying education hardware and experiments on board the Space Shuttle and International Space Station. The success of the recommendations included in this report is dependent on an Agency commitment and coordinated approach to NASA's STEM education investment. Mission Directorates should continue to fund and support education efforts aligned with their programmatic content.

4.5. The NASA Office of Education should develop a program that identifies opportunities for NASA staff to work with organizations on education projects; encourages staff to submit applications for education-related detail assignments, including assignments at colleges and universities; and helps to negotiate agreements to place Agency staff at external organizations in support of STEM education.

4.5.1. *The Office of Education should develop a screening process to identify a pool of potential program participants to support STEM education efforts.*

4.5.2. *NASA should consider identifying and assigning staff members to states pursuing systemic STEM education reform. These staff members would use their STEM expertise to assist states with special projects and help infuse NASA content into state programs and curricula. The Headquarters Office of Education should be assigned to coordinate this effort on behalf of the Agency.*

NASA has the opportunity to become more involved in shaping STEM policy at the national and state level. The Office of Education should work with the Office of Human Capital Management to encourage and enable staff across the Agency to use their expertise to support STEM education organizations or work on education projects through detail assignments. This would provide an effective means for Agency staff to infuse NASA content into STEM curricula and impact the broader education community. In order to support programs such as UTeach Engineering,^{xv} the Office of Education should identify organizations with which to partner, create an Agency policy encouraging technical staff to support STEM education projects and organizations, develop a rigorous process to screen potential participants and provide training to those selected to effectively support these partnerships.

4.6. The Office of Education should create separate functions (e.g., teams, groups) with responsibility for evaluating education programs and projects and for collecting outcome data to support education research.

Collecting data and monitoring performance and evaluating program impacts and effectiveness are two different but interrelated functions. Currently, the Agency has a single team responsible for both functions. As the Agency refines its portfolio, it will be important to separate the two functions and ensure both are sufficiently staffed. The evaluation function should be devoted to evaluating the relevance, quality, efficiency, and performance outcomes of ongoing programs, as well as serving as the point of contact for contracted third party evaluations. An evaluation team should also serve as a central resource for all evaluation activity to ensure that standard metrics are used throughout NASA Education programs and projects and that the metrics are based on sound research and practice.

The research/data-collection function should be responsible for the Office of Education Performance Monitoring system, and serve as a centralized research resource on education issues for the Agency. A research/data-collection team should support both reviews of current education research as well as

NASA Education Design Team member Lisa Guerra is currently on site at the University of Texas where she helped to create an undergraduate course in Space Systems Engineering and has just started an effort to develop a high school engineering curriculum through UTeach Engineering. Once piloted in Austin high schools, the curriculum will be rolled out across the state of Texas.

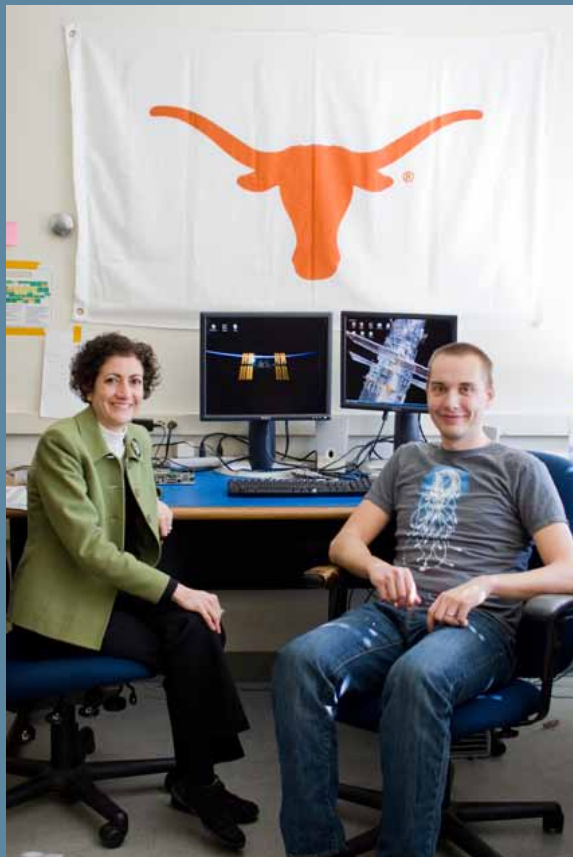

UTeachEngineering
Preparing Secondary Educators to Teach Design-Based Engineering Courses

provide the data necessary for independent education research. They should routinely provide education research findings to inform the Agency's education programs and projects. In addition, the research/data-collection team should establish a continual improvement process to allow the NASA education system to adapt as new needs/requirements are identified.

^{xv} UTeach Engineering was established in 2008 with support from the National Science Foundation to prepare university students and in-service educators to teach innovative and exciting curricula that will allow their students to discover what engineering is, what engineers do, and the role engineering plays in shaping their world. (<http://www.uteachengineering.org>).



“ There are people who make things happen, there are people who watch things happen, and there are people who wonder what happened. To be successful, you need to be a person who makes things happen. ”

JAMES A. LOVELL, IN A SPEECH TO GIRL SCOUTS
IN DUPAGE COUNTY, ILLINOIS, 1997



Recommendations

5 Expand the charter of the Education Coordinating Committee to enable deliberate education program design

In 2008 and 2009, external reviewers from the National Academies of Science and the Teaching Institute for Excellence in STEM urged NASA to be more deliberate in the design of its educational offerings by: setting specific achievable goals, designing programs and projects to meet these goals and evaluating the effectiveness of programs and projects in achieving those goals.^{xvi} To do this, NASA will need to extend its program/project management discipline to its education offerings as outlined in Recommendation 4 by creating a senior-level decision-making body to baseline and assess program/project performance and ensure successful achievement of NASA's education goals. This decision-making body should be similar to the Agency's Program Management Council, which serves the same function for the Agency's flight and research programs and projects.

NASA's Education Coordinating Committee consists of representatives from the Office of Education, Mission Directorates, Mission Support Offices and the Center Education Offices. The Committee is a collaborative body that supports the Agency's education strategy by coordinating education efforts across the Agency.

To enable deliberate education program design, this body should become a governance body, chartered to serve as the Agency's senior decision-making body to baseline and assess education program/project performance and help ensure the successful achievement of NASA's education goals. The Education Coordinating Committee should be responsible for the alignment of programs and projects to Agency education outcomes and objectives, approving the entry of new programs and projects into the education portfolio, and the assessment of program and project performance in achieving Agency goals. To focus the projects now in NASA's education portfolio on new goals, the Education Design Team recommends that the Committee sponsor and support an independent portfolio review, to be commissioned by the Office of Education and conducted by an external evaluator.



^{xvi} Teaching Institute for Excellence in STEM designs and engineers statewide systems of innovative STEM education networks focused on project-based learning in STEM disciplines. (www.tiesteach.org).

RECOMMENDED ACTIONS

5.1. The NASA Education Coordinating Committee should update the Agency's education strategy and framework as needed based on acceptance of Education Design Team recommendations, and help to communicate the updated strategy and framework throughout the Agency.

5.1.1. The Committee should update the NASA Education outcomes and measures to address new Agency objectives.

The NASA Education framework, as shown in Figure 3, is built on four main focus areas – inspire, engage, educate, and employ – to cultivate a future STEM workforce through efforts from across the education portfolio. As Figure 3 shows, NASA Education has a clearly defined and coordinated portfolio approach where education objectives are aligned with education outcomes within the education framework.

While aligned to the framework, the education portfolio is still developed within individual funding organizations, is diverse and targets numerous stakeholders. Following acceptance of the Education Design Team's recommendations, NASA's Education Coordinating Committee should update the Agency's education framework – including program objectives and associated measures – that will become the basis for the portfolio review and the transition from a loose confederation of smaller projects to a strategically focused portfolio. The update should bring the education portfolio into alignment with the Agency's new 2011 Strategic Plan.



5.2. NASA should expand the Education Coordinating Committee charter to empower it to serve as an education governance body.

5.2.1. *As with the Agency's other governance councils, the Committee's decision authority should rest with the Chair, the Associate Administrator for Education, and should be informed by council discussion and debate.*

5.2.2. *Mission Directorates maintain authority over their funds and the updated charter should define an escalation path to bring unresolved issues to the next level of authority. In instances where the Committee is considering educational programs/projects funded by offices other than the NASA Office of Education, the meeting should be co-chaired by the Associate Administrator for Education and the delegated authority representing the funding organization.*

5.2.3. *The NASA Office of Education, on behalf of the Education Coordinating Committee, should commission an independent in-depth review of programs and projects, regardless of funding source, against new Agency education goals, reprioritized budgets and program/project management requirements.*

5.2.3.1. *The Education Coordinating Committee should develop a transition plan to phase out programs and projects that no longer align with NASA strategic goals and the Agency's education outcomes.*



5.2.3.2. *The Committee should conduct an ongoing assessment of the Agency education portfolio to determine alignment to education outcomes and objectives and review education programs and projects at Key Decision Points in their lifecycles to determine which programs/projects are ready to transfer to other partners (consistent with recommendation 1.1) and which should terminate or continue development or operations. The Office of Education and the Committee should use evaluation and assessment data for continuous education program improvement.*

5.2.4. *Education Coordinating Committee members need to be empowered by their home organizations to make decisions regarding education programs, projects and activities within their organizations.*

With the expansion of Education Coordinating Committee authority, the Agency should ensure that Center Education Directors and Mission Directorate Education Leads – who are also Committee members – have the necessary authority to make decisions regarding education activities funded or sponsored by their respective organizations. Within their home organizations, these individuals should be responsible for alignment of all education activities with Agency goals and education objectives, and ensure that the criteria for sound education program/project design and performance are met.





“Every great dream begins with a dreamer. Always remember, you have within you the strength, the patience, and the passion to reach for the stars to change the world.”

HARRIET TUBMAN



Recommendations

6 Improve communication to inspire learners

While many federal government and private sector organizations are involved with advancing the national STEM education agenda, NASA is uniquely positioned to play a visible role in communicating with the general public. Many education experts told the Education Design Team that NASA has the “wow factor” for inspiring students that some other agencies lack, underscoring how important it is for NASA to highlight its missions and education initiatives.

Building a strong reputation as a positive and active contributor to STEM education initiatives requires effective and consistent communication. While NASA employs numerous mechanisms to communicate with students, educators and learners of all ages in multiple settings, the Agency should strive to adopt more proactive measures to reach target audiences. By increasing the capacity of the Office of Communications to support NASA’s education efforts, NASA will be able to more effectively communicate the Agency’s inspirational content with learners and educators. The Offices of Education and Communications, Mission Directorates and Centers should coordinate in managing outreach, which is where missions invest heavily in communications, and be actively involved in the earliest stages of mission planning to ensure education and communication requirements are addressed.

PREPARE AND INSPIRE: K-12 Science, Technology, Engineering, and Math Education for America’s Future, the President’s Council of Advisors on Science and Technology

In the report, the authors noted, “We must prepare students so they have a strong foundation in STEM subjects and are able to use this knowledge in their personal and professional lives. And we must inspire students so that all are motivated to study STEM subjects in school and many are excited about the prospect of having careers in STEM fields.”



RECOMMENDED ACTIONS

6.1. NASA should increase the capacity of the Office of Communications in order to enable NASA Education to more effectively reach those who are the targets of its educational programs and projects and enhance student and educator awareness of NASA's educational content and programs.

NASA Education should rely on the professional capabilities of the NASA Office of Communications for maximum exposure of NASA educational projects and content. While NASA Education efforts will focus on pre-service and middle school educator professional development and undergraduate education and research, communication activities should aggressively highlight all initiatives including those funded by partners.

Kennedy Educate to Innovate

The Kennedy Space Center Education Programs and University Research Division created the Kennedy Educate to Innovate project in 2010 to engage the Kennedy work force to inspire students to pursue STEM-related careers. In its first year the project reached more than 43,000 students, far exceeding the target goal of 35,000. During this year, the Division:

- ▷ Created turnkey educational kits
- ▷ Trained 358 Kennedy Space Center employees in three months
- ▷ Coordinated three NASA Family Education Nights reaching 737 students

All activities used in the project were NASA-themed and aligned to national educational standards. The Brevard Public School System superintendent, local school officials and three local educator interns were also involved in the development of the Kennedy Educate to Innovate project.

NASA should take advantage of its exciting discoveries and activities to inspire students and educators. Media activities announcing NASA discoveries and research should link to associated education content and program offerings.

6.2. While many of NASA's Centers allow employee participation in educational activities, Agency policy should recognize and encourage employee participation in sanctioned STEM education and outreach activities in coordination with the Office of Education, Centers, Mission Directorates and Communications.

6.2.1. The NASA education community should assist non-education personnel to more effectively engage with educators and students.

NASA employees currently give back to their local communities through mentoring projects (e.g., FIRST Robotics Competition),^{xvii} presenting at events organized through the NASA Speakers Bureau, collaborating with informal education organizations (e.g., museums, science centers) and volunteering at schools (e.g., judging science fairs, giving classroom presentations and attending career fairs). While employees participate in these formal and informal education projects, there is no Agency-wide policy governing participation. Each NASA Center has its own policy and guidelines for deciding which employees can participate. In order to make the most of this experience – for the employee and student or educator – the NASA education community should assist non-education personnel to more effectively engage with educators and students appropriately. The Office of Education should work with the Office of Human Capital Management to develop an Agency-wide policy for employee engagement with educators and students.

^{xvii}The FIRST (For Inspiration and Recognition of Science and Technology) Robotics Competition began in 1992 as a non-profit program that combines the excitement of sport with the rigors of science and technology. Since its inception, the Competition has grown exponentially from 28 sponsored high school teams to 1,683 teams competing in 2011. The NASA Robotics Alliance Project, created in 1999 to inspire K-12 students in robotics, has supported the FIRST Robotics Competition through encouraging NASA employees to volunteer as mentors and by helping plan and coordinate the regional competitions.

6.3. The Office of Communications should expand the charter of the Communications Coordinating Committee to better coordinate internal and external communication and to align mission- and Center-funded outreach efforts with overall Agency goals. Similar to what the Education Coordinating Committee has done for education, the Communications Coordinating Committee should align communications projects funded by organizations other than the Office of Communications with Agency goals.

6.4. NASA Education and the Office of Communications should be involved in early planning and the requirements definition phase of major NASA missions.

Any kind of preparation for new NASA missions requires significant planning. There is a unique opportunity for education and communications professionals within NASA and its partner organizations to work collaboratively with project managers to identify ways in which education and outreach can complement the Agency's missions. NASA Education and the Office of Communications should build an Education and Public Outreach communication strategy that leverage the excitement of each mission. Once the mission's goals and objectives are defined, NASA should plan to generate interest and educational impact for students and educators. The intended outcome of this coordinated communications plan is to consistently apply a strategy for all NASA Education initiatives and create a framework to proactively engage key partners in promoting STEM education.





“We are not the primary STEM educators for the Nation, we’re not the Department of Education, but STEM is what we’re about. We do risky stuff, and we do it well. Education innovation is risky, but we’re willing to take that risk...”

ADMINISTRATOR CHARLES BOLDEN



Summary and Next Steps

The recommendations put forward in this report by the Education Design Team represent a best-faith effort to provide NASA Education with ways in which it can improve its education program and have the greatest possible impact on STEM education. These recommendations echo a sentiment expressed by Administrator Bolden when he stated, “We are not the primary STEM educators for the Nation, we’re not the Department of Education, but STEM is what we’re about. We do risky stuff, and we do it well. Education innovation is risky, but we’re willing to take that risk...”²¹

Following the acceptance of these recommendations by the NASA Administrator, Deputy Administrator and the Associate Administrator for Education, the Office of Education should develop an implementation plan that details the activities and timelines for implementation.

Many of these recommendations call for significant changes in the portfolio and how projects within that portfolio are managed. They also call for organizational changes and a shift in certain responsibilities across the Agency. Changes of this magnitude cannot, and should not, be made in a vacuum. Only through a commitment to change and by soliciting the education community to contribute their ideas and energy to the new Program goals can these changes be made effectively.

Since its creation in 1958, NASA has been a driving force for innovation in science, technology, engineering and math. Once implemented effectively, the benefits realized from these recommendations will help to ensure that tomorrow’s NASA will have a highly educated STEM workforce capable of taking the Agency’s position as the preeminent aerospace and aeronautics organization in the world to new heights.



Appendix A Terms and Definitions

A

Activity

An educational process or procedure intended to stimulate learning through actual experience.

C

Curriculum Support Materials

The identification of the required subjects and topics that are critical for a given grade or age. NASA's curriculum support materials focus on those disciplines it employs to successfully complete missions and make advances in STEM disciplines. NASA's curricular resources are developed to national standards, peer reviewed and tested in classrooms before being released.

E

Evaluation

The process used to provide independent assessments of the continuing ability of the program/project to meet its technical and programmatic commitments. Evaluation also provides value-added assistance to the program/project managers.

Educator Professional Development

Professional development, usually through practical application, for persons currently employed as educators in both formal and informal settings. This is a broader term, inclusive of teacher professional development, and the work NASA does to increase the technical skills of informal educators. NASA infuses its content into these development opportunities to provide educators with the knowledge necessary to successfully teach a STEM subject.

F

Fellowships

Competitively awarded fellowships are offered to support independently conceived and designed research by highly qualified graduate and post-graduate students in disciplines needed to help advance NASA's missions.

Formal Education

Programs intended to provide support for or to strengthen education at the elementary and secondary through postgraduate levels, including adult education.

G

Governance

The process by which the Agency makes decisions where they require a high degree of visibility, integration and approval, typically involving or impacting more than a single funding organization. Governance touches all major strategic management processes: approval and oversight of strategic planning, implementation of the Agency's portfolio, and monitoring and overseeing activities for which formal baselines have been established.

I

Informal Education

Informal education activities are those with the intent to provide voluntary, self-directed opportunities for individuals who are motivated by personal needs and interests. This type of education takes place outside the established formal education pipeline.

Internships

Competitively awarded positions that provide research or engineering opportunities for high school and undergraduate students in which they gain real-world experience contributing to the operation of a NASA Center or the advancement of NASA's missions.

Implementation

To put in place the necessary resources and take action to perform a program or project. Implementation Plans are developed with clear requirements and traceability to the Agency Strategic Plan in order to verify compliance to the plan, define the baseline from which monitoring and evaluation will occur, and to enable the development of performance reporting to external stakeholders.

M

Museum Alliance

The Museum Alliance is a community of practice comprised of informal science educators at museums, science centers, planetariums, observatories, zoos, aquariums, parks and nature centers who wish to incorporate NASA's activities and materials into their exhibits and visitor programs. It is intended to bring current NASA science and technology to visitors through professional development of staff and provision of materials such as visualizations, access to NASA experts, educational materials, etc.

Mission

The core function(s) and primary job(s) of the Agency.

Metric

The various parameters or features of a process that are measured. A standard of measurement.

N

NASA Education Community

Includes all personnel involved in formal and informal NASA Education activities including Speaker's Bureau events, science fair judging, mentoring, etc.

NASA Education

At NASA, the formal and informal education programs and the people who support them. The term "NASA Education" includes more than the people and programs of the Agency's Office of Education; it includes the people and efforts of NASA's mission organizations and Centers, and as such, represents the Agency's entire educational portfolio.

O

Office of Education

The Office of Education manages NASA's education budget and administers national education programs that draw on content from across the Agency. The Office provides the leadership for setting Agency education goals, coordinating and integrating NASA's education framework, implementation approach and policies. The Office of Education is responsible for ensuring compliance with external requirements, laws and NASA-wide processes, procedures and standards

related to the education budget. The Office solicits external advice on matters pertaining to education and represents the Agency externally, especially in interactions with Congress, the Administration and other federal agencies.

Outreach

Activities intended to raise awareness of, or interest in, NASA, its goals, missions and/or programs, and developing an appreciation for and exposure to science, technology, research and exploration.

Outcome

Result of a program effort (what happened as a result of the program) compared to its intended purpose.

P

Pre-Service

An undergraduate student who has declared an education major but has not yet completed training and certification. These students typically complete a period of observing educators at different levels and an internship or student teaching experience working alongside a mentor or master educator before being licensed as a professional educator.

Program

A strategic investment by a Mission Directorate or Mission Support office that has defined goals, objectives, architecture, a funding level and a management structure that supports one or more projects.

Project

A specific investment identified in a program plan having defined goals, objectives, requirements, life-cycle costs, a beginning and an end. A project yields new or revised products or services that directly address NASA's strategic needs. They may be performed wholly in-house; by government, industry or academic partnerships; or through contracts with private industry.

Program Assessment

A determination, through objective measurement and systematic analysis, of the manner and extent to which federal programs achieve intended objectives.

Portfolio

A collection of investments and strategies, such as research development, managed to further a common goal or goals.

S**STEM**

The disciplines of science, technology, engineering and mathematics.

STEM Content Development

Creation of education content that includes science, technology, engineering, and mathematics material and knowledge from NASA's missions. NASA's STEM content supports informal and formal educators by providing them information that can be used as part of an activity or lesson that may fill a curriculum requirement.

Strategic Planning

A disciplined effort to produce fundamental decisions and actions that shape and guide what an organization is, what it does and why it does it, with a focus on the future.

Strategic Goal or Strategic Objective

A statement of aim or purpose included in a strategic plan that defines how an Agency will carry out major segments of its mission over a period of time.

Student Experiential Activities

Hands-on learning activities occurring in formal and informal settings that engage and inspire learners of all ages while advancing NASA's goals in STEM education.

U**Underserved Communities**

Often used interchangeably with "underrepresented," particularly as it relates to the sciences and engineering. Specifically, it is used to promote access and opportunity to persons of diverse backgrounds—racial, ethnic, gender, religious, age, sexual orientation, disabled, and other populations with limited access—to decent and affordable housing, gainful employment, and other services. In the STEM area, "underserved" has typically referred to women and persons with disabilities.

Underrepresented Communities

Refers to persons from racial and ethnic groups whose enrollment in STEM education or participation in STEM professions is much smaller than that group's representation in the general population. African Americans, Hispanics/ Latinos, and Native Americans and Pacific Islanders currently fit this definition.

Appendix B Reference Documents

The Team focused its research on the latest national education policy and STEM education industry reports throughout their deliberations. They used these reports not only to gain more insight into the national STEM landscape, but to incorporate elements of well documented STEM education practices. Additionally, the Team researched U.S. legislation from 2000 – 2008 to evaluate the changes in funding and reviewed congressional appropriations language to gauge Congress’s intent for NASA education over the same period.

1. INDUSTRY REPORTS

Christensen, Clayton M., Michael B. Horn and Curtis W. Johnson. *Disrupting Class: How Disruptive Innovation Will Change the Way the World Learns*. New York: McGraw-Hill, 2008. Print.

Committee on Science, Engineering, and Public Policy, National Research Council. *Rising Above the Gathering Storm: Energizing and Employing America for a Brighter Economic Future*. Washington, D.C.: The National Academies Press, 2007. Print. <http://www.nap.edu/openbook.php?record_id=11463&page=1>

Committee for the Review and Evaluation of NASA’s Precollege Education Program. *NASA’S Elementary and Secondary Education Program*. Washington, D.C.: The National Academies Press, 2008. Print. <http://books.nap.edu/openbook.php?record_id=12081&page=R1>

Committee on the Study of Teacher Preparation Programs in the United States. *Preparing Teachers: Building Evidence for Sound Policy*. Washington, D.C.: The National Academies Press, 2010. Print. <http://www.nap.edu/openbook.php?record_id=12882&page=R1>

Margaret Hilton, Rapporteur. Exploring the Intersection of Science Education and 21st Century Skills: A Workshop Summary. Washington, D.C.: The National Academies Press, 2010. Print. <www.nap.edu/openbook.php?record_id=12771>

Committee on Science, Engineering, and Public Policy and Thomas Arrison, Rapporteur. *Rising Above the Gathering Storm, Revisited: Rapidly Approaching Category 5*. Washington, D.C.: The National Academies Press, 2009. Print. <http://www.nap.edu/catalog.php?record_id=12999>

Committee on Science, Engineering, and Public Policy, National Research Council. *Rising Above the Gathering Storm Two Years Later: Accelerating Progress Toward a Brighter Economic Future*. Washington, D.C.: The National Academies Press, 2007. Print. <www.nap.edu/openbook.php?record_id=12537&page=R>

Morrison, Jan, Merrilea Mayo and Raymond V. Bartlett. *NASA Engagement in STEM Education: Innovation in Education for Sustainable Achievement*. Baltimore, Maryland: Teaching Institute for Excellence in STEM, 2009.

NOAA Education Council. *Education Strategic Plan 2009-2029*. Washington, D.C. <http://www.oesd.noaa.gov/NOAA_Ed_Plan.pdf>

NOAA Education Council. *National Oceanic and Atmospheric Administration 2009 – 2029 Education Strategic Plan: 2010-2014 Implementation Plan*. Washington, D.C., February 2010. <http://www.oesd.noaa.gov/planning_policy/lplanFinal_21210.pdf>

DoD STEM Education and Outreach Board of Directors. *STEM Education & Outreach Strategic Plan*. Washington, D.C.: U.S. Government Printing Office, 2009. Print. <http://www.afa.org/ProfessionalDevelopment/AerospaceEducation/ReportsandStudies/RS_PDFs/DoD-wide%20STEM%20Plan%20FINAL.pdf>

Office of the Under Secretary of Defense, Acquisition, Technology and Logistics. *Survey of DoD Science, Technology, Engineering and Mathematics (STEM) Programs*. Washington, D.C.: U.S. Government Printing Office, 2009. Print. <www.acq.osd.mil/ddre/stem/docs/STEM_Program_Survey.pdf>

National Aeronautics and Space Administration, Program Analysis and Evaluation. *A Review of the NASA Education Program: Education Team Report*. August 2005.

Office of Science and Technology Policy, Executive Office of the White House. *Preparing Our Children for the 21st Century Economy Science, Technology, Engineering and Mathematics (STEM) Education in the 2010 Budget*. Washington, D.C.: U.S. Government Printing Office, 2009. Print.

President's Council of Advisors on Science and Technology. *Prepare and Inspire: K-12 Education in Science, Technology, Engineering, and Math (STEM) for America's Future*. Washington, D.C.: U.S. Government Printing Office, 2010. Print. <<http://www.whitehouse.gov/sites/default/files/microsites/ostp/pcast-stemed-report.pdf>>

Scileppi, John, and Ronald Cromwell. *A Systems Approach to Education*. ERIC - Education Resources Information Center. 1995. Web. <<http://www.eric.ed.gov/ERICWebPortal/detail?accno=ED392151>>

Committee on Learning Science in Informal Environments, National Research Council. *Learning Science in Informal Environments: People, Places, and Pursuits*. Washington, D.C.: The National Academies Press, 2009. Print. <http://www.nap.edu/catalog.php?record_id=12190#toc>

National Center for Education Statistics. "Digest of Education Statistics, 2009 - Chapter 3: Postsecondary Education." U.S. Department of Education, 2009. Web. <http://nces.ed.gov/programs/digest/d09/ch_3.asp>

National Center for Education Statistics. "State Nonfiscal Survey of Public Elementary/Secondary Education." U.S. Department of Education, 2010. Web. <<http://nces.ed.gov/programs/projections/projections2018/tables.asp>>

National Science Foundation. "Science and Engineering Indicators 2008." January 2008. Web. <<http://www.nsf.gov/statistics/seind08/tables.htm#ch3>>

2. LEGISLATION AND INTERNAL NASA DOCUMENTATION

Memorandum for the Record: Markup of the NASA 2011 Authorization Bill, Executive Session of the Senate, Commerce, Science and Transportation Committee, 5136, 111th Cong., Library of Congress (2010). Print. <<http://thomas.loc.gov/cgi-bin/bdquery/z?d111:H.R.5136:>>

United States. Cong. House of Representatives. 110th Congress. *H.R. 2272, America COMPETES Act* [introduced in the U.S. House of Representatives; 10 May 2007]. 106th Cong., Library of Congress. Web. <<http://thomas.loc.gov/cgi-bin/bdquery/z?d110:h.r.02272:>>

Memorandum for the Record: Markup of the NASA 2011 Authorization Bill, Executive Session of the Senate, Commerce, Science and Transportation Committee. H.R. 578, July 2010. <<http://thomas.loc.gov/cgi-bin/bdquery/z?d111:h.r.5781:>>

United States. Cong. Senate. 111th Congress. *S.3729, National Aeronautics and Space Administration Authorization Act of 2010* [introduced in the U.S. Senate; 5 August 2010]. 111th Cong., Library of Congress. Web. <<http://thomas.loc.gov/cgi-bin/bdquery/z?d111:S3729:>>

United States. Cong. House of Representatives. 111th Congress. *H.R. 5781, National Aeronautics and Space Administration Authorization Act of 2010* [introduced in the U.S. House of Representatives; 7 July 2010]. 111th Cong., Library of Congress. Web. <<http://thomas.loc.gov/cgi-bin/bdquery/z?d111:h.r.5781:>>

NASA Education Design Team Charter, May 2010

NASA Procedural Requirements 7120.5D - NASA's Program and Project Management Processes and Requirements. Agency policy governing management of programs and projects. <http://nodis3.gsfc.nasa.gov/displayDir.cfm?Internal_ID=N_PR_7120_005D_>

3. ADMINISTRATOR SPEECHES

Committee on Commerce, Science and Transportation, United States Senate, 8 July 2009

Apollo 40th Anniversary Celebration, National Air and Space Museum, Washington, D.C., 20 July 2009

Space and Missile Defense Conference, Huntsville, AL, 19 August 2009

Race to the Moon: A Celebration with Space Legends (Gala Dinner), USS Midway Museum, San Diego, CA, 5 September 2009

NASA and the Future of the Aerospace Workforce, AIA Defense/Space Industrial Base Breakfast, Senate Visitor Center, Washington D.C., 16 September 2009

Space Entrepreneurship Forum, Congressional Black Caucus, Washington, DC, 23 September 2009

National Association of Investment Companies, Washington, D.C., 20 October 2009

Wernher Von Braun Memorial Symposium Dinner Address, Huntsville, AL, 21 October 2009

American Astronomical Society Winter Meeting, 5 January 2010

NASA Budget Press Conference, 1 February 2010

National Press Club Event, 2 February 2010

Subcommittee on Science and Space, Committee on Commerce, Science, and Transportation, United States Senate, 24 February 2010

Committee on Science and Technology, U.S. House of Representatives, 25 February 2010

Washington Space Business Roundtable Satellite 2010 Conference, Washington, D.C., 16 March 2010

Subcommittee on Commerce, Justice, Science, and Related Agencies, Committee on Appropriations, U.S. House of Representatives, 23 March 2010

National Space Symposium, 13 April 2010

Subcommittee on Commerce, Justice, Science, and Related Agencies, Committee on Appropriations, U.S. Senate, 22 April 2010

Commencement Address to the Class of 2010, Huston-Tillotson University, Austin, TX, 8 May 2010

Hearing on "The Future of U.S. Human Space Flight," Committee on Commerce, Science, and Transportation, United States Senate, 12 May 2010

Seventh Annual World Congress for Brain Mapping and Image Guided Therapy, Bethesda, MD, 24 May 2010

Appendix C

Education Design Team Survey Questions

1. Are you an ECC Member: Y/N
2. Please select if you are a NASA Civil Servant, NASA Contractor, or Other
3. Rate your knowledge of NASA Education programs/projects (One being little to no knowledge; 5 being extremely knowledgeable)
4. Which of the following types of NASA Education activities are you involved with? (e.g. Faculty and Research Support, Student Support, etc.)
5. Please select the most appropriate response to the following statements (e.g. NASA's existing education programs are having the desired impact.)
6. With regard to NASA's focus on education programs designed for students, rank Elementary, Middle, High School, College/University in order of highest to lowest priority.
7. With regard to NASA's focus on education programs designed for teachers, rank Elementary, Middle, High School, College/University in order of highest to lowest priority.
8. How should NASA encourage innovation in education projects?
9. What is NASA's most innovative education program?
10. What should NASA's primary goal with regard to education be, and why?
11. What types of programs are most critical to achieving this goal? (Select all that apply)
12. What do you think is NASA's biggest challenge when it comes to developing and implementing education programs?
13. What do you think is NASA's greatest strength with regard to impacting education in the U.S.?
14. Should NASA have standard performance measures that are applied across all education programs?
15. If you were the NASA Administrator, what changes would you make to the NASA Education Program?
16. If you had designed this survey, is there a question you would have asked that is not found here, and how would you answer it?

Appendix D

Experts Consulted

EXTERNAL EXPERTS

Margaret Ashida, Empire State STEM Learning Network Director

Norm Augustine, Chairman and Chief Executive Officer, Lockheed Martin Corporation (retired), Chair, The National Academies Committee on Prospering in the Global Economy of the 21st century

Angela Baber, National Governors Association Center for Best Practices, Senior Policy Analyst

Steve Barkanic, Gates Foundation, Senior STEM Advisor

Claudine Brown, Smithsonian Institution, Education Director

Valerie Caracelli, Government Accountability Office Center for Evaluation Methods and Issues, Applied Research and Methods Team

John Clemons, Raytheon Company, Corporate Director of Community Relations

Kristen Edwards, Einstein Fellow and former Teach for America Teacher

Dr. Alyssa Rulf Fountain and Dr. Abigail Jurist Levy, Abt Associates, Associates

Kumar Garg, Office of Science and Technology Policy, Policy Analyst

Michael Horn, co-author of "Disrupting Class: How Disruptive Innovation Will Change the Way the World Learns"

Rita Karl, Challenger Center for Space Science Education, Director of Education

Louisa Koch, National Oceanic and Atmospheric Administration, Director of Education

Chris Koehler, National Council of Space Grant Directors, Chair and Colorado Space Grant Consortium, Director

Dr. Anita Krishnamurthi, After School Alliance, Director of STEM Policy

Michael Lach, U.S. Department of Education, Special Assistant for Science, Technology, Engineering, and Mathematics Education

Jenay Leach, Einstein Fellow and K-6 General Science and Science Resources Teacher, Virginia

Zipporah Miller, National Science Teachers Association, Associate Executive Director for Professional Programs and Conferences

Dr. Antoinette Mitchell, Trinity Washington University, Interim Dean, School of Education

Dr. David Morgan, Immaculata University, Partnership in Math and Science Project, Principal Investigator

Jan Morrison, Teaching Institute for Excellence in STEM, Executive Director

Dr. Allison Powell, International Association for K-12 Online Learning, Vice President

Jennifer Rinehart, Afterschool Alliance, Vice President of Policy and Research

James Shelton, Department of Education, Assistant Deputy Secretary for Innovation and Improvement

Dr. Stephanie Shipman, Government Accountability Office Center for Evaluation Methods and Issues, Applied Research and Methods Team

Dr. Suzanne Weaver Smith, Kentucky Space Grant Consortium, Director

Dr. Carl Wieman, Office of Science and Technology Policy, Associate Director for Science

INTERNAL EXPERTS

Bill Anderson, Office of Education, Education Portfolio Manager (Retired)

Charles Bolden, NASA Administrator

Dr. Shelley Canright, Office of Education, Manager, Elementary and Secondary Education Programs

Dr. Diane Clayton, Office of Education, Education Project Management Requirements

Diane DeTroye, Office of Education, Space Grant Program Manager

Lori Garver, NASA Deputy Administrator

Jerry Hartman, Exploration Systems Mission Directorate, Education Lead

Dovie Lacy, Office of Education Summer of Innovation, Program Manager

Alan Ladwig, Deputy Associate Administrator for Communications

Rob LaSalvia, Glenn Research Center, NASA Explorer School Program Manager

Dr. Mabel Matthews, Office of Education, Higher Education Program, Manager

Kathy Nado, Exploration Systems Mission Directorate, Participatory Exploration Manager

Dr. Carl Person, Office of Education, Minority Programs Manager

Mary Sladek, Office of Education, Informal Education Manager

Tony Springer, Aeronautics Research Mission Directorate, Education Lead

Stephanie Stockman, Science Mission Directorate, Education and Public Outreach Lead

Jim Stofan, Office of Education, Deputy Associate Administrator for Integration

Alotta Taylor, Space Operations Mission Directorate, Education Lead

Dr. Michele Viotti, Jet Propulsion Laboratory, Mars Education and Outreach Manager

Dr. Brian Yoder, Office of Education, Evaluation Manager

Appendix E Education Design Team

Trish Pengra, Co-Chair, Deputy Associate Administrator, Office of Independent Program and Cost Evaluation, NASA Headquarters

Jim Stofan, Co-Chair, Deputy Associate Administrator for Education Integration, NASA Headquarters

Leland Melvin, (Co-chair from May-September 2010) Associate Administrator for Education, NASA Headquarters

Bill Anderson, Education Portfolio Manager (Retired), Office of Education

Dr. Gregg Buckingham, Deputy Director, Education and External Relations Directorate, Kennedy Space Center

Carmel Conaty, Informal Lead for the Office of Education, Goddard Space Flight Center

Lisa Guerra, NASA Research Fellow at The University of Texas at Austin, Exploration Systems Mission Directorate, NASA Headquarters

Dean Kern, Deputy Education Director, Goddard Space Flight Center

Rob LaSalvia, NASA Explorer School Program Manager, Glenn Research Center

Lori Manthey, Executive Officer, Office of the Director, Glenn Research Center

Kendra Perkins Norwood, Acting Director Legislative Reference and Analysis Division, NASA Headquarters

Dr. Bonita Soley, Social Scientist, Office of Diversity and Equal Opportunity, NASA Headquarters

Stephanie Stockman, Education and Public Outreach Lead, Science Mission Directorate, NASA Headquarters

Tammy Rowan, Education Director, Marshall Space Flight Center*

Carolyn Knowles, Executive Officer, Office of Education*

Mea Miller, Valador Administrative Support for Independent Program and Cost Evaluation, NASA Headquarters*

Shawna Kennedy, Administrative Specialist, NASA Headquarters*

Consulting support services provided by Booz Allen Hamilton

- ▶ Dmitri Reavis
- ▶ Scott Sadlon
- ▶ Sara Rahman
- ▶ Jennifer Haltli
- ▶ Chris Weymont

* Provided support to the Education Design Team.

Endnotes

- ¹ Gonzales, Patrick, Trevor Williams, Leslie Jocelyn, Stephen Roey, David Kastberg and Summer Brenwald. Highlights From TIMSS 2007: Mathematics and Science Achievement of U.S. Fourth and Eighth-Grade Students in an International Context. Publication no. 2009001. National Center for Education Statistics, December 2008. Web.
- ² Fleischman, Howard L., Paul J. Hopstock, Marisa P. Pelczar and Brooke E. Shelley. Highlights from PISA 2009: Performance of U.S. 15-Year-Old Students in Reading, Mathematics, and Science Literacy in an International Context. Publication no. 2011004. National Center for Education Statistics, 7 December 2010. Web.
- ³ National Center for Education Statistics. The Nation's Report Card: Science 2009. Publication no. 2011451. National Center for Education Statistics, 25 January 2011. Web.
- ⁴ "Science and Engineering Indicators 2008." nsf.gov – U.S. National Science Foundation (NSF). January 2008. Web.
- ⁵ Committee on Science, Engineering and Public Policy, National Research Council. *Rising Above the Gathering Storm: Energizing and Employing America for a Brighter Economic Future*. Washington, D.C.: The National Academies Press. 2007. Print.
- ⁶ Committee for the Review and Evaluation of NASA's Precollege Education Program. NASA'S Elementary and Secondary Education Program. Washington, D.C.: The National Academies Press. 2008. Print.
- ⁷ Committee on Science, Engineering, and Public Policy, National Research Council. *Rising Above the Gathering Storm Two Years Later: Accelerating Progress Toward a Brighter Economic Future*. Washington, D.C.: The National Academies Press. 2007. Print.
- ⁸ Committee on Science, Engineering and Public Policy and Thomas Arrison, Rapporteur. *Rising Above the Gathering Storm, Revisited: Rapidly Approaching Category 5*. Washington, D.C.: The National Academies Press. 2009. Print.
- ⁹ Christensen, Clayton M., Michael B. Horn and Curtis W. Johnson. *Disrupting Class: How Disruptive Innovation Will Change the Way the World Learns*. New York: McGraw-Hill, 2008. Print.
- ¹⁰ President's Council of Advisors on Science and Technology. Prepare and Inspire: K-12 Education in Science, Technology, Engineering, and Math (STEM) for America's Future. Washington: U.S. Government Printing Office, 2010. Print.
- ¹¹ Morrison, Jan, Merrilea Mayo and Raymond V. Bartlett. NASA Engagement in STEM Education: Innovation in Education for Sustainable Achievement. Baltimore, Maryland: Teaching Institute for Excellence in Stem. 2009.
- ¹² National Aeronautics and Space Administration, Program Analysis and Evaluation. *A Review of the NASA Education Program: Education Team Report*. August 2005.

¹³ Committee for the Review and Evaluation. [...]

¹⁴ United States. Cong. House of Representatives. 110th Congress. *H.R. 2272, America COMPETES Act* [introduced in the U.S. House of Representatives; 10 May 2007]. 106th Cong., Library of Congress. Web.

¹⁵ United States. Cong. Senate. 111th Congress. *S.3729, National Aeronautics and Space Administration Authorization Act of 2010* [introduced in the U.S. Senate; 5 August 2010]. 111th Cong., Library of Congress. Web.

¹⁶ United States. Cong. House of Representatives. 111th Congress. *H.R. 5781, National Aeronautics and Space Administration Authorization Act of 2010* [introduced in the U.S. House of Representatives; 7 July 2010]. 111th Cong., Library of Congress. Web.

¹⁷ Memorandum for the Record: Markup of the NASA 2011 Authorization Bill, Executive Session of the Senate, Commerce, Science and Transportation Committee, 5136, 111th Cong., Library of Congress (2010). Print.

¹⁸ The One Stop Shopping Initiative is an innovative, mission-enabling, NASA-wide approach to communicating and providing students at all institutions of higher education access to a portfolio of internship, fellowship, and scholarship opportunities offered by NASA Mission Directorates and Centers. The One Stop Shopping Initiative enables eligible students to access opportunities through a single portal (intern.nasa.gov) and single application.

¹⁹ Committee for the Review and Evaluation. [...]

²⁰ Committee on Learning Science in Informal Environments, National Research Council. *Learning Science in Informal Environments: People, Places, and Pursuits*. Washington, D.C.: The National Academies Press. 2009. Print.

²¹ Morrison

National Aeronautics and Space Administration

NASA Headquarters
300 E Street Southwest
Washington, D.C. 20546-0001
www.nasa.gov/centers/hq

www.nasa.gov