

Libraries for All!

How to Start and Run a Basic Library

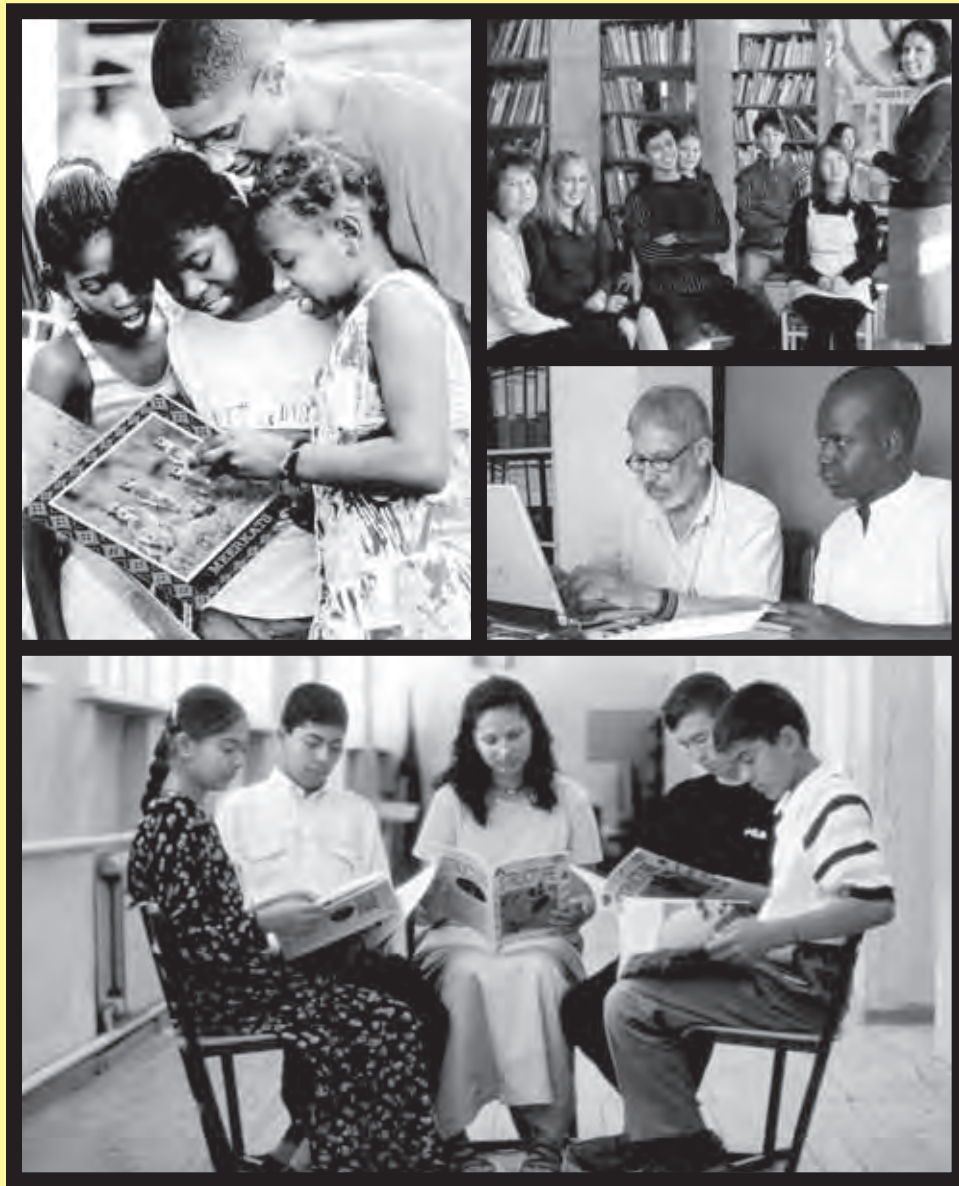

Information Collection and Exchange
Publication No. RE035

Information Collection and Exchange

The Peace Corps Information Collection and Exchange (ICE), a unit of the Office of Overseas Programming and Training Support (OPATS), makes available the strategies and technologies developed by Peace Corps Volunteers, their co-workers, and their counterparts to development organizations and workers who might find them useful. ICE works with Peace Corps technical and training specialists to identify and develop information of all kinds to support Volunteers and overseas staff. ICE also collects and disseminates training guides, curricula, lesson plans, project reports, manuals, and other Peace Corps-generated materials developed in the field. Some materials are reprinted “as is”; others provide a source of field-based information for the production of manuals or for research in particular program areas. Materials that you submit to ICE become part of the Peace Corps’ larger contribution to development.

This publication was reprinted by the Peace Corps with the permission of UNESCO (United Nations Educational, Scientific and Cultural Organization) - General Information Programme and UNISIST. It is distributed through the ICE unit. For further information about ICE materials (periodicals, books, videos, etc.) and information services, or for additional copies of this title, please contact ICE and refer to the ICE catalog number that appears on the publication.

Peace Corps

Office of Overseas Programming and Training Support

Information Collection and Exchange

1111 20th Street, NW, Sixth Floor

Washington, DC 20526

tel.: 202.692.2640

fax.: 202.692.2641

Abridged Dewey Decimal Classification (DDC) Number: 025.007

Share Your Experience!

Add your experience to the ICE Resource Center. Send your materials to us so we can share them with other development workers. Your technical insights serve as the basis for the generation of ICE materials, reprints, and training materials. They also ensure that ICE is providing the most up-to-date innovative problem-solving techniques and information available to you and your fellow development workers.

Libraries for All!

How to Start and Run a Basic Library

by Laura Wendell

Reprinted with the permission of UNESCO
(United Nations Educational, Scientific and Cultural Organization)
General Information Programme and UNISIST

Peace Corps
2004



Information Collection and Exchange
Publication No. RE035

Reprinted January 2009

TABLE OF CONTENTS

Table of Figures	iii
Preface: Who is this Manual for and What is it All About?.....	iv
How to Use This Book.....	iv
Peace Corps Book Donation Policy	vi
Introduction: Does your Community Really Need a Library?.....	1
Creating a Library Committee	5
Section one: How do we Set Up the Library?.....	8
Initial Location.....	8
Getting Materials	8
Networking	12
Some Facts About Book Donation Programs	16
Budgeting.....	18
Raising Funds.....	19
Bookkeeping	22
Buying Books.....	25
Recruiting a Librarian.....	27
Making the rules	29
Section two: How do we Manage the Library?	31
Librarian Training	31
Community Involvement	32
Organising the Materials.....	38
Creating Your Own System for Sorting Books.....	39
Making the Shelf List.....	42
Using the Dewey Decimal System	50
Labelling	54
Advanced Organising Ideas	57
Circulation.....	59
Inventory	63
Weeding	63
Computers.....	64
Controlling Theft	66
Taking Care of the Books	68
Evaluation	70
Expansion.....	72
Key Words.....	78
Resource Guide.....	80
Book Donation Programs.....	80
Funding	94

Library Associations and Networks	97
Publisher's Associations and Networks	107
Training	110
Other Services	115
Bibliography	123
Library Manuals	123
Guides to Book Donation Programs	128
Further Reading	130

TABLE OF FIGURES

<i>Figure 1: Sample book plate</i>	12
<i>Figure 2: Sample budget</i>	18
<i>Figure 3: Sample balance sheet</i>	24
<i>Figure 4: Sample receipt</i>	24
<i>Figure 5: Browser box</i>	35
<i>Figure 6: Sample shelf list notebook</i>	44
<i>Figure 7: Sample shelf list card</i>	45
<i>Figure 8: Arranging book cards</i>	46
<i>Figure 9: Making sections</i>	47
<i>Figure 10: Sample card for a fiction book</i>	48
<i>Figure 11: Boxes for pamphlets and other materials</i>	49
<i>Figure 12: Vertical files</i>	49
<i>Figure 13: Sample periodical card</i>	50
<i>Figure 14: Sample DDC card</i>	53
<i>Figure 15: Sample DDC subject index cards</i>	53
<i>Figure 16: Labelling the books</i>	55
<i>Figure 17: Labelling the shelves</i>	56
<i>Figure 18: Sample subject index cards for home-made categories</i>	56
<i>Figure 19: Sample cards for related words</i>	57
<i>Figure 20: Additional subject cards</i>	58
<i>Figure 21: Sample subject, author and title cards</i>	59
<i>Figure 22: Sample circulation notebook</i>	60
<i>Figure 23: Sample borrowing card</i>	62
<i>Figure 24: Book with card pocket and due date slip</i>	62
<i>Figure 25: How to cover books</i>	68
<i>Figure 26: Protecting shelves from insects</i>	69
<i>Figure 27: How to repair books</i>	70
<i>Figure 28: Saving space with double-sided shelves</i>	73
<i>Figure 29: Sample floor plan</i>	75
<i>Figure 30: Adjustable shelves</i>	76

PREFACE: WHO IS THIS MANUAL FOR AND WHAT IS IT ALL ABOUT?

This book is for community leaders, librarians, library committees, volunteers, aid workers and others who are interested in the practical aspect of starting and maintaining a successful library. Throughout the developing world, countless dedicated people respond to the pressing need for information in their communities by helping to start a library. They often have no formal training in library science and overcome enormous difficulties to establish collections of resources that enrich their communities. This book is a practical guide to help communities meet the challenges of setting up and running a library. It was inspired by my own experiences setting up a library with a community in West Africa and shaped by letters from hundreds of other aid workers and community librarians from around the globe. First-hand experience with the frustrations, challenges and rewards of setting up a library has given me a deep sense of respect for and solidarity with community librarians facing similar challenges. Like many of them, I am not a librarian by training and had to be very resourceful in seeking help and advice, which I have been fortunate to receive from many people and organisations.

This book was made possible by funding from the UNESCO Network of Associated Libraries (UNAL), which is dedicated to promoting international co-operation and understanding between libraries (see the *Resource Guide* at the back of this book for more information about UNAL). I would like to thank Joie Springer at UNAL for her invaluable help during this project. The book was written at the World Library Partnership (WLP) headquarters with much support and guidance from the board of directors. I would like to give special thanks to WLP President Peggy Hull for reviewing several versions of the manuscript.

To ensure that the information in this book has the widest possible relevance, it has been reviewed and field tested in eleven countries. I would like to thank the following reviewers for their insightful comments: Dr. Kingo Mchombu of the University of Namibia, Margaret Myers, U.S. Peace Corps Volunteer working with the National Library Service of Botswana, Carol Priestley of INASP (see the bibliography) and various staff at the UNESCO Division of Information and Informatics. I also want to express my sincere gratitude to Gail Wadsworth for her ongoing mentoring throughout this and many other projects. Her extensive comments in red ink helped me to develop many of the book's finer points. The following field testers provided critical feedback from the book's target audience: Midekeasa Degaga, Christopher Frederick, Sister Frances Kersjes, Roberta Overman, Pheny Birungi and Sam Werberger. I would also like to thank Norbert Adewuho for the honour of working with him on the Yikpa Community Library project. Finally, thank you to my husband for his loving support and skilful editing.

HOW TO USE THIS BOOK

The introduction to this manual focuses on specific issues that the community and the library founder(s) need to address before establishing a library. The second and third sections focus on establishing and managing a library. Each section is divided into several parts. There is a list of "action steps" at the end of each part summarising what needs to be done at each stage of planning and running a library. It is best to read

through the entire manual once before carrying out the action steps for each part. It may be helpful to set a target date for completing each action step and make a list of who is responsible for each task.

At the back of this book, there is a *Resource Guide* listing programs that can assist communities, library committees and librarians to carry out the action steps and manage their libraries. References in the text point readers to sections of the *Resource Guide* that are particularly relevant for each part of the manual. Although most technical terms are explained in the text, there is a list of key words at the end of the manual immediately preceding the *Resource Guide*.

Laura Wendell
The World Library Partnership

PEACE CORPS BOOK DONATIONS POLICY

The Peace Corps Office of Private Sector Initiatives (OPSI) is responsible for coordinating the acceptance of all gifts to the Peace Corps. Gift acceptance authority is subject to legal restrictions which limit who can solicit gifts on behalf of the Peace Corps. ***Volunteers are not authorized to solicit book donations for the Peace Corps.*** Volunteers may contact book donor organizations and discuss possible donations. However, if an organization wishes to make a donation to Peace Corps, rather than directly to the community, volunteers should contact their country director (CD) before any book donation takes place. The CD will contact OPSI. OPSI helps to facilitate in-kind donations to Peace Corps posts. OPSI coordinates with CDs, who have the authority to accept or reject donations. All donations to Peace Corps must support Peace Corps programming. OPSI facilitates the signing of an in-kind donation agreement between the CD and the donor.

The Peace Corps cannot incur costs by accepting an in-kind donation. Thus, the donor must pay for, or arrange payment for, shipping and any customs fees associated with a donation. Each in-kind donation agreement stipulates this. Book donations are shipped to the country director. Books can only be shipped after the agreement is signed.

Many book donors do not have in-kind donation agreements with the Peace Corps. Volunteers should not contact these organizations to request donations on behalf of the Peace Corps. Volunteers are encouraged to work with counterparts to request books from these organizations. Counterparts may contact these organizations on behalf of the local library. Shipments will be sent directly to the counterpart or other designated host country national.

For additional, up-to-date information on book donations, contact the Information Resource Center (IRC) manager in the Peace Corps office in-country for a copy of *Sources of Donated Books*, produced by Peace Corps Information Collection and Exchange (ICE) for use by Peace Corps Volunteers. Request ICE publication No. RE003.

INTRODUCTION: DOES YOUR COMMUNITY REALLY NEED A LIBRARY?

Those of you working in established libraries may be tempted to skip this section. However, if you are having problems with community support and involvement, you might find some good ideas here (and under *Community Involvement* below). This chapter can help you rethink your library service, and if necessary, make plans to change it or even shut it down.

How can those of you who are thinking about establishing a library decide if your community really needs one? You can start by making a list of the information resources already available in your community. Your list might include newspapers, radio, community centres, or television. People are also great resources and your list should include people who provide the community with information. They could be taxi drivers or merchants who bring in news from other towns, nurses, pharmacists, older community members, extension agents, successful farmers, religious leaders, healers or anyone whose opinions are generally respected. Ask community members who they go to with questions about health, agriculture, sewing, child care or family problems. The answers may differ for older and younger people, men and women, and/or richer and poorer people. Remember that people with different educational, ethnic and religious backgrounds may also go to different people for help and advice. Be sure to talk with a variety of people to get a complete picture of the information resources in your community. Your community information resource list could be the first item for the new library!

The next step is to find out if the information resources you have discovered are meeting the community's needs. If people are generally satisfied with the information available to them, they may not see the point of a library. Often, however, people do want and need additional information that they cannot get from the existing resources. Sometimes they want *specialised* information, such as the plans for a composting latrine or a solar food drier, or *specific* information, such as the books required by an official school curriculum. They may also want entertaining books about other people, places and times (see the list of the advantages of a library below).

Some people may want new information resources because they feel excluded from the existing ones. For example, women may feel excluded from learning about current affairs if men gather to listen to the news on the radio while women are busy preparing meals. Someone who cannot afford a newspaper might also feel excluded. A library can make information available to everyone. If there are people in your community who want information that they cannot currently get, then a library could be a great way to meet their needs. Some of these people could be children who need storybooks, literacy students who need basic reading material, extension agents or professionals who need technical information, or students and teachers who need textbooks.

Once you have determined that people in your community want and need more information, the next step is to make sure that they understand what a library is, how it works and how it can benefit them. People who have never used a library may not know all the ways it could help them to get the information they need. Some people may be

confused about the difference between a library and a bookshop. Others may think that library books belong to the librarian, not the community, and/or that they can only be used by certain people, such as teachers or professionals. You may need to explain the idea of borrowing and returning books (see *Making the Rules* below) or other aspects of how the library works.

Your first step in educating the community about the library could be to discuss it with some of the people it will benefit most directly, such as students, teachers, literacy classes and professionals. Many of them may have used a library at their school, agency or in another town. Those who have not may be quick to embrace the idea once you explain it to them. Ask them to help you promote the library by talking to parents, friends and colleagues about the idea.

If your community has a development committee, or other group that handles decisions about what projects get done in the community, be sure to talk to them about the library right from the start. You will need their help. The library will compete with other projects for space, money, time and resources. If the people who decide how those resources are used do not support the library, you will have a very hard time completing the project.

One good way to demonstrate what a library is and build community support for the project is to create a public display. Get together a few interesting books (you may even be able to borrow some from community members or bookshops) and display them on a shelf in a local shop, church, classroom or other public space. Ask the person responsible for that space to point out the books to people. You can post information about the proposed library near the books with a note to contact you for more information. When people ask what the books are for, explain that these are samples of books they might find in a library. Go on to explain that a library is a place where people can find books that will help them with their studies or jobs, or to read for entertainment. The books in a library are not for sale; they belong to the community and people either read them in the library or borrow them to read at home.

After most people have had a chance to look at the books, call a meeting to get the community involved in planning the library. Ask several people to help you organise the meeting and/or share their thoughts about the project. It is important that the community thinks of the library as “our project” not as “your project.” Involving others right from the beginning is the best way to make this happen. At the meeting, start by explaining that the purpose of the library is to provide information and services to the community. Even people who have seen the books on display may still be unclear about how a library works. Explain that it is a place where people can read, study and research. It can also be a place for classes, story telling, exchanging news and other information. Librarians provide services such as help using the library, answers to technical questions and/or information about jobs, resources and education programs. Libraries can also collect and preserve traditional stories and knowledge. Community members may be able to borrow the books to make reading more convenient. You can use a skit, song, poem or puppet show to demonstrate how a library works.

During your meeting, give examples of the information and services the library could

offer. If you have found that some people are dissatisfied with the current information resources in the community, or are not able to use those resources, be sure to bring that up. Point out that the library may be able to serve their needs by lending them books, or through special programs. Emphasise that a library, like a well, is a shared resource that benefits the whole community. Invite people to discuss how they would use the library, the books they would like and any concerns, questions or objections they have.

Here are some of the advantages of a library that you might mention at the meeting:

- The library will help students do better in school.
- It will give literacy students books to practice reading.
- It will bring new information and knowledge into the community.
- It can preserve the traditions, stories, music and ideas of the community.
- It will be a quiet place to study or hold adult education classes.
- It will give extension workers, health care providers and other professionals technical information to help them do their jobs better.
- It will be a source of entertainment.

It may take several weeks, months or longer to explain the library to the entire community, but your efforts will be well rewarded. Talking with individuals and community groups about the library will give you the chance to build awareness and support for the project and identify potential obstacles and problems. Only a well-informed community can make a responsible decision about starting a library. Taking the time in the beginning to make sure that as many people as possible know about the project will also make it easier to publicise the library once it is open.

If, after explaining and promoting the library, you find that there is a lot of community support for the project, your next step is to find out how high a priority the library is for the community. So many communities lack running water, health facilities, schools, latrines and other basic needs that many people, even the ones who really want more information, might prefer to spend their time working on these projects instead of a library. Make a list of a few projects, including the library, and ask people to rank them in order of importance. Different groups within the community may have different priorities, and it is important to get the opinions of a wide variety of people. The manual *Participatory Analysis for Community Action (PACA) Training Manual* (see bibliography) describes several good tools you can use to help groups reach a consensus on their priorities and discuss them with other groups. If most people think that other community projects are more important than the library, you might want to postpone the project. Otherwise, you may not be able to get the funds and volunteers you need. A library belongs to and serves the community and will only be successful with strong community support.

If community support for the library is not very great or the key officials are against it, there may be good reasons for their concern. Compared to many other projects, libraries are a lot of work. Unlike a latrine, which requires only basic maintenance after it is built, a library requires constant upkeep. If there are no funds available to hire a librarian, volunteers must be recruited to run the library (see *Recruiting a Librarian*). They may

have to sacrifice other activities to do this. School officials may not want their teachers spending valuable time in the library. Others may fear that the library will turn people away from traditional information sources, such as government, religious and community leaders. New books must be purchased every year and the old ones repaired or people will quickly lose interest in the library. This may take funds away from other projects. You must look long and hard at these possible negative consequences of building the library. If you cannot find a solution to them, or encounter a lot of resistance to the project, you may want to consider alternatives to a traditional library.

If you decide that creating a true library is not practical, or if you are considering shutting an existing library due to lack of support, what can you do? One answer is to distribute resources throughout the community. Since the purpose of a library is to support education and learning, it makes sense to put books in the hands of the people who are working in these fields. Instead of having a central library open to the public, you may want to create specialised “mini-libraries” throughout the community. For example, you might give health books to the head of the clinic, textbooks to teachers, religious books to the church, etc. You can ask a local restaurant, bar or shopkeeper if you can put the fiction books on a shelf for their clients to read. Emphasise that this may improve business. Distributing the library will at least get the books off the shelves and into the hands of a few people.

Another way to bring books to the community without starting a formal library is to participate in a book box or mobile library program co-ordinated by a library in another community. In a book box program, a library lends a community a box of 50 or so books. The community exchanges the box periodically for a new one. In a mobile library program, books are brought to the community by a book cart, van, truck, bicycle or other form of transportation. This “mobile library” visits the community regularly to lend out and pick up books. Either of these programs can be a great way to get information to the community and promote an interest in reading without starting a formal library.

Action steps:

1. Find out what information resources your community already has.
2. Find out if people are satisfied with these resources.
3. If possible, organise a visit to another successful library.
4. Promote the library by discussing it with community members and leaders.
5. If desired, create a display to demonstrate how the library will benefit the community.
6. Hold a community meeting to explain the advantages of the library and to get people’s reactions.
7. Find out how high a priority the library is for community members in relation to other projects.
8. Decide if you have enough community support to justify continuing with the library.

CREATING A LIBRARY COMMITTEE

Once you have community support for the library, you will need to form a library committee to help you work out a plan. The committee should represent the people the library will serve. It could include teachers, students, professionals, aid workers, community leaders, and others who have an interest in the library. While it is good to have some community leaders on the committee because they add credibility to the project and help to get things done, be sure to also include students, mothers, elderly people and others whom you want to encourage to use the library. They need to have a voice on the committee to ensure that their needs will not be overlooked. It is also a good idea to invite the people who oppose the library to join the committee, or at least to attend the meetings. They may have valid concerns and their participation will make the project better.

You should also consider inviting a government official to advise or serve on the committee. At the very least, you should be aware of the government regulations concerning libraries and the government agencies that could help you. If there is a local or regional government library service, they may be able to give you funding, training, books or other support, especially if you include them in your plans right from the start. Similarly, government agencies concerned with education and publishing may be able to help with resources and training. Sometimes, however, working with government agencies can cause delays and a loss of local control over the project. Be sure to bring up these concerns with any officials who get involved and request that the project use local labour and involve community members whenever possible. If this is not the usual policy, point out that community involvement will make the library more successful and sustainable because people are more likely to use and take care of a library they help to plan and build.

Once the committee is formed, you need to decide how you want to structure it. In most committees, the members elect officers: president (sometimes called the chairperson), vice president, secretary and treasurer. The offices may be for one or more years, and one of your first tasks should be to decide the length of time (term) of each office. Setting terms makes it possible to honour people who are doing a good job by re-electing them, and allows people to leave office gracefully when they no longer wish to serve. It also ensures that the officers change regularly, which gives more people a chance to serve. Here are some basic “job descriptions” for the different offices:

The President – is the chief officer of the committee. He or she runs the meetings, decides on the agenda and keeps order. The president should make sure that discussions keep to the point and that everyone has a chance to participate. He or she *works with* the committee to set policies, recruit librarians, make reports and oversee the finances of the library.

The Vice President – takes over for the president when he or she is not there and does any other duties assigned by the committee.

The Secretary – keeps notes on what happens at all the meetings. These should include who was present, what was discussed and any decisions that were made. He or she should be able to write clearly and summarise discussions.

The Treasurer – is responsible for the library’s finances. He or she distributes funds according to the decisions of the committee and should report all income or expenses to the committee (for more information, see *Bookkeeping* below).

This committee structure is somewhat rigid, but it has the advantage of clearly defining responsibilities. It is helpful to have written descriptions of the different offices so that everyone understands their role. Your committee can adapt or expand the above descriptions as needed. If this committee structure doesn’t work for your community, you can make it more flexible by rotating who runs each meeting and who keeps notes. It is not recommended, however, to rotate the office of the treasurer because keeping track of the accounts requires consistent attention over time. If the person responsible changes often, confusion may result and money could be misplaced or mishandled.

Regardless of the committee structure you choose, it is wise to have a set of written guidelines that describe how the committee works. Sometimes these guidelines are called a constitution or bylaws. Their purpose is to make sure that the committee does things in a consistent and fair way. Here is a list of things to consider when writing the guidelines:

- How many people should serve on the committee? It is fine to give a general range, such as 12-15.
- How will members be selected for the committee? Will the whole community elect them or will they be chosen by someone? Sometimes, the initial leaders of the library project choose or appoint the first committee members who then elect other members. If there are certain people you want to always be on the committee, like the librarian, head of the school, president of the community development committee or others, include that in the guidelines.
- How will decisions be made? Will you try to reach a solution everyone agrees on (a consensus) or will you discuss different viewpoints and then vote? Each method has advantages and disadvantages. Deciding by consensus ensures that everyone agrees, but it may take a very long time, and in some cases, it may not be possible. Voting is quick, but people on the losing side may feel dissatisfied.
- How many members of the committee need to be present at a meeting for a decision to be official? This number is called a quorum and it is usually at least half the members plus one. It is important to decide this number because you don’t want only one or two members to be able to make decisions for the whole committee. Pick a number that seems reasonable. If you require too many members to be present, you may never have enough to make an official decision. If you require too few to be present, a small group may end up making all the decisions.

- Under what circumstances will members be asked to leave the committee? For example, you might decide that people who miss three meetings in a row will be expelled.
- Finally, how will changes be made to the committee guidelines? These rules are not meant to be absolute laws. Leaving outdated or unpractical rules in the guidelines can lead to arguments and confusion, so be sure to have a procedure for making changes.

Establishing a library committee and writing the guidelines are major steps toward making the library a success! Having a committee ensures that the library will reflect the needs of the community, and writing guidelines ensures that the committee has clear rules for action.

Action steps:

1. Discuss all the different kinds of people the library will serve and how you can involve them in the committee.
2. Decide how the committee will be structured and the first members selected.
3. Form the committee.
4. Write “job descriptions” for the officers.
5. Write guidelines for committee action.
6. Select the officers according to the guidelines.

SECTION ONE: HOW DO WE SET UP THE LIBRARY?

Each of the following sections begins with an important “decision point” for the committee to discuss. This is followed by some ideas to help focus and guide your discussion. “Action steps,” like those at the end of the previous sections, summarise what needs to be done by the committee at each stage of setting up a library.

INITIAL LOCATION

Decision point: Should we start out with a new building or use an existing one?

It is wise to start out by locating the library in an existing building. It generally takes at least a year to raise money, plan and construct a building. During this time, people may start to lose interest in the project. By starting small, you can show people how the library works and gain their support and confidence before expanding. Even a single shelf in the corner of a classroom or shop is enough to get started. Choose a place that is easy to find near the centre of the community. If possible, locate the library in a secure place (locks on doors and windows or shutters).

Many places can be good first locations for the library. Shops and restaurants can be great because there is always someone around to look after the books. They also increase the library’s visibility in the community. A library in a storage room or office will be quieter and may have more room, but someone will have to take time out from other activities to open it, and it may be harder to publicise. If you choose to locate the library in a classroom, be sure to make it clear to everyone that the books belong to the whole school or community and not just the teacher who uses the classroom. If other activities, such as classes, church services or meetings routinely take place where the library is located, this will cut down the amount of time that it is open to the public. However, these activities may help to raise awareness of the library. If the space you decide on is being rented by someone, be sure to get permission from the owner as well as the tenant. If at all possible, choose a place with room for later expansion (see *Expansion* below).

The amount and type of furniture and shelves you will need depends on the location you choose. A shop or classroom may already have bookshelves and furniture. A storage room probably will not. For more information about buildings, furniture, equipment and other important considerations in planning your library, see *Expansion* below.

Action steps:

1. Talk with teachers, religious leaders, shopkeepers and others about hosting the library.
2. Visit all the potential locations for the library.
3. Choose the best location.

GETTING MATERIALS

This section discusses what materials you need for the library and how to get them. Materials can include books, tapes, posters, magazines, pamphlets newspapers, newsletters, games, teaching aids, videos, maps and other items. Since the vast majority of the materials in the library will be books, however, this section focuses primarily

on them. You can use most of the techniques described (especially networking) for collecting other materials as well. Also see *Involving the Community* a below for suggestions on repackaging and creating your own materials.

Decision point: what kind of books do we need?

You need to get books on subjects of interest to the community. Your first task, therefore, is to find out what people want to know. You may have already thought about this issue when trying to decide if the community needs a library. Now is the time to think about it in more depth. Since the committee is made up of community members, you can start out by asking yourselves what books should go in the library. But that is not enough. You need to go out into the community and ask people what books they want. What are they interested in academically, professionally and personally? Talk to a wide variety of people and try to find potential library users you may have overlooked, such as people with illnesses or disabilities.

If your library is focused on a topic, such as health, or serves a restricted community, such as an elementary school, you may be tempted to skip this step. Don't. You can really learn a lot by asking people what books they want in the library. For example, you might not think of putting books on animal care in a health library, but a farmer might. Since keeping the community animals healthy can lead to better nutrition and sanitation for the people, including those books is a good idea.

Some other things you need to consider are the reading levels and languages of the library users. How many years of formal education do most people in the community have? How many of your library users are children? How many are literacy students? How can you encourage people who cannot read to use the library? Can you get picture books, books on tape or other materials for non-readers? What languages do people in your community speak? People often prefer reading in the "local language" or vernacular to reading in the national language. Some community members may *only* speak/read the local language. If local language materials are scarce, the library should consider translating, repackaging or producing materials (see *Involving the Community* below).

Once you have made a list of all the subjects, languages and reading levels you need, the next step is to rank them according to their importance. Since you probably cannot get every book that someone wants or needs, you will have to decide which ones come first. Start by getting general books on the most popular topics before getting more specialised materials. This will help you create a broad collection that appeals to most people. If your library users are mainly students, you could start with a complete set of school textbooks. Reference books such as dictionaries, atlases, encyclopaedias and almanacs are expensive, but contain very useful general information. For novels and other fiction, start with children's books, young adult fiction and basic readers before moving on to advanced works that fewer people can read. Newspapers and magazines (also called periodicals) are often the most popular resources in the library. Be sure to keep a list of all the suggestions so you can work on filling them over time.

You should use the information you have gathered to write a “collection policy” that states the purpose of your library, whom it serves and the types of materials it collects. Many people may be involved in getting books for the library and such a policy will ensure that everyone knows which materials are most important to collect. It may also stop them from accepting unwanted or inappropriate books. Sharing the policy with book donors will help them to understand your needs and make more useful donations. The policy should be reviewed and approved by the whole library committee. You can also ask library users and community members to read and comment on it. Remember that it can be changed later on as the library grows, and in fact, it is a good idea to review it every year or two.

It is particularly important to try to gather materials that contain a variety of viewpoints to the extent that this is culturally appropriate. For example, if your library contains a political commentary about the United States that was published by the U.S. government, you might also want to include commentaries by non-governmental sources or people living in other countries to give your users several viewpoints. Providing information from a variety of sources is particularly important for religious, cultural, political and social commentaries because these works sometimes express the viewpoint of only one group or individual. These topics, however, can be very sensitive, and libraries should find out if there are any government regulations regarding what materials they can collect before they begin seeking donations.

Action steps:

1. Find out the interests and reading levels of the community members the library will serve.
2. Decide which books to focus on collecting.
3. Write a collection policy describing what materials the library would like and what materials it cannot use. Include what the library does with donations that are not suitable for the collection (see below).

Decision point: How can we get books?

Most developing world libraries contain a mixture of books that were donated and books that were purchased. This section addresses donated books and the next sections discuss fundraising and buying books. When reading this section, keep in mind that you do not have to accept every book that someone offers to donate. Use the collection policy you wrote in the previous section to explain to donors what books you need. Before adding any book to the library, check to make sure that it is accurate and up to date, in good condition, on a topic of interest to the community, presents a balanced viewpoint and uses an appropriate reading level. When someone offers to donate an unsuitable book, explain firmly but gently why you cannot accept it. People may be surprised to learn that the library has a collection policy, but they are usually happy to follow it once they know.

Some libraries accept all donations but sell the books they cannot use. It is best to tell donors up front if the library might not keep their books. You could include a statement

in your collection policy saying that the library cannot guarantee that every donation will become a permanent part of the library. Some donors (especially international charities) may not want you to sell the books they donate. In that case, it is especially important to be clear about what books you need.

The first place that you should look for book donors is within your own community. Are there school teachers, professionals, church leaders or other members of the community who have books they would be willing to donate to the library? You can find out by holding a book drive. There are many different ways to organise a book drive. Most involve setting aside a special day to collect donations from the community. Here is a list of ideas and incentives you can use to motivate and/or thank book donors:

- Have volunteers go from door to door asking for books. This is a lot of work for the volunteers but very convenient for the donors. It is also a great way to tell people more about the project and build a sense of community participation.
- Set up a book collection booth in the marketplace. Use musicians, dancers, colourful signs or other methods to get people's attention.
- Designate several places around the town where people can drop off book donations (this could go on for several days).
- Ask a religious congregation, community organisation or club to collect books for the library.
- Have a party at the library just for people who donate books.
- Give small prizes to book donors. These could be very inexpensive things like book marks made from cloth, paper, bamboo, braided string or other materials. You may need to make a lot of them, so get volunteers to help.
- Give each donor the chance to win a prize. See the instructions for raffles under *Raising Funds* below.
- Thank book donors by writing their names inside the books they donate. A nice way to do this is by using "book plates," which are paper labels you fill out and glue onto a blank page. If making or buying book plates is not possible, you can make a rubber stamp saying "This book was donated by..." or simply ask someone with attractive handwriting to write the donor's name in the book.

Figure 1: Sample book plate

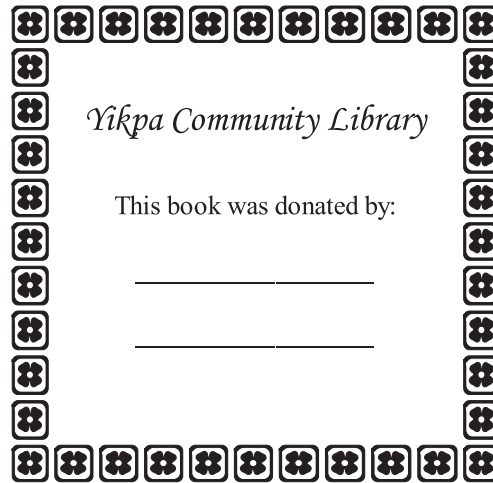

No matter how you organise it, the key to a successful book drive is publicity. Be sure to tell people weeks in advance about the book drive and any prizes or rewards you will give away. Then remind them often. Here are some ways you can publicise the book drive:

- Announce it in all the neighbourhoods of the community and/or the market.
- Ask teachers to announce it at school and/or send notes home for parents.
- Ask religious leaders to mention it at services.
- Put up posters or notices (these should be colourful and very clearly written).
- Announce it in the newspaper or on the radio.
- Send out special invitations to people who may have a lot of books to give.

A successful book drive will demonstrate to book donors from outside the community that the community really cares about the library. Be sure to remind people that they benefit twice by donating to the library – they get the pleasure of reading the books they donated in the library and the pleasure of sharing them with others!

NETWORKING

By holding the book drive and forming the library committee, you have already prepared the way for the next step in getting book donations – networking. Networking means finding and contacting people and organisations that can help the library. You should start by making a list of all the people in your own community who have connections to organisations that publish materials on interesting subjects (see the list below for examples of organisations). Ask them to request a donation from their organisation on behalf of the library. If they are unable to help, ask if there is someone else in the organisation you could talk with. Also ask if they can suggest other organisations that could donate books.

As you search for book donations, be sure to find out about other ways the organisations you contact could help the library (e.g. training, funding, advice or more contacts).

Networking is like a squash vine – it starts out with one or two shoots but soon covers the whole garden. If everyone on the committee makes a few contacts, you will soon have supporters covering the area.

Eventually, your networking will lead you to connections outside the community. You may hear about organisations in the next town or a distant city that have materials you need. If at all possible, arrange for a representative from the community to visit these organisations in person to request books. Visiting them makes it possible to look at their materials and select what the library needs.

The representative could be a member of the library committee, a community member who now lives in another town, a foreign aid worker or extension agent (such as a Peace Corps or United Nations volunteer – see below), a taxi driver, a merchant or anyone else who travels often. Give the representative a copy of the collection policy and make sure that he or she can explain the project clearly and knows exactly what materials are needed. He or she may have to choose from a variety of publications and should know enough about the library to make good decisions. Though it may be tempting to take whatever an organisation has to offer, the representative should leave behind materials that are clearly useless for the library (damaged, old, incompatible language, reading level or subject). You do not want to waste valuable shelf space on useless books! That will only discourage people from using the library.

Writing to an organisation to ask for a list of their publications before going to visit can save time and money. There is no point in visiting an organisation that does not have any materials you need. In the letter, be sure to explain that the materials are for a library and that you would like them to be donated. Ask them to include a list of prices if donations are not possible. Also ask for some general information about their organisation. Pamphlets and brochures about different organisations are a great thing to keep in the library.

The following list of groups that could help your library will give you some ideas to guide your networking:

Other libraries – ask them where they got their books. One of the first things you should do once you decide to start a library is talk with other librarians to get their advice. They have faced many of the same challenges that you are now facing and can give you a lot of help and support. By sharing contacts, you can help each other build stronger libraries and lay the groundwork for collaboration. Almost all countries have a national library and the librarian there should be able to tell you about government services for libraries, such as the national library service (if your country has one). Also contact any school or public libraries in your area.

Non-governmental organisations (NGOs) – these are also called aid, non-profit or relief organisations. They can be local, regional, national, or international. Their programs usually specialise in one or two areas such as health, women in development, education, agriculture, the environment or other development issues. Literacy programs may be particularly helpful for libraries. There is a lot of variety in the scope and focus of NGOs, as well as their budgets. Many NGOs publish materials designed for extension workers

and community volunteers. They will often give free copies to a library. Some NGOs even have library support programs and may offer books and training. Others have their own libraries that you should visit. Ask the librarians for information about free materials they have received from other NGOs and book donation programs. See the *Resource Guide* at the back of this manual for more information about organisations supporting libraries.

Government branches – these can be called ministries, departments, agencies, services, councils, commissions or other names. They can be local, regional and/or national. Many government branches publish free materials. They may each have their own information offices or publication units or there may be a central government printing office. Sometimes the printing office produces a catalogue from which you can order the materials you want. Government extension agents or other government employees should be able to help you get the materials you need, but remember that they may not be aware of publications produced by other branches of the government. If you don't get what you need from one branch, it is a good idea to try another.

Foreign governmental agencies – The governments of most developed countries have foreign aid programs that fund a wide variety of projects. A lot of foreign aid money goes directly to developing world governments, but some of it also goes to NGOs and grass-roots projects. Foreign government programs such as Peace Corps (United States) and Voluntary Service Overseas (Britain) send trained volunteers to live and work in a developing country. These volunteers can be a great source of information about NGOs, government programs, book donation and their home countries. These organisations generally have an office in the capital, but the volunteers may be posted in communities throughout the country.

Publishers – they will sometimes give away damaged books or books that are not selling well. Be careful to inspect these books closely. Sometimes the damage is very minor, such as the wrong colours on the cover, but other times entire sections are blurry or missing. For books that are not selling well, try to find out why. Sometimes useful books on agriculture or health don't sell because they were not marketed well or because too many copies were made. Other times, books don't sell because they are poorly written or badly made. Even if you cannot get publishers to donate books, ask for a discount. They will usually reduce the price for libraries. When you buy materials published domestically, you help support the local publishing industry. See the *Resource Guide* for more information about finding local publishers.

Bookshops – like publishers, bookshops will sometimes donate damaged or left over books. They can also tell you where to find local publishers and may even be able to order materials for you from abroad. Be sure to ask for discounts. You could also put a sign in the library with information about bookshops that donate materials. This might lead to new business for the shops and encourage them to help you.

Universities – can offer many kinds of help to libraries. First, the university library may receive donated books from overseas. If this is the case, ask if they have received any children's books or other materials more appropriate for your library than theirs. They

might also be able to request that books for your library be included in the next shipment they receive. Once again, do not take anything you do not really need. Second, the university librarian may be able to give you valuable advice about running the library or training a librarian. If there is a library science program at the university, be sure to find out what it costs and if they have any scholarships and/or distance learning programs. Perhaps one of the students would even be willing to help you organise your library as a school project, or you might spend a few days volunteering in the university library to learn about procedures. At the very least, ask if the librarian would be willing to answer your technical questions when they come up.

Library associations – are professional organisations for librarians. More and more developing countries have national library associations that promote the profession and help librarians share their knowledge and concerns. These associations often print newsletters and organise conferences to help librarians keep up with new developments. The library association might be willing to print an article about your library in its newsletter. They may also keep a list of book donation programs in the country. If there is no library association in your area, consider asking one of the national or international library associations listed in the *Resource Guide* for help with setting one up.

Library networks – libraries often form networks to share information and improve services to users. These networks can be regional, national or international and often focus on a particular type of information, such as health or appropriate technology. You should contact the library network in your area and find out about the costs and benefits of joining. Member libraries often receive subscriptions to journals and/or electronic databases. Several library networks are listed in the *Resource Guide*.

Cultural centres – many developed countries (especially the U.S.A., France and Germany) have cultural centres in developing countries. They are generally staffed and funded by the governments of the developed countries. These centres often include libraries, which are interesting to visit, and may have free materials about the country they represent. The United States Information Service (USIS), for example, maintains cultural centres in some countries that give away posters and books about United States and sell inexpensive basic English books for new readers (check with the U.S. embassy for more information). Cultural centres may also have information about study abroad programs, scholarships and distance learning (courses taken electronically or by mail). Be careful of getting propaganda (materials that give a one-sided picture of the sponsoring country – see *Getting Materials* above).

Embassies – depending on security issues, embassies may or may not be open to the general public. United States embassies can provide you with information about USIS (see above) and Project Handclasp (see the *Resource Guide*). If you have trouble getting into the U.S. embassy, it may be easier to ask an American Peace Corps Volunteer about embassy programs. Similarly, you may need to ask French, German or other aid workers about their embassy's programs.

Religious authorities – if your community requested religious materials, try asking missionaries or religious authorities (e.g. imams, priests, rabbis, ministers, etc.) if they can get you donations. They are generally happy to help.

SOME FACTS ABOUT BOOK DONATION PROGRAMS

In addition to the groups listed above, a section of the *Resource Guide* at the back of this manual is devoted to international book donation programs. There is a lot of confusion about how these programs work. To avoid frustration and disappointment, it is important to understand where book donation programs get their books and how they operate before you approach them for help. Most international book donation programs get their books from publishers, school systems and/or individuals. Publishers generally give them books they can't sell. This could mean hundreds of copies of one book or a few copies of several books. Individuals and school systems give them used and sometimes worn-out materials.

The book donation programs then sort out the useful books. Even when they have strict guidelines about what materials they accept, donation programs still get a lot of books they cannot use. A few donation programs allow librarians to choose which materials they receive from a catalogue, but most choose the books for you based on the information you supply about what you need. In most cases, it is hard to predict exactly what you will receive. For example, some libraries have received entirely useless donations (one even got a whole box of city sewage plans), but others have received beautiful new children's books. Requesting a book donation from overseas is always a gamble and you should know that you may wait months and spend a lot of money on customs or postage only to be disappointed by what you receive.

Once the books are collected by the donation programs, they must, of course, be shipped overseas. The great majority of book donation programs ship books in sea containers that hold around twenty thousand volumes. They may ask the recipient library to pay for part or all of the shipping costs and customs charges. It can cost a library thousands of dollars to get one of these shipments and the library must generally give the donor organisation the money before it will ship the books. This is obviously impossible for small libraries. Organisations that work this way have not been included in the *Resource Guide*.

Some book donors that ship books by sea container have partner organisations or field offices overseas. In this case, the book donor organisation usually has funding to ship one or two containers per year to their partner organisation, which is then responsible for distributing the books to libraries. These book donors have been included in the *Resource Guide* because librarians from small libraries can often get donated books from the partner organisation or field office in their country.

Partner organisations have different ways of distributing books. Sometimes, it is possible for librarians to select books from the partner organisation's warehouse. This enables librarians to choose the books that they want. Other times, the partner organisation charges a membership fee that entitles libraries to get a certain number of books per year. In this case, the partner organisation usually chooses the books for the library. Libraries should ask to see samples of the books and talk to other libraries in the program before buying a membership. As mentioned above, the quality of books can vary a lot from one program to another.

Another consideration is that getting books from foreign donation programs can actually harm the publishers and book sellers in your own country. When free books from overseas are “dumped” in a country, it makes it harder for publishers to sell the books they produce. Since local publishers are generally your only source for local language materials, books by local authors, and textbooks designed for your country’s school curriculum, it is in your interest to support them as much as possible. A library that only has donated books from abroad cannot give its readers books that are produced by, for and about their own country.

What useful books *can* you get from foreign donation programs? Donation programs are good sources for reference books such as dictionaries, atlases, almanacs and encyclopaedias. These are very expensive to produce and purchase and may not be available in your country. Ask for ones that are no more than five years old (ten for the dictionaries). Donation programs may also have classic fiction by foreign authors, books about other countries, children’s books, books on tape, CD ROMs (see *Computers* below) and back runs of interesting magazines like *National Geographic* (which seems to be popular almost everywhere because of its beautiful pictures). If you select these types of materials in the reading levels you need, you should get good results. You should be cautious about requesting used school textbooks because you may not be able to get a complete set, they won’t be published with your country in mind, and they may be very outdated. Similarly, technical manuals that are not produced specifically for developing countries often require tools and equipment you cannot get. It is better to request these materials from NGOs in your own country (see above).

Finally, if you are unable to find an organisation in your own country that distributes donated books from abroad (you can write to the World Library Partnership for country-specific contacts – see the *Resource Guide*) and decide to send letters to the international organisations listed in the *Resource Guide*, be as specific as possible about what you need. Far too often, book request letters give no specific information about the library, community or the materials needed. This makes it impossible for the book donation organisations to do a good job of helping the requestor. The donation organisation may respond by asking the requestor for more information, which causes delays, or they may not respond at all. In your book request letters, always include information about the size, type and purpose of the library, the community it serves and the subjects, languages and reading levels you need. It is even a good idea to include a school syllabus and list of specific titles.

Make sure that you also speak with the post office before requesting books to find out how much, if anything, it will cost you to receive them. In some countries, the customs charges may be so high that you cannot afford to request books from abroad. Be sure to ask the postmaster if the post office will waive the customs charges for humanitarian aid. The post office may have very strict rules about how the books must be labelled, addressed and/or packaged in order for the charges to be waived (e.g. they may waive them if the books are sent to the library, but not if they are sent to the librarian). Your book request letters should include any specific instructions for mailing donations.

Also send a thank you letter to the donors when you receive the materials. Be sure to mention which books were the most helpful. If you get books you really can't use, it is good to let the donors know. This will help the donors to improve their programs in the future. Some organisations complain that they never know if the books they send are truly helpful. If the books are not what you need, explain the problem to the donors. They may tell you that your request was not clear (this will help you to write a better one next time), or they may even send you more appropriate books. It can be hard to tell someone who has given you a gift that there is a problem with it, but if done gently and politely, the donors will appreciate the information.

Action steps:

1. Recruit people to help collect books for the library.
2. Hold a book drive.
3. Identify and contact organisations that can help the library (networking).
4. Ask the organisations about book donations and other services for libraries.
5. Visit local distributors of donated books (see *Resource Guide*).

BUDGETING

Decision point: How do we know how much money to raise?

To be truly successful and sustainable, your library must have some funding for books and other expenses. While donated books can be a significant part of the library's collection, the only way to get many of the books most relevant, important and interesting to the community is to buy them. As mentioned above, buying books also supports local publishers and booksellers. You may also need money to buy supplies, construct and maintain a building, pay a librarian or for special programs at the library. To guide your fundraising, you need to have a budget. A budget is a list of all the library's projected expenses (costs) and all of its income. There are many types of budgets, but the one that you will probably find most useful is called a line-item budget. It lists an amount of money for each type of expense or income. Here is an example:

Figure 2: Sample budget

1999 Library Budget

<u>Expenses:</u>		<u>Income:</u>	
New books	\$200.00	Fines	\$25.00
Supplies	\$30.00	Donations	\$150.00
Building Maintenance	\$60.00	Party	\$75.00
Postage	\$30.00	Raffle	\$100.00
 Total	 \$320.00		 \$350.00

Your budget may be more or less complicated than this one depending on the library's income and expenses (see *Bookkeeping* below). In this sample budget, the income is slightly greater than the expenses, which means that the library will have a little extra money in case of a problem. This is a good way to plan, but might not be possible in reality.

How do you develop the budget? First, make a list of all your expenses. If the library is just getting started, try to imagine everything it will need for one year and then research the cost for each item. If the library is a few years old, you can start by looking at what was spent in past years. The treasurer or another committee member should make an initial list of expenses for the committee to discuss and either accept or change. Add the amounts for each item to find the total amount of money the committee will need to raise. If the amount seems too high, you may need to lower some costs. If it seems too low, you can add money to different items or save the extra in case you run into problems.

The budget is meant to be a guide, not a firm rule, and the committee can decide to change it as needed. Changes are very common in the first few years when you are still learning what it costs to run the library and how much money you can realistically raise. In fact, you should read the next section about fundraising before you begin making your budget because it will help you to decide if your budget is realistic.

Action Steps:

1. Make a list of the library's expenses for one year.
2. Make a list of possible fundraising events (see next section).
3. If the income from the fundraising is enough to cover the expenses, then go ahead with your plan.
4. If not, look for new fundraising ideas and/or try to cut back your expenses.

RAISING FUNDS

Once you have a general idea of how much money you need, you are ready to start planning to fundraise (of course, sometimes libraries get a grant for a certain amount of money, which they then have to decide how to spend).

Raising money is one of the most important jobs of the library committee. In a very practical sense, the success of the library depends on the success of the fundraising. Here are some tips to make your fundraising more successful:

1. Demonstrate that the library committee is responsible and trustworthy by reporting to the community how past donations were spent (see *Evaluation* below for suggestions).
2. Involve as many people in the fundraising as possible. People are more likely to make donations when asked by their friends or family than when asked by a stranger. You may wish to form a "friends of the library" club (see *Involving the Community* below).
3. Be focused. If you want to raise money for books, make a list of which books. People prefer to give money when they know exactly how it will be used.
4. Set realistic goals. It is better to beat a small goal than fall short of a large one.
5. Keep track of who contributes. People who give once are more likely to give again.

6. Don't ask the same people for money in the same way too often. Use a variety of approaches.
7. Always thank every donor!

Here are some ideas for fundraising events:

Raffles – are a simple way to turn one donation into many. The basic idea is to sell people chances to win a prize. The more the prize is worth, the more people will be willing to pay for the chance to win it.

Example: Maria donates a dress for the library raffle. The library committee sets up a table at the market and sells people raffle tickets (slips of paper on which they write down their name and address). The tickets are stored in a closed box or bag until the end of the day when the winner is chosen by pulling out one ticket.

Auctions – ask people in the community to donate goods or services (e.g. repairing a roof). Then “auction off” the donations. Each person who wants to buy an auction item must offer a higher price than the one before. Whoever offers the highest price for an item buys it.

Dances or Parties – try to get musicians or someone with a good collection of recorded music (a DJ) to provide free music and/or someone to donate food and drinks. You can charge people a small fee to get into the party, and you will also make money on the food and drinks.

Sell school supplies – libraries in communities where school supplies are not readily available sometimes sell them to make money. This requires money to buy the first group of supplies. If there are already people selling school supplies in your community, try to think of something else you could sell like cookies, drinks or other items. Children in the United States commonly sell candy to raise money for school trips.

Church collections – if your church or other religious institution regularly takes a collection from the congregation, you can ask them to make a second collection for the library.

Solicitations – ask people to make donations to the library. The donations do not have to be money. In many places, it might be easier for people to give some of their crops at harvest time or donate crafts/goods they sell. The library committee can either sell, auction or raffle off these donations for money. They may also be able to use them to pay the librarian (see *Recruiting a Librarian* below). Some community members who work or study in distant places may only return for special holidays or festivals and you may therefore want to ask for donations or hold a fundraising event during these times.

Grants – some NGOs and/or governmental organisations will give money to a library. This is called a grant. Each donor organisation generally has its own application forms and guidelines. It is best to write them a brief letter (or better yet, visit their offices)

explaining the project and asking for an application. Some organisations that give grants for books are listed in the *Resource Guide*. If you have an American Peace Corps Volunteer or other aid worker in your community, they can sometimes work with you to get grants to help with a project. Since the process of applying for a grant can be very long and complicated, make sure you contact someone at the donor organisation to find out if your project qualifies before filling out all the forms. It is best to talk with someone at the organisation in person to get their advice about the process before you begin. If possible, also talk with someone who has received a grant from the donor.

Library twinning – there are a few organisations that can match your library with a partner library in another country. Your partner may be willing to send you books or raise money to help support your library (see the *Resource Guide*).

A library garden – if you live in a farming community, perhaps someone on the library committee or in the community would let you use a piece of land to raise crops for the library. This is a lot of work, but can potentially be a great source of income. Finding people to work the land may be difficult. The library committee should take a leading role in volunteering their time. During planting and harvesting, the whole committee can work together. When there is not as much work, you can rotate the responsibilities. In urban areas, try planting a courtyard garden. You could even grow peppers, tomatoes or herbs in pots on a rooftop, porch or balcony.

Sporting events – ask players or teams to hold a match and charge people a small sum to come and watch.

Performances – you could put on play, puppet show, story telling session, concert, reading by a local author or other performance at the library and charge people to attend. You could also rent out the library to groups, such as a band, who wish to put on a performance or hold an event there.

Movies – if your library is able to get a VCR or film projector, you can have movie nights. Charge an admission fee and sell drinks and snacks.

Book sale – sell the books that can no longer be used in the library (see *Weeding* below).

Haircuts – ask a local hairdresser to donate his or her time and spend a day giving haircuts/styling at the library. This is really fun and may encourage some people to visit the library who have never been there before.

Fees/fines – this is a very important issue. Some libraries decide to charge a yearly membership fee and/or to charge fines when books are not returned on time (see *Circulation* below). While this may bring in money for the library, it may also prevent some people from using it. This is an issue the committee will need to discuss at length before deciding (see *Making the Rules* below).

Using the list above, and your own creativity, the committee should make a list of fundraising events you plan to do. For each one, list how much money you expect to raise. Remember that you may need to purchase supplies or pay people to help with

some of the fundraising. You will need to plan very carefully to make sure that you don't spend more on these fundraising events than you can raise. In reality, it is very hard to predict how much money you will make from a fundraising event until you do it a few times. You should therefore plan on more fundraising events than you think you actually need in case some do not work out.

Now that you have your list of expenses and your list of fundraising, how do they match up? Does it look like you can raise enough money to cover all of your expenses? If not, can you cut out some of the expenses or increase your fundraising? If you do not realistically have enough money to pay for everything, the committee will have to choose which things are the most important. Too often, the first expense that libraries cut is new books. Before doing that, remember that new books are what keep people coming into the library. Without them, your level of community support will drop, which means that people will be less likely to help with fundraising or make donations to the library. The more interesting the books in the library, the more people will be willing to pay to keep it open (see *Community Involvement* below).

Action steps:

1. Recruit as many volunteers as possible to help with fundraising.
2. Select fundraising events from the list above or create your own.
3. Set goals for each fundraising event (how much you want to raise and why).
4. Report back to the community how much you raised and how it was spent.

BOOKKEEPING

Decision point: How should the committee keep track of the library's finances?

The librarian and the library committee must work together to safeguard the money raised by the library and keep clear records of how it is used. You have a responsibility to the community and the donors to use their contributions wisely and they will want to know how they were spent.

One of the first questions you must decide is where to keep the money raised by the library. The best place is in a bank account or an account at the post office. There are two types of accounts:

Current or Checking accounts – when you open a chequing account, you receive blank cheques that you can use to pay for purchases. The bank will explain how to fill them out. You will need to keep track of how much money is in the chequing account at all times so that you don't accidentally write a cheque for more money than you have in the account. If you do, the bank will not honour the cheque and you will be charged a fine. Checking accounts are very convenient because you do not have to go to the bank in person to get money and cheques can be sent through the mail (never send cash through the mail). However, the bank may charge a small fee for each cheque and generally does not pay interest (see below). In some rural areas, people may be unwilling to accept cheques.

Savings accounts – when you open a savings account, some banks start a passbook for the account that shows how much money is in it at all times. Some banks keep the passbook

and others ask you to bring it when you visit the bank. Money can only be removed from a savings account in person. Some banks pay a small amount of money each month to savings account holders. This is called interest, and it is one of the advantages of a savings account. The main disadvantage of this kind of account is that you must pay for everything in cash. It is more dangerous to carry around cash than cheques.

In order to open a bank account, you must decide who will have the authority to take out money on behalf of the library (anyone who knows the account number can *deposit* money). Generally, the treasurer and/or president can take out money. Requiring both of them to sign for the money improves security, but it can be very inconvenient – especially for savings accounts.

To open an account, the person or people who will have signing authority must bring the money and their identification papers to the bank. Often, a passport or other document with a photo is required. The bank clerks will help them fill out the necessary forms. They will probably have to present their identification papers each time they withdraw money at the bank (shops may also want to see identification before accepting a cheque). In some countries, you can also get an account at the post office, which may be more convenient than the bank.

If you live in a place where political instability or other factors make it undesirable to keep the library's money in a bank, you will need to find another solution. A strong box with a good lock will generally discourage most thieves, even more so if the box is hidden from view. If someplace in the community has a safe, such as a shop, a church or an NGO, they may be willing to let you use it. In general, your chances of avoiding theft will be greatest if only a few people know where the money is kept.

One disadvantage of not having a bank account is that it may be impossible for your library to receive money from foundations or organisations outside the country. These organisations prefer to send money via bank transfer, but they may be willing to send the money through the post office or a third party, such as a local NGO, when justified. Another disadvantage is that it is harder to order books by mail without a checking account. You will have to purchase a cashier's cheque, money order or similar form of guaranteed payment each time you wish to place an order by mail (never send cash through the mail). You may also be able to use UNESCO or British Council book coupons to order books from foreign publishers. See the *Resource Guide* for more information about these programs.

Once you have decided where you will store the library's funds, you will need to set up a system for keeping track of them. Keeping good records will allow you to report to the community, see if you are within your budget, plan your budget for next year, show your donors how their money was spent, know what equipment or furniture the library owns, and know at all times how much money the library has. The easiest way to keep track of these funds is to record all of the library's deposits and purchases by date. After each entry, record the total amount left in the account. This is called a balance sheet. You can buy special notebooks called ledgers for recording this information or make your own. Here is an example of all the income and expenses for a small library for the month of January:

Figure 3: Sample balance sheet

Date	Description	Expense	Income	Balance
1 Jan. 1997	Benefit party (this money was used to open the account)		\$200.00	\$200.00
10 Jan. 1999	Books from the Book Corner	\$98.50		\$101.50
12 Jan. 1999	Tape, pens, stamp pad from Ahmed's shop	\$15.00		\$86.50
13 Jan 1999	Donation from the literacy club		\$20.00	\$106.50
17 Jan 1999	Candles and Kerosene	\$3.00		\$103.50
20 Jan 1999	Desk and four chairs from Mr. Finch, the carpenter.	\$70.00		\$36.50
25 Jan 1999	Dictionary from the Book Corner	\$20.00		\$16.50
27 Jan 1999	Sale of donated corn		\$65.00	\$81.50

In addition to keeping a balance sheet, you should also save the receipts for all the purchases you make. You can use the receipts to verify how the money was spent and correct any errors made when entering the numbers in the balance sheet. If necessary, the library committee can always check a receipt by talking to the person who issued it. Most shops will automatically provide a printed receipt. If they do not, be sure to ask for one. Within your community, people may not be used to giving receipts. In that case, a simple hand-made receipt is fine. Here is a sample:

Figure 4: Sample receipt

I (name) received (the amount of money) from (the library) for (list the good or services) on (date).
 (signature)

For example:

I, Mr. Finch, received \$70.00 from the community library for one table and four chairs on 20 January, 1997.
 Edward Finch

Often, the librarian is responsible for recording all the income and expenses of the library, and the treasurer is responsible for actually writing cheques and making the bank deposits and withdrawals. It is a good idea to have two different people responsible for keeping the records and getting the money from the bank. The following examples show why:

Example 1: The library holds a big fundraising event. The treasurer collects all of the money and takes it to the bank. Then he or she records the amount deposited in the record book. Since no one but the treasurer knows how much money was raised, what

is to stop the treasurer from taking some money and depositing the rest? If, however, someone else records each donation (or better yet, gives people receipts for their donations and keeps a carbon copy of the receipts for the library), then there will be a record of how much money was raised and everyone will know if some of it is missing.

Example 2: The librarian takes out \$50.00 from the bank account, but only records taking out \$30.00. He or she spends \$30.00 on supplies for the library and \$20.00 on a new outfit. If no one but the librarian is responsible for the bank account and the record book, he or she may never get caught. If, however, the treasurer has to go to the bank to get the money for the librarian, then the librarian will have to account for the total amount to the treasurer.

These examples are not meant to imply that the librarian or anyone on your library committee is dishonest. They simply show that when all the records and the money are in the hands of the same person, there is no way to verify that the money is being handled responsibly. Someone could be a dishonest, or they might not – there is no way to tell. You want your accounting system to clearly show the community and your donors that their money was used for the library. It is therefore in your interest to have two different people responsible for keeping records and signing at the bank.

Action steps:

1. Set up a bank or postal account.
2. Keep records of all the library's income and expenses.
3. Save receipts from purchases.
4. Clearly divide responsibilities between the treasurer and the librarian.

BUYING BOOKS

Decision point: where should we buy books?

Once you have raised the funds, there are several ways you can buy books. The most direct way is to buy them at the nearest bookshop. This gives you the opportunity to look at the books and to try to negotiate a discount for the library. It also supports your local bookseller. Some countries also have book fairs where you can choose books from many different publishers and booksellers. Sometimes, you can buy the books used as displays during the fair for a good price on the last day.

If you do not have the time or money to go to a bookshop, you may be able to order materials directly from publisher. Note that commercial publishing houses are only one type of publisher – many NGO's and government agencies also publish useful materials. Some publishers may send you a free catalogue of their books and an order form with instructions for paying (e.g. Intermediate Technologies – see the *Resource Guide*). The publishing networks listed in the *Resource Guide* can supply you with the addresses for some publishers. Within your country, you can pay by cheque or bank draft (see *Bookkeeping* above for more information about bank accounts). For international orders, you can generally use an international money order or bank draft if these are available

from banks in your country. If not, UNESCO and the British Council have coupons that you can use to pay for books from countries in Europe and the United States. See the *Resource Guide* for more information about these programs.

In some countries, you may be able to find a “book jobber” or purchasing agent. These are companies that charge a fee to order books for libraries and schools. They are very convenient because they can get books from many publishers and usually handle the currency and shipping issues, resulting in a better selection and less paperwork. Purchasing agents may also be able to supply you with inexpensive catalogue cards for the books you order (see *Organising the Materials* below). You will have to decide if the time and effort you save by using a purchasing agent is worth the fee they charge.

Selecting books to order by mail can be hard. Publisher’s catalogues are designed to sell books and you should keep that in mind when reading them. Their book descriptions, when present, are sometimes vague. Book reviews are one of the best sources of information about new books. Reviews are detailed evaluations of books written by independent reviewers. You can find book reviews in newspapers, magazines and newsletters from other libraries, library organisations and NGOs. Bibliographies, such as the one at the back of this book, are lists of books on a specific topic. Some bibliographies contain descriptions (these are called annotated bibliographies) and others just list the title, author and publishing information. Be careful to check the publication dates on books listed in bibliographies to avoid getting out of date materials. Sometimes books or articles contain a list of additional reading. These lists are generally books recommended by the author.

Whenever you order books by mail or through a purchasing agent, be sure to keep a record of what you ordered, the date you ordered it and the price. When you receive the books, check them against your records to make sure that everything is correct. Immediately notify the supplier of any problems with the order and return any damaged books. As mentioned above, keep all receipts from booksellers, publishers and/or purchasing agents for your records (see *Bookkeeping* below).

Action Steps:

1. Visit local booksellers and book fairs.
2. Write to publishers for catalogues.
3. Consider using a purchasing agent to handle your orders.
4. Read book reviews in newspapers, newsletters and magazines.
5. Check the books you have for useful bibliographies.
6. Keep records of all your orders and purchases.

RECRUITING A LIBRARIAN

Decision point: Who should run the library?

Before you begin searching for a librarian¹, you must decide if the position will be paid and what skills and qualities the librarian should have. Now that you have made a budget, you should know how much of a salary, if anything, the library can afford to pay. In some countries, the ministry of education or the national library service will pay part or all of a librarian's salary. If this is not the case in your country, and you find that a salary is more than your library can afford, you won't be alone. Many community libraries are run by volunteers. Even though you may not be able to pay the librarian a salary, perhaps you can pay him or her in other ways. Some communities thank librarians by supplying their lunches or dinners while they are working. Others help them with their fields or household chores or give them a portion of the year's harvest or goods they produce. Perhaps you could also honour the librarian with a ceremony or certificate of recognition.

Whether the librarian is paid or not, be sure to choose someone with the right qualities for the job. The librarian is the most important link between the community and the library and will do more than anyone to build (or destroy) support for the project. As a result, one of most important consideration in choosing a librarian is how well he or she works with people. A good librarian must be cheerful and patient when answering questions (even for the hundredth time) and enthusiastic about reading. He or she should enjoy helping people and serving the community. The librarian should also be good at explaining things clearly.

Another important consideration is how much time the librarian will have to work in the library. Obviously, people who work full time or have fields to farm will not have much time to open the library. If the library is in the home or shop of someone who is there during the day, this will increase the number of hours it is open. However, if most of the community is occupied during the day, it may be more important to have the library open in the evenings or on days of rest. In this case, a volunteer who works during the day but is willing to open the library after school or in the evening may work just fine.

Besides being patient and cheerful and having time, there are several other qualities a librarian should have. The librarian must be well-organised and pay attention to details. He or she must be competent at basic math and responsible with money. It is very helpful, but not necessary, for the librarian to have experience teaching literacy classes or working with children. It is a good idea to choose someone who is respected in the community and self-confident because librarians sometimes face criticism or jealousy from some community members.

Before you begin searching for a librarian, you should write a "job description." It should list all of the duties and responsibilities of the librarian, as well as the skills required. Creating such a description will help people to decide whether or not they want the job. It

¹ This manual uses the term "librarian" for anyone who runs a community library. In some areas, only people who have completed a university degree or special training program in library science are called librarians. You may wish to use the title "library coordinator," "community information specialist" or a similar title if the person who runs your library does not have formal library science training.

will also help the library committee to choose the best person for the job by defining what skills and qualities they need to look for in the candidates. Here is a sample job description:

Description: The Yikpa Community Librarian reports directly to the library committee and is responsible for the day to day management of the library. His or her responsibilities include: opening and closing the library on time, explaining and enforcing the library's rules, helping readers to find books, organising the books in a clear and consistent way, taking inventory, purchasing new books, repairing books, tracking down overdue or missing books, helping the committee with fundraising and running community programs.

Skills needed: the librarian must be patient and cheerful, literate, numerate, well-organised, self-motivated and enjoy helping people.

Once you have written the job description, you are ready to begin recruiting a librarian. You can advertise the job by word of mouth, by posting notices in local schools and shops and/or by putting a notice in the newspaper. If you have enough money to pay a salary, you will probably have plenty of applicants. If you need to find a volunteer, here are some possibilities:

Teachers – if the library is in a school, sometimes teachers are willing to take turns opening the library. Remember that many teachers are already over-worked and the library committee should talk with the school director to see if the teachers who work in the library can be given time off from other responsibilities.

Older people – an older community member who is no longer able to spend as much time working might enjoy being the librarian. Being the librarian is a great way for older people to stay active in the community.

Merchants – if you initially located the library in a shop or bar, the shopkeeper may also be willing to be the librarian. This worked very well for the Yikpa Community Library in Togo. The librarian checked out books as he rang up purchases. Being the community's only shopkeeper also made it easy for him to keep track of overdue books because every family in the community came into the shop.

Community leaders – many libraries are run by young leaders who serve as librarians in their spare time. While this may mean that the library is only open for a few hours each day, the enthusiasm and commitment of these volunteers can make those few hours very productive.

Action steps:

1. Decide if the librarian will be paid or a volunteer.
2. If the person will be a volunteer, think about alternative ways to “pay” him or her (e.g. food, help with chores, etc.).
3. List all of the qualities you want the librarian to have.

4. Write a job description.
5. Advertise the job.
6. Interview all the candidates for the job and choose the best one.

MAKING THE RULES

Decision point: What rules should we have for our library?

The library committee and the librarian should work together to create clear policies and rules for the library. One of the most important policy decisions is whether or not to let people borrow books. Some libraries are strictly reading rooms – people may read the books there, but they cannot take them home. This is a good way to prevent theft and damage to the books, but it means that people can only read when the library is open. This can be very inconvenient. If your library does not have much space, it may also be impossible for everyone who wants to read to find a seat.

If the committee decides that the library should lend out books, it will have to make rules about who can borrow them and for how long. Will you lend them only to people from your community, or will you lend them to people visiting from out of town as well? How long will people be able to borrow the books, and what will happen if they don't return them on time (see next paragraph)? There may be some books, such as encyclopaedias and dictionaries, that are so expensive or so hard to replace that you decide not to lend them out. The committee will have to weigh the advantages and disadvantages of letting people borrow the books and then work with the librarian to set a clear and workable lending policy.

Another important policy issue is whether or not to charge fees and/or fines. Fees are charges to use the library. Some libraries charge a yearly membership fee, others charge a fee for each book you take out and still others require readers to leave a deposit when they take out a book (the library returns the money when you return the book so this is not really a fee). These fees may bring in needed money, but they may also make it too expensive for some people in the community to use the library. One solution is to have different fees depending on income and make the library free for the poorest people. It can be confusing, though, to charge different people different fees and some people may find that system unfair. Another approach would be to ask people to contribute what they can afford. Many museums in the United States have a sign at the door asking people to make a small donation. The donation is optional, but most people pay it, especially when there is a suggested amount.

Fines are penalties for breaking the library's rules. For example, damaging a book or not returning it on time. Many libraries increase the overdue book fine for every day a book is late. If you choose to do this, make sure the fine never gets so high that people cannot afford to return a late book (e.g. charge a few cents per day till you get to some maximum amount). Many libraries also charge users for the cost of replacing books that are lost, stolen or destroyed. Fines may discourage people from breaking the rules, or they may encourage them to steal books instead of checking them out properly. Strict rules usually lead to more book theft and rule-breaking than looser rules. While fees and fines can bring in money for the library and encourage people to obey the rules, they can also discourage some people from using the library altogether.

Finally, the committee should decide general rules for how and when the library will operate. When will the library be open? Should young children be allowed in without an adult or older child? Can people eat and drink in the library? Can books be dropped off after hours (some libraries have a slot in the door or a box outside the library for after hours book returns)? Can someone borrow books for someone else? Many of these rules can be left up to the librarian, but it is a good idea to talk them over if a problem comes up or if someone has strong feelings about them. The rules should be posted clearly in the library with the signatures of the committee members.

Action steps:

1. Discuss the advantages and disadvantages of letting people borrow books and decide what is best for the library and the community.
2. Discuss and decide on a policy for fees and fines.
3. Discuss and set other general rules for the library.
4. Post the rules in the library.

SECTION TWO: HOW DO WE MANAGE THE LIBRARY?

Whereas the last section was addressed to the Library Committee, this section is addressed mainly to the librarian(s). It follows the same basic format as the previous section with decision points followed by information and action steps.

LIBRARIAN TRAINING

Where can a librarian get training?

Most community librarians get all their training “on the job.” This means that they teach themselves how to be a librarian through experimentation and practice, reading books about librarianship and talking with other librarians. Formal training programs for librarians are often expensive and may require travel to a large city or even another country. They may also be directed towards university libraries and teach principles and techniques hard to use in smaller libraries. Some organisations that offer training for community librarians are listed in the *Resource Guide*. Library associations and university departments may also offer continuing education or distance learning programs in library management. Through networking (see *Getting Materials* above), the library committee may uncover additional sources for training.

If you are your community’s first librarian, you will have to take charge of your own training. Start by visiting other libraries and reading manuals such as this one (see the bibliography for more manuals). This will help you to get an overview of the job. Also review your job description with the library committee and write a list of all your responsibilities. This will help you identify the skills you need to develop. Here is a sample list:

Responsibilities of the librarian:

1. Opening and closing the library on time.
2. Helping readers to find books.
3. Explaining and enforcing the library’s rules.
4. Organising the books in a clear and consistent way.
5. Taking inventory.
6. Acquiring books.
7. Repairing books.
8. Keeping track of borrowed books.
9. Tracking down overdue or missing books.
10. Helping the committee with fundraising.
11. Designing and running community programs.
12. Bookkeeping.
13. Evaluating the library.
14. Making status reports to the library committee and the community.

As you can see from this sample, being a community librarian is a big job with a wide variety of challenges! It can be overwhelming at times and you should work with the library committee to decide which tasks are the most important. Now that you have an

overview of the job and a list of responsibilities, think about what skills you have and which ones you need to learn. Then make a plan for getting the skills you need. This manual discusses all of the responsibilities listed above and suggests ways to develop good library management practices. As mentioned above, you can also consult the manuals listed in the bibliography and/or talk with other librarians when you have questions. People with university degrees, foreign aid workers, teachers and government officials may also be of help. Use the same networking principles listed under *Getting Materials* above to find people who can help you learn library skills. Remember that every library and librarian is different and you may need to adapt the advice you receive to fit your situation.

Keep a record of your experiences so that others who volunteer or work in the library can learn from them. Writing down problems will help you work out clear solutions and develop policies for the future. You can eventually use your notes to write an operating manual for the library that describes its policies and how they were created. The manual should include general rules set by the library committee (see *Making the Rules* above) and descriptions of any tools you develop, such as the shelf list or circulation system (see *Organising the Materials* and *Circulation* below). Also include any helpful tips for making the job easier that you have learned over time.

Action steps:

1. Review your “job description” with the library committee.
2. Make a list of your responsibilities.
3. Find manuals, training programs and other librarians to help you get the skills you need.
4. Keep an ongoing record of your experiences for future librarians.

COMMUNITY INVOLVEMENT

Decision point: How do I keep the community involved in the library?

Library users who are confident and satisfied will keep returning to the library. You can help people to get comfortable using the library and develop new skills by pointing out the shelf list, showing them where books are located, helping them to find the right reading level and answering their questions. You may often need to be patient and creative when trying to help someone find what they need. Some people may feel shy or embarrassed about asking questions and need encouragement. Others may ask general questions even when they want to know something very specific. You can help people to clarify what they want to know by taking the time to ask them questions like those in the following sample dialog:

Sample dialog:

User: Do you have any books about farming?

Librarian: Yes, we have many. Are you interested in a particular kind of farming?

User: I am interested in corn.

Librarian: You would like to read about growing corn?
User: Well, I really want to know how to keep insects away.
Librarian: You want to keep insects off the corn in your field?
User: No, I want to stop them from eating it as its drying.
Librarian: OK I think you need a book about grain storage.
User: Yes, that is what I want.

The librarian in this example helped the user to express what he really wanted to know by asking questions. Instead of wasting a lot of time looking through all the books about farming, the librarian helped the user to narrow his search to books about grain storage. Helping people to be specific about the information they need will make them more successful and satisfied library users.

Users will also feel more comfortable if the library is bright, cheerful and welcoming. To make the library more attractive, try decorating the walls with posters, artwork and/or colourful displays. Make sure that the shelf labels and signs (see *Labelling* below) are neat and easy to read. Post the library's hours by the entrance and hang a sign on the door with a greeting such as "Please Come In" when the library is open. Always keep the library tidy and clean. Putting fresh flowers or potted plants on the librarian's desk or on some of the tables is also a nice touch. Some libraries forbid people from talking, but this can prevent them from studying together or sharing what they have read. Instead of silence, try asking people to talk in a quiet voice that does not disturb other users. Encourage people to obey the library's rules by using friendly reminders such as "using bookmarks makes books last longer" instead of negative statements such as "do not bend pages." Some libraries write friendly reminders on paper bookmarks that they hand out to users. This is a nice way to get people to read and obey the rules.

In addition to being helpful and friendly, you can also encourage people to visit and use the library by featuring information on topics of special interest to the community. You can identify these topics by keeping a list of frequently requested information, by following current events, by encouraging people to make suggestions and/or by attending meetings of different community groups. Select a few key issues to focus on and use some or all of the techniques listed below to make information on these topic more accessible to library users. You should also include local community information, as this is certain to be of interest. You can learn more about the techniques presented in the section by reading *Community Information Services: A Manual and Resource Guide* by Margaret Myers (see the bibliography).

Preserving oral knowledge – local history, folklore and culture is of special interest to the community. One way the library can help to preserve local traditions and customs is by recording interviews with people who have particular skills or special knowledge about the community. When appropriate, you can also record stories and legends, festivals, music, ceremonies, dances and other important cultural events. These recordings could even be made into radio shows to give them a wider audience. Be sure to discuss which things should be recorded with the community and write the date, place, speaker, topic, event or other explanation on each recording.

Works by local authors – as with oral knowledge, writings by local authors may contain a lot of very valuable information of special interest to the community. These works can be professionally published or simply typed or hand-written. The authors can be by writers, poets, students, artists or other community members. Special care should be taken to preserve manuscripts that are irreplaceable. Some libraries collect all works by local authors (in this case “local” usually means the village, town or city where the library is located). Others are more selective.

Repackaging or creating materials – there are many ways that you can summarise or simplify information to make it more accessible to library users. You can create posters, fact sheets, diagrams or bulleted lists to emphasise important facts, such as how to fight infant death from dehydration. You can also translate materials into local languages. This is particularly important in rural areas where people may only be literate in the local language and publications in these languages are scarce. You can create simple “how to” pamphlets on topics like fixing a bicycle tire or registering to vote. You could also transcribe materials recorded on cassette tapes or write notes about local music recordings. There are endless possibilities!

News – people can gather at the library to listen to the news on the radio, read and discuss the newspaper, hear the latest news from the local taxi driver or merchant, and/or share news of their own. You can make it easier for people to follow the news on a particular topic (e.g. the World Cup playoffs) by creating a vertical file or display board (see below).

Vertical file – you can collect materials such as pamphlets, brochures, newspaper clippings, magazine articles and information sheets on special topics of interest and store them in a vertical file or in subject boxes (you can find instructions for making both under *Making the Shelf List* below). Using a vertical file makes it easy for library users to check for new information on special topics.

Display area – as mentioned under news, you can use a display board to inform people about events in the community, such as marriages, births, deaths, exam results and/or sports scores. You can also use it to display artwork, poems, stories, photos, suggestions, thank you notes for library volunteers, local handicrafts and other information. The United Nations distributes information you can use to make displays about International Women’s Day, World Health Day and their other special days. You can make a simple display board by attaching flour or grain sacks to the wall and pinning things to the cloth. Put a shelf near the display board for books and materials.

Community or library newsletter – If you have the funds, producing a community newsletter with poems, drawings, puzzles and stories, as well as news, is a great way to encourage people to read, write and come to the library. You can also create a library newsletter that reports on programs, events, displays, contests and other activities going on at the library. Either kind of newsletter can contain articles by local authors or information about topics of interest to the community.

Discussion groups – you can hold lecture/discussions with local experts (such as the people included in the community information resource list you created in the section *Does your Community Really Need a Library?* above), or general discussions on topics of interest.

Radio/TV broadcast schedule – you can create a schedule of educational radio and television broadcasts. If you have a radio or TV at the library, you can invite users to enjoy the programs there and hold a discussion afterwards.

Resource list – keep a list of the services and information resources available in your community (see the section on creating a resource list in *Does your Community Really Need a Library?* above). You can use the *Resource Guide* at the back of this book as a model.

Job information – put job postings from the newspapers into a file or post them on the display board. Request brochures and catalogues from training programs, schools and universities in your country. Also collect materials about distance learning (courses taken electronically or by mail).

Browser box – sometimes people come into the library just because they are curious or want something interesting to read. They may have no particular subject or type of book in mind. These users may feel overwhelmed by the prospect of browsing the shelves or looking through the shelf list (see *Organising the Materials* below). To help them find a book they will enjoy, you can create a “browser box.” This is simply a wooden or cardboard box with one or more sections where you can put a selection of popular fiction, beginning readers, children’s books, information books or other materials for people to browse. You can change the books every few weeks to keep the selection interesting.

Figure 5: Browser box

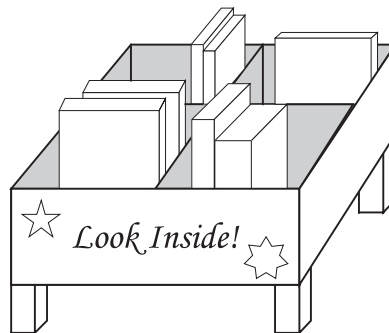

You can also encourage people to use the library by having events, services and programs. These may be ongoing or one-time-only activities. Most of the suggestions below cost little or no money, but may take quite a bit of time (some could even be used to raise funds – see above). Try to get volunteers to help you. For example, an older person may enjoy reading to children once a week or teacher may be willing to help students start a book club. Do not feel that you should limit yourself to the possibilities listed below. They are merely a starting point to help you form ideas.

“Friends of the library” club – you could start a club for people who are interested in volunteering at the library, working on the newsletter, helping with fundraising or other projects. The club could be made up of students and/or adults. A friends of the library club is different from a library committee in that club members meet to plan events and activities, not to make decisions about managing the library. Members can work on a single project or volunteer regularly. You can organise an annual party to thank the friends of the library and honour people who have helped throughout the year.

Inauguration ceremony – having a big party when the library first opens sends out the message that everyone is welcome. It is also a good opportunity to educate the community about how the library works.

Suggestion box – keep a box or notebook for suggestions in a prominent place and encourage people to use it. This can provide you with new ideas while demonstrating to library users that their opinions are important.

Essay/illustration contests – students who are not accustomed to reading and writing for pleasure may need a little coaxing before choosing to spend their free time at the library. Giving out prizes for the best essay, illustration or book report is a great way to motivate them. You can choose the book/topic or leave it up to them. Be sure to have different levels so that students from the lower grades don’t have to compete with more advanced students. If appropriate, give out prizes.

Other awards – you can give out awards for reading the most books, learning the most new words, writing the best report or for helping the librarian.

Story hours – reading a story out loud to a group of youngsters or adults can be a wonderful experience. With a little practice, you will find yourself putting more and more life into the characters. You can also ask other community members to take turns reading out loud or telling stories they know by heart. Try having a regular time and day for story reading – everyone enjoys a good story.

Performances – you can have plays, puppet shows (puppets can be made from paper bags, cloth, socks, paper attached to rods, dolls and many other materials), poetry readings, skits, dances, music or other performances at the library.

Games – you can keep board games, cards, traditional games and other types of games at the library. You can also hold “quiz shows” where teams compete against each other by answering questions on different topics. You can help students and community members learn to use the library by having a “quiz show” with library questions such as “where is a book’s title page?” or “which title comes first in the shelf list - *More Cars* or *Better Fish*?”

Literacy classes – the library can be a great place to hold literacy classes for adults who may not feel comfortable going to the school. Classes will bring new readers to the library where they can develop their skills.

School assignments – teachers should take advantage of the resources in the library by giving their classes research assignments or suggesting readings that complement school topics.

Book clubs – reading can be even more rewarding when you have a chance to discuss what you read with others. Organise a book club so that readers can share their reactions to books.

Library partnerships – also called twinning, connect your library with a library in another country. This can provide great opportunities for cultural exchange. Displaying drawings, letters, art and other materials from your partner is a great way to get people to come to the library.

Book box/mobile library – you may be able to extend services to distant areas by starting a book box or mobile library program. In a book box program, libraries lend a box of about 50 books to a distant community. The box is exchanged for a new one periodically. In a mobile library program, books are loaded onto a cart, van, truck, bicycle or other form of transportation and brought to distant areas on a regular basis.

None of these activities, however, will do much to build community support for the library if people do not know about them. You will need to publicise the activities as widely as possible for them to be effective. You can do this by word of mouth, calling a meeting, sending notices or fliers to community groups and schools, putting up posters, asking the local radio station to make announcements, sending a brochure or press release to a local newspaper, publishing a library newsletter, sending notices to library users (expensive) and/or by other means available in your community. Be sure to include the date, time and location of the activities in all publicity. You may also wish to charge a fee for attending some of the more popular activities (see *Raising Funds* above). If so, be sure to tell people in advance. Keeping the community informed about the library's activities is one of the most important ways to bring in new users and keep up the enthusiasm of regular users.

Action steps:

1. Practice welcoming people to the library and showing them how to find materials.
2. Practice helping people clarify what they want to know.
3. Decorate the library.
4. Identify some topics of special interest to the community.
5. Choose some ways to highlight these topics from the first list above.
6. Choose some programs, services or activities from the second list or design your own.
7. Publicise the activities, including date, time, location and cost (if any) throughout the community.
8. Have fun!

ORGANISING THE MATERIALS

Decision point: How should I organise the books so that people can find them?

As you read this section, remember that the main goal of your library is to share information with the community. It is sometimes easy to get so caught up in the details of organising your library that you lose sight of that goal. How you organise the books is not nearly as important as the end result. An organising system is only successful if it makes it easier for you and your library users to find information.

This section describes how to make one tool to help you organise your library – a shelf list.² A shelf list is a record of each book's unique location in the library. Whether or not you need a shelf list depends on the size of your library and how many people use it. Think of the shelf list as being like an address list for books. Trying to find a book in the library is like trying to find a friend in an unfamiliar village. If it is a small village, you can probably find your friend by going door to door. Similarly, if your library has only one or two bookshelves, you can probably find the book you need just by browsing. If, however, your friend lives in a large city, or the library has several bookshelves, you need a tool to save you time. An address book or a shelf list can tell you exactly where to find what you are looking for.

Making a shelf list is time consuming, but has many advantages. A shelf list:

1. Helps people find books quickly and easily.
2. Makes it easy to put books back in the right place.
3. Facilitates research.
4. Makes it possible to do inventories that check for theft and loss.
5. Reveals how many books there are on each subject.
6. Helps librarians decide which books to buy.

In order to create your shelf list, you will need to sort the books into categories. There are several standard systems for sorting books (also called classification systems) in use throughout the world. If the libraries in your area already have a system, you should try to use the same system. This will make it easier for you to co-operate with each other and less confusing for library users. Most librarians will be happy to explain their system for sorting books. This manual tells you how to set up a simple system on your own. It also explains the basics of one of the standard systems, the Dewey Decimal Classification or DDC.

It is a good idea to read all of this chapter carefully before deciding whether to use your own system for sorting books or the DDC. The advantage of setting up your own system is that you can create one that makes sense to you and your community. The established systems can be confusing, and even trained experts sometimes have trouble using them. The subject categories (see below) in the established systems often seem arbitrary

² The terms catalog and shelf list are often used interchangeably. The main difference between them is that a shelf list records the books in the same order they appear on the shelves, whereas a catalog may list the books in any order and may have several listings for each book (e.g. subject, author, title – see Advanced Organizing Ideas below).

and not very intuitive. However, setting up your own system for sorting books is not recommended by many professional librarians because they feel that home-made systems inevitably run into problems. The disadvantages are that other librarians who replace you may find the system hard to use, your readers will have to learn a whole new system if they visit another library, and your system may not be able to handle expansion easily. Reading the next two sections will give you a better understanding of how books are sorted into categories and help you decide which system to use.

CREATING YOUR OWN SYSTEM FOR SORTING BOOKS

As mentioned above, the purpose of organising the materials in the library is to make it easier for the librarian and the users to find information. In most libraries, the users are allowed to browse the shelves to find what they need. It is very helpful in these circumstances if similar books are located near each other.

Library users often ask questions such as, “Where are all the books about cooking?” or another topic. If finding a single book in the library is like finding a friend in a community as described above, then finding all the books about cooking is much like finding a family. If all the family members live together in one part of a community, then finding them is easy. If, however, they are scattered around, it would be hard, if not impossible, to find them all. To make it convenient for the users, you should put all the books from one “family” together. However, first you will need to decide which “family” or category each one belongs to. Here are three broad categories to start with:

1. Non-fiction – these books generally contain *facts* about a subject, such as forestry or cooking.
2. Fiction – these books are about imaginary situations, people and places. The main types of fiction are novels, plays, poetry and stories.
3. Reference books– these books contain important information that people need frequently. Users are not generally allowed to borrow them (see *Circulation* below) so that everyone can have access to them in the library. They are often expensive and hard to replace. Examples include dictionaries, atlases, encyclopaedias and almanacs. You may wish to include textbooks or other frequently used books in this category (see below).

The first step in sorting your books is to divide them up into these three broad categories. These categories, however, are too large to be of much help in organising the library. You therefore need to divide them into smaller groups. Non-fiction books are usually sorted by subject, fiction books are sorted by author and reference books are usually sorted by type (e.g. dictionary, atlas, etc.).

The majority of the books in the library will probably be non-fiction. In order to sort the non-fiction books by subject, you will need to either create your own subject categories as described here or use the DDC subject categories (see the next section). Sorting the non-

fiction books by subject makes it easier for users to find all the books on one topic. You may wish to sort the books by reading level in addition to subject. In a school library, you might even want to separate the books by grade level or have special shelves for each class.

Creating your own subject categories means making a list of the main topics covered by the non-fiction books in the library. If you made a list of subjects to include in the library as part of the collection policy, you can use that list as a starting point for your subject categories. If not, re-read *Getting Materials* now. Then consider what subjects are most often requested by community members and/or are likely to be requested in the future. Pay special attention to the words that people use to describe subjects (e.g. do people say “family planning” or “birth control”). There are often many different words for the same subject, but you can only use one as the name of the subject category. To make it easier for library users, try to use the words most familiar to people in your community.

When creating subject categories, it is generally best to start with broad categories that can be divided later instead of very narrow ones. For example, you might use the broad term mathematics instead of the narrow term arithmetic. Mathematics includes arithmetic, geometry, algebra and other mathematical subjects so you do not need to make separate subject categories for each of these topics.

If you find that the number of books in a category is getting too large, you can divide it into sections. For example, you might start out with one category for agriculture and later find that you need to make a section for books on gardening because it is such a popular topic (see figure 9 below). Making a gardening section within agriculture will make it easier for people to find the gardening books without moving them away from books on related topics in agriculture, such as plant diseases or fertiliser.

Here is a list of some general subjects to help you make your subject categories. You may use some, all, or none of them depending on the books in your collection. You can also create your own categories. An environmental library will obviously need to use different categories than a health library. Urban libraries may have different categories than rural ones. Larger libraries may need more categories than smaller libraries:

Agriculture – books related to growing food crops or raising animals for human use. There are many topics in agriculture such as animal and plant diseases, controlling pests, grain storage, irrigation, fertiliser, fisheries, poultry farming and many others. You may need to make sections for some of the most popular topics in the agriculture category.

Arts/crafts – includes books about artists, how-to books for different handicrafts such as weaving or pottery and books about arts and crafts from different periods or parts of the world.

Business – books about how to start a business, business practices such as accounting or bookkeeping, business trends, banking and other related topics.

Education/training – materials about education and teaching. This also includes training programs or manuals and teacher’s guides. You could put textbooks here as well, or keep them separate if you have a lot of them.

Environment – materials about how humans interact with their surroundings. This includes water pollution, air pollution, ways to keep the environment safe and clean, how to protect natural resources such as water, forests or animals and other topics that address the interaction between humans and nature.

Health – there are many topics in health such as sanitation, nutrition, first-aid, pregnancy and childcare, AIDS and many others. As with agriculture, you may wish to make separate sections in the health category for the most important topics.

History – materials about people and places from the past.

Nature – materials that describe the earth, sky, rivers, oceans, animals and the rest of the natural world.

People and places – materials about different countries or places that describe the climate, politics, culture, economy and general information about what it is like to live there.

Politics – this topic covers current world politics, different kinds of political systems, publications about different governments and how they work, elections and human rights.

Religion – this could include works about the world’s religions as well as religious books such as the Bible, the Koran, the Torah and other works.

Sports – materials that describe different sports, their rules and the people or teams that play them.

Textbooks – books used by teachers and students to prepare for lessons. Textbooks used in the local schools are usually in great demand. In fact, they may be some of the most popular and expensive books in the library. As a result, it may be wise to keep them in a special section near the librarian’s desk and only allow people to use them in the library, especially if you only have one set. You can shelve duplicate copies and textbooks not used in the schools by their subject or in a separate section and let people borrow them.

Trades/Technology – these books cover traditional trades such as carpentry, masonry, metal working, and tool making and newer trades and technologies such as auto mechanics, electronics, and telecommunication.

Once you have made your list of subject categories, test it out by sorting the books into the categories you have chosen. To do this, you will need a clean space, some large boxes and paper and pens for making signs. Label the boxes or put signs on the tables

and floor with each subject category. Then pile the books according to subject. It is not necessary to spend a lot of time determining the subjects of the books. You will do this carefully for each book later when you make the shelf list (see below).

Now look at your piles. Are some so big that it would be hard to browse through them? Do others only have only one or two books? Do you have a lot of books left over that don't fit into any category (try very hard to avoid this)? You may need to divide some categories and combine others. For example, if you are a rural librarian, you may find that your "agriculture" category is very large. To make it easier to manage, you could divide it into sections such as "gardening," "fisheries," "grain storage," etc. Creating sections within a category makes each subject easier to find, while still keeping related subjects together. Since each community has different information needs, each library will have different subject categories and sections.

It will be harder to adjust your categories after you make your shelf list so take plenty of time to make sure your categories and sections work before going on. In addition, try to imagine what categories you might need in the future. The decision to combine or divide categories should be based partly on whether or not you expect them to grow over time. Sorting the books also gives you a good opportunity to remove any damaged, old or unsuitable materials from your collection (see *Weeding* below).

MAKING THE SHELF LIST

Arranging the non-fiction books by subject category makes it much easier for people to find what they are looking for. But suppose that someone wants to find a book for which they don't know the subject category? For example, a book called *The History of Guatemalan Cloth* might be with the books about history, arts/crafts or people and places. If the user is not in a hurry, he or she could look on the shelves in all three places. But that could be very frustrating, especially if the user spends a lot of time looking for the book only to find out that the library doesn't have it. Librarians must also occasionally do an inventory, which means checking to see that each individual book is where it belongs. Having a record of the exact location of every book in the library makes it much easier for users to find a particular book and for librarians to do an inventory. If users at your library are not allowed to browse the shelves, then it is even more important to have a precise record of what books are available.

Such a record of where books are located is called a shelf list. It is a complete list of all the materials in the library according to their place on the shelves. You can keep this list in a notebook or on cards. Both methods and their advantages and disadvantages are described below. Before you begin making the shelf list, make a list of all the main subject categories that you have decided to use in the library. If you would like, assign colours and/or symbols to the subjects (such as a red cross for health or a yellow sun for nature). This will make it easier for new readers and children to find the books they want. Decide on a short way to write the subject, such as AG for agriculture or HE for

health (see the example below)³. This is called the subject code. If you have divided your subject categories into sections, you must also make section codes. Here are some sample subject and section codes:

<u>Subject Codes:</u>		<u>Section Codes for Agriculture:</u>	
Agriculture	AG	Animal traction	antr
Art/Crafts	ART	Fertiliser	fert
Business	BUS	Field crops	field
Education/Training	EDU	Fisheries	fish
Environment	ENV	Forestry	fore
Health	HE	Gardening	gard
History	HIS	General	genr
Nature	NAT	Grain storage	gran
People and Places	PEO	Plant diseases	plan
Politics	POL	(these are just a few examples)	
Religion	REL		
Sports	SP		
Textbooks	TEX		
Trades/Technology	TRT		

Now that you have created your subject and section codes, you are ready to assign them to the non-fiction books. Determine the subject of each book by carefully looking through the table of contents, introduction, index and text. Do not rely on the title alone! It is often misleading. For example, a librarian who glanced only at the title *What Color is Your Parachute?* might be tempted to put it with the sports books. One look inside the cover reveals that it is really a book about how to find a job and belongs in the business category. Many books have more than one subject. Since this system only allows you to choose one subject category for each book, you will have to use the subject you feel is the most important or main one.

Once you have determined the subject of a book and assigned it a subject code, you are ready to record it on the shelf list using one of the two methods described below. Be sure to keep a copy of all the subject and section codes with the shelf list.

1. The notebook method:

Materials

- One large ring binder (loose leaf notebook)
- Paper with holes punched in it that will fit in the binder
- OR* several regular school notebooks
- Black and coloured (optional) pens or pencils
- A ruler or straight edge for drawing columns

If you use a ring binder, make a separate section for each subject category. The advantage of a ring binder is that you can add paper to each section as needed. You can also replace damaged pages. The disadvantages are that ring binders sometimes cost more than regular notebooks and can be harder to find. The pages can also come out and get lost. If you use school notebooks, use a separate one for each subject category. This may seem wasteful at first, but it is necessary since you cannot add pages later. The advantages of using school

³ Using codes that follow the same alphabetical order as the full names of the subjects will make it much easier to arrange the subject categories and shelve the books.

notebooks are that the pages will not fall out as easily and they are generally less expensive and easier to find. The disadvantages are that you have more notebooks to keep track of and you cannot change the order of the pages or easily replace one page.

To make your shelf list, draw five columns on the notebook pages and label them subject, copy, title, author, supplier, date and value as shown below. Using one row for each book, fill in the columns as follows. In the subject column, write the subject code in capital letters. Write the section code below the subject code in lower case letters. If you have not yet created sections, leave a little room in the subject column in case you decide to add them later. If you have more than one copy of a book, assign each one a copy number and record that number in the copy column (you do not need a copy number if there is only one copy). In the date column, write the date the library acquired the book.

In the supplier column, write where you got the book. It will be very helpful to know this if you need to replace the book or get others like it. You may not have enough room to write the full name of the supplier in the column, but you can use a short code instead. In the example below, DBA stands for Darien Book Aid. Keep a list of all the supplier codes with the shelf list. In the value column, write the price the library paid for the book. If the book was donated, write the price listed on the book (usually found on the front or back cover or on the back of the first page). If no price is given, leave the column blank. Knowing the value will help you to decide how much to charge users who lose or damage a book (see *Making the Rules* above).

Figure 6: Sample shelf list notebook

Subject	Copy	Title	Author	Supplier	Date	Value
AG fish	1	Raise Better Fish	Dave Smith	DBA	1992	\$3.00

The notebook method is very inexpensive and requires few materials. One other advantage is that it is easy to make copies of a notebook shelf list for users. Making a copy for everyday use will prevent the original from getting damaged. Most larger towns have public photocopiers where you pay by the page, or you may be able to find an NGO or large library that would be willing to make a copy for free. The major disadvantage of the notebook method is that you cannot add new books and still keep the entries in the order that the books are kept on the shelves. This means that users must browse through the entire list of books in each subject category in order to find out if the library has the one they want and then browse the shelves to find it. If you decide to divide your subjects into sections, you will have to re-copy all the entries for that subject in order to list the books in each section together. The notebook method should therefore be used in only the smallest of libraries.

2. The Card Method:

Materials

Cards 125x74 mm. You can buy them or make your own from stiff paper.
Cards 125x84 mm to use as dividers.

A long narrow box or boxes to hold the cards. You can also get a special cabinet called a card catalogue that has drawers to hold the cards. Many larger libraries are getting rid of their card catalogues and replacing them with computers and might be willing to donate one.

Black and coloured (optional) pens or pencils

In this method, each book has its own card with all the information listed for the notebook method described above. For each book, write the subject code in the upper left hand corner of a card (see below). If you are using a colour or symbol for the subject, include that either above or next to the code for the subject. As in the notebook method, write the section code under the subject code. If you have not yet created sections, leave a blank space in case you need to add the section code later. Below the area for the section code, write the first three letters of the title as it appears on the first page of the book (the title page). If there is more than one copy of a book, write the copy number (c.1 in this example) below the first three letters of the title. In the centre of the card, write the complete title of the book on the first line. On the following lines, write the author, supplier, date the library acquired the book and the value (see *the notebook method* above). Since there is more room to write on the cards than in a notebook, you could also include the reading level, publisher or other information.

Figure 7: Sample shelf list card

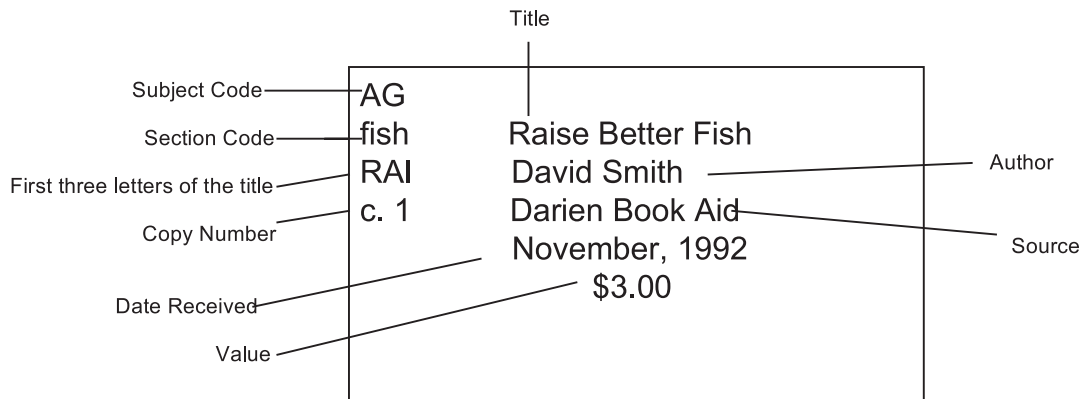

To organise the cards, use the taller cards to make dividers for each subject category. On each divider, write the full name of the subject category followed by the subject code. Arrange the dividers in alphabetical order (see the rules below). Using the full name of the subject instead of just the code (or symbol) will make it easier for users to find what they are looking for. Then place the book cards for each subject upright in the box alphabetically *by title*. You can rearrange and add cards as you add books. Card catalogue drawers have a rod that fits through a hole in the bottom of the cards, which holds them in place even if someone drops the drawer – a very useful feature. If you use boxes instead of a card catalogue, you can punch holes in the cards and make your own rod out of wood or simply tie the cards together with string. Leave enough room in the box so that you can see all the information on the cards as you flip through them.

Figure 8: Arranging book cards

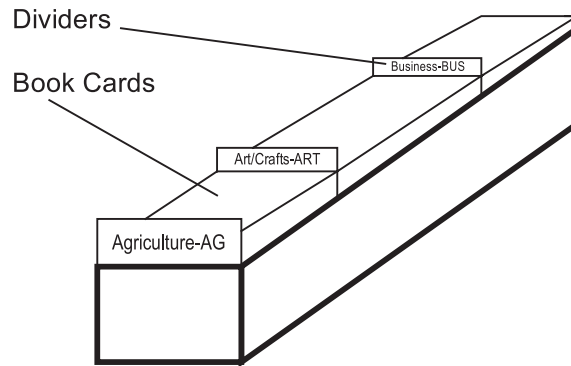

Here are a few rules to follow when arranging the cards alphabetically:

1. Using the first letter of the first main word in the title, order the cards from A to Z. Skip words such as “the,” “a,” or “an” when they appear at the beginning of a title.

Example: these three titles appear on cards

Life in Great Britain

The Australian Outback

A Day in the Life of Singapore

Place them in the card box in this order

The Australian Outback

A Day in the Life of Singapore

Life in Great Britain

2. If two words start with the same letter, use the second letter to decide which comes first.

Example: put these titles in this order

Bats and Other Rodents

Big Monuments

3. If several titles start with the same word, put them in ordering using the first letter of the second word.

Example: put these titles in this order

Games are Fun

Games for Groups

Games that Teach

4. If several titles start with different forms of the same word (e.g. garden, gardener, gardening), the shortest form comes first. Use the next letter to decide which of the longer forms comes first.

Example: put these titles in this order

Garden Plants

The Gardener's Guide to Pest Control

Gardening Made Easy

5. When titles start with a number, file them in the beginning of the section in order by number. If the number is written as a word, file it alphabetically.

Example: these titles go at the start of the section in this order

2 *Designs for Hats*

5 *Questions about Sewing*

Example: these titles are filed alphabetically

Seven Steps to Good Health

Two Exercises for a Healthy Heart

Despite the fact that the card method may be a little more work and/or money than the notebook method in the beginning, it has many advantages. Since each book has its own card, it is easy to fix mistakes or make changes. It is also easy to add new books. The cards hold more information than a notebook and can be arranged in alphabetical order.

If you decide to add sections to your subject categories, all you have to do is fill in the section code below the subject code on the cards, change the dividers and put the cards for the books in each section in order. On the new dividers, write the subject category in capital letters at the top, followed by the subject code. Then write the name of the section followed by the section code right underneath the subject category, as shown below.

Figure 9: Making sections

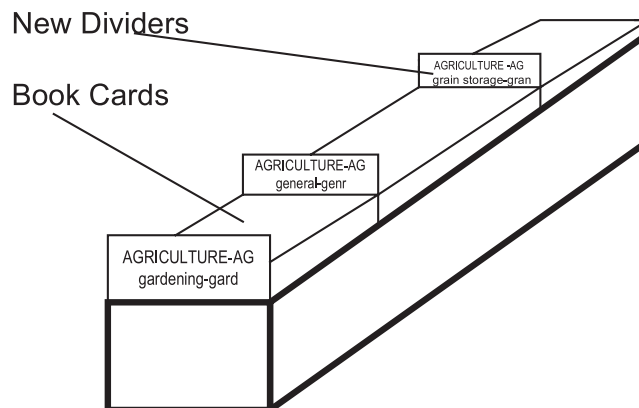

As mentioned above, fiction books are not given subject codes. Instead, fiction is usually shelved alphabetically by the author's name. Use a separate notebook or section in your card file to keep track of the fiction books. Where you would usually write the subject

code, write “F” for “Fiction.” If your library has a lot of children’s books, you can also use the code “JF” for “Junior Fiction” to separate the children’s fiction from the adult fiction. Then write the first three letters of the author’s last name under the “F” or “JF.” If you are using cards, write the author’s name on the top line in the middle of the card. Write the title, source, date and price beneath the author’s name, as shown in the example below. If you have more than one book by an author, arrange them alphabetically by title (see the rules for arranging cards above). Here is a sample card for a fiction book:

Figure 10: Sample card for a fiction book

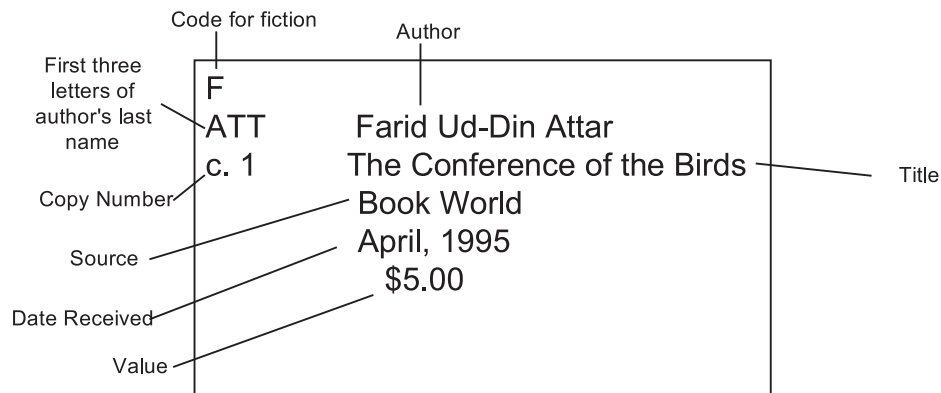

Reference books should also be included in the shelf list. Fill out cards for each reference book just as you would cards for non-fiction books using “REF” for “reference” in place of the subject code. If you would like, make sections for each type of book (e.g. dictionaries, atlases, encyclopaedias, rare or expensive books, etc.). Put all the entries for the reference books in a separate notebook or section of your card box alphabetically by title. Keep the reference books together on a shelf near the librarian’s desk so that he or she can keep an eye on them and help people to use them.

If you have materials other than books in the library such as audio or video tapes, maps, posters, pamphlets or periodicals (e.g. newsletters, annual reports, magazines or newspapers), you will need to keep these materials in separate areas so they don’t get lost among the books. You can put audio and video tapes on their own shelves. You can put the most recent issues of periodicals on a special table or shelf for people to read. Most libraries do not let people borrow periodicals because they are fragile, hard to replace and have current information that many people want to read while it is timely. When a new issue of a periodical arrives, store the old one with other back issues in stacks or boxes on the shelves in order by date.

Small items such as booklets or brochures are easy to lose, but may contain important information (see *Involving the Community* above). You can punch holes in them and store them in ring binders or make special storage boxes for them. The boxes illustrated below can be made out of cardboard or plastic or by cutting the top and sides off rectangular vegetable oil cans. You can also use browser boxes (see figure 5) to display odd-sized materials and/or magazines.

Figure 11: Boxes for pamphlets and other materials

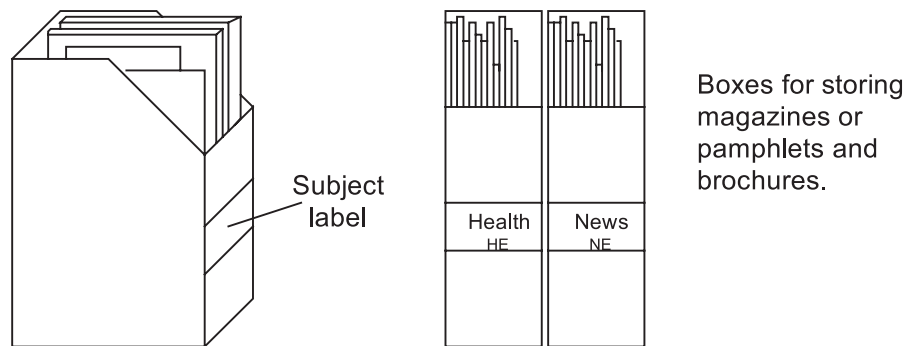

Another good way to store pamphlets and newspaper articles is in a vertical file. You can either use a file cabinet designed for this purpose, such as the one pictured below, or you can make your own vertical file out of a cardboard box. To make the file shown below, simply cut the top off a sturdy box that is wide enough to hold the materials you wish to store. Then make dividers for each subject from pieces of stiff paper or place your materials in file folders, which can be purchased at most stationary shops.

Figure 12: Vertical files

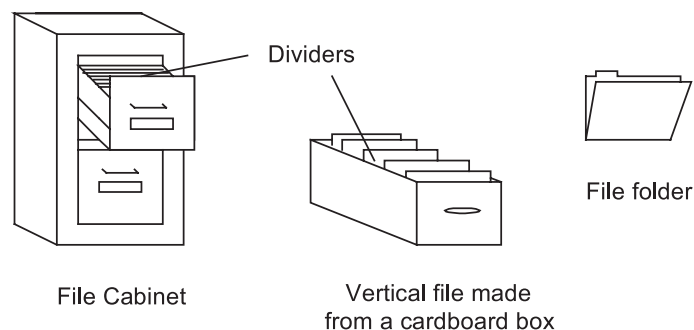

You may also want to add these non-book materials to your shelf list if they are a permanent part of the library (do not add things like meeting notices or other information that is only temporary). Give each pamphlet, video or audio tape a subject code (periodicals are addressed below) and make a shelf list entry for it as described for non-fiction books above. On the entry, write what the item is next to the title so that users will know where to look for it. You can shelve the video and audio tapes in order by title. Place all the pamphlets with the same subject code together in boxes or files as shown above. When library users find an entry for a video tape or pamphlet in the shelf list, you can direct them to the proper box, notebook, file or shelf to find it. If you find that adding these materials to the shelf list is too time consuming, simply encourage readers to check the vertical files and/or boxes often for new information on the topics that interest them.

Keep the records for periodicals separate from the rest of the shelf list. For each periodical, create a card or notebook with the name of the publication, address of the publisher (if you get it from a local distributor, also note that address), yearly cost, how often you are supposed to receive it (e.g. quarterly, monthly, weekly, daily), and when your subscription must be renewed. Record the number and date of each issue as it arrives. If issues are missing or late, you can write to the publisher to find out why or request another copy.

Figure 13: Sample periodical card

	Volume and issue number		
Title	Agbale Record		
Source	The World Library Partnership 1028 Bahama Rd. Bahama, NC 27503		
	Number	Date	
	Vol 1 No 1	4/5/97	Date received
	Vol 1 No 2	7/12/97	
	Price: Free Renewal: Not applicable Frequency: Quarterly		

Regardless of whether you choose the notebook method or the card method, it is very important to update the shelf list regularly. If books are stolen, lost or damaged, make a note on the shelf list. If you are using the card method, remove cards for books that are no longer in use in the library, but do not throw them away. Store them in a separate place so that you can see how many books have been lost over the years. Sometimes, a book that has been missing for several months will be found.

USING THE DEWEY DECIMAL SYSTEM

Instead of creating your own subject codes for the non-fiction books in your library, you could use the established codes from the Dewey Decimal Classification (DDC). One of the main advantages of using the DDC is that the codes in your library will be the same as those in countless other libraries around the world. Once you and your library users learn the system, you will be able to find books in many other libraries.

The DCC divides all of human knowledge into ten broad categories. Each of these categories is assigned a number. The ten main categories are each divided into ten more categories. In fact, you can keep dividing DDC categories to get very specific subject codes. Each division changes one digit in the code (e.g. 100, 110, 113, 113.4, 113.45 etc. – there is always a decimal point after the third digit). For small libraries, you may not need to go beyond the divisions given below⁴:

⁴ Summaries: DDC20. Albany, New York, Forest Press, 1989. 15 p.

The First Division:

000 Generalities
100 Philosophy & psychology
200 Religion
300 Social sciences
400 Languages

The second division:

000 Generalities
 010 Bibliography
 020 Library & Information Sciences
 030 Encyclopaedias
 040 Unassigned
 050 General serials & their indexes
 060 General organisations & museology
 070 News media, journalism, publishing
 080 General collections
 090 Manuscripts & rare books
100 Philosophy & Psychology
 110 Metaphysics
 120 Epistemology, causation, humankind
 130 Paranormal phenomena
 140 Special philosophical schools
 150 Psychology
 160 Logic
 170 Ethics
 180 Ancient, medieval, Oriental philosophy
 190 Modern Western philosophy
200 Religion
 210 Natural theology
 220 Bible
 230 Christian theology
 240 Christian moral & devotional theology
 250 Christian orders & local church
 260 Christian social theology
 270 Christian church history
 280 Christian denominations & sects
 290 Other & comparative religion
300 Social Sciences
 310 General statistics
 320 Political science
 330 Economics
 340 Law
 350 Public administration
 360 Social services; association
 370 Education
 380 Commerce, communication, transport
 390 Customs, etiquette, folklore
400 Languages
 410 Linguistics
 420 English & Old English
 430 Germanic languages
 440 Romance languages
 450 Italian, Romanian, Rhaeto-Romanic
 460 Spanish & Portuguese Languages
 470 Italic languages (Latin)
 480 Hellenic languages (Classical Greek)
 490 Other languages

500 Natural sciences & mathematics
600 Technology
700 The arts
800 Literature & rhetoric
900 Geography & history

500 Natural sciences & mathematics
 510 Mathematics
 520 Astronomy & allied sciences
 530 Physics
 540 Chemistry & allied sciences
 550 Earth sciences
 560 Paleontology
 570 Life sciences
 580 Botanical sciences
 590 Zoological sciences
600 Technology
 610 Medical sciences
 620 Engineering & allied sciences
 630 Agriculture
 640 Home economics & family living
 650 Management & auxiliary services
 660 Chemical engineering
 670 Manufacturing
 680 Manufacture for specific uses
 690 Buildings
700 The arts
 710 Civic & landscape art
 720 Architecture
 730 Plastic arts (sculpture)
 740 Drawing & decorative arts
 750 Painting & paintings
 760 Graphic arts (printmaking)
 770 Photography & photographs
 780 Music
 790 Recreational & performing arts
800 Literature & rhetoric
 810 American literature in English
 820 English & Old English literatures
 830 Literatures of Germanic languages
 840 Literatures of Romance languages
 850 Italian, Romanian, Rhaeto-Romanic
 860 Spanish & Portuguese Literatures
 870 Italic literatures (Latin)
 880 Hellenic literatures (Classical Greek)
 890 Literatures of other languages
900 Geography & history
 910 Geography & travel
 920 Biography, genealogy, insignia
 930 History of ancient world
 940 General history of Europe
 950 General history of Asia
 960 General history of Africa
 970 General history of North America
 980 General history of South America
 990 General history of other areas

As you can see, the DDC uses a lot of subject codes you will probably never need (chances are that if you don't understand it, you don't need it). Do not let this bother you. You should feel free to use only what you need. In some cases, such as agriculture, health, mathematics or any other broad subject on which your library has many books, you may need more divisions than those given above. In that case, try to get a copy of the abridged DDC or the edition for school libraries. *Setting Up and Running a School Library* by Nicola Baird (see the bibliography for information about where you can get a copy) contains the Junior Colour Code – a version of the DDC that uses colours as well as numbers for subject codes. Baird recommends the Junior Colour Code for libraries with fewer than 500 non-fiction books. It is much easier to use than the standard DDC and makes colour coding fast and simple.

To figure out the DDC subject code for a book, first determine its subject as described above. If the book has more than one subject, decide which one you think is the main or most important subject for your users. Then look at the first ten DDC divisions (000 - 900). Which one describes your book the best? If you only have a few books in that category, then simply use this number as the subject code.

Example 1:

You want to find the subject code for a book called *Aztec Sculpture*. Looking through the introduction and the table of contents reveals that the book is about carvings made by Aztec people. You look at the first ten DDC categories and decide that since sculpture is a form of art the subject code is 700 (the arts).

If you have many books on art, however, you may want to give this book a more specific subject code to make it easier to find.

Example 2:

You have already decided that *Aztec Sculpture* belongs under *700 the arts*. The second DDC division reveals that 700 is further divided into ten categories each with its own number (710 - 790). One of these categories, 730, is for sculpture. You therefore decide to use 730 as the subject code for your book.

As shown in these examples, it is possible to keep adding detail to your DDC subject code for a book. If your library contains a great many books about sculpture (e.g. a museum library), you might decide to sort the sculpture books into more categories. Using the next DDC division (not shown), you could assign your book 736 for “carving & carvings.” The full sequence of subject codes for *Aztec Sculpture* would then be:

700: The arts
 730: Sculpture
 736: Carving & carvings

If you still need more detail, you could put a decimal point after 736 and continue adding numbers until your book is in a category with just a few others. Only the final code

(736 in the example above), is written on the card (see below). As mentioned above, do not feel like you *have* to add any divisions beyond the first one. A technical library, for instance, would not have many books about art and could certainly use 700 as the subject code for all the art books. Remember that you are in charge and should only use what you need from the DDC.

To make a book card using the DDC, write the subject code in the upper left hand corner of the card. As in the sample book card shown below, write the first three letters of the title under the subject code. If there is more than one copy of the book, write the copy number below the letters from the title. On separate lines in the centre of the card, write the title of the book, the author, the source, when it was acquired and the value.

Figure 14: Sample DDC card

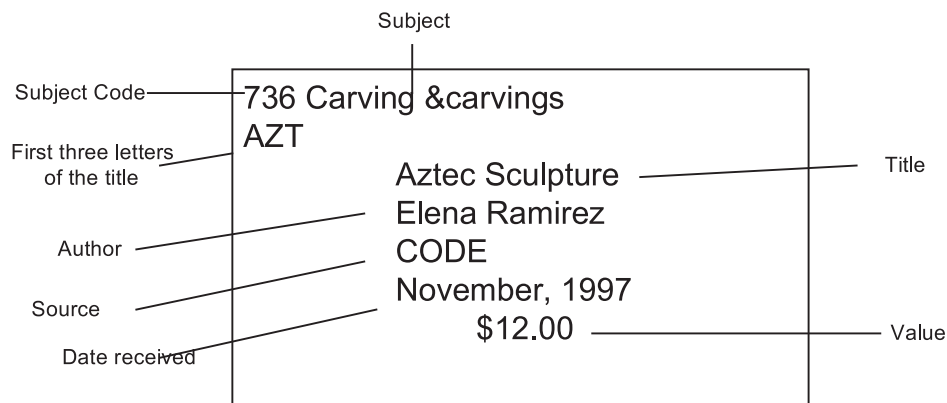

Once you have created DDC cards for the library books, you should arrange them by subject code in a card catalogue or boxes. When several books share the same code, put them in order by title. You must also make a separate subject index where users can look up the DDC code for different subjects, since they must know the codes in order to use the shelf list (also called a classified catalogue in this case). All that needs to be written on the subject index cards is the subject and the DDC code. Here are some examples of subject index cards:

Figure 15: Sample DDC subject index cards

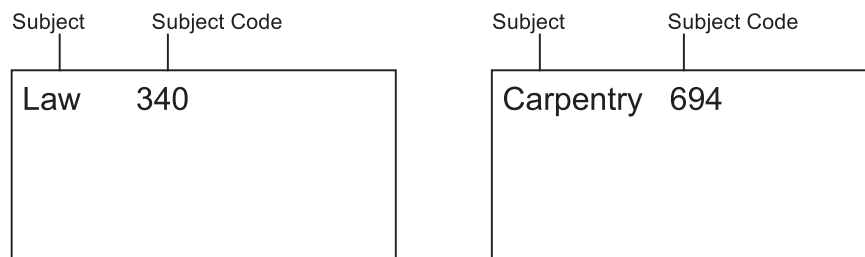

Arrange the subject index cards in their own box or drawer in alphabetical order by subject. If more than one word could be used to describe a subject, then make additional cards for those words. For example, “carpentry” can also be called

“woodworking.” To help users find what they are looking for, make a card that says “woodworking 694” just like the one for carpentry. Try to think of all the words the people in your community are likely to use to describe each subject and make cards for them.

The above examples of how to assign a DDC subject code are pretty straightforward, but the DDC can be confusing. For example, fiction is not supposed to be given a DDC subject code, but “literature” is. You can use the literature category (800) for collections of poetry, stories or plays by different authors. You can also use it for books about literature and for literature in foreign languages. The distinction between “fiction” and “literature” is just one example of how the DDC can be confusing.

This guide unfortunately cannot explain all the details of the DDC. In fact, there are few people in the world who can honestly claim to fully understand it all. If you have problems, try to find a more experienced librarian to help you. Remember that the important thing is not to get the DDC subject codes perfect (it is possible to spend far too much time worrying about this), but to get information to your users. The DDC is simply a tool to help you organise your library so that things are easy to find.

One great advantage of the DDC is that many books come with subject codes already in them. Once you know where to look, using the pre-assigned codes (or a shorter version of them) can save you a lot of time. When you open a book, the first page on the right side is usually the title page (sometimes there are one or more blank pages first). Not surprisingly, the title page contains the full title of the book and may also state the author, editor, publisher, date and other information. The back of this page is called the verso. The DDC code, if it appears, is usually on the verso near the bottom in very small print. It will look something like 025.1–dc19. The first part “025.1” is the DDC code. The second part, “dc19,” just means a librarian used the 19th edition of the DDC to assign the code.

LABELLING

Once you have completed your shelf list, you will need to label the books and the shelves so that you and the users always know where the books belong. On the spine of each book, write the subject code (and the section code if there is one). Also include any colours or symbols you have chosen to use with the subject codes (see above). Write the first three letters of the title as it appears on the title page under the subject code to make it easier to shelve the books in alphabetical order. Also write the copy number (if needed) below the letters of the title. You can use black and white permanent ink or labels to mark the books. You can make coloured labels by using coloured tape or by colouring white labels with markers or crayons.

Also write the subject and section codes and copy number on the inside cover of the book in case the spine label comes off. If the spine is too narrow to write on, label the upper left corner of the cover being careful not to write over anything important. You should also stamp the book with the name of the library in several different places so that people will know it belongs to the library. You can have a rubber stamp made at most stationary or bookshops. If you have trouble getting one, write the name of the library with permanent ink instead – use the kind that will not bleed through the pages.

Figure 16: Labelling the books

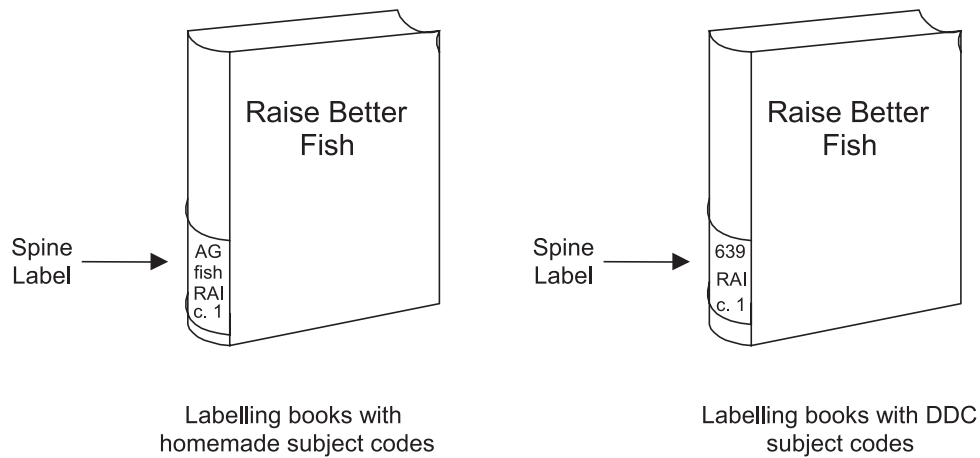

Once labelled, the books are ready to go on the shelves. If you use the card method, the books should be shelved in exactly the same order as they appear on the shelf list. It is standard to shelve books from top to bottom and left to right (see figure 17). Use the full name of the subject category followed by the subject code to determine the order of the books just as you did in the shelf list. This will make it make it easier for users to browse the shelves because they will not have to remember the codes. If you use the notebook method, the books should be in alphabetical order even if the shelf list entries are not. If you used DDC subject code numbers, the books should be shelved in order by number (e.g. 100, 101, 101.2, 101.23, 102 etc.)

Do not to pack the books too tightly and leave space at the end of the shelves for new books. When all the books are on the shelves, put up signs around the library indicating where readers can find each subject. If you have chosen to use colours or symbols for the subjects, put these on the signs as well as the subject codes. Put a subject label on each shelf. It is best to use tape or removable labels in case you need to expand or move subjects. You can use bricks or blocks of wood to indicate the sections. Tape labels onto the bricks with the name of the section and an arrow to show that the books for that section begin to the right of the brick (see figure 17). Put up signs on the ends of double-sided bookshelves to indicate which subjects are on each side. Also put up signs around the library with floor plans that show where the different subjects are. This will help users feel confident finding things on their own (see *Involving the Community* above).

Figure 17: Labelling the shelves

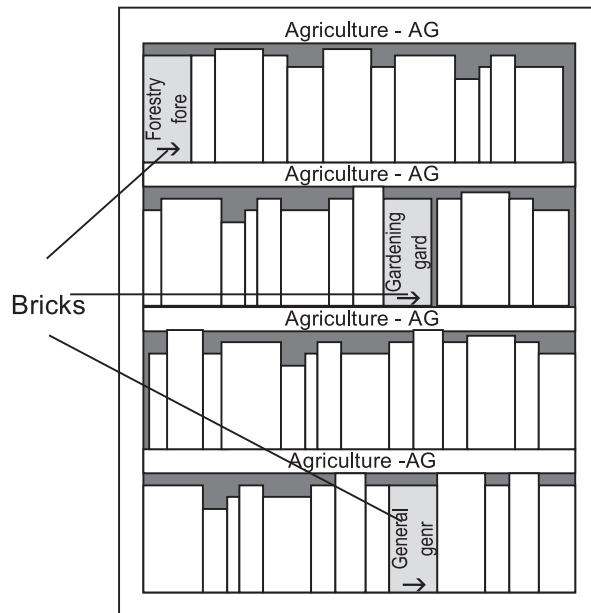

This bookshelf shows three sections of the agriculture section: Forestry, Gardening and General. Each section is marked with a labelled brick. The general section would be continued on the top shelf to the right.

When you have finished labelling the books and shelves, do not forget to make a list of all the subject categories, sections and codes used in the library. Most small libraries will be able to display this information on a poster.

If your library uses a large number of subject codes, you may need to create a subject index similar to the one described in the section about the DDC above. To create a subject index, simply make cards with the name of the subject category followed by the subject code. If you have divided your subject categories into sections, include the names of the sections and the section codes on the card for the subject category. Also make cards for each section that direct users to the proper subject category. *A subject index is really only necessary for larger libraries that use more subject codes than users can easily browse through, or for libraries using the DDC.*

Figure 18: Sample subject index cards for home-made categories

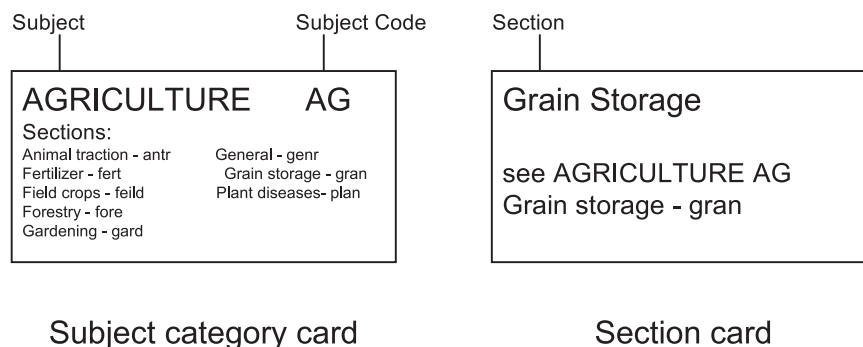

The card on the left shows the subject code for the category “agriculture” – AG. It also shows the section codes for that category. The card on the right tells the user that “grain

storage” is a section of the agriculture category. A library user who wants a book on grain storage should look in the shelf list under “agriculture” and then in the section “grain storage.”

One important feature of a subject index is that it can help users to avoid confusion when several different words describe the same subject. Imagine the frustration of someone who is looking for a book about multiplication, but doesn’t know that all the books on that subject are grouped together in a section called “arithmetic” in the subject category called “mathematics.” This person could waste a lot of time looking around the library for the arithmetic section before finally discovering that he or she should be looking for the mathematics section. You can make it easier for users to find subject categories by including related words or topics in your subject index with notes to see the proper subject category and section (if needed) as shown below.

Figure 19: Sample cards for related words

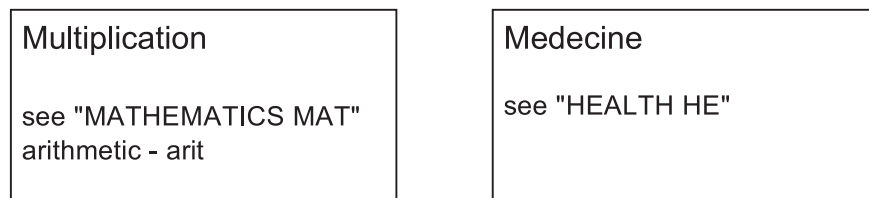

The card on the left tells the user that books on multiplication are located in the arithmetic section of the mathematics category. The card on the right tells the user that all the books about medicine are listed under the subject category “health.”

ADVANCED ORGANISING IDEAS

A shelf list is an important and useful tool for locating books, but for some libraries, it may not be enough. In a shelf list, each book has just one entry. The entry corresponds to the book’s physical location on the shelves. Since the books are shelved by subject, a shelf list allows users to easily find most of the books on a particular subject. But problems arise when a book has more than one subject. For example, a book about Chinese music could be shelved either with books about music or with books about China. If it is shelved with the music books, someone who looked under China would never find it. To avoid this problem, larger libraries usually make more than one card for books that have more than one subject. In that case, the book would still be shelved with the music books, but it would also have a card in the China section. This card would show that the book contains information about China, but that it is located in the music section.

Figure 20: Additional subject cards

Extra subject cards for homemade subject categories

ART	Chinese Music
mus	Ken Lee
CHI	The Book Shop
	June, 1997
	\$8.00

File this card with other cards for books about ART/CRAFTS

PEO	Chinese Music
china	
CHI	shelved at:
	ART/CRAFT ART
	music - mus

File this card with other cards for books about music

Extra DDC subject cards

780 MUSIC	Chinese Music
	Ken Lee
	The Book Shop
	June, 1997
	\$8.00

File this card in the 700's

915 ASIA	Chinese Music
	Ken Lee
	shelved at 780

File this card in the 900's

By creating several cards for a book, you can make it easier to find. Most larger libraries have author and title cards in addition to the subject cards used in your shelf list. These cards are usually organised into separate author, subject and title catalogues. The catalogues allow users to find all the books by a particular author, even if they are about different subjects, or to find out if the library has a particular book when they only know the title. Some libraries even have geographical cards that allow users to look for all the books that have information on one country, even when they are shelved under different subjects. If you use these additional cards, remember to remove all of them when a book is lost or discarded. For additional information about how to make and use title and author cards, see the manuals listed in the bibliography. Here are sample subject, author and title cards for *Raise Better Fish*:

Figure 21: Sample subject, author and title cards

Subject, title and author cards for homemade subject categories

Subject card	Title card	Author card
AG fish Raise Better Fish RAI David Smith c. 1 Darien Book Aid November, 1992 \$3.00	AG fish Raise Better Fish RAI David Smith c. 1 Darien Book Aid November, 1992 \$3.00	AG fish Smith, David RAI Raise Better Fish c. 1 Darien Book Aid November, 1992 \$3.00

DDC Subject, title and author cards

Subject card	Title card	Author card
630 Agriculture RAI Raise Better Fish c. 1 David Smith Darien Book Aid November, 1992 \$3.00	630 RAI Raise Better Fish c. 1 David Smith Darien Book Aid November, 1992 \$3.00	630 RAI Smith, David c. 1 Raise Better Fish Darien Book Aid November, 1992 \$3.00

Remember that subject, author and title cards are optional for small libraries. Although they are undoubtedly very helpful, do not feel obligated to use them if you are already overwhelmed or over-worked. It is more important to get the books onto the shelves in a timely manner than to have three (or more) cards for each book.

Action Steps:

1. Decide if you need to make a shelf list (if the answer is “no” skip the rest of this list).
2. Create subject codes or use the ones from the DDC.
3. Assign each book a subject code.
4. Decide if you want to use the notebook method or the card method to make your shelf list.
5. Gather the materials you will need.
6. Make a shelf list according to the instructions for the method you choose.
7. Label the books.
8. Put the books on the shelf.
9. Label the shelves so that readers can find the books.
10. Make a poster or index with all the subject codes used in the library.
11. Update your shelf list frequently.

CIRCULATION

Decision point: How do I keep track of books that leave the library?

If the library committee has decided to let readers borrow books from the library, you will need to have a system for keeping track of who has the books and when they are due back. As with cataloguing, there are many different systems for keeping track of

borrowed books. Some are more complicated and expensive than others. Two simple methods are presented below. Keeping the system simple will make it easy to use and increase the chance that people will follow the rules.

Before you begin lending out books, you need to register your borrowers. This means writing down information about how to contact them in case they forget to return a book. If your library charges borrowers a yearly fee (see *Making the Rules* above), registering them can help you keep track of who has paid. For each borrower, record the following information: name, address or neighbourhood (or any other information you could use to send them a message), and the date they paid their borrower’s fee (if applicable). For children, also include their age, parents’ names and school. It is best to write this information on cards and place them in a box alphabetically by family name.

Using cards makes it quick and easy to find information about any borrower. If you choose to use a notebook, divide it into sections for each letter of the alphabet. Address books are available at most stationary or bookshops and are already divided in this way, or you can make your own from a ring binder (recommended because you can add paper to any section). You can also make an address book by gluing tabs into a regular notebook. If you use any type of notebook, you will have to look through all the entries in a section each time you want to look up a borrower. You can register borrowers the first time they borrow a book. Once borrowers are registered, use one of the following method to keep track of the books they use.

1. Circulation Notebook:

Materials

- A large notebook (any type)
- A ruler or straight edge for making columns
- Pens and/or pencils
- Some slips of paper
- Paste, tape or glue

Create your circulation notebook by drawing the following six columns on the pages of a blank notebook as shown: date, borrower’s name, book title, date due, date returned, and fines.

Figure 22: Sample circulation notebook

Date	Name	Title	Date due	Date Returned	Fines
April 10	Kofi Agbale	Tales from the Forest	April 24	April 26	10¢ paid
“	“	Grow More Vegetables	“	April 26	10¢ paid
April 14	Elena Rodriguez	Love in the Time of Cholera	April 28	April 27	No
“	“	Basic Accounting	“	April 28	No
“	“	Small Business Management	“	April 28	No

In the example above, borrowers were allowed to take out up to three books for two weeks. Ditto marks (“) mean that the information for a line is the same as the line above. If the books were returned on time and in good condition, the borrower was not charged

a fine. If the books were late, the borrower was charged 5¢ per day. If your library does not charge any fines, you do not need a fines column. Always record the return date so that you know which books have been returned and which are still out. If the library has more than one copy of a book being borrowed, you should also record the copy number next to the title so that it is clear which copy the user has.

Before letting someone borrow a book, you or your assistant should check to see if they are registered and then record the date, name of the borrower, title of the book and the due date in the circulation notebook as shown above. Then stamp or write the due date on a slip of paper that has been glued, taped or pasted onto the inside cover of the book so that the borrower will know when to return it. Remind users that they can borrow a book again if they have not finished reading it. This may encourage them to bring it back on time.

When a book is returned, record the return date in the circulation notebook and check the book for damage. If the book is on time and in good condition, write “no” in the fine column (if your library does not charge fines, you do not need to do this). If the book is late and/or damaged, record the amount of the fine and whether or not it was paid. You may wish to keep a separate list of borrowers who owe the library money and/or write this on their registration. By checking the registrations often, you can also tell when it is time for borrowers to pay their annual user fee (if your library charges one). Many libraries will not let people that owe money borrow more books until they pay the fine or fee. Check the due date and return date columns often to see which books are overdue and remind the borrowers to return them.

Writing down all of this information in a circulation notebook takes time. Many busy libraries therefore use a system involving cards and pockets to make it faster and easier to check out books. There are many card systems currently being used. One called the Browne Issue system is very popular in the former British colonies and is described in detail in *Running a School Library* by Colin Ray (see the bibliography). If your library checks out a large number of books each day, then you should think about using a card system. Consider visiting a library that uses such a system before setting one up in your library. Be sure to ask if the library purchases the book cards and pockets or makes them and how much this costs. Ask if you can try checking a few books in and out to see how the system works. Here is a description of a simple card system:

2. Card Circulation System:

Materials

Cards for information about each book
Card pockets (to be glued inside each book)
A box for holding cards
Stiff paper for making dividers
A ruler or straight edge for making columns
Pens and/or pencils
Some slips of paper
Paste, tape or glue
A date stamp (optional)

For each book, make a “borrowing” card. Write the subject and section code (or DDC number) in the upper left corner. Below that, write the first three letters of the title and copy number (if needed), just as you did on the shelf list card. Write the full title next to the subject code. Make two columns below the title for the name of the borrower and the due date as shown in figure 21.

Figure 23: Sample borrowing card

AG fish RAI c. 1	Raise Better Fish	
	Borrower's Name	Date Due
	Pao An	29/9/98
	Yawa Akpado	15/10/98
	James Smith	30/10/98
	Salvador Garcia	13/11/98
	David Lee	10/12/98

Glue a card pocket onto the inside of the back cover of each book. You can purchase these pockets from a library supply store (ask local libraries that use such a system where they get theirs) or make your own from stiff paper and glue or by cutting letter-sized envelopes in half. Glue a slip of paper onto the last page of the book opposite the card pocket. Write “Due Date” at the top of the slip. Place the book card inside the book pocket. The book is now ready to be borrowed.

Figure 24: Book with card pocket and due date slip

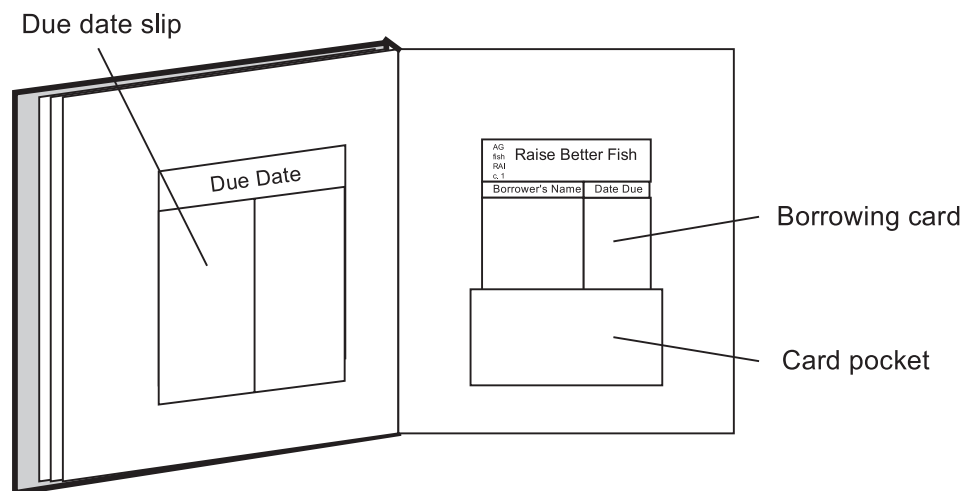

To check a book out, remove the borrowing card from the card pocket and write the borrower's name and the due date on the card. File the cards in a box by the due date using pieces of stiff paper to make sections for the dates. Also write or stamp the due date on the slip of paper you attached to the last page of the book so that the borrower will know when to return it. When a borrower returns a book, retrieve the borrowing card from the file and cross off the borrower's name (as shown in figure 21 above). Then replace the card in the card pocket and return the book to the shelf. This card system makes it very easy to check books out and see which books are overdue.

Although card systems make it faster to check books out, circulation notebooks have certain advantages that may make them worth the effort. A circulation notebook provides a record of all the books borrowed from the library. You can use this important information when evaluating the library and weeding the collection (see *Evaluation* and *Weeding* below). It shows how many books are borrowed from the library each month and which books are checked out the most often. Circulation notebooks can also make it easy to keep track of the fines people owe.

INVENTORY

At least once a year, you should take an inventory, which means checking to see if any of the materials listed on the shelf list are missing from the library. Close the library for a day (or more) and put all the books in order on the shelves. Starting at the beginning of the shelf list, check to see if every book listed is present. This is easiest with two people – one to read off the titles from the shelf list and another to look for the books on the shelves. If a book is present, write the date and a check mark on the shelf list (at the bottom of the book card or in the margin of the notebook). If the book is missing, check to see if someone has borrowed it. If someone has, write “out” on the shelf list next to the date. If you cannot find the book and no one has borrowed it, write “missing” on the shelf list and move on to the next book. The book may simply be shelved wrong, in which case you will find it later.

When you have completed the inventory, make a list of the books still missing. Give a copy of the list to the library committee and post a copy in the library. Over time, some books may be returned. If there are many items missing, you may need to improve security at the library and/or start an inquiry to discover what happened to the books (see *Controlling Theft*). You could even offer a small reward for their return.

WEEDING

Weeding a library serves much the same purpose as weeding a garden. Removing worn or damaged books makes room for new materials. It improves the appearance of the library and encourages people to take good care of the books. The yearly inventory gives you the chance to see if each book is in good condition. If not, you should set it aside to mend (see *Taking Care of the Books* below) or permanently remove it from the library.

Some books may be in perfect condition, but are really not appropriate for the library. Their contents may be old and outdated – perhaps even dangerous. They may be the wrong reading level for your library users or written in a language they do not speak.

Community members may not be interested in certain books because they contain information that is unrelated to their culture, customs or situation (for example, a book about how to ski would not be very relevant in Grenada).

It is sometimes difficult to convince members of the library committee that weeding is necessary. To avoid criticism, you should try to gain their support before removing any books. In the section *Getting Materials*, you worked with the community to create a collection policy. Use this collection policy now to remind the committee which subjects are most important to the community. Books on other topics may be taking up space that could be used for more useful materials. The circulation notebook described above is a record of which books have been borrowed from the library. You can use it to find out how many people have read a particular book. If no one has borrowed a book for a long time, it may mean that people are not interested in it. There may be other reasons, however, why people do not borrow a useful book. Showing that an outdated or inappropriate book is not being used supports removing it, but do not remove a book simply because it has not been borrowed without first trying to find out why (e.g. it may have been shelved wrong or the title may be confusing).

It may make committee members feel better about removing books from the library if you can find another use for them. You could try to sell unwanted books to raise money for new materials (do not sell donated books if this is against the donor organisation's regulations). Merchants may be willing to purchase old newspapers to wrap merchandise. Giving away back issues of magazines may encourage people not to take current issues. If there is a problem with the reading level, language or subject of the books, you could try to find another library that can use them. For example, a rural library might give a book on urban planning to a city library. You should never sell or give away books that contain outdated or false information. These books should only be used for scrap paper or fuel. If the committee absolutely opposes removing books from the library, try to get permission to at least take some books off the shelves.

Action Steps:

1. Register borrowers.
2. Decide if you plan to use a circulation notebook or a card and pocket system.
3. Prepare the notebook or cards as described above.
4. Check often for overdue books.
5. Record any fees or fines owed by the borrower and whether or not they were paid (only if your library charges fees and fines).
6. Do an inventory at least once a year.
7. Weed the collection at least once a year.

COMPUTERS

It is becoming standard for libraries to use computers instead of cards or notebooks to record information about books and users. When they work, and the library staff has good training, computers are *very* powerful tools. They enable library users to quickly and easily search for information in many different ways (e.g. by subject, title, author, key word or anything else recorded in the computer). Yet, the librarian only has to make one computer entry for each book instead of filling out several cards. Computers can

tell the librarian at a touch of a button which books are overdue, who has them and that person's address. Indeed, a computer is truly the best tool for keeping all the records in the library, if and when it works.

However, before you spend a lot of time raising money to buy a computer or even begin using a donated one to keep track of the library's collection, there are a lot of things you need to consider. If all of your records are on the computer, your library will be completely paralysed if it does not work. Unlike cards and notebooks, computers are sensitive to dust, heat and humidity. They break easily during transport and can only be repaired by highly trained experts. Replacement parts can be hard, if not impossible, to get and a reliable source of electricity is essential. Sometimes, computers manufactured in one country require an electrical converter to run in another country. Electrical surges can damage them, and power outages can cause information to be lost. Libraries in developing countries must often use second-hand or obsolete machines that are even harder to get parts for and more likely to break than modern equipment. It would be a tragedy to enter all the library's records into a computer only to lose that information when the computer breaks.

Another problem is deciding which "software" to use with your computer. Software is what makes it possible for people to use computers for different tasks. There is software for word processing, spreadsheets, databases, drawing, managing finances and many other tasks. Software can be very expensive, and not all software works with all computers. In general, the older the machine, the harder it is to find software for it. Without software, your computer would be useless – that is why many people are forced to replace older computers. It is beyond the scope of this manual to describe the many different types of software available. In the *Resource Guide*, however, there is a description of CDS/ISIS, which is an easy to use information storage and retrieval software package for libraries. It is distributed free to libraries in developing countries by UNESCO and is widely used throughout the world. Some of the organisations listed under "Book Donation Programs" and "Training" in the *Resource Guide* distribute additional information about using computers in libraries.

If you would like to fully explore the benefits and problems of using a computer to manage your collection, you should make arrangements to visit a local library that is already using computers (many university or national libraries – also see the "Library Associations and Networks" section of the *Resource Guide*). The librarian at such a library can give you invaluable information about resolving the problems mentioned above, as well as suggestions about where you can get software and training locally. Depending on the skills you have, you may need general training in the fundamentals of using and caring for a computer and/or specialised training in how to use particular software. Specialised training is absolutely necessary if you plan to use a computer for the library's catalogue.

If you are not absolutely certain that you will have the funding, technical support, training, software and other items necessary to maintain a computer, you should not use one to keep track of the library's collection. Instead, you could use a computer to write reports and letters, make a library newsletter, make signs, print book cards, play games and complete other tasks. You could also use it to create pamphlets, brochures or information sheets in local languages (see *Community Involvement* above). These are

tasks that even someone who has never used a computer before can learn fairly quickly with the right software and help from a good teacher. You can also raise money by teaching or hosting classes about using the computer and by letting the public pay to use it during certain hours.

In addition, you can use a computer with a CD ROM (Compact Disk Read Only Memory) drive to view many databases and multimedia materials. CD ROMs are small, durable plastic disks that can store as much information as a multi-volume reference set – complete with pictures, sounds and even video clips. Since they are small and easy to ship, many book donation organisations have begun offering CD ROMs.

If the library has a phone and the proper equipment and software, it can also use a computer to send and receive electronic messages (email) or browse the World Wide Web – a global network of computers containing an unlimited amount of information. Both email and the Web are good research tools and can be used to find out more about international organisations (email and Web addresses, called URLs, are included for most of the organisations in the *Resource Guide*). Libraries must have an account with Internet Service Provider in order to use email or the Web. “Internet Cafés” where people can pay to use computers hooked up to the Internet are becoming more common throughout the world. To find out more about the services available in your country and the cost, contact a university library or computer science department. Sometimes the phone company also has information about these services.

Action Steps:

1. Explore the costs and benefits of having a computer for the library.
2. Visit a library that uses computers.
3. Find sources for funding and training.
4. Decide if and how you want to use a computer in the library.

CONTROLLING THEFT

Decision point: How can I prevent the theft of library materials?

Unfortunately, there is no way to completely prevent book theft. Most libraries should expect to lose some books over the years and include the cost of replacing them in the budget. The surest way to prevent theft is also the most drastic – keep all the books under lock and key and only let users read them under supervision in the library. Since storing books in locked cabinets and only allowing the librarian to retrieve them is neither practical nor desirable for many libraries, try using some of the methods below to limit theft:

Community education – educate people about the value of the books for the community. Explain how removing books from the library hurts everyone and ask people to be on the look out for missing books. In particular, you might ask parents and teachers to set a good example and encourage responsible book use by members of their families. You should also make sure that merchants know what the library stamp looks like and where library books are stamped. Ask them not to re-sell any library books without checking first with the library.

Label the books – people are less likely to try to sell books that have the library’s name stamped or written on them. Be sure to stamp them in more than one place using ink that will not rub off. One good place to stamp them is along the edge where the pages come together because it is hard to remove marks from this area.

Keep accurate records – people are less likely to steal if they think they will be caught. You can find out which books are missing by doing regular inventories. You can identify borrowers who do not return books by keeping a circulation notebook.

Put wire mesh on all the windows – this works better than bars because people cannot pass the books through it.

Have only one door – it is easier for the librarian to keep an eye on people if they must enter and exit through the same door.

Check bags – ask people to leave their bags with the librarian while using the library.

Be selective – only lend books to people from the community. Visitors from other places may take the books home with them and not bring them back.

Use magazine folders – magazines and newspapers are small and easy to remove from the library. You can make it harder for people to take them by putting the current issues inside a large folder made of stiff paper or cardboard and passing a tiny lock through a hole punched in the folder and magazine or newspaper. You can reuse the folders and locks for new issues as they come in. Back issues are less likely to be stolen.

Take a deposit – require users to leave money or something else of value in exchange for the books. Return the money when they return the books. At least one library in Africa confiscates the shoes of students who do not return books on time. Needless to say, the students usually bring the books back quickly!

Involve the public – write a list of missing books and ask the public to help you find them. Someone may know who has them.

Offer a reward – this may work particularly well for school libraries.

Name names – you can ask religious or community leaders to read the names of people who have not returned books during public gatherings. While this is quite a drastic step, several librarians in Africa attest that it is effective.

Withhold diplomas or school certificates – school libraries should consider withholding the diplomas, certificates, exam results etc. of students who have not returned books at the end of the school year. Issue their diplomas when the librarian certifies that the students have returned or paid for the books.

Keep valuable books in the library – don’t let anyone borrow a book you cannot afford to replace.

Though it may be impossible to completely stop book theft, using the methods above can help to reduce losses. Over time, these techniques, when combined with community pressure, may have excellent results.

Action Steps:

1. Take an inventory of how many books are missing from the library.
2. Use the suggestions listed above to reduce theft.
3. If these suggestions do not help, you may need to change your lending policy.

TAKING CARE OF THE BOOKS

Decision point: *How do I take care of the books?*

Paper and books are very fragile. They can be damaged by sun, moisture, dust, dryness, and many insects find them delicious. The moment you put the books on the shelf, you expose them to potential harm. Here are some things that damage books and some steps you can take to fight them:

Moisture – is a disaster for any library. It dissolves paper and glue and encourages the growth of mould. The best way to fight the damp is to make sure that the roof and walls of the library are water-tight and that there is good ventilation. Using shelves with open backs promotes the flow of air. Leave enough space between the shelves and between shelves and the wall to allow air to circulate.

Direct sunlight – makes paper brittle and yellow. Use curtains, blinds or shutters to shield books from direct sun.

Dirt – one way to protect books from dirt and damage is to cover them. You can use old paper, plastic bags, special plastic covering available at bookshops or other materials to cover the books. The method shown below works well with old newspapers. If you cover the books with paper, remember to put a spine label on the cover as well as the book. You should also write the author and title on the front and spine of the new cover.

Figure 25: How to cover books

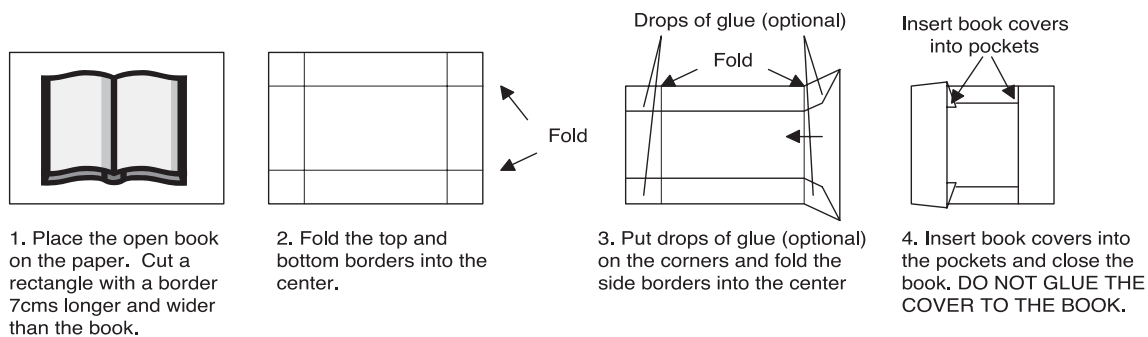

Insects – love to eat paper and glue. Regularly removing the books from the shelves and dusting them with a soft dry cloth (never use water) will help dislodge any insects that have crawled between the pages. If your shelves have legs, you can put them in

cans filled with water and a thin layer of oil, soap, or kerosene. You can also fill the cans with a solution made by soaking neem tree leaves in warm water overnight (replace this solution weekly). Be sure to move the shelves out from the wall or the insects will climb up that way instead. Never spray chemical insecticide directly on the books because it can damage the paper and may be unsafe for readers to handle. Talk to your local agriculture extension agent about safe plants, herbs and natural compounds you can use to repel insects. If the shelves don't have legs, consider putting them on bricks or blocks of wood treated as described above.

Figure 26: Protecting shelves from insects

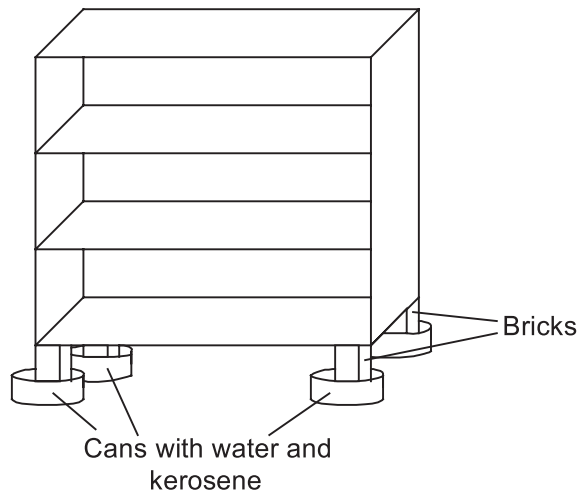

People – also damage books. It is important to educate library users (especially children) about how to care for the books they borrow or use in the library. They should always handle them gently with clean hands. They should never spill food or wax on them or tear or fold the pages. They should use a bookmark to keep their place instead of laying the book down with the pages open (this can crack the spine). They should never shut thick objects, such as pens, between the pages. The librarian should post the rules for handling the books, and any fines for damaging them, on a large colourful sign in the library (see *Community Involvement* above).

Of course, it is inevitable that some books will be damaged by normal use. You therefore need to have supplies on hand for book repair such as tape, glue, twine, rubber erasers, paper and cardboard. If a page is torn, apply transparent tape to both sides of the page so that the ends overlap and stick to each other. Then trim off the excess. Erase pencil marks by stroking gently in one direction with a soft eraser. Never wet or wash the books. You can reinforce the spines of books with heavy cloth tape or with cloth and glue. To make paperbacks last longer, glue cardboard to the insides of the covers. Choose cardboard that is strong, but not too thick. Then reinforce the spine with tape so that the covers do not rip off.

Here is a method you can use to re-cover a book that is falling apart. First remove the old covers and spine. Then carefully stitch together the pages making sure that they are

all there and in the right order. At the same time, stitch a piece of cloth in place over the spine. You may need to use a pin to punch holes in the pages a few at a time before threading the cord through the holes. Use very strong thread or light twine to securely bind the pages together. Then glue the new covers, or the old ones, onto the cloth and cover the spine, stitches and left edges of the covers with heavy tape or another strip of cloth. If the inside margin of the paper (the white space where the stitches go) is not wide enough, you will not be able to read some of the words once the pages are stitched together, so make sure you have enough room, at least 3cm, before you begin. Make your stitches about 1cm from the left edge of the paper so that the pages don't rip out easily. Since this method is very time consuming, use it only when the damaged book is valuable or hard to replace. Otherwise, discard the damaged book and replace it with a new one.

Figure 27: How to repair books

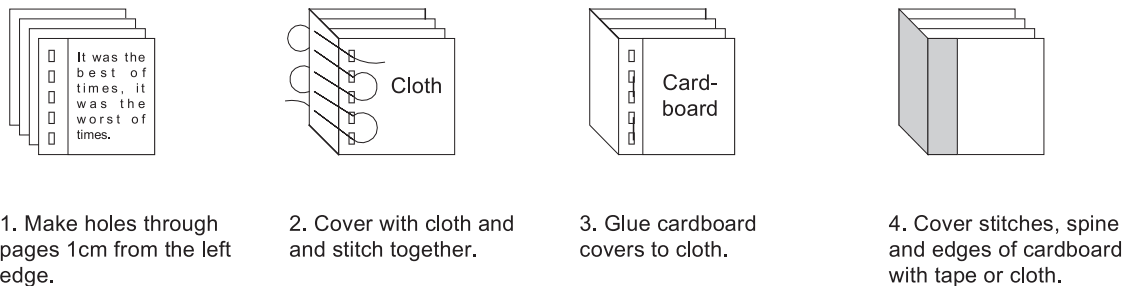

With proper care and cleaning, the library books will be a treasured community resource for many generations!

Action Steps:

1. Use some of the techniques mentioned above to protect books from moisture sunlight, dirt and insects.
2. Educate users about the proper way to handle books.
3. Promptly repair any damaged books.

EVALUATION

Decision Point: How do we find out how well the library is serving the community?

In order to find out how well the library is serving the community and what areas could be improved, you need to do an evaluation. Start your evaluation by finding out some basic facts about the library such as how many people use it, how many books they take out, whether this number is increasing or decreasing and what kinds of books are popular. Fortunately, you can find out most of these facts from the good records you keep. The circulation notebook tells you how many books are borrowed each month and which books are the most popular. Your shelf list tells you how many materials you have in each subject and when they were acquired. Your list of registered borrowers tells you how many people use the library and where they live. You can use these records to discover other facts as well, such as the number of children using the library or how many books were purchased in the last year.

Facts are only part of the picture, however, and you also need to talk to library users, and some non-users, to find out what the facts really mean. For example, you could discover from looking at the circulation notebook that the number of books borrowed has been dropping for the past few months. Is this because you haven't added any new books in a while, or because the literacy teacher moved to a new town, or because it is harvest season and people are too busy to read? It could be all or none of these things and your task is to find out which ones matter.

It is important to find out what people really think about the library and why they do or do not use it. There are many ways you can get this information. You could create a suggestion box, hold a community meeting, talk to people individually and/or ask library users to fill out a questionnaire. Make a special effort to find people who have never used the library, or have stopped using it, and ask them why. Ask the library committee to find out what their friends and neighbours think about the library. Then have a committee meeting to share what you have learned.

You should also make frequent reports to the library committee about the general status of the library. Let them know how the fundraising is going, how much money has been spent or received since the last committee meeting and whether or not you are within your budget. Also inform them if any materials have been acquired or lost and give an update on any programs at the library. These reports are crucial for good communication between you and the committee. They give you an opportunity to ask for help and suggestions, as well as to share your success stories.

There are many important uses for the information you gather about the library. If you find an increase in users, literacy, school performance or resources, use this information to demonstrate the success of the library to the community, local government and book donors. You can share this information by writing a letter to a local newspaper or library association, sending copies of a report to government officials and book donors or creating a brochure with facts about the library. Many donor organisations require this type of evaluation and will be happy to learn that the library is doing well and that they are supporting a successful project. Be careful, however, not to exaggerate the library's success. Ignoring problems will not make them go away. On the contrary, reporting things like theft or lack of funding for new books can get people involved in finding solutions. Reporting both the successes and the problems at the library will make people more willing to trust and help you.

Much of the information that you gather can be looked at in more than one way. For example, if you discover that the majority of the library users are elementary school students, you could decide to focus on buying more books of interest to them. Alternately, you might decide to expand your collection of books for older students and adults to encourage more of them to use the library. Neither idea is bad and it is up to the library committee to decide which is better for the community.

Similarly, you may find that more men than women use the library, or that some groups, such as the elderly or poor, do not use it all. You should talk with these groups to find out how the library can reach out to them. You might need to change the hours, lower fees, start a literacy class or create scholarships. If you take the time to do a

thorough evaluation, you can be confident that the library's policies will be based on good information. Please see *Rural Information Provision in Developing Countries: Measuring Performance and Impact* by Diana Rosenberg in the bibliography for more suggestions about how to evaluate and improve the library's services.

Every time you evaluate the library, be sure to share your findings with the community. Prepare a report summarising the information you gathered. If you have made any policy changes based on your findings, inform the community and ask people what they think of the changes. Always remember that the library is there to serve the community and could not exist without its support. Good communication between the librarian, the library committee and the community is the key to building a healthy future for the library.

Action Steps:

1. Use the library's records to gather facts.
2. Talk to library users and community members to help you interpret the facts and get suggestions.
3. Use all the information from the records and the community to set policies for the library.
4. Report your findings and any policy changes to the community.

EXPANSION

Decision point: When should we expand the library?

When you no longer have enough space in the library for all the readers and books, it is clearly time to expand. You may also need to expand when you notice that fewer people are coming to the library because nothing new has been added in a long time, or because they can never get the books they want. As always, people must not only want there to be more space for the library, they must also be willing to raise the money and/or donate the labour and materials needed. A good way to judge if the community is ready for this next step is to ask for volunteers to serve on a special library expansion committee. You might want to ask several carpenters, masons, roofers and other builders to be on this committee. Unlike the library committee, which is generally a small focused group, your expansion committee should be large. There will be plenty of tasks for everyone. Since expansion may be very expensive and time consuming, you should make sure that people are committed to a long-term effort.

Action Steps:

1. Decide if community interest and lack of space justify expansion.
2. Recruit volunteers to help.

Decision Point: How should we expand the library?

Expanding the library can mean anything from adding shelf space to constructing a new building. The bigger the project, the more time, money, effort and resources it will take, so you might want to start by looking for small ways to improve the situation. You can make more space for books by using rows of double-sided shelves instead of single-sided

shelves against the wall (see figure 28). Rearranging the furniture or buying new furniture made to fit the library can also save space. Giving away or selling used or worn out books can make room for new books. As mentioned above, yearly weeding and the inventory are a great opportunity to remove books that are no longer useful. If part of the library is being used for storage or as an office, try to move those things elsewhere.

Figure 28: Saving space with double-sided shelves

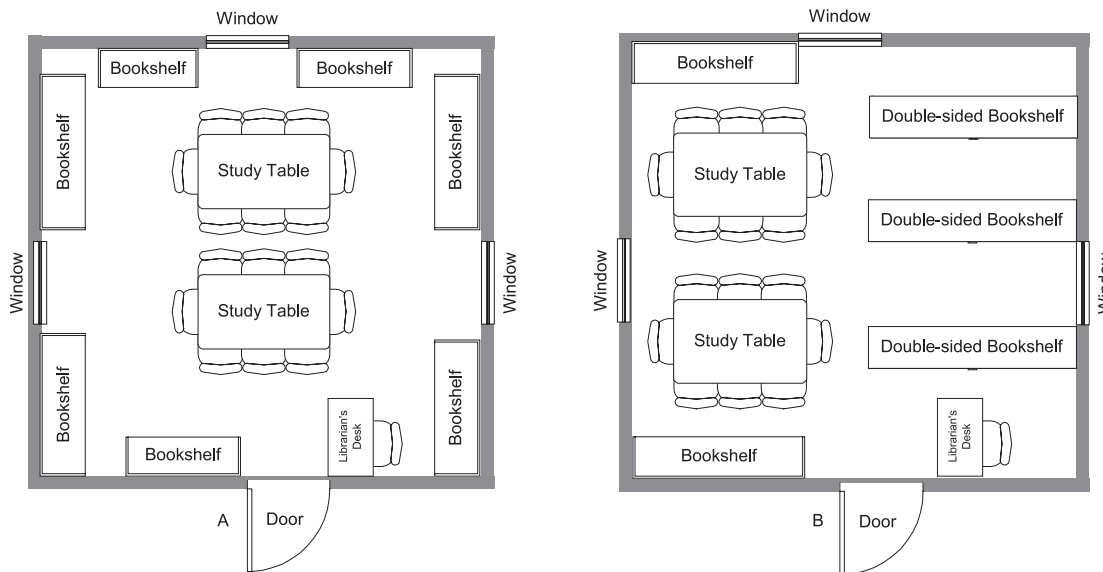

Library B has twice the shelf space as library A because it uses double-sided shelves.

If the library is still too crowded after making these changes, try to move to a different location or expand the space you have. Could you get a bigger room at the school? Is there space in the church or community centre? Does someone own an old building you could fix up in exchange for the right to use it? You could make more room for students by building an inexpensive porch on the front of the library or by building covered study areas in the school yard. If the climate is warm, a simple thatched roof supported by poles may be all you need. Sometimes, it may be possible to combine two rooms by knocking out a wall or putting in a door. Adding onto a structure may also be more economical than building a new one. You can add rooms to the back or side of a building. You can even build a second story.

Finally, if none of these measures work, it may be time to construct a new library. The great advantage of this is that you can design the new building to have all the features most important for a library. Often, libraries located in buildings or rooms designed for another purpose lack adequate light, ventilation and security. Your new library will have all that and more, but it will also cost you and the community some time and money. Here is a list of some things to consider when designing the library:

Location – choose a place that is centrally located and does not flood during the rainy season. If possible, get enough land so there will be room for expansion if needed in later years.

Light – readers need bright places to study, but books are damaged by direct sun. It is therefore a good idea to locate most of the windows near the study areas and away from the books. Planting shade trees near the building or using curtains or blinds to filter the light also helps. Direct sun can cause eyestrain in addition to book damage. Another option is to use skylights over the study tables. If you use tin roofing, you can replace one or two pieces with transparent corrugated plastic roofing. It is relatively expensive, but you only need a little bit. If you are planning to install a ceiling below the roof, leave openings for the light. If you prefer, you can cover the openings with pieces of plastic roofing, sheer cloth, or other transparent materials. Unless you have reliable electricity, provide kerosene or battery powered lanterns for night-time study and cloudy days.

Moisture – books mould quickly if kept in a damp dark place. This is another reason why you need to have windows in the library. Allowing air to circulate through the building and indirect sunlight (e.g. filtered through a curtain or blind) to fall on the books will help to keep the mould under control. Air circulation is increased by using shelves without backs. You will have more space for shelves if you locate the windows high in the wall. Be sure that the roof overhangs the walls enough to prevent any rain from entering and that leaks are repaired promptly.

Temperature – in hot climates, ventilation is just as important for the people as it is for the books! Leaving space between the top of the walls and the roof will allow the hot air to escape. Installing a ceiling and planting shade trees help to cut down on the amount of heat transmitted to readers by the sun beating down on the roof. Thatch roofs tend to absorb less heat than tin, but they can be leaky and require more maintenance. In a cold climate, you may need to install a stove or fireplace. In these areas, the walls and ceilings should be thick and air-tight to keep in the heat.

Security – you should install window bars, screens and/or locking shutters to prevent theft. There should be only one door to make it easier for the librarian to monitor comings and goings, and it should be solid and secured by a good lock (dead-bolts are the best) when the library is not in use. Never lock the door when the library is being used so that people can get out quickly in case of an emergency.

Space – this is really the most important thing to consider when making your plans. Cost will probably determine how large you can make the library, but even the smallest building must have space for books, a work area for the librarian and a comfortable study area. If you are able, also include areas for activities and displays and plenty of space for growth. The layout and furniture for the library are discussed in more detail below.

Materials – libraries can be constructed from a wide variety of building materials. A Peace Corps Volunteer in Namibia even worked with a community to build one out of discarded bottles and cement.⁵ Choose materials that are locally available, durable and suited to the climate. Weigh the advantages and disadvantages of different materials. Cement blocks and tin roofing may be more durable than mud bricks and thatch, but they may also be more expensive and difficult to replace. Where termites are a problem, you may need to avoid wood or raise the building on “legs.” Each leg should be surrounded

⁵ WorldWIDE News, Number 1, 1995. For more information, write to WorldWIDE Network, 1627 K St. NW, Suite 300, Washington, DC 20006 U.S.A.

by a trench filled with water and a mild insecticide such as soap. Books are extremely heavy for their size so make sure that the floor is very well supported.

Since it is too late to make changes once the building is finished, you should think about the placement of the windows, doors, shelves, study areas and work spaces before you begin construction. Include considerably more shelf space than you currently need or there will be no room for new materials. The floor plan below may give you some ideas for the layout of your new library. You can make your own floor plans by cutting out paper furniture shapes similar to the ones below and arranging them inside an outline of the library building.

Figure 29: Sample floor plan

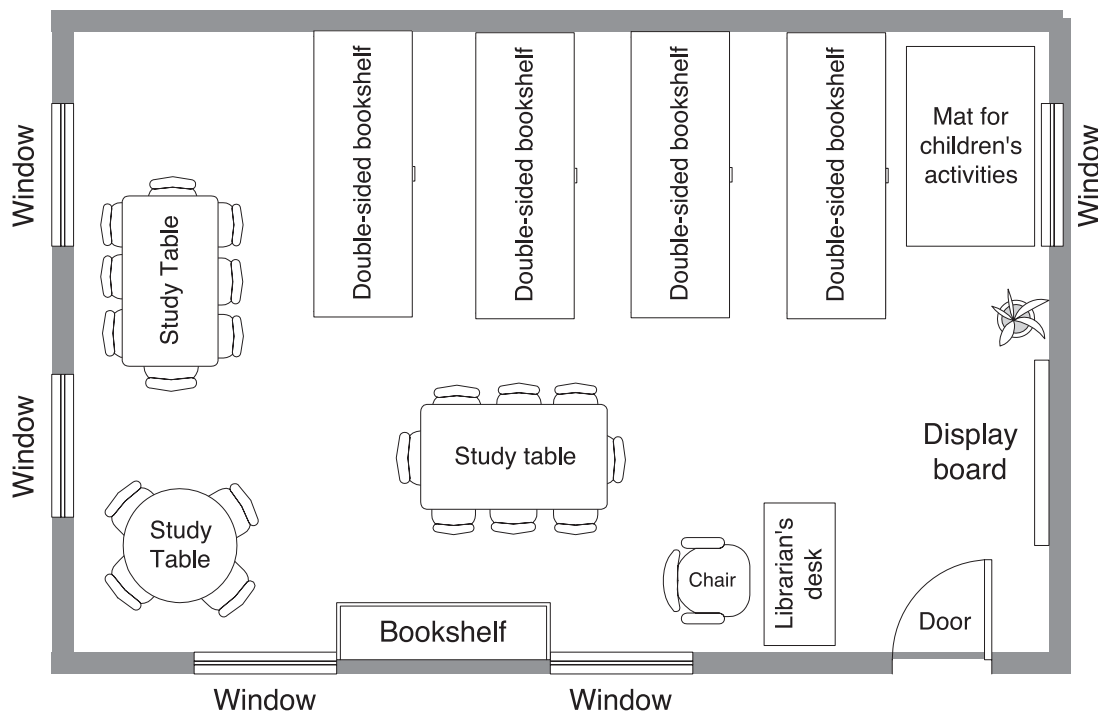

In the floor plan above, double-sided shelves were used to maximise space for books. The windows were located near the study areas where people need light and away from the bookshelves. There is only one door and it is located near the librarian's desk. This makes it easier for the librarian to see who is coming and going, and it makes it easier for the library users to see and approach the librarian.

The next largest expense after the cost of the building will probably be the cost of the furniture. In addition to the furniture shown in the floor plan above, you may also want to include a card catalogue, supply cabinet, vertical file(s), browser box and/or a display rack for periodicals. Try to get a library supply company to send you a catalogue or borrow one from another library. Local artisans can often make replicas of the furniture based on the photos or drawings in the catalogue.

Shelves can be made from many materials including packing crates, bamboo slats lashed together and/or planks supported by stacks of bricks. The most important thing is that

the shelves are very strong and have enough braces to support the weight of the books. If you use open-backed shelves, which is a good idea because they allow air to circulate, they should have braces stretching from corner to corner across the back to make them stronger. Avoid making the shelves so tall that people have difficulty seeing the books on the upper shelves or so low that they must stoop. Shorter shelves are good for the children's area or under windows where tall shelves can't fit. Since books come in all different heights, adjustable shelves are ideal. Brick and plank shelves are easy to adjust. Here is another model for adjustable shelves:

Figure 30: Adjustable shelves

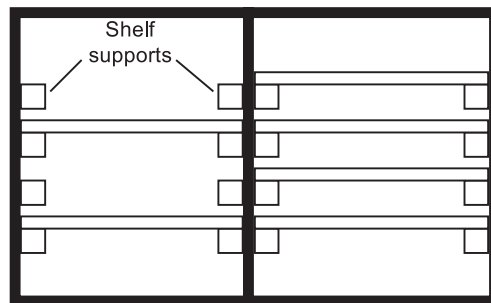

Use small pieces of wood as shelf supports. Adjust shelf height by using different supports.

You can also make other furniture from the materials available in your community. You can use boxes, benches, stools, oil drums or other materials for seating. Flour sacks or grain bags nailed to the wall make a good display area (attach notices by pinning them to the fabric). Children (and some adults) may prefer sitting on mats on the floor, which is very economical. As described above, you can make a vertical file from a cardboard box. You can move the furniture aside or stack it against the wall for special activities, such as puppet shows or other performances. As mentioned above, attaching a simple porch to the front of the library creates a very pleasant and inexpensive study area in a warm climate. You can furnish the porch with benches and tables.

Once you decide on a plan for the building and furniture, you will have to figure out how much it will cost and whether or not you can afford it (see *Budgeting* above). Shop owners, carpenters and masons can help you estimate prices. You can reduce costs by getting land, materials and labour donated. Offering to feed the workers lunch while they are on the job, inscribing their names on a plaque or sign in the library and/or honouring them with a party are good ways to encourage people to volunteer or donate supplies. Using materials available in the community will cut down the transportation costs and make repairs easier. See the section on raising funds above and the *Resource Guide* in the back of the manual for suggestions about how to raise money to pay for the labour and supplies you cannot get donated. When you are making your plans, be sure to remember that maintaining a building also requires labour, materials and money. It is very discouraging to construct a new library only to have it looking shabby in a few years due to lack of maintenance, so make sure you have a long term maintenance plan before you begin construction.

Action Steps:

1. Decide how you want to expand the library: rearrange the space you have, move to a different location or build a new building.
2. If you decide to construct a building, list all the features you would like it to have.
3. Plan a building that will meet all of your needs.
4. Ask people to donate land, labour and materials for the building.
5. Raise money for the things you cannot get donated.
6. Decide if you can afford the building you have planned, and if not, change the plan.
7. Decide how you will pay for maintenance.
8. Start building!

As you use this manual and resource guide, remember that every time your work helps one community member find the answer to a health question or learn a new skill, you make the community a better place. If your work helps one person learn to read, it gives that person the key to a new world. A successful library promotes the love of reading. It does not matter if the collection is small or the shelf list imperfect as long as the library encourages the community to read, discover and learn. Reading gives people power to change their lives and communities. Congratulations for caring about books and helping others to care!

KEY WORDS

Balance Sheet – a list of income and expenses by date.

Book Jobber – also called a “purchasing agent,” is a company that orders books for libraries.

Book Plate – a label with the name of the library that can be glued onto a blank page at the front of a book (see figure 1). It can have space for the name of the person or place that donated the book.

Browser Box – a place to put interesting or new materials that you want users to see.

Card Catalogue – a cabinet with drawers for holding book cards.

Catalogue – a complete list of the books in the library. Some common types of catalogues are author catalogues, subject catalogues (classified catalogues) and title catalogues.

CD ROM – (Compact Disk Read Only Memory) a small disk made of metal and plastic used for electronically storing databases, text, images, sounds, and software.

Collection Policy – a written description of what materials the library would like to have (e.g. most important subjects, languages, reading levels, age, etc.) and how donations will be used. It may also describe materials the library does not want (e.g. damaged, outdated, sexist, racist, etc.).

Classification – the process of sorting non-fiction books into different subject categories.

Consensus – when all the members of a group reach an agreement on an issue or decision.

Circulation – the process of lending books to users.

Dewey Decimal Classification (DDC) – a standard system for sorting non-fiction books by subject.

Distance Learning – courses taken by post or using the Internet.

Email – electronic messages sent from one computer to another using a phone line and the Internet (see below).

Fiction – materials about imaginary characters, places or events (e.g. stories).

Information Resources – all of the ways that people get information including books, newspapers, radio, television and other people.

Interest – money paid by the bank to people holding accounts with a positive balance. People who owe money to the bank have to pay interest to the bank. The amount of the interest is usually a percentage of the balance in the account.

Internet – an international network of computers that can be used to send and receive email (see above), access information on the World Wide Web (see below) and exchange information in other ways.

Internet Service Provider – a company that provides its customers with email or World Wide Web access. Customers are given a phone number they can call to connect their computer with the company’s computer (called a server). Your computer must be connected to a server in order to check your email or browse the Web.

Inventory – all of the materials in the library. “Taking inventory” means checking to see if any materials are missing from the library.

Junior Colour Code – a version of the Dewey Decimal Classification used by school libraries.

Line Item Budget – a list of all the library’s expenses and income by the type of expense (e.g. new books) or fundraising event (e.g. raffle).

Networking – the process of researching and contacting people and organisations that can help the library.

Non-fiction – materials that contain facts and information.

Non-governmental Organisation (NGO) – private groups working for the public good. They are also called charities, non-profits, aid organisations, relief organisations and other names depending on the type of work they do and the location.

Operating Manual – a manual describing the rules and procedures used in the library. It should include information about how the books are organised and circulated, how records are kept, the duties of the librarian and any other helpful information about running the library.

Periodical – any item such as a newspaper, magazine or annual report that is published regularly (periodically). Most periodicals have a volume number, issue number and/or date on the front cover.

Publisher – a company, NGO, government agency or other organisation that produces and distributes books, periodicals, teaching aids, CD ROMs and/or other resources.

Quorum – the number of committee members needed to make a vote official. It is usually at least half the members plus one.

Reference Book – books that contain general information on many subjects, such as dictionaries, almanacs, yearbooks and encyclopaedias.

Shelf List – a list of all the materials in the library according to their location on the shelves.

Software – products that enable people to use computers for certain tasks, such as word processing, drawing, bookkeeping, games, email, browsing the Web, etc.

Subject Category – a topic used for sorting books. The topics can either be selected by the librarian or taken from the DDC.

Subject Code – a short way of writing a subject category, such as HE for Health.

Subject Index – a list of all the subject categories and codes used in the library.

Suggestion Box – a box with a slot where library users can deposit written comments about the functioning of the library.

Term of office – the length of time that committee members serve as president, vice-president, treasurer or secretary.

URL – Uniform Resource Locator: the address of an electronic document or “page” on the World Wide Web (see below). In order to use a URL, you must type it into software for browsing the Web while your computer is connected to the Internet.

Vertical File – a box or cabinet with folders for storing pamphlets, clipping and other small items on different topics.

World Wide Web – part of the Internet that displays pictures, text and even sounds. For example, you can use the Web to look at street maps, hear the latest music from around the world, watch the news from different countries or find out more about the programs in the resource guide. To use the web, you need a computer, modem (a device for hooking your computer up to a phone line), phone line, Web browser software and an account with an Internet service provider.

RESOURCE GUIDE

Guides such as this one become out of date very quickly. As a result, you may wish to contact the World Library Partnership (WLP – see listing under “Other Resources” below) for updated information if you have any difficulty contacting these organisations. As a general rule, WLP can supply contacts for in-country partner organisations wherever they are mentioned in this resource guide. WLP also maintains a database of country-specific programs. You can write to WLP to get information about organisations supporting libraries in your country. WLP would also appreciate your help with identifying new programs. If there is a program you would like WLP to know about, please write to them at the address given below.

Most of the information in the entries requires no explanation, but “email” and “URL” may be unfamiliar terms. “Email” refers to electronic mail, which can be sent from one computer to another via phone lines. URL refers to the address of a “page” on the World Wide Web – an international network of computers. In order to send and receive email or view a page on the World Wide Web, you must have a computer, a phone line, the proper software and an account with an “Internet Provider.” Many NGOs and government offices have Internet service, and some may be willing to let you use it or get information for you. Some larger libraries and universities have public access Internet stations where you can view the World Wide Web and print out information. In addition, “Internet cafés” where people can pay to use computers hooked up to the Internet and email are becoming more common throughout the world. Hopefully, libraries will someday lead the way in bringing the Internet to the public.

BOOK DONATION PROGRAMS

The following list includes only organisations that work with small libraries. Programs that require recipients to pay for shipping, only donate university level materials or who showed no interest in working with small libraries have been omitted. Organisations that distribute books through partner organisations in developing countries and organisations that ship books in small boxes directly to recipient libraries have been included. PLEASE READ *Some Facts About Book Donation Programs* above before contacting any of these organisations. It contains valuable information about the book donation process.

ADIFLOR (Association pour la Diffusion Internationale Francophone de Livres, Ouvrages et Revues)

5 rue de la Boule Rouge

75009 Paris

Country: France

Phone: (33) 1 47 70 10 83

Fax: (33) 1 47 70 07 69

Email: adiflor@starnet.fr

URL: <http://www.starnet.fr/adiflor>

Contact: Mme Anne Nicolas du Parquett

Materials available:

Books and periodicals

Languages: French

Partner organisations:

ADIFLOR works with Alliance française, Mission laïque française, Ordre de Malte, Association des Bibliothécaires français (ABF). It distributes materials to Africa, Latin America and Central and Eastern Europe.

How to request materials:

Send details of the project, a list of materials needed and documents about the requesting association or organisation to ADIFLOR.

Agridoc

BDPA - Centre de Documentation et d'Information

27, rue Louis Vicat

75738 Paris Cedex 15

Country: France

Phone: (33 0)1 46 48 59 40

Fax: (33 0)1 46 44 75 44

Email: agridoc@bdpa.fr

URL: <http://193.105.38.1:81/cgi-bin/systex.cgi?REF=eslim.0.2.GUIDE&page=medapres>

Materials available:

Development and agricultural information

Languages: French

Partner organisations:

Agridoc is a development information network for Francophone countries in Sub-Saharan Africa and the surrounding islands. The network furnishes members with Agridoc (an international agricultural bulletin), question and answer services, photocopies of documents on demand and free access to the documents and databases on their web site.

How to request materials:

Membership is free for documentation centres concerned with rural development. To join, send a brief letter to Medagri describing the purpose of your organisation, its activities and your position in the organisation.

Asia Foundation

Books for Asia
451 Sixth Street
San Francisco, CA 94103
Country: U.S.A.
Phone: (1 415) 982-4640
Fax: (1 415) 543-8131
Email: tafbfa@igc.org
URL: <http://www.asiafoundation.org>

Contact: Matthew King, Director or Melissa Frakes, Office Supervisor

Materials available:

New, used and remaindered books in all educational subjects.

Languages: English

Partner organisations:

The Asia Foundation distributes books through its field offices in the following countries: Bangladesh, Cambodia, China, Mongolia, Nepal, Pakistan, Philippines, Sri Lanka, Thailand/Laos/Vietnam.

How to request materials:

Libraries should contact the Asia Foundation office nearest them (generally in capital cities) and ask about the Books for Asia Program. Write to the Asia Foundation to find out the location of the nearest field office in the countries listed above.

Association d'Aide à l'Équipement Scolaire (AESCO)

B.P. 61
45750 St.Pryvé St.Mesmin
Country: France
Phone: (33) 2 38 63 83 43
Fax: (33) 2 38 56 61 39
Email:
URL:

Contact: M. Loembe Gervais, President

Materials available:

School books, educational games, general reading

Languages: French

Partner organisations:

Aesco distributes materials in Guinea, Cameroon and Senegal.

How to request materials:

Send a detailed request to AESCO.

BIBLIONEF

48 bd. Diderot

75012 Paris

Country: France

Phone: (33) 1 43 40 75 10

Fax: (33) 1 43 40 75 24

Email:

URL:

Contact: Mme Dominique Pace, Vice President

Materials available:

New books for children and adolescents from publishers' overstock.

Languages: French, Dutch, Portuguese, Afrikaans, Zoulou, Sotho Xhosa

Partner organisations:

BIBLIONEF works with the Agence de la Francophonie (ACCT), French Cultural Centres, Alliance française and various NGOs and foundations. They distribute materials to Central and Eastern Europe, Francophone Africa, Asia, Haiti, Lebanon, Egypt, South Africa, Madagascar and Surinam.

How to request materials:

BIBLIONEF sends recipients a list of materials each month from which they can select the resources they need. Recipients are asked to contribute to the cost of maintaining the program and are responsible for paying the shipping costs.

Book Aid International

39-41 Coldharbour Lane

Camberwell London SE5 9NR

Country: U.K.

Phone: (0171) 733 3577

Fax: (0171) 978 8006

Email: info@bookaid.org

URL: <http://www.bookaid.org>

Contact: Carolyn Sharples (West Africa and Asia), Erica Lang (Horn of Africa, East Africa, Middle East and Pacific), Diana Ward (Southern Africa and Caribbean)

Materials available:

New and used books in good condition and no more than 15 years old. Book Aid offers books donated by publishers, schools, colleges, libraries and individuals. They also raise funds to buy books in areas that are rarely donated, such as key vocational texts. An important part of their work is to buy books published in Africa so that they can provide culturally relevant books and help African publishers meet the information needs of their countries.

Languages: English

Partner organisations:

Book Aid International gives practical support to a wide range of organisations working to promote education, training and publishing in developing countries. These include public libraries, schools and colleges. Book Aid gathers books and reading material in high demand and allows the professionals from these organisations to choose the materials they need. The point being that each local organisation knows what it needs and what it wants to do - Book Aid's role is to provide them with the resources so they can do it.

In the following core countries, Book Aid's programs are large and they work with partners with the capacity to distribute books widely through library or school networks, encompassing support for rural libraries: Cameroon, Ethiopia, Eritrea, The Gambia, Ghana, Kenya, Malawi, Nigeria, Sierra Leone, Sudan, Tanzania, Uganda, Zambia and Zimbabwe. In other countries, their programs are generally small and/or highly focused and support for rural libraries may be limited or non-existent. They do not work in Eastern Europe, China, India, Indonesia or South America (apart from Belize and Guyana).

How to request materials:

Book Aid International supports the development of rural libraries in two ways – librarians are either referred to the main partner organisation in their country or sent books directly from Book Aid headquarters in the U.K. In most cases, rural libraries are referred to their partners. Here is a list of contacts for the core countries: in Cameroon, Eritrea and Ethiopia please contact the British Council; in The Gambia please contact the National Library; in Ghana please contact the Ghana Library Board or the Ghana Book Trust (northern libraries); in Kenya, Malawi and Tanzania please contact the National Library Service; in Nigeria, Sudan and Uganda please contact Book Aid headquarters directly at the address above; in Sierra Leone please contact the National Library Board; in Zambia please contact the Ndola Rotary Club or the National Library Service; in Zimbabwe please contact the Harare Rotary Club at the British Council or the Mutare, Chipinge, Gweru or Bulawayo Rotary clubs. Please write to Book Aid International if you need more detailed contact information, or see their web site.

Brother's Brother Foundation (BBF)

1501 Reedsdale Street, Ste. 3005

Pittsburgh, PA 15233-2341

Country: U.S.A.

Phone: (1 412) 321-3160

Fax: (1 412) 321-3325

Email: BBF@charitiesusa.com

URL: <http://www.brothersbrother.com>

Contact: Luke Hingson, Tori Wolan or Diane McMahon

Materials available:

New books from U.S. publishers

Languages: English

Partner organisations:

Brother's Brother Foundation sends sea containers to libraries all over the world that can pay for shipping. In Jamaica, the Philippines and Ghana, they work with local Rotary Clubs to distribute books to libraries throughout the country free of charge. In other countries that have indigenous Rotary Clubs, Rotary International will match funds for shipping.

How to request materials:

Interested libraries should consider working with their local Rotary Club and BBF to set up an ongoing book distribution program.

CODE

321 Chapel Street

Ottawa, Ontario K1N 7Z2

Country: Canada

Phone: (1 613)232-3569

Fax: (1 613) 232-7435

Email: codehq@codecan.com

URL: <http://www.web.net/~code/index.htm>

Contact: Elise Tousignant (West and Southern Africa), Mike Emblem (East Africa and the Caribbean)

Materials available:

North American donated books and new books purchased from local publishers in Africa and the Caribbean.

Languages: English and French

Partner organisations:

The Canadian Organisation for Development through Education (CODE) works in 12 countries in the developing world through consultative committees and partner organisations. CODE's partner organisations for distributing donated books are: the Guyana Book Foundation, the Belize Book Bank, Code Ethiopia, the Kenya Book Foundation, the Tanzania Book Foundation, the Malawi National Library Service, the Zambia Library Service, the Ghana Book Trust, ALED (Mali) and BLD (Senegal).

How to request materials:

In conjunction with their partners, CODE's activities include distributing donated books, training teachers, librarians and publishers, establishing libraries and supporting local publishing and authorship. In some countries (Zimbabwe and Mozambique in particular), CODE helps publishers and libraries by purchasing works created by local authors and donating them to libraries. Librarians seeking donated books should contact the book distribution partners listed above. CODE headquarters prefers not to receive requests for donated books, but they can supply you with complete contact information for the nearest book distribution partner.

CTA Technical Centre for Agricultural and Rural Co-operation

Information and Capacity Development Department

Postbus 380

6700 AJ Wageningen

Country: Netherlands

Phone: (31) 317 467100

Fax: (31) 317 460067

Email: niang@cta.nl

URL:

Contact: Thiendu Niang, Department Head

Materials available:

Agricultural information and information about running an agricultural library (also see the bibliography).

Languages: English, French and Portuguese

Partner organisations:

The Technical Centre for Agricultural and Rural Co-operation (CTA) was established in the framework of the Convention of Lomé, a co-operation agreement between the European Union member states and the 70 African, Caribbean and Pacific states. CTA's tasks are:

- to develop and provide services which improve access to information for agriculture and rural development.
- to strengthen the capacity of ACP countries to produce, acquire, exchange and utilise information in these areas.

CTA runs several programs in support of agricultural libraries in the ACP states (also see Training below). They provide reference books, CD-ROM databases and rural radio reference packages.

How to request materials:

To receive free agricultural information, send your inquiries to CTA at the address above.

Darien Book Aid Plan

1926 Post Road

Darien, CT 06820

Country: U.S.A.

Phone: (1 203) 866-3006 for requests from Peace Corps Volunteers (1 203) 655-2777 for all others.

Fax: (1 203) 866-4070

Email: MMMinnis@aol.com

URL: <http://www.darien.lib.ct.us/dba>

Contact: Peggy Minnis for Peace Corps Volunteers or Eleanor King for all others

Materials available:

Used books on a variety of subjects no more than 10 years old.

Languages: English and occasionally small quantities of books in French and Spanish

Partner organisations:

Darien Book Aid sends small boxes of books directly to libraries all over the world. They do not have any partner organisations.

How to request materials:

To request books, write them a letter on school or library letterhead describing your library, the reading level of your users (by United States grade level if possible), the subjects you need and any other information that could help them to choose books appropriate for your library. The letter should be on school or library letterhead with the library stamp or other official mark. Darien will send you a postcard to let you know when the books were shipped. They will be sent surface mail and may take six months or longer to arrive. They would appreciate a thank you letter and photo of the library when the books arrive. Darien also accepts requests via email.

Donohue Group, Inc.

360 Hartford Avenue
Wethersfield, CT 06109
Country: U.S.A.
Phone: (1 860) 529-2938
Fax: (1 860) 529-5849
Email: info@dgiinc.com
URL: <http://www.dgiinc.com>

Contact: Christine Donohue or Audra Zimmerman

Materials available:

Donated books from American libraries and their own publications: Library Automation Guide; Guide to Creating Your Library; Guidelines for Donating Books.

Languages: English, Spanish and French

Partner organisations:

The Donohue Group sends books directly to libraries in Eastern Europe and the former Soviet Union.

How to request materials:

To request materials, contact the Donohue Group via phone, fax, email or post.

Medagri

BDPA - Centre de Documentation et d'Information
27, rue Louis Vicat
75738 Paris Cedex 15
Country: France
Phone: (33 0)1 46 48 59 40
Fax: (33 0)1 46 44 75 44
Email: agridoc@bdpa.fr
URL: <http://193.105.38.1:81/cgi-bin/systex.cgi?REF=eslim.0.2.GUIDE&page=medapres>

Contact:

Materials available:

Development and agricultural information

Languages: French

Partner organisations:

Medagri is a development information network for Francophone countries in the Mediterranean basin. The network furnishes members with the Medagri Notebook (a collection of selected works and summaries), Agridoc (an international agricultural bulletin), question and answer services, photocopies of documents on demand and free access to the documents and databases on their web site.

How to request materials:

Membership is free for documentation centres concerned with rural development. To join: send a brief letter to Medagri describing the purpose of your organisation, its activities and your position in the organisation.

Operation Bookshelf

37 Drake Rd.
Scarsdale, N.Y. 10583
Country: U.S.A.
Phone: (1 914) 723-0024
Fax:
Email:
URL:

Contact: No specific person

Materials available:

Used books and magazines

Languages: English

Partner organisations:

Operation Bookshelf is a small all-volunteer organisation that sends boxes of books to libraries, schools and NGOs world-wide. They fill requests for books on a first-come first-serve basis, subject to the availability of materials.

How to request materials:

To request books, send them a comprehensive detailed list of your needs.

Oxfam

274 Banbury Road
Oxford
OX2 7DZ
Country: U.K.
Phone: (44) 1865 311311
Fax: (44) 1865 313770

Email: rbuck@oxfam.org.uk
URL: <http://www.oneworld.org/oxfam>

Contact: Rosalind Buck

Materials available:

Oxfam has a Book Token Scheme that allows their partners, which may include libraries, to select a few publications on development topics from the catalogues of Intermediate Technologies (see listing under “Other Resources” below) and Book Aid International (see above).

Languages: English. A few monographs are available in Spanish and French.

Partner organisations:

Oxfam has offices in the following countries: Angola, Burkina Faso, Chad, Eritrea, Ethiopia, Ghana, Rwanda, Kenya, Malawi, Mali, Mauritania, Mozambique, Namibia, Senegal, South Africa, Somalia, Sudan, Tanzania, Uganda, Zaire, Zambia, Zimbabwe, Afghanistan, Bangladesh, Cambodia, India, Indonesia, Nepal, Pakistan, Philippines, Sri Lanka, Vietnam, Egypt, Yemen, Bosnia, Croatia, Serbia, Armenia, Azerbaijan, Georgia, Albania, Bolivia, Brazil, Chile, Colombia, Guatemala, Santo Domingo, El Salvador, Haiti, Honduras, Jamaica, Nicaragua and Peru.

How to request materials:

Contact the Oxfam office in your country to request further details.

Project Handclasp

c/o Commander, Naval Base
San Diego, CA 92132
Country: U.S.A.
Phone: (1 619) 532-1492
Fax:
Email:
URL:

Contact: P.C. Brown, director, Project Handclasp

Materials available:

Donated books from schools and individuals and a wide array of other “humanitarian aid”

Languages: English

Partner organisations:

Embassies in U.S. Navy ports of call.

How to request materials:

Project Handclasp uses empty cargo space on U.S. Navy ships to transport humanitarian, good-will and educational materials to Navy ports of call. The materials are donated by a wide variety of sources and the contents are unpredictable. Navy ships will off-load these materials wherever they are needed and customs practices allow. Recipients are chosen by the Defence Attachés at U.S. embassies. Visit your local U.S. embassy to find out if they participate in Project Handclasp and ask to be put on a recipient list.

Sabre Foundation, Inc.

872 Massachusetts Avenue, Suite 2-1

Cambridge, MA 02139

Country: U.S.A.

Phone: (1 617) 868-3510

Fax: (1 617) 868-7916

Email: sabre@sabre.org

URL: <http://www.sabre.org>

Contact: Colin McCullough

Materials available:

Sabre's staff works closely with their Partner Organisations to define areas of need in each country. This information is used to solicit the donation of new books and journals from commercial publishers, university presses, professional societies, and research institutes. Sabre also ships "special collections" donated by universities and individual scholars in the U.S.A.

Languages: English, Spanish and Eastern European Languages

Partner organisations:

Sabre has book distribution partners in the following countries: Belarus, Brazil, Bosnia, Bulgaria, Croatia, Cuba, Czech Republic, Estonia, Ghana, Grenada, Hungary, Kazakstan, Kyrgyz Republic, Lithuania, Poland, Romania, Russian Federation, Slovakia, Ukraine and Uzbekistan.

How to request materials:

Sabre Foundation's book donation programs are managed in-country by local partner organisations – non-governmental entities with links to academic, library, charitable or professional organisations. These partners are responsible for selecting and distributing books in their countries (see list above). Libraries should work with their local partner organisation to arrange book donations. Write to the Sabre Foundation or visit their web site for contact information.

UNI-BOOK (Universal Book Effort)

5620 Williams Lake Road

Deming, WA 98244

Country: U.S.A.

Phone: (1 360) 592-2382

Fax: (1 360) 592-9042

Email:

URL:

Contact: Sandi Madison or Rick Gates

Materials available:

Used textbooks from public schools and universities, used books from libraries, discarded books from publishers

Languages: English

Partner organisations:

Uni-Book is particularly active in Africa, India and the countries of the former Soviet Union. They accept requests for English language books from all over the world.

How to request materials:

To request books, write them a letter describing your library, the reading level of your users (by United States grade level if possible), the subjects you need and any other information that could help them to choose books appropriate for your library. Please include a school syllabus if one is available. They send books surface mail so they may take six months or longer to arrive. They would appreciate a thank you letter and photo of the library when the books arrive.

World Bank Volunteer Services Book Project (WBVS)

1818 "H" St., NW

Room JB3-105

Washington, DC 20433

Country: U.S.A.

Phone: (1 202) 473-8960

Fax: (1 202) 522-0301

Email: wproject@worldbank.org

URL:

Contact: Mrs. Elizabeth Shepherd

Materials available:

Used books from school systems, universities, libraries and individuals

Languages: English, occasionally a few books in French or Spanish

Partner organisations:

WBVS Book Project is dedicated to sending books to isolated, rural, and/or needy schools, universities, libraries and hospitals. When enough book request forms are received from these institutions to justify sending a container of books to a country, WBVS finds a recipient organisation to clear the books through customs, notify the other organisations that the books have arrived and distribute them to the other recipients. The distributor can either be spouses/staff of World Bank Missions, the Peace Corps in countries where volunteers are working with libraries and schools, ministries, or local or international NGO's.

How to request materials:

WBVS Book Project sends six containers of 400 boxes of books per year to developing countries around the world (shipping is paid to the nearest point of entry). Write to them for a book request form (do not contact the local office of the World Bank). Development workers or librarians visiting Washington D.C. can select books from their warehouse to take to libraries overseas. Due to the long waiting list of countries wanting shipments, it usually takes at least two years for WBVS to collect enough requests, find a reliable distributor, pack the shipment and send it overseas.

FUNDING

This section lists organisations that supply small libraries with financial support. Some of the programs only fund books; others provide more general support.

Books for All

Brunhildenstrasse 34

D - 80639 Munchen

Country: Germany

Phone: (49 89) 17 23 83

Fax: (49 89) 260 78 96

Email:

URL: <http://www.ifla.org/ifla/VII/s10/1996/b4all.htm>

Contact: Lioba Betten

Description of Services:

Books for All provides libraries specialising in children or youth and/or school libraries with funding for books and other media. The grants are usually between US\$500- US\$2,000, with grants up to US\$10,000 in special cases (e.g. disasters). The program is open to libraries in Africa, Latin America, the Caribbean Islands, south-east Asia and Eastern Europe. It is a co-action program of UNESCO.

How to apply for funding:

To apply for funding, send a description of the library program to Lioba Betten, and she will send you an application form.

International Association of School Librarianship (IASL)

Suite 300, Box 34069

Seattle, WA 98124-1069

Country: U.S.A.

Phone: (1 604) 925-0266

Fax: (1 604) 925 0566

Email: iasl@rockland.com

URL: <http://www.rhi.hi.is/~anne/unescoproject.html>

Contact: Executive Director

Description of Services:

Funds for school libraries in developing countries to purchase books. Each grant is for US\$1,000.

How to apply for funding:

The IASL UNESCO Project 554: Books for Children Project provides funds for purchasing books for school libraries in developing countries. Applicants must guarantee shelves, space, personnel and service, and verify this through a letter or other documentation from the school principal or designated supervisor (e.g. the librarian). Information should also be provided about the school. Selection is made by the IASL UNESCO project 554 - Books for Children Committee. This award is funded through the generosity of IASL members and friends. Applications may be in print or electronic form. The name of the contact person, mailing address, telephone number(s), fax number, and email address (as available) should be included with the application. The deadline for receipt of applications is March 1 each year.

International Development Exchange (IDEX)

827 Valencia Street Suite101
San Francisco, CA 94110-1736
Country: U.S.A.
Phone: (1 415) 824-8384
Fax: (1 415) 824-8387
Email: idx@igc.apc.org
URL: <http://www.idx.org>

Contact: No specific contact person

Description of Services:

IDEX builds partnerships to overcome economic and social injustice. They work toward people's greater control of their resources, political structures, and economic processes that affect their lives. They supports small scale, community-based development efforts, including libraries, in Africa, Asia and Latin America. To help overseas communities gain greater access to information, support, and resources as well as to inform and educate others, IDEX establishes educational partnerships between schools, community groups, and individuals in the U.S. with sponsored communities in our partner countries. They foster an awareness of the issues faced by communities overseas through teacher training, curriculum development, work in public and privates school classrooms, and an extensive volunteer program.

IDEX is active in the following countries: Ghana, Zimbabwe, Bangladesh, India, Philippines, Guatemala, Mexico and Nicaragua.

How to apply for funding:

Please contact IDEX by letter, phone, fax, or e-mail for their application criteria.

Open Society Institute Network Library Program (NLP)

Oktober 6. u. 12
H-1051 Budapest
Country: Hungary

Phone: (36 1) 327 3100
Fax: (36 1) 327 3101
Email: kupryter@osi.hu
URL: <http://www.osi.hu/nlp>

Contact: Rima Kupryte, Program Manager

Description of Services:

The numerous non-profit foundations and organisations created and funded by the philanthropist George Soros are linked together in an informal network called the Soros Foundations Network. At the heart of this network are autonomous organisations known as “national foundations,” which are located in Albania, Armenia, Azerbaijan, Bulgaria, Bosnia & Herzegovina, Croatia, the Czech Republic, Estonia, Georgia, Haiti, Hungary, Kazakstan, Kyrgyz Republic, Latvia, Lithuania, Macedonia, Moldova, Mongolia, Romania, Russia, Slovakia, Slovenia, Tajikistan, Ukraine, Uzbekistan and Yugoslavia.

The OSI Network Library Program (NLP) (formerly Regional Library Program) supports and advances in all aspects of information science in OSI countries. This program can support proposals in all fields of library and information science including training, automation, preservation and access, collection development and other areas (see separate entry under training). The NLP only funds proposals that have been endorsed by the national foundations and have received matching funds.

How to apply for funding:

Application requirements are listed in calls for proposals issued by the NLP and advertised by the national foundations. Library co-ordinators in the national foundation offices implement the Network Library Program on the national level.

LIBRARY ASSOCIATIONS AND NETWORKS

Collaboration is one of the main keys to the long term success of any library. Sharing information with other librarians can help you stay informed about training opportunities, funding, new sources for books and new techniques to make your job easier. Joining your local library association is one of the best ways to make contact with other librarians and stay current in the field. Joining an international network of librarians, such as UNAL listed below, can help you share ideas and resources across borders. The organisations listed below can help you contact a library association in your country. They may also be able to give you advice about setting up a local library association if there is not one in your area.

Association for Population/Family Planning Libraries and Information Centres International (APLIC-I)

c/o Family Health International

PO Box 13950

Research Triangle Park, NC 27709

Country: U.S.A.

Phone: (1 215) 898-5375 or (1 401) 863-1863

Fax: (1 215) 898-2124 or (1 401) 863-3351

Email: lnewman@pop.upenn.edu or anne_ilacqu@brown.edu

URL: <http://www.pop.upenn.edu/library/APLIC.html>

Contact: Lisa A. Newman or Anne K. Ilacqua

Services offered:

APLIC-I's mission is to develop effective documentation and information systems and services in the field of population and family planning; to provide the opportunity for professional networking among family planning and population documentalists, librarians, and information and communication specialists; to encourage and support the world-wide exchange of information through international programs and activities; and to provide continuing education to encourage professional development.

How to join:

Contact APLIC-I to obtain a membership application. The cost is US\$15.00 per year for libraries and individuals in developing countries.

AUPELF-UREF

Direction de l'information

4, place de la Sorbonne

75005 Paris

Country: France

Phone: (331) 44 41 18 18

Fax: (33-1) 44 41 18 19

Email: information@aupelf.refer.org
URL: <http://www.aupelf-uref.org>

Contact: Georges Malamoud

Services offered:

AUPELF-UREF has set up an international network of technical information centres called Centres SYFED-REFER. In most countries, these centres feature Internet access, electronic databases, multi-media and other information technology. The goal of the network is to facilitate rapid dissemination of information to promote community development, co-operation and scholarship. The centres can be focal points for local information networks and are also gateways to information about other AUPELF programs, including scholarships and distance education programs such as l'Université virtuelle francophone. There are Centres SYFED-REFER in the following countries: Benin, Bulgaria, Burkina Faso, Cambodia, Cameroon, Canada, Egypt, France, Gabon, Guinea, Haiti, Hungary, Ivory Coast, Madagascar, Mauritius, Mauritania, Morocco, Romania, Senegal, Togo, Tunisia, Vietnam.

How to join:

Centres SYFED-REFER are generally located in the capital of a country at a major university. If you have difficulty locating the nearest centre, contact the AUPELF information program at the address above or check their web site.

Central American Library Association (CALA)

2200 Francisco St.#5
San Francisco, CA 94123-1919
Country: U.S.A.
Phone: (1 415) 474-2098 or (1 888) 233-0762
Fax: (1 415) 563-4051
Email: Chairman@calas.org
URL: <http://www.calas.org>

Contact: Bill Linnemeier

Services offered:

CALA is developing a network of Internet-connected libraries in Central America. Each one will be connected by internet video conferencing to a partner school/library in the U.S.A. This network will give children in both regions the opportunity to freely exchange information. Each library will contain about 30,000 books, videotapes, and audio tapes, and be the dispersal point for a book exchange program serving small rural communities. Their pilot project is underway in La Fortuna, Costa Rica and will be their base of operations in the region.

How to join:

Communities interested in participating in the CALA network should contact their headquarters for more information.

Environmental Systems Information Centre (ENSIC)

Asian Institute of Technology (AIT)
G.P.O. Box 2754
Bangkok 10501
Country: Thailand
Phone: (66-2) 524-5863, (66-2) 524-5875
Fax: (66-2) 524-5870
Email: enreric@ait.ac.th
URL: <http://www.ait.ac.th/clair/centers/ensic.html>

Contact:

Services offered:

ENSIC (formerly Environmental Sanitation Information Centre) was created with the objective of providing developing countries with needed information on water supply, environment and sanitation. ENSIC staff work in close co-operation with the Environmental Engineering Program of the School of Environment, Resources and Development at the Asian Institute of Technology (AIT). The information collected from world-wide sources is repackaged and disseminated through various types of publications, through the development of computerised data bases, and by offering reference, referral and document delivery services. ENSIC also conducts training courses on environmental information services. ENSIC has created an outreach network, ENSICNET, within six countries (China, Indonesia, Nepal, Pakistan, Philippines and Vietnam) to collect from and disseminate to local institutions involved in water supply, environment and sanitation.

How to join:

Contact ENSIC for more information about their publications, training programs, network members in your country and/or how to become a member.

IBISCUS

1 bis rue du Havre
75008 Paris
Country: France
Phone: (330)1 42 94 24 3
Fax: (330)1 42 94 25 9
Email: ibis@ibiscus.fr
URL: <http://www.ibiscus.fr>

Services offered:

IBISCUS is a francophone network of training and information about developing countries intended for NGOs, universities and organisations focused on international co-operation. Its activities centre around three points. First, a network of fifty organisations in the north and south that share data. Second, a database containing bibliographic references, employment opportunities (for French citizens who want to work abroad), a directory of development organisations, French development projects, economic and social summaries and current events. Third, documentation assistance including training, technical information and publications.

How to join:

You can find out more about IBISCUS membership, databases and training programs by visiting the nearest member of the network or by contacting their headquarters.

IFLA Advancement of Librarianship Program (IFLA-ALP)

c/o Uppsala University Library

Box 510, S 751 20

Uppsala

Country: Sweden

Phone: (46) 18 471 3989 or (46) 18 471 3990

Fax: (46) 18 471 3994

Email: IFLA.ALP@ub.uu.se

URL: <http://www.nlc-bnc.ca/ifla/VI/1/alp.htm>

Contact: Birgitta Bergdahl

Services offered:

The mission of IFLA's Core Program for the Advancement of Librarianship (ALP) is to further the library profession, library institutions and library and information services in the developing countries of Africa, Asia & Oceania, Latin America and the Caribbean. It thus spans a wide spectrum of library activities and plays an important role within IFLA (see entry for IFLA below) as a catalyst for its activities benefiting developing countries. ALP particularly concentrates on issues which are of vital importance for these countries and which do not always fall within the responsibility of the other subject-oriented IFLA core programs.

For the period 1998-2001 the following major goals have been identified:

- To assist in continuing education and training;
- To support the development of library associations;
- To promote the establishment and development of library and information services to the general public, including the promotion of literacy;
- To promote the introduction of new technology into library services.

How to join:

To find out more about ALP, contact the International Focal Point listed above, or one of the regional focal points. They are located in Dakar, Senegal (hosted by the Cheikh Anta Diop University), at Thammasat University, Bangkok, Thailand (hosted by the Thai Library Association) and in Sao Paulo, Brazil (hosted by the Brazilian Library Federation, FEBAB). The managers of these Regional Offices work very closely with the ALP International Focal Point to support and develop the program. The Regional Newsletters are important vehicles for information about the ALP Program as well as the general library and information situation in the regions.

International Association of Agricultural Information Specialists (IAALD)

IAALD Secretary/Treasurer

CAB International

Wallingford, Oxon OX10 8DE

Country: United Kingdom

Phone: (44) 1491-832111

Fax: (44) 1491-833505

Email: bellamy@cabi.org

URL: <http://www.lib.montana.edu/~alijk/IAALD.html>

Contact: Margot Bellamy, IAALD Secretary/Treasurer

Services offered:

IAALD facilitates professional development of, and communication among, members of the agricultural information community world-wide. IAALD's goal is to enhance access to and use of agriculture-related information resources. To further this mission, IAALD: promotes the agricultural information profession; supports professional development activities; fosters collaboration; and provides a platform for information exchange. The Association has a membership of over 600 in 80 countries. On becoming a member, you will receive the IAALD Quarterly Bulletin and IAALD News free of charge and will be able to participate in the activities of the Association.

How to join:

IAALD has special discount subscriptions for members in developing countries. Contact the secretary/treasurer for more information and an application form.

International Association of School Librarianship (IASL)

Suite 300, Box 34069

Seattle, WA 98124-1069

Country: U.S.A.

Phone: (1 604) 925-0266

Fax: (1 604) 925 0566

Email: iasl@rockland.com

URL: <http://www.rhi.hi.is/~anne/iasl.html>

Contact: Executive Director

Services offered:

The mission of the International Association of School Librarianship (IASL) is to provide an international forum for those people interested in promoting effective school library media programs as viable instruments in the educational process. IASL also provides guidance and advice for the development of school library programs and the school library profession. IASL works in co-operation with other professional associations and agencies.

Membership is world-wide, and includes school librarians, teachers, librarians, library advisers, consultants, educational administrators, and others who are responsible for library and information services in schools. Membership includes a free subscription to the quarterly newsletter and two issues of a journal each year. Members are eligible to apply for the Jean E. Lowrie Leadership Development Grant which assists an individual to attend the annual association conference; Takeshi Murofushi Research Award to individuals undertaking some level of research in school librarianship, and the SIRS Commendation Award for a project, plan, publication or program which could serve as a model for replication by other individuals or associations.

How to join:

You can request a membership form by writing to the address above. Membership costs US\$15/year for individuals and libraries in developing countries. Some assistance is available for library personnel from developing countries to join the association through the Support A Member grants. IASL is committed to increasing participation by libraries in developing countries.

International Federation of Library Associations (IFLA)

P.O.B. 95312

2509 CH The Hague

The Hague

Country: Netherlands

Phone: (31) 70-314-0884

Fax: (31) 70-383-4827

Email: ifla.hq@ifla.nl

URL: <http://www.nlc-bnc.ca/ifla/home.htm>

Contact: Anne Telkers, Membership Officer or Sjoerd Koopman, Co-ordinator of Professional Activities

Services offered:

IFLA offers a professional home for library associations, libraries and librarians whatever their type of expertise. They can all find their particular group within the pyramidal structure of IFLA's professional activities. Thus IFLA is one of the means through which

librarians world-wide can formulate their goals, exert their influence as a group, protect their interests and find solutions for global problems.

How to join:

There are several kinds of memberships available and you can write to IFLA for more information. Many small libraries, however, may find membership too expensive, though IFLA is taking steps to make it more affordable. Most national libraries, library associations and library services are, however, members and they can help you find out more about IFLA activities and programs in your country. IFLA also has regional offices in Bangkok, Dakar and Rio de Janeiro that can provide information about IFLA activities (see the entry for IFLA-ALP above). You do not have to be an IFLA member to participate in many of their activities, such as conferences and seminars. Conversely, IFLA can tell you how to contact the library association or other IFLA members in your country.

Link: A Network for North-South Library Development

64 Ennersdale Rd.

London SE135JD

Country: United Kingdom

Phone: (44 171) 733 3577

Fax:

Email: 101450.2i67@compuserve.com

URL:

Contact: Gill Harris

Services offered:

LINK is a network that intends to be an informed, experienced and realistic forum for raising awareness of developing world library issues within the information-related professions of the North. It aims to link librarians and libraries in the “South” with colleagues world-wide, for their mutual benefit, and to provide support, briefing and continuing information to individuals who intend to do information work in developing countries. Specific objectives and activities of the group include:

- Providing information and support to individuals before, during and after their work overseas.
- Supporting students, librarians and information workers from developing countries who are in the UK.
- Supporting librarians and information workers in developing countries.
- Producing a newsletter to inform, link and support participants’ activities.
- Producing a directory of network participants and other resources that can facilitate the main aims of the network.

How to join:

LINK produces a quarterly newsletter called Link-Up that is free to libraries in developing countries. They also produce a Directory of Skills Exchange, which contains information about the network participants and a list of free newsletters. To receive these publications, write to Link at the address above.

Pacific Islands Association of Libraries and Archives (PIALA)

c/o University of Guam R.F.K. Library
UOG Station
Mangilao, Guam 96923
Country: U.S.A.
Phone: (1 671) 735-2345
Fax: (1 671) 734-6882
Email: acohen@uog9.uog.edu
URL: <http://uog2.uog.edu/rfk/piala.html>

Contact: Arlene Cohen, PIALA Executive Board Member and representative to the IFLA round table on the management of library associations.

Services offered:

The Pacific Islands Association of Libraries and Archives (PIALA) is the newest regional association of librarians and archivists to be formed in the Pacific area. The association was formed to address the needs of Pacific Islands librarians and archivists, with a special focus on Micronesia.

Two critical projects that PIALA was involved in were the publication of a "Directory of Libraries, Archives and Museums in Micronesia," and "The Union List of Serials in the Libraries of Guam and Micronesia." Work has already been started on both of these projects. PIALA also issues a quarterly Newsletter to keep the membership informed and holds annual conferences. The proceedings of the conferences have been published each year since 1993.

How to join:

PIALA membership is open to all individuals, institutions, and corporations interested in supporting its goals. Dues are US\$20.00 per year for individual membership and US\$50.00 for institutional or corporate membership.

Pan American Information Network on Environmental Health (REPIDISCA)

CEPIS - Peru
Los Pinos 259
Urb. Camacho
Lima 12
Country: Peru
Phone: (511) 437 1077
Fax: (511) 437 8289

Email: cepis@cepis.org.pe
URL: <http://www.cepis.org.pe>

Contact: Marta Bryce

Services offered:

REPIDISCA is a decentralised network of environmental health information centres operating in Latin America and the Caribbean. National institutions, acting as Co-operating Centres, together with the National Co-ordinating Centres, are responsible for the development of REPIDISCA in their own countries. There are currently 342 Co-operating Centres of REPIDISCA in 24 countries. REPIDISCA's participation in the "Network of Networks" also facilitates access to documentation from 19 information networks in Latin America and the Caribbean, as well as from the Urban Agricultural Network. Its data base is also compatible with LILACS (Literatura Latinoamericana en Ciencias de la Salud).

How to join:

REPIDISCA publications, videos, computer programs and other materials can be purchased using REPIDISCA Coupons. You may purchase the coupons directly from REPIDISCA headquarters or in local currency at PAHO/WHO Representative Offices in every country. REPIDISCA also offers the Selective Dissemination of Information Service (SDI) via email to keep its users abreast of the latest development in their field of interest and updated on the recent documents recorded in its data base. This service is offered free of charge. To subscribe to the SDI service, send REPIDISCA an email message listing the topics in which you are interested. This service works best if you restrict and state clearly your field of specialisation. You may also contact REPIDISCA for information about becoming a Co-operating Centre.

UNESCO Network of Associated Libraries (UNAL)

Division of Information and Informatics

1 rue Miollis

75732 Paris Cedex 15

Country: France

Phone: (331) 45 68 44 97

Fax: (331) 45 68 55 83

Email: j.springer@unesco.org

URL: <http://www.unesco.org/cii/unal/unalpg.htm>

Contact: Joie Springer

Services offered:

Launched in 1990 to promote library co-operation for international understanding, UNAL's principal objective is to encourage public libraries to undertake activities related to UNESCO's main goals such as the promotion of human rights and peace, cultural dialogue, protection of the environment, fight against illiteracy, etc. and to

establish contacts between libraries of the North and of the South. Members organise exhibitions, literary events, debates and lectures, exchanges of material and information, seminars, twinning arrangements, usually on a voluntary basis, as a means of promoting UNESCO's ideals. Membership is free and includes a subscription to the network's newsletter UNAL INFO (French and Spanish). Member libraries also receive discounts on UNESCO publications.

How to join:

Any public library, be it for adults, young people or children, sharing the open-minded spirit of the Network may join UNAL by requesting a membership form from Joie Springer at the above address. Applications may also be submitted electronically via email. The membership form is available in English and French on the UNAL web site.

PUBLISHER'S ASSOCIATIONS AND NETWORKS

As mentioned under *Some Facts About Book Donation Programs* above, it is in the best interest of libraries everywhere to support local publishing. The organisations listed below can help you find publishers in your area and may also be able to give you advice about getting discounts or forming collaborations.

International Publishers Association (IPA)

3 avenue de Miremont
1206 Geneva
Country: Switzerland
Phone: (41) 4422-3463018
Fax: (41) 4422-3475717
Email: info@ipa-uie.org
URL: <http://www.ipa-uie.org/>

Contact: Mr. J.A. Koutchoumow, Secretary General

Services offered:

The International Publishers Association (IPA) is a group of 74 member organisations in 65 countries. It is a professional organisation of national associations which are recognised as representative of publishers in each country. Individual publishing companies cannot join IPA. The Association's primary mission is to safeguard the fundamental freedoms to publish and to read. It defends the rights of authors and publishers to create and distribute the works of the mind without hindrance while respecting the local and international rights attached to these works.

How to contact them:

Contact IPA at the address above to find out the location and contact information for member publishers associations in your country.

The African Books Collective (ABC)

The Jam Factory
27 Park End Street
Oxford OX1 1HU
Country: U.K.
Phone: (44) 1865 726686
Fax: (44) 1865 793298
Email: abc@dial.pipex.com
URL: http://www.sas.upenn.edu/African_Studies/Publications/ABC_Menu.html

Contact: Mary Jay

Services offered:

ABC is a self-help initiative established by a group of 17 African publishers to promote and distribute their books in Europe, North America and Commonwealth countries outside Africa. Membership has grown to 50 African publishers since 1990. It is non-profit making on its own behalf in order for member publishers to enjoy more favourable terms than available under conventional commercial distribution agreements. In this way, African publishers fully benefit from the overseas sales earnings of their books and African publishing is supported.

How to contact them:

In January of 1997, ABC published a new edition of the African Publishers Networking Directory (ISBN 0-9521269-1-5). Revised and expanded, this second edition reference guide and networking tool is for publishers, librarians and others interested in the book industries and book development in Africa. It is available free, while supplies last, to African publishers, librarians, booksellers and writers. To receive a copy, send your request to ABC at the above address.

The African Publishers Network (APNET)

Box 3773

Harare

Country: Zimbabwe

Phone: (263-4) 705105 or (263-4) 72645

Fax: (263-4) 705106 or 706110

Email: APNET@mango.zw or apnet@harare.iafrica.com

URL:

Contact: Gillian Nyambura

Services offered:

APNET is a pan-African network of national publishers' associations and publishing communities, which works together to strengthen and promote indigenous publishing throughout Africa.

How to contact them:

To find out more about their activities or the national publisher's association in your country, write to them at the above address. If you are in Zimbabwe, you can also visit their secretariat on the 11th floor of the Megawatt Building, 44 Samora Machel Ave., Harare.

The International Board on Books for Young People (IBBY)

Nonnenweg 12

Postfach

CH-4003 Basel

Country: Switzerland

Phone: (4161) 272 29 17
Fax: (4161) 272 27 57
Email: ibby@eye.ch
URL: <http://www.ibby.org/>

Contact:

Services offered:

The International Board on Books for Young People (IBBY) is a non-profit organisation which represents an international network of people from all over the world who are committed to bringing books and children together. IBBY was founded in Zurich, Switzerland in 1953. Today, it is composed of more than sixty National Sections all over the world. The National Sections are organised in many different ways and operate on national, regional and international levels. In countries that do not have a National Section, individual membership in IBBY is possible. The membership of the National Sections include authors and illustrators, publishers and editors, translators, journalists and critics, teachers, university professors and students, librarians and booksellers, social workers and parents. IBBY's activities include awards, conferences, seminars, workshops and international children's book day activities. They also publish a journal called Bookbird and other materials. The regional sections conduct additional activities.

How to contact them:

Contact IBBY's headquarters in Switzerland (listed above) to find the location of the nearest IBBY National Section office or member.

TRAINING

The following organisations offer basic training programs for small libraries. Some of the programs are conducted in the field, and others take place in Europe, the UK or the USA. You should also contact the nearest university and/or national library service to find out about local training and distance learning programs in your country.

CAB International

Wallingford, Oxon OX10 8DE

Country: United Kingdom

Phone: (44) 1491-832111

Fax: (44) 1491-833505

Email: development@cabi.org

URL: <http://www.cabi.org>

Contact: Margot Bellamy

Services offered:

CAB International's (CABI) Information for Development Program assists developing countries to acquire, manage and disseminate scientific information. As part of the capacity-building component of the program, CABI conducts training programs in various aspects of information management, including library and information services. The training focuses on agricultural (including forestry) and health information. Training takes place at CABI itself for tailored individual or group programs (in the UK), as well as in-country or in-region. CABI can also supply other organisations with trainers for a specific course or project. CABI's training programs are project focused and usually address the needs of a specific organisation, project or group. CABI is not a funding agency, so funds have to be sought through projects or sponsorship.

How to contact them:

If you need training support for your organisation, or would like information about training courses being run by CABI Regional Centres, please contact CABI headquarters. Please note that CABI is NOT a funding organisation and does not give any grants or scholarships to individuals. Participants in CABI training programs are either funded by their organisations or obtain their own funding from another source.

CTA Technical Centre for Agricultural and Rural Cupertino

Information and Capacity Development Department

Postbus 380

6700 AJ Wageningen

Country: Netherlands

Phone: (31 317) 467100

Fax: (31 317) 460067

Email: jehl@cta.nl

URL:

Contact: Marie-José Jehl

Services offered:

CTA conducts training programs on a variety of topics for agricultural librarians and documentalists: training of trainers, information management, technical writing, CD-ROM and Internet use, information dissemination, scientific and web publishing. In 1998 they are concentrating on communication skills: scientific editing and writing (mostly national courses in West Africa), management of journal publications (one for anglophone and one for francophone countries in Africa), public awareness for decision makers in Africa, and electronic publishing (mainly creation of home pages and the use of HTML language). Most of these courses are run at a regional level with a few exceptions of national courses in scientific writing. CTA also distributes a free list of training experts in over 140 countries world-wide and they publish and distribute training materials (see the entry for CTA under Book Donation Programs above).

How to contact them:

Contact CTA at the address above to find out about seminars, workshops and training experts in your country. CTA expects people who have participated in their training of trainer program to “train other colleagues, and especially to transfer the basic technical skills.”

Institute Africain pour le Developpement Économique et Social (INADES)

Centre de documentation et d'information

08 BP 2088

Abidjan

Country: Ivory Coast

Phone: (225) 44 15 94195

Fax: (225) 44 84 38

Email:

URL: <http://www.ibiscus.fr> (look under partners or training)

Contact: Marie Paule Coing

Services offered:

INADES conducts training in basic library skills, as well as software and automation. They produce and sell several training manuals in French. INADES is an IBISCUS partner organisation (see Library Associations and Networks).

How to contact them:

The cost of training is 250,000 Fcfa for the first week and 150,000 Fcfa for subsequent weeks. Some partial scholarships are available. The request for a scholarship must be written by the director of the library other top manager. Pro forma invoices are available upon request.

Mortenson Centre for International Library Programs

246J Main Library
1408 West Gregory Drive
Urbana, Illinois 61801
Country: U.S.A.
Phone: (1 217) 333-3085
Fax: (1 217) 244-4358
Email: mcholdin@uiuc.edu or schnuer@uiuc.edu
URL: <http://alexia.lis.uiuc.edu/~mortensn/>

Contact: Marianna Tax Choldin, Director or Susan Schnuer, Co-ordinator

Services offered:

The Mortenson Centre offers a unique, individualised non-degree program for librarians and information science professionals from outside North America. The program provides visitors – known as Mortenson Associates – with a broad knowledge of, and exposure to, the theory and practice of librarianship in America. The program generally last from 4-6 months and involves a seminar on American libraries, workshops to build training and teaching skills, auditing university classes on information and library science, an introduction to automated technology for libraries, library tours, conferences, un-paid internships and consultations with librarians.

How to contact them:

The Mortenson Centre is able to host no more than 18-20 librarians at one time. The program begins twice a year: in late August (for the fall semester) and in early January (for the spring semester). In a few cases, the centre may start a program in early June to allow a participant to attend the University of Illinois Summer Intensive English Institute (if funding is available). The Centre is developing some short, focused modules to be offered during the summer.

Most applicants have private or governmental funding to support a stay at the Mortenson Centre. The cost is approximately US\$8,000 for a four month stay and US\$10,500 for a six month stay. Occasionally, the Mortenson Centre has funds from other sources to sponsor librarians from particular regions of the world or particular types of librarians. All applicants must complete the Mortenson Centre application process. Acceptance depends on whether the applicant meets their selection criteria, and whether they have room in the program at the time required. The application must arrive at the Mortenson Centre at least six months before the applicant would like to start. Write to the centre at the above address or see their web site for an application form and information about current competitions for funding.

Open Society Institute Network Library Program (NLP)

Oktober 6. u. 12
H-1051 Budapest
Country: Hungary

Phone: (36 1) 327 3100
Fax: (36 1) 327 3101
Email: kupryter@osi.hu
URL: <http://www.osi.hu/nlp>

Contact: Rima Kupryte, Program Manager

Services offered:

The numerous non-profit foundations and organisations created and funded by the philanthropist George Soros are linked together in an informal network called the Soros Foundations Network. At the heart of this network are autonomous organisations known as “national foundations,” which are located in Albania, Armenia, Azerbaijan, Bulgaria, Bosnia & Herzegovina, Croatia, the Czech Republic, Estonia, Georgia, Haiti, Hungary, Kazakstan, Kyrgyz Republic, Latvia, Lithuania, Macedonia, Moldova, Mongolia, Romania, Russia, Slovakia, Slovenia, Tajikistan, Ukraine, Uzbekistan and Yugoslavia.

The NLP sponsors training workshops throughout the region in co-operation with the national Soros foundations. All workshops are co-ordinated locally by the library co-ordinator within the national foundation. Each national Soros foundation participating in the NLP has received or will receive both a management training workshop and an automation training workshop. A new series of specialist workshops is being introduced. Topics may include: digitisation, grant writing, fundraising, retrospective conversion, new technologies, international standards, preservation and access and others upon request. The NLP also has several fellowship programs.

How to contact them:

Contact the library co-ordinator at the national foundation in your country for more information (contact the NLP if you do not know the address your country’s national foundation).

Peace Corps Eastern Caribbean

P.O. Box 123
Castries
Country: St. Lucia
Phone: (758) 453-6373/0
Fax: (758) 453-1931
Email: uspeacec@candw.lc
URL: <http://www.peacecorps.gov>

Contact: Peace Corps Country Director

Services offered:

Peace Corps Eastern Caribbean has volunteers on Nevis, St. Kitts, Grenada, St. Vincent, St. Lucia, Dominica and Antigua who can assist with library development.

How to contact them:

Assistance with small library development could be arranged on any of these island by contacting the Peace Corps Eastern Caribbean Regional Office at the address above.

Peace Corps/The Gambia

P.O. Box 582

Banjul

Country: The Gambia

Phone: (220) 392466

Fax: (220) 391803

Email:

URL: <http://www.peacecorps.gov>

Contact: Associate Peace Corps Director for Education/Health

Services offered:

Peace Corps/The Gambia has volunteers all over the country who can assist with library and resource centre development.

How to contact them:

Assistance with small library development in-country could be arranged by contacting Peace Corps/The Gambia at the address above.

OTHER SERVICES

This section includes other useful organisations and programs, such as twinning programs, library information services and coupon programs.

African Studies Association (ASA)

Rutgers State University

Douglas Campus

132 George Street

New Brunswick, NJ 08901-1400

Country: U.S.A.

Phone: (1 732) 932-8173

Fax: (1 732) 932-3394

Email: ckoch@rci.rutgers.edu

URL: http://www.sas.upenn.edu/African_Studies/Home_Page/ASA_Menu.html

Contact: Christopher P Koch

Services offered:

The ASA is making available up to \$4,000 annually to assist groups of individuals with shipping costs for book donations to African libraries and schools. Usually several awards are made each year with the average award being \$800. These grants are intended to encourage innovative projects that incorporate essential elements, including recipient participation, high quality materials and attention to the details of logistics.

How to contact them:

Applications for Funding:

1. Project description: Send a 1-3 page description of the relationship between the recipient and the donor, the materials requested (specific titles or subject area), the number of books, how they will be shipped and other logistical plans. Also describe the project - is it already underway, or just in the idea stage? Who will administer it? Who is the liaison in Africa?
2. Budget: What are total costs of the project? How much is the request to the ASA? How will the ASA funds be used? Who will be responsible for the final report to ASA?
3. Letter of Agreement from the recipient institution: The ASA will evaluate projects on the basis of participant involvement, response of donors to articulated needs and practicality of arrangements. Those meeting the criteria will be considered on a first come, first served basis.
4. A report on the project and brief summary for ASA News are required at the project's completion.

Please send, via the post, five copies plus the original proposal by the 1st of March of each year to ASA at the address above.

Banco del Libro

Edificio "Banco del Libro"

Avenida Luís Roche

Altamira Sur

Apartado Postal 5893

Caracas 1010-A-

Country: Venezuela

Phone: (58)-02-266.8138 / 2638442 / 2637728 / 2653990

Fax: (58)-02-2641391 / 2663621

Email: blibro@reacciun.ve

URL: <http://www.bancodellibro.org.ve/menu1.htm>

Contact:

Services offered:

Banco del Libros seeks to expand, study, evaluate and promote children's literature in Venezuela and Latin America; to produce, compile and disperse information for parents, teachers, librarians and specialists; to demonstrate to authors, illustrators and editors what is a book of quality for children and young people and show how they can help children to read more and better at school and at home. To this end they offer support through various programs and reading clubs for children of all ages and informational clearinghouses for documentation and promotion of children's literature.

How to contact them:

Contact Banco del Libros for more information about their programs.

Banque International sur les États Francophone (BIEF)

25, rue Eddy,

Hull K1A 0M5

Country: Canada

Phone: (819) 997-3857

Fax: (819) 953-8439

Email: acctbief@fox.nstn.ca

URL: <http://www.acctbief.org/index.html>

Contact:

Services offered:

BIEF is a program of the Agence de la Francophonie (ACCT). It maintains profiles of the information/library resources in 47 francophone countries and 46 Commonwealth countries. Each profile contains information about: library systems, copyright registration, the national bibliography, training, networks and collaborations, professional associations, national information policies and telephone infrastructure. BIEF also produces a large

variety of directories, manuals, conference proceedings and other materials of interest to librarians. They conduct training programs and promote the exchange of expertise.

How to contact them:

BIEF has a network of national focal points in the 49 member states of the Sommet Francophone known as the Réseau des centres serveurs de BIEF. These centres are generally hosted by the national library or archives. They contain BIEF publications and information about BIEF programs. The contact information for each country is available on their web site or by writing to them.

British Council Coupon Scheme

Publishing Promotion Unit

Bridgewater House

58 Whitworth St.

Manchester M1 6BB

Country: United Kingdom

Phone: (44 0)161 957 7182

Fax: (44 0)161 957 7168

Email: publishing.promotion@britcoun.org

URL: <http://www.britcoun.org/publishing/beb/coupons.htm>

Contact: Julie Brett, Publishing Promotion Officer

Services offered:

British Council book coupons are for sale in British Council offices in some countries where foreign exchange is in short supply or where British books are not easily obtained. They can be bought with local currency and used to buy books, periodicals and other published materials directly from Britain. Coupons are for use by individuals, institutional buyers and booksellers. Coupons can be used to purchase books, multimedia and periodicals (and also for the cost of freight and insurance).

How to contact them:

The British Council sells coupons for local currency. These are accepted by a wide range of British exporting booksellers and publishers as payment for orders for products. The seller then redeems the coupons for British pounds sterling from the Council office in Manchester. Rules vary slightly from country to country, so you should consult the Council office in your country before you use the coupons for the first time.

Your local Council office should be able to help with information about British books which are available and provide a list of booksellers and publishers. They cannot help with choosing a supplier or placing orders. Once coupons have been sold, the Council does not get involved in dealings (for example over freight, insurance or customs clearance) between the customer and the bookseller.

You will be asked to pay the local currency equivalent of the sterling price of the books or periodicals you want to buy plus a management fee to cover the cost of administration. Coupons are usually only supplied in connection with a particular order, so you should present them to your supplier without delay. They must be redeemed within a year of their issue in any case. If you would like a free copy of the British Council Book Coupon Scheme leaflet or more information, contact Julie Brett at the address above.

Intermediate Technology

103-105 Southampton Row
London WC1B 4HH
Country: United Kingdom
Phone: (44) 171 436 9761
Fax: (44) 171 436 2013
Email: itpubs@itpubs.org.uk
URL: <http://www.oneworld.org/itdg/publications.html>

Contact:

Services offered:

Intermediate Technologies produces an annual catalogue of over 300 recommended books on development topics available by mail order called Books by Post. Most of the publications are in English, but they do have some titles in French and Spanish. They also publish three quarterly periodicals: "Appropriate Technology," "Waterlines" and "Small Enterprise Development." They accept many forms of payment, including UNESCO Coupons (see below).

How to contact them:

Intermediate Technology has offices in Bangladesh, Kenya, Peru, Sri Lanka, Sudan and Zimbabwe. Their publications are also available in many bookshops world-wide or via mail order. Contact them via mail, phone, fax or email to request a copy of Books by Post, ordering information and/or a list of overseas distributors.

IFLA Library Twinning Program

IFLA Office for UAP and International Lending
c/o the British Library
Boston Spa
Wetherby, West Yorkshire
LS23 7BQ
Country: United Kingdom
Phone: (44) 1937 546254
Fax: (44) 1937 546478
Email: ifla@bl.uk
URL: <http://www.nlc-bnc.ca/ifla/VI/2/p4/proj4.htm>

Contact: No specific contact person

Services offered:

IFLA recently established a library twinning database. "The system will act as a kind of dating agency for libraries: libraries will provide brief details of their own organisation, together with an outline of what benefits they are seeking from the partnership and what benefits they can offer to the partner. The system will aim to match libraries, so that their needs are satisfied as closely as possible. Areas of professional interest on which partnerships may be based include:

1. Exchange of information about libraries generally
2. Improved access to published bibliographic information
3. Exchange of information on management, technology and professional development
4. Staff exchanges
5. Exchange of library material
6. Establishment of interlibrary loan and document supply services
7. Staff training and development

How to contact them:

Libraries wishing to identify potential partners for establishing a twinning arrangement are invited to contact the IFLA Office for UAP. They will send you a questionnaire asking for full contact details, brief information about your library, and areas of co-operation in which you wish to build links. They would also like to know what you can offer to bring to the twinning partnership, as well as the benefits you hope to gain.

UNESCO Micro CDS/ISIS Program

7, place de Fontenoy

75352 Paris 07 SP

Country: France

Phone: (331) 45 68 37 91

Fax: (331) 45 68 55 82

Email: g.delbigio@unesco.org

URL: <http://www.unesco.org/webworld/isis/isis.htm>

Contact: Giampaolo Del Bigio

Services offered:

Micro CDS/ISIS is an advanced non-numerical information storage and retrieval software developed by UNESCO since 1985 to satisfy the need expressed by many institutions, especially in developing countries, to be able to streamline their information processing activities by using modern (and relatively inexpensive) technologies. From the outset, CDS/ISIS was created as a multi-lingual software, providing integrated facilities for the development of local linguistic versions. Thus, although UNESCO distributes only the English, French and Spanish versions of the package, user-developed versions exist in virtually all languages, including special versions which UNESCO helped to develop, for Arabic, Chinese and Korean.

How to contact them:

Over the last twelve years, micro CDS/ISIS has become one of the most popular packages of its kind in the world: over 20,000 registered copies of the software have been distributed free-of-charge (or at cost price) the world over in both developed and developing countries. Although UNESCO distributes directly many copies of the package from Paris, the policy is to promote the establishment of distributing centres in as many countries as possible, whenever the number of users becomes significant, so as to reduce the financial burden on UNESCO. To date, they have a network of some 138 officially appointed distributors around the world, 72 of which are national distributors. The conditions on the use of CDS/ISIS are specified in the License Agreement signed between UNESCO (or the official distributor) and the receiving institution. You may write to UNESCO for more information and/or contact information for the nearest distributor.

UNESCO Coupons Program

7, place de Fontenoy

75352 Paris 07 SP

Country: France

Phone: (331) 4568 1000

Fax: (331) 4567 1690

Email:

URL: <http://www.unesco.org/general/eng/product/coupon/index.html>

Contact:

Services offered:

In many countries the shortage of foreign currency hinders the importation of books, publications and scientific material. In some of these countries UNESCO Coupons, whose value is expressed in United States dollars, are sold for national currency to educators, research workers and students who use them to pay for their foreign purchases. The Coupons are issued in the following values: \$1,000, \$100, \$30, \$10, \$3, \$1 and 'blank' Coupons, which can be made out by the distributing body for amounts from 1 to 99 U.S. cents, are also available. As a general rule, all publications, films and material intended for educational, scientific or cultural purposes can be purchased with UNESCO Coupons.

How to contact them:

In every user country there is a body responsible for the sale of the Coupons. As a rule, this is the National Commission for UNESCO. This agency supplies information on request, concerning the purchase of the Coupons. In cases where it has only a limited allocation of Coupons, the agency decides on an order of priority for the various requests received.

HOW DOES ONE USE UNESCO COUPONS?

Users pay for the Coupons in national currency at the official United Nations rate of exchange on the day of purchase. National distributing bodies may add a surcharge to cover handling costs, but this may not exceed 5 per cent of the value of the Coupons. Coupon users should send the supplier their order with the Coupons corresponding to the price of the material, including where necessary, the cost of insurance and postage.

Many publishers, booksellers and firms which produce educational, scientific and cultural material will accept UNESCO Coupons as payment. The distributing bodies can give users some explanations about this. Coupon users placing orders with firms unfamiliar with the UNESCO Coupons Program sometimes experience difficulty in getting them honoured. When this happens, they can request assistance from the Coupons Office in the UNESCO Secretariat; the Office will then inform the supplier of the conditions governing the redemption of Coupons and will try to facilitate settlement.

UNESCO cannot intervene in the actual commercial transaction between user and supplier. It is therefore up to the users themselves in their correspondence with suppliers to explain exactly what they want in the way of goods, date of delivery, packaging, insurance and method of dispatch. It is likewise their responsibility to address any complaints directly to suppliers or transporters.

UNESCO Coupons are a means of payment and users should take all the usual precautions to prevent their loss, theft or misuse. In case of loss or theft, please inform the UNESCO Coupons Office immediately of the serial numbers of the missing Coupons. If the missing Coupons have not been presented for redemption within six months, the Coupons Office will replace them.

World Library Partnership (WLP)

1028 Bahama Rd.

Bahama, NC 27503

Country: U.S.A.

Phone: (1 919) 479-0163

Fax: (1 919) 479-0163

Email: yovo@mci.com

URL: <http://RTPnet.org/~wlp>

Contact: Laura Wendell

Services offered:

The World Library Partnership fosters literacy, learning and global understanding by connecting libraries world-wide. WLP forms partnership between libraries in developing countries and libraries in the United States. These partnerships focus on cultural exchange and raising funds to support small libraries in developing countries. Each American library conducts at least one fundraising event per year to help their partner

purchase books and supplies and pay for postage and other expenses associated with exchange projects. The suggested amount is US\$500 per year. WLP also distributes information (including this manual) about book donation programs, training, funding, library associations, publishing networks and other programs of importance to libraries in developing countries. WLP does not have a book donation program, nor does it fund libraries directly.

How to contact them:

WLP invites libraries to write to them at their address above for a partnership application and guidelines. Please note that school libraries should apply during the months of August - February. Since the American school system opens in September and closes from June - August, recruiting new school library partners from March - July is not generally possible. Other types of libraries may apply at any time. The partnership program serves primarily small rural libraries. It does not serve national or university libraries at this time. Any library may write to WLP for information about library-related programs in developing countries. This information is also available in the Library Resource Database on WLP's web site.

BIBLIOGRAPHY

LIBRARY MANUALS

Baird, N. Setting Up and Running a School Library. London, Heineman, 1994. 137 p.

This excellent book is a necessity for school libraries. It covers all the basics plus some great suggestions for helping students to use the library and improve their library skills. It also includes the entire Junior Colour Code classification schedule. To obtain ordering information, contact the VSO (Voluntary Service Overseas) office nearest you or write to:

VSO
317 Putney Bridge Road
London SW15 2PN
UK

Caubergs, L. The Management of Technical Information Centres. Leuven, Belgium, CTA/ATOL, 1992. 61 p.

This useful guide to running a technical documentation centre focuses on managing agricultural information, but has a lot of general information as well. In addition to information about setting up a library, it contains an entire chapter on creating bibliographies, abstracts and other document descriptions. It also describes the SATIS classification system for rural development and appropriate technology libraries. To request a free copy, write to:

CTA
Postbus 380
6700 AJ Wageningen
The Netherlands

Department of Non-Formal Education (Thailand). A Training package for Rural Public Libraries. Sweden, Uppsala University Library, 1997. 35 p. (IFLA/ALP Project report no 11.)

This publication is a summary of six training modules used by the Thailand Department of Non-Formal education to train rural librarians. It assumes that the librarians have prior knowledge of basic book handling procedures and focuses on increasing community outreach and services. The descriptions of each module are concise. They are not meant to give a full description of the training, but rather a brief outline of the topics covered. Few exercises are described in enough detail to be duplicated, but the manual is an excellent starting-point for designing a similar training program.

IFLA/ALP
c/o Uppsala University Library
Box 510
S-751 20 Uppsala
Sweden

Doyle, R.P.; Scarry, P. Guidelines on Library Twinning. Paris, General Information Programme and UNISIST United Nations Educational, Scientific and Cultural Organisation, 1994. 84 p.

This guide to library twinning gives many practical suggestions for setting up a successful twinning relationship. It includes a sample twinning agreement and a resource guide containing sister city/twinning organisations, book donation programs and staff exchange programs:

*General Information Programme
UNESCO
7, Place de Fontenoy
75352 Paris 07 SP
France*

Forest Press. Summaries DDC 20. Albany, New York, Forest Press, 1989. 15 p.

This is a summary of the Dewey Decimal Classification through the thousands. It does not contain any information about how to use the DDC, just the subject codes. To request a copy write to:

*Forest Press/OCLC
85 Watervliet Avenue
Albany, New York 1220-2082
U.S.A.*

Giggey, S. Rural Community Resource Centres: A Guide for Developing Countries. London, Basingstoke, MacMillan Education Ltd., 1988. 117 p.

A simple and concise manual for community librarians with little or no experience. This manual is less technical than some of the others on this list and addresses community organising and fundraising in addition to the more standard topics in library management. It was commissioned by the Commonwealth Secretariat and should be available through the British Council Library System or Voluntary Service Overseas (VSO) in most Commonwealth countries.

Maya, E.W. and Macharia, D. Where There is no Librarian: an Information Management Manual. Nairobi, Environmental Liaison Centre International, 1992. 92 p.

The primary emphasis of this manual is on NGO information handling.

*Environmental Liaison Centre International
PO Box 72461
Nairobi, Kenya*

Moorman, J. Managing Small Library Collections in Business and Community Organisations: Advice for Non-librarians. Chicago, The American Library Association, 1989. 31 p.

This manual was written for small libraries in the United States. It contains some useful general information about setting up a library, circulating books and keeping accounts. Much of the information in the appendices is specific to the United States. It is currently out of print.

Motlhabane, R. E. Organising School Libraries: A Manual for Community Junior Secondary Schools. Gabarone, Botswana, National Library Service, 1991. 57 p.

This manual covers the basic library management practices preferred by the Botswana National Library Service. It could be a good model for school libraries:

*Botswana National Library Service
Private Bag 0036
Gabarone, Botswana*

Myers, M. Community Information Services: a Manual and Resource Guide. Gaborone, Botswana, National Library Service, 1997. 64 p.

Have you been wondering how to make your library more relevant to the community? This concise manual contains many good suggestions for bringing up-to-date community-focused information into the library. It covers how to identify "hot topics" in the community, where to get information about these topics, how to repackage this information to make it more accessible to library users, how to create your own materials on important topics, how to publicise your library, how to evaluate your services and additional outreach strategies.

*Botswana National Library Service
Private Bag 0036
Gabarone, Botswana*

Naber, G. An Agricultural Library: Its Start and Management. Netherlands, International Institute for Land Reclamation and Improvement, 1991. 123 p.

This is a rather technical guide for agricultural libraries. It would also be appropriate for NGO libraries. It contains several useful appendices including one about how to start a small library, a list of research organisation newsletters, addresses of publishers (including Spanish and Portuguese language publishers), a list of journals on library science (including training programs) and other helpful lists. To request a free copy, write to:

ILRI
PO Box 45
6700 AA Wageningen
The Netherlands

Peace Corps/The Gambia. Resource Centre Manual and Library Manual for Schools and Other Institutions in The Gambia. The Gambia, Peace Corps The Gambia, 1995. 32 p.

This is a very grassroots manual. I particularly enjoyed reading the instructions for making glue, chalk, crayons and other low-cost teaching aids. To request a copy, write to:

Peace Corps/The Gambia
P.O. Box 582
Banjul, The Gambia

Ray, C. Running a School Library: A Handbook for Teacher Librarians. London, MacMillan Education Ltd., 1990. 100 p.

A clear, thorough and informative resource for school librarians. It covers the purpose of the library, establishing the library, accommodation and space, storage, stock, library routines (administration), classification, cataloguing and using the library. It was commissioned by the Commonwealth Secretariat and should be available through the British Council Library System in most Commonwealth countries.

Rosenberg, D. Rural Information Provision in Developing Countries: Measuring Performance. Paris, UNESCO, 1997. 118 p. (Report CII-97/WS/11)

This valuable resource outlines standards for rural information centres and provides practical techniques for evaluating how well they meet the needs of their users. It contains sample evaluation tools and suggestions for using the results of an evaluation to improve services. It also contains a good discussion of Internet use in rural libraries and guidelines regarding which information and media are most useful to rural populations. Free (?) copies are available from:

General Information Programme
UNESCO
7, Place de Fontenoy
75352 Paris 07 SP
France

Rural Libraries and Resources Development Programme (RLRDP). A Manual for Rural Libraries in Zimbabwe. Bulawayo, Zimbabwe, RLRDP, 1992. 72 p.

This concise manual was written specifically for small rural libraries. It covers basic topics in library management: the role of the library in the community, location and establishment, stock selection, processing materials, caring for materials and promotion. It is available from:

RLRDP
PO Box QP105
Queens Park
Bulawayo, Zimbabwe

Stein, B. Running a School Library Media Centre: A How-to-do-it Manual. New York, London, Neal-Schuman, 1992. 143 p. (Series How-to-do-it Manuals for School and Public Librarians, 1.)

A down to earth guide to running a school library in the United States. It contains sections on administration, ordering and processing materials, cataloguing, circulation, maintenance, hiring, library design and programming.

Technical Centre for Agricultural and Rural Cupertino (CTA). Organising Agricultural Library Collections: A Workbook. edited by Foss, P; Payne, A. M. Wageningen, The Netherlands, CTA, 1991. 92 p.

This workbook is based on a training program developed by CTA for librarians with little or no formal training. It is specifically designed for agricultural libraries in the Pacific, but there is a lot of excellent practical information of general interest. It contains step-by-step instructions for weeding a collection, managing serials, managing books, descriptive cataloguing, managing pamphlets (including subject classification), making the library user-friendly, reference services and publicity. It is highly recommend for any small library. To request a free copy, write to:

CTA
Postbus 380
6700 AJ Wageningen
The Netherlands

UNCHS Habitat. Basic Manual for Library Management. 1st ed. Nairobi, UNCHS Habitat, 1984. 76 p.

A Basic manual for technical libraries.

United States Department of Health and Human Services. How to Start and Run an Alcohol and Other Drug Information Centre: A Guide. edited by Rolett, V.; Kinney, J. U.S.A., The United States Department of Health and Human Services, 1990. 101 p.

Librarians at many types of small specialised libraries (such as health, agriculture or environmental centres) may find this guide useful. It contains some specific advice for librarians in specialised libraries as well as general information on setting up and running a library.

GUIDES TO BOOK DONATION PROGRAMS

Greenburg, J. Manual for International Book and Journal Donations. New York, American Council of Learned Societies, 1993. 108 p.

This book contains a thorough discussion of the issues facing learned societies wishing to start a book donation program. It also contains descriptions of selected book donation programs (focused on university level technical material), an annotated bibliography and a list of contact addresses. To request a copy, write to:

*ACLS
228 East 45th Street
New York, NY 10017-3398
U.S.A.*

International Federation of Library Associations and Institutions (IFLA). Guide to Institutions Supporting Librarianship in Developing Countries. Edited by Birgitta Sandell Uppsala, Uppsala University Library, 1996. 83 p. (Project report no 7).

The IFLA guide contains brief descriptions of organisations that provide funding, training or other support for libraries. To request a copy, write to:

*IFLA/ALP
c/o Uppsala University Library
Box 510
S-751 20 Uppsala
Sweden*

International Network for the Availability of Scientific Publications (INASP). INASP Directory 1997/1998. Edited by Priestley, C.; Rowbotham, G. Oxford, INASP, 1997. 192 p.

The INASP Directory is updated bi-annually and “provides full information on 230 agencies, organisations, learned societies, professional associations and foundations involved in supporting library and book development. These may be organisations with a particular focus on one or more scientific disciplines, or organisations devoted to book or library development, or agencies whose programmes include support to library and book development as one of their areas of activity. Each entry includes full name and contact details, details of services, programmes and materials offered, and organisational policies with programme profiles.” Most of the organisations listed specialise in materials at the university level. To request a copy, write to:

*INASP
27, Park End Street
Oxford
OX1 1HU
United Kingdom*

International Relations Round Table of the American Library Association. International Leads. (Chicago), Vol. 8, no. 3, 1994. 6 p.

This issue of International Leads summarises many of the issues from the Dialog of Partners Handbook (see below) and contains descriptions of 20 book donation organisations. To request a copy, write to:

*America Library Association
International Relations Round Table
50 East Huron St.
Chicago, IL 60611
U.S.A.*

INTRAH. List of Free Materials in Reproductive Health. 7th ed. North Carolina, INTRAH, 1996. 257 p.

This guide to free materials in reproductive health is available in English, French and Spanish. To request a copy, write to:

*INTRAH Publications Program
University of North Carolina
School of Medicine
208 N. Columbia St.
CB# 8100
Chapel Hill, NC 27514
U.S.A.*

Library of Congress. Donated Book Programs: A Dialog of Partners Handbook. Washington, Library of Congress, 1993. 104 p.

This book is based on the proceedings of the Dialog of Partners Workshop held on September 14-16, 1992 in Baltimore, Maryland, U.S.A. The Workshop brought together book donors and recipients from about 50 countries. The book contains a summary of the issues raised during the seminar; a guide to implementing a donated book program; and a list of the workshop participants. The participant list includes program descriptions and contact information. To request a copy, write to:

*The Centre for the Book in the Library of Congress
101 Independence Ave., S.E.
Washington, D.C. 20540-8200
U.S.A.*

Peace Corps of the United States. Sources of Donated Books. Washington, DC, Peace Corps Information Collection and Exchange, 2008. 26 p.

This useful manual is updated annually, but it is only available to Peace Corps Volunteers.

Walsh, G. Book Donation Projects for Africa: A Handbook and Directory. Atlanta, The Book Famine Task Force of the African Studies Association, 1992. 8 p.

This handbook gives a concise and insightful summary of the key issues for each component of a book donation project: recipient, donor, books, transportation and communication. It also contains examples of successful projects and a brief directory of book donation organisations. To request a copy, write to:

ASA
Emory University
Credit Union Building
Atlanta, GA 30322
U.S.A.

FURTHER READING

- Abidi, S. Communication, Information and Development in Africa. Kenya, Masaki Publishers, 1991. 148 p.
- Banque Internationale d'Information sur les Etats Francophones (BIEF). Jumelage de Bibliothèques/Library Twinning. Ottawa, Canada, BIEF, 1991. 153 p.
- International Federation of Library Associations and Institutions (IFLA). Seminar on Information Provision to Rural Communities in Africa. Sweden, Uppsala University Library, 1995. 151 p. (Project Report no. 3.)
- Olden, A. Libraries in Africa: Pioneers, Policies, Problems. London, Scarecrow Press, 1995. 170 p.
- Partridge, W.G.McD. Low Budget Librarianship: Managing Information in Developing Countries. London, The Library Association, 1988. 93 p.
- Peace Corps Information Collection and Exchange. Participatory Analysis for Community Action (PACA) Training Manual. Washington, D.C., Peace Corps Information Collection and Exchange (Manual M0053). Revised, 2007. 242 pp.
- Rosenberg, D. University Libraries in Africa: a Review of their Current State and Future Potential. London, International African Institute, 1997. 84 p. (Volume one: Summary)
- Sturges, P and Neill, R. The Quiet Struggle: Libraries and Information for Africa. London, Mansell, 1990.
- Thomas, B. Libraries for Literacy in Geographically and Socially Isolated Communities. Sweden, Uppsala University Library, 1995. 42 p. (Project Report no. 4.)

