



Mathematics Education Research Group of Australasia Inc.



MERGA33 – 2010

Shaping the Future of Mathematics Education

*Proceedings of the 33rd annual conference of the
Mathematics Education Research Group of Australasia*

held at

John Curtin College of the Arts, Fremantle, 3-7 July 2010

Editors

Len Sparrow, Barry Kissane, Chris Hurst

Copyright © 2010 Mathematics Education Research Group of Australasia Inc.

Published by MERGA Inc., Fremantle, Australia

Shaping the future of mathematics education

Proceedings of the 33rd annual conference of the Mathematics Education Research Group of Australasia, Fremantle, Western Australia, July 3-7, 2010

ISBN 978-1-920846-25-1

Edited by Len Sparrow, Barry Kissane, and Chris Hurst

Produced by ProCopy, Morley

Copies of this CD are for distribution to MERGA33 Conference delegates

Preface

These collected papers are a record of the proceedings of the 33rd Annual Conference of the Mathematics Education Research Group of Australasia entitled, *Shaping the Future of Mathematics Education*. The conference is held in Fremantle, as was the previous conference a decade earlier.

Keynote speakers are discussing issues that are emerging more sharply at the present time as the mathematics education community focus on the education of Indigenous children, the scope of the mathematics curriculum and ways in which the content might be taught effectively, and the significant role of technologies in teaching and learning in the twenty-first century.

Research papers are featured from mathematics educators from all states and territories of Australia, from colleagues in New Zealand, and from overseas — United Kingdom, Singapore, United States of America, India, Thailand, South Africa, and Indonesia. Some participants are not only new researchers but also new to the conference. Many have been aided by experienced colleagues via the supervision process within their university and also by the Early Bird system coordinated by MERGA and the Organising Committee. I wish to acknowledge the advice, comments, and suggestions given as part of the Early Bird system by experienced MERGA researchers. Their generosity in many ways repays the help and advice they received from the MERGA community earlier in their own careers.

All papers submitted for publication have been ‘double blind’ reviewed by at least two experienced researchers and writers organised into review groups for the purpose. In some cases a third person also reviewed the paper. Only papers that have been accepted by two reviewers are published in these proceedings. In the ‘double blind’ review process, neither the reviewer nor the author was named. Reviewers worked with a set of review guidelines produced by MERGA to work for consistency of outcome. My thanks are offered to the group coordinators, the reviewers, Emeritus Professor John Malone for his coordination of the process, and to the local Organising Committee.

This set of proceedings includes abstracts and full papers for refereed research presentations, short communications of developing research, roundtable discussions, and symposia. Thanks are due to the co-editors, Barry Kissane and Chris Hurst, for their diligence and support in editing and compiling these proceedings.

The conference has been organised by a group of mathematics educators from each of the five universities in Perth, the main education systems, and the Curriculum Council of Western Australia. There has been a wonderful sense of collaboration typical of mathematics educators in Western Australia. All has been achieved under the experienced and watchful eye of conference organiser, Dr. Jack Bana. My thanks and appreciation is offered to all.

Len Sparrow
Chair, Conference Organising Committee

Table of Contents

<i>Reform under Attack – Forty Years of Working on Better Mathematics Education Thrown on the Scrapheap? No Way!</i>	15
Marja van den Heuvel-Panhuizen	
<i>Structured Failing: Reshaping a Mathematical Future for Marginalised Learners</i>	40
Robyn Jorgensen (Zevenbergen)	
<i>Technology, Research and Practice in Mathematics Education</i>	50
Barry Kissane	
<i>Making Sense of Critical Mathematics Teaching</i>	51
Annica Andersson	
<i>Perceived Professional Learning Needs of Numeracy Coaches</i>	59
Leonie Anstey and Barbara Clarke	
<i>Students’ Experiences of Mathematics During the Transition from Primary to Secondary School</i>	67
Catherine Attard	
<i>Percentages: The Effect of Problem Structure, Number Complexity and Calculation Format</i>	75
Wendy Baratta, Beth Price, Kaye Stacey, Vicki Steinle, and Eugene Gvozdenko	
<i>Why do Disadvantaged Filipino Children Find Word Problems in English Difficult?</i>	67
Debbie Bautista and Joanne Mulligan	
<i>Two Test Items to Explore High School Students’ Beliefs of Sample Size when Sampling from Large Populations</i>	91
Anthony Bill, Sally Henderson, and John Penman	
<i>The Impact of a Developmental Framework in Number on Primary Teachers’ Classroom Practice</i>	83
Janette Bobis	
<i>Language Negotiation in a Multilingual Mathematics Classroom: An Analysis</i>	107
Arindam Bose and Manojendu Choudhury	
<i>The ‘Number Proficiency Index’: Establishing the Starting Point for Mathematical Instruction in High School</i>	115
Phil Brockbank	
<i>Walking the Talk: Translation of Mathematical Content Knowledge to Practice</i>	123
Barbara Butterfield and Mohan Chinnappan	
<i>Scratching Below the Surface: Mathematics through an Alternative Digital Lens?</i>	131
Nigel Calder and Marilyn Taylor	

<i>Using Developmental Frameworks to Support Curriculum Outcomes</i>	139
Rosemary Callingham and John Pegg	
<i>The Influence of the Mathematics Class on Middle School Students' Interest for Statistical Literacy</i>	147
Colin Carmichael	
<i>Students' Frames of Reference and Their Assessments of Interest for Statistical Literacy</i>	153
Colin Carmichael	
<i>Aspects of Teachers' Knowledge for Helping Students Learn About Ratio</i>	159
Helen Chick	
<i>Teachers' Extent of the Use of Particular Task Types in Mathematics and Choices Behind That Use</i>	167
Doug Clarke and Anne Roche	
<i>Students as Decoders of Graphics in Mathematics</i>	175
Carmel M. Diezmann and Tom Lowrie	
<i>Challenging Multiplicative Problems Can Elicit Sophisticated Strategies</i>	183
Ann Downton	
<i>The Impact of Two Teachers' Use of Specific Scaffolding Practices on Low-attaining Upper Primary Students</i>	191
Sarah Ferguson and Andrea McDonough	
<i>The Predominance of Procedural Knowledge in Fractions</i>	199
Tricia Forrester and Mohan Chinnappan	
<i>Becoming More Numerate: The Journey of Tania</i>	207
Linda Galligan	
<i>Bridging the Numeracy Gap for Students in Low SES Communities: The Power of a Whole School Approach</i>	216
Ann Gervasoni, Linda Parish, Cait Upton, Teresa Hadden, Kathie Turkenburg, Kate Bevan, Carole Livesey, Deirdre Thompson, Melissa Crosswell and Julie Southwell	
<i>Auditing the Numeracy Demands of the Middle Years Curriculum</i>	224
Merrilyn Goos, Vince Geiger, and Shelley Dole	
<i>The Terminology of Mathematics Assessment</i>	232
Jane Greenlees	
<i>Mathematics Teachers: Negotiating Professional and Discipline Identities</i>	239
Peter Grootenboer and Julie Ballantyne	
<i>A Network Analysis of Concept Maps of Triangle Concepts</i>	248
Jin Haiyue and Wong Khoon Yoong	

<i>Impact of Context and Representation on Year 10 Students' Expression of Conceptions of Rate</i>	254
Sandra Herbert	
<i>Year 11 Advanced Mathematics: Hearing from Students who Buck the Trend</i>	264
Kai Fai Ho	
<i>'You might say you're 9 years old but you're actually B years old because you're always getting older': Facilitating Young Students' Understanding of Variables</i>	272
Jodie Hunter	
<i>Coming to 'Know' Mathematics through 'Acting, Talking and Doing' Mathematics</i>	280
Roberta Hunter	
<i>The Mathematical Needs of Urban Indigenous Primary Children: A Western Australian Snapshot</i>	288
Chris Hurst and Len Sparrow	
<i>Student Attitude, Student Understanding and Mathematics Anxiety</i>	296
Michelle Jennison and Kim Beswick	
<i>Upper Primary School Students' Algebraic Thinking</i>	305
Natcha Kamol and Yeap Ban Har	
<i>Utilising Year Three NAPLAN Results to Improve Queensland Teachers' Mathematical Pedagogical Content Knowledge</i>	313
Eduarda van Klinken	
<i>Learning Mathematical Concepts Through Authentic Learning</i>	321
Koh Noi Keng and Low Hwee Kian	
<i>A Teacher Pair Approach to Adopting Effective Numeracy Teaching Practice</i>	328
Janeen Lamb and Vince Geiger	
<i>Assessment for Learning Tasks and the Peer Assessment Process</i>	336
Lorraine Lauf and Shelley Dole	
<i>I liked it till Pythagoras: The Public's Views of Mathematics</i>	344
Gilah C. Leder and Helen J. Forgasz	
<i>Examinations in the Final Year of Transition to Mathematical Methods Computer Algebra System (CAS)</i>	352
David Leigh-Lancaster, Magdalena Les, and Michael Evans	
<i>A 'knowledge quartet' Used to Identify a Second-Year Pre-service Teacher's Primary Mathematical Content Knowledge</i>	360
Sharyn Livy	

<i>Web-based Mathematics: Student Perspectives</i>	368
Esther Yook-Kin Loong	
<i>The Relationship between the Number Sense and Problem Solving Abilities of Year 7 Students</i>	376
Jemmy Louange and Jack Bana	
<i>Teachers' Perceptions of Geometry Instruction and the Learning Environment in Years 9-10 ESL Classrooms</i>	383
Rinna K. Ly and John A. Malone	
<i>Young Children's Measurement Knowledge: Understandings about Comparison at the Commencement of Schooling</i>	391
Amy MacDonald	
<i>Developing a Framework for the Selection of Picture Books to Promote Early Mathematical Development</i>	399
Jennifer Marston	
<i>Teacher Change in Response to a Professional Learning Project</i>	407
Andrea McDonough, Philip Clarkson, and Anne Scott	
<i>Pre-service Students' Responses to Being Tested on their Primary School Mathematical Knowledge</i>	415
Tamsin Meaney and Troels Lange	
<i>Computational Estimation in the Primary School: A Single Case Study of One Teacher's Involvement in a Professional Learning Intervention</i>	423
Paula Mildenhall, Mark Hackling, and Paul Swan	
<i>Gap Thinking in Fraction Pair Comparisons is not Whole Number Thinking: Is This What Early Equivalence Thinking Sounds Like?.....</i>	430
Annie Mitchell and Marj Horne	
<i>Connecting the Points: Cognitive Conflict and Decimal Magnitude</i>	438
Bruce Moody	
<i>A Decade of MERGA Theses</i>	446
Judith A. Mousley	
<i>Using Video-Stimulated Recall as a Tool for Reflecting on the Teaching of Mathematics</i>	454
Tracey Muir	
<i>Partial Metacognitive Blindness in Collaborative Problem Solving</i>	462
Kit Ee Dawn Ng	
<i>Changing our Perspective on Space: Place Mathematics as a Human Endeavour</i>	470
Kay Owens	

<i>Experiences of Learning and Teaching Mathematics: Using Activity Theory to Understand Tensions in Practice</i>	478
Shaileigh Page and Julie Clark	
<i>Facilitating the Development of Proportional Reasoning through Teaching Ratio</i>	485
Linda Parish	
<i>An Ethnographic Intervention using the Five Characteristics of Effective Teacher Professional Development</i>	493
Sitti Maesuri Patahuddin	
<i>Exploring the Relationship between Mathematical Modelling and Classroom Discourse</i>	501
Trevor Redmond, Joanne Sheehy, and Raymond Brown	
<i>Assessing the Number Knowledge of Children in the First and Second Grade of an Indonesian School</i>	509
Rumi Rumiati and Robert (Bob) Wright	
<i>Enactivism and Figural Apprehension in the Context of Pattern Generalisation</i>	517
Duncan Samson	
<i>Mathematics Registers in Indigenous Languages: Experiences from South Africa</i>	525
Marc Schäfer	
<i>Using Concept Cartoons to Access Student Beliefs about Preferred Approaches to Mathematics Learning and Teaching</i>	531
Matthew Sexton	
<i>How to Build Powerful Learning Trajectories for Relational Thinking in the Primary School Years</i>	539
Max Stephens and Dian Armanto	
<i>Students' Opinions about Characteristics of Their Desired Mathematics Lessons</i>	547
Peter Sullivan, Doug Clarke, and Helen O'Shea	
<i>The Multifaceted Variable Approach: Selection of Method in Solving Simple Linear Equations</i>	555
Salma Tahir and Michael Cavanagh	
<i>Interactive Whiteboards and all that Jazz: Analysing Classroom Activity with Interactive Technologies</i>	563
Howard Tanner, Sonia Jones, Gary Beauchamp, and Steve Kennewell	
<i>One on One Numeracy Intervention: A Pilot Project in Low SES Communities</i>	571
Steve Thornton, Gina Galluzzo, Mary Quinane, and Debbie Taylor	
<i>Now I'm teaching the children: Changing from Assessment of Learning to Assessment for Learning in Fiji</i>	
Kaye Treacy, Poniparte Tiko, Sarita Harish, and Prabha Nairn	579

<i>Student Centred Approaches: Teachers' Learning and Practice</i>	587
Colleen Vale, Mary Weaven, Anne Davies, and Neil Hooley	
<i>Documenting the Learning of Teacher Communities Across Changes in their Membership</i>	595
Jana Visnovska	
<i>The Researcher's Self in Research: Confronting Issues about Knowing and Understanding Others</i>	603
Margaret Walshaw	
<i>Indigenous Children's Ability to Pattern as They Enter Kindergarten/Pre-prep Settings: An Exploratory Study</i>	610
Elizabeth Warren and Jodie Miller	
<i>Student Change Associated with Professional Learning in Mathematics</i>	618
Jane Watson, Natalie Brown, Kim Beswick, Rosemary Callingham, and Suzie Wright	
<i>Biased Sampling and PCK: The Case of the Marijuana Problem</i>	626
Jane M. Watson and Erica L. Nathan	
<i>Counting On in the Middle Years</i>	634
Allan Leslie White	
<i>Modelling the Cooling of Coffee: Insights From a Preliminary Study in Indonesia</i> ...	642
Wanty Widjaja	
<i>Abstracting by Constructing and Revising a 'Partially Correct Construct': A Case Study</i>	650
Gaye Williams	
<i>Pre-service Teachers Constructing Positive Mathematical Identities: Positing a Grounded Theory Approach</i>	658
Sue Wilson	
<i>"I always feel more confident when I know where things are going": How do Pre-service Teachers Engage with Mathematics Curriculum Documentation?</i>	665
Sue Wilson and Jane McChesney	
<i>Beyond the Curriculum: The Mathematical Beliefs of Pre-service Primary Teachers in Hong Kong</i>	673
Wing Yee Lo and Judy Anderson	
<i>Algebraic Thinking: A Problem Solving Approach</i>	681
Will Windsor	
<i>Equivalent Fractions: Developing a Pathway of Students' Acquisition of Knowledge and Understanding</i>	689
Monica Wong	

<i>Mathematics Attitudes and Achievement of Junior College Students in Singapore</i>	701
Lim Siew Yee	
<i>Three Primary School Students' Cognition about 3D Rotation in a Virtual Reality Learning Environment</i>	706
Andy Yeh	
<i>Socio-economic Background, Senior Secondary Mathematics, and Post-secondary Pathways</i>	714
Eng Yeoh and David Leigh-Lancaster	
<i>Two Decades of Mathematics Education Reform in New Zealand: What Impact on the Attitudes of Teacher Education Students?</i>	721
Jenny Young-Loveridge	
Symposia	729
<i>Playing with Mathematics: Play in Early Childhood as a Context for Mathematical Learning</i>	730
Janette Bobis, Eva deVries, Sue Dockett, Kate Highfield, Robert P. Hunting, Shiree Lee, Bob Perry, Louise Thomas, and Elizabeth Warren	
<i>What Makes Mathematics Play?</i>	731
Sue Dockett and Bob Perry	
<i>Teaching Mathematics and Play-based Learning in an Indigenous Early childhood Setting: Early Childhood Teachers' Perspectives</i>	735
Eva deVries, Louise Thomas, and Elizabeth Warren	
<i>Mathematical Outdoor Play: Toddlers' Experiences</i>	739
Shiree Lee	
<i>Little People, Big Play, and Big Mathematical Ideas</i>	743
Robert P. Hunting	
<i>Maths in the Kimberley Project: Evaluating the Pedagogical Model</i>	747
Robyn Jorgensen (Zevenbergen), Peter Grootenboer, Peter Sullivan, and Richard Niesche	
<i>Maths in the Kimberley Project: An Overview</i>	748
Richard Niesche, Peter Grootenboer, Robyn Jorgensen (Zevenbergen), and Peter Sullivan	
<i>Effective Features of the Maths in the Kimberley Inclusive Pedagogy Model</i>	752
Peter Grootenboer	
<i>Group Work, Comma and Language Interaction: Challenges of Implementation in Aboriginal Contexts</i>	756
Robyn Jorgensen (Zevenbergen)	

Problem Solving in the School Curriculum from a Design Perspective760
Toh Tin Lam, Leong Yew Hoong, Jaguthsing Dindyal, and Quek Khiok Seng

Enacting a Problem Solving Curriculum761
Leong, Yew Hoong, Toh Tin Lam, Quek, Khiok Seng,
Jaguthsing Dindyal, Tay, Eng Guan, and Lou, Siew Tee

Problems for a Problem Solving Curriculum765
Jaguthsing Dindyal, Quek, Khiok Seng, Leong, Yew Hoong,
Toh Tin Lam, Tay, Eng Guan, and Lou, Siew Tee

Resources for Teaching Problem Solving: A Problem to Discuss769
Quek, Khiok Seng, Toh Tin Lam, Jaguthsing Dindyal, Leong,
Yew Hoong, Tay, Eng Guan, and Lou, Siew Tee

Roundtable Presentations 774

Targeted Learning: A Successful Approach775
Linda Cheeseman, Bina Kachwalla, and Marilyn Holmes

Online Professional Development for Mathematics Teachers776
Brooke Evans, Patricia McKenna, Don Gilmore, and James Loats

Teaching Mathematics for an Ethical Citizenry777
Helen J Forgasz

*K-10 National Mathematics Curriculum Implementation:
Implications for Research and Teacher Education*777
Merrilyn Goos, Robyn Jorgensen, Christelle Plummer, Glenys Reid,
Peter Sullivan, and Gaye Williams

*Magnifying Misalignment of Student Data Across a Range of Assessment
Tools to Inform Future Learning Goals*778
Marie Hirst and Anuja Singh

*Make it Count: An Evidence Base to support Numeracy,
Mathematics and Indigenous learners*779
Will Morony and Caty Morris

Short Communications 780

*Primary Students' Theories of Intelligence, Mathematics Self-Efficacy
and Achievement: Analysis of the Initial Data*781
Linda Bonne

Using Primary-School Learning Environments to Teach Maths at University781
David Butler

<i>Pre-service Primary Teachers' Ability to Communicate Mathematics Concepts Effectively</i>	782
Chua Kwee Gek	
<i>An Alternative Pathway to University Mathematics</i>	782
Nicholas Crouch	
<i>Preparing a New Generation of High School Mathematics Teachers</i>	783
Joanne E. Goodell	
<i>A Survey of Instructional Leaders in Primary Schools: Emerging Patterns in Numeracy Leadership</i>	783
Joanna Higgins and Linda Bonne	
<i>Calculator Technologies and Females' Mathematics Learning: A Pilot Study</i>	784
Janelle Hill	
<i>Values Operating in Effective Mathematics Lessons in Singapore: Reflections from Classroom Observations</i>	784
Ho Siew Yin	
<i>Lesson Study as Research and Professional Development for Practitioners</i>	785
Jodie Hunter	
<i>The Effectiveness of a Dynamic Professional Development Model Using an Online Mathematics Learning System</i>	785
Sharon London, Joanne Mulligan, Michael Cavanagh, and Matthew Bower	
<i>Teaching and Learning in an Interactive Multimedia E-Learning Environment</i>	786
Sharon London, Mike Mitchelmore, and Michael Cavanagh	
<i>Aboriginal Independent Community Schools Numeracy Strategy</i>	786
Daniel Pinchas, Renae Small, Rebecca Youdale, Shirley Riley, and Kaye Treacy	
<i>Elementary Students' Understanding of Variable: The Role of Problem Type and Representation</i>	787
J. Matt Switzer	
<i>Singaporean Senior Secondary Students' Ways of Using Graphics Calculators</i>	788
Hazel Tan	

Keynote Presentations



Reform under attack – Forty Years of Working on Better Mathematics Education thrown on the Scrapheap? No Way!

Marja van den Heuvel-Panhuizen
Freudenthal Institute, Utrecht University
<m.vandenheuvel@fi.uu.nl>

This paper addresses the reform of mathematics education in the Netherlands and the attacks that presently take place against this reform. The attacks concentrate on primary education and criticize in particular the program for teaching calculation skills with long division as a case in point. The paper gives an overview of what Realistic Mathematics Education (RME) stands for, and what mathematics education the reform-attackers have in mind. Furthermore, attention is paid to possible factors that could have triggered this attack, and what other countries may learn from it.

What comes after a reform of mathematics education? It is beginning to look as if the answer to that question is: War. In the late nineties of the previous century a so-called ‘Math war’ overran the United States, starting as a reaction to the reform-based curriculum and teaching approach in California (Becker & Jacob, 2000). Presently, we have a similar situation in the Netherlands. The attack concentrates on primary education. The focus of the assault is both on what students should learn and on didactical methods. Without any evidence from research, the main principles of ‘Realistic Mathematics Education’ (RME), which form the basis of the Dutch reform, are called ‘didactical blunders’. At the same time an argument is made in favour of a form of education that is almost the polar opposite of what RME stands for. According to the reform-attackers, mathematics should not be taught in context, informal strategies should be avoided because they confuse children, progressive schematisation leads to a long, unnecessary detour and the focus should not be on understanding; because understanding comes automatically after training. Moreover, it is stated shamelessly that children do not need to think. In the mind of the reform-attackers the main content to be learned in primary school must consist of written algorithms.

The development of RME commenced in the late 1960s and is still developing to reach further maturity as an instructional theory and in its implementation into educational practice. Up to some forty years ago, this development process went on with trial and error, but in relative peace. Actually, it was a silent revolution; there was hardly a whisper in the media (Treffers, 1991a). There was very little opposition and no pressure from above. For example, in all those forty years there has been hardly any government involvement with the reform of mathematics education. The Ministry of Education was only involved in a facilitating sense. Government subsidy made it possible that an extensive infrastructure arose in the Netherlands allowing development, research and training to take place in mutual coherence and cooperation with the field of education. Where other educational researchers were blamed for the gap between their research and educational practice, we were held up as an example of how research should be done; see the report by the Education Council of the Netherlands (Onderwijsraad, 2003). Not only was there recognition in our own country, but we also inspired developments in many other countries. Our work was, and still is, in great demand all over the world, even if only perhaps that it gives these countries good hope of being able to attain such high test scores as the Dutch.

Looking back, the peace we had for forty years had everything to do with student performance. In 2004 and 2005, the first reports of disappointing results in both national tests



and in TIMSS and PISA came in. From that time on, RME was coming under fire. Unfortunately, the discussion that was started was anything but academic, but was a veritable libel campaign that took place mainly in newspapers and on websites. It happened regularly that there were sneering articles in these media about the ruination of Dutch mathematics education by the Freudenthal Institute — or more precisely — about the ruination of the education in written arithmetic, because that was what the discussion focused on. Dutch students could no longer do written calculations. Long division was often used as an example.

What is in the Newspapers in the Netherlands?

The opponents of RME have as their leader, a professor in mathematics, who used to teach at a military academy. He and his supporters argue for mathematics education based on bare numbers, where the teacher demonstrates the problems and the students learn by imitation. For each operation there is one prescribed procedure, namely that of algorithmic addition, subtraction, multiplication and division. Using this algorithmic procedure starts already for problems up to 100. There must be a lot of practice, and that practice will automatically lead to insight (Van de Craats, 2007).

Along with this plea for returning to the mathematics education of forty years ago — or rather, to the one-sided view that the attackers of RME have of mathematics education in the past — a great number of misconceptions and inaccuracies about RME, is put forward in the media:

- If we are to believe the media, students do not get the opportunity to practice in RME. This, however, is a flagrant contradiction of RME's long tradition in including practice (see De Jong, Treffers, & Wijdeveld, 1975; De Moor, 1980; Treffers & De Moor, 1990; Van den Heuvel-Panhuizen & Treffers, 1998; Menne, 2001; Van Maanen, 2007). An aside here is that in RME this means practising with understanding and coherence, which is radically different from the isolated drill that the opponents of RME have in mind.
- RME is said to have abolished algorithmic calculations. Again this is simply not true. See what the main curriculum documents — the so-called 'Proeve' (Treffers & De Moor, 1990) and the TAL learning-teaching trajectory for whole number calculation (Van den Heuvel-Panhuizen, 2008b) that describes the learning-teaching trajectory for whole number calculation in primary school mathematics — say about algorithms. Moreover, traditional algorithms are being widely taught (Janssen, Van der Schoot, & Hemker, 2005). It should be said though, that the degree to which that is done differs for each textbook series. For example, the RME textbook series *Wereld in Getallen* (WIG) contains a total of around 3000 digit-based algorithmic problems, 1200 for addition and subtraction, 1000 for multiplication and 750 for division (Levering, 2009).

A disturbing misapprehension that is being presented in this context in the media — and which clearly evidences a lack of didactical knowledge — is that the so-called 'traditional', digit-based algorithm and the 'new' method of whole-number-based written calculation (more on which later) are being showcased as two opposite end goals. The opponents of RME do not realise that the whole-number-based method is a transparent and insightful introduction to the digit-based algorithm and clearly show their didactical lack of understanding by presenting ridiculous examples of this approach in the media.

- RME supposedly only involves word problems. This is another unfounded assertion. One only needs to open an RME textbook to see that it is filled with a large amount of

bare number problems. Of course the amounts are different for each textbook, but there is not one RME textbook that does not have bare number problems.

However, there is one more reason that makes this insinuation far from the truth. Word problems have always been an object of suspicion within RME (Van den Heuvel-Panhuizen, 1996). Of course, linking problems to reality is important. This means that within RME students are presented problems which they can imagine and with which they have daily life experience, but this does not mean that word problems have a central role in RME. The crucial point is that the problems are presented in a meaningful and accessible context. Therefore they are often presented visually through pictures, models, and diagrams. Word problems with complicated ways of explaining a problem are avoided. They cannot be considered typical RME problems. However, our opponents do try to represent them as such.

- RME is said to teach students as many different calculation strategies as possible, which confuses students. Neither the first nor the second is true. RME starts teaching with following on from what students themselves come up with and do — which has natural variation — and from thereon gradually works towards a standard method, which is however not a straitjacket. The students must have an understanding of the numbers with which they calculate, and if possible use shortened calculation methods or smart strategies — which implies an intentional variation in strategy that reflects the high level of number understanding that RME wants students to reach.
- All RME textbooks are of low quality. Another inaccuracy. The outcomes of the large-scale studies (performed by Cito, the national institute for assessment in the Netherlands) into the effects of the textbooks belie this claim. The RME textbooks were among the best textbook series more often than the traditional ones (Janssen, Van der Schoot, Hemker, & Verhelst, 1999). Later, Cito (Janssen et al., 2005) concluded that the newer textbooks, despite the differences between them, have had a small, but positive summative effect on student performances. In other words, without these textbook series, performances would likely have been lower. More about these studies later.
- Supposedly, the average Dutch student at the end of primary school is incapable of calculating. Based on the latest Grade 4 data from TIMSS (Mullis, Martin, & Foy, 2008) it is clear that this statement is wholly unfounded. If it were in fact true, it would not only be the case for the Netherlands, but for all other Western countries that took part in TIMSS. I will return to this point later.

In addition to these misconceptions and inaccuracies about current Dutch mathematics education, the reform attackers regret deeply that a reform occurred and they worry themselves sick wondering why Dutch mathematics education was reformed. Utterances like these bear painful witness to a lack of any knowledge about the problems that existed in mathematics education forty years ago both in the Netherlands and internationally.

How RME Started and What It Stands For

Although the very beginning of RME can be placed at the end of the 60s, the name ‘Realistic’ was only used at the end of the 70s (Treffers, 1991a). The very beginning of the reform movement was the start, in 1968, of the Wiskobas project (meaning ‘mathematics in primary school’) initiated by Wijdeveld and Goffree, and joined not longer after by Treffers. It was these three who in fact built the foundation for RME. In 1971, when the IOWO Institute, with Freudenthal as its director, was established for the Wiskobas project

and a similar project for secondary education, the movement received a new impulse to reform mathematics education.

In the 1960 the Netherlands wanted to abandon the then prevalent mechanistic approach to mathematics education. Characteristic of this approach is its focus on calculations with bare numbers, and the little attention that it pays to applications; which is certainly true for the beginning of the learning process. Mathematics is taught in an atomised way. Students learn procedures in a step-by-step way in which the teacher demonstrates how to solve a problem.

Conversely, mathematics education in England had an empiricist slant in those days. Typical of this type of education was that students were let free to discover much by themselves and were stimulated to carry out investigations. This method deviated greatly from the, at that time existing, structuralist approach derived from the ideas from Bourbaki group about mathematics as a discipline, and which in the US led to the so-called New Math movement. This is a method of teaching mathematics which focuses on abstract concepts such as set theory, functions and bases other than ten.

In its search for an alternative for the mechanistic approach, the Netherlands pursued neither the empiricist nor the structuralistic approach. In particular through Freudenthal's opposition to the structuralistic 'New Math' movement that washed over the Netherlands, there was an opportunity to go in another direction and end up at the RME approach.

To understand this way of teaching mathematics and recognise how it differs from other approaches to mathematics education which were manifest in the early days of RME, Treffers' (1978, 1987) distinction in horizontal and vertical mathematisation is very helpful. Horizontal mathematisation involves going from the world of real-life into the world of mathematics. This means that mathematical tools are used to organise and model, and solve problems situated in a real-life situations. Vertical mathematisation means moving within the world of mathematics. It refers to the process of reorganisation within the mathematical system resulting in shortcuts by making use of connections between concepts and strategies.

Treffers' (1987) scheme included in Table 1 shows how the four different approaches to mathematics education diverge.

Table 1

Types of Mathematisation in Mathematics Education (from Treffers, 1987, p. 251)

Approach to mathematics education	Mathematisation	
	Horizontal	Vertical
Realistic	+	+
Structuralistic	-	+
Empiricist	+	-
Mechanistic	-	-

Connected to this 'two-way mathematisation', RME can also be explained by a number of principles (Van den Heuvel-Panhuizen, 2001)¹:

- The *activity principle* refers to the interpretation of mathematics as a human activity (Freudenthal, 1971, 1973). In RME, students are treated as active participants in the learning process. Transferring ready-made mathematics directly to students is an 'anti-didactic inversion' (Freudenthal, 1973) which does not work.

¹ This list of principles is an adapted version of the five tenets of the RME instruction theory distinguished by Treffers (1987): "phenomenological exploration by means of contexts", "bridging by vertical instruments", "pupils' own constructions and productions", "interactive instruction" and "intertwining of learning strands".

- The *reality principle* emphasises that RME is aimed at having students be capable of applying mathematics. However, this application of mathematical knowledge is not only considered as something that is situated at the end of a learning process, but also at the beginning. Rather than commencing with certain abstractions or definitions to be applied later, one must start with rich contexts that require mathematical organisation or, in other words, contexts that can be mathematised (Freudenthal, 1979, 1968).
- The *level principle* underlines that learning mathematics means that students pass various levels of understanding: from the ability to invent informal context-related solutions, to the creation of various levels of shortcuts and schematisations, to the acquisition of insight into how concepts and strategies are related. Models serve as an important device for bridging the gap between informal, context-related mathematics and the more formal mathematics. In order to fulfil this bridging function, models have to shift from a ‘model of’ a particular situation to a ‘model for’ all kinds of other, but equivalent, situations (Streefland, 1985, 1993, 1996; see also Van den Heuvel-Panhuizen, 2003). For teaching calculations the level principle is reflected in the didactical method of progressive schematisation (Treffers, 1982a, 1982b). I will return to this point later.
- The *intertwinement principle* means that mathematical domains such as number, geometry, measurement, and data handling are not considered as isolated curriculum chapters but as heavily integrated. Students are offered rich problems in which they can use various mathematical tools and knowledge. This principle also applies to topics within domains. For example, within the domain of number this means that number sense, mental arithmetic, estimation and algorithms are taught in close connection to each other.
- The *interactivity principle* of RME signifies that the learning of mathematics is not only a personal activity but also a social activity. Therefore, RME is in favour of ‘whole-class teaching’. Education should offer students opportunities to share their strategies and inventions with other students. In this way they can get ideas for improving their strategies. Moreover, reflection is evoked, which enables them to reach a higher level of understanding.
- The *guidance principle* means that students are provided with a ‘guided’ opportunity to ‘re-invent’ mathematics (Freudenthal, 1991). This implies that, in RME, teachers should have a pro-active role in students’ learning and that educational programs should contain scenarios which have the potential to work as a lever to reach shifts in students’ understanding. To realise this, the teaching and the programmes should be based on a coherent long-term teaching-learning trajectory.

Although it certainly is not the case that nowadays every class is taught according to the principles of RME or that every textbook which advertises itself as RME is designed according to the RME principles, it is clearly true that since the beginning of the development of RME, the nature of textbook series has changed dramatically. In the 1980s, the market share of mechanistic textbooks was 95% and that of RME ones 5%. In 1987 the market share of RME textbooks was around 15%. In 1992 this had increased to almost 40%, and 75% in 1997. In 2004 RME textbooks were in use in 100% of cases (sources: Treffers, 1991a; Janssen et al., 2005; Janssen et al., 1999).

In the following I will illustrate this development by zooming in on long division.

Reform Developments in the 1980s

Two Examples from the Classroom

In 1983 Fred Goffree had the idea to study how a mathematics lesson looks on an ordinary day in November at an ordinary primary school in the Netherlands. The day in question was Tuesday, November 15, 1983. Goffree asked me to join him in this study, which led to the publication 'Zo rekent Nederland' [This is how the Netherlands calculate] (Van den Heuvel-Panhuizen & Goffree, 1986).

Every teacher could be part of the study and was free to describe his or her own mathematics teaching that day. No one checked whether what had been written down did really take place. At first sight, from a sense of reliability, this does not appear to be a scientific approach. Of course, teachers could present their teaching in a better light than what really took place in their classroom, but what they told about that mathematics lesson, does in any case reflect their opinion about it. And this didactical baggage was in fact what we were looking for in this study, rather than what happened in practice. It is more than likely that the teachers' opinions about mathematics teaching and their didactical knowledge determined to a high degree the lesson they had decided on for this special day.

We received 161 lesson descriptions, containing a plethora of subjects, including long division. As it happens that day, one Grade 3 class was taught how to do long division (see Van den Heuvel-Panhuizen & Goffree, 1986, 66-67). The starting point was: dividing twelve into fours. As it was explained by the mechanistic textbook series *Naar Aanleg en Tempo* (Student book 6, Task 32, without year, published by Thieme-Zutphen) you can write this down as 'division' or as a 'division in the form' (see Figure 1).

	<p>division</p> $12 : 4 = 3$	<p>division in the form</p> $4 \begin{array}{r} \big/ \\ 12 \\ \big \end{array} 3$ $\underline{12}$ 0
---	-------------------------------------	---

Figure 1. Explanation of long division in mechanistic textbook

The teacher gave the following explanation:

Imagine that these two slanting bars are tails. 4 out of 12 goes 3 times. You write down the 3. Then you take the final 3 x 4 is 12. Subtracted 0. Remember: subtract.

Then the teacher dictated a few problems to practice: $20 \div 5$ and $30 \div 5$. These were treated on the blackboard afterwards.

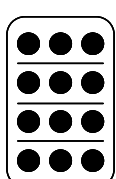
Who had them right? Do you see how it works? A few more problems like that. The last 0 has to be under the right number. Do you remember how we call this division? Long division. In the book we call that 'in the form'.

And indeed, in this mechanistic approach to learning long division the lay out was all that mattered, learning outward details such as 'what is it called', 'how does it look', 'what you must do', and 'what you must say'. The teacher writes down a division problem and the students must turn it into long division. Characteristic of the mechanistic method is that

it starts with small numbers and that the larger ones follow along. This structure is called ‘progressive complication’ (Treffers, 1982a, 1982b). Another characteristic of this method is that a start is made with calculations immediately.

Continuing with the classroom vignette from 1983, we see that nearly all students were able to do the long division problems they were given. The teacher should be pleased. Or maybe not?

The problem with using for instance $12 \div 4 = 3$ to learn long division is that it is not very long, which is why the teacher was reduced to referring to the ‘tails’. The question is whether this will be any help to students when they are stuck: Long division? Oh, yeah, with the two tails. And what goes between them?

Happily there was also a lesson description (see Van den Heuvel-Panhuizen & Goffree, 1986, p. 68-69) that showed students learning long division with more understanding. In a Grade 5 class the students were given a row of long division problems that they had to solve in two ways: the whole-number based method that was used as an introduction in Grade 4 and the ‘regular’ digit-based method (see Figure 2).

“long division as it was
taught last year in grade 4”

$$5459 : 53 =$$

$$\begin{array}{r} 5459 \\ - 5300 \\ \hline 159 \\ - 159 \\ \hline 0 \end{array} \quad \begin{array}{r} 100 \\ 3 \\ \hline 103 \end{array}$$

“long division as it is usually
taught in other schools”

$$53 \overline{) 5459} \quad 103$$

$$\begin{array}{r} 53 \\ \hline 159 \\ \hline 159 \\ \hline 0 \end{array}$$

Figure 2. Combining whole-number-based division and digit-based division

In this school, which used a programme inspired by Wiskobas, the students had not been taught the shortest digit-based long division algorithm in Grade 4 immediately, but they started with a whole-number-based procedure of repeated subtraction. This clear and to the students natural approach of division, which starts with relatively large numbers immediately, gradually shortens the procedure until one arrives at the familiar standard algorithm; this is ‘progressive schematisation’ rather than ‘progressive complication’ (Treffers, 1982a; 1982b).

Although the whole-number-based long division can be called an icon of RME, it certainly was not invented within RME. Before this style of long division was included in the RME textbook series, it could already be found for instance in Dutch textbook series of the early 1960s that, like RME, had a broad approach to calculation, and did not limit themselves to algorithmic digit-based calculation. Outside the Netherlands, the history of this whole-number-based calculation and notation method goes back even further. At the beginning of the twentieth century this method of calculation with whole numbers rather than digits could already be found with the German mathematics didactician Kühnel (1925). In the NCTM Yearbook on developing computational skills, Hazekamp (1978) even refers to an example of this approach in a mathematics book from 1729.

Nowadays as well, whole-number-based written calculation, which is so under attack in the Netherlands, is not a procedure that is typical for RME. This stepping stone towards shortened long division is used in many places worldwide, such as in England (see <http://nationalstrategies.standards.dcsf.gov.uk/node/19829>; Thompson, 1999, 2008; Anghileri, 2001), the United States (Kilpatrick, Swafford, & Findell, 2001, p. 211-212) and Hong Kong (Leung, Wong, & Pang, 2006).

Unfortunately not everybody showed as much didactical insight in 1983 (see Van den Heuvel-Panhuizen & Goffree, 1986) as the teacher in Grade 5.

A director of a lower vocational school mentioned that his daughter, who was at a teacher education college, had taught him the new method of long division. To the question of whether this method was used in his school as well, he answered: “No, because you cannot use tricks with it. Students are immediately unmasked with this method” (p. 69).

This seems upside-down: do not try to let students understand long division, but limit yourself to teaching the outward form. The problem with this kind of blind calculation procedure is that its success is limited. Despite the large amount of teaching time spent on calculation — often more than fifty hours of teaching time for long division (Treffers, De Moor, & Feijs, 1989; Wijnstra, 1988) — results were poor. One in three children had problems with long division, and over half stumbled on harder division problems with zeros in the result (Treffers & De Jong, 1984). American studies at the time also showed the huge problems students had with long division. For instance, Bright (1978) showed that in the National Longitudinal Study of Mathematical Abilities (NLSMA), that was performed by the School Mathematics Study Club at the end of the sixties, only 44% of ten-year old students gave a correct answer to a problem like $9792 \div 32$ (result 306) and that the percentage for $482 \div 24$ (result 20 rest 2) of correct answers was 61. In addition to difficulties with making bare number problems, students also had trouble with the aspect of applicability. This emerged from, for example, English studies, with Brown (1981) finding that students did not know which operations should be used in context problems.

Inception of a National Reform Plan

Although Wiskobas had already been active in the 1970s, publishing curriculum documents and background studies with examples of reformed mathematics education, at the end of the seventies and the start of the eighties mathematics education differed widely in both content and didactic approach. For that reason the Dutch Society for the Development of Mathematics Education (NVORWO) decided to commission the start of a national plan for mathematics education in primary school. Its goal was

“to achieve a certain homogenisation on content in mathematics education, and to create favourable conditions for education, training, support, development and research, and the relationship between them” (Treffers & De Moor, 1984, p. 5).

A concept version of this plan was published in 1984 as ‘10 voor de basisvorming rekenen/wiskunde’ (Treffers & De Moor, 1984) and presented to a large group of experts.

For algorithmic digit-based calculation it was proposed to:

- have it in a less central position in favour of mental calculation, estimation and number sense
- aim more at applicability, and
- not immediately teach students the most shortened forms of standard algorithms (working with digits), but to start with a notation using whole numbers; for long division this meant: starting with repeated subtraction.

Of the almost 300 respondents (among them around 70 teacher education teachers, 70 teacher counsellors and 70 primary school teachers) who were consulted about this concept plan for algorithmic calculation, 95% agreed with this proposal (Cadot & Vroegindewej, 1986). Although it was also clear from the commentary that not all respondents were equally sanguine about the time gain that would result from this new approach, and concerns about implementation were expressed, in general there was an almost unanimous agreement with the reform of mathematics education as proposed in the concept plan. This was the case not just for this group of consulted experts. Another study (Ahlers, 1987) also showed that there was a desire to put algorithmic digit-based calculation on a new footing. Of teachers in grade 6 only 32% felt that algorithmic calculation was 'very important'. This percentage was slightly higher for parents, 43% chose this qualification for algorithmic calculation, while 56% of parents rated mental calculation as 'very important' and 62% indicated that they felt mathematics applied in daily life was 'very important'.

So, at the end of the 1980s the Netherlands was ready for a new direction for algorithmic digit-based calculation. It should be said immediately though that this was not the direction that had been decided upon in England after the publication of the Cockcroft Report in 1982 (DES, 1982). Although there was the intention to spend more time on solving problems with examples from daily life, unlike England the Netherlands was explicitly not going so far as to for example abolish long division (see Treffers & De Moor, 1990). All that NVORWO wanted was to get rid of the one-sided focus on algorithmic digit-based calculation, and at the same time it chose to have an insightful introduction to the shortest version of the algorithms. Alongside, a greater role was assigned to mental calculation, estimation and number sense. There were consequences to this new approach.

Consequences for Mathematics Achievements

The studies of the National Assessment of Educational Achievement (PPON) used to assess mathematics achievements of primary students in the Netherlands once every several years, clearly reflected the results of the new approach. As is shown in Figure 3, comparing the results in the years 1987, 1992, 1997 and 2004 of students in grade 6 (end primary school) (Janssen et al., 2005) revealed that the performance in the area of number sense and estimation have improved greatly. In comparison to the first assessment in 1987 these two topics show an increase of about 25 percentage points. In addition, mental addition and subtraction have also improved by about 10 percentage points. Aside from calculating with percentages, which has also improved by about 10 percentage points, achievements on 'relations, fractions and percentages' and 'measurement and geometry' (not included in Figure 3) have hardly changed between 1987 and 2004. However, Figure 3 also shows that achievements in written calculation have gone down substantially in the period 1987-2004. This is especially the case for multiplication and division. These scores have gone down by about 1.25 standard deviation. This means that the percentage of correct answers has gone down by about 30 percentage points. For composed written calculation the total reduction is 20 percentage points and for written calculation addition and subtraction about 15 percentage points.

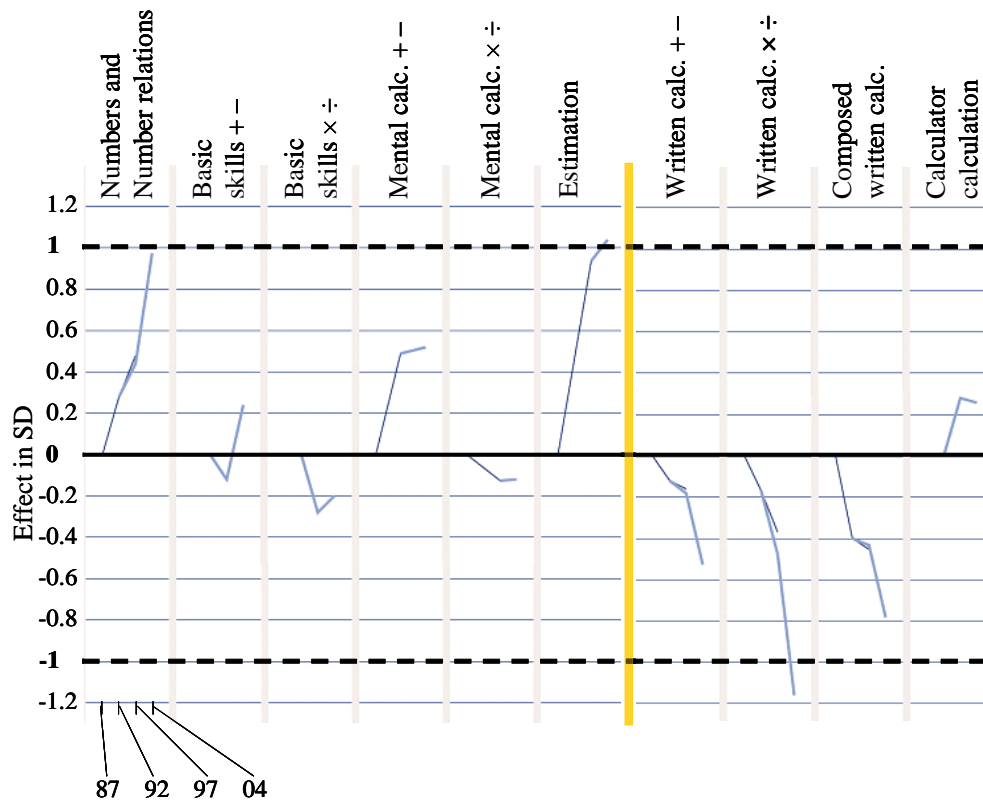

Figure 3. Effect sizes in changes in achievement in the domain of number at end primary school from 1987 to 2004 (based on Janssen et al., 2005)

So, according to PPON, written calculation has clearly become less over time. While this is the case, we might also say that what we see of the achievements in the domain of number in the Netherlands in 2004, does to some degree match the performance profile opted for twenty years ago. The reform that was proposed at the time has indeed taken place, and from within education without government intervention, something that is at the very least remarkable. Just as remarkable is however that the change in students' performance, especially in the public debate, has been taken as deterioration in mathematics achievements. Apparently, written calculation is identified more with mathematics than number sense, estimation, mental calculation and applications such as calculation with percentages.

A Critical Evaluation of the Assessment of Written Division

Although the lower achievement in written calculation can be taken partly as a result of the broadly-supported decision to spend less time on this topic, the difference in achievement is in fact higher than expected and intended. Before we place the blame for this difference on RME, a critical analysis of how these achievement scores have been established is called for.

Three points can be identified that give reason to question the assessment of written division (see Van den Heuvel-Panhuizen, Robitzsch, Köller & Treffers, 2009): (a) the problems used, (b) the time of measurement, and (c) the test instruction that was given.

The Problems Used

A total of nineteen items was used for assessing the topic ‘Operations: multiplication and division’ in 1997 and 2004. Of these items, only four were included in both assessments. These items were used to link the two measuring points. Unfortunately, three of these anchor items, two of which are shown in Figure 4, are more suited — especially with the improved number sense in 2004 — to mental than to written calculation.

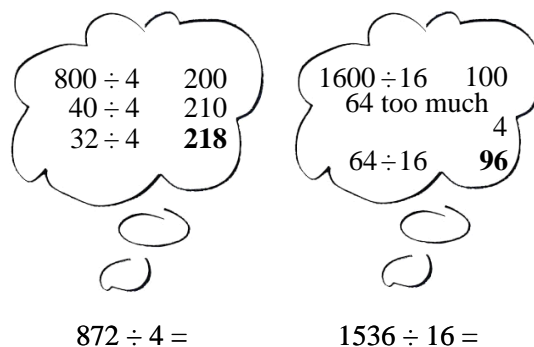

Figure 4. Two of the four anchor items for written division

Of the nineteen items, sixteen were context problem, with four focusing on the ability to interpret the remainder, which is not the same as being able to perform the division procedure.

Moreover, only one of the hardest items with whole numbers, those with a zero in the result (for example $64800 \div 16$; see Figure 5), was included in the nineteen test items, although precisely for this type of problem the RME approach, applying a whole-number-based division, is less sensitive to errors than the traditional algorithm. In the latter approach you can take 16 out of 8 zero times, and then you must remember to put down a zero in the result. The same happens again at the end of the division procedure.

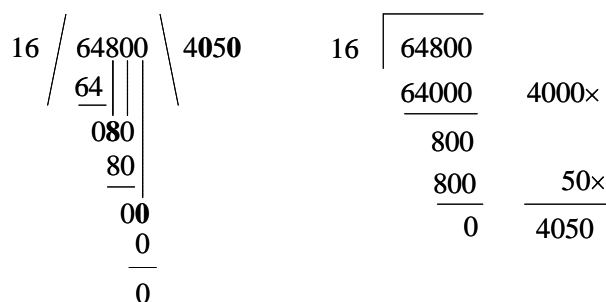

Figure 5. A division problem with a zero in the result

The Time at Which the Assessment Took Place

Because, in 2004, Cito did a reference study for the Cito Student Monitoring System, we do not only know how the students scored on the test items at the end of Grade 6 as collected in the PPON study, but we also know their scores halfway this grade (Janssen et al., 2005). It turns out that the decrease that has been found between the end of Grade 6 in 1997 and the end of grade 6 in 2004 is complicated. The downward movement in achievement for written calculation turns out to have occurred mostly in the second half of

Grade 6 (see Figure 6). There seems to be a turning point mid grade 6, with scores decreasing after the students have done the Cito End of Primary Test which is administered in the middle of grade 6.

Regrettably there are no data on the middle of grade 6 in 1997, but we do know the scores of the middle and the end of Grade 5 from the Cito Student Monitoring System reference study in 2004. These show an increase for the second half of Grade 5.

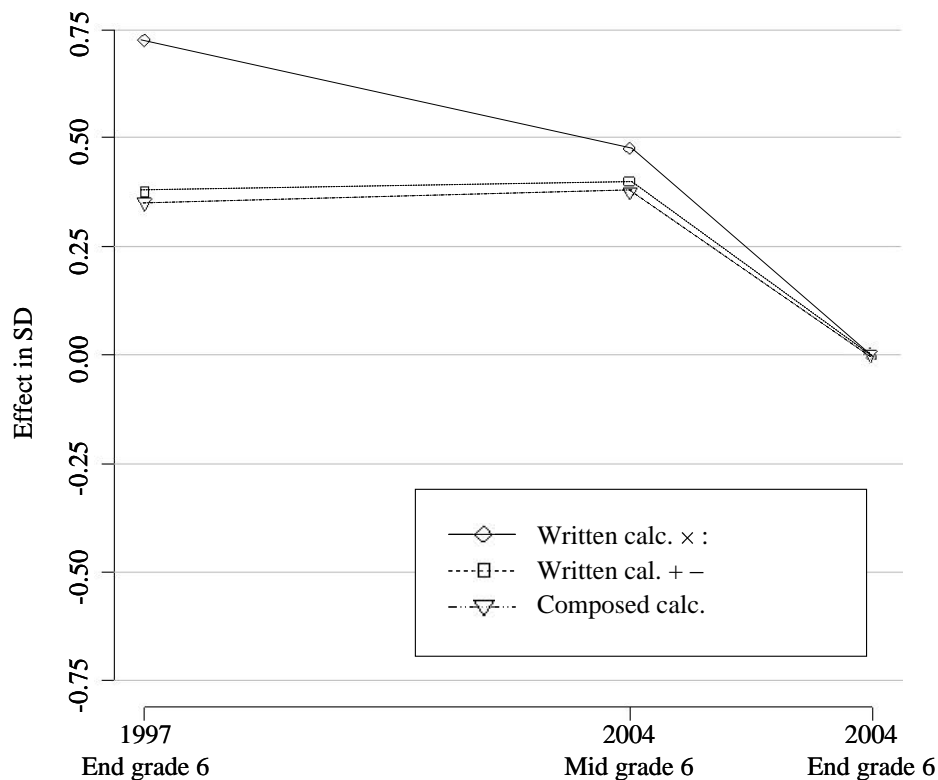

Figure 6. Achievements in written calculation end grade 6 compared to mid grade 6

Of course the same pattern with the notable decrease in Grade 6 may also have occurred in 1997. However, it is also possible that the trend to spend less time on mathematics instruction after administering the Cito End of Primary Test has become stronger over time. Add to that the fact that after primary school, students mostly switch to using a calculator for doing calculations and it is hardly surprising that written calculation skills in secondary school are not good.

The Test Instructions

The third point allowing questions to be raised about the assessment of written calculation and the conclusions based on it, concerns the given test instructions.

To study the use of strategy by students on the tested items, 140 students who took part in the written 2004 PPON test were also interviewed individually (see Van Putten, 2005; Hickendorff, Heiser, Van Putten, & Verhelst, 2009). Not only did this additional research allow study of the effect of the RME and traditional solution strategies, it also revealed, as in shown in Table 2, that there was a significant difference in correct scores between both testing formats. In 2004, the correct scores for the released items $736 \div 32$ en $7849 \div 12$ were about 30 percentage points higher for individual testing than in the class-administered

written test. Compared to items from other topics that were tested in two ways, this is a large difference.

Another remarkable difference in 2004 is, that for the individual test format there was not a single student without written notations of the calculations. For the class-administered written test this was for the two items, respectively 30% and 35%.

Table 2
Percentage Strategy Use and Answers Correct in Two Test Formats

Item 9	1997		2004
736÷32 (in context)			
Strategy	Paper-and-pencil	Paper-and-pencil	Individual interview
Traditional Algorithm	42	19	29
Realistic ^a	24	33	71
No Written Working	22	30	0
Other	12	19	3
Answer correct	71	52	84
Item 10	1997		2004
7849÷12 (in context)			
Strategy	Paper-and-pencil	Paper-and-pencil	Individual interview
Traditional Algorithm	41	19	27
Realistic ^a	22	25	68
No Written Working	17	35	0
Other	20	21	5
Answer correct	44	29	60

^a As defined by Hickendorff et al. (2009) including chunking and partitioning

Apparently, the instruction for the written test was not strong enough in comparison to the individual one to let the students do their calculations on paper in all cases. However, to establish whether Dutch students are capable of written calculation, and to make statements about changes over time in this ability, one should explicitly ask students to do their calculations on paper. Testing whether students can solve mathematical problems is something different than testing whether students can perform certain calculation procedures.

The three questionable points mentioned here (the items used, the time of assessment and the given test instructions) show that research into changes in achievement is not easy, certainly not if there is educational reform taking place at the same time. A problem like 736÷32 that would be tackled by using a division procedure on paper in 1997, is more likely to evoke mental calculation in 2004 — as a result of the greater emphasis on number sense: 736÷32, ... 20 already gives you 640, add 2 times 32, 64, that gets you to 704 and add one more 32, that gives you; together 23 times 32. However, if this mental calculation strategy turns out to be an overestimation of a student's skills, things will go wrong in the class-administered written test, while the individual test shows that 84% of students will get it right if they use written calculation.

What TIMSS Says About the Mathematics Achievements of Dutch students

The results of the Trends in International Mathematics and Science Study (TIMSS) 2007 (Mullis et al., 2008) provide the most recent facts on the mathematics achievements of Dutch primary school students. Because Dutch Grade 4 students participated in TIMSS in 1995, as well as in 2003 and 2007, the TIMSS scores show the development of mathematics achievements in recent years within an international context, like the PPO scores did on a national level. The most important conclusion of TIMSS is that there was a significant decrease in the whole period between 1995 and 2007, but that there was no significant change at the latter end, between 2003 and 2007. A problem with the first part of the conclusion is that in 1995 the Netherlands did not comply with the requirements for the sampling procedure. However, the TIMSS researchers did not see this as an obstacle for including the 1995 data in their trend analyses.

Despite the supposed decrease, Dutch fourth graders scored reasonably well for TIMSS in 2007. The Netherlands are in eighth place for the domain of number — which is what the current discussion is about — below four Asiatic participants (Singapore, Hong Kong, Taiwan, and Japan) and three participants from Eastern Europe (Kazakhstan, Russian Federation, and Latvia) (Mullis et al., 2008). The Netherlands have the highest score of the nine Western European countries that took part. Additionally, the Netherlands finished above the other Western countries that took part, including the United States, Australia and New Zealand. It would be justified to call the Netherlands ‘Best of the West’. The media, however, see things differently. For example, a popular magazine for parents *j/m Voor Ouders* ‘translated’ the Dutch results as: “Internationally, our children have poor results in arithmetic.”

The discrepancy between the achieved results and their perception becomes even larger if the opportunity to learn is taken into account. For example, in Singapore the test items used for the domain of number are covered for 91% by the taught curriculum. In the Netherlands, that is the case for only 64% of the items. Compared to the countries with a higher score, we have the lowest coverage percentage (although the coverage percentage for two countries is unknown) (Mullis et al., 2008). For instance, calculations with fractions and decimal numbers are not taught in Grade 4 in the Netherlands, while these topics were included in the TIMSS test.

Another point is the low spread in the mathematics scores of the Dutch students. The best Grade 4 students in Singapore may be better than our best Grade 4 students, but our weakest students are at around the same level as the weakest students in Singapore (Mullis et al., 2008). This low spread was not unique to TIMSS 2007, but emerged from earlier TIMSS and PISA studies as well. Even though this is a remarkable result that says something essential about our education system, it is given relatively little attention in the media and reports. Clearly, we do not want to establish ourselves as ‘equal opportunities champion’ (see Van Streun, 2009), while this is in a sense what we are, and while this also matches our thoughts of the mission we have with mathematics education.

Other data from TIMSS 2007 received equally little attention:

- diverging from most other countries, girls in the Netherlands do not do as well as boys
- the Netherlands are at the bottom of the league table for teacher participation in professional development
- the Netherlands has the highest percentage of time spent on working on problems individually without a teacher’s guidance.

The type of classroom organisation that emerges from this last point, certainly does not match the RME model of interactive whole-class teaching. The newspapers and opponents of

RME do not mention this, but it is a point of concern to us. The lack of whole-class teaching may well match the limited ability of Dutch students to write down their calculations systematically, as this is something that is hard to teach a whole class through individual instruction. It is not clear why Dutch teachers make so little use of whole-class instruction. It may be an effect of the Inspection of Education ‘teaching-to-size’ policy that they pursued since the 1990s (see, e.g., Inspectie van het Onderwijs, 1998). What is remarkable here is that England which had the highest increase of all countries in 2007, had decided in favour of ‘whole-class teaching’ in the 1990s — within the framework of the National Numeracy Strategy (see Askew, 2002), which was partly inspired by the ideas of RME.

What is Better, Mechanistic or Realistic Mathematics Education?

RME Under Attack

Since 2007 a deluge of reports has flooded the Netherlands, all of them emphasising a downward trend in our mathematics achievements and observing that we do badly in comparison with other countries. There were only two sources for the findings in these reports in primary education: the PPO and TIMSS studies. While neither study is above criticism, as I have shown in the previous section, the reports that reference these studies do not show the necessary critical attitude. Even worse is the cumulative effect in reporting bad results. PPO and TIMSS show that achievements decrease. This result is then included in another report, with the effect that subsequent reports will then refer back to three, rather than two, sources showing that mathematics achievements of Dutch primary school students are falling behind. The next report mentions four sources, and so on.

A recurring element in the media is that the opponents of RME do know why achievements decreased so much. It is the fault of RME. Therefore they argue that RME should be dropped and we should return to the mechanistic teaching of before the reform; this would mean going back about forty years. In fact two new mechanistic textbook series are currently in production, while some RME textbooks series fear loss of market share and no longer call themselves RME or state explicitly that they have a balanced approach and combine RME characteristics and mechanistic characteristics.

An Arbitrator to Decide the Argument

To stop the debate, the Ministry of Education asked the highest academic body in the Netherlands, the Royal Netherlands Academy of Arts and Sciences (KNAW) to find out which approach to teaching mathematics is better: the RME approach or the traditional mechanistic manner of teaching. This latter approach includes those methods in which students are taught one standard algorithm per operation, teachers provide direct instruction and students learn by solving bare number problems.

The KNAW Commission was a mixture of both proponents and opponents of RME. To find an answer to the question of which teaching method is the best, the Commission did not carry out a study by itself, but instead looked at the empirical research conducted in the Netherlands in the past twenty years. In addition, a brief and general survey was done of studies conducted abroad. The conclusion of the Commission (KNAW, 2009) was that the

empirical material is not unequivocal and does not permit any general, scientifically-grounded statements about the relationship between mathematics instructional approaches and mathematical proficiency. The research is limited and does not provide convincing empirical evidence for the claims made by either side of the debate about the effectiveness of traditional methods versus RME. (p. 14)

This ‘not decided’ conclusion by the KNAW Commission fits well into the Dutch policy that is known as the ‘polder model’², which refers to the consensus policy in economics based on the tri-partite cooperation between employers’ organisations, labour unions, and the government, aimed at defusing labour conflicts and avoiding strikes. It is a good result for the Ministry of Education. The worst is over. Both tabloids and serious newspapers are quiet again. But, really, this conclusion is not satisfactory. In fact our reform is back where we started. This is how a reform can end. Forty years of work for nothing. RME, based on the work of many researchers, developers, mathematics educators and teachers, is being compared with the opinion of a small group of opponents who have no development and research work to support them, and who only have some slogans going back to the past and at best a lean behaviouristic basis. It is difficult to name their approach a didactic of mathematics education. Asking which didactic is better, is to compare two unequal quantities with the result that the opponents of RME, despite of their low behaviour in the media, have been promoted to respected researchers of mathematics education.

Insufficient Evidence?

Measured by the current hype of *evidence-based educational* policy and decision making there is insufficient evidence for both the mechanistic approach and RME. On the one hand, there is no evidence available in the Netherlands at all for the first approach, simply because there has been no research, except for a couple, in some ways flawed studies into the effect on weak students of offering one single, fixed strategy. On the other hand, RME does have a long history of research — and in addition is supported by the huge body of knowledge about reformed approaches to mathematics education gathered by the international research community — but this research has not yet delivered the level of evidence that is required nowadays. The development and implementation of RME took place at a time when the emphasis was not yet on experiments with pretest-posttest designs with randomised control and experimental groups. RME was more interested in design experiments. First we had to find out what the reformed education should look like, how we could evoke certain learning processes in children and how we could raise the children to a higher level of understanding. The ideas for didactical approaches that emerged from this were often convincing enough in themselves. Everybody could test their didactical value every day in their own educational practice. These experiences were enough to implement RME in mathematics classrooms, teacher education and in-service courses, educational counselling activities and textbooks.

Examples of convincing didactical innovations of RME. Look for example at whole-number-based written division; a calculation procedure that, by the way, was not even a Dutch invention (see Hazekamp, 1978) and that was already in use in the Netherlands before the time of RME (see Van Gelder, 1959). The only research that was done to include this introduction to digit-based algorithmic calculation in RME was the study done by Rengerink (1983; see also Treffers & De Jong, 1984). This was a small-scale study with an experimental class of 21 students, an experimental programme of about 25 teaching hours, and a control class of 23 students following the regular programme.

Other examples of RME innovations that were introduced worldwide without randomised controlled trials are the empty number line and the corresponding stringing strategy (Treffers, 1991b; Van den Heuvel-Panhuizen, 2008a), the arithmetic rack with the two lines of beads in a 5-5 structure (Treffers, 1991b), the ratio table (Treffers, 1993;

² Although it must be said that some people wonder whether this is actually typically Dutch (De Bruijn, 2010).

Middleton & Van den Heuvel-Panhuizen, 1995), and the percentage bar (Van den Heuvel-Panhuizen, 2003).

Convincing large-scale and standardised research. If the success of these didactical innovations and the research that contributed to the development of them did not count in the eyes of the members of the KNAW Commission, and the worldwide support and appreciation that they received were also not important, then the KNAW Commission should at the least have taken a closer look at the few studies that were large-scale and standardised. These studies did in fact show that the RME textbook series that concretised RME — even if not all RME textbook series did so perfectly — did lead to higher achievement scores in mathematics in comparison with traditional, mechanistic textbook series.

For instance, the PPON analyses by Cito over the period 1992-2004 showed that, despite the strong decrease in written calculation, the newer mathematics textbooks as a whole contributed in a small, but positive way to the mathematics achievements of the students (Janssen et al., 2005). This argues in favour of the RME approach.

In addition, Cito did a comparison at textbook level using the achievement scores collected in 1987, 1992, and 1997 (Janssen et al., 1999). This was in fact the last time that it was possible to make a large-scale empirical comparison between RME and the mechanistic approach, since a part of the textbook market was still controlled by mechanistic textbooks. In 1997, RME textbooks had a market share of 75% with mechanistic textbooks at around 10%. The results of the comparison indicated that the RME textbooks were more often part of the best textbook series (with students in grade 6 obtaining the highest achievements in mathematics) and that the mechanistic methods were more often among the weakest textbook series (with students in Grade 6 obtaining the lowest achievements in mathematics). One illustrative point was that the textbook series *Wereld in Getallen (WIG)* — the oldest RME textbook still in use, and additionally seen as a good representative of RME — achieved the top place on 19 of the 24 mathematics topics that students were tested on, while the mechanistic series *Naar Zelfstandig Rekenen (NZR)* never achieved a top place in the category best textbook series. This method had the highest score in the category weakest textbook series on 13 topics.

Based on the data published by Cito (Janssen et al., 1999) another comparison can be made that gives an even better answer to the question of what way of teaching mathematics is better: the RME approach or the mechanistic manner of teaching. For this we can take the two RME textbooks that were included in the study then and which are still in use, virtually unchanged. These textbooks, which to a large degree determine the quality of current mathematics education with a combined market share of 70%, are the textbooks *Wereld in Getallen (WIG)* and *Pluspunt (PP)*. If we consider the achievement scores of grade 6 students with these two RME textbooks obtained for PPON in 1987, 1992, and 1997 against the scores of students who used the mechanistic textbook *Naar Zelfstandig Rekenen (NZR)*, then it is clear to see that the RME textbooks led to better results than the mechanistic textbook. Figure 7 shows that the RME textbooks *WIG* and *PP* outperform the mechanistic textbook *NZR* in nearly all topics within the domain of number.

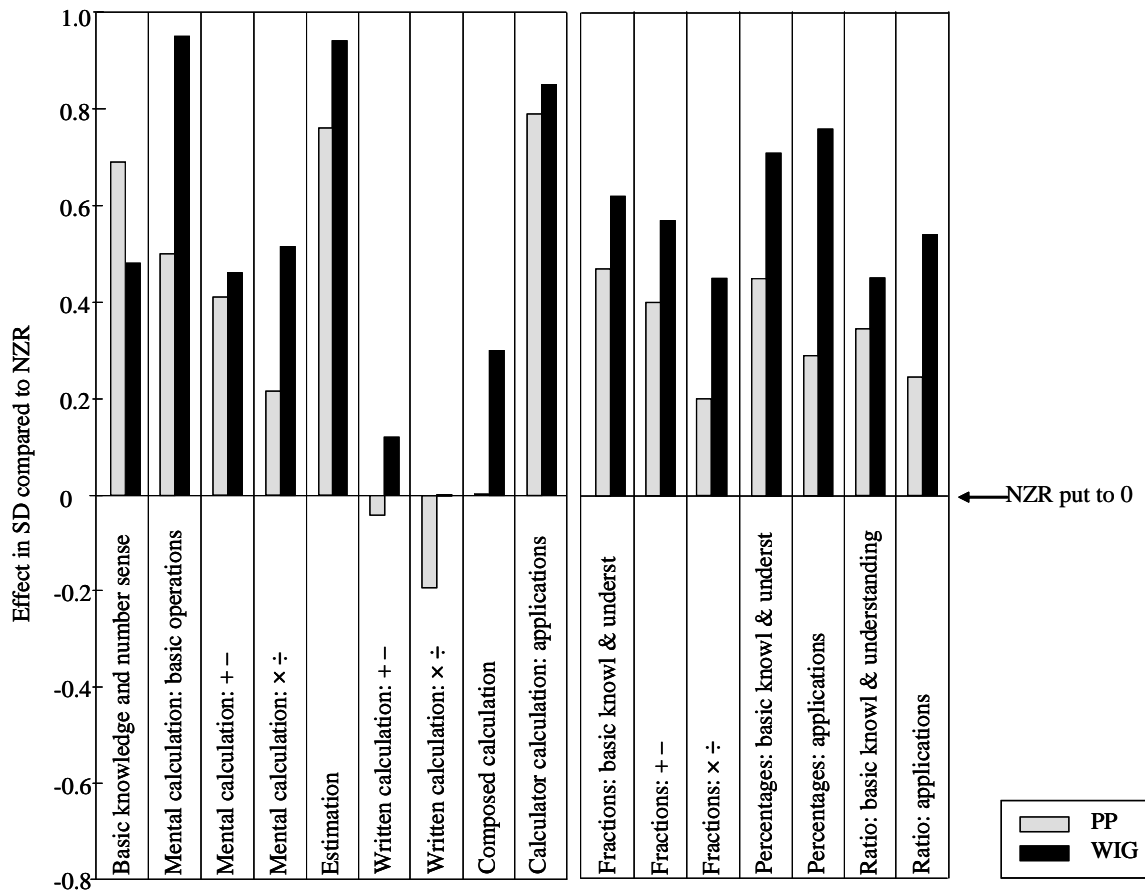

Figure 7. Effect sizes for the *PP* and *WIG* scores in comparison to the *NZR* scores

On basic knowledge and number sense, estimation and insightful use of the calculator *PP* scored 10 to 15 percentage points higher than *NZR*. On the other number topics the scores of *PP* are 5 to 10 percentage points higher. Only for written calculation is the score for *PP* slightly lower than for *NZR*. Two of the three topics for written calculation are at around the same level for *WIG* and *NZR*, though not the hardest topic, composed calculation. Here, *WIG* has a significantly positive textbook effect against *NZR* — and to consider that *NZR* strongly emphasises written calculation.

It is, however, not just written calculation where *WIG* does relatively well. The quality dominance of *WIG* against *NZR* shows especially in the fact that *WIG* also has significantly better scores than *NZR* on the other 16 number topics. The differences lie on the whole between 10 and 15 percentage points. *WIG* does especially well for basic knowledge and number sense, estimation, insightful use of the calculator and calculations with percentages.

Unfortunately, the KNAW Commission did not look at these PPON data in detail, but lumped together all RME textbooks and all traditional textbooks. This is especially detrimental for the traditional textbooks, of which there are two types: textbooks which only focus on digit-based algorithms and textbooks which have a broad interpretation of calculation. The first type does not include whole-number-based calculation (the insightful introduction to the algorithms), or (smart) mental calculation and estimation, while the textbooks of the second type do take these into account, and as a result are consistent with the RME textbooks with respect to the number domain. The students who worked with the

traditional textbooks with a broad interpretation of calculation outperformed the students who were taught with the traditional textbooks that only focused on the algorithms (Treffers & Van den Heuvel-Panhuizen, 2010).

One can only guess at why the KNAW Commission did not take an in-depth look at the PPON data. At the same time it also remains unclear why this commission did not refer to the criticism of the assessment of written calculation that was mentioned earlier.

Fear of Monoculture

The most important question is still why the KNAW lent their name to comparing a serious reform movement which has a large national and international reputation with the opinion of a small group of people who think that we should return to the education of forty years ago. One may also question how the KNAW rates our discipline, the didactics of mathematics education. The distinguished university professor of mathematical physics who is the current chairman of the KNAW wonders in the foreword to the report (KNAW, 2009) “what [...] a scholarly gathering such as the Royal Netherlands Academy of Arts and Sciences has to do with the didactics of primary mathematics” (p. 5).

Something else that emerges from the foreword of the KNAW report (2009), is that in the eyes of the KNAW the battle between RME and mechanistic education could only end in a draw. Even the science of biology was quoted to justify the result, by warning that monocultures (read RME) are an impoverishment of an ecosystem.³ It may be clear that the natural diversity within applications of RME in textbooks and classroom practice, the width of mathematising both horizontally and vertically and the interconnectedness of conceptual understanding and procedural knowledge that characterise RME, has not been recognised and acknowledged by the KNAW. It is therefore an illusion to think that we will ever be able to convince the opponents of RME.

Lessons to be Learned

Although the attack on educational reform described in this paper takes place in the Netherlands, it seems to me that there are lessons to be learned from it for every other country that engages in reform of mathematics education. Taking a step back to look at the situation in which we — in fact rather unexpectedly⁴ — find ourselves from a more remote perspective, I reach the following conclusions.

This Math War is Based on Framing and Emotions Rather Than on Facts

The first conclusion that can be drawn is that, when a reform that has been going on for close to forty years, now suddenly calls up a counter movement that wants to recreate the traditional mechanistic method of teaching as it existed before the reform, the discussion is not about facts but about emotions, and framing techniques (Lakoff, 2004; Kuitenbrouwer, 2010) are used to convince people. One would not expect that anyone who is focused on knowing more about what mathematics children should learn and how this can best be

³ This rejection of a monoculture is also mentioned by the Education Council of the Netherlands (Onderwijsraad, 2010), who argue in favour of two research and development institutes in the Netherlands: one for RME and one for a traditional approach to mathematics education.

⁴ In 2003 the Education Council of the Netherlands (Onderwijsraad, 2003) still held up the Freudenthal Institute as an example of how development and dissemination of knowledge about education should take place: “This knowledge community has developed to a high level in three decades, and has many participants and contacts, both nationally and internationally” (p. 49).

taught, will seriously consider throwing all the knowledge that has been gathered in the last forty years on the scrapheap. Rationally, this makes no sense. Just imagine that we would do something similar in healthcare. The mathematics education debate is ruled by emotions, in this case the feeling that everything was better in the old days. It is not for nothing that the attack on current mathematics education is coming mainly from a few mathematics professors. Their educational career is the proof that everything was better in times past. All they forget is to wonder for how many children that was the case.

Reform vs. Restore Debates in Education are Universal

The discussion between traditional and reformed education is probably as old as education itself. Nussbaum (2002) provides the example of the comedy ‘Clouds’ from 424 BC, where the great ancient Greek comic playwright Aristophanes writes about the dangers of the new education:

A young man, eager for the new learning, goes to a ‘Think-Academy’ near his home, run by that strange notorious figure Socrates. A debate is staged for him, contrasting the merits of traditional education with those of the new discipline of Socratic argument. The spokesman for the old education is a tough old soldier. He favors a highly disciplined patriotic regimen, with lots of memorization and not much room for questioning. He loves to recall a time that may never have existed – a time when young people obeyed their parents and wanted nothing more than to die for their country [...] (p. 289).

The Style of Attack Reflects the Political Climate in the Netherlands

While the style of criticisms against RME in official reports stays within the social conventions that can be expected from professionals, the newspapers, including the so-called ‘quality papers’ as well as magazines and websites often contain crass and unfounded accusations, in which well-regarded scientists are pilloried. This is all ‘normal’ within the current political climate in the Netherlands. In recent years, for a variety of reasons — including the emergence of high-profile populist politicians — the tone of the public debate has been lowered; especially when the establishment is the target of the debate. The track record that the Freudenthal Institute has built since 1970 means that we are now part of that establishment, with all the consequences of that position.

Open Reform Movement Makes a Reform Vulnerable

In the same way that RME gives students room to work on their own solutions, there is also room for teachers, teacher educators, teacher counsellors, researchers and developers of mathematics education, and last but not least textbook authors, to include their own nuances in the core ideas of RME. There is no state didactics in the Netherlands, and there is no unified RME. Implementation accompanied with ownership for all involved in the reform is an essential value of RME. We succeeded in achieving that, but at the same time it does make us vulnerable. Any mathematics textbook can be qualified as RME by its authors, but at the same time the authors are free to include problems and instructional sequences which maybe go against RME. Such less successful interpretations of RME are grist to the mill of the opponents of RME. Similar situations can occur when enthusiastic teachers put their lessons online, and make the mistake of for instance explaining whole-number-based written calculation using numbers that are much too large, causing children to lose track. Opponents of RME use such examples to disqualify RME and argue in favour of the traditional, mechanistic approach.

These situations are hard to counter without changing the character of the reform. One way of regulating the implementation is performing textbook analyses. In such analyses, concretisations of RME can be examined and commentary and additions can be provided. This approach would allow constant adjustment. We stopped doing these textbook analyses at the end of the eighties. It might have been better if we had continued doing them.

A Reform Requires Professional Development of Teachers

Without a doubt, the driving forces behind the RME reform have been the textbooks. The textbook authors adopted the RME ideas and models of teaching particular topics and later on made use of the RME-based Proeve books (e.g., Treffers et al., 1989; Treffers, & De Moor, 1990) and TAL learning-teaching trajectories (e.g., Van den Heuvel-Panhuizen, 2008b). However, another driving force was missing in the Netherlands. Unlike many other countries, there is no obligatory in-service training for primary school teachers, nor is there a culture of in-service training (Mullis et al., 2008). This means that for the development of their knowledge of RME teachers had to depend on textbooks and on themselves. This left Dutch teachers with a weak foundation, with as a consequence that, although they have adopted RME, they can easily become uncertain about RME when it is criticised. They miss a profound and updated knowledge base. Research has shown that in-service programs for teachers are an essential factor in a change process (see, e.g., Clarke, 1997); especially teachers' beliefs about the teaching and learning of mathematics are considered as critical in determining the pace of curriculum reform in mathematics education (Handal & Herrington, 2003).

The Importance of the Inclusion of Parents

The parents of the children who are now in primary school were in primary school themselves in the 1980s, when RME was by no means ubiquitous. It is not unlikely that the mathematics education they received was given in a mechanistic way, with the consequence that there may be differences with what their children are learning, not just for content, but also for solution strategies, ways of notating and teaching methods. O'Toole and de Abreu (2005) who studied the gap between the past experiences of parents who went to school in England before the introduction of the National Curriculum and current mathematics education practice in their children's school, showed that this gap should be taken seriously. Many parents use their own past experiences as the main resource for understanding their children's current school learning. In addition, the parents' parents also play an important mediating role. This can be painfully observed in the Netherlands, in the plea to reintroduce granddad's mathematics. Unfortunately, this gap between the parents' and grandparents' mathematics education and that of their children has never been a focal point in RME. After seeing in 1987 that the parents agreed to the reform, there have been no further attempts to keep them involved. This is an omission.

Any Reform Will Have to Prove Itself at Some Point

The long history of RME reform made us almost complacent. As was said in the beginning of this paper, we never thought that the development and implementation of RME were finished or that we had found the ultimate answer to the best way for children to learn mathematics. We were never really satisfied and were always looking for further improvements. But we did so in relative peace. After the first twenty years, we no longer really considered that we still had to prove that RME was better than the mechanistic

approach. It seemed so obvious for everybody. In fact, there only was a discussion with remedial educationalists on what mathematics education for special education students should look like. Meanwhile, teachers in special education were hard at work introducing the empty number line and other didactical innovations of RME. In view of these experiences, we considered the confrontation between RME and mechanistic teaching methods as a run race. This was a misconception that we have come to regret. When the wave of criticism started, we did not have our evidence readily at hand, at least not in the form that is currently demanded.

Take Care That the Assessment of Mathematics Achievement is in Order

The most vulnerable part of a reform movement is students' achievement scores. Everything seems to be fine, until scores decrease or are being perceived as less. Reform nearly always means opting for other content or other accents in content, resulting in different achievement profiles for students. The problem here is that no one will argue with the things that improve, but that is not the case for the things that decrease. Even if it has been agreed on that one topic is not so important, once the scores start going down, there is bound to be protest. Justifying the scores in retrospect does not seem to help. Therefore it must be recommended, when making choices, not to discuss only the input, but also, and especially the expected changes in the output. This makes them more 'real'.

The experience that changes in achievement profiles can become a breaking point for a reform, serves to emphasise the importance of how results are assessed. In the end, what matters is not the inspiring learning environment that can be achieved through RME, but the test scores. Therefore it is important for reformers to also look at tests. We did not really do this in the Netherlands, while we are now being judged on the basis of these test results.

RME Continues

I cannot end this paper without reporting a sign of recovery. Our opponents have taken the step of entering the market and found a publisher who dared to take the decision to publish a new traditional mechanistic textbook series, after the last one disappeared by the end of the last century. This publisher has the good practice of letting a panel of teachers judge prototypes of new products. The group had been established from proponents of restoring the mechanistic approach to mathematics education. However, their commentary was significant. No, this kind of textbook series was not what they needed: there should be illustrations and they missed the didactics telling them what to do when children do not understand; after all, you cannot go on infinitely with demonstrating.

The next step will certainly be that RME innovations such as the empty number line, the corresponding stringing strategy, the arithmetic rack with the two lines of beads in a 5-5 structure, the percentage bar, and probably even whole-number-based written division as an introduction to digit-based algorithmic calculation will show up in this mechanistic textbook series. Whether this also will happen with the broad interpretation of calculation, in which written calculation, mental calculation and estimation are integrated, remains to be seen.

What will in any case not appear in this mechanistic textbook series, and others that may follow, are problems that stimulate mathematical reasoning. The attackers of the RME reform state very explicitly that primary school students need to learn calculation skills and do not need to think. In contrast, within RME, getting the children to think mathematically is what it is all about. Unfortunately, this key goal is not reflected very strongly in the existing RME textbooks for primary school. Although these textbooks contain many RME

characteristics, puzzle-like number problems in which children have to think are rare (Kolovou, Van den Heuvel-Panhuizen, & Bakker, 2009). In this respect, the RME textbooks truly do need improvement: there should be more mathematics in Dutch arithmetic education. This is a point we have to work on. The narrow focus on plain calculation can really threaten the mathematical competence of Dutch students, but this shortcoming in how RME is implemented in textbooks and maybe also in classrooms is beyond the view of our attackers. Their concerns are only about students' skills in one type of calculation, the algorithms.

References

- Ahlers, J. (1987). Grote eensgezindheid over basisonderwijs. Onderzoek onder leraren en ouders. *School*, 15(4), 5-10.
- Anghileri, J. (2001). Development of division strategies for Year 5 pupils in ten English schools. *British Educational Research Journal*, 27(1), 85-103.
- Askew, M. (2002). The changing primary mathematics classroom – the challenge of the National Numeracy Strategy. In L. Haggarty (Ed.), *Aspects of teaching secondary mathematics: Perspectives on practice*. (pp. 3-17). London: RoutledgeFalmer.
- Becker, J. P., & Jacob, B. (2000). The politics of California school mathematics: The anti-reform of 1997-99. *Phi Delta Kappan*, 81(7), 529-537.
- Bright, G. W. (1978). Assessing the development of computation skills. In M. N. Suydam, & R. E. Reys (1978). *Developing computational skills* (pp. 148-241). Reston, VA: NCTM.
- Brown, M. (1981). Number operations. In K. M. Hart (Ed.), *Children's understanding of mathematics: 11-16* (pp. 23-47). Londen: John Murray.
- Cadot, J., & Vroegindewij, D. (1986). *10 voor de basisvorming, Rekenen/wiskunde onderzocht. Op weg naar een nationaal plan voor het reken-wiskundeonderwijs op de basisschool en het gebruik van de computer daarbinnen*. Utrecht: OC&OW, Rijksuniversiteit Utrecht.
- Clarke, D. M. (1997). The changing role of the mathematics teacher. *Journal for Research in Mathematics Education*, 28(3), 278-308.
- De Bruijn, H. (2010). Polderen moet en de markt is er gewoon. *De Academische Boekengids*, 80, 3-5.
- De Jong, R., Treffers, A., & Wijdeveld, E. (Eds.) (1975). *Overzicht van Wiskundeonderwijs op de Basisschool. Leerplanpublikatie 2*. Utrecht: IOWO, Rijksuniversiteit Utrecht.
- De Moor, E. (1980). Gevarieerd rekenen. Leerplanpublikatie 11. *Wiskobas-Bulletin*, 9(1/2/3). Utrecht: IOWO, Rijksuniversiteit Utrecht.
- Department of Education and Science (DES) (1982). *Mathematics Counts*, London: HMSO.
- Freudenthal, H. (1968). Why to teach mathematics so as to be useful. *Educational Studies in Mathematics*, 1, 3-8.
- Freudenthal, H. (1971). Geometry between the devil and the deep sea. *Educational Studies in Mathematics*, 3, 413-435.
- Freudenthal, H. (1973). Mathematics as an educational task. Dordrecht: Reidel Publishing Company.
- Freudenthal, H. (1979). Structuur der wiskunde en wiskundige structuren; een onderwijskundige analyse [Structure of mathematics and mathematical structures; an educational analysis]. *Pedagogische Studiën*, 56(2), 51-60.
- Freudenthal, H. (1991). *Revisiting mathematics education. China lectures*. Dordrecht: Kluwer Academic Publishers.
- Handal, B. & Herrington, A. (2003). Mathematics teachers' beliefs and curriculum reform. *Mathematics Education Research Journal*, 15(1), 59-69.
- Hazekamp, D. (1978). Teaching multiplication and division algorithms. In M. N. Suydam, & R. E. Reys (1978). *Developing computational skills* (pp. 96-128). Reston, VA: NCTM.
- Hickendorff, M., Heiser, W. J., Van Putten, C. M., & Verhelst, N. D. (2009). Solution strategies and achievement in Dutch complex arithmetic: Latent variable modeling of change. *Psychometrika*, 74(2), 331-350.
- Inspectie van het Onderwijs (1998). *Verslag van de staat van het onderwijs in Nederland over het jaar 1997*. Utrecht: Inspectie van het Onderwijs.
- Janssen, J., Van der Schoot, F., Hemker, B., & Verhelst, N. (1999). *Balans van het reken-wiskundeonderwijs aan het einde van de basisschool 3*. Arnhem: Cito.

- Janssen, J., Van der Schoot, F., & Hemker, B. (2005). *Balans van het reken-wiskundeonderwijs aan het einde van de basisschool 4*. Arnhem: Cito.
- Kilpatrick, J., Swafford, J., & Findell, B. (Eds.) (2001). *Adding it up: helping children learn mathematics*. Washington, DC: National Academy Press.
- KNAW-Commissie Rekenonderwijs Basisschool (2009). *Rekenonderwijs op de basisschool*. Amsterdam: KNAW
- Kolovou, A., Van den Heuvel-Panhuizen, M., & Bakker, A. (2009). Non-routine problem solving tasks in primary school mathematics textbooks – A needle in a haystack. *Mediterranean Journal for Research in Mathematics Education*, 8(2), 31-68.
- Kühnel, J. (1925). *Neubau des Rechenunterricht II* (5. Druck). Leipzig: Klinkhardt.
- Kuitenbrouwer, J. (2010). Niet de beste spreker wint de verkiezingen, maar hij die goed zijn woorden kiest. *NRC Handelsblad*, 15 May 2010,
- Lakoff, G. (2004). *Don't think of an elephant!* White River Junction, VT: Chelsea Green.
- Levering, B. (2009). Ons rekenonderwijs is Best of the West. *Pedagogiek in Praktijk Magazine*, 47, 14-20.
- Leung, I., Wong, R., & Pang, W. (2006). *Departing from the Traditional Long Division Algorithm: An Experimental Study*. Paper presented at the 29th Annual Conference of Mathematics Education Research Group of Australasia. Canberra, Australia (<http://www.merga.net.au/documents/RP382006.pdf>)
- Menne, J. J. M. (2001). *Met sprongen vooruit. Een productief oefenprogramma voor zwakke rekenaars in het getalengebied tot 100 – een onderwijsexperiment*. Utrecht: CD-beta Press, Universiteit Utrecht.
- Middleton, J.A. & Van den Heuvel-Panhuizen, M. (1995). The ratio table. *Mathematics Teaching in the Middle School*, 1(4), 282-288.
- Mullis, I.V.S., Martin, M.O., & Foy, P. (2008). TIMSS 2007 International Mathematics Report. Chestnut Hill, MA: TIMSS & PIRLS International Study Center, Lynch School of Education, Boston College.
- Nussbaum, M. C. (2002). Education for citizenship in an era of global connection. *Studies in Philosophy and Education*, 21, 289–303.
- Onderwijsraad (2003). *Kennis van onderwijs: Ontwikkeling en benutting*. Den Haag: Onderwijsraad.
- Onderwijsraad (2010). *Ontwikkeling en ondersteuning van onderwijs*. Den Haag: Onderwijsraad.
- O'Toole, S. & de Abreu, G. (2005). Parents' past experiences as a mediational tool for understanding their child's current mathematical learning. *European Journal of Psychology of Education*, 20(1), 75-89
- Rengerink, J. (1983). *De staartdeling: Een geïntegreerde aanpak volgens het principe van progressieve schematisering*. Utrecht: OW&OC, Rijksuniversiteit Utrecht.
- Streefland, L. (1985). Wiskunde als activiteit en de realiteit als bron. *Nieuwe Wiskrant*, 5(1), 60–67.
- Streefland, L. (1993). The design of a mathematics course. A theoretical reflection. *Educational Studies in Mathematics*, 25(1–2), 109–135.
- Streefland, L. (1996). Learning from history for teaching in the future. Regular lecture held at the ICME-8 in Sevilla, Spain; in 2003 posthumously published in *Educational Studies in Mathematics*, 54, 37–62.
- Thompson, I. (1999). Written methods of calculation. In I. Thompson (Ed.), *Issues in teaching numeracy in primary schools* (pp. 169-183). Buckingham: Open University Press.
- Thompson, I. (2008). Deconstructing calculation methods, Part 4: division. *Mathematics teaching*, 208, 6-8.
- Treffers, A. (1978). *Wiskobas doelgericht*. Utrecht: IOWO, Rijksuniversiteit Utrecht.
- Treffers, A. (1982a) Cijfers in het rekenonderwijs van toen en nu. *Pedagogische Studiën*, 59(3), 97-115.
- Treffers, A. (1982b) Basisalgoritmen in het wiskunde-onderwijs op de basisschool. *Pedagogische Studiën*, 59(11), 471-483.
- Treffers, A. (1987). *Three dimensions. A model of goal and theory description in mathematics instruction – the Wiskobas project*. Dordrecht: Reidel Publishing Company.
- Treffers, A. (1991a). Realistic mathematics education in the Netherlands 1980-1990. In L. Streefland (Ed.), *Realistic Mathematics Education in primary school* (pp. 11-20). Utrecht: CD-β Press, Utrecht University.
- Treffers, A. (1991b). Didactical background of a mathematics program for primary education. In L. Streefland (Ed.), *Realistic Mathematics Education in primary school* (pp. 21–56). Utrecht: CD-β Press, Utrecht University.
- Treffers, A. (1993). Wiskobas and Freudenthal: Realistic Mathematics Education. *Educational Studies in Mathematics*, 25, 89-108.
- Treffers, A., & De Jong, R. A. (1984). Nieuwe aanpak 'ouderwetse rekenkwast' voldoet uitstekend. *Didaktief*, 14(2), 2-4.
- Treffers, A., & De Moor, E. (1984). *10 voor de basisvorming rekenen/wiskunde*. Werkboek. Utrecht: OW&OC, Rijksuniversiteit Utrecht.

- Treffers, A., & De Moor, E. (1990). *Proeve van een nationaal programma voor het reken-wiskundeonderwijs op de basisschool. Deel 2. Basisvaardigheden en Cijferen*. Tilburg: Zwijsen.
- Treffers, A., De Moor, E., & Feijs, E. (1989). *Proeve van een nationaal programma voor het reken-wiskundeonderwijs op de basisschool. Deel I. Overzicht einddoelen*. Tilburg: Zwijsen.
- Treffers, A., & Van den Heuvel-Panhuizen, M. (2010). De rekenmethode telt. *Reken-wiskundeonderwijs: onderzoek, ontwikkeling, praktijk*, 29(1), 50-56.
- Van de Craats, J. (2007). Waarom Daan en Sanne niet kunnen rekenen. *Nieuw Archief voor Wiskunde*, 5/8(2), 132-136.
- Van den Heuvel-Panhuizen, M. (1996). *Assessment and Realistic Mathematics Education*. Utrecht: CD-β Press, Utrecht University.
- Van den Heuvel-Panhuizen, M. (2001). Realistic Mathematics Education in the Netherlands. In J. Anghileri (Ed.), *Principles and practices in arithmetic teaching: Innovative approaches for the primary classroom* (pp. 49-63). Buckingham/Philadelphia: Open University Press.
- Van den Heuvel-Panhuizen, M. (2003). The didactical use of models in realistic mathematics education: an example from a longitudinal trajectory on percentage. *Educational Studies in Mathematics*, 54, 9-35.
- Van den Heuvel-Panhuizen, M. (2008a) Learning from “didactikids”: An impetus for revisiting the empty number line. *Mathematics Education Research Journal*, 20(3), 6-31.
- Van den Heuvel-Panhuizen (Ed.), M. (2008b). *Children learn mathematics. A learning-teaching trajectory with intermediate attainment targets for calculation with whole numbers in primary school*. Rotterdam/Tapei: Sense Publishers.
- Van den Heuvel-Panhuizen, M., & Goffree, F. (1986). *Zo rekent Nederland*. Enschede: SLO.
- Van den Heuvel-Panhuizen, M., & Treffers, A. (1998). *NCRC-module Oefenen*. Utrecht: Freudenthal Instituut, Universiteit Utrecht.
- Van den Heuvel-Panhuizen, M., Robitzsch, A., Treffers, A., & Köller, O. (2009). Large-scale assessment of change in student achievement: Dutch primary school students’ results on written division in 1997 and 2004 as an example. *Psychometrika*, 74(2), 351-365.
- Van Gelder, L. (1959). *Grondslagen van de rekendidactiek* (3e druk). Groningen: J.B. Wolters.
- Van Maanen, J. (2007). *De koeiennon*. Utrecht: FIsme, Universiteit Utrecht.
- Van Putten, C. M. (2005). Strategiegebruik bij het oplossen van deelsommen. In J. Janssen, F. van der Schoot, & B. Hemker, *Balans van het reken-wiskundeonderwijs aan het einde van de basisschool 4* (pp. 125-131). Arnhem: Cito.
- Wijnstra, J. (Ed.)(1988). *Balans van het rekenonderwijs in de basisschool*. Arnhem: Cito.

Structured Failing: Reshaping a Mathematical Future for Marginalised Learners

Robyn Jorgensen (Zevenbergen)

Griffith University, Nyangatjatjara Aboriginal Corporation

r.jorgensen@griffith.edu.au

In this paper I draw on a particular case that encapsulates some of the most extreme elements of educational disadvantage – poverty, remote location, English as a foreign language, cultural diversity and Aboriginality – to provide a lens for understanding the complexity of coming to learn school mathematics. In so doing, I illustrate the need for a greater understanding of the intersection of various factors that limit the opportunities for success in school mathematics. The objective of this paper to provide an understanding of the complexity of teaching in remote contexts that will challenge current practice and move to a more holistic model for conceptualising research, practice and policy in mathematics education that may enable greater access to mathematics and schooling for some of the most disadvantaged students in Australian schools.

Learners from particular backgrounds have a greater chance of failing school mathematics than their peers from mainstream, middle-class backgrounds. A popular mythology is that this is due to some innate ability and one that has considerable acceptance in school mathematics. This standpoint preserves the hegemony of school mathematics and perpetuates its status, while reifying the structured failing of too many students. In this presentation I will propose a model for analysing the structured failing of students who come from particular social, cultural, regional and language backgrounds. Increasingly, policy makers, educationalists, researchers and the wider public recognise that there is something inherent in mathematics education (and schooling) that works against the success of some students. The solution cannot be found in looking from a mathematical lens but must be much broader if increased access to mathematics education is to be a reality of the future.

In this paper, I draw on my past twelve months in the field where I have been working in one of the most disadvantaged contexts in Australia. The experience has shown me how limited a researcher's perspective can be when we undertake 'fly in fly out' research. The complexities of teaching and learning in these contexts are elusive when approaching research in this way. In structuring this paper, I provide a scenario from the classroom in which a young Anangu student was working on some activities around equivalence in fractions. Drawing on this scenario, I then discuss the multitude of factors that facilitate or hinder mathematical learning. From this I conclude that learning mathematics must be considered in the context of learning so as to build a much stronger theory of learning mathematics, particularly for learners who live in worlds different from mainstream education. Finally, I discuss the implications of these earlier considerations on teacher education.

In writing the paper, I draw on the theoretical constructs of Bourdieu (1977; 1990) – game, habitus, field - but deliberately do not extend these. Such extension is beyond the scope of this paper. Familiarity with the constructs has been assumed. My key intention is to unpack the complex milieu in which marginalised students are working and trying to make sense of school mathematics, often with limited success.



Equivalent Fractions: An Exemplary Case

The classroom is in a junior secondary in a remote Aboriginal community. As is culturally-appropriate in this context, young men and women are taught separately with a teacher of the same gender. On this day, the female teacher is working with the only female student. There is some revision around fractions using a commercially produced resource that has pizzas divided into halves, quarters, eighths and sixteenths. Another set of pizzas is divided into thirds, sixths and twelfths. The teacher is working with the student, Anastasia⁵ and asking the usual questions that require her to articulate how many pieces in the different pies. The sequence was originally on the halves and then extended to other denominations.

T⁶: How many halves are there in the pizza?

Pause

S: two

T: That's right. So how many quarters are there in that pizza?

S: Two

T: mmm so how many quarters in that pizza?

T: points to the pizza with quarters

S: (Smiles) Four

T: Good, so you do know this stuff. That's really good

This type of interaction continued through different quantities of fractions. What became increasingly apparent throughout the interactions was that as the teacher posed a new question on a given fraction (such as half or quarter), the student would reply using the previous answer. After about 6 of these questions, the student appeared to understand the game behind the questions being posed.

The teacher then moved into equivalent fractions. A similar process occurred with this game question. The moves in the interaction saw the teacher a series of questions as to how many smaller parts 'made up' a part of a whole. Initially Anastasia relied on the questioning strategy in the first question sequence as to how many made up the whole. It appeared that she took her cue for the questions from the initial stem in the question. This is shown in following extract:

T: So how many quarters make a half

S: four

T: Have a think about it again... how many quarters make a half – one of these (points to half a pizza).

S: two

T: Great, that is good. You are very clever. I knew you'd learnt this before. So how many eighths in a quarter?

S: Eight

[teacher repeats process to draw attention to the part of the part process]

After a few examples, the teacher then draws on two strategies to highlight equivalence. Both are used concurrently. The teacher writes on paper the 4 to 8 relationship of how many eighths in a quarter trying to illustrate the doubling/halving process so that the "two-ness" can be shown with figures. Many questions and much talking is focused on the numerical relationships. Anastasia, however, relies heavily on visual cues, often taking the smaller units to make the larger unit - e.g. two eighths to show how it is visually the same as one quarter. However, at no time does she place the pieces on top of each other, and each time she manipulates the objects it is an immediate

⁵ This is a pseudonym for the student.

⁶ T is used to indicate T and S is used for Student

recognition – that is, she immediately would take 2 eighths or 3 sixths to create the equivalent.

In the final part of this section of the activity, Anastasia made a whole pizza using pieces scattered around the table. These were varied in sizes (quarters, eighths, and sixths). She took pieces and worked them to make a whole. The final piece, a quarter, was not taken by trial and error but with perceived automaticity in recognition of the size. It appeared from this interaction that the student relied heavily on visual recognition for identification of size and equivalence. There was little reliance on the use of numbers.

In the next section of the activity, the teacher moved to the use of computers and a fraction game where the student would have a nominated piece (such as $\frac{3}{4}$) and had to place on a number line that had denominators in twelfths. The initial strategy was to hang the monkey on the hook that had the same numerator (i.e. $\frac{3}{12}$). This did not work of course. The teacher then used a range of strategies that relied on a cross multiplying strategy to find the equivalence. This created great confusion as in one game the multiplier was 4 when the piece to be hung on the line was in thirds ($\frac{2}{3}$) and the next piece was $\frac{3}{4}$ so needed a multiplier of 3. Anastasia appeared confused with this irregularity in multipliers. At some points she would rely on drawing lines in clusters to show that there were four groups of three so that $\frac{3}{4}$ could be seen to have nine twelfths.

What is poignant in these observations was the non-reliance on number to understand fractions. Anastasia's work was heavily drawing on visual thinking. It appeared that she struggled to understand the use of numbers and the ways in which numbers could be multiplied. Her strategies were very reliant on being able to create visual representations. As in the pizza work, her capacity to respond to teacher questions, once she accessed the game the teacher was using with her questions, was very much in the visual.

Of further note is that the language background of many remote Aboriginal students is very heavily in their home language. In this case, the student was a Pitjantjatjara speaker whose main contact with Standard Australian English was through school and if she interacted with non-Aboriginal people in community, or if she went to a regional centre. For many remote students, Australian English is a foreign language. This makes questioning students about metacognition an almost impossible task without the use of an interpreter. Even then, the home language of the student often does not have the language structure to enable appropriate responses to be developed due to the mathematical concepts not being a (natural) part of that culture and hence language.

In the following sections, I seek to analyse the interaction with Anastasia to highlight the problematic engagement with mathematics in particular, and schooling in general for remote Aboriginal learners. In doing so, my goal is to draw out the need for new education and research paradigms that may seek to explore the complexity of assimilationist education. This proposition may be construed negatively but I contest this. By its very nature, Western education should be considered to be assimilationist. It represents particular worldviews that are incongruent with many Aboriginal cultures. Coming to learn school mathematics requires a conscience effort to take on board the knowledge structures of Western thinking and rationalism

Closing the Gap: A National Initiative

The Federal Government espouses a commitment to “closing the gap” between the first nation people of Australia with the rest of the nation with priorities in the areas of health, housing and education. Undeniably the statistics for first nation people represent a national disgrace in terms of provision and outcomes. The Rudd government is putting significant

amounts of money into a range of initiatives to address the gap between First Nation people and the rest of the nation.

However, in considering the Rudd initiative, consideration must be made of the differences among First Nation People. The AAMT initiative “Make it Count” recognises these differences and has strategically focused on working with First Nation people in regional centres rather than remote. Similarly, Pearson cites research where it was found that First Nation people who marry outside their culture and live in urban areas are more likely to have children who will engage with schooling and become successful in their studies and transitions to work. For a plethora of reasons, this is far more difficult to achieve in remote communities.

While there are many aspects of the “Closing the Gap” initiative that can be criticised, the intent of the Government is heavily focused on addressing the inequalities in outcomes between First Nation People of Australia and mainstream Australians. This gap is significantly increased when remote living is considered. In education, this is most evident in the NAPLAN testing where remote Aboriginal students are consistently underperforming nationally. A recent announcement by the Federal government (Patty & Harrison, 2010) was their intention to reform preservice teacher education so that teachers would be better prepared to work in remote locations to develop better programs and be able to cope with remote living. Aboriginal activist Noel Pearson has influenced government significantly with Aboriginal and Torres Strait Islander advice. He is a strong advocate for quality teachers being sent to remote sites as he sees this as a strong factor in bringing about quality education to remote students. However, what is seen as “quality” in one context may not directly transfer to the new context. Transposing urban ways of living and schooling into remote settings may meet with opposition and failings as many of the assumptions underpinning urban education may be quite different from remote contexts.

Worldviews : The Clash of Cultures and Ways of Working and Being

The difference in worldviews between Western education and remote Aboriginal cultures is widely recognised as a considerable issue in First Nation education but how this has been built into education reforms is at best a very mixed bag. For example, in the Northern Territory (NT) bi-lingual education was abolished in late 2009 as it was seen not to have met with success while in the Kimberley region, bi-lingual education in the early years is seen as a key to educational reform. Having children come to school strong in their home language but weak in Standard Australian English has resulted in an early years bilingual program in the Kimberley (with considerable resourcing) when it was being ceased some few hundred kilometres away in the NT after being operational for a number of decades in the neighbouring state.

Aboriginal students in many remote areas are still very strong in their home cultures and languages. This is most evident in the desert regions of Australia – the APY lands in South Australia, most of the Northern Territory and the far north of Western Australia. Aside from language issues, many of the cultural norms create dissonances between expectations of the learners with formal schooling. These barriers are quite profound and contribute significantly to the poor attendance in these regions. These need to be an integral part of coming to understand the impediments to learning that are beyond the bounds of mathematics education yet contribute significantly to them.

In terms of mathematics education, the immersion in a numerate and literate culture as represented in school knowledge is not part of the habitus of most communities in remote areas. The exposure to written text and number is almost non-existent in communities and

the home. Taken-for-granted aspects of mainstream Australian culture are not evident in remote communities or families – often birthdates are not known or seen to be important; students' names can change many times (both first name and family names); street names and numbers are not present in communities; most families do not have a home phone or computer (or written texts). These absences represent significant challenges to creating bridges between the home and school.

The culture among Anangu people is very strong. For many young people this means that they undertake particular cultural activities that mark the transition into adulthood. In becoming adults, the young person is able to choose whether or not to come to school. This transition into adulthood can occur as young as twelve years of age, thus limiting the time in school significantly.

Life in remote areas has created a very different way of being and living in the world. Long and medium term planning is absent so the premises upon which most of Western education is built, particular mathematics, are missing from the habitus of the learning. Number is not an important aspect of desert life, particularly big numbers. A recent case of an Anangu family wanting to buy a car from a resident saw the Anangu family come to the buyer indicating they had the cash. The car was for sale for \$7000 but the family had \$700 and were very disappointed that they could not take the car. This confusion with big numbers is a common occurrence. The level of trust required by non-numerate people to live in a numerate world can only be considered phenomenal but also very disempowering.

If we return the original case at the opening of this paper, the impact of the worldview becomes foregrounded. In this case, Anastasia did not use number in her solution of problems. Her initial visual strategy allowed potential for success and helped with some aspects of the computer game. However, the need to move forward with the concept of part number will be contingent on the possibilities to use number sense. However, this is likely to be severely limited due to her restricted sense of number – both whole number and part number.

The linear logic that is integral to a significant portion of teaching school mathematics is not part of the Anangu habitus. In solving the fraction problems using visual strategies offered different potential for solutions but this strategy limits the extension of that knowledge. This was very evident when Anastasia tried to work out the equivalent fractions needed in the computer game. Visual strategies were far less successful in this type of problem. The logic needed focused on relationships between number families (such as half, quarter, sixths and twelfths). Seeing relationships and then applying a logic to these to find and calculate equivalence was not evident in the strategies observed.

Furthermore, Anangu culture focuses in the “here and now” and does not adequately include a futures perspective. This is evident in much of the ‘planning’ undertaken in Anangu events. For example, in one community, there is a “Yellow Bus” (an American-type school bus) that is used to take members of the community to events such as funerals or football/sporting events. The travellers are expected to cover the costs of fuel. When the bus leaves, it is filled by the amount of money people have contributed which inadvertently means the bus frequently runs out of fuel on long trips (and every trip is a long trip in remote Australia!). The events are so frequent that the local shire managers have requested that travellers will need to put up the fuel money prior to departure from community. There are numerous tales that highlight this aspect of Anangu “planning”. The capacity to plan is a key part of the Western rationality and relates strongly to financial literacy. However, many of the financial literacy packages available to schools are premised on a Western notion of forward planning and budgeting which is not part of the Anangu habitus. Thus, to

be able to participate in such learnings, a reconstitution of the Anangu habitus is necessary if there is to be success.

A common observation of students is their reliance on a range of strategies that are different from those common to mathematics teaching and learning. The systems of reasoning are not those of Western education so remain invisible to teachers and hence cannot be drawn upon to transition students into Western mathematics. Hypothetically, what this disjunction between the two ways of knowing and doing may be the root of the failure observed in the NAPLAN data that appears in late primary school. It is here that differences in performance appear to grow. While it may be a function of attendance, the failure to attend school could be, in part, associated with the failure to walk in both worlds and experience success.

Language Barriers

The language of instruction and mathematics offer particular barriers to learning. In Pitjantjatjara there are only a few prepositions in comparison to the 60+ in English. Coming to see equivalence requires a language of number, fractions and prepositions (for transposing fractions) as well as the language games that are used in the teaching episodes. As I have argued in many papers, the language games that are played in mathematics classrooms represent a particular cultural form and access to mathematical understandings is contingent upon ‘cracking the code’ of school mathematics.

What can be seen in the interactions between Anastasia and the teacher is a typical pedagogic interaction where the teacher poses questions to scaffold learning. However, what can also be seen is Anastasia trying to make sense of the pedagogic interaction. In the first set of interactions, the game is for her to be able to articulate how many items in the whole. I suggest that in the first interaction where the teacher poses the question of halves and she replies two, this answer is then offered again for quarters (i.e. two). While this is incorrect, I contend that this interaction is similar to the others where Anastasia is trying to interpret the game that is being played as much as trying to work out the mathematical ideas that are embedded in the interactions. This guessing the game, which I draw from the work of Bourdieu (1977; 1990), is one that is common among students for whom the game is not part of their familial habitus.

In the second set of interactions, there is a shift in the game. Here the teacher is no longer talking about the whole but focuses on parts of the whole so the student has to try to make sense of this shift. What can be seen is that Anastasia is trying to guess the game by drawing on the key words used by the teacher. In this case, it appears that her responses draw on the words of quarters and eighths and these are the cue words to which the student responds. Over the subsequent interactions, the student anticipates the game and understands that the questions are now relating to the parts and parts relationships.

What is not shown in the earlier transcripts is how the teacher also writes the fractions on a piece of paper using numerical representations. These, however, are not used by the student who relies on her visual strategies. The interactions around the numerical representations did not appear to make sense to the student who would look at the teacher as she wrote but then return to the manipulation of the pizza fractions.

Student Attendance: The Greatest Barrier to Learning

In using the case of Anastasia, it is not my intention to draw attention to one particular student. Rather, the examples drawn from the one example have been used to highlight the

struggles faced by students and teachers in remote communities as they try to teach school mathematics. The issues to which I have drawn attention are embedded in the clash of cultures between that of school/mathematics and that which First Nation learners bring to school. There are many areas that need to be addressed if there is to be a closing of the gap in Indigenous performance and outcomes in education. However, I would contend that perhaps the biggest hurdle to success is attendance. The poor attendance, and subsequent engagement when attending, is the lynchpin to success.

The attendance issue is endemic and needs to be addressed seriously if First Nation students are to succeed in Western schooling, and mathematics. Funding regimes are premised on the notion that for success in schooling, students must attend 80% of the time. Schools are measured against this. However, the slipperiness in attendance records denies actual attendance and, moreover, engagement. In many remote communities, formal learning is not part of the habitus of First Nation people so the concept of schooling is not integral to their worldviews. This impacts significantly on students but also teachers. The high turnover of staff in remote areas is a reflection of the harsh conditions of remote life of which the job satisfaction levels are limited by the engagement of students. As one teacher commented, "I did not train for four years to have no students in my class" as she nearly broke down with the frustration of poor attendance, student walk outs and the perception of school being a 'drop in' centre.

Planning quality learning experience with irregular attendance is a considerable challenge for remote teachers. Not knowing who will come to school on a given day (or part of the day) means that planning for learning is a complex task as the diversity in any one class is immense.

NAPLAN and National Curriculum: Inclusion or Exclusion?

The above arguments are drawn together with the culmination of NAPLAN testing. Without being critical of the testing scheme as a whole, I intend to draw attention to the inappropriateness of these tests for remote First Nation students. The capacity to answer the questions in Year 7 and Year 9 tests is severely limited. The tests are administered by age yet by the time students are in Year 9 many would have been lucky to have attended the equivalent number of days as a primary school student in Year 5. The chronological age of the students is a poor indicator of time in school and hence the tests are targeting the dominant group in Australian society, those who have attended school for most of their lives. This is clearly not the case for most remote students.

The diversity within a classroom may present one set of challenges to teachers, but a tension with this diversity is the students' desire to be the same as their peers. This meant that the recent tests identified particular students to sit the tests. The fact that they are set apart from their peers is problematic. A more appropriate approach would be for all students who attend to sit the test so that the isolation is not obvious.

Regardless of their capacity to sit the test or read the booklet, the students all like to be the same. They all like to do the same thing. Having some sit the test and others not sit is more likely to result in all the students walking out. A better solution is for all of them to sit it.

Furthermore, teachers expressed frustration with the test. The levels were well above what was possible. The Year 9 test was above the capacity of the students, as well as the relevance of many of the questions and reading materials. For example one reading item consisted of three related items about gorillas and the impact of mining in the region that resulted in land clearing, which in turn, drove gorillas out of their environment making

them easier for poachers to catch and kill. The experiences of remote First Nation students are very tied to their country and the immediate areas around that country.

The tests are not set up for our students. They are meant to fail them. It is a waste of their time, our time and government money. Once they realise the tests are on, they don't come back the next day.

This last point should not be lost. The students are proactive in voting with their feet and do not return to experiences that they do not enjoy. NAPLAN was not something that they found useful or enjoyable. No student sat more than one test.

National Curriculum

The capacity to deliver a national curriculum in remote areas is perhaps one of the biggest challenges to First Nation education. For the reasons cited in the preceding sections of this paper, I would contend that the priority for remote education is to enable First Nation students the right to be literate and numerate in the first instance and then to consider priorities in curriculum.

Past practices in remote education has often been focused on attendance and entertainment. Creating environments that allow students to draw on their culture (e.g. music, dance, art, football) or interest areas to ensure that they attend school may have put other learning areas (such as literacy and numeracy) at risk. The considerable catch-up required due to poor attendance means that priority areas must be integral to First Nation education. Already NAPLAN data suggest that literacy and numeracy are at worryingly low levels and that the gap widens with the time in school. Having priority areas of learning for remote First Nation people must be a serious area for discussion.

The challenges faced by teachers in remote areas are already enormous. Placing further demands on them when they are barely able to meet basic levels of literacy and numeracy engenders greater burnout and dissatisfaction. This is not a moot point. One of the key factors in success is stability of the teaching staff yet teacher turnover in remote education is very high.

Implications for Teacher Education: Preparing to Teach Mathematics

If the Rudd government is serious about the challenges of creating success for remote First Nation students, then closer scrutiny of the complexity of teaching and living in remote Australia must be a prime consideration. If the Rudd government wants to take a proactive stance in the preparation of teachers to work in remote communities, then particular notice needs to be taken of the whole context. Before I discuss implications for teacher education, a powerful point must be made. It is not the sole responsibility of teachers to ensure that First Nation students are successful in school or mathematics. There are many factors that contribute to success. Perhaps, the most important factor is attendance. This is a whole of community responsibility. Teachers can only do so much to encourage students to come to school. In many communities teachers have to drive around the communities prior to school to collect and bring students to the school. Some teachers have to conduct community meetings and work with communities to develop strategies for coming to school (such as “no school, no pool” policies, or closing the community store if the numbers in school are low; or developing incentive plans to reward attendance). Attendance is a community issue where all parties must work collectively to ensure attendance at school. Without attendance, regardless of how good a teacher may be, there is little chance to achieve success.

As I have attempted to show in this paper, researching mathematics education in remote contexts must capture the multitude of factors that impinge on learning and teaching. While it is easy for us as community of mathematics educators to focus on our discipline, it cannot be considered in isolation of the contexts of learning. Failure to recognise these factors isolates us from the reality of the classroom, the schools, the communities and the field of education. As such, the impact of our research possibilities is limited. Quick fix solutions will not address the entrenched failure that is enmeshed with the context of learning.

Of most significant importance is the prime need for students to attend school on a regular basis but also when in school that there is engagement with learning. While cultural issues of shame feature strongly in teachers' minds when trying to extend learning and not wanting to embarrass learners, or for learners to walk out rather than engage, strategies need to be developed that shift the habitus of the learner from that of the home culture to that of the school culture. Explicit teaching of these skills and dispositions is increasingly important if there is to be some change in outcomes.

Teaching the game of schooling and interactions is also important. Bourdieu's work on games shows how the game of schooling is not taught explicitly but acquired through engagement with the game. One way of learning how learning happens in First Nation culture is for teachers to try to learn something new from the students (such as card games or other gambling games). There is little explicit teaching but rather modelling or apprenticeship type approaches. Coming into the school context represents a very different teaching approach that is clouded with other factors (such as language and mathematical concepts and ways of thinking and working) that are not part of the familial habitus. If First Nation students are not engaging with the schooling, then it is increasingly difficult to engage with the game of learning.

Tenacity is a disposition that is needed for teaching in remote communities. Not only in relation to the hardships (and joys) of living remote, teachers must also learn to develop resilience to the on-going task of engaging students who do not see education as part of their life or world. There is often a feeling of groundhog day where the impact of teaching is minimal. One teacher commented that he felt that working with remote students felt like

You work all day with them and you think that they have it. Then at night, something miraculous happens. Something comes into the community and sucks everything out of their head. Then they come to school the next day and you have to start all over again.

Most of the models of planning taught in pre-service teacher education fail to prepare teachers for the conditions they will encounter in remote communities. The "revolving door" phenomenon in remote classrooms means that students, particularly adolescents, may drop in and out over the day, week or month. This means that the usual planning processes adopted by teachers fails to account for this type of teaching. More flexible models that cater for diversity in the learners as well as their knowledge systems are essential for these contexts.

What I have sought to do in this paper is to provide some insights into the failure of First Nation students in school mathematics. Rather than see such failure as due to innate ability of the learner or the failure of teachers to provide adequate teaching, I have argued that failure is complex and new ways of thinking about education provision must be addressed. Mathematics education, if it is to redress structured failings must take a much more holistic approach to educational research and practice that encompasses the multitude of factors that work for success.

References

- Australian Association of Mathematics Teachers (2009). *Make it Count*. Accessed May, 2010. <http://makeitcount.aamt.edu.au/>
- Bourdieu, P. (1977). *Outline of a theory of practice* (R. Nice, Trans.). UK: Cambridge University Press. (Original work published 1972)
- Bourdieu, P. (1990). *The logic of practice* (R. Nice, Trans.). UK: Polity Press. (Original work published 1980)
- Patty, A. & Harrison, D. (2010) Aboriginal pupils in sharp focus in education plan. Sydney Morning Herald (May 10) On line. <http://www.smh.com.au/national/aboriginal-pupils-in-sharp-focus-in-education-plan-20100511-uuun.html>
- Principals Australia. (2009) *Dare to Lead: Partnerships build success*. Accessed May 2010 <http://www.daretolead.edu.au/>
- Stronger Smarter Institute (2009) <http://www.strongersmarter.qut.edu.au/>
- Zevenbergen, R. (2000) "Cracking the Code" of mathematics classrooms: School success as a function of linguistic, social and cultural background. In J. Boaler (Ed.) *Multiple perspectives on mathematics teaching and learning*. Westport: Greenwood Publishing.
- Zevenbergen, R. (2001). Mathematics, social class and linguistic capital: An analysis of mathematics classroom interactions. In B. Atweh, H. Forgasz and B. Nebres (eds) *Sociocultural research on mathematics education: An international perspective*. London: Routledge.

Technology, Research and Practice in Mathematics Education

Barry Kissane
Murdoch University
B.Kissane@murdoch.edu.au

The past two decades have seen extraordinary developments of technologies of potential value to mathematics education, including a range of software (such as dynamic geometry systems, graphing software, statistics software and computer algebra systems), a range of devices (such as scientific and graphics calculators, desktop computers, iPods and interactive whiteboards) and a range of environments (such as computer laboratories, microworlds, the Internet and learning management systems), all in various combinations. While there are many hopes, aspirations and opinions on the appropriateness of particular technologies for particular purposes, obtaining credible and helpful evidence on such matters has been difficult; indeed, many researchers have noted the difficulties of studying what is clearly a moving target. In a world in which simplistic views of research abound (as in suggestions or inferences that research will provide the evidence upon which decisions are made), in which decisions by curriculum developers and classroom teachers are subject to a range of influences (including financial, commercial, political and ideological), and in which communications between different educational interest groups are rarely productive, it is hard to see the best way forward. In this presentation, I will attempt to survey some of the achievements and problems of research on technology in mathematics education, in order to understand the limited impact so far of research upon practice and to suggest how we might collectively do better to productively connect technology development, educational research and classroom practice for mathematics education.



Making Sense of Critical Mathematics Teaching

Annica Andersson
*Malmö University, Sweden and
Aalborg University, Denmark*
<annica.andersson@mah.se>

This paper highlights a teacher's perspective when changing her accustomed and traditional way of teaching into a pedagogic approach philosophically inspired by critical mathematics education. The focus here is on the practitioner's identities during the teaching process, in a context of change. The research is socio-culturally grounded and involves a methodologically critical ethnography. The teacher's learning was demonstrated through her voice in the end as sensing freedom in her teaching, reflecting on new possibilities and analysing the responsibilities different actors have in the mathematics classroom. Her experiences indicate that a critically mathematics inspired teaching approach has the potential to support teachers' achievement of agency.

Setting the Scene

...it feels as if it is always here (traditional education) – where the students and I end up. We start out with, for example, practical mathematics, but then suddenly I stand there again delivering a whole class explanation and think “wait, what happened now, how did we get here again...” (Elin, conversation)

Learning and Identity

Probably Elin, a mathematics teacher in a Swedish upper secondary school, is not unique in her experience of trying to change her teaching in mathematics education but ending up organising her classroom activities in a “usual” familiar way. Even having the best personal intentions and motivation to try out a new way of organising her teaching, and with an achieved agency (Biesta & Tedder, 2006) to do so, it is still very difficult to succeed. This paper discusses the teacher's perspective when she, in collaboration with the researcher, attempted to change her way of organising her teaching. The research is grounded in socio-cultural theories (Lerman, 2001; Radford, 2008). This is important as we were all, researcher, teacher and students, learning together. Learning is here understood as a process of *knowing* and a process of *becoming* as described by Radford (2008).

In this study the teacher's sense making is illuminated through the analytical tool put forward by Sfard and Prusak (2005) where identity is defined as the “collections of stories about persons or, more specifically, as those narratives about individuals that are reifying, endorsable and significant” (p. 16). Sfard and Prusak explained the notion of identity as a present identity and a designated identity – that is, an identity imagined or expected in the future. They suggested learning to be the act of closing the gap between these two identities, thus a process of *becoming*, resonating with the ideas of Radford (2008).

The purpose of this paper is to explore Elin's identities while she, in collaboration with the researcher, changed her teaching to an approach inspired by critical mathematics education, and by foregrounding societal issues as suggested by Wedege (2010). Her prior way of organising her teaching I would describe as traditional. A traditional mathematics structured teaching is here seen as mainly based on teacher's instruction, textbook exercise work (Andersson & Ravn, in press) and students' individual written assessments. With a teaching approach structured in this way, the authority in the mathematics classroom

resides with the teacher and the mathematics textbook (Bishop, 2008). Consequently, it is hard for students to influence their learning of mathematics. Critical mathematics education (CME) is here understood on two different levels. The first level addresses the microclimate, the relationships between all actors within a particular classroom. Skovsmose (2001, p.123) noted that CME “includes a concern for developing mathematics education in support of democracy, implying that the micro-society of the mathematics classroom must also show aspects of democracy”. In such a teaching situation students’ possibilities of achieving agency and students’ opportunities for negotiating and influencing their learning are taken seriously into account (Biesta & Tedder, 2006).

The second level addresses how mathematics teaching itself is organised (Andersson & Valero, 2009). Our interpretation of the assignment (among others) for mathematics teaching is to give students mathematical knowledge and competence for taking well-grounded decisions in everyday life and to interpret the flow of information and hence be able to understand and participate in political discussions in society. This paper articulates some of the challenges and problematic processes the teacher experienced in her change of teaching approach, before she eventually associated CME with terms and words such as *sensing freedom*, and *inspiration*. But first, I review the literature on teachers’ changing practice. Methodological and analytical concerns will be discussed, and a journey in time through two carefully chosen critical moments will be told.

Changing a Teaching Practice

There is a rich body of literature on teachers challenging and changing their practice (Clarke, 2007). A large part of this research focuses on teachers changing practice in reaction to new curricula and reform implementations. Lasky (2005) took a socio-cultural approach and showed how teachers’ identities are shaped in an American reform context and highlighted the dynamic interplay between political and social context and teacher’s agency and identity. Her results clearly showed that the new reform context constrains teachers’ experiences of agency.

If change is to be a robust process, and not only an isolated event, Fullan’s (1991) research implies that a stable change involves continuous learning for teachers and possibilities for reflection. For teachers to undertake the intellectual work of engaging in thorough reflections about their own practice and in making decisions for engaging in a process of change, the notion of teachers’ foreground i.e. the potentials she sees in her future practice (Alrö et al, 2008) needs to be acknowledged. Willingness, openness and feelings of trust also facilitate teacher change (Clarke, 2007; Lasky, 2005). Clarke (2007, p.28) suggested ten principles for guiding planning and implementation of teacher development programs. The possibilities for teachers achieving agency are conditional the existence of principles of “identified by teachers”, “degree of choice for participants” and “enable substantial degree of ownership”. Supportive conditions are articulated as “involving groups of teachers”, “solicit teachers’ commitment” and “allow time and opportunities for planning, reflection, and ... to share ‘the wisdom of practice’ (p. 28). Feelings, or teachers’ vulnerability are expressed in words such as “recognize that change is a gradual, difficult and often painful process”(p. 28). At the start of this project it seemed as all these conditions were almost fulfilled.

Methodology

Critical Ethnography

This research is conducted as ethnography (Willis & Trondman, 2000,) with inspiration from critical ethnography (Soyini Madison, 2005; Thomas, 1993). Willis and Trondman (2000, p.5) described ethnography “as a family of methods involving direct and sustained social contact with agents”. The researcher spent five months with two social science classes and their mathematics teacher during lessons, breaks, lunches and administration work. Thomas (1993 p.4) noted, “Conventional ethnographers study culture for the purpose of describing it; critical ethnographers do so to change it”. In the research reported here, things are a bit different as the context in itself is *the change*.

Positioning the Researcher

A researcher needs to consider critically her positioning in the classroom (Patton, 2002). In this particular context the teacher, Elin, chose to position the researcher as an assistant teacher in relation to the students and their parents, though with no assessment obligations. Elin was clearly the responsible class teacher with the authority in the classrooms. Elin and the researcher worked very close together planning the teaching sessions. The labour sharing changed over time as the researcher took more planning responsibility when Elin asked for support due to work pressure. At those times the preparing and planning part of the lessons and students’ projects were done by the researcher, Elin always made the final decisions relating the content to the curriculum and assessment system. The researcher’s role was encouraging and supporting but also, as responsible for pushing the process further, not letting go of the goals of the main research project during tough times.

Data Collection and Data Analysis

The main information was collected through participation in two Swedish social science classes in the students’ first mathematics course in upper secondary school. Field notes were complemented with regular audio-recorded conversations and written material such as personal letters, Internet forum comments and e-mails. The data were coded as suggested by Sfard and Prusak’s (2005, p. 17) analytical framework. An identifying story was represented by the triple ${}_B A_C$ where A was the identified person, B the author of the story and C the recipient. To distinguish between Elin’s different identities, authored by different actors, ${}_A A_C$ is defined as an identifying story told by the identified person by and for herself, ${}_B A_A$ is an identifying story told to the identified person, and ${}_B A_C$ is a story about A told by a third party to a third party. To understand *why* Elin’s identities changed the way they did at those particular times, the framework offered by Sfard and Prusak needed to be complemented. This was done visually with the emerging narratives told by Elin and others arranged over a timeline. Events and incidents at the school and the labour sharing were added on the timeline with the purpose of connecting the narratives with occasions in other parts of the network of the educational practise (Valero, 2009). Out of this exercise, critical moments emerged with stories related to Elin at particular historical times. To reach the endurable quality, Elin have confirmed the writings as reflecting the state of affairs. The next section of the paper introduces Elin and her reasons to engage in the project. The following sections elaborate two chosen critical moments and the last section contains Elin’s reflections on organising her classroom activities inspired by CME.

The Process as Critical Moments

Elin's Decisions on Curriculum and Assessment Issues in CME teaching

For me it's important to clarify what goals they are working towards but also that they themselves know what goals they are working for ... have a continuing dialogue...they are aware of the assessment criteria... and feel they have possibilities to show all the qualities and curriculum criteria or that they get influence on the examination forms ... some of them can't work well on written tests so there must be a variation so everybody feel they have had opportunities to show their knowledge. (Elin, interview).

This particular setting is situated in the social science program's first year at Ericaskolan, in the first compulsory mathematics A course. The grading system in the Swedish upper secondary school is different to most other countries. In upper secondary school the students attend specific subject courses on different levels. Students get graded after each finalised course, adding up to 30-40 different courses during a three-year period, and all grades are equally important when applying for further studies at university. These relatively short courses add extra pressure on teachers who have a limited time to get "everybody through" the courses. Changing teaching organisation may affect students' results negatively. Hargreaves (2001) stressed the importance of teachers engaging in change do so critically considering, for example which students benefit or which will suffer from these initiatives. This critical discussion was conducted on a regular base through the collaboration semester.

I have always spent a lot of time on all the different topics which has made them feel tedious (känns segt), especially when one only work in the book, and have to count all exercises on all the pages, then it takes quite a long time. Maybe one could look closer into what the course curriculum says, slim it and work with them more intensively (Elin, interview).

The CME projects had to be well prepared and designed to give students opportunities to reach all curriculum stated goals, on different grading levels, within the given time space of the course. The effect was that special sheets were created titled 'Objectives possible to reach within this project' and, 'What is needed to show for different grade levels'. The outcome of this was threefold. First, it was clear to all participants that care was taken for these issues and by that support was given for the project from school organisation level. Second, from a CME point of view, this made it easier for students to achieve personal agency on assessment and grading issues. They had the opportunity to decide individually what levels they wanted to work on and what goals they wanted to reach within each project. Third, it supported Elin to "get everybody through" as assessment and grading issues became transparent for all actors in the network.

The First Critical moment: Mixing Traditional and Critical Mathematics Education

If I should do the %-counting project again? Not in that way... a project... where they didn't have to hand in exercises from the book as well. But we had that discussion before and then I chose to bring in the book part to feel sure that they did something... it was a control point. (Elin, interview, reflecting back at the very end of the semester)

During the planning stage of the first student project Elin's concern was with the students and their feeling of security and recognition in mathematics education as this was their first year at Ericaskolan. She decided to start the first two weeks with traditional mathematics teaching and assessing with a written test as she saw this as the didactical contract (Brousseau, 1997) they probably were used to from prior mathematics classes. After the initial weeks the first students' project started on the mathematical topics

percentages and decimal fractions. A ‘mathematical frame’ was provided as the *task context* (Wedegé, 1999 p. 206) and the students, working in groups of three (in order to facilitate discussions with peers both about the mathematical content and the critical reflections) decided on a *situation context* (ibid) that made sense for them. Elin wanted the students and herself to feel certainty about students reaching curriculum goals and so, in relation to the objectives and openness of the project they had to solve and hand in book exercises in addition to the presentation as illuminated by her reflection above.

It was an interesting period for Elin and me as a researcher, when we reflected on how we positioned ourselves in the classroom in relation to each other and the students. We reflected on the way we talked with and answered the students and how power was distributed in the classrooms. Reflecting back, it became much easier to change the power relations during the critical projects as it came more naturally there. During the traditional mathematics teaching sequences a change was almost impossible; positioning and power relations seemed to be ‘stuck in the walls’ for all actors in the classroom. As Hargreaves (2000) pointed out, structures of schooling have become so institutionalised over years that they define the essence of schooling itself for the teachers and the students.

Discipline Issues. A critical moment from this period is from the class where some discipline problems occurred with students arriving late and some never bringing their books or calculators. Elin took a respectful and clear conversation with them about these issues. She wanted them to reflect on different possible outcomes of different choices, and what she expected from them if they wanted to pass the course and go on with their studies. Some students changed their behaviour but some did not. A critical moment was when Elin silently wrote on the whiteboard at the end of a busy lesson, at 17.00 on a Tuesday afternoon, “Those of you who don’t attend, present and pass next week will have to do a written math test”. Changes of didactical contracts can be hard for *all* participating actors

The Curling Teacher. A change in Elin’s way of describing herself was commencing:

I am fighting with the feeling that this in some way can contribute to that they don’t do the exercises, don’t reach the goals, and won’t pass the course. Maybe this is yet a “curling behaviour”. Sometimes I feel like a curling-teacher. I bring extra calculators, extra books and extra papers and pencils. In what way does that support the students becoming independent and taking responsibility? (Elin, e-mail)

At this time Elin used a ‘sweeping’ metaphor when describing her teaching. The picture of a curling teacher refers to a ‘curling parent’, in Sweden a generalising label for parents who sweep the way in front of their children and by that solve possible problems and tensions and making their children’s life as smooth and easy as possible. Summing up the first story, Elin’s present identities during these weeks were slightly modified. She struggled with acting in a (new) way she wanted and intended, for giving students opportunities to take decisions in their own way and at their own pace. At the same time her ‘curling identity’ for keeping control, interfering in the students’ work and leading the class became more obvious. Her designated identity at this stage can be interpreted as becoming a “non-curling teacher“. She started to reflect on whether this was a fruitful way of teaching or not.

The Second Critical Moment: The Statistical Project.

At a later stage of the semester a statistical project in collaboration with the environmental teacher on the theme “Ecological footprints”, a project with very high possibilities for students taking their own decisions, commenced. The project ran intensely

for three weeks during mathematics and environmental lessons, with a whole day of displaying results with PowerPoints, papers, posters, presentations, discussions and interactions in the fourth week.

I think we could have collaborated with any subject... because it was - the critical discussion – about how we live here, how we can influence and have an impact on how we live, and to react on it. It has been extra up-to-date now with the climate debate and Copenhagen meeting... but we could collaborate with the social science subject as well. It has definitely enriched both the subjects... I believe that mathematics enriches the other subject and it is good to show that mathematics doesn't stand on its own, because it never does; everything "hangs together" (Elin, interview)

Elin commented after the initial lessons: "it was hard for me to feel that I could stand back and not interfere with their work, especially when they were formulating their investigation questions I wanted to start explaining". Then, Elin became ill and stayed at home for two days. During these days the statistical project continued with me participating as researcher with the environmental science teacher in the classroom. When Elin came back from her sick leave the students had questions on assessment issues and these had to be discussed with Elin. When she met the students, something critical happened.

- Elin, tell me how you experienced the project when you came back to the science class.

- Just then, I was only there to clear some questions... but... everybody was so into what they were doing, everybody sat working, *independent*, it was awesome to see the difference from the introduction. I had only seen one session with that group, then you (environmental science teacher and researcher) had two, but it was anyway a very big difference between the first introduction when they through themselves into ... it felt as if they had been over a peak and worked down slope now, and they were *proud* of what they were doing... (Elin, interview. Authors italics indicating emphasis)

There is an Australian saying that "Teachers won't change their teaching practise unless they believe it is in the best interest for the kids" (P. Clarkson, personal communication). This could be described as a turning point for Elin and her reflections on her teaching. Her present identity after this experience was clearer and more confident; I sensed a relief in her way of being and engaging with the students. An e-mail arriving a month after the researcher left the school illuminates this point:

Reflecting on my personal learning process is difficult. I think I have been influenced in a way that I feel more *freedom* and more *inspiration* in working in different ways in relation to the curriculum goals. Projects, group work, oral assessment. I have also been thinking quite a lot about my teacher roll. I am very caring that the students feel they have enough support from me; I have done extra "matteugor", giving them special exercises. ... One can say I have worked quite hard with those things, but during the (autumn) semester I have been thinking if all this really supported the students. How does their independence and autonomy develop if they always get everything served? Obviously I, as a teacher, am there for the students, but in what way?

During this project (statistical) I have been *fighting a bit with letting go of the responsibility* to the students. Letting them seek information on their own, ask for help when needed – plainly being *responsible for their own learning*. Looking back, now when the new spring semester has started I think the students, even when we do book exercises seems to have learnt a lot by working in the way we have done. With that I mean they use the book and work more together (not always, and not everybody – but many!) (Elin, e-mail, author's emphasis)

Concluding Remarks on Teaching CME

The number of different mathematical topics to be covered during the course put time boundaries on the projects for both students and teacher, who wanted to push the projects mathematically and critically further. In Elin's words:

I think these projects have been meaningful for them. I believe it would have been good to push the projects one step further, to see that what we discussed, e.g. with Swedish language. There are things needing taking care of, e.g. hardly anybody in the class knew where the paper recycle bin was. We ought to do something about that, take the last step so something actually happens. I think that would have been experienced as meaningful so this project won't become yet another school task one does. About influence, I think on different levels, I think of their own personal influence but also that they can feel they can influence outward, that they can see through, and feel confident with that...

Elin's point of view indicates that the students did not express their usual feelings of meaninglessness during the projects. The question "Why do we have to do this?" was not raised during the projects. It rather indicates that the projects could have been pushed further both mathematically and critically. Thus, these projects have developed a sense of meaningfulness for the students. Elin commented on her teaching inspired by CME points towards an increasing awareness of the mathematical impact on the students in society:

I think that has been good, I have noticed that but it is about *them gaining the power*, and then they can in some way *reflect*; wait, what happened, what would happen instead, and if somebody does this to me or how does the stuff I am reading impact on me? That is what I think has been critical in many of these topics. That's what I think has been good. They maybe don't say much but I believe they think about it and that (mathematical knowledge) is a lot about power; I believe they are starting to see that. (Elin, interview, author's emphasis)

This also leads to a belief that every student could benefit from CME. I want to argue, in line with Elin's comment below, that CME is for everybody, not only for social science students in a Swedish context. For an understanding of the world I argue that all students, at several times during their mathematics education should be exposed to CME:

I have been thinking, I don't think this is only for the social science students. Sure, it's possible to relate to the other social science subjects ... but it is not certain that because you are social science students you are more interested in those subjects. What I feel more and more is that *it's about them feeling they have opportunities to influence* [...] they might grow of this kind of mathematics... they feel *responsibility*... and that I don't think is possible when only counting in the math book. (Elin, interview, author's emphasis).

References.

- Andersson, A. & Valero, P. (2009). *Mathematics education giving meaning to social science students. A case from Sweden*. Accepted for proceedings at II Congreso Internacional de Investigación, Educación y Formación Docente in Medellin, Colombia 26-28 Aug 2009.
- Andersson, A & Ravn, O. (in press). *A critical perspective on contextualisations in mathematics education*.
- Bishop, A. (2008). ?????? In P. Clarkson & N. Presmeg (Eds.) *Critical issues in mathematics education. Major contributions of Alan Bishop (pp. ???)*. New York: Springer.
- Biesta, G. & Tedder, M. (2006). How is agency possible? Towards an ecological understanding of agency-as-achievement. *Working paper 5*. Exeter: The Learning Lives project.
- Brousseau, G. (1997). *Theory of didactical situations in mathematics*. Dordrecht: Kluwer Academic Publishers
- Clarke, D. (2007). Ten key principles from research for the professional development of mathematics teachers. In G. C. Leder & H.J. Forgasz (Eds.) *Stepping stones for the 21st century*. Rotterdam: Sense publishers.

- Clarkson, P. C., Bishop, A., & Seah, W.T. (in press). Mathematics education and student values: The cultivation of mathematical wellbeing. In T. Lovat, R. Toomey & N. Clement (Eds.). *International research handbook on values education and student wellbeing* (pp. ???). Dordrecht: Springer.
- Hargreaves, A. (2000). Four ages of professionalism and professional learning. *Teachers and Teaching: History and Practice*. 6 (2) 151-182.
- Lasky, S. (2005). A socio-cultural approach to understanding teacher identity, agency and professional vulnerability in a context of secondary school reform. *Teaching and Teacher Education*. 21 899-916.
- Lerman, S. (2001). A Cultural/discursive psychology for mathematics teaching and learning. In B. Atweh, H. Forgasz, & B. Nebres. (Eds.) *Socio-cultural research on mathematics education*. New Jersey: Lawrence Erlbaum Associates, Publishers.
- Patton, (2002). [Qualitative research and evaluation methods](#). Thousand Oaks: Sage Publishers Ltd.
- Punch, K. (2009). *Introduction to research methods in education*. Thousand Oaks: Sage Publishers Ltd.
- Radford, L. (2008). The ethics of being and knowing: Towards a cultural theory of learning. In L. Radford, G. Schubring & F. Seeger (Eds) *Semiotics in mathematics education: Epistemology, history, classroom and culture* (pp. ???). Rotterdam: Sense Publishers.
- Sfard, A. & Prosak, A. (2005). Telling identities: In a search of an analytical tool for investigating learning as a culturally shaped activity. *Educational Researcher*, 34(4) 2-24.
- Skovsmose, O. (1994). *Towards a philosophy of critical mathematics education*. Dordrecht: Kluwer Academic Publishers.
- Skovsmose, O. (2005). *Travelling through education: Uncertainty, mathematics, responsibility*. Rotterdam: Sense Publishers.
- Soyini Madison. D. (2005). *Critical ethnography*. USA: Sage Publications.
- Thomas, J. (1993). *Doing critical ethnography*. USA: Sage Publications.
- Valero, P. (2009). *Mathematics education as a network of social practices*. Keynote at CERME, Lyon.
- Wedege, T. (1999). To know or not to know – mathematics, that is a question of context. *Educational Studies in Mathematics*, 39(1), 205-227.
- Wedege, T. (2010). Sociomathematics: A subject field and a research field. Research paper presented at MES 6 in Berlin. Retrieved 2010 03 29 from <http://www.ewi-psy.fu-berlin.de/>
- Willis, P. & Trondman, M. (2000). Manifesto for ethnography. *Ethnography*. 11(1) 5-16.

Perceived Professional Learning Needs of Numeracy Coaches

Leonie Anstey

*Department of Education and Early
Childhood Education*
anstey.leonie@edumail.vic.gov.au

Barbara Clarke

Monash University
barbara.clarke@education.monash.edu.au

This paper describes part of research conducted with fifteen Numeracy Coaches as they carried out their work supporting teachers in Victorian government schools. There was great variation in the mathematical background of coaches, and this area of the research investigated the changing perception of professional learning priorities to support their work in schools, using questionnaire and interview data. The data indicated that the coaches' priority for mathematics content knowledge and pedagogical content knowledge strengthened over the year of the study.

The *Teaching and Learning Coaches Initiative* was intended to provide assistance to schools to improve student outcomes in mathematics and, in the case of a small number of schools, in science. The initiative was underpinned by the key findings that student achievement is determined to a significant extent by the knowledge and skills of teachers in individual classrooms. (Darling-Hammond, 2000; Wenglinsky, 2000)

In 2007, the DEECD worked extensively with Professor Richard Elmore on evaluating the School Improvement Practices in Victorian Government schools. Elmore (2007) noted that human investment was the strength of the Education System in Victoria and suggested that teachers:

should be given opportunities to develop a cosmopolitan view of their practice, one in which new and powerful ideas about teaching practice are public goods, rather than private practice. They should be exposed to coaching and mentoring others as early as possible in their careers. (p.7)

In the later part of 2007, the Teaching and Learning Coach Initiative (TaLC) was announced to begin in February 2008. The purpose and intention was to provide intensive assistance to identified schools to bring about changes in classroom practices that are necessary to improve student outcomes and build teacher capacity. In particular, the focus was on teacher capacity to establish priorities, analyse student results, measure student progress and improve the quality of learning and teaching. This represented a change in focus for school improvement policy to more direct support of teachers in the classroom and accountability of each of the regions. The data reported in this paper forms part of research conducted with fifteen Numeracy Coaches based in regional Victoria. The specific research question that was explored is: How do mathematics coaches' priorities for professional learning needs grow or change during a one-year period?

The Role of Coaches

Coaches work collaboratively with teachers to build their capacity to improve student learning outcomes. Victorian schools are divided into nine geographical regions and Teaching and Learning Coaches form part of regional school improvement teams. They are allocated to identified schools based on school data and mathematical performance for specified periods of time as determined by regional leaders. The impetus for teacher coaching was based on research that increasing teacher capacity had the most direct impact on improving student achievement (Hattie, 2003).



Coaching is a form of professional development in increasing use by school systems. In Victoria, both the Catholic and Government systems have large scale coaching initiatives. It is argued that it has the potential to have a high impact on classroom practice. Feger, Woleck, and Hickman, (2004, pp. 2-5) found that:

- effective coaching encourages collaborative, reflective practice;
- effective embedded professional learning promotes positive cultural change;
- a focus on content encourages the use of data analysis to inform practice;
- coaching promotes the implementation of learning and reciprocal accountability;
- and
- coaching supports collective, interconnected leadership across a school.

The literature points to three broad categories of skills that an effective coach should possess: pedagogical knowledge, content expertise and interpersonal skills (Steiner & Kowal, 2007).

Teachers in primary schools require a deep understanding of mathematics for teaching and this is a key component in improving student learning outcomes (Hill, Rowan & Ball, 2005). Shulman (1986) discussed the combination of content and pedagogical content knowledge for teaching.

Mere content knowledge is likely to be as useless pedagogically as content-free skill. But to blend properly the two aspects of a teacher's capacities requires that we pay as much attention to the content aspects of teaching as we have recently devoted to the elements of teaching process (p.6)

It is widely accepted that teachers of mathematics require appropriate strength in both content and pedagogical content knowledge. Much of the literature is general, focusing on leadership and relational aspects, with an implicit assumption that the pedagogical content and content knowledge and skills of coaches will be sufficient for the role.

Table 1 presents five categories of learning needs for coaches. These categories emerge from the literature. Examples of relevant authors are given for each category.

Table 1:

Aspects of Coaches' Professional Learning Needs and Related Literature

Categories of learning needs	Literature basis for the selection of the categories including the intended interpretation
Content Knowledge of Mathematics.	"...deep understanding of the content area of the subject for which they are working." (Feger, Woleck & Hickman, 2004, p.4) Teachers' mathematical knowledge was significantly related to student achievement (Hill, Rowan & Ball, 2005)
Instructional Skills of Teaching and Learning	Sound pedagogical practices based on Principles of Learning and Teaching (PoLT) enable coaches to discuss instructional practices and models for explicit teaching and learning. (DEECD, 2006)
Interpersonal Relationship Development	Requires understanding the human states of mind, including verbal and non-verbal references to lead and pace teacher learning. (Costa & Garmston, 2002; Steiner & Kowal, 2007)
Instructional Knowledge as a Coach	Identify and plan for change through focussed inquiry to broaden the basis for work with teachers. "...given the vast amount of information teachers need to assimilate coaches will continually make decisions about whether to introduce something new or support further refinement of a previously explored concept or strategy". (Burkins, 2007, p.107)
Leadership Skills	"Coaches require many approaches to change and need to adapt their methods to be aligned with the goals of the school/teacher/and educational system". (Toll, 2004, p.18)

Methodology

To support the development of skills, knowledge and capacity in mathematics, coaches were invited to take part in monthly mathematics pedagogical content forums, addressing topic areas of fractions and algebra. The basis used was formative data collection and analysis to identify “big ideas” for student learning. Of the 15 coaches, 13 attended these sessions on a regular basis. In addition, coaches attended 16 days of professional development provided at the state level, focusing on both mathematics-specific and general coaching techniques and theory.

The level of mathematics background and experience for the coaches varied considerably from secondary mathematics trained (3 coaches), primary trained (10 coaches) and secondary English (2 coaches). All coaches were asked to complete a survey in March and again in November 2009. From the initial survey results, four coaches were identified for case study analysis and were interviewed in April and October 2009. The selected coaches provided a balance between perceived coaching ability and confidence in mathematics and represented different networks within the region. Two of the selected coaches had a high degree of experience in teacher action research within their school. They were both actively involved in the Project for Enhancing Effective Learning (PEEL) conferences, workgroups and discussion groups. The third coach had experiences across a range of schools including Adult Education and listed primary mathematics as an initial strength. The fourth coach had a strong focus on data analysis and school improvement, working as both the Line Manager for a number of coaches, coaching in one school and regional school accountability.

The data presented in this paper focus on the perceived learning needs of the coaches. At the beginning (March) and end of the research (November) as part of the survey completed by all coaches they were asked to rank the five aspects for their learning or development from the first column in Table 1 in order of personal importance with the following instructions.

Please rank the following aspects for your **own development** as a Teaching and Learning Coach. Rank order the following of 1 as **most important** aspect and 5 being the **least important** aspect of your learning.

Results

Table 2 presents the ranked perceived professional learning needs of the coaches from the survey in March and November, respectively. (The ranking of 1 being their highest professional learning need and 5 being their lowest need).

While the perceived professional learning needs varied considerably across the coaches involved in the study, it can be noted that there was a substantial increase in the learning need for *Content Knowledge of Mathematics*, as evidenced by the lower score. While the focus for their learning through the regional meetings was on content knowledge of mathematics (presented within the context of student learning and pedagogical content knowledge) this seems to have actually increased their awareness of their needs. It could be argued that the more we learn, the more we realise we have to learn.

The variation between coaches in each category was large with all possible ranks represented for each aspect in both collection periods except for *Instructional Knowledge as a Coach* for which only four ranks were represented. This validated the need for more in-depth data collection to help to understand the individual responses.

Table 2:

Rankings of Professional Development Needs (March and November)

	Content Knowledge of Mathematics		Leadership Skills		Interpersonal Relationship Development		Instructional Knowledge as a Coach		Instructional Skills for Teaching and Learning.	
	Mar	Nov	Mar	Nov	Mar	Nov	Mar	Nov	Mar	Nov
A	1	2	4	1	5	5	2	3	3	4
B	1	2	3	3	5	5	2	4	4	1
C	1	3	4	5	5	1	2	2	3	4
D	3	1	2	5	5	3	4	2	1	4
E	5	1	4	5	2	4	1	2	3	3
F	5	1	4	4	3	5	1	2	2	3
G	2	1	4	4	5	5	1	2	3	3
H	2	2	1	1	3	3	4	4	5	5
I	2	2	5	5	2	4	3	1	1	3
J	5	2	3	5	1	1	4	3	2	4
K	4	3	5	5	1	4	3	2	2	1
L	5	5	4	2	1	4	2	1	3	3
M	5	5	1	3	2	1	3	2	4	4
N	5	5	4	1	3	3	1	2	2	4
P	5	5	1	3	2	4	4	2	3	1
Q	5	5	3	3	4	4	2	2	1	1

From the initial interviews, it appeared that coaches were interpreting the categories of *Instructional Skills for Teaching and Learning* in two different ways: as generalised teaching skills and behaviours, or as specific content knowledge of mathematics. To further investigate this task, coaches were asked in the second survey to explain their first and last professional learning need. The coaches that highlighted *Instructional Skills for Teaching and Learning* as their first priority supported their choice with the following statements:

Coach Q: I need to develop the continua of learning in mathematics to be established for level 4, 5 and 6 (Victorian Essential Learning Standards, yr 5-10) and how it extends to finding a problem of practice is a personal learning goal.

Coach P: I believe Professional Development in understanding the pedagogy for teaching mathematics is the most important. As Teaching and Learning Coaches we need to have a clear understanding of the horizontal knowledge of an outcome so we can ask probing questions in our coaching conversations.

These comments would seem to refer to knowledge for teaching mathematics, with elements of both content and pedagogical content, rather than more general instructional skills that were the intention of the category. While we may argue that teachers do not need to understand the nuances of defining their own knowledge and skills, it would seem that for a teaching and learning coach who is required to support the professional learning of others, these distinctions might be better understood. The following example was an explanation for choosing *Instructional Knowledge as a Coach* that also focused on mathematics teaching knowledge:

Coach L: I need to become more confident in sharing with the teachers the "horizontal" knowledge or the steps/gaps which have been identified in the student learning. Being able to identify and lead these for various mathematical concepts to be understood.

When the case study coaches discussed *Content Knowledge of Mathematics* as their professional learning need in October and were asked to elaborate on what aspects of

mathematics teaching they found particularly difficult, three out of four specifically reported fractions, percentages, decimals and ratio questions as their most challenging.

Coach D: ...Teaching and Learning approaches that are specific to core ideas in mathematics are a focus for me. My area of focus is Fractions, decimal, ratio. I have started to understand the big ideas of these, however I have a long way to go, especially in answering questions in context.

These comments by coaches have been somewhat surprising given that coaches were involved in substantial professional learning sessions both at the regional and state level specifically targeting Fractions, Decimals and Ratio. To explore these results further and focus on individual responses, brief summaries of three of the case study teachers synthesised from the interview transcripts are now presented.

Case Studies

The overall results for the case studies are shown in Table 3. The rankings in April and October were based on the card sort.

Table 3:

Case Study Ranking of Professional Development Needs (survey and card sort)

	Content Knowledge of Mathematics				Leadership skills				Interpersonal Relationship Development				Instructional Knowledge as a Coach				Instructional skills for Teaching and Learning.			
	M	A	O	N	M	A	O	N	M	A	O	N	M	A	O	N	M	A	O	N
Kay	2	1	1	2	5	3	2	5	2	4	4	4	3	2	1	1	1	*	3	3
Amy	1	1	2	2	4	1	4	1	5	5	5	5	2	3	3	3	3	2	4	4
Claire	3	1	2	1	2	5	5	5	5	4	4	3	4	3	3	2	1	2	1	4

*Placed along side all

Kay was first appointed as a coach in June 2008, six months into the coach initiative beginning in Victoria. She appeared to hold a strong belief and commitment for teacher action research and she was involved in a number of PEEL projects as a classroom teacher. When Kay first completed the survey in March, she identified development of her strength in *Instructional skills for Teaching and Learning* as the highest rank. A further six weeks into the study saw a shift for Kay. She still ranked the *Instructional Skills for Teaching and Learning* highly, although her greatest need to be a more effective coach was now identified as *Content Knowledge of Mathematics*. She discussed specifically the need to be able to identify confidently what students were doing in mathematics classrooms as an area for her development. She was unable to describe or predict a sequence of mathematics skills that students could display during a mathematics lesson or specific learning task.

Early in the year, Kay started to use demonstration lessons from the professional learning program to illustrate to the teachers she was coaching how mathematics tasks can be scaffolded to allow all students to learn. This form of professional learning gave her opportunity to unpack the mathematics within the learning tasks herself before working with teachers in classrooms. This gave her confidence to predict the mathematics skills that students displayed by what they were able to do, say and write. As the year progressed and Kay further developed her pedagogical content knowledge through using a variety of models and specific learning tasks to meet the learning needs of the teachers and students. She explained that the rich learning tasks she chose to demonstrate were selected to further the teachers' understanding of mathematics. The start of her shift in coaching confidence was to identify and discuss evidence of student learning for some of the "big ideas" in

mathematics. She also identified the use of analogies and a range of models for similar mathematical situations in the demonstration lessons, strengthened and enhanced her coaching conversations with teachers.

The end of the study saw a further shift for Kay in terms of the *Instructional Skills for Teaching and Learning*. Kay explained that her general pedagogy skills could be drawn upon easily, however to be a more effective mathematics coach, this is no longer a priority. An understanding of how all students learn mathematics particularly as the content requirements, learning tasks and mathematical models become more advanced (in Kay's words, above Grade 6 level) limits her ability to coach teachers effectively. Throughout the research, it was questioned if Kay saw herself as the teacher of the children or the coach of teachers. This is one of the many challenges for coaches as they transition from being a classroom teacher to a role as a mathematics coach.

Case study coaches were sent a draft of their summaries and Kay's response supports this coaching challenge:

It was so interesting that you identified the very issue that I think is the biggest challenge to me- that is totally stepping away from the teacher role into the coach role. I think it is because I am so passionate about teachers reflecting on and building good teacher practice, and students really engaging in their learning, that sometime I slip into a teacher role, rather than really meeting the teachers I am coaching where they are at. It is something I am aware of and am working on- a work in progress! I think I am growing into the role of a coach, and that was another reason to push myself a bit more and will take me out of my comfort zone, and hopefully improve my skills as a coach.

Amy was appointed as a teaching and learning coach in June 2008. Her background included teaching across a number of primary schools and also the adult learning sector. She saw her strength as general pedagogy, and in the first interview discussed the limitation of her mathematics: "In literacy, you can get away with pedagogy; in maths you need the content for credibility. I know I have a lot to learn in mathematics. I need to develop the content first before I can develop the effective pedagogies." She saw herself as having teaching skills, but needed to know how to tell teachers what to do without offending them. By the end of the research, Amy discussed the use of data collection and evidence of student learning in mathematics as the basis for coaching teachers.

Amy identified the regional mathematics professional learning programs as an excellent vehicle to develop both her content and pedagogical content knowledge. Amy elaborates that while she was able to solve mathematical problems, she was unable to describe how students could learn mathematical concepts in a variety of ways. The Professional Learning provided her with the models and contexts to open the learning for teachers and students. She perceived her knowledge of lower secondary mathematics as her future goal. "I need to develop my horizontal knowledge at the secondary level. The area of focus for my learning is Fractions, and in particular ratio questions in context." To extend her "horizontal knowledge", Amy enrolled in a Grad Cert of Secondary Mathematics in 2010. She appears to be referring to *knowledge at the mathematical horizon* (Hill, Ball & Schilling, 2008), a concept shared at the regional professional learning sessions.

In the first interview, Amy was unable to describe any coaching structures other than telling teachers what they needed to do. By the end of the research, she had adopted a range of conversation structures, based on the Cognitive Coaching Frameworks (Costa & Carmston, 2004). It would seem that the professional learning program was able to meet Amy's needs in terms of coaching structures and conversations, however her identification of her learning needs for content and pedagogical content knowledge have strengthened.

Claire started in the initiative in a support role to the Student Learning Manager and became the Teaching and Learning Coach manager in January 2009. In March 2009, she began coaching at one of the schools where a coach was unable to continue due to personal reasons. In April, she identified clearly development of *Content Knowledge of Mathematics* as her highest need, though it had been ranked lower in the survey. She answered most questions in her interview in terms of her need to develop her understanding of mathematics content. When asked to elaborate or clarify her focus area, she was unable to do so. “I really need to develop all these. I don’t know what I don’t know.” In the final interview, Claire still considered *Content Knowledge of Mathematics* as a high priority, however she then incorporated content and pedagogical content into the one area. She was also able to identify her next level of learning in Mathematics.

A strong knowledge of mathematics is essential for engaging in debate and rigour to inform the next level of my learning. For me this is around fractions and division. Content knowledge development where I needed and enjoyed the greatest impact on change and challenge that has led to growth. Mathematics subject and pedagogical content continues to be my priority.

At the beginning of the research, when asked to discuss her choice of *Instructional Skills for Teaching and Learning*, she only referred to how to teach mathematics. A shift in November was noted, with Claire discussing teaching and learning models of how students learn “We need to be aware of what will get students, teachers and teams onto the ‘ramp’ (Vygotsky’s Zone of Proximal Development) as the instructional skills for teaching and learning.”

Claire did not see the role as a coach as one of Leadership. She saw her role as using collaboration and shared learning but not leading: “I have deliberately positioned myself as a learner of mathematics. I have used content knowledge building as the basis for my connection to colleagues.”

Conclusion

Many coaches are faced with challenges related to their own content knowledge of mathematics. To lead conceptually-driven conversations with the teachers with whom they are working, they need to be supported to develop their own content and pedagogy skills. Many coaches continued to raise concerns related to their own understanding of content and pedagogical content knowledge of mathematics. As coaches were exposed to classroom coaching experiences and focused professional learning throughout the research period, this seemed to strengthen their goals to further develop their content knowledge in mathematics. It seemed to be a case of “knowing what they didn’t know.”

During the research period, there were changes in the language used by the coaches including pedagogical content knowledge of mathematics, and reference to specific aspects of this, demonstrating an emergence of new understanding of how students learn mathematics. However, most coaches continued to discuss pedagogical content knowledge in isolation from subject content knowledge and were unable to make links between the two.

The finding of this study support the need for coaching initiatives to include a focus on developing knowledge for teaching mathematics, including content and pedagogical content knowledge (Ball, Thames & Phelps, 2008). It is important that coaches have strong mathematics content and pedagogical content knowledge to support teacher development and ultimately achieve the policy imperatives of improving student learning.

References:

- Costa, A., & Garmston, R., (2002). *Cognitive coaching: A foundation for renaissance schools*. Norwood, MA: Christopher-Gordon.
- Ball, D. L., Thames, M. H., & Phelps, G. (2008). Content knowledge for teaching: What makes it special? *Journal of Teacher Education*, 59(5), pp 389-404.
- Burkins, M. (2007). *Coaching for balance*. Newark, DE: International Reading Association.
- Darling-Hammond, L. (2000). Teacher quality and student achievement. *Education Policy Analysis Archives*, 8(1), Retrieved from <http://epaa.asu.edu/article/view/392>
- Department of Education and Early Childhood Development. (2006). *Principles of learning and teaching P-12 Background paper*. Melbourne: Author.
<http://www.eduweb.vic.gov.au/edulibrary/public/teachlearn/student/bgpaper1.pdf> Accessed Jan 26, 2010
- Department of Education and Early Childhood Development (2008). *Blueprint for education and early childhood development*. Department of Education and Early Childhood Development: Victoria, Australia
<http://www.eduweb.vic.gov.au/edulibrary/public/commrel/policy/Blueprint2008/blueprint-final-2008.pdf>
- Elmore, R. (2007). *Educational improvement in Victoria*. Melbourne: Office for Government School Education.
- Feger, S., Woleck, K., & Hickman, P. (2004). How to develop a coaching eye. *Journal of Staff Development* 25(2), 14-18.
- Hattie, J. (October, 2003). *Teachers make a difference: What is the research evidence?* Paper presented at the Australian Council for Educational Research Annual Conference on Building Teacher Quality.
- Hill, H. C., Ball, D. L., & Schilling, S. G. (2008). Unpacking pedagogical content knowledge: Conceptualising and measuring teachers' topic-specific knowledge of students. *Journal for Research in Mathematics Education*, 39 (4), 372-400
- Hill, H. C., Rowan, B., & Ball, D. L. (2005) Effects of teachers' mathematical knowledge for teaching on student achievement. *American Educational Research Journal*, 42, 371-406.
- Shulman, L. S. (1986). Those who understand: Knowledge growth in teaching. *Educational Researcher*, 15(2), 4-14.
- Steiner, L., & Kowal, J. (2007). *Instructional coaching*. Washington DC: Centre for Comprehensive School Reform and Improvement.
- Toll, C. (2004). *The Literacy Coach's survival guide: Essential questions and practical answers*, Newark, DE: International Reading Association.
- Wenglinsky, H. (2000). *How teaching matters: Bringing the classroom back into discussion of teacher quality*. Princeton, MA: Educational Testing Service.

Students' Experiences of Mathematics During the Transition from Primary to Secondary School.

Catherine Attard
University of Western Sydney
<c.attard@uws.edu.au>

As part of a longitudinal case study on engagement in middle years mathematics, 20 students attending their first year of secondary school in Western Sydney were asked to provide views on their experiences of the transition to secondary school in relation to mathematics teaching and learning. Differences in teacher-student relationships caused the most concern due to the decrease in teacher-student interactions and a reliance on computer-generated mathematics lessons. Findings indicate that a strong pedagogical relationship forms the foundation for sustained engagement in mathematics during the middle years.

During the transition from primary to secondary schooling many students experience significant changes in the physical structure, teaching and learning practices, and expectations of school. In an Australian setting, transition to high school occurs when students are aged between 11 and 12, a time when they are experiencing physiological, psychological and social changes associated with adolescence (Downs, 2003; Moroney & Stocks, 2005). Literature suggests difficult transitions can lead to disengagement, negative attitudes towards school, reduced self-confidence, and reduced levels of motivation, particularly in the area of mathematics education (McGee, Ward, Gibbons, & Harlow, 2003). Disengagement in mathematics can lead to reducing the range of higher education courses available to students and can limit their capacity to understand life experiences through a mathematical perspective (Sullivan, Mousley, & Zevenbergen, 2005).

As part of a qualitative longitudinal case study on engagement in mathematics during the middle years (Years 5 to 8 in NSW), a group of 20 Year 6 students from one school were asked to provide their views on mathematics teaching and learning through individual interviews and focus group discussions. When the group began high school, they participated in a sequence of three focus group discussions over the course of the year. This paper is a report of some of the findings of this study. It focuses on the changes encountered by the students in terms of their experiences within the secondary mathematics classroom.

Middle Years, Mathematics and Transition

Factors that have the potential to influence students' engagement in mathematics occur both outside and within the school, and outside and within the mathematics classroom. Although transition to high school can play a major role in influencing engagement, there are additional factors specific to the learning and teaching of mathematics itself that play a critical role. Such factors are curriculum, pedagogy, assessment strategies, social interactions and students' relationships with others. Together with transition, the sometimes negative impacts of these factors are cause for concern. The following is a brief account of current literature pertaining to key issues of transition and mathematics.

Over the last 20 years, research has overwhelmingly documented an increasingly smaller percentage of students pursuing the study of mathematics at upper secondary level and beyond. The choice not to pursue mathematics has been seriously influenced by



students' attitudes towards and performance in mathematics, in turn deeply shaped by school mathematical experiences and the teaching they experienced in school (Nardi & Steward, 2003). Although arguably attitudes change throughout the school years, once formed, negative attitudes towards mathematics are difficult to change and can persist into adult life (Newstead, 1998). Maintaining engagement in mathematics during the middle years may promote more positive attitudes, in turn making the study of mathematics more attractive.

There is a definite decline in school mathematics engagement of many young adolescents when compared with their engagement in primary school (NSW Department of Education and Training, 2005). In addition, increased truancy, greater incidence of disruptive behaviour, alienation and isolation increase in early adolescence (Sullivan, McDonough, & Harrison, 2004). Hill, Holmes-Smith and Rowe (1993) noted that in the middle years, there is a noticeable arrest in the progression of learning observed, with those in the lower decile seeming not to progress academically beyond Year 4 level. Disinterest in mathematics generated by certain pedagogical approaches seems strongly linked with underachievement (Boaler, 1997).

During transition to high school students encounter changes at social, organisational and academic levels. Students preparing to transition from primary school often have preconceived ideas and high expectations of the challenges presented by secondary schools. Many Year 6 students expect the work in Year 7 to be harder, presenting a challenge to some, and anxiety and concern for others (Howard & Johnson, 2004). In an Australian study of students' perceptions of the transition to secondary school by Kirkpatrick (1992), students found the academic work during their first year of secondary school was no harder, or was easier than their final primary year, yet they still had difficulty adjusting to the new academic environment. Although there may be a lack of challenge, the transition to secondary often results in some level of achievement loss, a phenomena not limited to students in Australian schools (McGee et al., 2003).

In addition to the academic issues outlined above, students are faced with significant social changes as they transition to high school. Many students must learn to cope in a much larger school environment where, relative to primary schools, secondary schools are characterised by a greater emphasis on control, more impersonal student/teacher relationships and a greater likelihood of public evaluations of students (Hardy, Bukowski, & Sippola, 2002).

With substantial literature stating social interaction within the classroom is an important contributor to positive learning outcomes it appears mathematics classrooms are sometimes regarded as an exception. The often individualistic nature of mathematics lessons seems extremely unusual, causing some students to view mathematics classrooms as 'other-worldly', with no relationship to their own lives and perhaps no connection to other academic areas (Boaler, 2000). The traditional practices of individualised work in the mathematics classroom discourage meaning, engagement and understanding. "Students within mathematics classrooms regard themselves as a community, whether teachers do or not, and it is antithetical to the notion of any community that it should inhibit communication between participants, and that dominant practices preclude meaning and agency" (p.394).

For adolescents to function positively at school and within society, emotional wellbeing is crucial. Relationships with teachers have a substantial impact on student learning in mathematics in addition to relationships with peers. One of the most obvious differences between primary and secondary school is the amount of time students spend

with their teachers, forming relationships. The *Connecting Through the Middle Years Project* (Henry, Barty, & Tregenza, 2003), found when dealing with students and the ‘drop-out’ syndrome a link was made with ‘connectedness’, referring to the sense of belonging which results in a feeling of well-being.

Although there is an abundance of research into middle-years, mathematics and transition from primary to secondary school, there appears to be a gap in the research with a lack of longitudinal studies set within an Australian context. Another gap seems to be a lack of ‘student voice’ exploring students’ perspectives on mathematics teaching and learning during this time of transition. The goal of this study is to address the current gaps in research and explore students’ perceptions of teaching and learning in mathematics, identifying pedagogies that help sustain engagement, fostering continued study and enjoyment of mathematics.

The Study

It is common for research relating to engagement and mathematics to take a deficit approach towards current practices in classrooms. It was a commitment in this study to take a positive perspective, focussing on identification of what was seen by the participants to be working well or being taught well in the mathematics classrooms involved. A second commitment was to give the participants a voice – something also lacking in current research on student engagement.

The study was carried out at two sites. The initial phase took place during the students’ final year of primary school in a Western Sydney Catholic school. The school had been selected as an appropriate site for the study to begin because it was identified as one in which a large proportion of students gained high achievement levels in the Year 5 Basic Skills Numeracy Test in 2007. A ‘high achieving’ school was purposely chosen due to repeated studies showing moderate to strong correlations between academic achievement and academic self-concept (Barker, Dowson, & McInerney, 2005). It is reasoned students who experience positive academic self-concept in mathematics are more likely to be engaged, and therefore the school was an appropriate setting from which to explore students’ engagement levels as they made the transition to secondary school.

During the second phase of data collection the students attended the second site, a Catholic secondary school, within the same area of Western Sydney. At the time of data collection the school was in its third year of operation and considered itself a ‘groundbreaking’ learning community in which an interdisciplinary approach to learning via an integrated curriculum is delivered. Each student at the school is required to purchase a laptop computer and teachers are known as ‘learning advisors’. Co-teaching occurs in large, purpose-built learning spaces with each learning advisor taking a role in the facilitation of the group. The school population comes from a low to mid socio-economic range with students drawn from a wide range of both catholic and local government schools.

In order to identify prospective participants, the Year 6 cohort of 55 students completed the Motivation and Engagement Scale (High School) with all questions specific to mathematics (Martin, 2008). Twenty students, all of whose results showed strong levels of engagement towards mathematics and intended on attending the same high school, were invited and became participants. The participants represented a diverse range of mathematical abilities, cultural backgrounds, and most came from families with two working parents.

In the first phase of data collection participants took part in individual interviews before taking part in focus group discussions, which took place once during Year 6, and three times during Year 7. The following discussion points/questions were used as a starting point for each meeting: (a) Tell me about school; (b) Let's talk about maths; (c) Tell me about a fun maths lesson that you remember well; (d) When it was fun, what was the teacher doing?; and (e) What do people you know say about maths? Other data were collected through series of classroom observations of two teacher students had identified as 'good' mathematics teachers, and interviews with each of those teachers.

The data gathered were transcribed and analysed using NVivo software as a tool to assist coding into themes. In terms of the most significant changes and issues affecting the students through their transition to secondary school, two broad themes emerged: differences in pedagogy from primary to secondary; and changes in teacher-student relationships. Representative excerpts from the data will be used to illustrate the two themes in the following section.

Results and Discussion

Differences in Pedagogy

The changes in pedagogy experienced by the participants will be discussed in terms of mathematics content, teaching practices, workload, assessment practices, integration, and the use of Information and Computer Technologies (ICTs). Over the course of their first year at high school the students' attitudes towards mathematics and their teachers evolved as they began to settle in to their new school environment.

Consistent with existing literature, the students found most of the content in Year 7 very similar to that in Year 6 (Kirkpatrick, 1992).

... basically it's just primary work but they're just making it like that step harder. Like, ... , we did polygons the other day, we did polygons from primary but then they gave us harder ones. (Year 7 boy, Term 2)

Although the content itself did not present as a challenge, students did find the presentation of the content and the volume of work expected of them was demanding.

I find it much more up front and demanding this year. And last year, they'd give you time until you understand it. That's what I like about last year. (Year 7 girl, Term 1)

From the beginning of Year 7 the students noticed a change in the pace of the mathematics lessons compared to the pace of primary school. This continued during Term 2, as the students felt pressure to complete work within a limited time frame, and although they claim they were familiar with the content, this appeared to have had a negative effect on their engagement in mathematics.

... people are complaining about the teachers and when work is due and I think it's ridiculous how fast it's got to be done and stuff. (Year 7 girl, Term 2)

As the students progressed through the year, the students became less concerned over the workload, and more concerned over the amount of assessments they were required to complete. This finding is consistent with literature that states the assessment practices in secondary school are quite different to those in primary, are more competitive and norm-referenced, resulting in lower engagement (Martin, 2006).

... there's so many assessments. (Year 7 girl, Term 2)

The only kind of maths we do is assessments... I guess that's what makes maths a bit boring 'cause there's no excitement. (Year 7 girl, Term 4)

At the beginning of Year 7, the main methods of assessment were either traditional pen and paper tests or computer-based tests at the end of each topic. This changed as the year progressed, so that by Term 4 the students were exposed to a slightly wider variety of assessments in which they appeared to be much more engaged. One assessment that the students particularly enjoyed incorporated the use of technology to create a movie. The assessment required students to create a 'How to Do It' movie on geometrical constructions.

It's pretty good... considering it's a maths assessment task. Usually they're not too fun, and nobody's looking forward to them, but I'm actually pretty excited. (Year 7 boy, Term 4)

When interviewed, the teacher identified by the students as the 'best' mathematics teacher at the school, spoke about this particular assessment.

It's a move away from very traditional topic tests at the end, it's not logical. We've got to account for lots of different learning styles and different assessment strategies to enable the different types of learners to have a fair chance of showing us what they know. (Year 7 mathematics teacher)

The 'hands on' approach that engaged the students in the 'How to Do It' assessment task was one aspect of primary school teaching and learning they appeared to miss in their high school mathematics lessons. Although the students commented on how much they enjoyed being more independent, they still craved the use of concrete materials and 'hands-on' practical activities in their mathematics lessons. In direct contrast to their primary school experiences, during the first term the students were confronted with a purely computer-based experience as the basis of all their mathematics lessons. In addition to using a traditional textbook, the school provided a subscription to an on-line commercial mathematics site that included a comprehensive program of lessons, worksheets, interactive animations, step-by-step instructions, assessment activities and feedback. Although initially the students were engaged in the computer activities this was likely due to the novelty of having brand new laptops and a degree of freedom to work at their own pace. Unfortunately the dependence on the program for full, 100-minute mathematics lessons, and a lack of other pedagogies during that time saw the students quickly become disengaged with their mathematics learning.

I think I liked it better when we could do hands-on stuff... with the (commercial site) it's kind of like you can sometimes get the same problem over and over again 'cause it's like the Internet... (Year 7 boy, Term 1)

A lack of interaction with teaching staff and an over-use or mis-use of computer technology initially had a negative impact on the students' engagement in mathematics during the first months of high school. However, things did improve for the students so that by the end of Term 2, lessons were no longer based purely on the computer mathematics program and the computers were being used in a more flexible manner. In addition, some lessons involved hands-on activities. It is not known whether the change in pedagogy was implemented as a result of student feedback.

I'm enjoying maths... we can use computers in this program called Sketchup to make three dimensional shapes. It's fun. (Year 7 boy, Term 2)

One of my favourite lessons was when we got all the straws and had to build a 3D shape... (Year 7 boy, Term 2)

The tasks that the students found engaging were those that were derived from the interdisciplinary Programs of Study. The integration of mathematics with other key learning areas was found to engage the students yet some felt they still needed mathematics lessons that were focussed only on the mathematics content.

The different pedagogies experienced by the students during transition to secondary school had some effect on their engagement in mathematics causing their attitudes to fluctuate throughout the year but surprisingly, pedagogy was not the most influential factor effecting the student's engagement. The relationships between teachers and students proved to be a stronger influence on engagement in mathematics.

Teacher-Student Relationships

The relationships students experienced in the mathematics classroom changed dramatically for the participants as they made the transition to secondary school. Coming from a school where they were expected to work cooperatively, the students were initially faced with working on an individual basis. The students' reactions are consistent with the findings of Boaler (2000), who noted that because of the often individualistic nature of mathematics lessons, some students come to view mathematics as 'other-worldly', having little relationship to their own lives.

I learnt a lot more in maths when we were doing that cooperative learning. Yeah, but it's more individual here. (Year 7 boy, Term 1)

It's better if you can communicate with people 'cause then you can explain stuff better to each other rather than by yourself. You can sort of get off task. (Year 7 boy, Term 1)

Over the course of the year the students continued most of their mathematics work on an individual basis but they seemed to become accustomed to this. However, they did express some concerns over the amount of interaction between themselves and their teachers. It should be noted at this point that in addition to coming to terms with having different teachers for different subjects, the participants were faced with a rotation of teachers during their mathematics lessons. This seemed to have a negative effect on the students as some of the teachers were not trained in mathematics and found it difficult to explain mathematical concepts to the students. The strong teacher-student relationships the participants had experienced in primary school were vastly different to what they were experiencing in secondary school.

The thing is at times when we're trying to get help from the teachers they're not sure how to figure it out. (Year 7 boy, Term 1)

Well, there's no student-teacher connection. He ends up... calling out the answers... he keeps going through so he's not teaching us anything. (Year 7 girl, Term 2)

Despite the experiences causing students to become disengaged in mathematics, the students discussed a teacher whom they considered to be the 'best' mathematics teacher in the school.

When Mr. S. was teaching us I really understood fractions more than I did before with other teachers because he really can simplify it if you don't get it. (Year 7 girl, Term 4)

He always walks you through step-by-step on how to do it and he gives you homework but he doesn't overload you with homework and he doesn't make you rush. (Year 7 boy, Term 4)

The particular teacher appeared to have formed positive relationships with the students and attributes discussed by almost all of the students were his ability to explain things well, his sense of humour and his ability to make mathematics lessons interesting.

Unfortunately, due to the structure of the school, the students did not have access to this particular teacher for every mathematics lesson.

During their final focus group meeting in Term 4, the students were asked if their attitudes towards mathematics had changed since leaving primary school. The students' responses were mixed with many of them claiming they still enjoyed mathematics and realised how important mathematics is to their futures at school and beyond.

Implications

Although the students reported changes in their mathematics teaching and learning experiences that resulted in fluctuations to their engagement, it is important to note that there were many positive aspects of their experiences that should be focussed upon. Many of the negative aspects such as the individual work and a lack of hands-on activities have already been documented in literature. It is the positive aspects that should be highlighted if any future improvements are to take place.

Initially the students were highly engaged when working on computers each day. This did not continue because of the limited way the computers were used. As they began to be used differently, students began to re-engage with mathematics. Further studies into the use of computer technology in the mathematics classroom would be beneficial.

The issue of having several mathematics teachers may be limited to this particular school and does not necessarily have to be a cause of disengagement if the teachers work on building relationships with the students. However, a positive pedagogical relationship includes a strong knowledge of how students learn and a strong content knowledge. If teachers are not trained in mathematics, this may not always occur. It can be argued the apparent lack of appropriately qualified mathematics teachers could be a result of students' disengagement in mathematics with fewer students choosing to continue its study, and it seems there is a cycle developing which warrants further investigation.

The data suggest the use of more hands-on activities and concrete materials is something that should continue during the middle years when students are still making the transition from a concrete-manipulative state to abstract thought. Although the structure of secondary school timetables makes the provision of such activities more difficult for teachers, it is probable that incorporation of such pedagogies would be of benefit during the middle years. Liaison with primary school teachers would assist with this.

Above all, the pedagogical relationship between students and teachers appears to have had a vast effect on this group of students' engagement in mathematics. Although some of the pedagogies these students experienced were not considered 'best practice', it appears they were able to overcome this where it was difficult for them to overcome the lack of positive interactions with some teachers.

It is proposed that regardless of the school context, students in the middle years have a need for positive teacher-student and student-student relationships as a foundation for engagement in mathematics. This relationship is built on an understanding of students and their learning needs. Unless such a relationship exists, other factors such as pedagogy and content knowledge may not sustain engagement in mathematics during the middle years.

Although this study is limited by the selective nature of the sample, it can be argued the impacts of transition, pedagogy and teacher-student relationships may have implications for different student groups. Repetition of the study in different contexts and further investigation of factors affecting engagement during the transition years would be of benefit in helping students maintain engagement in mathematics during the secondary years and beyond.

References

- Barker, K., Dowson, M., & McInerney, D. M. (2005). *Effects between motivational goals, academic self-concept and academic achievement: What is the causal ordering?* Paper presented at the Australian Association of Educational Research (AARE).
- Boaler, J. (1997). Setting, social class and survival of the quickest. *British Educational Research Journal*, 23(5), 575-595.
- Boaler, J. (2000). Mathematics from another world: Traditional communities and the alienation of learners. *Journal of Mathematical Behavior*, 18(4), 379-397.
- Downs, J. (2003). *Self-concept during the transition to secondary school: Turmoil or normative adjustment?* Paper presented at the Australian Association for Research in Education (AARE) Conference/New Zealand Association for Research in Education (NZARE) Conference.
- Hardy, C. L., Bukowski, W., & Sippola, L. K. (2002). Stability and change in peer relationships during the transition to middle-level school. *The Journal of Early Adolescence*, 22(2), 117-142.
- Henry, J., Barty, K., & Tregenza, K. (2003). *Connecting through the middle years: Phase two evaluation report*. Melbourne: State Government Victoria Department of Education and Training.
- Hill, P. W., Holmes-Smith, P., & Rowe, K. (1993). *School and teacher effectiveness in Victoria: Key findings from Phase 1 of the Victorian Quality Schools Project*. Melbourne: Centre for Applied Educational Research.
- Howard, S., & Johnson, B. (2004). *Transition from primary to secondary school: Possibilities and paradoxes*. Paper presented at the Australian Association for Research in Education.
- Kirkpatrick, D. (1992). *Students' perceptions of the transition from primary to secondary school*. Paper presented at the Australian Association for Research in Education/New Zealand Association for Educational Research joint conference.
- Martin, A. J. (2006). The relationship between teachers' perceptions of student motivation and engagement and teachers' enjoyment of and confidence in teaching. *Asia-Pacific Journal of Teacher Education*, 34(1), 73-93.
- Martin, A. J. (2008). *Motivation and Engagement Scale: High School (MES-HS) Test User Manual*. Sydney: Lifelong Achievement Group.
- McGee, C., Ward, R., Gibbons, J., & Harlow, A. (2003). *Transition to secondary school: A literature review*. Ministry of Education, New Zealand.
- Moroney, W., & Stocks, C. (Eds.). (2005). *Quality mathematics in the middle years*. Adelaide, S.A.: AAMT.
- Nardi, E., & Steward, S. (2003). Is mathematics T.I.R.E.D? A profile of quiet disaffection in the secondary mathematics classroom. *British Educational Research Journal*, 29(3), 345-367
- Newstead, J. (1998). Aspects of children's mathematics anxiety. *Educational Studies in Mathematics*, 36(1), 53-71.
- NSW Department of Education and Training. (2005). Students - middle years. Retrieved July 5, 2005, from http://www.det.nsw.edu.au/reviews/futuresproject/issuespapers/stdnt_middle.htm
- Sullivan, P., McDonough, A., & Harrison, R. T. (2004). *Students' perceptions of factors contributing to successful participation in mathematics*. Paper presented at the 28th Conference of the International Group for the Psychology of Mathematics Education.
- Sullivan, P., Mousley, J., & Zevenbergen, R. (2005). Increasing access to mathematical thinking. *The Australian Mathematical Society Gazette*, 32(2), 105-109.

Percentages: The Effect of Problem Structure, Number Complexity and Calculation Format

Wendy Baratta

University of Melbourne
<barattaw@unimelb.edu.au>

Beth Price

University of Melbourne
<priceb@unimelb.edu.au>

Kaye Stacey

University of Melbourne
<k.stacey@unimelb.edu.au>

Vicki Steinle

University of Melbourne
<v.steinle@unimelb.edu.au>

Eugene Gvozdenko

University of Melbourne
<eugeneg@unimelb.edu.au>

This study reports how the difficulty of simple worded percentage problems is affected by the problem structure and the complexity of the numbers involved. We also investigate which methods students know. Results from 677 Year 8 and 9 students are reported. Overall the results indicate that more attention needs to be given to this important topic. Simple unit fraction equivalents seem to be emphasised, at the expense of fundamental definition (“out of a hundred”) and apparently easy percentages such as 30%. The draft National Curriculum gives better guidance on the variation amongst percentage problems.

With a strong presence in the real world, percentage is a valuable topic in the school mathematics curriculum. Percentages are the method of choice for expressing fractional quantities in many real world applications, yet they are part of the mathematical world of proportional reasoning and so, as many studies have confirmed, they present challenges to learners (Cole & Weissenfluh, 1974; Parker & Leinhardt, 1995; Smart, 1980). This paper reports some findings related to Year 8 and 9 students’ knowledge of this topic.

The questions examined in this paper are part of those being developed for an online diagnostic tool (www.smartvic.com) for probing the mathematics understanding of students. Descriptions are given by Price et al (2009) and Stacey et al (2009). The intention is that these ‘smart tests’ (Specific Mathematics Assessments that Reveal Thinking) will provide quick information to teachers on the extent and nature of understanding in their class and the prevalence of misconceptions about specific topics. Accompanying the results, which are available to teachers instantaneously, there is a description of the developmental stages, teaching suggestions and links to other resources. In addition to helping teachers with specific classes, the accompanying information is intended to increase the mathematical pedagogical content knowledge of the teachers using the tests. Note that the smart tests are unrelated to the author Smart(1980) above.

For most students, teaching about percentage spreads from the later years of primary school to Year 10. Percents are an everyday way of expressing fractional parts (e.g. I got 62% for Chemistry) with the advantage of easy comparison, and they are also the usual way of expressing multiplicative comparison and change (The price went up by 5%, this medicine reduces your chance of getting sick by 10%), relationships which are difficult to express otherwise. Four broad areas are assessed in the current version of the smart tests:

- **Relative size and equivalence:** use percentage to describe relative size (e.g. select which beaker is 68% full, describe a tree as about 50% taller than another) and link percents with fraction and decimal equivalents
- **Constant-whole calculations:** solve one-step problems of three types - find-part (e.g. 25% of 20 is x), find-percent (e.g. 5 of 20 is $x\%$) and find-whole (e.g. 25% of x is 5)?



- **Varying-whole calculations:** solve problems where the ‘whole’ varies (e.g. find that 10% of 20% of a quantity is 2% of it – first the initial quantity is the ‘whole’ and for in the second part 20% of it is the temporary ‘whole’)
- **Adding percent is multiplying:** identify adding a percent with multiplying (e.g. add 3% by multiplying by 1.03; repeated adding of 3% is multiplying by powers of 1.03)

The Victorian Essential Learning Standards (2008) for the compulsory years of school specifically mentions percent at only a few points. The Number dimension specifies “relative size and equivalence” ideas: finding equivalences such as $\frac{3}{4} = 0.75 = 75\% = 3 : 4$ at level 4 and extends to ratios such as $2 : 3 = 4 : 6 = 40\% : 60\%$ (sic) at level 5. Two other dimensions make mention of percentage, both of which are ‘find-percent’ problems from the constant-whole calculations above. A supplementary part of VELS (Progression Point Examples in Mathematics) includes work from all four areas above and therefore goes further than VELS, presumably with appreciation of the many real world problems that relate to percentage. Textbooks also generally go further than VELS. A survey of six current textbooks showed that all covered find-part and find-percent problems, and half of the Year 8 textbooks included find-whole problems, sometimes as extension work and mainly done by the unitary method, written as a series of separate steps.

This paper gives the results from a study trialling the percentage items. The main aim is to report on the degree of mastery shown by middle secondary students and how this is affected by problem structure, number complexity and calculation format (defined below). We report only on the second of the four broad areas above (constant-whole calculations).

Literature Review

Ashlock, Johnston, Wilson, and Jones (1983) cited in Dole, Cooper, Baturo, and Conoplia (1997) observed that there are three different problem structures amongst the constant-whole percent situations, which we label ‘find-part’, ‘find-percent’ and ‘find-whole’ (examples above). Dole et al (1997), reporting a study of 18 students in Years 8, 9 and 10 after screening 90 students, classified them at three levels. Their classification system implies that find-part problems are easier than the other two problem structures. In this study, we will report on the relative difficulty of the three problem structures.

Dole et al (1997) found that only students able to solve all three types could identify these different types of percentage questions, analyse them in terms of their meaning and predict the operation to be used as well as the size of the answers relative to the other numbers given. Students only able to solve find-part problems were reliant on formulas and, if they forgot them, resorted to trial and error. They were able to predict the value of the answer but unable to construct strategies to calculate them.

Koay (1998) investigated the understanding of percentages of pre-service primary teachers in two Singapore teacher education courses. The “find-part” problem (find 75% of 160) was done correctly by 98% of the 224 students, with about 90% of them showing a fraction calculation. The “find-percent” problem (what % is 7 of 28?) was of intermediate difficulty and the most common error was to calculate $\frac{7}{100} \times 28$. The find-whole problem (40 is 80% of what number?) was the most difficult with a facility (percent correct) of 85%. No students used a fraction or decimal calculation (dividing by 0.8 or by 80/100) but instead they used unitary, ratio or algebra methods. Koay concluded that knowledge of percent was often rigid and rule-bound, even amongst pre-service teachers. She recommended that greater understanding of percent would arise from teaching using better visual models and using more real life examples. Significantly, more than a third of the

students were unable to give a second method to solve the problem. In this study, we report on the calculation methods that students are able to use to solve percentage problems.

As well as the ubiquitous difficulties with proportional reasoning, some specific features affect the difficulty of percent problems. VELs emphasises common fractions and known benchmarks, which indicates that number type is a factor and this will be tested in this study. Another factor affecting the difficulty of “find the whole” problems especially is the well known and persistent ‘MMBDMS’ (Multiplication Makes Bigger, Division Makes Smaller) misconception (Bell, Swan & Taylor, 1981). Many students will choose to divide rather than multiply (and vice versa) in problems where the divisor or multiplier is a number between 0 and 1. This is because students associate multiplication with making numbers larger and division with making smaller. In our study students are required to identify which calculations could compute the whole when 11% is 145. The MMBDMS misconception could cause them to reject $145 \div 0.11$. Possibly in order to avoid the MMBDMS misconception, three of the six surveyed textbooks did not find-whole by division of the decimal or fraction, but used the unitary method.

There are several sources of data on students’ success with percent problems of the constant-whole type. Ryan and Williams (1997) found that 38% of 14 year olds were able to compute the percentage remaining when 60 books were taken from 80. 31% of students gave the answer 20, rather than 20%. This “% sign ignored” misconception was common across contexts. The facility for a variety of find-part and find-percent problems varied from 15% and 49%. “Percent means divide” was another misconception, when, for example, students calculate 24 out of 500 by finding $500 \div 24$.

Method

Participants and Procedure

The data reported in this paper comes from four secondary schools in Victoria, representing a range of socio-economic backgrounds. The testing took place in Term 3 of 2008; at this time, some Year 7 students and all Year 8 students from the four schools were tested and all Year 9 students at three schools. Only students who returned consent forms (57% over the whole project) are included in this analysis. The normal classroom teacher took their complete class into a computer laboratory for the duration of a normal lesson for the test. An on-screen calculator was available. There were many items in the tests across all strands of the mathematics curriculum, and three different test versions were used, to reduce copying, and to vary the order of items. This data was being collected to trial and calibrate the smart tests. From this data, we have extracted two large subgroups to report on percentage: 342 Year 8 students who answered at least one question of the three multi-question items labelled #363, #370 and #377 and 335 Year 9 students who answered at least one question of the three multi-question items labelled #62, #63, #64.

Problem Structure and Number Complexity

The Year 9 students completed constructed response items covering the three problem structures above; find-part (#62), find-percent (#63) and find-whole (#64). These three items were provided as word problems with multiple questions, each question having a different number complexity. The levels of number complexity used were *definition* – relying only on an understanding that percent means “out of a hundred”; *simple* – using percentages equivalent to unit fraction with denominator a small factor of 100 (e.g. 2, 4, 5,

10); *medium* – using percentages with well known non-unit fraction equivalents (e.g. denominators of 5, 10, 8); and *hard* – using difficult numbers so that a calculator is required to produce an answer. For example, the question: *A bookcase has 100 books. 7% are picture-books. How many picture-books are there?* (#62A) is a *find-part* question with *definition* level number complexity. Table 1 summarises the items.

Table 1

Summary of Problem Structure and Number Complexity (#62, #63 and #64)

Number Complexity	Problem Structure		
	Find-part #62	Find-percent #63	Find-whole #64
A) Definition	7% of 100	29 out of 100	1% is 3
B) Simple	25% of 40	15 out of 30	10% is 4
C) Medium	30% of 60	35 out of 40	80% is 12
D) Hard	13.5% of 1294	78.85 out of 95	87% is 163

Problem Structure and Calculation Format

The Year 8 students completed three multiple-question, multiple choice items which examined the types of calculations that they recognise as solving a percentage problem (#363, #370, #377). All of these items are of *hard* number complexity. Since calculation methods depend to a large extent on the type of number being used, the calculation formats are classified as fraction, decimal and whole number.

Figure 1 shows the find-whole item #370 (145 is 11% of x). Part (a) is a multiple choice estimation question designed to prompt students to think carefully about the problem. This estimation was not included in the other problem structure items (#363, #377). In part (b) students were required to select one of the multiple choices (*right*, *wrong* or *not sure*) from a drop down box for each of the six calculations provided. Note that they did not need to actually perform any of these calculations. These six calculations have been created in three pairs (one right and one wrong calculation) in three different formats.

<p>a) Tom’s class won 145 lollies at the quiz. This was 11% of the lollies. The total number of lollies at the quiz is:</p> <p>(a) Less than 145</p> <p>(b) About 145</p> <p>(c) About 300</p> <p>(d) More than 1000</p>	<p>b) Which of these calculations will find how many lollies at the quiz?</p> <p>i) 145×0.11</p> <p>ii) $145 \div 0.11$</p> <p>iii) $(145 \div 11) \times 100$</p> <p>iv) $\frac{11}{100} \times \frac{145}{1}$</p> <p>v) $145 - 11$</p> <p>vi) $\frac{145}{11} \times \frac{100}{1}$</p>
--	--

Figure 1. Item #370 (find-whole), showing a) estimation question and b) calculation format questions.

We use the terms *right* / *wrong* to describe questions (so (i) is a wrong calculation) and *correct* / *incorrect* to describe students (so a student who rejects (i) is correct on that question). Calculation (iii) is a right calculation and a student who accepts it is correct, whereas a student who rejects it is incorrect. Calculation (iii) reflects the thinking behind the unitary method. Note that decimal calculation format is logically impossible for find-percent calculations. The complete set of items is given later in Figure 3 with the results. Note that all fraction formatting in the test was done correctly with multi-line formatting.

Results and Discussion

Problem Structure and Number Complexity (items #62, #63 and #64)

Figure 2 provides the facility (percent correct) for Year 9 students on items investigating the effect of problem structure and number complexity. The facilities are generally in the order find-part (#62) (which Dole et al (1997) and Koay (1998) found easiest) then find-percent (#63) then find-whole (#64). With the exception of #62B (with answer 50%), as the number complexity increases, the facilities decrease. The broad pattern is consistent with previous studies such as Koay (1998).

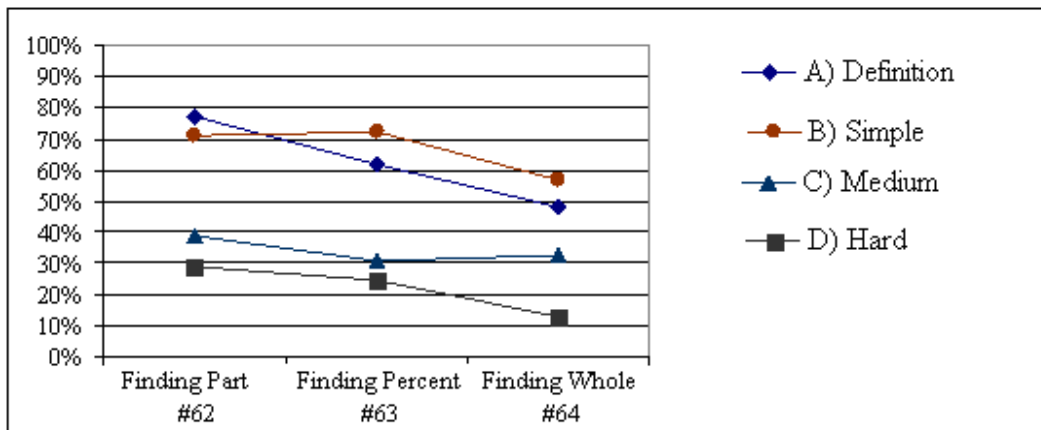

Figure 2. Facility of 335 Year 9 students on problem structure vs number complexity questions.

We discuss several features. First the facilities are very much lower than desirable for a topic central to basic numeracy. With very simple, highly readable, worded contexts, only 62% of students knew that 29 out of 100 is 29% (#63A) and only 39% could find 30% of 60 (#62C). The other feature is that, broadly speaking, the results show that questions with *definition* and *simple* number complexity are of similar difficulty (the top two lines in Figure 2). The similarity of facility for the *definition* and *simple* questions raises the possibility that instruction is emphasising the simple fraction equivalents (half, quarter) even more than the fact that percent is “out of a hundred”. This possibility is consistent with our reading of VELs.

The similarity of facility of *medium* and *hard* number complexity questions demonstrates that students regard only a small range of fractions (and equivalents) as familiar. For example, we had expected that finding 30% of 60 could be handled by many students mentally (10% is 6, so 30% is 18) but the facility (39%) of this question is very close to the facility (29%) for of the difficult number question. Given the usefulness of being able to carry out calculations such as 30% of 60 mentally, this result is of concern.

Problem Structure and Calculation Format (items #363, #370, #377)

Figure 3 shows graphically the results for the questions where the Year 8 students ($N = 342$) had to decide if given calculation methods were right. Students were not asked to do the calculation, although some may have checked calculations by doing them. The percentage of responses that were blank was similar across all questions (range of 5% to 10%), so the reasons for not answering seem not greatly affected by question type or

difficulty. The percentage of responses that were ‘not sure’ were reasonably similar across all questions (range of 6% to 19%), although (as may be expected) there is a moderate trend ($r = 0.45$) for more students to be unsure on questions with lower facility, which indicates that the option of choosing “not sure” is being used as intended. The find-part questions were best done (average facility of 54%) and the find-percent and find-whole questions had equal average facility (44%), but this reflects both the range of choices offered as well as the problem structure. The wrong choices 145 – 11 and 87 – 19, for example, were easy to reject and were only offered in the find-percent and find-whole categories. As can be seen from patterns in Figure 3, students were more frequently correct with (rejecting) wrong calculations (54% on average) than with (accepting) right calculations (36% on average). The average facility on the three calculation formats (decimal, fraction, whole number) was approximately the same (45% - 50%).

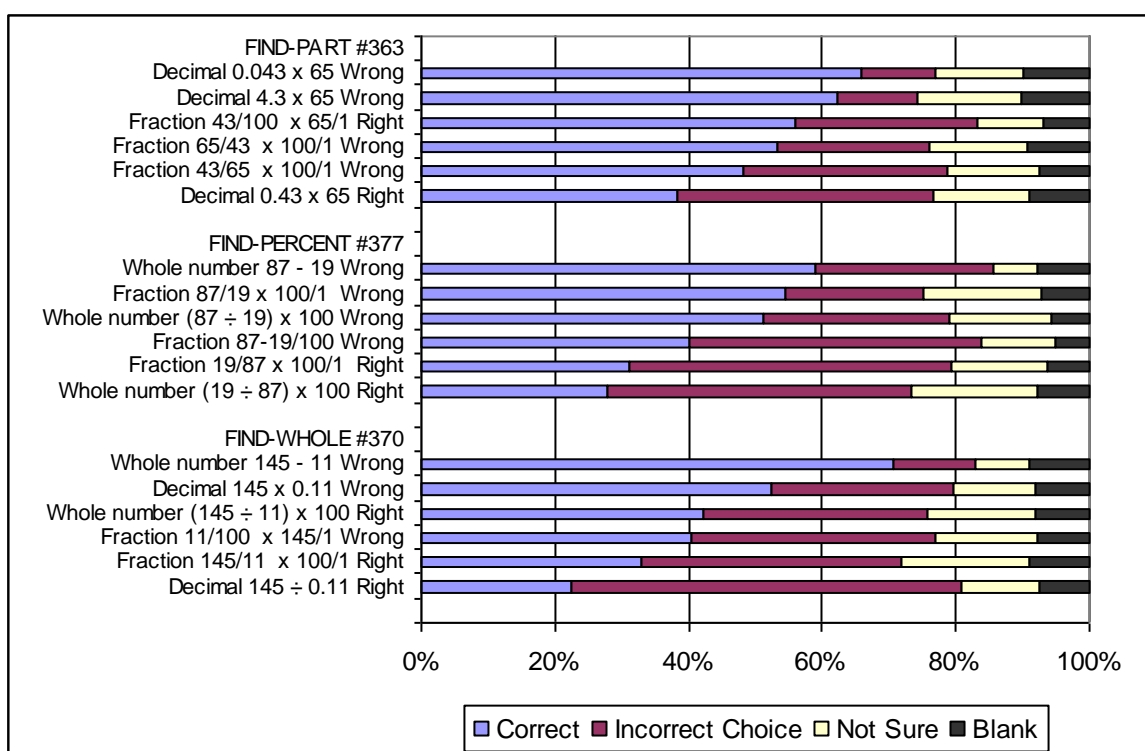

Figure 3. Percent of 342 Year 8 students giving each response by calculation formats.

Looking more closely at individual questions in the find-part item (#363) shows that the right fraction calculation ($\frac{43}{65} \times \frac{100}{1}$) was accepted relatively well (56% correct) and considerably better than the right decimal calculation with only 38% accepting 0.43×65 . This is also the case for the other comparison of right decimal and fraction calculations (find-whole). It is somewhat surprising that 30 years after “five dollar” four function calculators became available to everyone in Australia it appears that fraction methods for percent questions still dominate over decimal methods in schools. This is confirmed in the textbooks.

The most difficult question was the right, find-whole, decimal question ($145 \div 0.11$), which involves division by a number less than 1 to give a larger answer. It is likely that the MMBDMS misconception makes this question especially difficult. Division by a number

less than 1 is not evident in other calculation formats. The right, find-whole, whole number calculation $(145 \div 11) \times 100$ was relatively very well done; this may be because it reflects the steps of the unitary method. Our modest survey of Year 8 textbooks indicated that the unitary method was the method most commonly taught for find-whole questions, but the method is taught as a series of steps, rather than as one calculation, so students have done well to recognise it in the compound calculation offered in the item.

Koay's observation that many of her students did not know more than one method for solving a percentage problem is also probably influencing the data in these questions, although the effect cannot be measured. Students who believe there is only one way to do a calculation may reject others without examination after finding one that is right. Even though the choice "right / wrong / unsure" was placed alongside each question, it is also possible that a few students thought that there would be only one right answer in the batch of calculations as in a typical multiple choice question.

Finally, it is also interesting to compare the accuracy of the estimation in item #370 (see Figure 1) with the calculations chosen. The correct answer (over 1000) was chosen by 56% of the Year 8 students, so that it is easier than nearly all of the calculation format questions. The group of students who estimated correctly was no better at selecting the calculations correctly. For example, 15% of correct estimators accepted the right decimal calculation $(145 \div 0.11)$ and rejected the wrong one (145×0.11) compared to 17% of incorrect estimators. This is consistent with Dole et al (1997) who found most students were able to predict the expected answer of a percentage problem but did not or could not use this to guide their calculations.

Implications and Conclusion

As noted in the discussion above, the facilities of the percent items in almost all categories were low. The analysis of the students who omitted answers indicates that students took the test seriously. The problems were straightforward, with simple wording, clear layout and no extra data. The results are concerning, given the real world importance of percent. Moreover, the problems reported in this paper are only in the second of the four areas of percentage problems that should be part of the curriculum. Problems from the (harder) third and fourth types are also of importance in the business world. Both problem structure and number complexity were contributed to difficulty. The difficulty that students had with problems involving 100% directly (definition-level complexity) and with medium-level percentages (e.g. 30%) was very surprising. The fraction method for the find-part calculation $(\frac{43}{65} \times \frac{100}{1})$ was the only right method that was correctly recognised by over 50% of students. Right decimal methods were generally not recognised. This probably reflects the continuing dominance of fraction methods in textbooks, which is surprising given that they are not so simple to implement on a calculator or spreadsheet.

To improve the teaching of percentage may need more emphasis in the curriculum (see below), better teaching methods and a review of the methods being taught. Although we have no hard evidence, our experience is that it is very effective to use the dual number line (DEECD, no date) as a graphic organiser for (nearly) all types of proportional reasoning problems, including the constant-whole percentage problems. Additionally, it may be worthwhile to review the methods being taught to solve percent problems. For example rather than teaching separate methods for each problem structure, students could start with a formula that applies across problem structures.

In our opinion, the VELS (2008) statements do not describe an adequate level of mastery of percent. Finding parts, percents and 'the whole' are all common problems,

encountered in the course of everyday and business life. A common find-whole problem, for example, is to find the cost before GST of something which costs \$25 after 10% GST has been added. All four areas of percentage knowledge as outlined in the introduction and certainly all three problem structures for the constant-whole calculations should be part of a rounded mathematics curriculum. The draft National Curriculum (ACARA, 2010) has better coverage than VELS, specifically including in the elaborations find-part, find-percent and find-whole problems, as well as varying-percent calculations and examples (such as compound interest and population decay) which require knowledge of the fourth part of percentage knowledge, that adding a percent is the same as multiplying. We hope that clearer expectations may assist in giving students the opportunity to develop better knowledge of this important part of mathematical literacy.

Acknowledgements

This work is part of LP0882176 Australian Research Council project with Department of Education and Early Childhood Development (Victoria). We thank teachers and students.

References

- Ashlock, R., Johnston, M., Wilson, J., & Jones, W. (1993). *Guiding each child's learning of mathematics: A diagnostic approach to instruction*. Columbus, OH: Charles E. Merrill.
- Australian Curriculum, Assessment and Reporting Authority. (2010) *Australian Curriculum Mathematics. Draft Consultation Version 1.0*. Retrieved 2 March 2010 from <http://www.acara.edu.au>
- Bell, A., Swan, M., & Taylor, M. (1981). Choice of operation in verbal problems with decimal numbers. *Educational Studies in Mathematics*, 12(3), 399-420.
- Cole, B. & Weissenfluh, H. (1974). An analysis of teaching percentages. *Arithmetic Teacher*. 21, 226- 228.
- Department of Education and Early Childhood Development (no date) Mathematics Developmental Continuum. Solving Percent Problems. Retrieved 2 March 2010 from <http://www.education.vic.gov.au/studentlearning/teachingresources/maths/mathscontinuum/default.htm>
- Dole, S., Cooper, T., Batur, A., & Conoplia, Z. (1997). Year 8, 9 and 10 students' understanding and access of percent knowledge. In F. Biddulph & K. Carr (Eds.) *People in mathematics education* (Proceedings of the 20th Annual Conference of the Mathematics Education Research Group of Australasia). Rotorua, New Zealand: MERGA.
- Koay, P.L. (1998). The knowledge of percent of pre-service teachers. *Mathematics Educator*. 3(2), 54-69.
- Parker, M., & Leinhardt, G. (1995). Percent: A privileged proportion. *Review of Education Research*, 65(4), 421-481.
- Price, B., Stacey, K., Steinle, V., Chick, H., Gvozdenko, E. (2009). Getting SMART About Assessment for Learning. In D. Martin, T. Fitzpatrick, R. Hunting, D. Itter, C. Lenard, T. Mills, L. Milne (Eds). *Mathematics - Of Prime Importance*. (Proceedings of the 2009 Annual Conference of the Mathematical Association of Victoria. pp. 174-181). Melbourne: Mathematical Association of Victoria.
- Ryan, J & Williams, J. (2007). *Children's mathematics 4-15: Learning from errors and misconceptions*. New York: Open University Press.
- Smart, J.R. (1980). The teaching of percentage problems. *School science and mathematics*. 80, 187-192.
- Stacey, K., Price, B., Steinle, V., Chick, H., & Gvozdenko, E. (2009). *SMART Assessment for Learning*. Paper presented at Conference of the International Society for Design and Development in Education, Cairns, Australia. September 28 – October 1, 2009). Retrieved 2 March 2010 from http://www.isdde.org/isdde/cairns/pdf/papers/isdde09_stacey.pdf.
- Victorian Curriculum and Assessment Authority. (2008) *Victorian Essential Learning Standards, (Mathematics)*, Revised edition Retrieved 2 March 2010 from <http://vels.vcaa.vic.edu.au/vels/maths.html>

Why do Disadvantaged Filipino Children Find Word Problems in English Difficult?

Debbie Bautista
Macquarie University

<debbie.bautista@students.mq.edu.au>

Joanne Mulligan
Macquarie University

<joanne.mulligan@mq.edu.au>

Young Filipino students are expected to solve mathematical word problems in English, a language that many encounter only in schools. Using individual interviews of 17 Filipino children, we investigated why word problems in English are difficult and the extent to which the language interferes with performance. Results indicate that children could not solve word problems independently when these were given in English. However, appropriate interventions such as presenting problems in Filipino or narrating them led to improved performance. Implications for teaching are proposed.

In accordance with Philippine national policy, mathematics is taught in English. However, many children from poor families have little knowledge of English and it is recommended that instruction begin “with an assumption of zero knowledge” (Gonzales, 2006, p. 147). It is within this background that we investigated student performance in the domain of word problems that form an integral part of the Philippine mathematics curriculum (Department of Education Bureau of Elementary Education, 2003).

Word problems primarily serve as a means to apply computational skills. The curriculum documents are quite explicit about how children should solve word problems. Children should be able to state what is asked and what are given, identify word clues, and specify the correct operation to be used. For two-step problems, children are also asked for the “hidden question”. These stringent requirements are evident not only in textbooks but also in standardised assessments (see Figure 1).

- In a Grade Two class, there are 20 boys and 25 girls. How many pupils are there in all?
- _____ 24. What is asked in the problem?
a. number of pupils in all c. number of girls
b. number of boys d. number of class
- _____ 25. What are given in the problem?
a. 20 boys c. 20 boys and 25 girls
b. 25 girls d. 25 boys and 20 girls
- _____ 26. What operation will solve the problem?
a. addition b. subtraction c. multiplication d. division
- _____ 27. What is the correct number sentence?
a. $20 \times 25 = N$ b. $25 \div 20 = N$ c. $25 + 20 = N$ d. $25 - 20 = N$
- _____ 28. What is the correct answer?
a. 45 pupils b. 54 pupils c. 45 boys d. 45 girls

Figure 1. Word problem assessments for Grade 2 students from all public schools in one city

Filipino children find word problems difficult (Brawner et al., 1999), and the language factor is identified as one of the “what-else-is-new” reasons for student failure (Philippine Executive Report on the TIMSS, cited by Carteciano, 2005). Multiple studies have shown



that Filipino children find word problems in English more difficult than those in Filipino (Bautista, Mitchelmore, & Mulligan, 2009; Bautista & Mulligan, 2010; Bernardo, 1999). It is also well-known that word problems in English are more difficult for children who are still in the process of learning English than for native English speakers (Martiniello, 2008).

Language is not the only challenge facing problem solvers. Some additive problem structures are more difficult than others (Carpenter & Moser, 1984). For example, the problem “There are 12 birds. Five are flying. How many are not flying?” is more difficult than “Julia has 12 books. She gave 5 books to Mark. How many books does Julia have now?” even though both can be answered by calculating $12 - 7$. The first problem does not involve an explicit action, making it hard for children to relate the given quantities (Nunes & Bryant, 1996).

The disadvantages of written tests as a means of diagnosing children’s difficulties is well established (Ellerton & Olson, 2005), especially when the language of the test is not the child’s first language (Abedi, 2002). When children produce an error for short-answer questions, one can only hypothesise about the reasons for the error. Similarly, it is possible for students who do not have a firm grasp of the mathematical concepts involved in the problem to give correct answers. Thus, individual interviews are becoming increasingly utilised for mathematical assessments (Goldin, 2000).

The purpose of this paper is to describe an interview method for investigating the responses of young Filipino students to one-step addition and subtraction problems. Through the interviews, we aim to investigate (a) why Filipino children find word problems in English difficult, and (b) the extent to which the language and the related mathematical concepts explain these difficulties. The results from this study were intended to inform the design of an intervention as part of a larger research project.

Structure of the Interview Protocol

Analysing children’s word problem difficulties through individual interviews is not new. Newman (1983) interviewed children to assess their initial errors when solving word problems, and proposed that word problem solvers should succeed in five intermediate stages: Reading, Comprehension, Transformation, Process Skills, and Encoding. The hierarchy provides a framework for identifying children’s errors, allowing for the preparation of an appropriate teaching strategy.

Newman acknowledged that the method was designed to identify children’s initial errors. However, other errors may occur after the initial error. For instance, a child who initially miscomprehends a problem may subsequently execute some calculation inaccurately. These errors were not of primary concern in the Newman method. Nevertheless, Newman proposed modifications that allow for researchers to determine whether children may produce subsequent errors by providing assistance in the initial stages. For example, for a child who commits a Reading error, the interviewer may read the problem aloud and see whether the child can now proceed with a solution.

The value of Newman’s modification became evident after we have analysed our pilot interviews with seven Filipino children (Bautista, Mulligan, & Mitchelmore, in press). The pilot data revealed that children with the same initial error (e.g., Reading) may consequently follow different solution paths after some help. Thus, we shifted the focus from identifying initial errors to investigating “intentional actions” (Jacobs & Ambrose, 2008, p. 261) which could give students more opportunities to reveal their mathematical abilities. Our pilot interviews also revealed that the interview design should allow for the systematic use of two language versions of each problem.

We now describe the interview method in detail. It employs six tasks taken from Carpenter and Moser's (1984) word problem classification (Table 1). English and Filipino versions of each task were prepared and checked by reverse translation.

Table 1
Word Problem Tasks Used in this Study

Problem Type	Sample Problem
Join (addition)	Alvin had 3 coins. Then Jun gave him 8 more coins. How many coins does Alvin have now?
Separate (subtraction)	Dora has 11 mangoes. Then Dora gave 6 mangoes to Kevin. How many mangoes does Dora have now?
Join (missing addend)	Jolina had 7 pencils. Then Alma gave her some more pencils. Now Jolina has 12 pencils. How many pencils did Alma give her?
Combine (addition)	Tess has 5 hats. Rodel has 8 hats. How many hats do they have altogether?
Combine (subtraction)	Jimmy and Mia have 11 marbles altogether. Jimmy has 4 marbles. How many marbles does Mia have?
Compare	Rica has 12 books. Luis has 7 books. How many more books does Rica have than Luis?

Following Newman (1983), the English problem was first presented to the child, who was asked to read the problem aloud. When no response or an incorrect response was given, the interviewer attempted to determine whether the child had any difficulties in comprehending what had been read. The child was asked for any word or phrase that was not understood, or what was being asked in the problem. Alternatively, the child may have been asked to retell the problem (cf. Hershkovitz & Nesher, 2001) as a means of understanding the child's interpretation of the text.

The Filipino version was presented next. If this procedure did not help, the problem was read aloud to the child by the interviewer. Again, if reading aloud did not help the child, the interviewer retold the problem to the child as if it were a story (in Filipino), utilising questions about the text along the way, to facilitate comprehension. The following dialogue illustrates the interviewer's (*I*) intervention when the child (*C*) could not manage to retell the situation described by the Separation problem:

- I:* *O, may 11 na mangga si Dora ha* [Dora has 11 mangoes]. *Tapos, ito makinig ka, ilan ulit yung mangga ni Dora* [Then, listen here, how many mangoes does she have again]?
- C:* Eleven.
- I:* *Binigyan ni Dora si Kevin* [Dora gave Kevin]; *namigay si Dora ng anim na mangga* [Dora gave Kevin six mangoes]. *O, kanina ilan yung mangga ni Dora* [How many mangoes did Dora have a while ago]?
- C:* Eleven.
- I:* *O, tapos namigay siya ng* [Then how many did she give]?
- C:* *Anim* [Six].
- I:* *Ilan na ang mangga ni Dora ngayon* [How many mangoes does Dora have now]?

Some children still failed to produce correct answers even after the text was narrated to them in this manner. To further understand the cause of their difficulties, the interviewer gave one or more of the following interventions: (a) reading the problem line by line and pausing to allow the child to represent each statement using blocks, (b) presenting a concrete modelling task, or (c) rewording the problem. The concrete modelling task was one that matched the problem’s mathematical structure (cf. Wright, Martland, & Stafford, 2000). In the Separation Problem, for example, the corresponding task was to briefly display, then screen, 11 counters. Without allowing the child to see, six counters were then removed from this set. The interviewer said (in Filipino), *There were 11 counters, but then I took away 6 counters. How many counters are there now?*

For Combine (subtraction) and Compare problems, a reworded version was presented because rewording has been found to facilitate problem solution (Bernardo, 1999; Jacobs & Ambrose, 2008). For example, the reworded version for the Compare problem was: “Rica has 12 books. Luis has 7 books. How many more books does Luis need so that he and Rica would have the same number of books?”

We do not assert that the concrete modelling tasks or the reworded versions required the same level of thinking as the original problems. However, because our aim was to determine obstacles to solving word problems, we wanted to provide as many aids as possible in order to identify the strategy that enabled the child to solve the word problem. The strategy of providing aids was in accordance with Goldin’s (2000) procedure for constructing scripts for task-based interviews. He asserted that these pre-planned aids allow the researcher to delve deeper into children’s thinking than would have been possible had no aids been available. The enabling strategies for making word problems accessible to students are summarised in Table 2. Minor computational errors that were corrected after children had been asked to repeat or explain their solution were recorded as correct.

Table 2
Levels of Enabling Strategies for Correct Solution

Description
<i>Incorrect</i> – child fails to solve the problem
<i>Concrete</i> – child solves the corresponding concrete modelling task
<i>Reworded</i> – child solves the reworded problem
<i>Narrated</i> – child solves the problem when the interviewer tells the problem as if it were a story or when the interviewer corrects the child’s initial misinterpretation of the problem
<i>Read aloud</i> – child solves the problem when the interviewer reads it aloud in Filipino
<i>Filipino</i> – child solves the Filipino problem independently (not read aloud by interviewer)
<i>English</i> – child solves the English problem independently (not read aloud by interviewer)

Interview Results

The interviews reported here were conducted with 17 Filipino Grade 2 students (11 girls, 6 boys; mean age: 7 years 10 months) who voluntarily participated in a parish-based, out-of-school tutorial program. All the children were from public schools drawn from the poorer areas of Metropolitan Manila.

For purposes of analysis, the Join (addition), Separate (subtraction), and Combine (addition) problems (see Table 1) were grouped together and labelled “Easy Problems”

because previous findings (Okamoto, 1996; Riley, Greeno, & Heller, 1983) indicate that children are generally more successful with these problems than with the rest. The remaining problems in Table 1 were grouped together and labelled ‘Difficult Problems’.

The 17 children’s responses are summarised in Figure 2. The graph shows the point at which a correct solution was produced. For easy problems, most responses were correct. However, most of these correct answers required some form of assistance from the interviewer. These aids were less successful for the difficult problems where almost half of the responses were incorrect. Although reading word problems aloud facilitated problem solution for easy problems, it did not seem to have helped for more difficult problems.

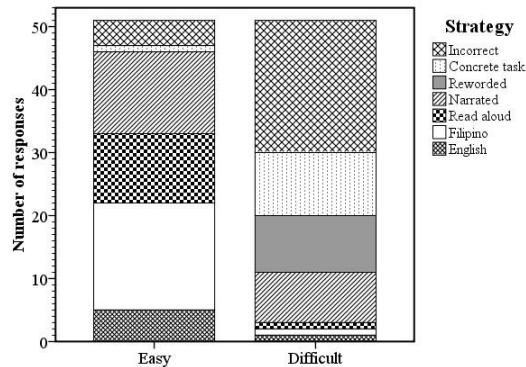

Figure 2. Enabling strategies for easy and difficult problems

The results also show the expected poor performance in solving problems written in English, and the interview protocols reveal several possible reasons. Some children could only read one syllable at a time, and most had not mastered the conventions of written English (e.g. reading “now” as “no”). Also, many children knew only the most basic words. When Dina⁷ was asked what “Alvin had 3 coins” meant, she replied, “Pera [money]”. She was only able to pick out one word that she understood. Under these circumstances, it was unlikely that she could have understood the meaning of the entire sentence. Eleven other children just shook their heads when asked whether they understood the same statement. To place ourselves in these children’s shoes, solving the relatively simple Join (addition) problem in Spanish requires understanding the sentence, “Alvin tuvo tres monedas” which a non-Spanish speaker would find difficult, if not impossible, to comprehend.

The inability to understand simple English sentences did not prevent some children from producing correct answers, although it is questionable whether the correct answers reflected mathematical understanding. For example, after reading the Join (addition) problem (see Table 1), Maria added the two given numbers silently and said, “Eleven”, which was the correct answer. However, when asked subsequently about what happened in the problem and what “gave” meant, she could not respond. When the Filipino version was presented, she smiled and said, “Sabi na nga ba, dagdag ‘yan eh! [I told you, it’s addition!]”. It was only then when she understood the basis for her own method.

Not only did children have problems with English vocabulary but they also had difficulties with the syntax of the English language. For example, Sheryl knew what “gave” meant in “Alvin had 3 coins. Then Jun gave him 8 more coins”, but she thought

⁷ All children’s names are pseudonyms.

that Alvin was the giver. There were also many instances where children said they did not understand the word “does” in the sentence “How many coins does Alvin have now?”

Presenting problems in Filipino offered some help, but several children needed to have the text narrated to them, especially for the more difficult problems. In particular, probing questions showed that children interpreted “Then Alma gave her some more pencils. Now Jolina has 12 pencils” as “Alma gave 12 pencils,” even when the text was presented in Filipino. The situation had to be clarified to them before a correct strategy was selected. This aid worked in some instances. For example, after Monica read the Filipino version of this problem, she immediately answered, “Twelve”. The interviewer said that the text did not mention the exact number of pencils given, but only that Alma gave Jolina some pencils and “*kaya ngayon, 12 na daw ang lapis ni Jolina. [so now, Jolina already has 12 pencils]*”. After hearing the narration, Monica used her fingers to silently count up from seven and gave the correct answer.

After the problem had been clarified, the children displayed a wide range of mathematical strategies. Jessa solved the problem above in a different way. She formed a set of seven red blocks and joined nine green blocks to this set. She then started to count all the blocks, starting with the red ones. Upon reaching 12, she removed the excess blocks and counted the number of green blocks.

We also observed that besides understanding the problem context, children also needed to understand that addition and subtraction are more than joining sets or breaking them apart. For example, most of the children responded to the Compare problem by adding the two given numbers or saying the larger number. They had no appropriate strategy to deal with this mathematical structure, even after the problem was explained to them.

Discussion

Most of the children in this study could not solve word problems when they were presented solely in written English. This result confirms the assertion we made at the outset that written assessments may fail to give a complete picture of Filipino children’s abilities. The pre-planned aids presented during the interviews minimised interference from deficiencies in reading and English language competence. The interview allowed the children to demonstrate their mathematical knowledge, even when the language initially impeded problem solution. Thus, we found that like the children from Carpenter and Moser’s (1984) study, the children from our study also found some problem structures easier than others and displayed a wide range of strategies for solving word problems.

Results indicate that the children’s difficulties with the English language are not comparable with those reported in the literature. Much of the research on difficulties of second language learners focuses on academic English and the highly specialised language of mathematics (Bielenberg & Fillmore, 2005; Schleppegrell, 2007). However, the needs of the children in this study are much more basic. They have not even acquired the English language skills necessary for daily social interactions, and the interviews themselves had to be in Filipino in order for meaningful communication to take place. Thus, the problem’s semantic structure remains concealed and cannot form the basis for an appropriate strategy.

The children’s unfamiliarity with English may prevent them from going through the recommended problem solving steps illustrated in Figure 1. It is conceivable that the guide questions were intended to help children capture relevant information from the text. However, children with very low levels of English proficiency and decoding skills are unlikely to benefit from such questions. The only way for them to solve these questions is if they were taught superficial strategies. For example, to determine what is being asked,

one should simply change “how many” in “How many pupils are there in all?” to “the number of”. These kinds of strategies may work but they encourage low-level thinking and do not contribute to meaningful sense making.

Implications for Teaching and Curriculum

The results from this study have clear indications for teaching. First, because many children could not understand everyday English words, plenty of time should be set aside for helping children understand the problem situation. Helping children make sense of the situation before applying a mathematical strategy will prevent the development of short-cut solutions not based on the problem text. Second, the interviews demonstrated effective interventions that make word problems more accessible for students. Teachers may narrate problems and guide children towards understanding, and support the discussion with concrete tasks. These aids often lead children to execute appropriate strategies.

A third implication is that it is important to develop children’s understanding of the various addition and subtraction structures illustrated in Table 1. Because students’ language difficulties may mask their gaps in mathematical knowledge, it may be tempting to focus primarily on language issues. It is also important to encourage them to model the relations in the problems using representations which make sense to them, whether these be physical objects, drawings, counting sequences, or number sentences.

We also propose that the problem solving process outlined in Philippine curriculum documents be seriously re-examined. This study showed how difficult it was for children to understand common English words. The proposed intermediate questions illustrated in Figure 1 contain more specialised language than that used in basic social interactions. Linguistically, they are even more complex than the original word problem, and it is highly unlikely that the questions would contribute to better comprehension. Instead, we suggest that questioning should be more conversational. These questions should pertain to the particular problem being solved and help children develop a qualitative understanding of the relationships between the given quantities.

Finally, the research reported here must be interpreted in the context of a developing country with limited educational resources (Senate of the Philippines, 2009, January 27), and where educational reform is challenging but possible (Nebres, 2009).

Acknowledgment

Special thanks are due to Assoc. Prof. Michael Mitchelmore for providing valuable comments and suggestions on earlier drafts of this paper.

References

- Abedi, J. (2002). Standardized achievement tests and English language learners: Psychometrics issues. *Educational Assessment*, 8, 231-257.
- Bautista, D., Mitchelmore, M., & Mulligan, J. (2009). Factors influencing Filipino children’s solutions to addition and subtraction word problems. *Educational Psychology*, 29, 729-745.
- Bautista, D., & Mulligan, J. (2010). *Solutions of addition and subtraction word problems by Filipino public school children*. Manuscript submitted for publication.
- Bautista, D., Mulligan, J., & Mitchelmore, M. (in press). Young Filipino students making sense of arithmetic word problems in English. *Journal of Science and Mathematics Education in Southeast Asia*.
- Bernardo, A. B. I. (1999). Overcoming obstacles to understanding and solving word problems in mathematics. *Educational Psychology*, 19, 149-163.
- Bielenberg, B., & Fillmore, L. W. (2005). The English they need for the test. *Educational Leadership*, 62, 45-49.

- Brawner, F. G., Golla, E. F., Ibe, M. D., De Guzman, F. S., Ogena, E. B., Talisayon, V. M., & Vistro-Yu, C. (1999). *TIMSS-Repeat Philippine Report, Volume 2: Mathematics*. Manila, Philippines: Department of Education, Culture, & Sports, Department of Science and Technology - Science Education Institute, & University of the Philippines National Institute of Science and Mathematics Education.
- Carpenter, T. P., & Moser, J. M. (1984). The acquisition of addition and subtraction concepts in grades one through three. *Journal for Research in Mathematics Education, 15*, 179-202.
- Carteciano, J. A. (2005). NRCP/DOST addresses dire state of S&T education in the regions. Retrieved 23 December 2008, from http://nrcp.dost.gov.ph/index.php?option=com_content &task=view&id=31&Itemid=106
- Department of Education Bureau of Elementary Education (2003). *Basic education curriculum (Philippine learning competencies): Mathematics*. Pasig City, Philippines: Author.
- Ellerton, N. F., & Olson, J. (2005). The assessment dilemma: Correct answers with no understanding and incorrect answers with some understanding. In H. S. Dhindsa, I. J. Kyeleve, O. Chukwu & Q. P. J.H.S. (Eds.), *Future directions in science, mathematics and technical education* (pp. 226-235). Bandar Seri Begawan, Brunei Darussalam: Universiti Brunei Darussalam.
- Goldin, G. A. (2000). A scientific perspective on structured, task-based interviews in mathematics education research. In A. E. Kelly & R. A. Lesh (Eds.), *Handbook of research design in mathematics and science education* (pp. 517-545). Mahwah, NJ: Lawrence Erlbaum.
- Gonzales, A. (2006). The language planning situation in the Philippines. In R. B. Baldauf, Jr. & R. B. Kaplan (Eds.), *Language planning and policy in the Pacific: Fiji, the Philippines, and Vanatu* (Vol. 1). Clevedon, UK: Multilingual Matters.
- Hershkovitz, S., & Nesher, P. (2001). Pathway between text and solution of word problems. In M. van den Heuvel-Panhuizen (Ed.), *Proceedings of the 25th Conference of the International Group for the Psychology of Mathematics Education* (Vol. 3, pp. 145-152). Utrecht, the Netherlands: PME.
- Jacobs, V. R., & Ambrose, R. C. (2008). Making the most of story problems. *Teaching Children Mathematics, 15*, 260-266.
- Martiniello, M. (2008). Language and the performance of English-language learners in math word problems. *Harvard Educational Review, 78*, 333-368.
- Nebres, B. (2009). Engaging the community, targeted interventions: Achieving scale in basic education reform. *Educational Research for Policy and Practice, 8*, 231-245.
- Newman, A. (1983). *The Newman language of mathematics kit*. Sydney: Harcourt Brace Jovanovich Group.
- Nunes, T., & Bryant, P. (1996). *Children doing mathematics*. Cambridge, MA: Blackwell.
- Okamoto, Y. (1996). Modeling children's understanding of quantitative relations in texts: A developmental perspective. *Cognition and Instruction, 14*, 409-440.
- Riley, M. S., Greeno, J. G., & Heller, J. I. (1983). Development of children's problem-solving ability in arithmetic. In H. P. Ginsburg (Ed.), *The development of mathematical thinking* (pp. 153-196). Orlando, FL: Academic Press.
- Schleppegrell, M. J. (2007). The linguistic challenges of mathematics teaching and learning: A research review. *Reading & Writing Quarterly, 23*, 139-159.
- Senate of the Philippines (2009, January 27). *Increased budget for education still insufficient--Gordon*. [Press release]. Retrieved 15 September 2009 from http://www.senate.gov.ph/press_release/2009/0127_gordon2.asp.
- Wright, R. J., Martland, J., & Stafford, A. K. (2000). *Early numeracy: Assessment for teaching and intervention*. London: Paul Chapman Publishing.

Two Test Items to Explore High School Students' Beliefs of Sample Size when Sampling from Large Populations

Anthony Bill Sally Henderson John Penman
University of Tasmania *Department of Education, Tasmania* *Department of Education, Tasmania*
<afbill@utas.edu.au> <sally.henderson@education.tas.gov.au > <john.penman@education.tas.gov.au>

Two test items that examined high school students' beliefs of sample size for large populations using the context of opinion polls conducted prior to national and state elections were developed. A trial of the two items with 21 male and 33 female Year 9 students examined their naïve understanding of sample size: over half of students chose a sample size of "10% of the population", and a quarter chose a sample size of 15,000 – both approaches grossly exceeding the accepted sample size.

Formal consideration of sample size when designing a survey is presently largely excluded from the high school curriculum; it is a complex topic that high school students may not have the conceptual development to support. When a survey is conducted in schools, the most convenient population is the students present in the class: the survey is a census, and the sample size is the number of students present. Sample size is considered only when a survey is conducted beyond the confines of the classroom, and the practical difficulties for a teacher may discourage this type of investigation. When the opportunity for designing a survey – as distinct from a census – arises, students naturally ask the question "how many should be asked?" This suggests not only awareness that a representative sample imperfectly reflects the population, but also a desire to obtain as accurate a result as possible.

Theoretical Background

Statisticians and educators have observed the widespread misunderstanding of sample size amongst students, the general public, and within the media (e.g., Fielding, 1997; Smith, 2004). As a statistician, Fielding noted that inadequately trained investigators were often preoccupied with sample size as a fraction of the population, rather than the absolute sample size. In a study of college students, Smith observed similarly that most untutored students would use a sample size based on the size of the population, such as "10% of the population", and that many students found the notion that a larger population did not require a larger sample as counter-intuitive. Sample size was formerly part of the senior high school curriculum (e.g., Harding, 1992), and more recently studied at college level using computer based re-sampling techniques (e.g., Smith, 2004). Within schools the importance of representative and random sampling is emphasised, but the curriculum is curiously silent on the complementary topic of explicitly quantifying sample size (Department of Education, Tasmania, 2008). The explanation for this apparent omission may be quite simple: in a crowded curriculum this topic is displaced by what are considered higher priority learning goals, and the statistics literature provides no accessible alternative for high school students and school teachers than the crude "10% of the population" rule possibly first acquired in upper primary. Watson's (2006) extensive work with primary and middle school students examining statistical literacy – a cohort that includes the Year 9 students in the proposed study – considered sample size, but the work focused on part/whole concepts and sample representativeness rather than the explicit determination of sample size. Students encounter large populations through the media, for



example political opinion polls, and the *CensusAtSchool* program (Australian Bureau of Statistics, 2009) now provides large data sets where analysis is feasible only through sampling of the data. The literature does not formally define a large population, but the populations in the test items are arguably large. The populations are also finite: “10% of the population” has no application with the *infinite* populations that students do encounter at school, such as die and coin systems. Formally quantifying students’ beliefs using the two proposed test items, and with more sophisticated sample size models potentially accessible to high school students (to be published subsequently) as students mature mathematically, suggests that greater consideration of sample size may be warranted.

Method

The sample consisted of two Year 9 extended mathematics classes in two single-gender government high schools in an Australian capital city. The first author taught the classroom component of the research as part of research into the use of *Fathom*TM in high schools, and the second and third authors acted as colleague teachers. A theme of the research was an exploration of sample size, and the two test items presented below were used to examine students’ naïve beliefs of sample size when sampling from large populations.

Both groups were defined as extended mathematics classes, but the students had self-selected to enrol in the course and presented with a range of abilities. While 21 male students and 35 female students participated, two female students were not fully competent English speakers and, given the language requirements and the contextual nature of the tasks, their responses were not included. The students were either 14 or 15 years old.

Description of the Two Test Items: Task 1 and Task 2

The two test items were presented as multiple-choice companion tasks: Task 1 and Task 2, using the context of opinion polls conducted prior to national and state elections. Both tasks examined sample size in large populations, but Task 1 National Election considered a population ten times that of Task 2 State Election. The number of voters is plausible, but not accurate. The items were designed to be familiar and experiential: the national election and the opinion polling were conducted seven months prior to the study; the students were not eligible to vote at that election, but would vote at the subsequent election. The items were presented under traditional examination conditions. The two items posed the same questions and offered the same responses, but Task 2 also included a response that related population and sample size. Both test items asked students to first, choose the sample size, and second, provide an explanation for that choice. These will now be discussed in turn.

When choosing a sample size, students were provided with four alternative responses that may be categorised as either a fixed percentage of the population, or a numerical value. The fixed percentage, *about 10% of the voting population*, was included as a strategy used in schools and in the wider community. The numeric values responses are arranged in descending order in decrements of an order of magnitude. The two populations were described as, for example, “1.5 million” and fully numerically, for example, “1,500,000.” An additional comment encouraged students to focus on sample size by emphasising that a representative and random sample was taken. The statistically correct and commonly used sample size for a large population is, for both tasks, (c) 1500.

Students were asked to provide an explanation for their choice of sample size, with the question posed informally as “what best describes your thoughts”. In both items students

were presented with four explanations and the further option of volunteering a written response. The four explanations: “(i) I read it in a newspaper or heard it on TV” identifies the media as the students’ source of information; “(ii) I mainly thought about the practicalities and cost of doing the survey” provides students with an opportunity to make a considered judgement amongst the alternatives presented; “(iii) eliminated a few then guessed” recognises a strategy used commonly; and “(iv) knew it from school” explores whether students had encountered the topic in school previously. In Task 2 students are presented with the same four explanations, and a fifth: “(i) the sample size has to be smaller because the population is smaller” identifies a commonly held belief of sample size.

Task 1: Opinion survey prior to an Australian national election

This question was much more topical prior to last year’s federal election! In Australia’s population of 20 million about 15 million (=15,000,000) are 18 years of age or older and can vote. A survey is to be conducted on “how people will vote at the next national election”. How many voters do you think should be surveyed? [This is a question about sample size; assume that the sample is perfectly representative with men and women, and young and old voters etc. included in the sample in the same proportion as the entire voting population.]

- (a) About 10% of the voting population (b) 15,000 (c) 1,500 (d) 150

Why did you choose that sample size? Circle what best describes your thoughts:

- (i) I read it in a newspaper or heard on TV, (ii) I mainly thought about the practicalities and cost of doing the survey, (iii) eliminated a few then guessed, (iv) knew it from school, (v) other:

Task 2: Opinion survey prior to a Queensland state election

In a Queensland state election there are about 1.5 million (=1,500,000) voters. How many voters should be surveyed for a Queensland state election?

- (a) About 10% of the voting population (b) 15,000 (c) 1,500 (d) 150

Why did you choose that sample size? Circle what best describes your thoughts:

- (i) the sample size has to be smaller because the population is smaller (ii) I mainly thought about the practicalities and cost of doing the survey (iii) I read it in a newspaper or heard on TV (iv) eliminated a few then guessed (v) knew it from school (vi) other:

Results

Consistent with the two test items’ structure the analysis is performed in two parts: *Part A: Students’ naïve sampling strategies* are presented as Tables 1-5, and *Part B: Students’ explanations for their naïve sampling strategy* are presented as Table 6.

Part A: Students’ Naïve Sampling Strategies

Table 1 presents students’ naïve beliefs of sample size for a large population. Greater than half of both the boys and the girls chose an incorrect and impracticable sample size of 10% of the population of 15 million. The frequency of students’ responses broadly descended in decreasing order of sample size, with the second most favoured strategy a sample size of (b) 15,000. Seven (21%) girls gave the (preferred) response of (c) 1,500, but in this multiple-choice item the result differs little from chance. No student gave the response of (d) 150.

Table 1
Students' Response to Task 1: Opinion Survey for an Australian National Election

Student response	Boys (<i>n</i> =21)		Girls (<i>n</i> =33)	
	Number	%	Number	%
(a) About 10% of the population	13	62 %	18	55 %
(b) 15,000	6	29 %	6	18 %
(c) 1,500 ¹	2	9 %	7	21 %
(d) 150	0	0 %	0	0 %
No response	0	0 %	2	6 %
Total	21	100 %	33	100 %

¹ Note: The accepted sample size when sampling from large populations

A traditional analysis would examine students' response to the companion Task 2, but a more productive alternative is to examine whether students adopted a consistent sampling strategy response to the two tasks. Within this study, a consistent strategy is considered to be either a *percentage strategy* where students choose *about 10% of the population*, or a *numeric strategy* where students choose explicitly a numeric value (but not necessarily the same numeric value), for both tasks; for example, (b) 15,000. The term *consistent strategy* is used in the sense of students' responses: students' thinking may be consistent, but the two test items may not reveal this thought process. *Inconsistent strategies* are a combination of percentage and numeric strategies. Table 2 shows that in both classes 67% of students applied a consistent strategy, and 28% of boys and 15% of the girls used an inconsistent strategy. A substantial proportion of the girls did not provide a complete response to both tasks.

Table 2
Students' Use of Consistent or Inconsistent Sampling Strategies

Student response	Boys (<i>n</i> =21)		Girls (<i>n</i> =33)	
	Number	%	Number	%
Consistent sampling strategy	14	67 %	22	67 %
Inconsistent sampling strategy	6	28 %	5	15 %
Incomplete response to both items	1	5 %	6	18 %
Total	21	100 %	33	100 %

Students who adopted a consistent approach provided a sub-group of the cohort that may be divided further into three groups: (a) students who adopted a consistent percentage strategy, (b) students who used a consistent numeric strategy and (c) students who used the same sample size for both tasks. Table 3 shows that the female students preferred (68%) the percentage strategy, and the male students were approximately evenly divided between the use of a consistent percentage (43 %) and a consistent numeric (50%) strategies. One student from each class chose the same, and the preferred, sample size of 1,500 for both populations.

Table 3
Type of Consistent Strategy Used by Students

Response	Boys (<i>n</i> =14)		Girls (<i>n</i> =22)	
	Number	%	Number	%
Consistent percentage	6	43 %	15	68 %
Consistent numeric with a smaller sample used for the smaller state population	7	50 %	6	27 %
Consistent numeric; same sample size used for both national and state elections ²	1	7 %	1	5 %
Total	14	100 %	22	100 %

² Note: Two students gave the preferred response of a sample size of 1500 for both items.

Students who adopted an inconsistent strategy comprised the complementary, albeit small, sub-group of six male and five female students. The small number of students in the sub-group provides interesting supporting information. The students predominantly *first* chose a percentage strategy for Task 1, *then* a numeric strategy for Task 2, as shown in Table 4.

Table 4
Type of Inconsistent Strategy Used by Students

Response	Boys (<i>n</i> =6)		Girls (<i>n</i> =5)	
	Number	%	Number	%
Percentage for Task 1, numeric for Task 2	5	83 %	4	80 %
Numeric for Task 1, percentage for Task 2	1	17 %	1	20 %
Total	6	100 %	5	100 %

In Task 2 the explanations included the alternative “(a) the sample size is smaller because the population is smaller”. Responses to this item are confounded because it is impossible to distinguish between students who disagreed (the preferred response) and students who did not give any response. A large proportion of students, over half of the males and a third of the females, indicates this belief is held widely, as shown in Table 5.

Table 5
Students’ Responses to Item Task 2 (a) “the sample size has to be smaller because the population is smaller”

Response	Boys (<i>n</i> =21)		Girls (<i>n</i> =33)	
	Number	%	Number	%
Agree	11	52 %	11	33 %
Disagree ³ / No response	10	48 %	22	67 %
Total	21	100 %	33	100 %

³ Note: Preferred response.

This belief cannot be called a misconception because it is strictly correct; it is, however, a partial understanding only; survey design conventionally chooses a sample size determined by the accuracy required. For example, increasing sample size may increase survey accuracy, but such an increase in accuracy may not provide any additional meaningful information. It is the trade-off between sample size and the accuracy of the survey, and the ability to interpret and *make sense* of sample size that underpins good survey design.

Part B: Students’ Explanations for Their Naïve Sampling Strategy.

Although students were asked to provide separate explanations for their strategies for the two tasks, the low level of responses for Task 2 means that responses to Task 1 are provided only. Arguably students’ responses to the first task, Task 1, may represent their intuitive responses, summarised in Table 6. Similar proportions of male and female students offered “practicalities and cost” as the principal consideration. Over half of female students, but a smaller proportion of male students, provided the candid explanation of “eliminated a few then guessed.” Almost one quarter of male students volunteered the written separate explanation “use a large a sample as possible to improve a survey’s accuracy”, but one female only offered this explanation. One student only gave the response “knew it from school”, indicating that students had not encountered this topic at school previously. One male and one female identified the media as their source of information, but of these only one gave the preferred response of (c) 1,500.

Table 6

Task 1, Students’ Explanations for their Strategies: “What best describes your thoughts?”

Response	Boys (<i>n</i> =21)		Girls (<i>n</i> =33)	
	Number	%	Number	%
Knew it from newspaper or TV	1	5 %	1	3 %
Considered practicalities and cost	6	29 %	10	30 %
Eliminated a few and guessed	3	14 %	17	52 %
Knew it from school	1	5 %	0	0 %
Other: accuracy, take largest sample	5	24 %	1	3 %
Other: intuition	2	9 %	0	0 %
Other: unclassified	0	0 %	1	3 %
No response	3	14 %	3	9 %
Total	21	100 %	33	100 %

Discussion

The two test items provoked a broad range of student responses. The responses provided by the male and female students differ substantially on whether a consistent strategy was used (Table 3) and on the explanation for the strategy used (Table 6), but these differences may reflect the education experiences of the two groups, rather than be gender based. Several themes emerged in the study, and these will be discussed in turn.

Part A: Students’ Naïve Sampling Strategies.

A sampling strategy of “10% of the population” is used extensively, with over half over the students preferring this strategy. The sampling strategy’s widespread appeal is

obvious: it is simple to both remember and use, but the strategy is impracticable with the populations purposefully chosen for the two test items.

A consistent sampling strategy is preferred with two-thirds (67%) of both male and female students applied a consistent sampling strategy, either percentage or numeric, to both tasks. If applied consistently a percentage strategy is arguably a less sophisticated strategy than a consistent numeric approach because the “10% rule” may be applied without sensible consideration of the sample size required – a rule applied by rote. In contrast, and if purposefully used, a constant numeric approach is a two-step process that first requires an appreciation of the magnitude of the sample size (do students of this age have an intuitive sense of 150,000 people?), and second, the practical physical and financial considerations of conducting a survey – a modest demonstration of sense-making. The two students who chose correctly the preferred sample size of 1,500 could have used facts reported in the media.

The small group of students who adopted an inconsistent strategy (six male and five female), strongly favoured a percentage strategy for the first task, and a numeric value for the second task. It is interesting to speculate on students’ thinking: perhaps they began with a familiar strategy then modified the strategy believing that a small sample size was required for Task 2, without appreciating that continued application of the 10% rule will achieve the same purpose.

Part B: Students’ Explanations for Their Naïve Sampling Strategy

Students’ naïve explanation for their preferred strategy represents their established and intuitive beliefs, and this may represent a point of departure for classroom instruction and a guide for students’ development of understanding. Students provided predominantly three explanations for their sampling strategies. First, the high proportion (52%) of female students who explained their strategy as “eliminated a few then guessed” is an candid acknowledgment that students had little or no background knowledge to justify their sampling strategy. Second, almost a third (29% of male and 30% of female students) purposefully considered the practicalities and cost of conducting the survey. This suggests students are applying sense making to an everyday situation outside the mathematics classroom – sense-making that requires cultivation in the classroom. Third, 24% of male students favoured a large sample size to improve accuracy, which provides the opportunity for an exploration of sample size and accuracy. Reconciling the practicalities and the cost, and the accuracy of the survey, are precisely the same issues considered by professional statisticians when designing a survey.

That a smaller population does not require a smaller sample size is a counter-intuitive notion – after all, the converse of more people surveyed, the closer the result must approach that of the population seems axiomatic. Indeed this belief is formally correct, but the value of additional information gained through increasing the sample size may be inconsequential. This sophisticated notion is not normally encountered until tertiary level mathematics, but the foundation intuitions are potentially accessible to high school students.

Conclusion and Implications for Teaching and Research

The concept of sample size is somewhat neglected in education research and in schools, and many students may complete formal schooling with notions of sample size possibly first acquired at upper primary school. More sophisticated notions of sample size

are potentially accessible to high school students by relating sample size and accuracy. The two test items, by quantifying high school students' beliefs of sample size when sampling from large populations, contribute modestly to the body of education research knowledge and may provide a formal mechanism to prompt and support further research in schools on this topic.

The two test items – prototypes only – require refinement. The explanation should include an option of “largest sample size possible to improve accuracy”. In the second task “sample size should be smaller because the population is smaller” does not allow students who disagree to be distinguished from those who did not respond, so this question should be presented separately along with the responses agree/disagree/not certain. The explanations for students' choice of sample size should be offered once only at the conclusion of the test items.

Teaching entirely *to the two test items* misses the opportunity to explore both the relationship between sample size and survey accuracy, and the more sophisticated concept that the accuracy of survey in a large population is determined by the numerical sample size, not the sample proportion. Sampling is measurement; any measurement has a certain accuracy, and accuracy should be introduced first as sense-making of the familiar physical properties of mass, length, and time. The “10% of the population” sampling strategy, in common with any model, has limitations. This sampling strategy is clearly impracticable in the large populations used in the two test items, and it cannot be used with *infinite* populations that are encountered at school, such a die and coin systems – in the latter instance the sample size is chosen without any sound mathematical basis, but on the time available or the endurance of students to roll a die or flip a coin. The limitations of the “10%” strategy are potentially accessible to students in terms of time and cost of conducting a survey, or as an extension of the law of large numbers activities, or by the use of electronic simulations. Naïve notions identified by the two tasks may provide a basis for instruction. The challenge for teachers may be to replace naïve notions with more sophisticated sample size strategies.

Acknowledgment.

This research was supported under an ARC Linkage grant LP0669106 by the Australian Bureau of Statistics and KCP, the manufacturer of Fathom. The researchers thank the students and staff at the schools, Bill Finzer of Key Curriculum Press, and the first author's supervisor for their support and participation.

References

- Australian Bureau of Statistics. (2010). *CensusAtSchool*. Retrieved 8 January 2010 from <http://www.abs.gov.au/websitedbs/cashome.nsf/Home/Home>
- Department of Education, Tasmania. (2008). *The Tasmanian curriculum. Mathematics–numeracy. K – 10 syllabus and support materials*. Retrieved 2 November 2009 from <http://resources.education.tas.gov.au/item/edres/29da4473-d8fd-6edd-a1d5-7e6da3384886/1/syl-mnall.pdf>
- Fielding, A. (1996). Determining adequate sample sizes. *Teaching Statistics*, 18(1), 6–9. Retrieved 1 January 2008 from <http://www3.interscience.wiley.com/cgi-bin/fulltext/119953047/PDFSTART>
- Smith, M. H. (2004). A sample/population size activity: Is it the sample size of the sample as a fraction of the population that matters? *Journal of Statistics Education*, 12(2). Retrieved 29 January 2008 from <http://www.amstat.org/publications/jse/v12n2/smith.html>
- Watson, J. M. (2006). *Statistical literacy at school: Growth and goals*. Mahwah, NJ: Lawrence Erlbaum Associates, Publishers.

The Impact of a Developmental Framework in Number on Primary Teachers' Classroom Practice

Janette Bobis

University of Sydney

<janette.bobis@sydney.edu.au>

This paper presents the findings of an investigation into the influence primary teachers' knowledge of a researched-based framework describing children's cognitive development in early number has on their teaching practices. Survey and interview data from twenty-eight teachers were collected to determine teachers' perceptions of their understanding of the framework, their ability to use the framework to assess students' mathematical development and to plan appropriate instruction. The findings raise further questions about the influence of affective factors, such as teachers' confidence in their own knowledge, on their instructional decision-making.

Teachers' knowledge of children's mathematical thinking strategies can be extremely influential in determining their instructional strategies (Swafford, Jones & Thornton, 2000). While distinct from knowledge (Thompson, 1992), teachers' *perceptions* of their knowledge seem to particularly impact on their classroom instruction (Cai, Perry & Wong, 2007). Without confidence in their knowledge to determine students' mathematical development, teachers may question their abilities to plan appropriate instruction.

'Confidence' is a dimension of attitude that has been studied quite extensively in relation to teachers' mathematical content knowledge, particularly in primary and middle school teachers (Beswick, Watson & Brown, 2005). Considered together with the work of researchers such as Deborah Ball (e.g., Hill, Sleep, Lewis & Ball, 2007) and those concerned with a program of research surrounding Cognitively Guided Instruction [CGI] (e.g., Fennema, Carpenter, Franke, Levi, Jacobs & Empson, 1996; Franke & Kazemi, 2001), we have gone some way in developing our understanding of teachers' abilities — and confidence in those abilities — to both assess students' mathematical development and to plan appropriate instruction as a consequence.

In a long-running series of studies, Carpenter, Fennema and a team of CGI researchers showed that primary teachers can identify the major strategies that children use to solve different kinds of problems, but their knowledge is generally not organised into a coherent network and possibly for this reason does not play a determining role in their instructional decision-making (Fennema et al., 1996). They proposed that research-based frameworks present that knowledge in a more organised manner and thus it would be easier to use to guide assessment and teaching practices. Fennema and colleagues used frameworks for addition/subtraction and then multiplication/division problem-types to study teachers' knowledge and beliefs about children's thinking in these areas, and explored the impact on instruction and children's learning of that knowledge. They found that knowledge of children's thinking made a difference in how teachers taught mathematics and what children learned (Franke et al., 2001). Exactly what these differences are and how teachers use this information to modify their instruction is the subject of on-going research of the CGI and other researchers concerned with the impact of teacher knowledge on instruction and student learning.

The explicit assessment of teachers' abilities to apply their knowledge of a research-based developmental framework in number was an important component of a larger study designed to explore the impact of a professional development program on teachers'



knowledge and classroom practices. Before presenting the specific research questions of the study relating to teacher knowledge, their perceptions of that knowledge and its impact on their teaching practices, background to the professional development program and the specific developmental framework in question is briefly presented to provide the context for the study.

Count Me In Too and the Learning Framework in Number

The professional development program that formed the basis for this study was the Count Me In Too (CMIT) numeracy program. CMIT is a professional development initiative of the Department of Education and Training in New South Wales (NSWDET, 2007). Its main aims are to help teachers understand children's mathematical development and to improve children's achievement in mathematics. Key aspects of the program include the Learning Framework in Number (LFIN) and a diagnostic interview or Schedule in Early Number Assessment (SENA) (Wright, Martland & Stafford, 2006). The LFIN is a useful 'tool' used by teachers to not only identify the level of development each child has attained but to provide instructional guidance as to what each student needs to work towards. A stimulus for the current study was the need to know what teachers understand about the LFIN and how it impacts on their teaching and assessment practices.

Learning frameworks provide a description of skills, understandings and knowledge in a sequence in which they typically occur, giving a virtual picture of what it means to progress through an area of learning. Thus they provide a pathway or map for monitoring individual development over time. A student's location on a framework can be utilised as a guide to determining the types of learning experiences that will be most useful in meeting the student's individual needs at that particular stage in their learning. A number of professional development programs now exist that utilise such theoretical frameworks with the aim of increasing teachers' understanding of children's mathematical thinking (e.g., Bobis, Clarke, Clarke, Thomas, Wright, Young-Loveridge & Gould, 2005; Van den Heuvel-Panhuizen, 2001).

The CMIT Framework was initially developed by Wright (1994) and has since undergone further development through the impact of a wide range of research in early number (e.g., Gravemeijer, 1994; Mulligan & Mitchelmore, 1997). The LFIN characterises major stages of development in five key components of number, including: knowledge of forward and backward number word sequences, numeral identification, operation strategies using both counting by both ones and in groups, through to knowledge of fractions by sharing and partitioning. Teachers use these stage descriptions to profile their students' knowledge in each key component. Such information then provides instructional guidance as to what each student needs to progress. An important step in teachers' ability to utilise the framework in their instructional decision-making is their understanding of how all components are interrelated.

Aim of This Study

The aim of this study was to explore teacher knowledge of the LFIN from the CMIT numeracy program, teachers' perceptions of that knowledge, and the impact this knowledge has on their teaching practices. In particular, the study addressed the following research questions:

1. What are teachers' perceptions of their knowledge about the Learning Framework In Number [LFIN]?

2. How confident do teachers feel about identifying children's levels of mathematical development on the LFIN?
3. Can teachers use their knowledge about children's mathematical development as indicated on the LFIN to plan appropriate instruction?

Research Design

Three primary schools were purposively selected by NSW DET authorities and then invited to participate in the study. Criteria for selection were based on a school's action plan detailing 2008 outcomes and processes for the implementation of CMIT in their school and their willingness to participate in the study. A case study of each school was compiled that specifically focused on teacher knowledge of the LFIN and its impact on their teaching practices. While information for the larger study was gathered from three main sources — survey, interviews and teaching documents — given length restrictions, only data from certain sections and questions of the survey can be reported here.

Procedure and Instruments

The survey consisted of three main sections. The first section sought biographical and contextual information about the school and the individual teacher completing the survey. Section 2 asked teachers to rate the level they perceive best described the implementation of CMIT at their school and in their own classroom. The third section of the survey required an open-ended response to a scenario involving a description of a student's reaction to a mathematical task. Teachers were asked to use the available evidence to approximate the child's performance as described by the LFIN and to make suggestions about the types of activities/learning experiences that would most suit the child's level of understanding. The survey was completed anonymously by teachers and then placed in individual, unmarked envelopes for collection by the researcher.

Responses to Questions 5-8 from Section 2 and the open-ended response to Section 3 of the survey will be reported in this paper. These questions related specifically to individual teachers' perceived understanding of the LFIN (Ques. 5), the extent to which they considered the LFIN had increased their understanding of children's number knowledge (Ques. 6), their confidence using it to assess students' development in number (Ques. 7) and the impact this knowledge has on their instructional decision-making (Ques. 8). Individual background data drawn from Section 1 of the survey will be drawn upon to help interpret some findings when appropriate.

Results and Discussion

Twenty-eight surveys were returned from the three case study schools—10 from both School A and School C and 8 from School B. For Questions 5 to 8 of Section 2 on the survey, teachers were asked to use a rating scale from 0 (no understanding or confidence) to 4 (excellent /extensively). Hence, the higher ratings generally indicate more desirable and confident responses in terms of teachers' understanding of the LFIN and the perceived extent to which it impacted on their pedagogy. However, without an explanation or rationale for each rating, caution should be used interpreting the results. For instance, during site visits, interviewees were asked to rate themselves on similar items and to explain their rating. While some interviewees rated themselves only 1 or 2 for their understanding of the LFIN (e.g., Respondent 5 from School A), some explained the fairly low rating was because they now know that they "have a lot more to learn". This may also

be a reason why some teachers did not wish to indicate Excellent (Level 4) for any aspect of their understanding of the LFIN despite their familiarity working with the LFIN in the classroom for a number of years. Nonetheless, important trends in the data can still be identified, particularly when comparisons are made between schools.

The results for Section 2 Questions 5 to 8 for all survey respondents are presented in Figure 1. Generally, respondents from School A (Respondents 1-10) rated their understanding of the LFIN as Adequate (Level 2) or higher with the majority considering their understanding as Good (Level 3). Respondent 6, who displayed the most positive responses overall, indicated on the survey that she is also the CMIT coordinator in her school so it is understandable that this respondent would be more experienced and confident in most aspects of the LFIN and its impact on instruction. Six respondents (Respondents 2, 3, 7, 8, 9, and 10) rated Question 7 (confidence identifying a student’s stage of development on the LFIN), as only Adequate. Given that four School A, respondents indicated that they had less than 12 months experience implementing CMIT in their classrooms (Respondents 2, 5, 9 and 10) it is highly likely that this lack of experience influenced their self-ratings on these items.

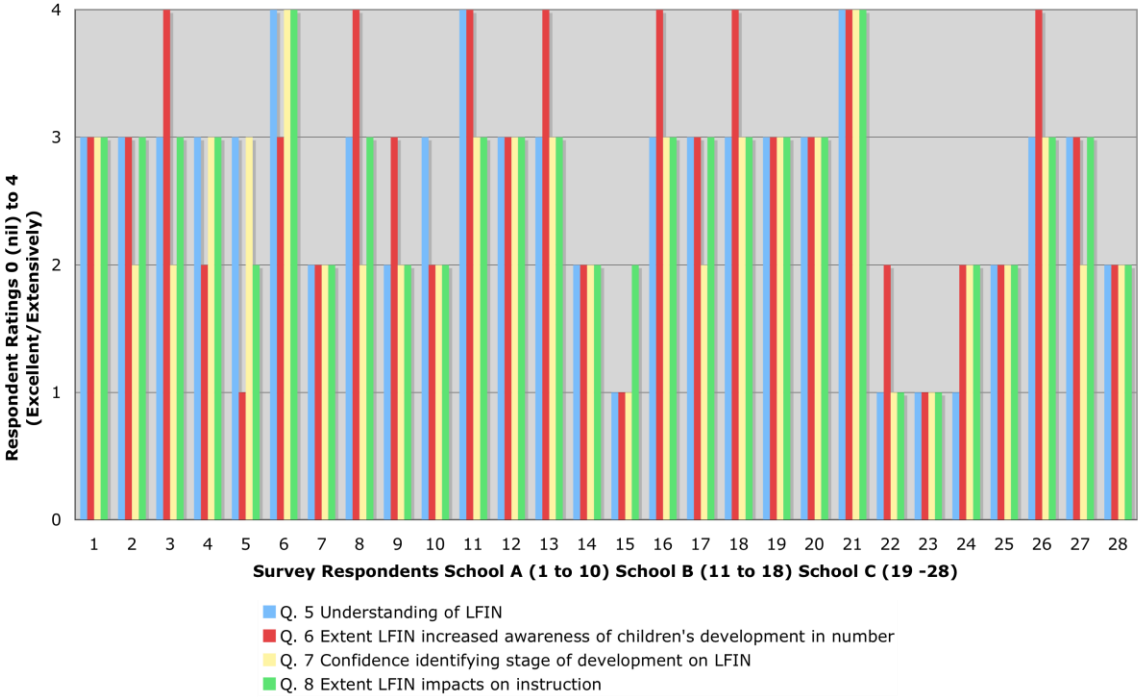

Figure 1: Responses to survey section 2 Questions 5 – 8.

Survey respondents from School B (Respondents 11 to 18) generally indicated more positive perceptions of their understanding and confidence using the LFIN. The majority provided a Good (Level 3) rating to each of the questions concerned with their understanding and implementation of the LFIN. From Section 1 biographical data provided by respondents, it was found that the average length of involvement in the program of all School B respondents was 5 years, making the staff of School B the most experienced CMIT users of all three case study schools. Half of the respondents considered that there had been Extensive (Level 4) increases in their awareness of children’s development in

number knowledge and strategies as a result of their introduction to the LFIN. Only one respondent (Respondent 15) selected ratings at Minimal (Level 1) for their understanding, increase in awareness and for their confidence identifying the stage of development using the LFIN. Understandably, and in accord with the findings of Frank et al. (2001), the same respondent considered that the LFIN had only a Level 2 impact on their instruction.

School C survey results are represented by Respondents 19 to 28 in Figure 1. Taken as a whole, the range in responses is more varied than for Schools A and B with a greater number of respondents selecting lower (Level 1 or 2) ratings to describe their understanding and confidence working with the LFIN. Importantly, respondents who rated any aspect relating to their knowledge and implementation of the LFIN as a Level 3 or 4 were either Kindergarten teachers (Respondents 20, 21 and 27), the CMIT Facilitator (Respondent 26) or executive staff (Respondent 19 Year 5 teacher) with at least 4 to 5 years experience working with CMIT in their classrooms. The remaining respondents (Respondents 22, 23, 24, 25 and 28) each had less than 2 years experience implementing the program with Respondent 28 indicating less than a few months experience. Respondent 21, who indicated the highest level of confidence about their understanding of the LFIN and their ability to use it to identify children's developmental stages and plan for instruction also had the greatest number of years experience working with CMIT in the classroom (nearly 6 years). While reasons for individual ratings still need to be clarified via interview data, there is a clear trend at School B and C indicating that the more exposure teachers had to CMIT, the more confident they felt about their understanding of the LFIN and their ability to use it to guide their assessment and instructional decision-making. Understandably, the more time spent familiarising oneself with new knowledge and practices, the more comfortable a teacher would feel incorporating them into their teaching. However, as argued later, this was not the case for all teachers, and it became apparent that while 'length of time' may be necessary for a more robust implementation of CMIT, it is certainly not a sufficient factor.

Section 3 of the survey presented an excerpt from a 'hypothetical' interview in which a child's early arithmetical strategies were being assessed. Respondents were required to respond with advice for the teacher of this child regarding (a) the child's numerical development, and (b) what to teach the child. Due to the enormous variation in responses to this item, a rubric was established to assist with analysis of respondents' comments. The rubric, along with the number of respondents from each school falling into each level and sample responses, is presented in Table 1. Importantly, an allocation to a particular level on the rubric does not indicate that one teacher is considered a better teacher than any other — it simply means that they are considered to have a different level of understanding of the LFIN.

Three survey respondents (1 from School A and 2 from School C) did not respond to this section on the survey so were given an automatic Level 0 rating according to the rubric. Only two other respondents received this level rating due to the fact that their answers did not explicitly address the question. Seventy-eight percent of respondents (23 out of 28) provided responses that were rated at Level 1 or above with 50% receiving ratings in the top two levels.

Table 1

Rubric for Analysing Teachers' Responses to the Assessment Scenario of the Survey.

Level	No. of teachers responding at each level per school & total (%) for all schools ¹	Description of response level	Sample responses and list of respondents in each category
0	School A = 2 School B = 0 School C = 3 Total = 5 (17.8%)	No response, unreasonable or inappropriate response indicating little/no understanding of task or unable to make sense of response.	No response (Respondents 10, 20 & 25). Depends on how old the child is (Respondent 23). Respondents 4, 10, 20, 23, 25
1	School A = 3 School B = 2 School C = 3 Total = 8 (28.5%)	Strategy development described or LFIN referred to but inappropriate stage selected. No follow-up suggested or some understanding evident of follow-up activities but may not be the most appropriate given stage selected.	Child is counting from 1 for addition (Respondent 7) Child is emergent and needs the more efficient method of counting-on from larger number (Respondent 14) Respondents 6, 7, 9, 14, 15, 19, 21, 22
2	School A = 3 School B = 1 School C = 3 Total = 7 (25%)	Appropriate strategy described or LFIN referred to. Follow-up learning experiences mostly appropriate.	Perceptual level. Teach child to count on from the larger number (Respondent 17) Respondents 1, 2, 5, 17, 24, 27, 28
3	School A = 2 School B = 4 School C = 1 Total = 7 (25%)	Comprehensive understanding of strategy development or LFIN and/or uses LFIN to justify choice of appropriate follow-up learning experiences.	Level 1 Perceptual. Still needs concrete materials and counts from 1. Reinforce counting forwards and backwards to increase confidence, working towards counting on from numbers other than 1. Activities such as 'Rabbit ears' will help reduce reliance on concrete materials (Respondent 16) Respondents 3, 8, 11, 12, 16, 18, 26

¹ School A (n = 10), School B (n = 8), School C (n = 10), Total (n = 28)

Respondents from Schools A and C dominated Level 1 and 2 ratings indicating that respondents from these two schools were clearly able to use the available information to either identify the type of strategy used by the child in the scenario or suggest appropriate follow-up instruction. However, Level 1 type responses usually did not refer to a specific stage from the LFIN or, if they did, they selected the wrong strategy 'label'. For instance, Respondent 14 suggested the child was demonstrating 'Emergent' characteristics when a

‘Perceptual’ strategy assessment is more appropriate. Respondents providing Level 2 type responses usually provided an appropriate description of the strategy being used by the child or used the correct terminology from the LFIN. However, they normally suggested follow-up instruction indicating the child now needed to “count-on from the larger number” (e.g., Respondent 17). While this is certainly a necessary strategy development for the future of this child, there are a few more urgent skills the child needs prior to being able to develop the more sophisticated strategy of counting-on. Such appropriate strategy development was more typically suggested by responses rated as Level 3.

Level 3 type responses provided evidence of a comprehensive understanding of strategy development via their ability to analyse the information provided in the scenario. They were also able to use their knowledge of the LFIN and strategy development to justify their choice of appropriate follow-up learning experiences (see, Respondent 16’s justification in Table 1). Over half of the responses demonstrating Level 3 characteristics were from School B respondents. Consistent with results from Sections 1 and 2 on the survey, respondents from this school not only possess the most experience with CMIT in terms of the number of years they have implemented it in their classrooms, but they also generally rated themselves more highly in terms of their confidence in understanding and using the LFIN to guide their instruction. Importantly, the trend across all three case study schools linking length of time in which respondents have implemented CMIT with their self-identified levels of understanding, and confidence using the LFIN is further supported by the results of Section 3 on the survey. However, it should not be assumed that ‘time’ by itself is the definitive factor for improving teachers’ abilities to understand and integrate the LFIN into their pedagogy. The interview data will be critical in identifying what these schools are doing with their ‘time’ that seems to be having such a positive impact on teachers’ abilities to implement CMIT.

Conclusion

The aim of this study was to explore teachers’ perceptions about their knowledge of the Learning Framework In Number, their confidence in identifying children’s stages of development according to the LFIN and the extent to which they could use this knowledge to plan appropriate instruction for students. While the larger study drew upon more varied and richer data sources (e.g., interviews and teacher programs), the closed and open-ended survey items reviewed for this paper indicate trends (such as the link between the duration a school was involved in CMIT and the degree to which teachers felt it was being implemented) and further questions that were explored in more detail during the follow-up interviews. In particular; (a) What is the link between the duration of a teachers’ exposure to the program, their perceived confidence using the LFIN and the extent to which they could successfully assess and plan appropriate instruction for individual students? (b) Why is it that the majority of teachers rated their understanding of the LFIN as Level 3 and their confidence using the LFIN as Level 3 or lower; yet a quarter of all respondents achieved the highest possible rating when given a realistic case scenario to assess and plan instruction?

As shown by Ball and her colleagues (e.g., Hill et al., 2007), and findings by the CGI team (e.g., Frank et al., 2001), knowledge of children’s mathematical thinking can be influential in changing teachers’ instructional strategies and can potentially increase their abilities to cater for various levels of children’s mathematical understanding when it is presented to teachers in a coherent network of knowledge. The LFIN is a tool that is intended to provide such a network of knowledge. It is therefore imperative that the impact

of this tool be evaluated so that we better understand how to help our teachers understand and use it more effectively.

Acknowledgement

The research reported in this paper was supported by a grant from the NSW Department of Education and Training.

References

- Beswick, K., Watson, J., & Brown, J. (2005). Teachers' confidence and beliefs and their students' attitudes to mathematics. In P. Clarkson, A. Downton, D. Gronn, M. Horne, A. McDonough, R. Pierce, & A. Roche (Eds.), *Building connections: Theory, research and practice* (Proceedings of the 28th annual conference of the Mathematics Education Research Group of Australasia, pp. 68-75). Melbourne: MERGA.
- Bobis, J., Clarke, B., Clarke, D., Thomas, G., Wright, R., Young-Loveridge, J. & Gould, P. (2005). Supporting teachers in the development of young children's mathematical thinking: Three large scale cases. *Mathematics Education Research Journal*, 16, 27-57.
- Cai, J., Perry, R., & Wong, N. Y. (2007). What is effective mathematics teaching? A dialogue between East and West. *ZDM The International Journal on Mathematics Education*, 39(4).
- Fennema, E., Carpenter, T. P., Franke, M. L., Levi, L., Jacobs, V. R., & Empson, S. B. (1996). A longitudinal study of learning to use children's thinking in mathematics instruction. *Journal for Research in Mathematics Education*, 27, 403-434.
- Franke, M. L., Carpenter, T. P., Levi, L., & Fennema, E. (2001). Capturing teachers' generative change: A follow-up study of professional development in mathematics, *American Educational Research Journal*, 38, 653-689.
- Gravemeijer, K. (1994). *Developing realistic mathematics education*. Utrecht, The Netherlands: CD-B Press.
- Hill, H. C., Sleep, L., Lewis, J. M., & Ball, D. L. (2007). Assessing teachers' mathematical knowledge: What knowledge matters and what evidence counts? In F. Lester (Ed.), *Second Handbook of Research on Mathematics Teaching and Learning* (p.111-155). Charlotte, NC: Information Age Publishing.
- Li, Y. & Kulm, G. (2008). Knowledge and confidence of pre-service mathematics teachers: The case of fraction division. *ZDM Mathematics Education*, 40, 833-843.
- Mulligan, J. T. & Mitchelmore, M. C. (1997). Young children's intuitive models of multiplication and division. *Journal for Research in Mathematics Education*, 28, 309-330.
- New South Wales Department of Education and Training (2007). *Count Me In Too: Professional Development Package*, Sydney: New South Wales Department of Education and Training.
- Thompson, A. (1992). Teachers' beliefs and conceptions: A synthesis of the research. In D. B. Grouws (Ed.), *Handbook of research on mathematics teaching and learning* (pp. 127-146). New York: Macmillan.
- Van den Heuvel-Panhuizen, M. (2001). *Children learn mathematics: A learning-teaching trajectory with intermediate attainment targets for calculation with whole numbers in primary school*. Utrecht: Freudenthal Institute, Utrecht University/SLO.
- Wright, R. J. (1994). Working with teachers to advance the arithmetical knowledge of low-attaining 6- and 7-year-olds: First year results. In J. Ponte & J. Matos (Eds.), *Proceedings of the 18th Conference of the International Group for the Psychology of Mathematics Education* (Vol. 4, pp. 377-384). Lisbon, Portugal: PME.
- Wright, R. J., Martland, J., & Stafford, A. (2006). *Early numeracy: Assessment for teaching and intervention*. London: Paul Chapman Publications /Sage.

Language Negotiation In a Multilingual Mathematics Classroom: An Analysis

Arindam Bose

Homi Bhabha Centre for Science Education,
TIFR, India
<arindam@hbcse.tifr.res.in>

Manojendu Choudhury

Homi Bhabha Centre for Science Education,
TIFR, India
<manojendu@hbcse.tifr.res.in>

We have analysed multilingual mathematics classroom discourse to understand how languages are negotiated in student-teacher conversations under the assumption that language-use is a socially embedded process. We attempt to comprehend in what different ways languages (of instruction and local) are mixed and switched to arrive at better clarity and understanding of the mathematical contexts. We conclude that when teachers cultivate negotiation between languages by reinforcing the practice of code mixing and switching, students' understanding and participation is enhanced.

It is widely accepted that language plays an important role in thinking and learning. Central to learning and teaching school mathematics lies the "ability to communicate mathematically" (Setati, 2008, 2005). One of the main current policy documents for school education in India, *The National Curriculum Framework* acknowledges, "the kind of thinking one learns in mathematics is an ability to handle abstractions, and an approach to problem solving" (NCF, 2005). Language patterns and discursive practices in classrooms help students in abstracting mathematical concepts and relationships (Sfard *et al.*, 1998). It is also the use of language that leads to a conflict between students' negotiations with the mathematical meanings of the word problems, and the required mathematical operations therein. This happens due to inconsistency in their expectations arising from the everyday experience and the structure of the instruction language. Therefore, language proficiency becomes essential in comprehending the mathematical tasks, more so because mathematical abstractions become contingent upon the understanding of the language in which it is put forth (Halai, 2009). Hence, when students learn mathematics in a language other than their language of comfort, they need to learn both mathematics and the language, which can result in learning of a poor quality. The *Position Paper on Teaching of Mathematics* of the NCF asserts that "for a vast majority of Indian children, the language of mathematics learnt in school is far removed from their everyday speech, and especially forbidding" and that this becomes "a major force of alienation in its own right" (Position Paper, 2005, p.5). Evolving a sound language policy for effective teaching and learning of mathematics is hence of current relevance in Indian school education.

In this paper, we try to observe how more than one language is negotiated in such classrooms, starting with current literature and analysis of the excerpts from a set of mathematics lessons to explore the nature of language-use in a mathematics classroom.

Research on the Use of Languages In Mathematics Classrooms

India is linguistically diverse with many languages and even more dialects spoken by its people. Although Hindi is the national and the official language, English, the associate official language, enjoys a special status that is associated with the international recognition as well as the colonial history. However, during informal conversations it is commonly the local language that is used more often. Use of a mixture of vernacular and English is very common in urban settings. This situation is closer to Halai's descriptions of



classrooms in Pakistan (Halai, 2009) while Setati's reports from South Africa indicate even more diverse use of languages in mathematics classrooms (Setati, 2008, 2005). Interestingly, the world scenario is not very different according to Morgan's claim that in most of us are multilingual today and switch over to different languages in different ways while speaking using different vocabularies and syntactical constructions (Morgan, 2007).

The issue of multilingualism in mathematics classrooms raises a few questions. Halai (2009) for example, maintains that for understanding the mathematical ideas and concepts one has to be able to understand the instruction-language, which means, if the instruction-language is foreign to the learner then it becomes a "double" task of learning both the "foreign" language as well as the mathematics that is being taught – all at the same time. She suggests that this problem can be addressed only by allowing the movement between the languages used in the class, known as "code-switching". This has remained the focus of many studies of late. Setati (2008, 2005) as well advocates code switching in the backdrop of the new language policy currently under way in South Africa's post-apartheid regime.

Clarkson (2007) discusses Kern's empirical study to ascertain how learners comprehend foreign language texts using their first learnt language L1. He argues that L1 facilitates semantic processing, while if a learner were to process the input exclusively in L2 (second language/formal language of instruction), then she might run into trouble handling syntactically complex or harder sentences. He adds that translation is not always beneficial or reliable as it might not reflect the exact meaning. However, the exact meaning can be retained by replacing few words in L2 with words from L1. Hence the use of code mixing and switching helps in such situations for better understanding and comprehension.

However, there is little research that might help us understand the role of language and specific curriculum content in the light of learners' interactions (Barwell, 2005). Therefore, by looking at code-mixes, code-switches and hybrid languages, one may expect to make better sense of the ways learners socialise into discursive practices and their ways of using and interpreting given arithmetical tasks.

Research Framework

The main question on which we focus in our analysis is: how do participants in a mathematics classroom negotiate the use of two languages through code mixing as well as code-switching? We enumerate the various outcomes that follow this negotiation. We are interested in observing how knowledge of more than one language is used in communication and how diversity of knowledge and its comprehension is integrated as a result of which a new set of knowledge (of language and content) is constructed. We have made an attempt to address these issues in the present work.

Code Mixing and Code Switching

Code switching is a practice of switching between two or more languages in a conversation or an utterance, while code-mixing happens when switch between the languages is only for "one or few words" (Farrugia, 2009). In Indian classrooms, code mixing is inherent and quite predominant in the student-student interaction and to a lesser degree in the teacher-student interaction. Code switching, when it occurs, is also accompanied by code mixing. To keep things in proper perspective, we will first describe code mixing and then differentiate it from the code switching.

Code-mixing: each sentence is spoken in one language, let us call it the primary language, with words (subject, predicate, object, adjectives, verbs/auxiliary verbs)

substituted by words from a second language, say, secondary language; ***without disturbing the original sentence structure, which is in the primary language.***

Example: "first problem mein kya karna hai?" / (*What is to be done in the first problem?*). The underlying sentence-structure indicates that the primary language is Hindi and it is "mixed" with two words from English, the secondary language.

Example: "... sun lo phir wapas you discuss, ok" / ("*... listen, then again you discuss, ok*"). Underlying sentence-structure indicates that the primary language is English and "code-mixing" occurs with the incorporation of four words of Hindi.

Code switching: when the primary language is switched to the secondary language (i.e. from Hindi to English or vice-versa), as a consequence of which, the sentences may remain as a combination of English and Hindi, but the structure of the sentences changes and their roles interchange (primary language becomes secondary and vice-versa).

Example: "each book ka cost tha seventeen rupees/ each book's cost is rupees seventeen/ tho how much money I spent?" / (this whole utterance was spoken by the teacher, an example of "repetition with translation" and code-switching).

There can be different communicative contexts where code mixing and switching can be used, for example, the linguistic form of English-Urdu mix as reported in Halai's (2009) work. In the Indian context utterances and conversations involving language swapping (interchangeably using primary and secondary languages) are very common; examples of which are discussed below in the "observations" section.

Sample and Methodology

The classroom sessions observed and recorded using a video camera, were multilingual in nature. These sessions were part of a camp that was held at HBCSE, Mumbai (Bombay) for 21 (12 boys + 9 girls) grade 6 students of age 10-11 years from a neighbourhood English medium school. Camp-classes were held over a period of two months every Thursday for one and a half hours. Students were selected by their respective class teachers on the basis of their performance in the school mathematics test, and had secured less than 40% marks. All the students knew Hindi and English, although some spoke a home language different from these (for example, Marathi, Tamil). Teaching was conducted by an HBCSE member-researcher fluent in English, Hindi and Marathi.

The medium of instruction in the camp was English. However, the teacher as well as the students used Hindi, which we consider here as the first learnt language. In urban India, the phenomenon of code mixing is very common and is a regular feature in daily-life conversations though not so much in the formal classrooms. Especially in most English-medium schools (including the one these students came from) the practice is to use only English in the classrooms. Use of any other language is generally discouraged. In this camp, however students and the teacher overtly used English and Hindi in the classroom.

For the analysis, clips of different episodes of the lessons were made which depict some interesting student-teacher exchanges involving significant amount of code mixing and switching occurring in tandem. These clips were then transcribed for the analysis. In these sessions the teacher discusses six word problems with the students, who were expected to solve them in groups of two. Whole class interaction between students and the teacher happens when they first discuss the problems and later when they discuss their respective solutions. There are five different sessions of which the transcript is recorded and labelled 'a)' through 'e)'. English translations are given in the parentheses, wherever

needed; the numerals before the teacher-utterances indicate the line numbers in the respective transcripts. "T" and "C" stands for "teacher" and "student" respectively.

Problem-Tasks Given to Students

The following word-problems ('i' through 'vi') were given to the students. The teacher presented them in a story-telling manner contextualising the word-problems.

- i. Jay is older than Rahim, Rahim is older than Sheela. Sheela is younger than Jay and Sangeeta is older than Jay. List the people from oldest to youngest.
- ii. One morning an ant fell down a hole 2 metres deep. She would climb $\frac{1}{4}$ of a metre every day. At this rate, how many days ant will take to come out?
- iii. Mini interchanged two digits of the number 3840 and the number increased by 990. Which digits did Mini interchange? Explain your answer.
- iv. If one story-book costs Rs 8, how much will seventeen books cost?
- v. Raghav goes to college by bus whose one-way fare is Rs 4. Then, how much money does Raghav spend in 26 days a month in his travel to college and coming back?
- vi. Divide a square into four equal parts that cover the whole of the square. Find as many such divisions as possible.

Observation and Analysis

In all the 5 transcripts that we analysed, there were altogether 155 monolingual sentences (either completely in Hindi or completely in English) and 150 sentences where code mixing occurred. This shows that the use of code mixing was a characteristic feature of this particular mathematics classroom. The number of instances of code switching from Hindi to English was 30 and from English to Hindi was 29.

Code-mixing

From the transcripts, we find that code mixing results in:

1. free exchange of conversation establishing classroom practices,
2. the students building a rapport with the teacher by mixing informal modes of addressing the teacher (for example, using the term "Didi"), which is reaffirmed by the teacher when she uses the term "beta" (*son*) to address the students. This normally happens when the student or the teacher is too engrossed in the classroom process, for example: a) 25 C: *bahut didi hard hai/(didi it's too hard/)*
3. "Didi" is the Hindi word for elder sister. The student who was engrossed in the task, suddenly exclaimed "didi"! The same student addresses the teacher as "teacher" on other occasions.
4. Additionally, code-mixing in mathematics classrooms also enhances the knowledge of vocabulary of a "foreign" language of instruction, as evident from the following utterance: a) 30 T: *bade se chhota/ oldest matlab bada/ old insaan ko chhota bolenge kya? (old to young/ oldest means older/ will we call an old person young?)*

Code mixing also ensures continuity in conversations, particularly, when a person is unable to think of a proper word or a phrase in the middle of a conversation. Use of equivalent words or phrases borrowed from other language(s) not only helps to attain better comprehension but also helps to maintain a continuous flow of the conversation. So, lack of language proficiency does not distract students from the mathematical problems.

The students were not accustomed to mathematical discourse, which allowed code switching and code mixing since this is discouraged in the school (they are not allowed to speak in languages other than English). Students in the camp-session, however, quickly grasped this practice of code mixing and got involved in the classroom discussions freely with their peers and the teacher. Exposure to this practice allows each student to assert her individuality. Hence, in their zeal to share their newly found status as answer-providers to the problems posed by the teacher, all the students became enthusiastic to share their answers with the whole class irrespective of their proper understanding of the problems.

Code switching

From transcripts of the HBCSE camp mathematics classroom, we note a few points: first, students engage in code-switching (moving from one language to another) especially moving from the language of instruction to a local language. Code switching occurs on account of a need felt by learners to make sense of the given instructions and also of the involved mathematics. Generally there is a shift to local language as soon as there is some conceptual difficulty. Such difficulties include comprehension of complicated problems, clarification of embedded concepts, making sense of the instructions and difficult vocabulary (Barwell, 2005). Examples of more such occurrences are discussed below:

Repetitions in terms of translations. The instances of code switching commonly occurs when a direct translation of a statement is made, repeating the original statement. For example:

a) 32 T: see, I am older than you matlab main badi hoon/(... *I am older than you means I am older*). Here, the teacher directly translates an English statement into Hindi to elaborate problem (i). Neither the English nor the Hindi utterance was part of the problem. Whereas, in the following two utterances, the teacher gives a direct translation of the English statement as an elaboration of problem (v) into Hindi:

d) 17 T: Raghav is a college student/hmm/He goes to college, he travels to college by bus everyday/

d) 18 T: matlab bus se jata hai, bus se aata hai from his house/ok/(*means goes by bus, comes by bus from his house/ok*).

In another instance, the teacher translates a Hindi statement into English to reinforce the understanding the of problem:

d) 7 T: each book ka cost tha seventeen rupees/each book's cost is rupees seventeen/

We note here that the original Hindi statement is an instance where code mixing has been used very effectively to elucidate the English statement uttered subsequently. The fact that in the first statement the teacher says "seventeen rupees" indicates that here the primary language is Hindi, whereas the second statement is completely in English, i.e. the primary language is English and the cost is stated in terms of "rupees seventeen" spoken in the way it is written. That is, while writing the currency and its unit, the general norm is to write the unit of the currency first followed by the amount (say, Rs 100/-), whereas in the spoken language the amount is stated first followed by the unit of the currency. Another example of such an instance is:

d) 21 T: bus se jata hai, bus se aata hai/ his one-way ticket of bus is rupees four/ (*goes by bus, comes by bus/ his one-way ticket of bus is rupees four*/)

Mathematical terms and operations. English was always used for mathematical terms and operations while the rest of the sentences were in Hindi; verbs and predicates were commonly in English. There are numerous instances of such utterances, one of them is produced below (problem vi):

e) 21 T: "yeh square ka char equal part karke chahiye mujhe"/ (*I need four equal parts of this square*). Here the technical terms "square", "equal part" are used in English while explaining this problem. The teacher illustrates technical terms using English words in the following example (problem ii):

a) 8 T: second question kya hai ki ek subah ek ant ek hole mein gir gayee/ two metre ka hole hai/ ab woh ant chalna shuru kiya/ (*second question is that one morning an ant fell in a hole/ hole is of two metre/ now that ant started climbing*).

a) 9 T: everyday woh kitna karti hai?/ one by four metre cover karti hai/ haan/ to poora do metre karne ko usko kitne din lagenge?/ How many days?/ (*everyday how much does it do?/ it covers one by four metre/ yes/ then how many days will it take to complete two metre?/ how many days?*).

Explanations. Explanations given by the teacher were mostly in Hindi. For example, in problem (i):

a) 4 T: Jay is older than Rahim/Rahim is older than Sheela/Sheela is younger than Jay and Sangeeta is older than Jay/

a) 5 T: to aapko likhna hai sabse bada kaun hai/aur usse chhota, usse chhota, usse chhota, sabse chhota kaun hai/aise sabke naam likhne hain/line mein (*so you need to write who is eldest, and younger, and younger, and younger, and youngest is who/ like this you write all the names/ in a line*).

a) 6 C: ascending/

a) 7 T: nahin, sabse bada se chhota, descending/ oldest to youngest/sabse bade se chhota/ (*No, oldest to the young, descending/ .../ oldest to the young*).

The purpose of code switching in lines a) 4 and a) 5 is evidently to bring out a clear understanding of problem (i). In addition, the teacher attempts to teach the meanings of technical terms like, "ascending", "descending", "older", and "younger" using code mixing and code-switching.

Enforcement of authority, discipline in the classroom. While enforcing authority and discipline, the teacher switches from primarily a Hindi utterance to English as reflected in the following: e) 20 T: beech ka poora square baaki hai/main bol rahee hoon, hanso mat/this is difficult problem/I want solution/ (*whole square in the middle is remaining/I am speaking, don't laugh/this is difficult problem/I want solution*).

Achievements in problem-tasks. In camp sessions, while having an informal discussion with the teacher in Hindi, the children switched over to English when they felt confident of their answers and were eager to declare their achievement to the class as the following:

e) 25 C: Teacher, Teacher/

e) 26 C: Teacher, Teacher, I got/Teacher, one, two, three, four/

This instance also illustrates the high degree of class involvement in the exercise.

Code switch from formal to informal language. In addition to the code switch involving the two languages, English and Hindi, the teacher also switches from a formal version of Hindi to a very colloquial form of the same language. This sets up the environment of shared learning and ownership in the classroom. For example:

b) 14 T: Ok/ who is going to explain how five days? Lavesh chalo batao, kaise aaya panch days? (...?/ *Lavesh com'on tell, how did you get five days?*).

Here the code switch takes place as a language-swap from English to Hindi, as well as from the formal form to an informal form. Here the utterance in English is also an example of the hybrid sentence (discussed below).

Now, consider the following excerpt:

c) 31 T: six days kiska aaya? Sayali? Nahin aaya six days? Aapka aya tha?/ nahi aya? (T: who got six days? Sayali? You did not get six days? You got it?/ did not get?)

c) 32 T: iske alawa kisika alag answer aaya? Sudhir/ kisika correct answer hai pata nahin/ bindaas bolo jo aaya hai woh! (T: who else has got a different answer? Sudhir/ don't know if anyone has correct answer/ freely say whatever you've got/).

There is a clear transition from formal to informal language as is visible from c) 31 and 32. The use of the highly informal "slang" like "bindas" meaning "carefree" makes the classroom setting informal thereby encouraging the students to open up and take part in the discussion. Here, the teacher is also trying to break students' hesitation by declaring that she does not yet have the correct answer, so, anyone can take the call.

In the following instance, in addition to a code switch in language, there is a switch from formal to informal language as well that builds a social connection of the problem situation (problem iii) with the students:

a) 11 T: third question/ Mini tumlogon jaise camp ki ladki hai woh/ usne kya kiya three eight four zero, three thousand eight hundred forty – yeh number liya/ (third question/ Mini is a camp-girl like you all/ what she did, three eight four zero, three thousand eight hundred forty – she took this number/).

Hybrid Sentences

There are instances when the primary language is not very explicitly distinguished from the secondary language, with the whole sentence being code-mixed in a complicated manner, and the resultant structure of the grammar represents a sort of hybrid structure. For example, while explaining problems (iv) and (v) the following conversation took place:

d) 4 T: bought eight story books/ how many books I bought?/

b) 14 T: ok/who is going to explain how five days?/

In b) 14, an apparent error in the grammatical structure is arising because of a code-switch from English to Hindi, but the Hindi sentence is constructed by substituting all the words from English (i.e. a complete code-mixing has occurred). Thus, hybrid sentences occur when the speaker bends or takes liberties by mixing the grammar of one with the other.

Conclusion and Implications

Code mixing and switching facilitates in connecting verbal language and visual supplements from everyday experience as was seen in the ant-problem (problem ii). They become particularly visible when the teacher is introducing a word-problem with its illustrations in the local language. Arguably, code mixing and switching allows simultaneous language learning in addition to mathematical learning. This usually happens when semantic differences of the technical terms are brought forth with the use of language-switches. Code switch from formal to informal language is used as a mark of solidarity that empowers the students in the classroom. This helps the teachers in intervening in student-interactions resolving their confusions or dilemmas in case there is any. This also helps in breaking the authoritative approach of mathematics teaching, which is normally followed in formal classroom set-ups. In addition, this results in students socialising into discursive practices in the classrooms. Yet when required the teacher uses code-switching to establish some authority in the class. Sometimes non-availability or unfamiliarity of particular terms in a language while speaking gives rise to code mixing

and switching. For teachers and students this offers comfortable and flexible mode of communication and therefore serves as a useful pedagogical resource.

As per our observations the language of learning may be different from the language of teaching, therefore for effective mathematical understanding code mixing and switching to student's first learnt language becomes helpful. In order to facilitate and improve learning and achievement in mathematics classrooms where the language of instruction is different from learners' local (or first learnt) language, giving recognition to code mixing and switching allows the learners to make use of the local language as a learning resource. This helps the students to understand the problem better and makes way for a better group work. We argue that code mixing and switching result in 1) development of the socio-mathematical practices in the classroom, and 2) enhanced understanding of the language of instruction making way for better comprehension. However, we feel there is need of more investigation about the role of code mixing in mathematics classrooms and their different manifestations, including the creation of hybrid sentences. There is also less material available on metalinguistic awareness, i.e. the ability to reflect and manipulate structural features of language, in the light of the development of mathematics learning. It is important in our view to note the metalinguistic usages of the "words" in mathematics classrooms that necessitates code mixing and switching.

The process of establishing effective and productive policies related to teaching multilingual students needs revision and reflection to alter current beliefs and assumptions regarding the use of language(s). We speculate that the issue of multilingualism in mathematics classrooms has a universal bearing, subject to local adaptation.

Acknowledgements

We are grateful to the teacher and her students for allowing us to sit through the classroom sessions and to use the video-clips for our work. We are thankful to K Subramaniam, Shweta Naik and Richard Barwell for giving us ideas and suggestions.

References

- Barwell, R. (2005). Integrating language and content: issues from the mathematics classrooms. *Linguistics and Education* 16, 205-218.
- Clarkson, P. (2007). Australian Vietnamese students learning mathematics: High ability bilinguals and their use of their languages. *Educational Studies in Mathematics* 64 (2), 191-215.
- Halai, A. (2009). Politics and practice of learning mathematics in multilingual classrooms: Lessons from Pakistan. In R. Barwell (ed.). *Multilingualism in mathematics classrooms: Global perspectives*. Bristol: Multilingual matters.
- Farrugia, M. T. (2009). Reflections on a medium of instruction policy for mathematics in Malta. In R. Barwell (ed.). *Multilingualism in mathematics classrooms: Global perspectives*. Bristol: Multilingual matters.
- Morgan, C. (2007). Who is not multilingual now? *Educational Studies in Mathematics* 64 (2), 239-242.
- NCF (2005). *The National Curriculum Framework*. New Delhi: National Council of Educational Research Training (NCERT).
- Position paper, Mathematics. (2005). National Curriculum Framework 2005 Position Paper of National Focus Group on Teaching of Mathematics. New Delhi: National Council of Educational Research Training (NCERT).
- Setati, M. (2008). Access to mathematics versus access to the language of power: The struggle in multilingual mathematics classrooms. *South African Journal of Education* 28, 103-116.
- Setati, M. (2005). Learning and teaching mathematics in a primary multilingual classroom. *Journal for Research in Mathematics Education* 36 (5), 447-466.
- Sfard, A., Neshet, P., Streefland, F., Cobb, P. and Mason, J. (1998). Learning mathematics through conversation: Is it as good as they say? *For the Learning of Mathematics* 18 (1), 41-51.

The ‘Number Proficiency Index’: Establishing the Starting Point for Mathematical Instruction in High School

Phil Brockbank

All Saints’ College, WA

<phil.brockbank@allsaints.wa.edu.au>

This paper summarises part of a longitudinal study to investigate the possibility of establishing an Index that would indicate the appropriate starting point for instruction for students entering high school and reports on the first group of students to sit the Index tests in 2005, comparing the predictive nature of the tests with other state and national tests through correlations. The Index tests focus on the number construct and it is envisaged that by identifying the student’s deficiencies or strengths in this construct it may be possible to devise interventionist strategies or extension activities that would increase the probability of success in later years.

Premature teaching of mathematical concepts prior to educational and conceptual readiness can have a significant negative impact on subsequent conceptual understanding and this alone should be sufficient reason to ensure that teachers are aware of the preparedness of their students (Clarke, 2005; Stein and Lane, 1996). The main purpose of this paper is to examine the predictive reliability of a new bank of tests designed to measure the level of understanding of the number strand. Numerous studies have shown that there is often a decline in achievement after transition (Carvel, 2000; Collins & Harrison, 1998; Galton, Gray, & Ruddrick, 1999) so it is imperative that this decline does not continue to impact on performance if the situation can be remedied by interventionist strategies and pedagogical adjustments (Doig, McCrae, & Rowe, 2003). Transition does not only affect students who struggle but can also impede the progress of more able students who find that the first year of high school presents few new challenges, with an increased volume of work but little increase in difficulty over the work completed in primary school, often leading to disillusionment and lack of control (Green, 1997; Kirkpatrick, 1992). As many mathematics classes are not *streamed* in the first year of high school lessons are often targeted to the middle ability students, which can have a detrimental effect on both the lower ability student and those more able.

In 2005, tests were administered to 172 new students in Year 8 (the first year of High School in Western Australia) in four different schools. Each student received a final score, which was referred to as their Number Proficiency Index (NPI). Data for these same students were gathered from the Western Australian Literacy and Numeracy Assessment (WALNA) for Year 7 and the Monitoring Standards in Education (MSE9) test at Year 9. From 2008, the National Assessment Program Literacy and Numeracy (NAPLAN) replaced the previous full-cohort literacy and numeracy assessment programs of all Australian States and Territories for students in Years 3, 5, 7 and 9. Further data were collected from the students exit point from high school by weighting their final scores according to the difficulty of the course undertaken. Multiple correlations were calculated to investigate the predictive nature of the WALNA test, MSE9 test and the NPI. The results reported in this paper are for the first group of students to have passed through the five years of high school from 2005 to 2009. The tests have also been given to students entering high school in each of the years from 2006 to the present.



Whilst acknowledging that the measure of mathematical ability is not solely determined by the number construct, it is the intent of this report to show that it the most reliable predictor of success in later years. If it can be shown that deficiencies in the understanding of number contribute to unsatisfactory mathematical performance in later years, then it may be possible to alert teachers to these deficiencies so that they may provide alternative strategies to assist understanding. Also, very able students may be exposed to more challenging work, either in the same strand or in a related strand involving applications, rather than repeating what they have already mastered. Indeed, one of the main objectives in establishing the Index is to provide teachers with a *simple numerical value* that may be used as a guide to the most appropriate starting point for mathematical instruction in the first year of high school. This does not imply *streaming* in the true sense of the term but more of an adaptive approach to teaching pedagogies to suit different abilities.

Theoretical Framework

As attitudes to learning are influenced greatly by a student's perception of their potential to be successful and this is profoundly influenced by their self-belief in their ability or lack thereof (Dweck, 2000), the determination of the NPI may increase confidence in students who have a negative distorted perception of their own ability and even encourage a more adventurous approach to mathematics for those students with above average understanding of number.

Teachers have a profound influence on the achievement of their students in mathematics (Askew et al 1997). Further, teachers' beliefs influence their practices and preferred pedagogies (Beswick, 2007) and teachers will tend to choose the middle ground when faced with a large class of students with different abilities. The challenge is to get teachers to acknowledge that it is wrong to believe that students are all at the same stage of development when entering high school and will thus make the necessary changes to their teaching style to accommodate these differences.

Given that the correlation between a student's NPI and their exit results in Year 12 is sufficiently high to be used as a predictive model then it seems reasonable to assume that an improvement in a student's NPI would indicate better *number sense* and result in improved performance in later years. Number sense is defined as not only a person's general understanding of number and operations but also their ability to use this understanding and flexibility to develop strategies for dealing with numbers and operations usefully (McIntosh, Reys, & Reys, 1993).

Differences in curriculum delivery in high school have been widely recognised as one of the major factors in students failing to sustain their academic progress after transition (Kruse, 1996). Other factors include a change in the students' belief in themselves as learners, expectations of performance on the part of teachers and the inappropriateness of the content with respect to the ability of the students (Kirkpatrick, 1992). These factors are compounded when a student becomes bored or frustrated with the lack of challenge (Green, 1997) because they have had to spend a large part of their first year in high school repeating what they have already mastered (Yates, 1999).

Students being promoted chronologically are assumed to be at the same level of intellectual development, but a simple observation of the *physical* differences observable in any class in the first year of high school would show this to be a naive assumption. As success in the first year of high school can have a profound influence on the choice of subjects and vocational pathways (Siemon, Virgona, & Cornielle, 2001), it is vital that the

students are provided the best opportunities. To do this, teachers need to be acutely aware of the base level of each of the students. The Index may help to indicate which students would benefit from teaching strategies that emphasise mastery, understanding and improvement (Midgley & Maehr, 1998).

Research that has shown transition difficulties do not last long for most students (Davison, 1996) did not focus on mathematics and it appears from the results of this study that the difficulties can last for many years although transition is, most likely, only one contributing factor to a complex problem. The lack of basic mathematical skills can have a compounding effect on success over many years and there is even a possibility that these same students are at an even greater disadvantage in being less skilful in adjusting to change in teaching style and pedagogy after transition (Eccles, Lord, & Midgley, 1991).

Despite the number of changes occurring in the educational landscape in Australia it should be noted that the decline in achievement following transition (Collins & Harrison, 1998; Galton, Gray, & Ruddrick, 1999) is not dependent on the age of the child when transition occurs as the same decline is evident in countries which have different transition periods (Anderman, Maehr, & Midgley, 1999).

Students entering high school are often not equipped to handle the emphasis on measuring performance (American Psychological Association, 1996) and exposure to a set curriculum that is based on the assumption that students are all at the same level of understanding (and skills), particularly in the number construct. As understanding and skills are intertwined (Wu, 1999) and not a dichotomy of one or the other it would be advantageous to students if intervention programs could be devised and implemented in the initial year of high school to challenge or improve the skills, and therefore the prospects of success of these students. Of course, this would require teachers to accept and adopt a range of pedagogies and the prospects of this happening are not great given current research findings (Cohen & Hill, 2001; Fullan, 1993). The linkage and continuity problems between schools may not be solved by the introduction of a national curriculum (Gorwood, 1991) so the importance of this research is not diminished by the changes occurring in Australia at present.

Methodology

Feeder Primary Schools. Before administering the tests the number of contributing primary schools was determined. Table 1 shows the data for the 2005 intake.

Table 1

Number of Feeder Primary Schools (Minimum 2 students) - 2005.

School Type	Number of Primary Schools
Government School	7
Catholic School (co-educational)	15
Catholic School (boys only- Boarding)	11
Anglican School (co-educational)	13

It seems that all of the schools were dealing with a large number of feeder schools and these numbers became much larger when the minimum number of contributing students was not used as a parameter. This makes the creation of linkages between primary and secondary schools very difficult and this requires further consideration as there is evidence

that improved linkages can have a positive effect on transition (McGee, 1987). In the competitive environment of the private school system it may be that it is more important to *sell* the school rather than ensure that there is a sustained and effective linking arrangement between the schools that concentrate on the learning progression of the child (Abrams, 2000; Herrington & Doyle, 1998). This lack of linkage can exacerbate the problems faced by teachers in trying to establish the proficiency of students in their care often resulting in repetitive curriculum delivery and testing.

The Anglican school has its own primary school on site that contributes over half of the high school entry year so the number of other feeder schools was somewhat surprising.

The NPI Tests

The NPI tests contributing to this research were administered during Year 8 of high school in 2005. Many schools in Western Australia are now starting high school at Year 7 and other schools are adopting a middle school approach by grouping Years 7, 8 and 9 as a distinctive identity in terms of administration. The tests will continue to be given either at the end of Year 7 or at the beginning of Year 8, between the national NAPLAN tests in Year 7 and Year 9.

Participants and the Structure of the Tests

A total of 172 students sat the original test in 2005. The students came from four different schools and eight teachers were involved in the administration of the tests. The tests are a combination of 20 multiple-choice questions and 60 short-answer questions on basic number skills with many of the questions being modified from an original 60 multiple-choice questions, first used in 2003. The questions do not necessarily increase in difficulty and are not grouped. Responses are either awarded one mark for a correct answer or no marks for an incorrect answer. Instructions are prescriptive and teachers are not allowed to offer any assistance. No examples are given on the test papers and students are not permitted to use calculators or other mathematical aids.

The tests are prepared in two booklets, both containing 40 questions and can be administered across two 40-minute periods or in one 80-minute session. Both tests contain 10 multiple-choice and 30 short-answer questions and are constructed in such a way that topics alternate throughout the test and do not necessarily increase in difficulty as it was not assumed here that individual difficulties could be pre-determined. Estimation and number line questions are used extensively in all topics as can be seen in Figure 1.

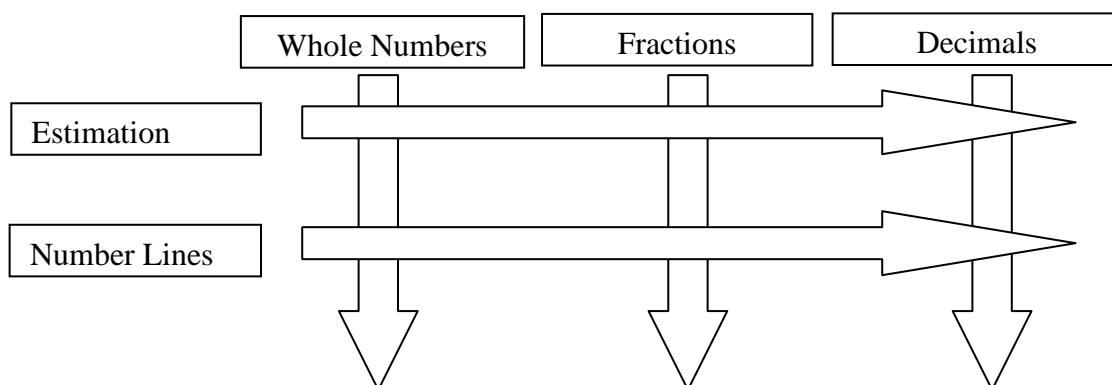

Figure 1. Structure of the NPI tests.

Data Collection and Reporting

The NPI is reported to teachers in raw score form, ranking lists, dot frequency diagrams, and separate results by gender and topic. The most important report for teachers simply indicates which of the three distinct categories *low*, *medium* and *high* the student falls into based on their raw score result from the NPI tests. This then indicates to the teacher those students who may need additional support and those students who do not need to repeat what they have already mastered. The categories are defined below:

- *Low* identifies the group of students who may benefit from interventionist strategies that may enable them to proceed successfully with work in number and measurement.
- *Middle* indicates the students who would be expected to work through the existing curriculum with very little change in content or delivery method.
- *High* identifies the group of students who would be provided with extension activities either in the same context as existing content or in a different context related to other areas of mathematics.

Discussion and Findings

The numbers in each category identified by their results in the NPI tests of 2005 are shown below in Table 2. The strategy to be adopted is also indicated in the table. It is interesting to note that 43 of the students had a very good understanding of number and could therefore benefit from becoming actively engaged in investigative learning and hands-on activities. The same could be said of the 31 students categorised as *low* but with a different emphasis concentrating on motivation and engagement. Whilst the recommended strategy for the *middle* group implies that no change is necessary to current practices it may be necessary to research the practices adopted by teachers in the transition year to ensure that they are encouraging students to think mathematically (Ruthven, 2002) and are not simply using repetitive processes that do not lead to sustained learning (Walshaw & Anthony, 2008).

Table 2
Results in Categories -2005 Test Year.

Category	Number	Strategy
<i>Low</i> (score less than 40)	31*	Intervention
<i>Middle</i> ($40 < x < 70$)	98	No change
<i>High</i> (score greater than or equal to 70)	43	Extension

Note. * Four students were special needs students with recognised learning difficulties.

The correlations shown in Table 3 below refer only to the 2005 Year 8 intake. The exit scores refer to the final mark obtained by the student when leaving high school and are taken from the scaled Western Australian Tertiary Entrance Examination (TEE) marks as provided by the Curriculum Council of Western Australia except for those students that did not sit the final examinations in which case the students scaled school mark was used. The scaling factors used were the same as those applied to the courses in Western Australia for the determination of the Tertiary Entrance Score (TES) that then provided each student with a Tertiary Entrance Rank (TER). Students who completed the lowest of the available

senior mathematics courses (Modelling with Mathematics) had their marks adjusted to reflect the relative simplicity of the course.

Table 3

Correlations -2009 Graduation Year.

Comparison	Correlations	n*
WALNA7 v MSE9	0.93	164
WALNA7 v NPI	0.84	170
MSE9 v NPI	0.91	169
WALNA7 v Exit Score**	0.66	143
MSE9 v Exit Score	0.71	155
NPI v Exit Score	0.79	163

Note. * Student numbers varied due to the length of time between comparative data.

** The Exit Score is the weighted score obtained by the student in their final year of high school.

Tracking the Pathway of the Students through High School

Once the students had completed their final year examinations it was possible to compare their results to their positioning from the NPI tests nearly five years earlier. No student categorised as *high* in the NPI tests completed the Modelling with Mathematics course in 2009, which was not a TEE course and did not require the students to sit an examination, and only four of these students in this category attempted the easiest of the three TEE courses with examinations available in Western Australia. No student in the *low* category attempted any course higher than Modelling with Mathematics and seven students did not do any mathematics courses in 2009. Students who were originally categorised as *middle* in 2005 were represented in all three TEE courses and their final results were spread across the entire state distribution.

Implications

By showing that the NPI is the most reliable predictor of success teachers may become more cognisant of the importance of establishing a measure of a student's number facility and making changes to existing practices. It is not surprising that the correlations between the WALNA in Year 7 and the MSE in Year 9 were so high considering that the content covered in both tests was very similar and there was less than two years between the tests. Correlations decreased with the passing of time so whilst the correlation between the NPI results and the exit scores is only moderately strong it is the strongest of the three exit score comparisons.

High scores on the NPI tests do not necessarily mean that a child is proficient in the context of number but merely that they have some procedural skills in the strand and are thus ready to begin their next stage of learning on the way to becoming competent. It is imperative that teachers know the ability of the students in their care *before* they start teaching the curriculum. If we are to accept that teachers and their practices have a profound influence on their student's achievement then it is clearly evident that every effort must be made to assist teachers in understanding the potential of their students. Unfortunately, there is little confidence in believing that teachers will change from what they have been comfortable doing (Fullan, 1993) or any guarantee that teachers who identify problems with their student's understanding of basic facts will change their pedagogy (Walshaw & Anthony, 2008).

It is hoped that this research will not only identify problems in the assumptions of teachers about the most suitable starting point for instruction, but will also be instrumental in offering realistic, potential solutions to the problem. At the very least it should help teachers to understand the futility of trying to teach high order concepts to students who have not mastered a basic understanding of the number construct. It may also provide the opportunity for more able students to avoid the repetitive nature of some of the content delivered in the first year of high school.

Further research will continue and will include a broader cross-section of school types and factors such as cultural and socio-economic considerations, pupil perceptions, organisational issues and gender differences.

Conclusion

If we accept that teachers are reluctant to change their ingrained conventional practices (Cohen & Hill, 2001) then we need to make it as easy as possible for them to identify the standing of their students in relation to their peers and against minimum benchmarks. The NPI has a sufficiently high correlation to the students exit score to be used as a predictor for success throughout high school. Given that teachers acknowledge the results of the NPI tests and consequently make changes to cater for both strengths and deficiencies this research may help to alleviate some of the concerns regarding the number of students excluded from effective mathematics learning because of their lack of challenge or their lack of proficiency with basic number skills.

References

- Abrams, F. (1993, March 19). Transition Teamwork. *Times Educational Supplement* 4003, Iv.
- American Psychological Association. (1996). Middle school malaise. *Family and Relationships*. Retrieved March 6, 2009, from <http://www.helping.apa.org/family/malaise.html>.
- Anderman, E., Maehr, M., & Midgley, C. (1999). Declining motivation after the transition to middle school: schools can make a difference. *Journal of Research and Development in Education* 32(3), 131-147.
- Askew, M., Brown, M., Rhodes, V., Johnson, D., & Wiliam, D. (1997). *Effective teachers of numeracy*. London: School of Education, King's College.
- Beswick, K. (2007). Teachers' beliefs that matter in secondary mathematics classrooms. *Educational Studies in Mathematics*, 65(1), 95-120.
- Carvel, J. (2000, January 4). *Summer schools for all 11-year-olds*. Guardian Unlimited. Retrieved March 6, 2009, from <http://www.education.guardian.co.uk/news/story/0,5500,118738,00.html>.
- Clarke, D. M. (2005). Written algorithms in the primary years: Undoing the 'good work'? In M. Coupland, J. Anderson & T. Spencer (Eds.), *Making mathematics vital* (Proceedings of the twentieth biennial conference of the Australian Association of Mathematics Teachers, Brisbane, pp. 93-98). Adelaide: AAMT.
- Cohen, D. K. & Hill, H. C. (2001). *Learning policy: When state education reform works*. New Haven CT: Yale University Press.
- Collins, J. & Harrison, B. T. (1998). Claiming and reclaiming education: The experiences of multilingual school students in transition from primary to secondary school. *Unicorn*, 24(1), 16-29.
- Davison, B. (1996). Middle schools cater for the age of information. *New Zealand Herald*, A15.
- Doig, B., McCrae, B., & Rowe, K. (2003). *A good start to numeracy: Effective numeracy strategies from research and practice in early childhood*. Camberwell, Vic: ACER.
- Dweck, C.S. (2000). *Self theories: Their role in motivation, personality, and development*. Philadelphia: Psychology Press.
- Eccles, J.S., Lord, S. & Midgley, C. (1991). What are we doing to early adolescents? The impact of educational contexts on early adolescents. *American Journal of Education*, 99(4), 521-542.
- Fullan, M. (1993). *Changing forces: Probing the depths of educational reform*. London, UK: Falmer Press.
- Galton, M., Gray, J. & Rudduck, J. (1999). *The impact of school transitions and transfers on pupil progress and attainment*. Annesley, Notts: Department for Education and Employment. Research Report RR131.

- Gorwood, B. (1991). Primary-secondary transfer after the national curriculum. *School Organisation*, 11(3), 283-290.
- Green, P. (1997). Moving from the world of the known to the unknown: The transition from primary to secondary school. *Melbourne Studies in Education*, 38(2), 67-83.
- Helme, S. & Stacey, K. (2000). Can minimal support for teachers make a difference to students' understanding of decimals? *Mathematics Teacher Education and Development*, 2, 105-120.
- Herrington, N. & Doyle, L. (1998) *Learning Progression Across the Primary/Secondary Divide*. All in Success: Centre for the Study of Comprehensive Schools 9(2), 10-12.
- Kirkpatrick, D. (1992). *Students' perceptions of the transition from primary to secondary school*. Paper presented at the Australian Association for Research in Education /New Zealand Association for Educational Research joint conference, Deakin University, Geelong 22-26 November. Retrieved January 21, 2002, from <http://www.aare.edu.au/92pap/kirkd92.003>
- Kruse, D. (1996). Transition and change: Early adolescence and the role of education. *Learning Matters*, 1(2), 59.
- McGee, C. (1987). *Executive report: The linkages project: Transition from primary to secondary school in New Zealand*. Wellington: Research and Statistics Division, Department of Education.
- McIntosh, A., Reys, B. J., & Reys, R. E. (1993). A proposed framework for examining number sense. *For the Learning of Mathematics*, 12(3), 42-46.
- Midgley, C. & Maehr, M.L. (1998). *The Michigan middle school study: Report to participating schools and districts*. Ann Arbor, MI: University of Michigan.
- Ministerial Council on Education, Employment, Training and Youth Affairs, MCEETYA (2007a). *National assessment program: Literacy and numeracy. Numeracy sample questions*. Retrieved 18 December 2009 from the World Wide Web: http://www.naplan.edu.au/test_samples/numeracy/numeracy.html
- Ruthven, K. (2002). Assessment in mathematics education. In L. Haggarty (Ed.), *Teaching Mathematics in Secondary Schools* (pp. 176-191). London: Routledge Falmer.
- Siemon, D., Virgona, J., & Cornielle, D. (2001). *The Middle Years Numeracy Research Project: 5-9, Final Report*: Department of Education, Employment and Training, Victoria, Catholic Education Commission of Victoria and Association of Independent Schools of Victoria.
- Stein, M. K. & Lane, S. (1996). Instructional tasks and the development of student capacity to think and reason: An analysis of the relationship between teaching and learning in a reform mathematics project. *Educational Research and Evaluation*, 2(1), 50-80.
- Walshaw, M. & Anthony, G. (2008) The teacher's role in classroom discourse: A review of recent research into mathematics classrooms. *Review of Educational Research*, 78(3), 516-551.
- Wu, H. (1999). Basic skills versus conceptual understanding: A bogus dichotomy in mathematics education. *American Educator* 1-7. Retrieved 30 August 2009, from http://www.aft.org/pubs-reports/american_educator/fall_1999
- Yates, L. (1999). Transitions and the year 7 experience: A report from the 12 to 18 project. *Australian Journal of Education*, 43(1), 24-41.

Walking the Talk: Translation of Mathematical Content Knowledge to Practice

Barbara Butterfield
University of Wollongong
<butterfi@uow.edu.au>

Mohan Chinnappan
University of Wollongong
<mohan@uow.edu.au>

Recent debates on students' learning outcomes in mathematics have shifted the focus to better understanding the types of knowledge that teachers need in order to support children. In the present study, we examined the quality of knowledge of a cohort of prospective teachers along the dimensions developed by Ball et al. (2008). We found support for the contention that beginning teachers tend to have built a body of content knowledge. However, that knowledge remains less germane to teaching children. Implications for translation of this knowledge for teaching are presented.

In the past decade or so, we have noticed a steady decline in the number of young Australians pursuing mathematics, in particular, advanced mathematics in high schools. This trend has raised alarm among teachers, tertiary institutions and other key stakeholders alike. While the problem is most visible in secondary education, the root of the problem appears to lie in the attitudes towards, and knowledge of, mathematics that children develop in years K-6. How can we start arresting and possibly reversing this trend in mathematics in Australia? One potentially fruitful area could be to take a serious look at the quality of our mathematics teacher and teaching. The education system of countries that are consistently ranked in the top five, based on Trends in Mathematics and Science Study (TIMSS) results, regard quality of their teachers as being the major contributory factor for the performance of their students. Thus, it would seem that mathematics learning, to a large extent, is dependent on teacher quality. But what aspect of teacher quality is instrumental in improving access to and participation in mathematics?

Context and Significance of Issue

Teacher quality as it relates to mathematics learning can be given many interpretations but our focus here is on the knowledge that teachers bring to support deep mathematics learning and understanding. Nationally, these knowledge categories have been gaining increasing attention in professional standards set by teacher accreditation bodies such as the New South Wales Institute of Teachers, Queensland College of Teachers, and the research community (Frid, Goos, & Sparrow, 2009). The need to ensure that our teachers of mathematics had developed an adequate knowledge base of mathematics was also echoed in the recent review of mathematics education conducted by the Group of Eight Universities that drew the attention of teacher educators to examining the quality of mathematics acquired by primary teachers (Brown, 2009).

Many studies focus on what pre-service teachers (PSTs) do *not* know (Mewborn, 2001). Others have looked at misconceptions including Afamasaga-Fuata'I (2007) who found evidence that students come to university with misconceptions. There is also a paucity of research about the PSTs who *do* have 'strong conceptual knowledge of mathematics' (Mewborn, 2001, p. 33). Our study is set against this background and is motivated by the desire to better understand the state of our prospective teachers' knowledge of mathematics and teaching as they entered and completed our course. Data on PSTs' knowledge is expected to: a) provide clear directions for design and conduct of



methods subjects and b) better inform us about the kind of professional experiences that would be needed before our PSTs commence their professional work as fully-fledged teachers.

Related Literature

The issue highlighted in our introduction has been the subject of several lines of inquiry. We examine the broader issue within the context of the types of knowledge that teachers require to engage students in a variety of ways. Shulman (1987) pioneered the area of research that focussed on the relationship between teacher knowledge and teaching by identifying two major dimensions of that knowledge: Subject Matter Knowledge and Pedagogical Content Knowledge. The positive correlation between teachers' mathematics knowledge and student performance is gaining increasing support particularly since the seminal work by Ma (1999) where it was found that superior mathematical learning in China could be ascribed to the mathematical expertise of their teachers.

Delaney, Ball, Hill, Schilling, and Zopf (2008) have been active in analysing and developing Shulman's (1987) knowledge categories that are relevant to mathematics. Their ongoing research has established a solid platform for the study of fundamental knowledge components that a teacher needs. Instead of taking into account the multiple facets of PSTs' knowledge and beliefs, there appears to be a tendency among teacher educators to view PSTs as simply lacking particular knowledge. Furthermore, although some PSTs are able to successfully solve mathematical problems, many are unable to explain the concepts and procedures they perform (Mewborn, 2001).

Significantly, Ball, Hill, and Bass (2005) found a correlation between a teacher's mathematical knowledge and student achievement. However, Ball, Hill and Bass (2005) conclude that teaching PSTs more content knowledge is not the answer, and teaching for understanding is required. As well as the content, *what of mathematics*, teachers also need to know *how to teach Mathematics* which led Delaney et al. (2008) to coin the term Mathematical Knowledge for Teaching (MKT). MKT is multilayered, interdependent, and interrelated. Hill, Ball and Schilling (2008) provide more nuanced dimensions of MKT: Common Content Knowledge (CCK), Specialised Content Knowledge (SCK), Knowledge of Content and Students (KCS) and Knowledge of Content and Teaching (KCT).

While CCK, SCK, KCS and KCT provide a solid theoretical framework, Delaney et al. (2008) suggest that there is a need for further empirical evidence gathered from a range of contexts. We pursue this issue in the present study.

Conceptual Framework

Data analysis and interpretations were guided by the following schematic representation of teacher knowledge for teaching mathematics (MKT) (Figure 1) (Hill, Ball & Schilling, 2007, p. 174). The four dimensions are defined as follows:

Common Content Knowledge (CCK): Mathematical knowledge and skill possessed by a well educated adult.

Specialised Content Knowledge (SCK): Knowledge of how to: a) use alternatives to solve a problem; b) articulate mathematical explanations; c) demonstrate representations.

Knowledge of Content and Students (KCS): Knowledge that combines knowing about mathematics and knowing about students. Knowledge of how to: a) anticipate what

students are likely to think; b) relate mathematical ideas to developmentally appropriate language used by children.

Knowledge of Content and Teaching (KCT): Knowledge that combines knowing about mathematics and knowing about teaching. Knowledge of how to: a) sequence content for instruction; determine instructional advantages of different representations; b) pause for clarification and when to ask questions; c) analyse errors; observe and listen to a child's responses; d) prompt; e) pose questions and probe with questions; f) select appropriate tasks.

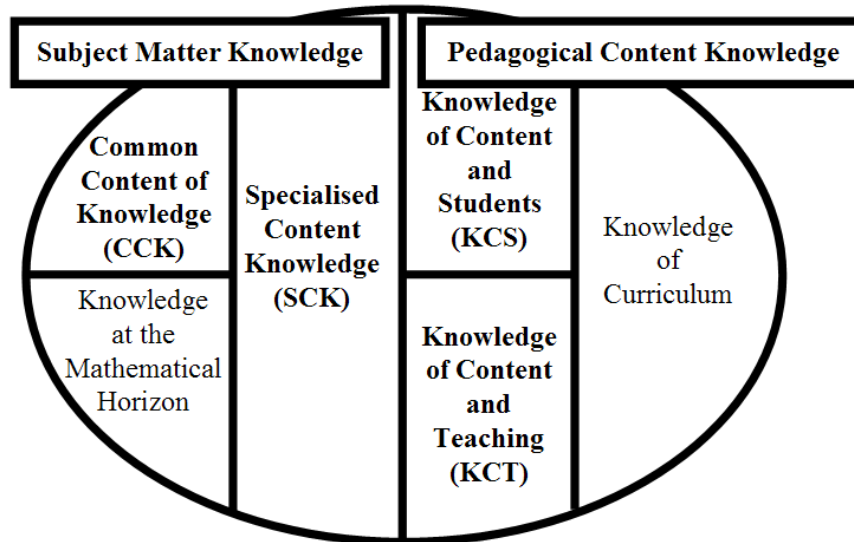

Figure 1. Schematic representation of teacher knowledge for teaching mathematics (MKT).

Research Questions

Are there differences in the activation of pre-service teachers' MKT as used in the context of solving a focus problem (Truss Bridge Problem)?

What are potential relations among the four dimensions of MKT that prospective teachers activate in the context of a focus problem (Truss Bridge Problem)?

Methodology

Design

The aim of our larger study is to examine the issue raised by Ball, Hill and Bass (2005) by investigating potential relations between the four categories of MKT before and after PSTs' professional experience in schools. We followed a design experiment which Cobb, Confrey, diSessa, Lehrer and Schauble (2003, p. 8) suggest as appropriate for 'engineering particular forms of learning and systematically studying those forms of learning within the context defined by the means of supporting them'. The study involves two phases: Phase 1 (pre-professional experience) and Phase 2 (post-professional experience). This report concerns Phase 1 of the larger project in which PSTs attended 16 hours in lectures and 8 hours in tutorials. Data about pre-service teachers' MKT reported in the present study were collected in the tutorials that followed the aforementioned sessions.

Participants:

A cohort of 40 Graduate Diploma of Education students participated in the study. The cohort included both Australian and Canadian students who have completed a variety of undergraduate degrees including psychology, social sciences and science.

Context and Procedures for Data Collection:

We provided a range of prompts and support structures in the course of 4 weeks prior to the focus activity via a series of lectures and tutorials. The teaching program included demonstrations and opportunities to use aids such as arrays, Base-10 Blocks and activities from NSW *Count Me In Too* programme. The focus of the lectures and tutorials was teaching, learning, and assessing numeracy. The activities in the lectures and tutorials were geared at fostering awareness among PSTs of the need to provide both developmental and differentiated opportunities for children to make connections in mathematics. The tutorial activities were designed to be learning opportunities that moved the students beyond talking and reading about pedagogy (Ball & Cohen, 1996). PSTs were thus involved in an authentic teaching and learning context where they could independently and collaboratively explore preconceived ideas and extend ideas. This strategy afforded explanation, representation, utilisation of language, as well as interpretation of others' thinking of the content and pedagogical issues.

Following the four-week intensive session the participants were asked to solve the Truss Bridge Problem (focus activity), designed for upper primary students. The goal of the problem was to determine the number of beams on either side of the given bridge as well generating patterns for bridges of similar design but of different lengths. PSTs were asked to think like a child and concomitantly 'put on a teacher's hat' in order to identify and scaffold potential difficulties that could occur in the process of understanding and solving this problem. We provided a coloured photograph of the Truss Bridge Problem (Figure 2), the NSW K-6 Syllabus (Board of Studies, 2002) as well as concrete aids such as coloured paddlepop sticks and grid paper, to support the activation of PSTs' mathematical knowledge for teaching. In addition, we provided four focus questions to participants (Table 1).

Table 1
Focus Questions

	Question
A	What are some of the difficulties that might be experienced by Stage 3 children in understanding and solving this problem?
B	How would you help children develop skills and knowledge in solving this type of problem?
C	How would you weave Working Mathematically Processes in the course of doing the activity?
D	What are the types of connections or relations that can be supported via this activity? How can these connections be extended?

The solution of the problem involves integration of content knowledge from a number of strands such as geometry and algebra, and use of a range of problem-solving strategies, such as reasoning and pattern identification. The richness of this problem to elicit the four

knowledge categories was assessed by comments from an experienced primary teacher. We are confident that we provided ample prospects within the context of the Truss Bridge Problem for the PSTs to access MKT, which includes CCK, SCK, KCS and KCT.



Figure 2. *Truss bridge problem.*

Data Analysis

The purpose of the study is to identify and describe four categories of pre-service teacher knowledge, namely, CCK, SCK, KCS and KCT. The participants' written responses and work samples (comments, diagrams and photographs) were examined to determine activation of the knowledge components.

Research Question 1

- 1) Are there differences in the activation of pre-service teachers' MKT as used in the context of solving a focus problem (Truss Bridge Problem)?

The means and standard deviations for the four knowledge components are presented in Table 2. The table shows that our PSTs' accessing of CCK was almost three times that of the other categories. This indicates that during the solution of the Truss Bridge Problem, our PSTs tended to solve the problem as adults despite being scaffolded with both teaching aids and focus questions that prompted attention to the other three knowledge components.

Table 2:

Component Means and Standard Deviations

Component	Mean	Std. Deviation
CCK	4.15	1.73
SCK	1.50	1.33
KCS	1.47	0.99
KCT	1.38	0.90

Research Question 2

What are potential relations among the four dimensions of MKT that prospective teachers activate in the context of a focus problem (Truss Bridge Problem)?

The bivariate correlations were computed for the four knowledge dimensions (Table 3). Common Content Knowledge (CCK) is significantly correlated with Specialised Content Knowledge (SCK) and Knowledge of Content and Students (KCS). Likewise, teachers' SCK was significantly related to KCS. Knowledge of Content and Students (KCS) is related to Knowledge of Content and Teaching (KCT).

Table 3
Bivariate Correlation Results

Component	CCK	SCK	KCS	KCT
CCK		0.740**	0.437**	0.062
SCK			0.475**	0.139
KCS				0.518**
KCT				

** Correlation is significant at the 0.01 level (2-tailed)

Three Vignettes of PSTs' Responses

In order to illustrate the interconnectivity amongst the knowledge components we provide vignettes of three pre-service teachers' actions.

Vignette 1 (PST1). PST1 stated that a child might have difficulty in seeing that the triangles share a side (KCS). In order to aid a child's visualisation and to also enable physical interaction, PST1 demonstrated how paddlepop sticks could be used (Figure 3). She commented, "The child can touch and count the sides" (KCT). This identifies an instance of the relationship between KCS and KCT. While this shows some understanding of MKT, notions of 2D shapes and one-to-one correspondence, the participant did not articulate how she would assist the child to extend the links to patterns, which is necessary to deduce lengths of different size bridges. Even though PST1 had initially solved the problem herself in adult terms, "Twice the number of triangles plus one is equal to the number of sticks" (CCK), she did not make the connections in ways that would enable children to develop the sequence (KCT).

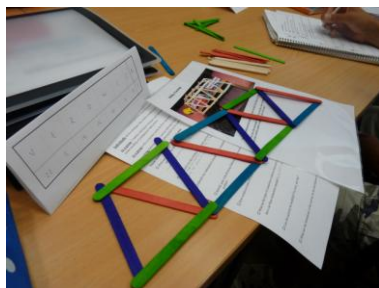

Figure 3: PST1.

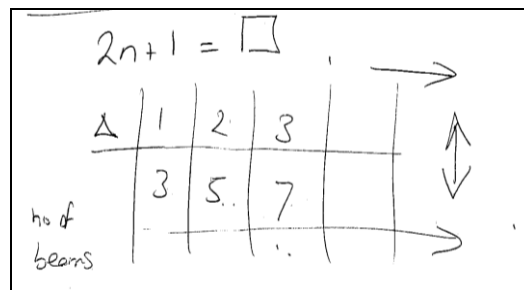

Figure 4: PST2.

Vignette 2 (PST2). PST2 wrote the equation $2n + 1 = \square$ and drew a table to show how the pattern is developed (Figure 4). Other patterns were also outlined, "... ordinal numbers along the top and uneven numbers along the bottom" (SCK). To teach this she "... would tell the patterns as I filled in the table on the whiteboard". PST2 identified the only difficulty a child might have "is they are unable to read the question" and to assist a child, she would "read the question aloud to the child". While this demonstrates a level of support, there is a need for further development of KCS and KCT.

Vignette 3 (PST3). Activation of CCK, involving geometry and algebra, is identified with PST3 stating, "The problem requires breaking down from 3D to 2D and then it is $2n + 1 = \square$ ". PST3 noted to assist a child he would, "teach the 3 times tables and also

encourage physical engagement (hands on) with objects”. These comments indicate that PST3 needs further development of KCT in order to translate CCK. The only evidence of any difficulties a child might face in understanding and solving this problem is, “Children might play with the sticks”, indicating a need for further development of KCS.

Discussion and Implications

Our current work is part of a larger study with an aim to capture change in the quality of the four dimensions of teacher knowledge that Ball, Thames and Phelps (2008) suggest is required for effective pedagogical mathematical practice. We examined the knowledge of a cohort of pre-service teachers before their professional experience. Our research was structured around two key research questions.

Analysis of data relevant to Research Question 1 suggests that PSTs activated a higher proportion of common mathematical content knowledge (CCK) in relation to the other three knowledge components, namely Specialised Content Knowledge (SCK), Knowledge of Content and Students (KCS) and Knowledge of Content and Teaching (KCT). The examination of links (Research Question 2) indicated strong positive correlations amongst all the elements with the exception that KCT was found to be related to KCS and not the others.

Given that all our participants had completed a variety of undergraduate degrees we expected a reasonable level of CCK in their MKT indicative of a strong mathematical knowledge base and some degree of understanding of how children learn mathematics. This expectation was supported by the results of the study as our teachers produced lower knowledge in three of the four constituents of the knowledge complex proposed by Ball, Thames and Phelps (2008). We are conscious that our data collection was conducted in the first semester of the students’ teacher education program and the results would seem to be consistent with their level of understanding of mathematical pedagogy one could expect at this stage of the development as professionals.

The draft of National Curriculum for K-10 mathematics (ACARA, 2010, p. 1), suggests that teaching ought to support children’s ability to ‘recognise connections between the areas of Mathematics and other disciplines and appreciate mathematics as an accessible and enjoyable discipline to study’. The data from this study indicates that while the beginning teacher did show evidence of acquisition of the four knowledge clusters, this knowledge of the PSTs is not quite robust enough to buttress the development of the above relations. However, we anticipate that this cohort of student teachers would have built a wider knowledge base after their professional experiences and further completion of other courses. The second phase of the study will examine if this is indeed the case.

Our measurement of pre-service teacher’s knowledge within the category of KCT was somewhat constrained due to the limitation of not having access to classroom children. In their responses, the participants had to ‘work’ within a hypothetical situation. While pre-service teachers’ CCK was evident within the context of the Truss Bridge Problem, it is possible that given a wider range of problems, additional evidence of knowledge within CCK and the other categories could be obtained. This issue could be the subject of further investigation.

While our prospective teachers’ CCK seems to be relatively strong, a further development of this knowledge into SCK is a critical aspect of teacher knowledge development as argued by Ball et al. (2008). Current debates on teacher mathematical knowledge required for teaching seem largely driven by concerns with CCK. But this knowledge has to be tempered so that it is germane to making connections with children’s

prior understanding of mathematics and numeracy. We contend this process and resulting children-friendly mathematical knowledge have not received sufficient attention in current debates and reform statements. The professional experience of our teachers is expected to engage them in ways that would bring a higher degree of focus to SCK.

The implications for translating the content matter of mathematics into effective pedagogical practice are paramount in raising the profile of mathematics. Assisting pre-service teachers to ‘walk the talk’ could lay the necessary foundations in our primary schools.

References

- ACARA (2010). *Draft Australian Curriculum*. Sydney: Australian Curriculum Assessment and Reporting Authority. Retrieved 2 February 2010 from <http://www.australiancurriculum.edu.au/Home>
- Afamasaga-Fuata'I, K. (2007). Student teachers' content knowledge and understanding of primary mathematics. *Proceedings of the 2007 annual conference of the Australian Association for Research in Education*. Retrieved 30 February 2010 from <http://www.aare.edu.au/07pap/code07.htm>
- Ball, D. L., & Cohen, D. K. (1996). Reform by the book: What is--or might be--the role of curriculum materials in teacher learning and instructional reform? *Educational Researcher*, 25(9), 6-8.
- Ball, D. L., Hill, H. C., & Bass, H. (2005). Knowing mathematics for teaching: Who knows mathematics well enough to teach third grade, and how can we decide? *American Educator*, 29(3), 43-46.
- Ball, D. L., Thames, M. H., & Phelps, G. (2008). Content knowledge for teaching: What makes it special? *Journal of Teacher Education*, 59(5), 389-404.
- Board of Studies (2002). *Mathematics K-6 Syllabus*. Sydney: Board of Studies NSW.
- Brown, G. (2009). *Review of education in mathematics, data science and quantitative disciplines: Report to the Group of Eight Universities*. Retrieved 26 February 2010 from <http://www.go8.edu.au/storage/go8statements/2010/Go8MathsReview.pdf>
- Cobb, P., Confrey, J., DiSessa, A., Lehrer, K. & Schauble, L. (2003). Design experiments in educational research. *Educational Researcher*, 32(1), 9-13.
- Delaney, S., Ball, D. L., Hill, H. C., Schilling, S. G., & Zopf, D. (2008). Mathematical knowledge for teaching: Adapting U.S. measures for use in Ireland. *Journal of Mathematics Teacher Education*, 11(3), 171-197.
- Frid, S., Goos, M. & Sparrow, L. (2009). What knowledge is needed for effective teaching of mathematics? *Mathematics Teacher Education & Development* (pp. 1-3). Melbourne: Arena.
- Hill, H. C., Ball, D., & Schilling, S. (2008). Unpacking “pedagogical content knowledge”; conceptualising and measuring teachers' topic-specific knowledge of students. *Journal for Research in Mathematics Education*, 39(4), 372 - 400.
- Ma, L. (1999). *Knowing and teaching elementary mathematics: Teachers' understanding of fundamental mathematics in China and the United States*. Mahwah, NJ: LEA.
- Mewborn, D. (2001). Teachers content knowledge, teacher education, and their effects on the preparation of elementary teachers. *United States Mathematics Education Research Journal*, 3, 28-36.
- Shulman, L. (1987). Knowledge and teaching: Foundations of the new reform. *Harvard Educational Review*, 57(1), 1-22.

Scratching Below the Surface: Mathematics through an Alternative Digital Lens?

Nigel Calder
University of Waikato
<n.calder@waikato.ac.nz>

Merilyn Taylor
University of Waikato
<meta@waikato.ac.nz>

A key element in the examination of how students process mathematics through digital technologies is considering the ways that digital pedagogical media might influence the learning process. How might students' understanding emerge through engagement in a digital-learning environment? Interactive software that has cross-curricula implications and facilitates thinking in rich, problem-solving environments is emerging. *Scratch*, a free-to-download graphical programming environment provides opportunities for creative problem solving. This paper is part of an on-going study into the ways mathematical learning evolves through these alternative environments. It reports on a pilot research study involving 10-year-old children using *Scratch* to create mathematical digital learning objects, including games, and examines the ways mathematical thinking was facilitated through this process.

Processing mathematical activity through a digital pedagogical medium frames the nature of the engagement in a distinctive manner, with the understanding that emerges fashioned in alternative ways (Calder, 2008; Keiren & Drijvers, 2006). Building on earlier research involving students processing mathematical tasks with spreadsheets (Calder, 2008), this paper utilises an interpretive lens to examine the manner in which mathematical thinking emerges when children work with *Scratch*, an interactive, programming language. *Scratch* is a media-rich digital environment that utilises a building block command structure to manipulate graphic, audio, and video aspects (Peppler & Kafai, 2006). It incorporates elements of Logo including 'tinkerability' in the programming process (Resnick, 2007). This allows the user to combine the programming building blocks (at times incorporating measurements) and to immediately observe the outcome of that programming. The blocks can be deconstructed and recombined as users logically develop desired movements and effects. *Scratch* facilitates creative problem solving, logical reasoning, and encourages collaboration, and students can use geometric and measurement concepts such as coordinates and the unit circle (Peppler & Kafai, 2006).

When learners engage in mathematical investigation, they interpret the task, their responses to it, and the output of their deliberations through the lens of their pre-conceptions; their emerging mathematical discourse in that perceived area. Social and cultural experiences always condition our situation (Gallagher, 1992), and thus the perspective from which our interpretations are made. Learners enter such engagement with pre-conceptions of both the mathematics, and the pedagogical medium through which it is encountered. Their understandings are influenced by a variety of cultural forms, with particular pedagogical media seen as cultural forms that model different ways of knowing (Povey, 1997). The engagement with the task likewise alters the learner's conceptualisation, which then allows the learner to re-engage with the task from a fresh perspective. This cyclical process of interpretation, engagement, reflection and re-interpretation continues until there is some perceived reconciled interpretation of the situation. Other researchers have likewise perceived learning emerging through digital environments by an iterative process of re-engagements of collectives of learners, media, and other environmental aspects, with the mathematical phenomena (Borba & Villareal,



2005). In essence, the mathematical task, the pedagogical medium, the pre-conceptions of the learners, and the dialogue evoked are inextricably linked. It is from their relationship with the learner that understanding emerges. This understanding is their interpretation of the situation through those various filters (Calder, 2008).

When learners investigate in a digital environment, some input, borne of the students' engagement with, or reflection on the task, is entered. The subsequent output is produced visually, almost instantaneously (Calder, 2009) and can initiate dialogue and reflection. This will lead to a repositioning of their perspective, even if only slight, and they re-engage with the task. They engage in an iterative process, alternatively attending to the task and their emerging understanding. This allows for a type of learning trajectory that can occur in various media (Gallagher, 1992), but is evident in many learning situations that involve a digital pedagogical medium (Borba & Villareal, 2005). There are, however, affordances of the digital medium associated with the process that influence the nature of the engagement (Calder, 2008). These affordances frame the nature of the problem-solving activity. This paper considers two forms of mathematical thinking that emerged when the participants created mathematical games to facilitate understanding of number concepts with their younger, 'buddy' class. One is the evolution of logic and reasoning that developed through the creative problem solving during the programming process, while the other involves the conceptual area of geometry. We examine the first through an iterative, interpretive process, to see how the children's mathematical thinking evolved as the groups created, and then refined their games. We also consider the geometric thinking interspersed through the process as the children transformed their 'sprites' (animated figures), including moving them to specific locations.

Approach

This paper continues an ongoing examination of how digital pedagogical media influence the learning process in mathematics. Specifically, it reports on a pilot research project involving a digital-learning class of 26, Year 6 children. Students had access to their own computer and although this was their first experience with *Scratch*, they were confident and experienced with a range of software. Their teacher was the school's ICT coordinator. The students worked in pairs, which were self-selected and single gender. Over the two-week research period, the students wrote daily blogs articulating their progress and reflections, students and the teacher were interviewed, and classroom observations (both written and photographic) were recorded. These data, along with informal observation and discussion formed the data, which were then systematically analysed.

The first week involved the students doing a range of distinct, structured tasks to familiarize them with the *Scratch* environment. All groups were given the same design brief: To design and build a mathematics game suitable for facilitating the number understanding of their Year 1 'buddies'. The students interviewed their Year 1 'buddy' class partners and consulted the Year 1 teacher regarding appropriate mathematics concepts and activities with which the class was familiar. This helped determine the nature of games they would devise. The younger children also gave formative feedback on the games during the development process.

A feature of the approach taken by the teacher was the sharing of the work that had been done each day. Each project was loaded on to a data stick near the end of the session and one student took responsibility to coordinate displaying the work on the data projector. Each group would explain what was being done and any characteristics of their

programming. The other students could ask questions and provide feedback and suggestions. The students' respect for each other and confidence with this process was a feature of the classroom culture and clearly had been engendered before the project took place. The feedback session also gave opportunities for the teacher to formatively assess, to identify aspects that might need individual or whole-class feedback, and for students to identify other class members who could assist them with aspects of their design problems. The projects in these varying evolving stages and the accompanying feedback likewise became part of the data.

Results and Discussion

Problem-solving in Scratch

While the design brief was set within a mathematics context, a central element of the thinking that took place was in the area of problem solving. The students familiarised themselves with the task and then through iterations of action and reflection modified their game. At each juncture, the feedback to their engagement with the task modified their approach and enabled them to re-engage from a fresh perspective. Thus their thinking evolved and the games became more refined as they reset their investigative sub-goals based on the feedback and subsequent reflection. The feedback was in various forms: immediate visual feedback within the programme as they changed their programming script; fellow student and teacher feedback and suggestions, feedback from the intended users, and feedback involving other groups that unfolded in the public domain. Each of these varying forms of feedback led to reflection, and then re-engagement from a modified perspective.

For instance, the 'Jabadah' group began with a "stage" and explored changing the colour of it, how to move the 'sprites', and some of the pre-programmed effects. They settled on a stage colour and then experimented with moving the 'sprites' that made up the letters of their group name. They wanted to make the J hit the A and set it off spinning, but it moved in a continuous loop. The following observational data, recorded their discussion:

James: We can't get it to go forever-we'll need to explore different loops.

Don: What if we glide until it points to the direction?

James: We can point towards.

Don: What about exploring the use of "sense?"

They tried a few options and considered the visual feedback resulting from each change in the coding. They were developing a sense of the relationship between the programming script they had selected and modified the measurements of, and the associated movement of the 'sprite' on the screen. The next day they continued this relational experimentation by "using existing scripts to see how to manipulate things differently". During this process of experimentation they worked out how to design and operate a spinner. When they reached a point of uncertainty they used a 'predict and check' approach, reflected on the outcome, before refining their evolving script. This involved further relational thinking, as recorded in the written observations, they "looked at how the different scripts affected the action of the sprites" and "experimented with the number scripts in their own project by putting in variables and then running the script to see what would happen." This illustrated a development in their relational thinking as they became more effective at predicting the outcome of their changes to the programming script.

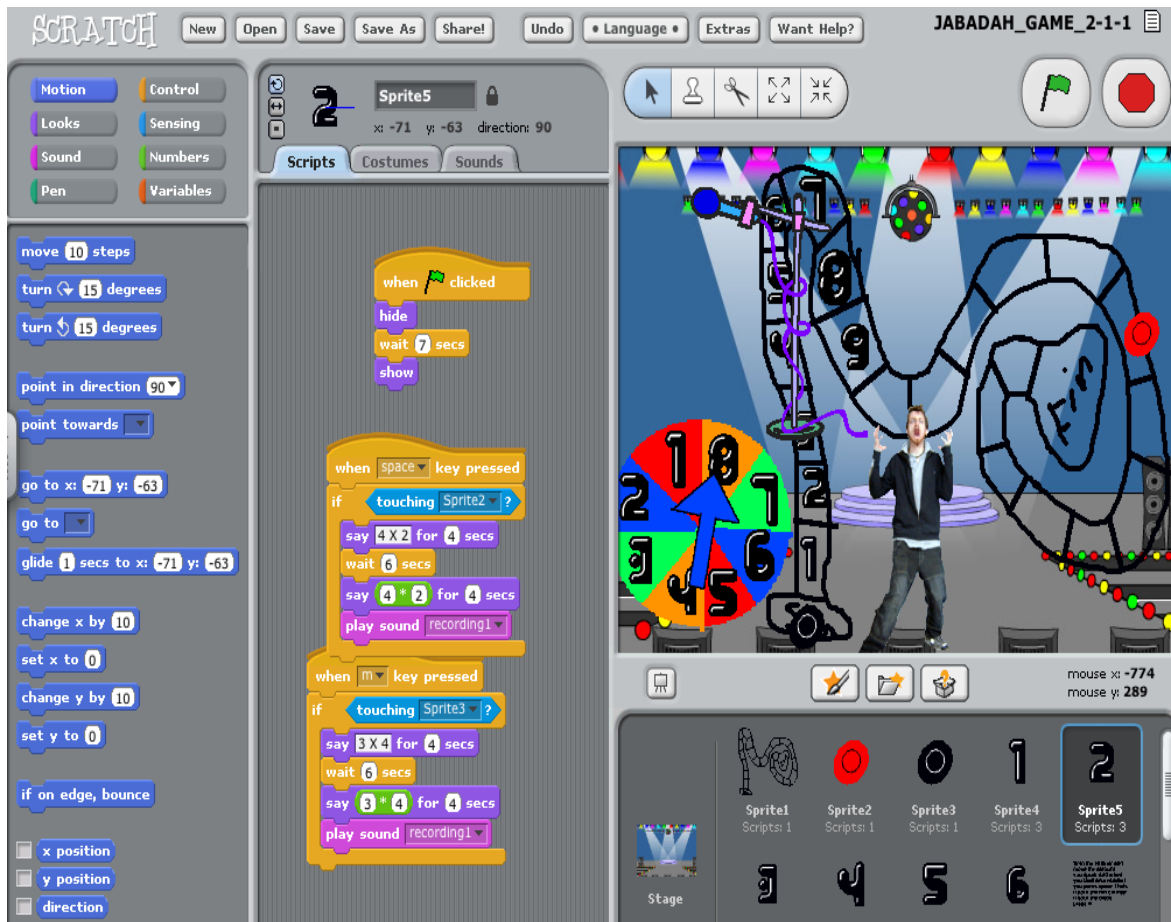

Figure 1: The group ‘Jabadah’s workspace as their game is in development.

While the spinner was now operating successfully, they had encountered another problem. Although they were able to move the blue and red counters on their board game whilst *Scratch* was in design mode, they had not been able to move the counters in full screen mode. They experimented with other scripts line by line. Eventually, through evaluation of the feedback to their input, they were able to achieve this aspect. With each engagement they reflected on the digital feedback, modified their interpretation of the situation, and re-engaged with the task from this modified perspective. Their thinking evolved through the problem-solving process. As well as the relational thinking, they also used logic and reasoning to evaluate and interpret the situation, before resetting their sub-goal in the investigative process. They generalised from a range of actions and after reflection, determined the type of command that produced the desired effect. They also responded to other feedback:

MF: How does the code work, tell me what that code means?

James: It just spins randomly and lands on a random place.

Although the question hasn’t been answered in the detail intended, the student nevertheless has reflected on the question and articulated their response in terms of both language of movement (spins, lands) and chance (random). The children also articulated the movement of the spin in mathematical language, which they understood, even though the script was modified rather than created:

Don: All we did was go: “When sprite 15 clicked repeat random 3 to 100 and turn 45 degrees.”

This indicated development in the children’s understanding of rotation and the link between the numerical size and the movement of the turn. In the interviews, they articulated the value of the ‘buddy’ feedback and how they responded to it by adapting the game.

James: They said it was fun. They thought the spinner was cool.

Don: We changed the questions from multiplication to addition because it was too hard for them.

Eventually, they were satisfied with the game and the way it operated. Data from other groups also highlighted the way *Scratch* facilitated problem solving. For instance, when Geoff had run into a problem with the logic of the scoreboard of their game:

Geoff: I’ll need to problem solve that.

He then investigated spacing, proportion, colour, and size aspects of the scoreboard. The challenge of the problem-solving process was evident in the blog from another group:

We are trying to figure out how to use a gravity effect and how to use the variables. We are finding it challenging to make our character Jetman jump in the air without spinning 15 degrees.

The teacher also discussed problem solving in her final interview. She talked about some of the benefits:

The communication and competencies coming through with the use of it. That whole problem solving and questioning (aspects). So the whole thing of exploratory learning was where it was a very valuable bit of software.

She further stated that two of the benefits for the children using the programme were in problem solving and mathematics.

Further Thinking in Geometry and Measurement

Instances of thinking in geometry and measurement emerged during the iterative, hermeneutic process through which ‘Jabadah’s’ game evolved. The trialling of variations of movement, angle size and coordinates, and linking these to the instantaneous effects would have enriched their understanding of these aspects. There was also evidence of geometric thinking from other groups. These are recorded as different snippets rather than being situated within each group’s overall process.

The ‘Jigsaw’ group explored changing the length of time for repeat movements and varying angle sizes. They later articulated their attempt to make the letters glide into place, eventually figuring out how to use coordinates to specify where the ‘sprite’ was to glide to and how to keep the characters in place. The ‘Mats’ group likewise aimed to explore animation and movement. They worked out how to use the glide command and x- and y-coordinates to move to different positions on their stage. From the interview data:

Stan: We have to remember where the numbers (their ‘sprites’ for the game they were devising) go, so they all move to the middle and then they mix around to different places.

Matiu: We want to put the numbers in position.

Later, they applied this learnt skill in their game to moving asteroids through space. They were observed manoeuvring a spaceship and dodging spinning asteroids. Interestingly, at another point, when writing the script for their ‘sprite’ to move they initially recorded: “turn 90 degrees, wait one second” 10 times, rather than using a more efficient: “repeat 10 times command.”

After choosing a stage and ‘sprite’, another group, XE2, were observed immediately engaging with movement and the positioning of their ‘sprite’. This involved the use of coordinates to indicate the position they wanted the ‘sprite’ to glide to. They were not concerned with the exact position of the coordinates, but more the general position associated with them. They spent time exploring different coordinates and how this affected the position of the ‘sprite’, gaining a sense of the relationship between the values of the coordinate and the position on the screen. They also programmed ‘wait time’ of 5 seconds and ‘hide time’ of 6 seconds. ‘PC’ also experimented with time, and what the interval signified, when creating their game. They formulated a programme that offered simple addition equations such as ‘ $7 + 4 =$ ’ and the ‘buddy’ children needed to match the solution to the appropriate number of aliens.

Peter: If you get this right, it tells you, and then it changes to the next question in fifteen seconds.

In the ‘Hemzie’ group blog, data indicates that they had marked plots on a pencil-and-paper map they had made to help them work out how to move the ‘sprite’ from one place to another. Their aim was to explore ‘sprites’ and how to change from one ‘sprite’ to the next. They thought this aspect was challenging. Later they worked out the movement effects they required and were incorporating sounds. They recorded and linked an appropriated sound for each movement. They eventually enabled a car ‘sprite’ to be moved by inputted commands.

Brian: The reward is that you get to steer the car around for 20 seconds.

The ‘Lissa’ group also had initial difficulty with the movement, but learnt from the feedback sessions. They were eventually able to have a beach ball move around the screen through a maze, controlled by the keyboard arrows.

The ‘Pig’ group explored similar areas but with an additional transformation. They wrote in their blog:

We have learnt how to move letters and characters by programming a key on the keyboard to move an object. We learnt that if you use a text box you can’t make an animation with effects, it will just enlarge your ‘sprite’.

They articulated that their initial aim was to find out about position and effects. They were exploring movement and angles.

While engaged in the programming experiences, *Scratch* appeared to facilitate the children’s understanding of angles and measurement, with experimentation enabling them to find what was appropriate to use in their particular context. Errors with programming appeared to have a positive effect in that they prompted the children to willingly experiment with commands to achieve the desired appearance and effects. The ‘tinkerability’ of *Scratch* facilitated exploration with angles and the measurement of time and length. Students could actively experiment with angle size, for example, in ways that would not be possible without the digital medium. Likewise, the understanding that emerged regarding coordinates was inherent in the process of exploring the movement and position of the ‘sprites’. Clements, Sarama, Yelland, and Glass (2008) discussed how game contexts and practice can significantly improve spatial performance. The study not only involved participants with spatial movement and location while designing the games, the trialling and modification process would also have influenced the children’s spatial awareness.

Conclusion

Scratch software proved to be an engaging and relatively easy to use space for problem solving. Additionally, it proved to be an effective medium for encouraging communication and collaboration (Otrell-Cass, Forret, & Taylor, 2009). Each of the above episodes illustrated how *Scratch* provided a worthwhile and motivating programming environment to explore some mathematical ideas. The challenge of creating a mathematical activity or game for younger students overtly positioned the programme in mathematics, while implicitly, it simultaneously demanded that mathematical ideas be utilised to develop their game. What is not quite so certain is the extent to which new mathematical learning occurred during this process. The students in this digital class were quickly able to access and understand the programming capabilities and used mathematical thinking in their approach to problem solving. In the classroom, where electronic media and an environment where discussion and sharing were the norm, the students were able to transform their ideas into workable programmes. It proved to be a medium whereby programmes were easily composed and decomposed, thus encouraging the use of critical, meta-cognitive and reflective skills. *Scratch* was also intrinsically motivating. The sharing sessions were pivotal in that they provided a forum for displaying work, and as a way of collectively helping each other to solve programming problems. *Scratch* therefore, provided an opportunity for students to develop their thinking, a key competency that is integral to the *New Zealand Curriculum* (Ministry of Education, 2007). The facilitation of logical thinking from initial empirical concepts, as students test ideas in response to feedback, and the influence of programme feedback in the evolution of students' geometric ideas has been reported elsewhere (e.g., Clements et al., 2008).

While not specifically designed to facilitate conceptual thinking in a particular mathematical area, there were clear indications of the children engaging with mathematical ideas and to some extent enhancing aspects of their mathematical thinking through the use of *Scratch* in the development of the digital learning objects. Their spatial awareness, understanding of angles, and positioning sense through the use of coordinates, were all engaged to varying degrees. There was also evidence of relational thinking as the children made links between their input, the actions that occurred on screen, and the effect of specific variations of size and occurrence of single or iterative procedures. However, the process the participants undertook more directly facilitated mathematical thinking through the creative problem-solving process it evoked, and the development of logic and reasoning as they responded to the various forms of feedback. These mathematical conclusions can nevertheless only be tentative. While consideration of mathematical thinking was one intention of the research study, it was predominantly set up as an open investigation into the potential of the software across a range of learning areas. A more focussed study on the mathematical learning implications may have been more productive in the revealing of mathematical thinking, and may have reached less tentative conclusions.

Acknowledgement

We wish to acknowledge Dr Mike Forret, Dr Kathrin Otrell-Cass, and Sheena Saunders, who were part of the *Scratch* research team.

References

- Borba, M. C., & Villarreal, M. E. (2005). *Humans-with-media and the re-organisation of mathematical thinking: Information and communication technologies, modelling, experimentation and visualisation*. New York: Springer.
- Calder, N. S. (2008). *Processing mathematical thinking through digital pedagogical media: The spreadsheet*. Unpublished doctoral thesis. University of Waikato.
- Calder, N. S. (2009). Visual tensions when mathematical tasks are encountered in a digital learning environment. In Tzekaki, M., Kaldrimidou, M. & Sakonidis, C. (Eds.), *In search of theories in Mathematics Education*, Proceedings of the 33rd annual conference of the International Group for the Psychology of Mathematics Education. Athens: PME.
- Clements, D. H., Sarama, J., Yelland, N. J., & Glass, B. (2008). Learning and teaching geometry with computers in the elementary and middle school. In M. K. Heid & G. W. Blume (Eds.). *Research on Technology and the Teaching and Learning of Mathematics: Vol 1. Research Synthesis*, (pp 109-154).
- Gallagher, S. (1992). *Hermeneutics and education*. New York: State University of New York Press.
- Keiren, C. & Drijvers, P. (2006). The co-emergence of machine techniques, paper-and-pencil techniques, and theoretical reflection: A study of CAS use in secondary school algebra. *International Journal of Computers for Mathematical Learning*, 11, 205-263.
- Ministry of Education of New Zealand. (2007). *The New Zealand curriculum*. Wellington: Learning Media.
- Otrell-Cass, K., Forret, M., & Taylor, M. (2009). *Opportunities and challenges in technology-rich classrooms: Using the Scratch software*. SET 1, 49-54.
- Peppler, A. P. & Kafai Y. B. (2006). Creative codings: Personal, epistemological, and cultural connections to digital art production. *Proceedings of the 2006 International Conference of the Learning Sciences, Bloomington, Indiana*.
- Povey, H. (1997). Beginning mathematics teachers' ways of knowing: The link with working for emancipatory change. *Curriculum Studies*, 5(3), 329-343.
- Resnick, M. (2007). Sowing the seeds for a more creative society. *Learning & Leading with Technology*, 35(4).

Using Developmental Frameworks to Support Curriculum Outcomes

Rosemary Callingham

University of Tasmania

<Rosemary.Callingham@utas.edu.au>

John Pegg

University of New England

<jpegg@une.edu.au>

Curriculum documents in Australia are designed around outcomes and related standards. Teachers need to provide opportunities for students to learn the content that will allow them to meet the expectations defined in the curriculum. After undertaking professional learning sessions about the SOLO model, mathematics teachers in six high schools hypothesised developmental pathways for several key mathematical ideas. These theorised pathways were compared with Australian and State curriculum outcomes. The implications of using this approach for supporting teachers are discussed.

The change in curriculum emphasis to focus on the outcomes of learning rather than inputs to schooling is part of a pressure and support approach to educational reform espoused by a number of governments over the past decade (Fullan, 2000). Outcomes-based curriculum approaches demand that teachers are more intentional in their work with the assessment of outcomes being integrated into teaching. Teaching and learning become inextricably linked and assessment is embedded within the teaching process (Pellegrino, Chudowsky & Glaser, 2001; Shepard, 2000). The integration of curriculum (what is taught), teaching (how it is taught), and assessment (what has been understood by the learner) is termed curriculum alignment (Biggs, 1996).

Aligning curriculum objectives with teaching practice and assessment of outcomes is important, if schools are to achieve improved student learning. Unless, however, teachers make the necessary connections among students' responses, students' underlying conceptual understanding and the demands of the subject and the curriculum, they are unlikely to be able to use curriculum materials effectively (Manouchehri & Goodman, 1998). Concerns such as these have led to a considerable research agenda around pedagogical content knowledge (Shulman, 1987), mathematical knowledge for teaching (Hill, Sleep, Lewis & Ball, 2007) and teachers' mathematics content knowledge (e.g., Ma, 1999). Consistently, the research literature suggests that teacher practices in classrooms are what contribute most to students' outcomes (Ingvarson, Beavis, Bishop, Peck & Elsworth, 2004). Curriculum outcomes, however, typically describe key ideas needed by students to progress, rather than the smaller building blocks used by teachers to plan their programs and provide targeted intervention for their students. Teachers are hence left with little curriculum support for their day-to-day work.

From the early work of Piaget (e.g., Piaget & Inhelder, 1969) to more recent developments in the area of neuroscience (Goswami & Bryant, 2007), there is an acceptance that learning is gradual, building on prior experiences mediated through language. As Goswami and Bryant put it "Incremental experience is crucial for learning and knowledge construction" (p.20) and teachers must provide the necessary opportunities. To plan effective programs for their students, teachers need to recognise developmental pointers, and these may not be present in curriculum documents. In this situation, one solution is to consider general developmental frameworks that can be applied to students' mathematics learning.



One such framework is provided by the SOLO model (Biggs & Collis, 1982, 1991). SOLO (Structure of the Observed Learning Outcome) is characterised by identifiable levels of response that are categorised by the complexity of the language used. These levels occur in cycles of Unistructural (U), where use is made of a single piece of information, Multistructural (M), where information is used in a stepwise process, and Relational (R) where information is synthesised into a coherent explanation or generalized to new situations. These cycles occur within modes of response: kinesthetic, iconic, concrete-symbolic and formal. Two U-M-R cycles have been identified in many situations, especially in the concrete-symbolic mode, which is the target mode for most school curricula (Pegg, 2003).

In the study reported here, teachers were introduced to the two-cycle approach to SOLO (Callingham, Pegg & Wright, 2009). As part of the professional learning sessions, teachers of mathematics chose to theorise developmental U-M-R cycles for some common topics in mathematics as a way of helping themselves to understand students' development. From this background, the research question reported in this paper is:

To what extent do theorised developmental sequences used by teachers to identify students' understanding match curriculum outcomes?

Method

Mathematics teachers in six NSW public high schools were involved in the study. All 11 teachers were very experienced, with the average number of years of teaching being above 15. They chose to develop SOLO sequences for some common mathematics topics including percent, congruence and Pythagoras' theorem as a way of understanding SOLO and also identifying students' development. They used these theorised sequences to construct assessment and teaching tasks. Generally, the initial sequence was developed within one school to address a specific need within that school's context. The SOLO sequence was then brought to the next project meeting, sometimes with some student work samples, and discussed with other project participants and the researchers. Hence the final hypothesized sequence was the result of collaboration among experienced teachers and researchers. Although not always fully validated due to time constraints in the project, teachers were happy to accept the SOLO U-M-R cycles as a guide for planning and assessment.

These theorised U-M-R cycles were then compared with two curriculum documents. The first was the NSW syllabus for Years 7 – 10 (NSW Board of Studies, 2003), which was the curriculum used by the teachers in the project. The second was the new draft Australian Curriculum (AC) (Australian Curriculum Assessment and Reporting Authority (ACARA), 2010). The comparison identified the key ideas identified by teachers and located them in relation to the stage or grade of the curriculum document. Results are reported for two theorised sequences: percent and Pythagoras' theorem. Both of these ideas are important in middle-years mathematics, and require good understanding of underpinning concepts before they can be successfully learned by students.

Results

The tracking of the hypothesised SOLO levels against the two curriculum documents for percent is shown in Table 1.

Table 1
Comparison between SOLO Levels and Curriculum Documents

Hypothesised SOLO level	NSW Syllabus	Australian Curriculum
U1 Knowing the symbol % and that it means 37 parts out of 100	NS2.4 (end Year 4) Students learn about: <ul style="list-style-type: none"> recognising that the symbol % means 'percent' 	No direct equivalent but implicit in M5NA3 (Year 5) Content description Solve problems involving making comparisons using equivalent fractions and decimals and everyday uses of percentages, relating them to parts of 100 and hundredths.
M1 Understanding that $50\% = \frac{1}{2}$ and $25\% = \frac{1}{4}$	NS2.4 (end Year 4) Students learn about: <ul style="list-style-type: none"> equating 10% to , 25% to and 50% to 	M5NA3 (Year 5) Elaboration Representing decimal and percent equivalents of familiar fractions by using equipment, such as percentage strings, metre rulers, number lines, and 10×10 grids (e.g., counting 25 beads on a string of 100 to show $25/100$ or 25% to demonstrate that this is one quarter of the beads, and that it can also be written as 0.25 or $\frac{1}{4}$).
R1 Finding 50% or 25% of very easy numbers (without formal procedures) e.g., 50% of \$80	Outcome NS3.4 (end Year 6) Students learn about: <ul style="list-style-type: none"> calculating simple percentages (10%, 20%, 25%, 50%) of quantities. 	M5NA3 (Year 5) Elaboration Using equivalences with fractions to calculate 50%, 25% and 10% of quantities (e.g., recognising that 25% of 80 is the same as $\frac{1}{4}$ of 80 which is 20)
U2 Finding a % of an amount, (using % 100 amount) OR I lost 14% of my money, what % is left?	No direct equivalent	M7NA3 (Year 7) Elaboration Solving problems using fractions and percentages, such as those that require calculating fractions or percentages of quantities.
M2 Finding a discount by finding a % and deducting it. Increasing by a %. Solving a question like: Find the original price if after 25% off, you pay \$84.	NS4.3 (End Grade 8) Students learn about: <ul style="list-style-type: none"> Increasing and decreasing a quantity by a given percentage Expressing profit and/or loss as a percentage of cost price or selling price 	M8NA1 (Year 8) Elaboration Expressing profit and loss as a percentage of cost or selling price, comparing the difference, and investigating the methods used in retail stores to express discount; Applying the unitary method to solve real life problems involving ratios and percentages, including those where the whole is unknown (e.g., 'after a discount of 15%, an MP3 player was worth \$183. What was its value before the discount?')
R2 Solving a problem like: If you increase 100kg by 10%, and then reduce by 10%, what do you have?	No direct equivalent, similar to NS4.3 (End Year 8) Students learn about: <ul style="list-style-type: none"> Interpreting and calculating percentages greater than 100% 	No direct equivalent
Formal: Solve a question like: A leather handbag was discounted by \$x and then sold for \$y. Find the % discount in terms of x and y.	No direct equivalent	No direct equivalent

The U, M, R refers to Unistructural, Multistructural and Relational and the subscript identifies whether it is located in the first or second U-M-R cycle in the concrete-symbolic mode. Statements from the two curriculum documents were selected where they best matched the SOLO description. In some instances these were part of the outcomes or key ideas (NSW), or the content description (AC); in others the activity statement "Students learn about ..." (NSW) or Elaboration (AC) provided the best match. These latter two are

provided in the curriculum documents to exemplify the nature of the expectations for classroom practice, rather than being definitive teaching points.

For the percent concept, the lower SOLO levels were identifiable in both curriculum documents, although the U_1 level (recognising %) was implicit rather than explicit in the Australian curriculum. The development of the percent concept was similar in both the theorised SOLO sequence and the two curriculum documents and spanned the middle years of schooling. In NSW, however, the recognition of the percent symbol (U_1) and understanding of familiar fractions as percents (M_1) was expected by the end of Year 4 whereas in the AC this occurred in Year 5. In contrast, calculation of familiar percents (R_1), such as 25% and 10%, was also expected in Year 5 in the AC but not until the end of Year 6 in NSW. There was no explicit mention of percent in Year 6 in the AC but in Year 7 students were expected to calculate simple percents beyond familiar fraction equivalents (U_2). By the end of Year 8 in both NSW and AC, the expectations were similar of fluent use of percent for complex computations such as discounts, including inverse problems (M_2). Two further SOLO levels were theorised, both more abstract in nature, neither of which had a direct equivalent in the curriculum documents. The R_2 level hypothesised involved problems that changed the basis for the percent calculation and a further Formal mode level was entirely algebraic.

The project teachers theorised the SOLO sequences in order to help them understand the development of the concept of percent. This detail was present in the curriculum documents but was often buried in the activity statements. The outcome statements (NSW) and content descriptions (AC) were too dense to be useful in identifying the small steps necessary for teachers to plan for development. In addition, some of the SOLO levels were compressed. The whole of the first cycle ($U_1 - M_1 - R_1$), for example, was placed in Year 5 in the AC, and the M_2 and R_2 levels were both expected by the end of Year 8 in NSW. The AC addressed a single grade in its statements in contrast to the NSW document, which described outcomes in two-year blocks, implying a two year period for the development of ideas. Experience from other studies suggests that students need time to consolidate lower levels of development and often making the shift from a Multistructural to a Relational level of thinking can be difficult (Pegg, 2003). The expectation for percent development in Year 5 in the AC may, on this basis, be unrealistic.

A somewhat different picture emerges when Pythagoras' theorem is considered. All of the theorised SOLO levels were expected by the end of Year 8 in NSW, and most were also located in Year 8 of the AC. Little explicit attention was given in either curriculum document to the development of essential underpinning ideas such as recognition of key parts of a right triangle (U_1 and M_1), although some of this is implied in the Year 5 content description "Make connections between different types of triangles and quadrilaterals using their features, including symmetry and explain reasoning" in the AC. The R_1 SOLO level (recognising the Pythagorean relationship) is explicit for the end of Year 8 in the NSW activity statement but not in the AC Year 8 statements, where the emphasis is on using the relationship.

Table 2

Comparison between SOLO levels and Curriculum Documents for Pythagoras' Theorem

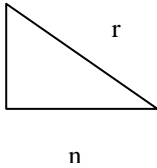
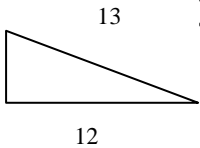
SOLO	NSW Syllabus	Australian Curriculum
U1 Recognise hypotenuse	MS4.1 (End Year 8) Key Idea: Apply Pythagoras' theorem Students learn about: <ul style="list-style-type: none"> identifying the hypotenuse as the longest side in any right-angled triangle and also as the side opposite the right angle. 	Not mentioned
M1. Identifies parts of the right-angled triangle		Implicit in M5MG1 (Year 5) Content Description Make connections between different types of triangles and quadrilaterals using their features, including symmetry and explain reasoning.
R1  Recognises $m^2 + n^2 = r^2$	MS4.1 (End Year 8) Key Idea: Apply Pythagoras' theorem Students learn about: <ul style="list-style-type: none"> establishing the relationship between the lengths of the sides of a right-angled triangle in practical ways, including the dissection of areas. 	M8MG7 (Year 8) Content Description: Use Pythagoras' theorem to solve simple problems involving right-angled triangles. Elaboration: Using Pythagoras' theorem in right-angled triangles: $a^2 + b^2 = c^2$, where a and b represent the lengths of the shorter sides and c represents the length of the hypotenuse.
U2 Calculates hypotenuse length.	MS4.1 (End Year 8) Key Idea: Apply Pythagoras' theorem Students learn about: <ul style="list-style-type: none"> using Pythagoras' theorem to find the length of sides in right-angled triangles 	M8MG7 (Grade 8) Elaboration: Solving problems involving the calculation of unknown lengths in right-angled triangles
M2 Calculates short side or identifying triad.	MS4.1 (End Year 8) Key Idea: Apply Pythagoras' theorem Students learn about: <ul style="list-style-type: none"> identifying a Pythagorean triad as a set of three numbers such that the sum of the squares of the first two equals the square of the third. 	M8MG7 (Grade 8) Elaboration: Solving problems involving the calculation of unknown lengths in right-angled triangles
R2 Decision making and Reversibility e.g.,  Find x.	MS4.1 (End Year 8) Key Idea: Apply Pythagoras' theorem Students learn about: <ul style="list-style-type: none"> solving problems involving Pythagoras' theorem, giving an exact answer as a surd (e.g., $\sqrt{\quad}$) and approximating the answer using an approximation of the square root using the converse of Pythagoras' theorem to establish whether a triangle has a right angle. 	M8MG7 (Grade 8) Elaboration: Applying understanding of Pythagoras' theorem to determine if a triangle is right angled
Formal. Using Pythagoras, single part of a 3-D object, Bearings etc.	SGS5.3.1 Deductive geometry <ul style="list-style-type: none"> proving Pythagoras' theorem and applying it in geometric contexts applying the converse of Pythagoras' theorem 	M9MG2 (Grade 9) Content Description: Solve problems involving right angled triangles using Pythagoras' theorem ... and justify reasoning

Discussion

A number of issues are raised by the mapping exercise described in the last section. The SOLO pathways were theorised by a group of experienced teachers, and were not

formally validated. Nevertheless, the hierarchies were accepted as reasonable representations of the development of the notions of percent and Pythagoras' theorem. The same kinds of understandings were evident in the curriculum documents as well, suggesting that the nature of the knowledge that students need to develop is widely agreed upon.

A major difference, however, was in the developmental aspect, particularly over a period of time. The concept of percent in the curriculum documents did have some sense of growth across time, with the earliest notions located in the later years of primary school, and the more complex ideas situated in the lower secondary years. Some aspects of percent, however, which were identified as having different levels of complexity in the SOLO sequence, appeared within a single grade in the curriculum documents. For example, the M_1 (Understanding that $50\% = \frac{1}{2}$ and $25\% = \frac{1}{4}$) and the R_1 (Finding 50% or 25% of very easy numbers) SOLO levels both appeared in Year 5 Elaborations in the Australian Curriculum. The first of these elaborations is explicit about the use of concrete materials such as using percentage strings or 10×10 grids and is like the M_1 SOLO level, but the second is considerably more abstract in expecting the use of fraction equivalents, similar to the theorised R_1 SOLO level. This finding would suggest that the first elaboration might be better addressed earlier in Year 5 and the more abstract idea revisited later in the year but the curriculum document does not provide any indication of sequencing within a particular year level. In the NSW syllabus document, the M_1 SOLO level appeared at Stage 2, that is at the end of Year 4 and the R_1 level was identified in Stage 3, the end of Year 6. The two-year time frame suggests that the curriculum allows for growth over time, and implicitly acknowledges students' developmental needs.

The situation in the curriculum documents with respect to Pythagoras' theorem is less developmental. There appears to be little consideration in the Australian Curriculum to building an understanding of the Pythagorean relationship before using it to solve problems, although the expectation of concrete approaches to proving the relationship is explicit in the NSW document. Understanding Pythagoras' theorem, however, is largely restricted to the Year 8 level in both documents, and includes most of the hypothesised SOLO levels.

Neither SOLO nor the curriculum documents provide any clear indication of the rate of learning; that is whether it is reasonable to expect students to progress through a number of developmental levels within a short time frame. SOLO, however, does provide some support for teachers in terms of sequencing activities, which is not evident in curriculum documents. One aspect of SOLO that the project teachers particularly appreciated was that it allowed them to understand how a concept developed, so that if students were struggling with an idea the teacher could move back to an earlier notion in a structured and informed manner. For example, one teacher stated

It's [SOLO] sort of made me understand about that really basic level, and unless they know that, and feel comfortable with it, and understand it, they can't start linking everything together.

In addition, SOLO provided the teachers involved with approaches that informed their teaching and made it more intentional. They were able to use the complexity of students' responses to identify whether they were ready for the next stage of development, and were mindful of the need to move students through the developmental levels identified, for example:

I'm progressing through it and seeing that the kids are at a certain level, and saying to them...and thinking to myself, at school and at home, how can I get them to a higher level?

SOLO also had an impact on other aspects of teaching, in particular the nature of the questions posed to students. The teachers in the project reported that they were no longer satisfied with questions that allowed students to demonstrate only particular skills. Instead they were deliberately posing questions that required explanations or demonstrations of understanding. For the two concepts considered here, percent and Pythagoras' theorem, there is almost no indication of students explaining their thinking in the curriculum documents. For example, students are expected to represent percents using concrete materials but not to explain why that representation is suitable. Hence, students could manipulate the materials successfully with apparent expert behaviour but without deep understanding of the concept.

It should be acknowledged that the curriculum documents do not purport to advise teachers on how to teach, only on what to teach. Without some acknowledgement of students' mathematical development and corresponding approaches to teaching, however, the curriculum documents become somewhat sterile. The NSW mathematics syllabus is explicit in having a developmental focus and having flexibility for students to achieve the standards at different times and in different ways. The NSW syllabus states "Syllabus outcomes in mathematics contribute to a developmental sequence in which students are challenged to acquire new knowledge, skills and understanding" (NSW BoS, 2003, p.147). In contrast, the Australian Curriculum has an explicit focus on increasing difficulty of the mathematics rather than student-focussed developmental pathways:

The Australian mathematics curriculum focuses on developing increasingly sophisticated and refined mathematical understanding, fluency, logical reasoning, analytical thought processes and problem-solving skills... (ACARA, 2010, p. 1).

Despite considerable emphasis on equity considerations in the earlier Mathematics Framing Paper (National Curriculum Board, 2009), in which principles for the writing of the Australian Curriculum were established and which acknowledged "the markedly different rates at which students develop" (p.17), the focus on developmental aspects of students' learning of mathematics is limited in the draft AC. It may be that the added flexibility of having two-year stages for which outcomes are described in the NSW Syllabus provides a stronger developmental framework than the year level expectations of the Australian Curriculum. Neither document, however, appears to set out to map a specific developmental pathway that provides sequencing information for teachers' day-to-day work. In this void, SOLO can provide a theoretical perspective to support teachers' decisions about their students' learning by identifying the small steps needed for students to progress.

Conclusion

Mapping current curriculum documents against theorised learning sequences provided some insights into the structure and nature of the mathematics curriculum. Although the kinds of understandings that students demonstrate as they develop mathematical concepts are, in general, well documented in formal curriculum documents, there is little indication of the sequence of development of such understanding. Teachers, using the SOLO model (Biggs & Collis, 1982, 1991), were able to theorise levels of mathematical development that allowed them to plan appropriate learning activities that met their students' learning needs. With the focus on learning outcomes that is apparent in modern mathematics curricula, some support to teachers in the form of a developmental model, such as SOLO, would seem to be helpful for the routine work of teaching.

Acknowledgement

The study reported in this paper was supported by an Australian Research Council Linkage Grant: LP 0455320.

References

- Australian Curriculum Assessment and Reporting Authority (ACARA), (2010). *Draft K-10 mathematics curriculum*. Accessed 21 March 2010 from www.australiancurriculum.edu.au
- Biggs, J. (1996) Enhancing teaching through constructive alignment. *Higher Education*, 32, 347-364.
- Biggs, J. B. & Collis, K. F. (1982). *Evaluating the quality of learning: The SOLO taxonomy*. New York: Academic Press.
- Biggs, J. B. & Collis, K. F. (1991). Multi-modal learning and the quality of intelligent behaviour. In: H. Rowe (Ed.), *Intelligence: Reconceptualisation and measurement*. Hillsdale, NJ: Lawrence Erlbaum.
- Callingham, R., Pegg, J. & Wright, T. (2009). Changing teachers' classroom practice through developmental assessment: Constraints, concerns and unintended impacts. In R. Hunter, B. Bicknell, & T. Burgess (Eds.), *Crossing divides* (Proceedings of the 32nd annual conference of the Mathematics Education Research Group of Australasia), 8pp. [CDROM]. Palmerston North, NZ: MERGA.
- Ingvarson, L., Beavis, A., Bishop, A., Peck, R., & Elsworth, G. (2004). *Investigation of effective mathematics teaching and learning in Australian secondary schools*. Melbourne: Australian Council for Educational Research.
- Fullan, M. (2000). The return of large-scale reform. *Journal of Educational Change* 1, 5–28.
- Goswami, U. & Bryant, P. (2007). *Children's cognitive development. Primary review research survey 2/1a*. Cambridge: University of Cambridge.
- Hill, H. C., Sleep, L., Lewis, J. M., & Ball, D. L. (2007). Assessing teachers' mathematical knowledge: What knowledge matters and what evidence counts? In F. K. Lester Jr. (Ed.) *Second handbook of research on mathematics teaching and learning* (pp. 111-156). Reston, VA: National Council of Teachers of Mathematics.
- Ma, L. P. (1999). *Knowing and teaching elementary mathematics*. Mahwah, NJ: Lawrence Erlbaum.
- Manouchehri, A. & Goodman, T. (1998). Mathematics curriculum reform and teachers: Understanding the connections. *The Journal of Educational Research*, 92(1), 27-41.
- National Curriculum Board. (2009). *National mathematics curriculum: Framing paper*. Melbourne: Author.
- New South Wales Board of Studies. (2003). *Mathematics years 7 – 10 syllabus*. Sydney: Author.
- Pegg, J. (2003). Assessment in mathematics: A developmental approach. In M. Royer (Ed.), *Mathematical Cognition* (pp. 227-259). Greenwich, Connecticut: Information Age Publishing.
- Pellegrino, J.W., Chudowsky, N. & Glaser, R. (Eds.) (2001). *Knowing what students know: The science and design of educational assessment*. Washington, DC: National Academy Press.
- Piaget, J. & Inhelder, B. (1969). *The psychology of the child*. (trans. by H. Weaver). New York: Basic Books.
- Shepard, L.A. (2000). *The role of classroom assessment in teaching and learning*. CSE Technical Report 517. Los Angeles, CA: National Center for Research on Evaluation, Standards, and Student Testing.
- Shulman, L. S. (1987). Knowledge and teaching: Foundations of the new reform. *Harvard Educational Review*, 57, 1-22.

The Influence of the Mathematics Class on Middle School Students' Interest for Statistical Literacy

Colin Carmichael
University of Tasmania
<colin.carmichael@utas.edu.au>

This paper explores the differences between middle school students' interest for the statistical literacy acquired in mathematics classes, their interest for mathematics in general, and their interest for the statistical literacy acquired in other school subjects. Based on the responses of a sample of 425 Australian middle school students, it appears that such students have no more interest for the statistical literacy in mathematics classes than the mathematics that they encounter. The same students, however, have more interest for statistical literacy when it is encountered outside of mathematics classes. Follow up interviews with 17 students are used to explore the reasons for these differences. The results suggest that students' interest for statistical literacy is strongly associated with the perceived relevance of the context in which the statistics is embedded. Moreover, a number of students dislike the inherent uncertainty that is associated with statistics, preferring instead problems with clear solutions.

Statistical literacy is regarded as an ability to interpret and critically evaluate messages that contain statistical elements (Gal, 2003). The requisite concepts and skills for this literacy are usually first encountered by Australian students in their mathematics classes. These skills are then often used in a variety of contexts that occur in other school subjects. As a result, the development of Australian students' statistical literacy should occur across the entire school curriculum. This is as it should be, for statistics itself is a "methodological discipline rather than a core substantive area" (Moore & Cobb, 2000, p. 620). This paper explores the extent to which the mathematics classroom influences middle school students' attitudes to statistical literacy. More specifically, the paper seeks to explore differences between middle school students' interest for the statistical literacy encountered in the mathematics classroom, their interest for the other areas of mathematics, and their interest for the statistical literacy encountered in other school subjects.

The Development of Interest

Dewey (1910, p. 91) described interest as "the annihilation of the distance between the person and the materials and results of his action." More recently, interest has been conceptualised as an affect with both state and trait properties (Ainley, Hidi, & Berndorff, 2002). At the trait level, interest is viewed as a predisposition to attend to certain tasks (Ainley et al., 2002); at the state level it is likened to curiosity, "an emotional state aimed at understanding" (Silvia, 2001, p. 277). Students' responses to interest inventories are thought to reflect both their trait and state interests (Ainley et al. 2002).

In learning contexts, interest is known to influence student motivation, with reported positive associations between students' interest and their achievement (Schiefele, Krapp, & Winteler, 1992). Factors that are known to influence students' interest for domains such as mathematics or statistics have been documented in Carmichael, Callingham, Watson, and Hay (2009). These include individual factors such as: students' personal interests, their goals, and their competency beliefs. Situational features, such as the novelty, complexity and uncertainty associated with given tasks are also known to influence the interest that students have for that task.



Arguably, mathematical and statistical learning experiences are sufficiently distinct for students to experience different levels of interest. In statistical investigations, for example, context is essential and the extent to which it aligns with students' personal interests and/or goals will influence the interest, or lack of interest, that they experience. Similarly, students who believe they are more competent with statistical investigations than mathematical investigations are likely to report higher levels of interest for the former. Situational aspects associated with the learning of statistics are also likely to elicit different levels of interest than those associated with the learning of mathematics. For example, Mitchell (1993) reported that novelty can be found in computer applications, so it is likely that some students will find interest in statistical investigations that use software to interrogate datasets. It is also possible that some students will experience interest as a result of the inherent uncertainty that is associated with aspects of statistics.

Methodology

The methodology for this study occurred in two stages, a quantitative study involving survey responses of 425 students, and a supporting qualitative study involving the interview responses of 17 students.

Stage 1: Quantitative Study

A convenience sample of 425 students from nine schools in three Australian states agreed to participate in a larger interest based study. Students in the study were primarily enrolled in years 7, 8 and 9 of secondary school, although students from years 6 and 10 were also included in the study. The mean age of students was 13.6 years, and 47% of students were male.

Students responded on a five point Likert scale to a series of interest self-descriptions, for example: "I'm interested in surveys that find out about people". A Rasch analysis of these responses was used to provide an interval measure of their interest for statistical literacy (Carmichael, 2008). In addition to these interest self-descriptions, and relevant to this study, students were also provided with the following three self-descriptions:

Compared to others in my class I am good at maths.

I find statistics more interesting than the other work we do in maths.

The statistics that I do in maths classes is more interesting than the statistics that I do in other subjects.

These were also answered on a five point Likert scale that ranged from 1 (*Not me at all*) to 5 (*Describes me well*).

Stage 2: Qualitative Study

A sample of 17 students was selected from those who had completed the interest survey. The students, from two participating schools, were selected in order to represent a range of levels of interest for statistical literacy. Interviews were semi-structured and were conducted in groups of between 2 and 4 students, details of these groups are provided in Table 1. After students explained the sorts of things they did when they encounter statistics in mathematics and other subjects, the following questions were posed:

1. For you, is statistics more interesting than the other sorts of maths you do?
2. Is the statistics you do in other subjects more interesting than the statistics that you do in maths?

Interviews took between 30 and 40 minutes. They were recorded and subsequently transcribed. A content analysis of the data (Miles & Huberman, 1984) was then performed and the results are reported in this paper.

Table 1:

Details of Students and Schools Used in Qualitative Study

Group	Students	School
1	3 boys and 1 girl from a mixed ability Y7 class	Independent, co-educational from Qld.
2	2 girls from a mixed ability Y8 class	
3	2 girls and 1 boy from a high ability Y9 class	
4	2 boys and 2 girls from a low ability Y8 class	Government, co-educational from Tasmania
5	1 boy and 3 girls from a high ability Y10 class	

Results

Stage 1

The number of student responses in each Likert category for each of the questions is shown in Table 2. Only 54 students (13.2%) responded with a 4 or 5 to question 2 and presumably felt that statistics was more interesting than the other work they did in maths. Most students either did not see any difference or regarded statistics as less interesting than other work in maths. Indeed, if responses in the lower categories reflect disagreement, then 259 students (63%) regarded statistics as less interesting than other work in maths. Students' responses, however, were influenced by their competency beliefs. Students who considered they were less competent at maths than their peers (Question 1) tended to respond with lower ratings to Question 2 than students who considered they were no less competent ($\chi^2 = 61, p = 0.000$). Interestingly students who considered they were more competent than their peers also tended to see statistics as less interesting than maths.

Table 2:

Number of Student Responses to the Three Questions by Likert Category

	1	2	3	4	5	Total
Question 1	81	78	103	90	57	411
Question 2	146	113	97	34	20	410
Question 3	136	96	108	38	31	409

Only 69 students (16.9%) felt that the statistics encountered in mathematics classes was more interesting than the statistics encountered in other subjects. Most students either did not see any difference or regarded the statistics encountered in maths classes as less interesting than the statistics encountered in other subjects. Again, if responses in the lower

categories reflect disagreement, then 232 students (56.7%) regarded statistics as less interesting when it is encountered in mathematics classes. As in question 2, students' responses to question 3 were influenced by their competency beliefs ($\chi^2 = 91, p = 0.000$). In addition to this, their responses to question 3 were also influenced by gender ($\chi^2 = 18.5, p = 0.001$), with girls more likely than boys to see the statistics encountered in mathematics classes as less interesting than that the statistics encountered in other classes.

Stage 2

In response to the first interview question, 11 of the 17 students saw no difference in their interest for mathematics and statistics. One student saw the question as irrelevant arguing that "there's some things in maths that I like and others that I don't, but you're just got to do it..." Two students said the answer depended on other factors, such as the difficulty of the actual task, or its relevance. Only three of the students found statistics more interesting. One of these was interested in statistics because they were interested in finding out about other people; the other two expressed interest in statistics because they considered it to be easier than the other work done in mathematics classes.

When students were asked to give reasons for their responses a common theme emerged. Students identified a certain definiteness about many mathematics problems that was not found in statistics. One of the Year 7 students enjoyed "racing" through the mathematics questions. In response to the question whether statistics was more interesting, he replied:

Its not interesting to me, I'd rather sit down and work out. I like getting my times because at my last school...we'd have 30 questions up on the board, we'd race each other to see who'd finish

Some of the Year 10 students expanded this theme further. One of the boys remarked:

I don't like statistics as much as I like other stuff, because when you get the other stuff you're actually solving a problem, and statistics, you're not really solving a problem, you're just getting lots and lots of information and solving the problem you made for yourself.

One of the girls added to this discussion with the remark:

I just like things that are bit more...sort of definite.

In response to the second interview question, 6 of the 17 students were unsure, suggesting that they had not encountered sufficient statistics outside of mathematics classes to comment. Six thought the statistics in other subjects was more interesting, four students said it depended on the context and one student felt that the statistics encountered in mathematics was more interesting.

When students were asked to give reasons for their response most felt that the contexts encountered outside of mathematics classrooms were more relevant. One Year 9 student remarked that "...you can actually see how it is" in other subjects. Another student, who was in Year 8, enjoyed using statistics in other subjects "because you have something that goes along with it, like an experiment or something to do". In relation to the statistics she had encountered in mathematics, one Year 10 student remarked:

...in maths the data that we use, like, it's on a very small scale, like individual people's body measurements. But it's more interesting and important when its things that concern the whole world.

Discussion

The results from the first stage of this study indicate that students do not find any more interest in the statistical literacy encountered in mathematics classes than other areas of the mathematics syllabus. Their interest, however, appears to be influenced by their competency-based beliefs. Students who believe that they are less competent at maths than their peers are more likely to provide seemingly negative responses to such self-descriptions. The results also indicate that students do not find any more interest in the statistical literacy encountered in mathematics classes than that encountered in other classes. In fact, they suggest that students find statistical literacy more interesting when it is encountered outside of mathematics classes. This result, however, may be more related to students' negative attitudes towards mathematics than their interest for statistical literacy in other contexts. Girls tend to have a lower intrinsic valuing of mathematics than boys (Watt, 2004) and the tendency for girls in this study to provide low ratings for this question may more reflect their low valuing of mathematics than a preference for statistics in other contexts.

The results from stage 2 of this study suggest that students can distinguish between statistical literacy and other areas of the mathematics syllabus. In fact one rather unique characteristic of statistical investigations, as opposed to mathematical investigations, is that they typically result in an opinion supported by the data rather than a definite solution (Garfield, 2003). This characteristic actually evoked negative attitudes in some students, who preferred the definite solutions that are typically encountered in mathematical investigations. The results of stage 2 also suggest that students' interest ratings are very much influenced by the perceived relevance of the context in which the statistical literacy is embedded. Their interest ratings, therefore, may more reflect an extrinsic valuing than the intrinsic valuing that is associated with interest.

Other than the students who were interviewed, there was no available information on the nature of learning activities that students encounter in their acquisition of statistical literacy, both within the mathematics classroom and in other subjects. These learning activities influence students' interest ratings and indeed their ability to differentiate between statistical literacy, other areas of mathematics and other areas of the school curriculum. In fact the lack of response from some students in stage 2 to question 2 suggests that they may encounter very few statistical applications outside of their mathematics classrooms. This certainly appears to be the case in Great Britain, where Holmes (2003, p.46) argued, "the lesson that statistics is an interdisciplinary subject has not been learned". Given that statistics and probability will form one of three content strands in the proposed Australian National Mathematics Syllabus, there appears to be a growing awareness of the importance of statistical literacy. Although students can acquire the requisite skills and knowledge for statistical literacy in their mathematics classrooms, this literacy must be developed in wider contexts. In acknowledging this need, the *National Numeracy Report* (Council of Australian Governments, 2008) recommended an across curriculum commitment to numeracy, which it is assumed includes statistical literacy. In response to this, the proposed Australian National Mathematics Syllabus has recommended the inclusion of references in all syllabi indicating where numeracy is relevant in those disciplines. Such a recommendation, though, is merely a preliminary step. There is a pressing need for an audit of all school-based subjects, to determine the extent to which students encounter statistical applications across the curriculum and the efficacy of these applications for developing their statistical literacy.

Acknowledgements

Thanks are extended to Assoc. Prof. Rosemary Callingham, Prof. Ian Hay and Prof. Jane Watson for their kind assistance and advice.

The research was funded by Australian Research Council grant number LP0669106, with support from the Australian Bureau of Statistics.

References

- Ainley, M., Hidi, S., & Berndorff, D. (2002). Interest, learning, and the psychological processes that mediate their relationship. *Journal of Educational Psychology, 94*(3), 545-561.
- Carmichael, C. S. (2008). The development and validation of the Statistical Literacy Interest Measure (SLIM). In T. Hays & R. Hussain (Eds.), *Proceedings of the third annual postgraduate research conference: Bridging the gap between ideas and doing research* (pp. 35-39). Armidale: University of New England. <http://www.une.edu.au/faculties/professions/Resources/2008proceedings.pdf>
- Carmichael, C. S., Callingham, R., Watson, J. M., & Hay, I. (2009). Factors influencing the development of middle school students' interest in statistical literacy. *Statistics Education Research Journal, 8*(1), 62-81.
- Council of Australian Governments. (2008). *National Numeracy Review Report*: Department of Education, Employment and Workplace Relations.
- Dewey, J. (1910). Interest in relation to training of the will. In J. J. Findlay (Ed.), *Educational essays* (pp. 73-132). Bath: Cedric Chivers Ltd.
- Gal, I. (2003). Teaching for statistical literacy and services of statistics agencies. *The American Statistician, 57*(2), 80-84.
- Garfield, J. B. (2003). Assessing statistical reasoning. *Statistics Education Research Journal, 2*(1), 22-38.
- Holmes, P. (2003). 50 years of statistics teaching in English schools: Some milestones. *The Statistician, 52*(4), 439-474.
- Miles, M. B., & Huberman, A. M. (1984). *Qualitative data analysis: A sourcebook of new methods*. Newbury Park: SAGE Publications.
- Mitchell, M. (1993). Situational interest: Its multifaceted structure in the secondary school mathematics classroom. *Journal of Educational Psychology, 85*(3), 424-436.
- Moore, D. S., & Cobb, C. D. (2000). Statistics and mathematics: Tension and cooperation. *The American Mathematical Monthly, 107*(7), 615-630.
- Schiefele, U., Krapp, A., & Winteler, A. (1992). Interest as a predictor of academic achievement: A meta-analysis of research. In K. A. Renninger, S. Hidi & A. Krapp (Eds.), *The role of interest in learning and development* (pp. 183-212). New Jersey: Lawrence Erlbaum Associates.
- Silvia, P. J. (2001). Interest and interests: The psychology of constructive capriciousness. *Review of General Psychology, 5*(3), 270-290.
- Watt, H. M. G. (2004). Development of adolescents' self-perceptions, values, and task perceptions according to gender and domain in 7th through 11th grade Australian students. *Child Development, 75*(5), 1556-1574.

Students' Frames of Reference and Their Assessments of Interest for Statistical Literacy

Colin Carmichael

University of Tasmania

<Colin.Carmichael@utas.edu.au>

This study examines the influence of middle school students' frames of reference on their assessments of interest for statistical literacy. Based on the responses of 406 middle school students to a previously validated interest measure, the study explores students' use of *external* – perceived self-competency when compared with others – and *internal* – perceived self-competency when compared with other subjects – frames of reference on their interest assessments. The study concludes that students' assessments of interest appear to be dependent on both comparisons but only for those students who consider that they are worse at maths than their peers. The interest assessments of other students appear to be less dependent on their self-competency beliefs.

The term interest, as conceptualised in this study, is defined as a “person's relatively enduring predisposition to reengage particular content over time” (Hidi & Renninger, 2006, p.113). Students' interest in a domain of knowledge is known to be positively associated with deeper levels of cognitive processing, the use of self-regulatory learning strategies and their ratings on the quality of the learning experience (Schiefele, 1991). In a mathematics context, middle school students' interest is known to influence their re-engagement with the subject, in particular their choice of senior secondary mathematics course (McPhan, Morony, Pegg, Cooksey, & Lynch, 2008). Students' self-competency perceptions, their beliefs on how competent they are at mathematics, are known to be positively associated with their assessments of interest (Trautwein, Ludtke, Köller, Marsh, & Baumert, 2006). When students make judgements regarding their perceived competency in mathematics, it is believed that they use two different frames of reference; they compare their performance with that of their peers – external frame of reference – and/or they compare their performance with their performance in other subjects – internal frame of reference (Marsh & Hau, 2004). With two frames of reference it is hypothesised that students with achievement consistently below that of their peers may have favourable self-competency beliefs if they consider that mathematics is their best subject.

Given the close association between students' competency beliefs and their interest, researchers have explored the influence of students' frames of reference on their interest assessments. Students' use of the external frame of reference was demonstrated by Trautwein et al. (2006) who reported that ninth grade students with low achievement relative to their class are likely to report low levels of interest for mathematics irrespective of their actual achievement. Demonstrating the influence of the internal frame of reference, however, has typically involved the analysis of cross-domain associations between achievement and self-concept in mathematics and language (Marsh & Hau, 2004). The typically low or zero correlations between mathematics achievement and language self-concept, despite positive correlations between mathematics and language achievement, demonstrate the use of the internal frame of reference. Goetz, Frenzel, Hall, and Pekrun (2008) used this method to explore the use of both frames of reference in students' assessments of their enjoyment of mathematics. Their study involved cross-domain associations – mathematics and language – and reported low or negative associations



between mathematics achievement and language enjoyment, indicating that students were also making comparisons across subjects when forming self-competency beliefs. As discussed, their study relied upon cross-domain results to deduce the influence of frames of reference on students' self-competency assessments. It did not assess the use of frames of reference directly from the students. Moreover, no studies noted have specifically explored students' use of frames of reference on their interest assessment.

This study seeks to examine the influence of students' frames of reference on their assessments of interest for statistical literacy, which is defined as an ability to critically interact with messages containing statistical elements (Gal, 2003). Moreover, in line with a suggestion by Bong (1998), it seeks to examine this influence through the use of specific items that ask students to make internal and external comparisons, rather than the use of cross-domain comparisons.

Methodology

Instruments Used

All students were asked to complete the Statistical Literacy Interest Measure (SLIM), a previously validated interest instrument (Carmichael, 2008) that contains 16 self-descriptions, which students respond to using a five point Likert scale. For this sample of students, SLIM explained 67% of the variance in their responses and reported an estimated internal reliability coefficient of $\alpha=0.91$.

In order to assess their frames of reference, two additional self-descriptions were included. For the external frame of reference, students were asked to respond to the self-description "Compared to others in my class I am good at maths", and for the internal frame of reference, "Out of all my subjects I usually get my best marks in maths". Both self-descriptions were answered using the same Likert scale that ranged from 1 (*Not me at all*) to 5 (*Describes me well*).

In addition to these items, teachers of students provided estimated ratings of their students' achievement in mathematics. More specifically, these ratings matched students' achievement grades and ranged from E, the lowest grade, to A.

Sample Design and Participants

A convenience sample⁸ of 406 students was chosen so that it would be representative of the Australian middle school population. Consequently a range of government and independent schools from three Australian states were targeted and then students invited to participate. Of this sample, 59% were from Tasmania, 20% from Victoria and the remainder from Queensland. Most students (65%) attended independent schools and the majority (85%) were in Years 7, 8 or 9. The mean age of students was 13.6 years and just over one half (53%) were female.

Analysis of Data

Data was in most cases analysed using non-parametric methods such as the chi-square test of association, and graphical methods. In addition to this, group means were compared using the analysis of variance (ANOVA). In order to maintain adequate sample size it was

⁸ Since the sample was non-random, cited *p*-values are notional, as are tests of statistical significance.

necessary to collapse the original five categories in the frames of reference questions to three. More specifically, student responses of 1 or 2 on the original scales were grouped into one category indicating a negative comparison, responses of 3 were retained as a single category indicating a neutral comparison, and responses of 4 and 5 were grouped into a single category indicating a positive comparison.

Results

A cross-tabulation of students' responses to the two frames of reference (FoR) questions is shown in Table 1. It indicates that most (64%) students had similar assessments on both frames of reference, especially those who had negative or positive assessments on both.

Table 1
Cross Tabulation of Students' Responses to FoR Items

		Internal FoR			Total
		Negative	Neutral	Positive	
External FoR	Negative	128	22	6	156
	Neutral	38	35	30	103
	Positive	15	34	98	147
	Total	181	91	134	406

Relationship with Prior Mathematics Achievement

Students' prior achievement grades were adjusted to reflect their grade relative to the class median. A four-category variable was obtained that ranged from an achievement of two or more grades below the class median to an achievement of one or more grades above the class median. The cross-tabulation of this variable against the external frame of reference question is shown in Table 2. As is seen from this table, students' perception of their ability relative to their class approximately matched their teachers' estimates ($\chi^2_6 = 47, p = 0.00$). Students' responses to the internal FoR question were also associated with their relative prior achievement grades ($\chi^2_6 = 40, p = 0.00$), but not as strongly.

Table 2
Cross Tabulation of Students' Relative Maths Grade Against Their Responses to External FoR

		Maths grade relative to the class median			Total	
		≤ -2		Median		
External FoR	Negative	12	48	67	21	148
	Neutral	7	23	53	16	99
	Positive	4	8	76	49	137
	Total	23	79	196	86	384

Relationship with Interest

Based on their responses to the SLIM, students were assigned an interest for statistical literacy score. There is a clear relationship between students' responses to the frame of reference (FoR) questions and their level of interest. The mean interest score of students with negative competency assessments on the external FoR is less than that for students with neutral or positive assessments ($F = 38, p = 0.00$). Similarly, the mean interest score for students with negative competency assessments on the internal FoR is less than that of students with neutral or positive assessments ($F = 23, p = 0.00$). The interaction was examined graphically and is shown in Figure 1, which displays mean interest scores for each of the nine groups reported in Table 1 as well as 95% confidence intervals for statistically distinct groups. As is seen from this figure, for most students there is little association between their interest for statistical literacy and their responses to either FoR question, group means were close to zero for seven of the nine groups. The exception is for those students who provided negative assessments on the external FoR. This group of students also appeared to use an internal FoR. Statistically significant differences in mean interest levels occurred between students who had negative assessments on both frames of reference and those with neutral and positive assessments on the external FoR. In addition to this, there is a statistically significant difference in interest between students with negative assessments on both FoR questions, and those with a negative assessment on the external FoR and a positive assessment on the internal FoR, although as is shown in Table 1 the later group consists of only six students.

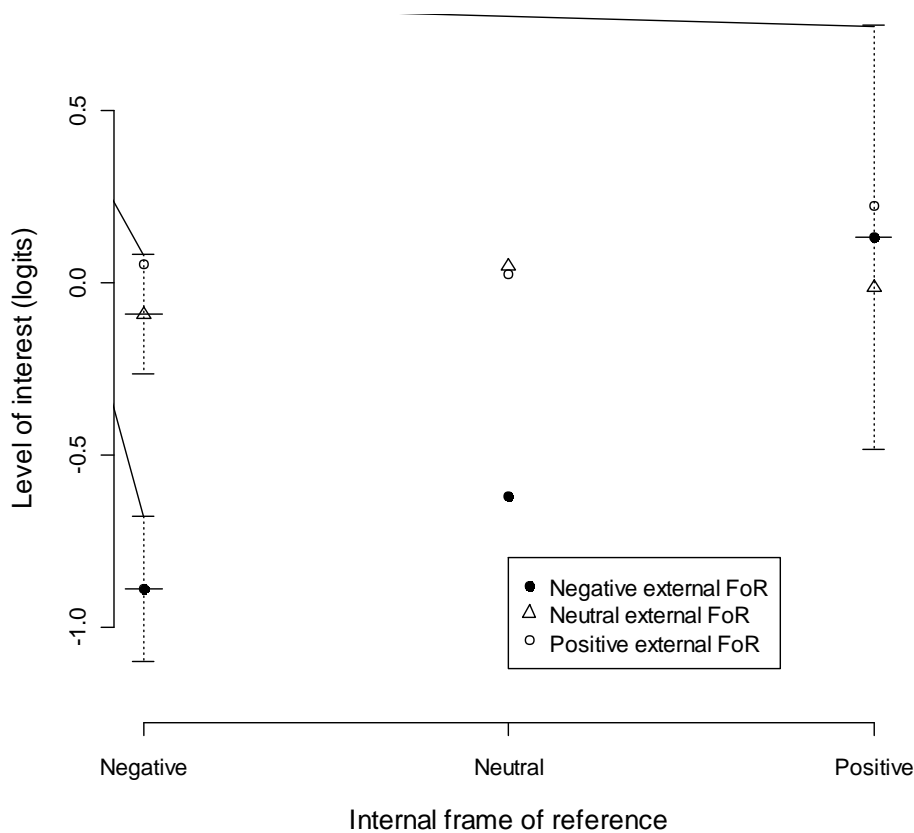

Figure 1. Mean interest scores against response on FoR items

Discussion and Implications

In this study a sample of middle school students were asked to indicate their perceived level of competence in mathematics using two frames of reference. Their responses were then compared to their level of interest for statistical literacy and group means were analysed for differences. A cross-tabulation of responses indicated that students' assessments on one frame of reference (FoR) were in most cases the same as their assessment on the other. In addition to this, students' assessments of self-competency in mathematics approximately agreed with their teachers' estimates of their achievement. The results also suggested that taken separately, students' assessments on either FoR were positively associated with their interest. For example, students who considered that they are worse at mathematics than their peers reported lower levels of interest for statistical literacy than students who considered that they are the same or better than their peers. Similarly, students who considered mathematics is their worst subject reported lower levels of interest for statistical literacy than those who considered that it is their best subject.

Given the apparent influence of both frames of references on students' interest for statistical literacy, the interaction of the two was then examined. This analysis suggested that apart from students who considered that they are worse at maths than their peers; students' interest assessments were relatively independent of their frame of reference assessment. For students who believed that they are worse at maths than their peers, however, competency assessments using both frames of reference appeared to influence their interest. These results suggest that self-competency perceptions have their greatest influence on interest or rather lack of interest, for those students with relatively negative self-competency perceptions and that such students are more likely to use both frames of reference. Interventions aimed at increasing students' interest for statistical literacy, should therefore make the greatest gains if they focus on enhancing the self-competency beliefs of such students.

In this study, frames of reference questions were focussed on mathematics in general, while interest assessments were specifically for statistical literacy. All Australian students encounter the underlying concepts of statistical literacy in the mathematics curriculum. Yet it is expected that many students will encounter statistical messages in other subjects and indeed in non-school contexts. It is possible that the apparent lack of association between FoR assessment and interest score for students who considered that they are equal or better than their peers in mathematics, could be attributed to perceived differences in the two domains. Students with relatively positive mathematics self-competency beliefs may be able to disentangle their perceived competency in mathematics from their perceived competency in statistical literacy, which in fact may span a number of subject domains. Consequently their mathematics self-competency beliefs may have a minimal influence on their interest for statistical literacy. Those students with relatively negative mathematics self-competency beliefs, however, may not be able to distinguish between the two domains. Instead providing low interest assessments for statistical literacy because they do not feel competent in the mathematics classroom.

Acknowledgements

Thanks are extended to Assoc. Prof. Rosemary Callingham, Prof. Ian Hay, and Prof. Jane Watson for their kind assistance and advice. The research was funded by Australian Research Council grant number LP0669106, with support from the Australian Bureau of Statistics.

References

- Bong, M. (1998). Tests of the internal/external frames of reference model with subject-specific academic self-efficacy and frame-specific academic self-concepts. *Journal of Educational Psychology, 90*(1), 102-110.
- Carmichael, C. S. (2008). The development and validation of the Statistical Literacy Interest Measure (SLIM). In T. Hays & R. Hussain (Eds.), *Proceedings of the third annual postgraduate research conference: Bridging the gap between ideas and doing research* (pp. 35-39). Armidale: University of New England.
- Gal, I. (2003). Teaching for statistical literacy and services of statistics agencies. *The American Statistician, 57*(2), 80-84.
- Goetz, T., Frenzel, A. C., Hall, N. C., & Pekrun, R. (2008). Antecedents of academic emotions: Testing the internal/external frame of reference model for academic enjoyment. *Contemporary Educational Psychology, 33*(1), 9-33.
- Hidi, S., & Renninger, K. A. (2006). The four-phase model of interest development. *Educational Psychologist, 41*(2), 111-127.
- Marsh, H. W., & Hau, K.-T. (2004). Explaining paradoxical relations between academic self-concepts and achievements: Cross-cultural generalizability of the internal/external frame of reference predictions across 26 countries. *Journal of Educational Psychology, 96*(1), 56-67.
- McPhan, G., Morony, W., Pegg, J., Cooksey, R., & Lynch, T. (2008). *Maths? Why Not?* (Report): Australian Department of Education, Employment and Workplace Relations (DEEWR).
- Schiefele, U. (1991). Interest, learning, and motivation. *Educational Psychologist, 26*(3 & 4), 299-323.
- Trautwein, U., Ludtke, O., Köller, O., Marsh, H. W., & Baumert, J. (2006). Tracking, grading, and student motivation: Using group composition and status to predict self-concept and interest in ninth-grade mathematics. *Journal of Educational Psychology, 98*(4), 788-806.

Aspects of Teachers' Knowledge for Helping Students Learn About Ratio

Helen Chick

University of Melbourne

<h.chick@unimelb.edu.au>

Ratio (and associated topics such as fractions and proportion) is known to be an area of mathematics that students find difficult. Multiplicative thinking is necessary, and students benefit from a wide range of strategies and representations for interpreting ratio. This study examined aspects of teachers' pedagogical content knowledge for teaching ratio, and investigated their knowledge of a typical misconception together with the strategies that they would use for dealing with such a misconception. The nature of the numerical examples that they suggested might be useful in teaching was also examined. Most teachers were able to recognise the misconception, but not all were able to generate examples that might help students to deal with it. Teachers also appeared to have only a limited repertoire of strategies to assist students.

Research into children's learning has long revealed that the topic of ratio—together with the allied topics of fractions, proportions, and percentages—is one that students find difficult (e.g., Hart, 1982). This is no surprise to teachers, whose experiences often lead them to list the topic as one of the more problematic in the curriculum. This small study examines the extent to which teachers can recognise a typical misconception associated with ratio understanding, and what strategies they have for addressing it. This implies an examination of their understanding of children's conceptions, their knowledge of models and explanations for teaching, and their capacity to modify examples in pedagogically useful ways, all of which lie in the domain of pedagogical content knowledge (PCK) (Shulman, 1986; see also Chick, Baker, Pham, & Cheng, 2006; Chick, 2007). The study also adds to the growing literature examining PCK using questionnaires with open-ended items that involve pedagogical situations; see, for example, the study of Watson, Beswick, and Brown (2006) which investigated teachers' knowledge about the teaching of fractions.

Background

One of the classic results in the history of examining students' understanding about ratio came from a large study of UK high school students reported by Hart (1982). In the Mr Short and Mr Tall problem, Mr Short was presented as being 6 paperclips tall, and then, when measured instead by matchsticks, was 4 match-sticks tall. Mr Tall, in contrast, was 6 matchsticks tall, and students were asked to determine Mr Tall's height in paperclips. Among the approximately two-thirds of students who could not answer this question correctly, many made the additive error of focussing on $6 - 4$ difference in the two measurements for Mr Short, and then added this to Mr Tall's height of 6 to get his paperclip height as 8.

Many studies since have examined students' understanding of ratio more closely, often focussing on the challenge of developing the necessary multiplicative thinking, and on the importance of identifying the component parts and the associated whole. Norton (2004), studying 12-13-year-old students, used the context of gears in Lego construction kits to help build multiplicative thinking. Some incidental understanding of equivalence was developed, such as recognising that, for gears in the ratio of 13:24, turning the larger gear



once will result in the smaller one turning 1.846 or approximately two times. Yeh and Nason (2008), working with adults with low numeracy skills, encountered a learner who struggled with even elementary equivalence such as between 1:1 and 2:2. In fact, it might be conjectured in this case that the learner's belief in non-equivalence actually led to him failing to see the "sameness" in the shades of paint used as physical representations of the ratios. The learners in the Yeh and Nason study also struggled to identify the whole. They thought that the number of "ingredients" comprised the whole, as opposed to the total number of parts present among all the ingredients, so that, for example, with four paint colours in the ratio 1:2:2:2 there was a belief that there were four parts (the number of colours) rather than nine (the number of actual parts).

The studies of Mitchelmore, White, and McMaster (2007) and Steinhorsdottir and Sriraman (2009) involved extended teaching sequences that were intended to focus on multiplicative relationships in general and ratio in particular. In the first study, with high school students, there was a focus on abstracting the idea of ratio from a series of contextualised situations. The researchers found that average ability students still had difficulty with understanding the connection between fractional and ratio representations, but noticed the usefulness of a visual depiction of ratio using a partitioned bar. The latter study, with older primary school students, showed how students' knowledge can develop with appropriate cognitively guided instruction, and identified different levels of understanding, including one associated with the difficulties of dealing with non-integer multipliers.

In addition to visual representations, another strategy that has been highlighted for ratio work is the use of ratio tables (Middleton & van den Heuvel-Panhuizen, 1994; also Brinker, 1998; Dole, 2008). A ratio table is an organising device that allows students to start with a known ratio and develop equivalent ratios, by using simple multiplication strategies, such as doubling and multiplying by 10, and then allows addition to combine previous results to obtain more complex ratios (thus, for example, a recipe involving a ratio like 2:3 might be "scaled up" to serve 12 times the amount by scaling the original by 10 (20:30) and also by 2 (4:6), and adding the results to get a ratio 24:36. This facilitates mental strategies, although it may be less effective at highlighting the direct multiplicative scaling by a factor of 12. In contrast, a teacher in one of the author's earlier studies (Chick & Harris, 2007; Chick, 2009) was very explicit in the way that she highlighted multiplicative relationships—using *only* multiplication, rather than a hybrid with addition—within an organising table like the ratio table. (See also further comments in Chick (2009) concerning the kinds of numbers that should be used as multipliers to ensure that students understand the full generality of equivalence.)

In fact, the question of how choice of numbers affects what examples might be able to exemplify is highlighted in the work of Watson and Mason (2005, 2006). Drawing on the work of Ference Marton, they highlight that general principles can be made apparent through the judicious variation of parameters or dimensions of the situation. This notion of *dimensions of variation* was explored, implicitly, in the study of two teachers' choices of examples for introductory work in ratio at the upper primary school level (Chick & Harris, 2007; Chick, 2009). It seemed evident that the capacity of the lessons to illustrate important ratio principles was influenced heavily by the numerical values and contexts of the examples used. Skemp (1971, pp. 29-30) also highlights the importance of signal and noise in examples, implying that teachers' examples must allow the key principle to be identified. Thus it seems that specific choices among the dimensions of variation will impact on an example's pedagogical effectiveness (see also Chick, 2007).

Method

The present research examined aspects of teachers' knowledge for teaching ratio. It was part of a larger study, involving a questionnaire and interview protocol intended to explore the PCK of secondary teachers who were teaching mathematics. There were 40 teachers from three schools involved in the study, comprising all those teaching at least one mathematics class in their school. The teachers' backgrounds ranged from being first year graduates and non-specialists through to teachers with many years of experience including teaching senior level mathematics. Each teacher completed a questionnaire in his/her own time, with the questionnaire focussing on a number of key topics from Years 7 to 9 of the mathematics curriculum. The fourth item in the questionnaire addressed ratio, and comprised the stem and questions shown in Figure 1.

The following question was given to Year 8 students:

Some children are making pink paint by mixing together white and red.
Shea uses 4 spoonfuls of red paint and 11 spoonfuls of white paint.
Mi-Lin uses 6 spoonfuls of red paint and 13 spoonfuls of white paint.

- (a) One student thinks these paint mixes will look the same shade of pink. Why might he think this?
- (b) What assistance/explanations might you provide to such a student?
- (c) What changes to the numbers in the question might you make in order to help students?

Figure 1. Questionnaire item about ratio given to teachers.

It should be noted that an early version of the questionnaire had question (c) worded more generally as "What examples might you use to help?". A follow-up interview was conducted with each teacher once the whole questionnaire had been completed. This interview, which followed a semi-structured protocol, gave teachers the opportunity to expand on and clarify their written responses. There were three standard questions, listed below, and occasionally teachers were asked additional questions depending on their particular responses.

- Do you think many students would think that these paint mixes give the same shade of pink?
- What difficulties do they [students] have with such problems?
- [With reference to (c)] Why did you pick those examples?

The audio-recorded interview responses were transcribed. This was not a verbatim transcription; instead responses were paraphrased to capture the main themes and specific examples. The questionnaire responses and transcribed interview responses were then incorporated into a spreadsheet. Content analysis (Bryman, 2004) was conducted with these data. Responses to question (a), together with the interview question about the prevalence of such a misconception, provided data to determine the extent to which the teachers were aware of the additive error misconception (and any other difficulties with ratio). Responses to (b) plus discussion arising in the interview provided evidence for the kinds of strategies and explanations that teachers might use to assist students. In this case the data were examined to identify emerging themes, which were then used to categorise the approaches. Finally, the whole data set was examined to collate the numerical examples that teachers proposed to use. These were analysed to determine whether or not

the examples would address the additive error misconception or whether they were intended to assist with ratio understanding more generally. Some of the teachers' examples were selected as exemplifying cases (Bryman, 2004, p.51), in order to illustrate the impact of variation on what can be exemplified.

Although the data included information about teachers' experience and main teaching areas, there were a large number of categories within the small data set that made it impossible to conduct a satisfactory examination of whether teacher knowledge depends on experience or area of expertise. In fact, an informal overview of the data set suggests that there were inexperienced teachers teaching mathematics 'out of area' who gave 'good' examples and explanations, and experienced specialist teachers whose responses had shortcomings, and that opposite cases were also present.

Results and Discussion

Identifying Possible Misconceptions

Of the 40 teachers, over 80% (33 teachers) recognised that a possible reason for the student to believe that the two different paint mixes were the same shade of pink was because of an additive relationship between the two ratios. Most of them saw that the second ratio (Mi-Lin's) involved numbers that were two more than each of those in the first, whereas six teachers identified that both ratios had an internal difference of seven between the two parts. Of the remaining seven teachers—that is, those who had not identified the additive error—four thought that students might say "Red and white always make pink" because the students did not understand that the proportions matter (this was echoed by three of the teachers who also recognised the additive error), one pointed out that in both cases white is roughly twice the red, and two did not propose a possible reason for the misconception. Just under half of the teachers thought that the additive error would be a common misconception (but it must be noted that this question was not asked consistently and, of course, not all teachers had noticed the phenomenon).

Four teachers commented that literacy issues might affect students' capacity to engage with the problem, but all but one of these could also identify the additive error misconception as a possible explanation. This fourth teacher was also one of the three teachers who did not identify the additive error among the four teachers who claimed that the context might be difficult for some students. These four teachers suggested that students' lack of experience with paint mixing might imply that they would not comprehend the way different shades of colour arise. There is a temptation to draw parallels between the teachers' claim that students cannot engage in the mathematics because of the context, and these instances of teachers themselves not engaging with mathematical aspects of the learning process because of a context.

Proposed Teaching Strategies

Table 1 shows the different strategies for assistance or explanations that teachers proposed in response to question (b), supplemented by those strategies added during the interviews. In some cases a particular strategy was applied only to the specific paint-mixing ratio problem mentioned in the item, in other cases the same strategy was intended to develop understanding about ratios more generally. This is indicated by the phrase "general or problem-specific". It also should be noted that here "use other ratio examples" *only* includes those instances where teachers made explicit mention of this strategy in

response to question (b), and does not count the examples suggested in response to the more specific question (c).

Table 1
Teaching Strategies Proposed by the Teachers (n = 40)

Teaching strategy	Number (%)
Common denominator/equivalent fractions (general or problem-specific)	7 (18%)
Pictorial representation (general or problem-specific)	15 (38%)
“Tell” or “Explain” (general or problem-specific)	6 (15%)
Convert to decimals (general or problem-specific)	9 (23%)
Unitary (general or problem-specific)	2 (5%)
Identify approximate relationship (e.g., relate to half) (problem-specific)	4 (10%)
General – use analogy (e.g., cooking)	8 (20%)
General – do mixing with real materials	12 (30%)
General – use other ratio examples	7 (18%)
General – vague	5 (13%)

Most of the suggestions from the 15 teachers for some kind of pictorial representation were problematic. There were four circular area models (pie “graphs” or pizzas), for which both the production of the representations and comparisons are difficult. Four suggestions were to use discrete materials, which are limited in their capacity to develop equivalent wholes (so that, for example, to compare 2:5 and 3:7 it is necessary to find equivalent ratios for each that can then be compared more readily). Five teachers proposed undescribed “diagrams”, drawings of tins, or use of coins. Finally, one teacher suggested a “colour picker”, in which graphics programs mix colours based on numerical values for different colours, but the proposer did not realise that most implementations of these do not use ratios (e.g., the colour produced by, say, an RGB value of 1-1-1 is different from that produced by 20-20-20). Only two of the suggestions were for number lines, which are both easy to apportion and compare (one suggestion was from a teacher who had also proposed a pie diagram, hence the 16 proposals from only 15 teachers). No teacher proposed the use of ratio tables or similar. Among the suggestions to mix real materials were paint (2), cordial and water (4), and food colouring (1), with the remainder unspecified but possibly implying paint (5). Little if any mention was made of the practicalities of this, and whether or not close ratios could be distinguished in practice. The six “tell” or “explain” responses gave no details about what might be emphasised in such an explanation.

Variation in the Proposed Examples

There were eleven teachers who did not give any additional specific numerical ratios that they thought might be useful for students to consider. Although the vague wording of the early version of question (c) may have contributed to this, by not emphasising that the researcher was interested in changes to the numbers used in the examples, most of the follow up interviews clarified this intention and gave teachers a chance to respond. In at least three cases, the researcher probed specifically for an example that would meet certain requirements but the teachers talked around the issue rather than giving numerical values.

Seven of the teachers continued to use the values given in the original problem to illustrate points that they wanted to make. For example, one teacher wrote “I might reduce the numbers so they could see that 11 is almost 3 times 4 and that 13 is only just twice 6”, when in fact the explanation is satisfactory for the task as specified and he did not actually reduce the numbers at all. Another teacher asserted that she preferred the question as stated because it allows her to ascertain which students really have understood the ratio concept.

The examples from twelve of the teachers seemed to be designed to highlight the role of factors in simplifying ratios. As an example of a non-specific low-level response one teacher wrote that she would work with “fives and tens”. In most cases, however, specific examples were given, and, in fact, these seemed part of an intention to address general ratio principles. One teacher, for instance, gave 5:15 and 3:12 as two examples that she might consider; similarly another teacher proposed 4:12 and 6:18. These choices allow for easy simplification and then comparison, although all of these examples involve simple reduction to a unitary ratio (in contrast to something like 8:12, which is equivalent to 2:3).

In fact, almost half (19) of the teachers gave examples that appeared to be concerned with broader ratio issues like equivalence and comparison (and some of these are among those mentioned in the previous paragraph involving obvious factors). One teacher chose 1:5 and 2:4, both of which have the same number of parts in total. Another chose examples that would allow students to relate ratios to benchmarks, suggesting that examples such as 5:10, 11:20, and 7:12—representing 1:2, and, for the latter two, a little more than 1 to 2—might force students to focus on ways of making comparisons. Other teachers focussed on doubling and halving operations and the fact that these lead to equivalent ratios.

Finally, and significantly, 15 of the teachers suggested examples that addressed the additive error issue (including one teacher who probably constructed his inadvertently because he had not actually identified the misconception). It should be noted that the researcher did not always probe for a misconception-addressing example in the case of teachers who had identified the error but whose examples did not target it. This may explain why less than half of the teachers who identified the misconception produced examples that addressed it. On some occasions, however, probing occurred and teachers varied in their capacity to respond ‘on the spot’.

It is illuminating to explore the consequences of the differing numerical choices among the 15 error-addressing examples. One teacher tried to work with the original problem, explaining that adding a 4:11 mix and a 2:2 mix would have different proportions to the original 4:11 mix, but did not attend to the complex issue of what happens to wholes in this process. Three of the teachers gave 1:2 and 2:3 as example pairs: these are simple ratios, with an increment of one from the first to the second (i.e., both red and white have increased by one spoonful), but only one of the teachers specified the argument needed to convince students that these ratios are, indeed, different, saying that in the first ratio white is twice red, whereas in the second it is not. A similar ‘what is doubled’ relationship argument was proposed by the teacher who suggested using 1:3 and 2:4 (again, with an increment of one), and by the teacher who suggested 2:1 and 4:3 (this time an increment of two). One teacher proposed 4:12 and 8:16 (with an increment of 4), with the choice of numbers readily allowing simplification to obtain the easy-to-compare unitary equivalent ratios 1:3 and 1:2. Another teacher began with 4:11 and argued its equivalence to 8:22, and then highlighted that this is a different ratio from going up by two twice, which would give 8:15. A particularly striking example of an error-addressing pair of ratios was given by another teacher who proposed 1:10 and 11:20 (an increment of 10), with the former very

obviously containing very little red—one-tenth of the white, in fact—and the latter containing about half as much red as white.

The final example to be discussed was constructed during the interview and shows a range of aspects of teacher knowledge. The teacher began by proposing 2:3 and 3:4 as an error-addressing pair, but then realised that the 3:4 in particular would be awkward to represent using her preferred sectors-of-a-circle model for fractions and ratios. The 2:3, with 5 parts in total, was not a problem since 360 is divisible by 5. She then adjusted 3:4 by another increment of 1 to make it 4:5, which is still related to 2:3, but which is now made of 9 parts and is thus easy to represent using the circle model. Her discussion in the interview articulated the mathematical relationships she was trying to achieve.

Conclusions

This study found that the vast majority of mathematics teachers—at least in this sample—recognised the additive error misconception. There was wide variation, however, in the teachers' suggestions for strategies that might assist students. Very few of the suggestions proposed in part (b) specifically addressed the additive error, although by the end of the overall questionnaire and interview protocol about half of the teachers who had recognised the additive error could provide targeted examples for students. It is acknowledged that the lack of detail about what, exactly, would be included in an “explain” or “tell” response may have been an artefact of the questionnaire approach and the lack of further probing in the interview. Nevertheless it may reflect a difficulty that some teachers have in actually articulating the mathematical heart of a teaching issue. If this is the case, then there is cause for concern here. Similarly, there were problems involving the mathematical and pedagogical heart of most of the pictorial representations as well. Pie ‘graphs’ may represent the mathematics appropriately but construction is relatively complex mathematically and they are not easy to compare, which is a pedagogical issue. Discrete models have difficulty representing a whole, and have limitations for showing equivalence depending on the numbers of parts involved. Finally, it was striking that no teacher proposed a simple computational organiser like a ratio table.

The examination of the examples that teachers proposed as ways of modifying the problem for teaching highlights how what it is possible to exemplify may be dramatically affected by the choice of numerical values. Some of the examples that teachers proposed seemed much better for featuring a principle than others.

These results highlight the complexity of the knowledge required for effective teaching. There is a need for mathematical knowledge, such as, for ratio, understanding the relationship between parts and wholes, and the concept of equivalence. There is a need to know appropriate models that have sufficient epistemic fidelity (cf. Stacey, Helme, Archer, & Condon, 2001) to represent the concepts in mathematically appropriate and pedagogically productive ways. There is a need to understand the pedagogical effect of the dimensions of variation in families of examples. There are, of course, other requirements as well, but these are particularly evident in this study.

The results also highlight how mathematical considerations have important pedagogical consequences. This is frequently assumed as being both true and something that those involved in teaching mathematics take into account, but there is evidence in the results here that, at the least, teachers' conversations about their work do not always focus on this. Helping educators to attend to these issues seems to be an important role of pre- and in-service professional learning activities.

Acknowledgements

This research was supported by Australian Research Council grant LP0882176 (and also informed by work from DP0344229), with co-researchers Kaye Stacey and Vicki Steinle, and research assistants Beth Price and Eugene Gvozdenko. Beth conducted some of the interviews.

References

- Brinker, L. (1998) Using recipes and ratio tables to build on students' understanding of fractions. *Teaching Children Mathematics*, 5 (4), 218-224.
- Bryman, A. (2004). *Social research methods* (2nd ed.). Oxford: Oxford University Press.
- Chick, H. L. (2007). Teaching and learning by example. In J. Watson & K. Beswick (Eds.), *Mathematics: Essential research, essential practice* (Proceedings of the 30th annual conference of the Mathematics Education Research Group of Australasia, pp. 3-21). Sydney: MERGA.
- Chick, H. L. (2009). Choice and use of examples as a window on mathematical knowledge for teaching. *For the Learning of Mathematics*, 29 (3), 26-30.
- Chick, H. L., Baker, M., Pham, T., & Cheng, H. (2006). Aspects of teachers' pedagogical content knowledge for decimals. In J. Novotná, H. Moraová, M. Krátká, & N. Stehlíková (Eds.), *Proceedings of the 30th annual conference of the International Group for the Psychology of Mathematics Education* (Vol. 2, pp. 297-304). Prague: PME.
- Chick, H. L. & Harris, K. (2007). Pedagogical content knowledge and the use of examples for teaching ratio. *Proceedings of the 2007 annual conference of the Australian Association for Research in Education* (Fremantle, WA, 25 - 28 November, 2007). Retrieved 24 May 2010 from <http://www.aare.edu.au/07pap/chi07286.pdf>.
- Dole, S. (2008). Ratio tables to promote proportional reasoning in the primary classroom. *Australian Primary Mathematics Classroom*, 13(2), 18-22.
- Hart, K. M. (Ed.). (1982). *Children's understanding of mathematics: 11-16*. London: John Murray.
- Middleton, J. A., & van den Heuvel-Panhuizen, M. (1995). The ratio table. *Mathematics Teaching in the Middle School*, 1(4), 282-288.
- Mitchellmore, M., White, P., & McMaster, H. (2007). Teaching ratio and rates for abstraction. In J. Watson & K. Beswick (Eds.), *Mathematics: Essential research, essential practice* (Proceedings of the 30th annual conference of the Mathematics Education Research Group of Australasia, pp. 503-512). Sydney: MERGA.
- Norton, S. J.** (2004). Using Lego construction to develop ratio understanding. In I. Putt, R. Faragher, & M. McLean (Eds.), *Mathematics education for the third millennium: Towards 2010* (Proceedings of the 27th annual conference of the Mathematics Education Research Group of Australasia, pp. 414-421). Sydney: MERGA.
- Shulman, L. S. (1986). Those who understand: Knowledge growth in teaching. *Educational Researcher*, 15(2), 4-14.
- Skemp, R. R. (1971). *The psychology of learning mathematics*. Harmondsworth, UK: Penguin.
- Stacey, K., Helme, S., Archer, S., & Condon, C. (2001). The effect of epistemic fidelity and accessibility on teaching with physical materials: A comparison of two models for teaching decimal numeration. *Educational Studies in Mathematics*, 47(2), 199-221.
- Steinhorsdottir, O. B., & Sriraman, B. (2009). Icelandic 5th-grade girls' developmental trajectories in proportional reasoning. *Mathematics Education Research Journal*, 21, 6-30.
- Watson, A., & Mason, J. (2005). *Mathematics as a constructive activity: Learners generating examples*. Mahwah, NJ: Lawrence Erlbaum Associates.
- Watson, A., & Mason, J. (2006). Seeing an exercise as a single mathematical object: Using variation to structure sense-making. *Mathematical Thinking and Learning*, 8(2), 91-111.
- Watson, J., Beswick, K., & Brown, N. (2006). Teachers' knowledge of their students as learners and how to intervene. In P. Grootenboer, R. Zevenbergen, & M. Chinnappan (Eds.), *Identities, cultures and learning spaces* (Proceedings of the 29th annual conference of the Mathematics Education Research Group of Australasia, pp. 551-558). Sydney: MERGA.
- Yeh, A., & Nason, R. (2008). Mixing colours: An ICT tool based on a semiotic framework for mathematical meaning-making about ratio and fractions. In M. Goos, R. Brown, & K. Makar (Eds.), *Navigating currents and charting directions* (Proceedings of the 31st annual conference of the Mathematics Education Research Group of Australasia, pp. 605-611). Sydney: MERGA.

Teachers' Extent of the Use of Particular Task Types in Mathematics and Choices Behind That Use

Doug Clarke

Australian Catholic University
<doug.clarke@acu.edu.au>

Anne Roche

Australian Catholic University
<anne.roche@acu.edu.au>

As part of a larger project, *Task Types in Mathematics Learning*, through the use of a questionnaire, we sought middle years mathematics teachers' insights into the task types they chose to use in mathematics, the reasons for these choices, and the ways (if any) in which their choices had changed as a result of their involvement in the project. We found that teachers were able to articulate the reasons for their choices, and that both the choices and the reasons given varied considerably across the group. We also found that most teachers had changed their relative use of task types as a result of the project. Of particular note was the increased use of contextual tasks.

Mathematical tasks are important for teaching, and the nature of student learning is determined by the type of task and the way it is used (Kilpatrick, Swafford, & Findell, 2001; Sullivan, Clarke, Clarke, & O'Shea, 2009). It has been argued that the tasks set and the associated activity form the basis of the interaction between teaching and learning (Christiansen & Walther, 1986) and that "instructional tasks and classroom discourse moderate the relationship between teaching and learning" (Hiebert & Wearne, 1997, p. 420).

Stein, Grover, and Henningsten (1996) developed a conceptual framework that involved a set of differentiated task-related variables leading toward student learning. The model moved from the task as represented in curriculum materials to the task as set up by the teacher in the classroom, to the task as implemented by students in the classroom to student learning, including proposed factors, which may influence how the task variables related to each other.

When teachers pose higher order tasks, students give longer responses and demonstrate higher levels of performance on mathematical assessments (Hiebert & Wearne, 1997). The greatest gains on performance assessments, including questions that required high levels of mathematical thinking and reasoning, are related to the use of instructional tasks that engage students in "doing mathematics or using procedures with connection to meaning" (Stein & Lane, 1996, p. 50). A growing body of research has focused on the design and implementation of tasks, including problem situations, questioning methods, and activities for promoting student learning (Tzur, Zaslavsky, & Sullivan, 2008). Krainer (1993) claimed that, "powerful tasks are important points of contact between the actions of the teacher and those of the learner" (p. 68). As Silver and Herbst (2008) noted, "teachers' decisions and actions influence the nature and extent of student engagement with challenging tasks and ultimately affect students' opportunities to learn from their work on such tasks" (p. 55).

Herbst (2008, p. 125) distinguished between problem ("the mathematical statement of the work to do") and task ("the anticipated or observed deployment of one such problem over time, in the actions and interactions of particular people ... doing particular operations with particular resources.")

Teacher knowledge can be crucial in task enactment. Charalambous (2008), who focused on tasks and the Mathematical Knowledge for Teaching (MKT), (Hill, Ball, & Schilling, 2008), contrasted the actions of a high MKT teacher who "largely maintained the cognitive demand of curriculum tasks at their intended level during task presentation and enactment" and a low-MKT teacher who "proceduralized even the intellectually demanding tasks she was

using and placed more emphasis on students' remembering and applying rules and formulas" (p. 287).

Of particular interest in this study were the decisions teachers make in relation to their choice of tasks, and the relative benefit they attribute to different kinds of tasks. Anderson (2003) drew on responses to extensive questionnaires completed by 162 primary teachers in New South Wales. For the purpose of her study, she classified school mathematics questions as exercises, application problems, open-ended problems or unfamiliar problems. Exercises were claimed to be used "often" by 68% of respondents. Teachers believed that they provided practice in basic skills, particularly for low ability students, could be used to assess understanding, and enabled children to experience success. A common theme was that open-ended problems were challenging and therefore more suitable for more able students or students in higher grades. Anderson noted that the experience and confidence of the teacher appeared to be a major contributing factor in their choice of tasks, as were ability grouping practices, resource availability and assessment procedures.

Henningsen and Stein (1997) noted that, "the nature of tasks can potentially influence and structure the way students think and can serve to limit or broaden their views of the subject matter with which they are engaged" (p. 525). Students develop their sense of what it means to "do mathematics" from their actual experience with mathematics.

In this article, we describe briefly a project in which middle years' teachers and students were exploring the effective use of a range of task types in mathematics classrooms. We outline the task types, and then provide information of the relative use of these task types by individual project teachers, the changes in use they identified over the course of the project, and the reasons for their choices in this respect.

The TTML Project

In collaboration with teachers and students in Government and Catholic schools in three geographical clusters in Victoria, the Task Type and Mathematics Learning (TTML) project investigated the best ways to use different types of mathematics tasks, particularly in Grades 5 to 8. TTML was an Australian Research Council funded partnership between the Victorian Department of Education and Early Childhood Services, the Catholic Education Office (Melbourne), Monash University, and Australian Catholic University. Principal investigators were Peter Sullivan, Barbara Clarke and Doug Clarke. The author limit on MERGA papers restricted the list of authors for this paper.

Essentially the project focused on three types of mathematical tasks that we describe as follows:

Type 1: The teacher uses a model, example, or explanation that elaborates or exemplifies the mathematics. Such tasks are associated with good traditional mathematics teaching. The mathematical purpose is clear and the tools/models/representations are linked directly and explicitly. An example is a teacher who uses a fraction wall to provide a linear model of fractions, and poses tasks that require students to compare fractions, to determine equivalences, and to solve fractional equations.

Type 2: The teacher situates mathematics within a contextualised practical problem to engage the students, but the motive is explicitly mathematical. This task type has a particular mathematical focus as the starting point and the context exemplifies this. The context serves the twin purposes of showing how mathematics is used to make sense of the world and motivating students to solve the task. An example of this is: How many people can stand in your classroom? (Lovitt & Clarke, 1989) In this case, the task is "Imagine we have the opportunity to put on a concert in this classroom with a local band to raise funds for more school computers. How many tickets should we sell?" Here, the context provides a motivation for what follows and dictates the mathematical decisions that the students make.

Type 3: Teacher poses open-ended tasks that allow students to investigate specific mathematical content. Content-specific open-ended tasks have multiple possible answers and prompt insights into specific mathematics through students seeing and discussing the range of possible answers. An example is: A group of 7 people went fishing. The mean number of fish caught was 7, the median was 6 and the mode was 5. How many fish might each of the people have caught? The power of such tasks has been established by Cruz and Garrett (2006) and others.

These task types are not claimed to include all possible tasks and the categories are not mutually exclusive, with many tasks difficult to classify uniquely.

The project involved full day and after school professional learning sessions for teachers, some team teaching in classrooms, and considerable observation of teachers as they used the different task types in lessons. (See O'Shea & Peled (2009) for a more detailed description of the project.)

Elsewhere (see, e.g., Clarke, Clarke, Sullivan, O'Shea, & Roche, 2009), we have provided information on students' perceptions of those tasks that are most enjoyable and those from which they learn the most. Our focus in this paper is on the reasons behind teachers' choices of particular task types in planning and teaching.

Our research questions were the following:

- What is claimed to be the relative use of particular task types in the mathematics classroom by teachers who have participated in the TTML project for at least two years?
- What reasons do teachers give for their choices in this respect?
- How do teachers claim the relative use of particular task types has changed from what it was prior to their involvement in the project?

Methodology

In the final month of the project, teachers were surveyed on their use of particular task types. The data discussed in this paper are derived from the responses of 16 teachers who had been involved in the project for at least two years. It was believed that extended experience in using the different task types provided a good basis for commenting on their relative use and merit.

The questionnaire items that form the basis of discussion within this paper are shown in Figure 1.

The element "8" in the Venn Diagram refers to tasks which were neither models, contextual or open ended and would include, for example, *exercises* (Anderson, 2003). Although it had originally been intended to survey the relative use of the three "pure" task types, as the project progressed it became clear that there was not always widespread agreement on classification. That is, very few tasks were seen by teacher participants and the project team as solely Type 1, 2 or 3. There was another survey item where teachers were given eight tasks and asked to locate each within the Venn Diagram. However, the results for that item are not included or discussed here.

In the TTML Project, we have explored the use of three types of tasks:

Type 1: Teachers use tasks that involve the introduction to, or use of models, representations, tools, or explanations, which exemplify the mathematics

Type 2: Teachers situate mathematics within a contextualised practical problem where the motive is explicitly mathematics

Type 3: Students investigate specific mathematical content through open-ended tasks

In our discussions, we suspect that some tasks have features of more than one task type, indicated by the numbers in the diagram below (e.g., #6 refers to tasks which are based on contexts and are also open-ended, but don't involve models).

(i) Please select the part of the diagram (No. 1 – 8) that best describes the types of tasks you most often choose to use when teaching mathematics and explain why.

a) Most common: #
Reason why this is most common:

b) Second most common: #
Reason why this is second most common:

(ii) Please select the part of the diagram that best describes the type of tasks that you would least likely choose when teaching mathematics and explain why.

c) Least likely choice: #
Reason why this is the least likely to be chosen:

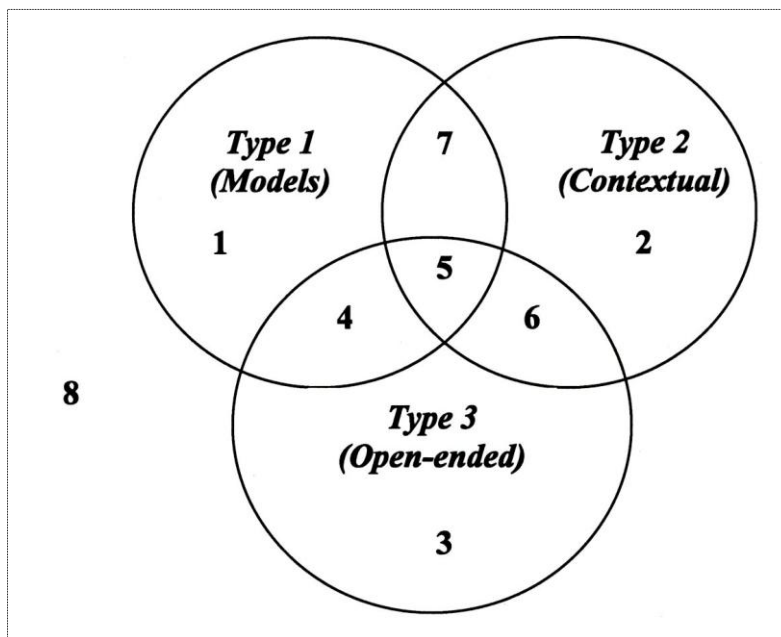

Figure 1. TTML teacher survey on use of task types, July 2009.

We acknowledge too that the mere statement of a task does not necessarily anticipate how a teacher will use it in a classroom, with, for example, the potential for a teacher to greatly “close” a potentially open task.

Results

In the next section, we discuss the relative use of different task types claimed by teachers. In the following section, we discuss the reasons given for these choices.

Relative Use of Task Types

In Table 1, we show the results of the responses to these items. The distribution of choices for the most common of the eight, the second most common, the least common, and the most common prior to the project are given.

Table 1

Frequencies of Use of Task Types in TTML Survey (n = 16)

	Part of the Venn Diagram							
	1	2	3	4	5	6	7	8
Most Common	2	2	1	2	2	5	2	
2nd Most Common	7	1	3	1		3	1	
Least Likely Choice	2	3	3		3			5
Prior to the Project	7	2	5	1	1			1

It should be noted that the frequencies for the item relating to teachers’ use of tasks prior to the project add up to 17 because some teachers chose more than one task type in this item and others chose none.

As can be seen from Table 1, there was a considerable diversity of responses to the items regarding the most common and second most common elements within the Venn Diagram. Tasks, which were both open-ended and contextual, (#6) were rated by more teachers as most common than any other choice. However, tasks which were Type 1 solely (i.e., #1) were the most common response to “the 2nd most common” item. When the responses to “common” and “second most common” were added together, elements 6 and 1 were greater than the rest put together (totalling 8 and 9, respectively).

Element 8 (tasks which were neither Type 1, Type 2, nor Type 3) were not surprisingly the least common choice late in the project. We would see these task types as being largely exercises. It was also interesting that “pure” Type 1 tasks (# 1) and “pure” Type 3 tasks (# 3) were nominated most commonly as in greatest use prior to the project.

Although it is acknowledged that overlaps between task types are important, we decided nevertheless to rework the frequencies, to allow for the relative frequencies of tasks that had at least a component of Types 1, 2 and 3, respectively. Table 2 provides these data.

Table 2

Frequencies of Use of Task Types When Grouped in Main Categories (n = 16)

Parts of the Venn Diagram	Type 1	Type 2	Type 3
	1, 4, 5, 7	2, 5, 6, 7	3, 4, 5, 6
Most Common	8	9	11
2nd Most Common	9	5	6
Least Likely Choice	5	6	6
Prior to the Project	9	4	7

It is clear from Table 2, that when grouped according to the original components (models, contextual, open-ended), there is little difference between the relative frequencies of the three, for most common, second most common and least common. However, it is interesting to note that, based on their responses to these items, teachers were clearly making greater relative use of contextual tasks towards the end of the project than prior to the project. Comments during professional learning sessions early in the project indicated that teachers found these the hardest to create themselves, but the greater identified use later in the project may indicate that teachers’ confidence with generating appropriate contextual tasks had grown.

In the next section, we will discuss the reasons given for teachers’ choices.

Reasons Given for Choices Related to Task Use

The teachers were able to articulate the reasons for their preferences and the perceived benefits or disadvantages of the tasks types for their students. From these responses, some themes emerged. These are now discussed for each task type:

Type 1: Models. Those who used Type 1 tasks more than others claimed that these tasks allowed for more explicit teaching and provided more structure for students who lacked confidence. The tasks were seen by some as providing opportunities to build a skill base and were usually more hands-on and practical. Type 1 tasks were noted to be more useful for teaching fractions, decimals and percentages and often included concrete materials. One teacher felt using Type 1 meant he/she was more “in control” and another suggested she/he used this task type to “build a knowledge base” and then practise using games. Only one teacher referred to the use of “games” in this survey, and this was in connection with the use of Type 1 tasks.

One teacher stated that these types of tasks were more “teacher driven” and did not allow for students to use different strategies or to problem solve. More teachers used these types of tasks prior to the project, and some worried that when used in isolation they were not meeting the needs of all students, and may have been less engaging than other task types.

Type 2: Contextual. Those who made most use of Type 2 tasks claimed that they were useful for connecting mathematics to the students’ world, enabling them to become “more critical consumers and thinkers.” One noted that “maths is more interesting and exciting when it has a real world purpose” and another felt that the problem solving context enabled concepts to be reinforced. Some noted that students enjoyed the challenge of these tasks and that they allowed students to “experiment with mathematical ideas.” One teacher found it easy to provide contextual activities by using the newspaper, television and local events.

On the other hand, one teacher felt that some students struggled with tackling these types of tasks and sometimes had trouble knowing how to begin. Another teacher noted that these types of tasks can tend to take longer than other task types and may not be the best use of time for all students. One teacher found it difficult to develop contextual problems that genuinely linked to their unit of work.

Type 3: Open-ended. Those who made greatest use of Type 3 tasks stated that they were useful for catering for a range of abilities and could be used for assessment and as a “reporting tool.” Several noted that open-ended tasks provided opportunities for the students to discuss their strategies or ways of solving problems and were sometimes a “springboard to other ideas.” One noted that she/he predominantly used open-ended tasks (and contextualised tasks) for a unit on measurement. Another found that these were easy to develop and to link to their units of work.

In contrast, one teacher claimed that this type of task was used the least because they were used as assessment tasks only. Another only chose these tasks for students who were low achievers. One teacher stated that students needed more help to solve open-ended tasks and that it was difficult to determine what the students had learned. This teacher also found that they were difficult to use as an assessment item because it took time to analyse the responses.

As mentioned earlier, the most commonly used combination in the Venn Diagram was tasks which were both contextual and open-ended. One teacher explained her/his choice of these as follows: “Open-ended tasks are the easiest way to cater for different ability groups. The context enables students to engage with the task and therefore connect with the mathematics.”

Conclusion

Overall, as a result of the TTML Project, most teachers stated that they were now more aware of the range of task types and looked actively for opportunities to use all three task types. They now felt able to select the task type that best suited the purpose or focus of the lesson and were more likely to choose tasks that catered for the range of abilities in their class. One teacher summed this view up as follows, reflecting on her/his prior focus on Type 1 tasks: “I felt in control of the content, wasn’t aware of the need to differentiate learning, or confident enough to allow students to develop their own strategies to problem solve.”

Teachers claimed to be now more mindful of providing a variety of experiences that allowed for a range of strategies and ways of thinking. Some noted that in particular the project had highlighted for them the use of contextual problems. For example, one commented that, “I think this project has highlighted contextual problems (genuine contexts) and also developed the understanding and recognition of all the elements which contribute to a rich task.” In an important paper on task complexity and task selection, Williams and Clarke (1997) noted that “the practical act of task selection can only be undertaken in the knowledge of the students for whom the task is intended and the purpose for which the task is being chosen” (p. 414). There is some evidence from our study that the teachers in the TTML project were increasingly making choices of task based on both their knowledge of students and a clear mathematical purpose.

References

- Anderson, J. (2003). Teachers’ choice of tasks: A window into the beliefs about the role of problem solving in learning mathematics. In L. Bragg, C. Campbell, G. Herbert, & J. Mousley (Eds.), *Mathematics education research: Innovation, networking, opportunities* (Proceedings of the 26th annual conference of the Mathematics Education Research Group of Australasia, pp. 72-79). Pymble, NSW: MERGA.
- Charalambous, C. Y. (2008). Mathematical knowledge for teaching and the unfolding of tasks in mathematics lessons: Integrating two lines of research. In O. Figuras, J. L. Cortina, S. Alatorre, T. Rojano, & A. Sepulveda (Eds.), *Proceedings of the 32nd Annual Conference of the International Group for the Psychology of Mathematics Education* (Vol. 2, pp. 281-288). Morelia: PME.
- Christiansen, B., & Walther, G. (1986). Task and activity. In B. Christiansen, A. G. Howson, & M. Otte (Eds.), *Perspectives on mathematics education* (pp. 243-307). Holland: D. Reidel.
- Clarke, B. A., Clarke, D. M., O’Shea, H., Sullivan, P., & Roche A. (2009). Likes and learning: Students’ perceptions of the value of different mathematical task types. In M. Tzekaki, M. Kaldrimidou, & H. Sakonidis (Eds.), *In search of theories in mathematics education* (Proceedings of the 33rd Conference of the International Group of Psychology of Mathematics Education, Vol. 1, p. 361). Thessaloniki, Greece: PME.
- Cruz, J. A. G., & Garrett, A. J. (2006). Students’ actions in open and multiple-choice questions regarding understanding of averages. In J. Novotna, H. Moraova, M. Kratka, & N. Stehlikova (Eds.), *Proceedings of the 30th Conference of the International Group for the Psychology of Mathematics Education* (Vol. 3, pp. 161-168). Prague: PME.
- Herbst, P. (2008). The teacher and the task. In O. Figuras, J. L. Cortina, S. Alatorre, T. Rojano, & A Sepulveda (Eds.), *Proceedings of the 32nd Annual Conference of the International Group for the Psychology of Mathematics Education* (Vol. 1, pp. 125-133). Morelia: PME.
- Henningsen, M., & Stein, M. K. (1997). Mathematical tasks and student cognition: Classroom based factors that support and inhibit high-level mathematical thinking and reasoning. *Journal for Research in Mathematics Education*, 28(5), 424-549.
- Hiebert, J., & Wearne, D. (1997). Instructional tasks, classroom discourse and student learning in second grade arithmetic. *American Educational Research Journal*, 30(2), 393-425.
- Hill, H., Ball, D., & Schilling, S. (2008). Unpacking pedagogical content knowledge: Conceptualising and measuring teachers’ topic-specific knowledge of students. *Journal for Research in Mathematics Education*, 39(4), 372-400.
- Kilpatrick, J., Swafford, J., & Findell, B. (2001). *Adding it up: Helping children learn mathematics*. Washington, DC: National Academy Press.
- Krainer, K. (1993). Powerful tasks: A contribution to a high level of acting and reflecting the mathematics instruction. *Educational Studies in Mathematics*, 24, 65-93.

- Lovitt, C., & Clarke, D. M. (1989). *Mathematics curriculum and teaching program activity bank*. Carlton, Victoria: Curriculum Corporation.
- O'Shea, H., & Peled, I. (2009). The Task Types and Mathematics Learning research project. In R. Hunter, B. Bicknell, & T. Burgess (Eds.), *Crossing divides* (Proceedings of 32nd annual conference of the Mathematics Education Research Group of Australasia, Volume 2, pp. 714-718). Palmerston North, New Zealand: MERGA.
- Silver, E. A., & Herbst, P. G. (2008). Theory in mathematics education scholarship. In F. K. Lester (Ed.), *Second handbook of research on mathematics teaching and learning* (pp. 39-68). Charlotte, NC: Information Age Publishing.
- Stein, M. K., & Lane, S. (1996). Instructional tasks and the development of student capacity to think and reason: An analysis of the relationship between teaching and learning in a reform mathematics project. *Educational Research and Evaluation*, 2(1), 50-80.
- Stein, M. K., Grover, B. W., & Henningsen, M. (1996). Building student capacity for mathematical thinking and reasoning: An analysis of mathematical tasks used in reform classrooms. *American Educational Research Journal*, 33(2), 455-488.
- Sullivan, P., Clarke, D. M., Clarke, B. A., & O'Shea, H. (2009). Exploring the relationship between tasks, teacher actions, and student learning. In M. Tzekaki, M. Kaldrimidou, & H. Sakonidis (Eds.), *In search of theories in mathematics education* (Proceedings of the 33rd Conference of the International Group of Psychology of Mathematics Education, Vol. 5, pp. 185-192). Thessaloniki, Greece: PME.
- Tzur, R., Zaslavsky, O., & Sullivan, P. (2008). Examining teachers' use of (non-routine) mathematical tasks in classrooms from three complementary perspectives: Teacher, teacher educator, researcher. In O. Figuras, J.L. Cortina, S. Alatorre, T. Rojano, & A. Sepulveda (Eds.), *Proceedings of the 32nd Annual Conference of the International Group for the Psychology of Mathematics Education* (Vol. 1, pp. 121-123). Morelia: PME.
- Williams, G., & Clarke, D. (1997). Mathematical task complexity and task selection. In D. Clarke, P. Clarkson, D. Gronn, M. Horne, L. Lowe, M. Mackinlay & A. McDonough (Eds.), *Mathematics: Imagine the possibilities* (Proceedings of the 34th annual conference of the Mathematics Association of Victoria, pp. 406-415), Brunswick, Victoria: MAV.

Students as Decoders of Graphics in Mathematics

Carmel M. Diezmann

Queensland University of Technology
c.diezmann@qut.edu.au

Tom Lowrie

Charles Sturt University
tlowrie@csu.edu.au

This paper reports on students' ability to decode mathematical graphics. The findings were: (a) some items showed an insignificant improvement over time; (b) success involves identifying critical perceptual elements in the graphic and incorporating these elements into a solution strategy; and (c) the optimal strategy capitalises on how information is encoded in the graphic. Implications include a need for teachers to be proactive in supporting students' to develop their graphical knowledge and an awareness that knowledge varies substantially across students.

Numeracy has been a priority within Australia for the past decade with a national agenda that includes substantial investment in numeracy initiatives and the monitoring of achievement through national testing of Years 3, 5, 7 and 9 students. Underlying these directions is the goal of developing a numerate society in which citizens can cope with the mathematical demands of life at school, at home, at work, and in the community. However, we contend that the achievement of the numeracy goal is dependent (at least in part) on developing students' proficiency in decoding the range of graphics that are used for the communication and organisation of mathematical information. The purpose of this paper is to examine how knowledge of information graphics influences success in mathematics through an investigation of students' performance on items with embedded information graphics. In Hill, Ball, and Schilling's (2008) terms, we are investigating the *knowledge and content of students* (KCS), which is one of three components of pedagogical content knowledge (PCK). As a background, we present an overview of information graphics and how expertise develops. Following the results of the investigation, we consider the findings in relation to the *knowledge of content and teaching* (KCT), another component of PCK. (The final component of PCK relates to *knowledge of curriculum*.)

Background

The Content of Information Graphics

In mathematics, information graphics convey quantitative, ordinal, nominal or spatial information via perceptual elements (Mackinlay, 1999). These elements are position, length, angle, slope, area, volume, density, colour saturation, colour hue, texture, connection, containment and shape (Cleveland & McGill, 1984). Although information graphics is a burgeoning field (Harris, 1996), there are six "graphic languages" that link perceptual elements via particular encoding techniques (Mackinlay, 1999). Examples from the six graphic languages, their perceptual elements and encoding techniques are described in Table 1 and shown in the Appendix. To capitalise on the power of each graphic language, students need to understand the constraints and affordances of each encoding technique. For example, if quantitative information is known about one segment on a pie chart, information can be inferred about another segment on the same pie chart based on its relative size (Affordance) but not about a segment on a different pie chart (Constraint).



Table 1
Examples of Graphic Languages

Graphic Language	Example Items	Perceptual Elements	Encoding Technique
Axis	Numberline	Points, line, position	Each position encodes information by the placement of marks on axis.
Apposed-position	Line Graph	Points, line, position	Information is encoded by a marked set positioned between two axes.
Map	Street Map	Points, line, position	Information is encoded through the spatial location of marks on a grid.
Retinal-List	Flip Item	Shape, position, connection, containment	Retinal properties of shape and orientation are used to encode information. These marks are not dependent on position.
Connection	Game	Shapes, line, connection	Information is encoded by a set of shapes connected by a set of lines.
Miscellaneous	Pie Chart	Shapes, angles, containment	Information is encoded through angles and containment.

The Development of Expertise with Graphics

Expertise in communication involves proficiency in both the semantic and syntactic dimensions of a language. Like written language, information graphics have a *semantic* dimension (e.g., perceptual elements) and a *syntactic* dimension (e.g., organisation of elements within a graphic). However, unlike (typical) written language, which utilises a sentential mode of communication and requires sequential (cognitive) processing to extract meaning, the syntactic dimension of graphics is underpinned by a visual-spatial mode of communication and requires simultaneous processing to decode information. Thus, expertise with information graphics will be quite distinct from expertise in written language. Within the domain of graphics, expertise should be characterised by three stages of capability according to Alexander's (2003) *Model of Domain Learning* (MDL). At the *acclimation stage*, students are orienting to a new domain and knowledge will be limited and fragmented; at the *competence stage*, individuals have foundational and comprehensive knowledge of the domain; at the *proficiency stage*, individuals have breadth and depth of knowledge and may contribute new knowledge to the domain.

Design and Methods

This study employed a longitudinal design to monitor the development of students' ability to decode graphics in mathematics items and to solve these items. Students' ability was investigated using a multi-method approach. The research questions were:

1. How do students perform on graphic languages over time?
2. How do students solve items from particular graphic languages?

The Graphic Languages in Mathematics (GLIM) Instrument and Participants

The GLIM instrument. This is a 36-item multiple choice test that contains six items of varying difficulty from each of the six graphic languages. The items were sourced from

published tests that have been administered to students in the mid-late primary years. Due to the limited Connection items in mathematics tests, some content free items from science tests were also included. A full description of the GLIM instrument is presented elsewhere (Diezmann & Lowrie, 2009a). The GLIM test was administered in mass testing situations over three consecutive years when students were in 9Years 5, 6 and 7. Items were scored 1 and 0 for correct and incorrect responses respectively. Students' performances were calculated on each language subtest (max. score = 6) and the overall test (max. score = 36). Also, over a 3-year period, different cohorts of students were progressively interviewed on sets of twelve GLIM items commencing with the easiest pair of tasks in each graphic language. After completing each pair of items, students then justified their multiple choice response. The interviewer probed their reasoning but no scaffolding was provided. Here we report on five of these items (See Appendix, Items 1, 20, 27, 28 and 36).

Participants. There were three cohorts of participants. Cohort 1 was drawn from two Queensland and five New South Wales schools and completed the mass testing only. This cohort commenced with 371 students in the first year of the study when students were aged approximately 10 years and subsequently reduced to 352 and 325 in successive years. Cohort 2 ($N = 67$) and Cohort 3 ($N = 47$) were sourced from two Queensland and three New South Wales schools respectively. In the results, the interview cohorts are indicated by Cohort number (C2 or C3) and year level (Qld) or grade level (NSW). Students were aged 10 years in the first year of their 3-year set of interviews.

Results and Discussion

The results are presented in two parts according to the research questions. Part 1 presents students' performance on GLIM over time. Part 2 reports on students' solutions and their difficulties with GLIM items from five languages excluding Connection languages.

1. *How do Students Perform on Graphic Languages over Time?*

An Analysis of Variance (ANOVA) (year by correct score) revealed statistically significant differences between the students performances on the GLIM test over a 3 year period [$F(2,1047) = 91.76, p < 0.001$] with students' performance increasing at a significant rate in each of the three years of the study (Table 2 provides means and standard deviations for total score correctness). Performance increases were statistically significant across all six languages in each of the three years of the study (see Lowrie & Diezmann, in press).

The second level of analysis distinguished participants' performance on mathematics and science items over a three-year period (Years 5 to 7) with means and standard deviations for the two content categories presented in Table 2. (Recall, some of the items in the GLIM test were science items because there were insufficient mathematics tasks in some graphic languages.) An ANOVA (year with content category) revealed a statistically significant difference between the performance of students across mathematics [$F(2,1047) = 86.71, p < 0.001$] and science [$F(2,1047) = 58.27, p < 0.001$] content categories. Subsequent post hoc analysis revealed statistically significant differences in the performance of students between Year 5 and Year 6 and Year 6 and Year 7 for both mathematics and science categories [at $p < 0.001$ for each of the six t -tests].

9 In mass testing results, Year levels are reported as for Queensland students. Year levels for New South Wales students of an equivalent age are one year earlier (i.e., Year 7 in Qld = Grade 6 in NSW). The use of the term "Grade" signifies a typical NSW age cohort rather than its QLD age equivalent.

Table 2

Means (and SD) for Test Correctness and Mathematics and Science across Three Years

Category	Year			F Value
	Year 5 (N=371)	Year 6 (N=352)	Year 7 (N=325)	F(2, 1047)
GLIM Total (N = 36)	21.74 (5.47)	25.02 (5.3)	27.06 (4.99)	91.76**
Mathematics (N = 25)	14.99 (3.72)	17.12 (3.75)	18.64 (3.52)	86.71**
Science (N = 11)	6.75 (2.25)	7.90 (2.08)	8.42 (1.97)	58.27**

Note: ** $p < 0.001$

A third level of analysis was restricted to the 25 mathematics items. This analysis was used to identify if there were any mathematics items on which student performance *did not* increase over time. Consequently, multiple ANOVAs (year with item) revealed statistically significant differences between performance on 22 of the 25 items [with a Bonferroni correction method set at $p = 0.002$, i.e., $0.05/25$]. Thus, for 22 of the mathematics items, performance increased across the three years. The means and standard deviations for the three insignificant items (Appendix, Items 1, 27, 35) are presented in Table 3. Item 1 was of limited concern because the ceiling effect precluded statistical improvement over time. However, there was substantial scope for improvement on Items 27 and 35 (in relation to mean scores) over the 3-year period. Items 1 and 27 are discussed further shortly.

Table 3

Means (and SD) for the Items, Which Did Not Result in Performance Increases Over Time

Item	Graphic language	Year 5	Year 6	Year 7	% increase	F(2,1051)
1	Axis	.88 (.33)	.89 (.31)	.93 (.26)	6	2.5
27	Retinal	.65 (.47)	.68 (.46)	.71 (.45)	9	1.3
35	Connection	.21 (.40)	.21 (.40)	.27 (.44)	3	2.1
Total	25 Maths Items	14.99 (3.72)	17.13 (3.75)	18.64 (3.52)	24	86.71**

Note: ** $p < 0.001$

2. How Do Students Solve Items from Particular Graphic Languages?

Apposed Position Item. Whilst in Year 6, Cohort 1 found the column graph item (Appendix, Item 20) to be relatively difficult ($\alpha = 0.66$). In interviews, 60% of Grade 5 students (C3) were successful in considering the information on the x and y axes simultaneously. Jane, for example, indicated that “Most are 9 or some are 10 or older. They are the two highest (9 + 10). I looked at this (points to x axis) and I knew that (the y axis) wasn’t the ages of children”. Unsuccessful students focused on the data as positioned on *either* the x or y axis rather than considering the relationship between these data and the axes (Lowrie & Diezmann, 2007). A high proportion of students (70% of the inappropriate solution strategies) focused on the y axis and selected a solution that corresponded with the highest point on the graph: “I put A because most children are 9 because it is the highest bar” (Terry). Elsewhere (Lowrie & Diezmann, 2007), we have argued that students’ incorrect responses can be derived from prior, and prototypical, tasks

that routinely required them to select the highest point on the graph without an additional requirement to interpret other data. As Roth (2002) suggested, when students are not required to read beyond simple components of the data, they tend to concentrate on perceptual features rather than attending to all elements in a holistic manner.

Map Item. By contrast to the other map items, Cohort 1's performance on Item 28 (Appendix) plateaued from Year 6 ($\eta^2 = 0.71$) to Year 7 ($\eta^2 = 0.75$). In interviews (C3, Grade 5), approximately 70% of the successful approaches involved students understanding the relationship between location and direction: "First I had a look at where the pool was [location] ... He drives North and takes the first right, which is Wattle Road. Then he takes the 2nd left, that's first, that's second, that's School Road [direction] (Larry)". Unsuccessful responses involved students overlooking the need to simultaneously attend to ordinal and positional information. On this item, unsuccessful students tended to either focus on the ordinal information (second left) or the directional information (left rather than right turn). Ellen's incorrect solution (Post Rd) was reached by "start[ing] at the pool, then (they) took (a) right turn (Wattle Rd) then (a) left turn and it's Post Rd". Ellen was able to carry out directional instructions but overlooked the requirement to take the *second* road on the left. Thus, she was not able to *interpret information* and distinguish between what information should and should not be included (Wiegand, 2006).

Axis Item. With the exception of a number line item (Appendix, Item 1), there was a significant improvement in Cohort 1's performance over time on Axis items (Table 3). Although the lack of improvement on Item 1 was due to a ceiling effect, it was evident that some students lacked knowledge of how information is encoded on a number line. In interviews, 91% of students (C2, Year 5) were successful on the number line item. The most common explanation (67.2%) for the selection of the correct response of D related to it being closest to the identified number: "I chose D because it's closest to 20 and C is too far away (Jo)." The six students who selected an incorrect response all used the same strategy of counting back: "I think it should go there (D) because it's next to 20 and it goes 19, 18 then 17" (Tracy). Thus, unsuccessful students treated the number line as a *counting model* in which all marks irrespective of spacing were one number apart. In contrast, successful students' explanations focused on distance and number implying that they conceptualised the number line as a *proportional* or *measurement* model.

Retinal List Item. Cohort 1 found the Retinal-List items to be the most difficult of the graphic language items to solve in Year 5. This is a concern because some of these items, such as the Flip (Appendix, Item 27), are typical tasks in national numeracy tests for Years 3 and 5 (e.g., Curriculum Corporation, 2009a, 2009b). In interviews, 56.7 % of students (C2, Year 5) successfully completed the Flip item. The majority of successful students (63.2%) used a *Symmetry* strategy in which they sought a pair of symmetrical shapes: "A flip is when you flip it over (moves one hand over) so it's kind of like symmetrical if you join them together (joins hands together) and if you join B together (pair of shapes) it would look symmetrical (Donna)". Over 20% of students used the *Deduce and Check* strategy (21.1%). These students reached a solution by visualising changes to the perceptual elements of each shape in turn and deducing the correct response by eliminating incorrect responses. These students exhibited functional rather than proficient knowledge of graphics because they employed a laborious strategy in lieu of the optimal strategy of identifying a symmetrical pair of shapes. The perceptual elements of the graphic and their relationship were not evident to all students with some unsuccessful students demonstrating a lack of knowledge about the spatial relationships between shapes (Del

Grande, 1990). Hannah, for example, eliminated the correct answer of B because the noses on the shapes pointed in opposite directions. Thus, on the Flip item, there was substantial variance in knowledge of graphics between the most and least capable students.

Miscellaneous Item. The pie chart is a Miscellaneous item of particular interest because only 71% of Year 8 students in the 2003 Trends in International Mathematics and Science Study (TIMSS) were successful on a pie chart showing crop distribution (National Center for Education Statistics, n.d.). Some insight into students' performance on pie charts is evident from interviews on Item 36 from GLIM (Appendix). On this item, 93% of students were successful (C2, ¹⁰n = 15, Year 7). However, as with the Flip item, there was a distinct difference between students who were proficient with graphics and those who were functional. Successful students predominantly used two strategies. The *Fraction* strategy (53.3%) focused on calculating the total amount of Jemma's budget from the known value of the clothes segment of \$30 and the area of this segment being a quarter of the circle. For example, Amy said "Clothes for a quarter of the circle then if you times that (\$30) by four because there are four quarters in the circle ... she would have had around (\$120." Thus, the Fraction strategy capitalised on the affordance of the encoding technique of a pie chart through the utilisation of angles and containment in solution. By contrast, the *Estimate Quantity and Add* strategy (20%) overlooked the proportional nature of the pie chart and involved an estimation of the cost of objects and a sum of their total cost. For example, Holly selected \$120 as her response: "I reckon she spent about (\$10 or no ... \$15 for that (food) ... Which is (\$35 if you add them together and then books would probably be about (\$50 (that's) (\$85 and um they (banking and games) would probably be about \$40". Although this strategy can lead to success, it is laborious and errors can occur at multiple points. The only unsuccessful student guessed the answer. An elaboration of the cohort's performance on this item is presented elsewhere (Diezmann & Lowrie, 2009b).

In sum, with consideration for students' performance and Alexander's (2003) MDL, there are three types of decoders based on their ability (a) to identify and utilise critical perceptual elements and (b) to exploit the encoding technique in a solution strategy. *Emergent decoders* are acclimating to the graphical domain and have limited knowledge. Thus, these students try to employ a solution that incorporates some critical perceptual elements. *Functional decoders* display some competence in the graphical domain in that their ability to interpret perceptual elements enables them to create a workable strategy. By contrast, *proficient decoders* have developed the expertise to exploit the encoding technique in the graphic to employ an optimal strategy.

'The Report Card' on Graphical Expertise

The investigation of students' decoding of graphics (i.e., KCS) informs *Knowledge of Content and Teaching*. Over time there was a significant improvement in students' performance on most graphic items but there were some items on which teachers needed to provide explicit support to students. Additionally, teachers needed to be able to identify students as *emergent*, *functional* or *proficient* decoders of graphics and to tailor support to students' expertise in decoding. Emergent decoders need opportunities to learn about the critical (and non critical) perceptual elements in various graphics. Functional decoders need opportunities to compare solution strategies and identify the optimal strategy

10 Participants were from one intact class in one of the two C2 schools.

according to the encoding technique of a particular graphic. Proficient decoders need opportunities to apply their graphic knowledge and create new strategies for solving tasks.

Acknowledgements.

This project was funded by the Australian Research Council (#DP0453366). Special thanks to Tracy Logan, Lindy Sugars and Kim Woodland for their assistance with this project and with this paper.

References

- Alexander, P. A. (2003). The development of expertise: The journey from acclimation to proficiency. *Educational Researcher*, 32(8), 10-14.
- Cleveland, W. S., & McGill, R. (1984). Graphical perception: Theory, experimentation, and application to the development of graphical methods. *Journal of the American Statistical Assoc.*, 79(387), 531–554.
- Curriculum Corporation (2009a). *National Assessment Program Literacy and Numeracy: Numeracy Year 3 2009*. Retrieved 21 March 21 2010, from http://www.naplan.edu.au/verve/_resources/NAP09_Numeracy_Y3.pdf
- Curriculum Corporation (2009b). *National Assessment Program Literacy and Numeracy: Numeracy Year 5 2009*. Retrieved 21 March 2010 from http://www.naplan.edu.au/verve/_resources/NAP09_Numeracy_Y3.pdf
- Del Grande, J. (1990). Spatial sense. *Arithmetic Teacher*, 37(6), 14–20.
- Diezmann, C. M., & Lowrie, T. (2009a). An instrument for assessing primary students' knowledge of information graphics in mathematics. *Assessment in Education: Principles, Policy and Practice*. 16(2), 131-147.
- Diezmann, C. M., & Lowrie, T. (2009b). The role of fluency in a mathematics item with an embedded graphic: Interpreting a pie chart. *ZDM: The International Journal on Mathematics Education*, 41(5), 651-662.
- Educational Testing Centre (2002). *Year 4 Primary Schools Mathematics Competition*. Educational Assessment Australia, The University of New South Wales, Sydney, Australia.
- Harris, R. L. (1996). *Information graphics: A comprehensive illustrated reference*. Atlanta, GA: Management Graphics.
- Hill, H., Ball, D. L., & Schilling, S. (2008). Unpacking “pedagogical content knowledge”: Conceptualizing and measuring teachers' topic-specific knowledge of students. *Journal for Research in Mathematics Education*, 39(4), 372–400.
- Lowrie, T. & Diezmann, C. M. (2007). Middle school students' interpretation of graphing tasks: Difficulties within a graphical language. In C. S. Lim, S. Fatimah, G. Munirah, S. Hajar, M. Y. Hashimah, W. L. Gan & T. Y. Hwa (Eds.), *Proceedings of the 4th East Asia regional conference on Mathematics Education* (pp. 430-436). Penang: Universiti Sains Malaysia.
- Lowrie, T., & Diezmann, C. M. (in press). Solving graphics tasks: Gender differences in middle-school students. *Learning and Instruction*. Retrieved 24 May 2010 from doi:10.1016/j.learninstruc.2009.11.005
- Mackinlay, J. (1999). Automating the design of graphical presentations of relational information. In S. K. Card, J. D. Mackinlay, & B. Schneiderman (Eds.), *Readings in information visualization: Using vision to think* (pp. 66-81). San Francisco, CA: Morgan Kaufmann.
- National Center for Education Statistics. (n.d.). *TIMSS 2003 8th-Grade mathematics concepts and mathematics items*. Retrieved 21 March 2010 from http://nces.ed.gov/timss/pdf/TIMSS8_Math_ConceptsItems_3.pdf
- National Center for Educational Statistics, (1992). *National Assessment of Educational Progress (NAEP), 1992, Year 4 Mathematics*. Retrieved 9 September 2004, from <http://nces.ed.gov/nationsreportcard/itmrlsx/s508/Detail.aspx?itemBlockId=1992-4M7:3>
- Queensland School Curriculum Council (2000). *2000 Qld 3 Test: Aspects of Numeracy*. Brisbane: Author.
- Queensland School Curriculum Council (2001). *2001 Qld 3 Test: Aspects of Numeracy*. Brisbane: Author.
- Queensland Studies Authority (2002a). *2002 Qld Year 5 Test: Aspects of Numeracy*. Brisbane: Author.
- Queensland Studies Authority (2002b). *2002 Qld Year 7 Test: Aspects of Numeracy*. Brisbane: Author.
- Roth, W.-M. (2002) Reading graphs: Contributions to an integrative concept of literacy. *Journal of Curriculum Studies*, 34(2), 1-24.
- Wiegand, P. (2006). *Learning and teaching with maps*. New York: Routledge.

Appendix

Estimate where you think 17 should go on this number line.

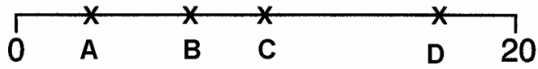

Answer

A
 B
 C
 D

Item 1: *Axis-Number Line* (QSCC, 2000, p. 11)

Which two faces show a flip?

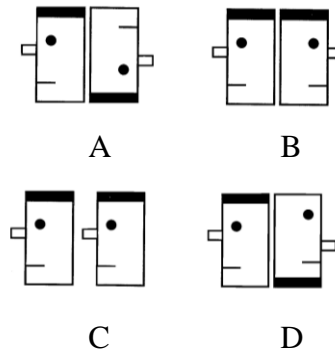

Answer

A
 B
 C
 D

Item 27: *Retinal List – Flip* (QSCC, 2001, p. 13)

The graph above shows how many of the 32 children in Mr Rivera’s class are 8, 9, 10 and 11 years old. Which of the following is true?

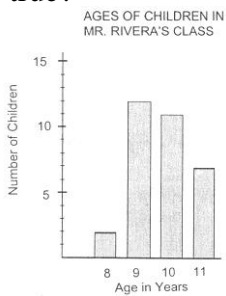

Answer

Most are younger than 9
 Most are younger than 10
 Most are 9 or older
 None of the above is true

Item 20: *Apposed Position-Column Graph* (NCES, 1992, Q 229)

In 2004, Jemma budgeted \$30 on clothes. Approximately how much money did she get that year?

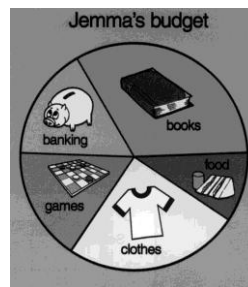

Answer

\$90
 \$120
 \$150
 \$180

Item 36: *Miscellaneous-Pie Chart* (QSA, 2002b, p. 6 & p. 1 of insert)

Bill leaves the pool. He drives north and takes the first road on the right, then the second road on the left. Which road is he in?

Answer

School
 Post
 Beef
 Jones

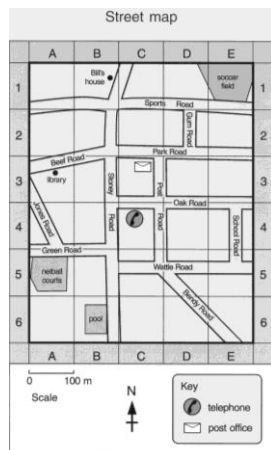

Item 28: *Map-Street Map* (QSA, 2002a, p. 7 & p. 3 of insert)

Two children are playing a board Game. They toss a standard dice and move forward the number of spaces to match the number on the dice. What is the least number of tosses of the dice needed to reach HOME?

Answer

5
 4
 3
 2

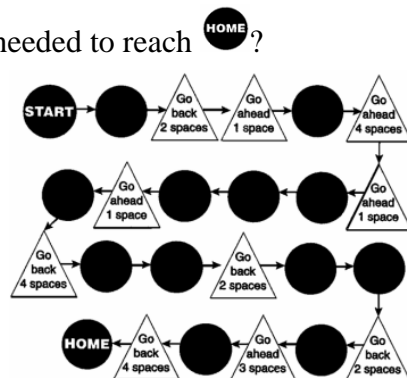

Item 35: *Connection: Game* (ETC, 2002, p. 9)

Challenging Multiplicative Problems Can Elicit Sophisticated Strategies

Ann Downton
Australian Catholic University
ann.downton@acu.edu.au

This paper reports on 13 Grade 3 students' approaches to *Equivalent groups* and *Times as many* multiplicative word problems. The findings are part of a larger study relating to children's development of multiplicative thinking. Of particular interest was the extent to which task level of difficulty influenced students' strategy choice. The results suggest a relationship between the level of difficulty and strategy choice: the more difficult the task the more sophisticated strategy choice.

One of the dilemmas teachers face when introducing operations to children relates to types and complexity of problems they pose. Textbooks often present tasks progressing from simple to complex, and likewise concepts are presented from simple to complex. This paper presents evidence to suggest that some students use more sophisticated strategies when presented with challenging problems, involving numbers considered beyond the factor structure determined by the curriculum for that particular grade. Conversely, easier problems prompt some students to use a less sophisticated strategy.

Research Framework

Many authors have argued that multiplication is conceptually complex both in terms of the range of semantic structures (Anghileri, 1989; Greer, 1992; Kouba, 1989) and conceptual understanding (Clarke & Kamii, 1966; Steffe, 1994). Clarke and Kamii (1996) concurred with Steffe (1994) that understanding multiplication requires a higher level of abstraction than addition and greater demands on children as described by Steffe:

For a situation to be established as multiplicative, it is necessary at least to co-ordinate two composite units in such a way that one of the composite units is distributed over the elements of the other composite unit (1994, p. 19).

Research has indicated that children as young as pre-school can solve a variety of multiplication problems by combining direct modelling with counting and grouping skills, and with strategies based on addition (e.g., Anghileri, 1989; Carpenter, Ansell, Franke, Fennema, & Weisbeck, 1993; Clark & Kamii, 1996; Kouba, 1989; Mulligan & Mitchelmore, 1997). Number triples within most of these studies were limited to small numbers such as (3, 4, 12), (3, 5, 15), (3, 6, 18), (3, 8, 24), (4, 5, 20), (4, 6, 24), and (5, 6, 30) from Kouba's (1989) study of Grade 1 to Grade 3 students. These studies identified the stages children move through in their transition from additive to multiplicative thinking. Some studies (Anghileri, 1989; Kouba, 1989; Mulligan & Mitchelmore, 1996, 1997) classified the strategies as either modelling (using physical objects, fingers, or drawings) or calculation (e.g., unitary counting, to skip counting, to additive strategies based on repeated addition to multiplicative strategies, such as known and derived multiplicative facts).

In their study of Grade 2 and 3 students Mulligan and Mitchelmore (1997) found that young children acquire a sequence of increasingly efficient intuitive models (defined as "an internal mental structure corresponding to a class of calculation strategies" p. 325)



derived from the previous one. However, the intuitive models student employed to solve a particular problem was determined by the mathematical structure they imposed on it, rather than the mathematics inherent in the problem.

Research on Grades 4 to 6 students' solution strategies to whole number multiplication word problems involving more complex number triples, such as (5, 8, 40), (5, 19, 95), (13, 7, 91), (23, 4, 92) (Ell, Irwin, & McNaughton, 2004; Heirdsfield, Cooper, Mulligan, & Irons, 1999) found that although students' strategies progressed through a range of calculation strategies similar to those previously described, they did not necessarily consistently employ the more sophisticated strategies. In fact, Heirdsfield et al. (1999) indicated that the number triples and strategies available to the students influenced their strategy choice for solving word problems. Both studies (Ell et al., 2004; Heirdsfield et al., 1999) suggested the instructional effect and formal algorithm influenced students' strategy use.

Mulligan and Mitchelmore (1997) also found that the intuitive models children employed were influenced by the characteristics of the problem such as the size of the numbers, the multiples involved, or the extraneous verbal cues. As a consequence most students were not consistent with the intuitive models they used across the different problems. For example, many students who used repeated addition for problems involving small number triples seemed to experience a "processing overload" (p. 322) when attempted to use the same strategy for larger number triples. Conversely, some students who used a multiplicative operation for a problem involving small number triples were often unable to retrieve the number fact required for problems involving larger number triples and reverted back to repeated addition.

Three commonalities are evident from the literature presented relating to students' solution strategies to whole number multiplicative word problems. First, students' intuitive strategies progress according to their level of sophistication in the transition from additive to multiplicative thinking. Second, having mastered a more sophisticated strategy one cannot assume a student will employ it. Third, a range of factors such as the size of the numbers, multiples and instructional effect influences strategy use.

The purpose of the study underpinning the findings reported here, was to explore Grade 3 students' strategy choice across a range of multiplicative word problems, that involved numbers considered outside the factor structure stipulated by the curriculum. The study was informed by the work of Ell et al. (2004) and Heirdsfield et al. (1999), relating to Grades 4 to 6 students' approaches to two-digit by one-digit whole number multiplication word problems and extends the work of Mulligan and Mitchelmore (1999) who posed the conjecture "that students first learn a new strategy to solve problems where the situation is familiar and the relevant number facts are well known" (p. 327).

The questions guiding this study were: Are there students who use more sophisticated strategies, than they currently do, if the number triples are more complex? Are there students who use less sophisticated, than they currently do, if the number triples are simpler? In other words, is there a relationship between students' strategy choice and the factor structure of the problem?

Methodology

This paper draws on one of the findings of a larger study, conducted from March to November 2007, of young children's development of multiplicative thinking. The study involved Grade 3 students (aged eight and nine years) in a primary school located in a middle class suburb of Melbourne. Thirteen students, representing a cross section of the

class, were selected according to their mathematical achievement. A one-to-one, task-based interview was administered to the students to gain insights into and probe their understanding of and approaches to multiplicative problems. The findings of a subset of these results are reported in this paper.

Instruments

The author developed a one-to-one, task-based interview on multiplication, consisting of three problems for each semantic structure identified by Anghileri (1989) and Greer (1992): equivalent groups and times as many. For each problem there were three levels of difficulty, rated as easy (E), medium (M) or challenge (C) from pilot testing. Number triples, considered outside the factor structure stipulated by the curriculum at this level, such as (7, 8, 56), (13, 8, 104), (8, 14, 112), (18, 4, 72), (8, 16, 128), were chosen for the challenge level of difficulty for two reasons. First, to gauge whether students attended to the structure of the problem or merely manipulated the numbers, as indicated by Mulligan and Mitchelmore (1997). Second, to identify whether students at this level are capable of solving problems involving harder number triples than commonly asked at this level, and do so using more sophisticated strategies. Visual cues were used in M1 (task 1, medium level of difficulty) as a context, M3 and C3 (task 3, challenge level of difficulty) to gauge whether students could replicate a collection, and M4 to provide students with a sense of the meaning of the times as many structure.

Interview Approach

Each interview was audio taped and took approximately 30 to 45 minutes, depending on the complexity of the student's explanations. Responses were recorded and any written responses retained. The problems were presented orally, and paper and pencils were available for students to use at any time. Generous wait time was allowed and the researcher asked the students to explain their thinking and if they thought they could work the problem out a quicker way. Students had the option of choosing the level of difficulty to allow them to have some control and feel at ease during the interview. If a student chose a challenge problem and found it too difficult, there was an option to choose an easier problem.

Method of Analysis

Initially, the researcher coded the students' responses as correct, incorrect, or non-attempt as well as coding the level of abstractness of solution strategies, informed by earlier studies (Heirdsfield et al., 1999; Kouba, 1989; Mulligan, 1992; Mulligan & Mitchelmore, 1997). For the purpose of this paper, the term abstraction refers to a student's ability to solve a problem mentally without the use of any physical objects (including fingers), drawings or tally marks. Where a student solved two problems for the one task (easy and medium), only the code for the more sophisticated strategy was recorded. The strategies chosen by the students presented in this paper are listed and defined in Table 1 according to the level of abstraction. Transitional counting is the only strategy listed that includes some form of representation; the other strategies indicate the students are abstracting. Students whose preferred strategy was multiplicative calculation or wholistic thinking were considered to be using multiplicative thinking rather than additive thinking.

Table 1
Solution Strategies for Whole Number Multiplication Problems

Strategy	Definition
Transitional Counting	Visualises the groups and can record or verbalise the multiplication fact but calculates the answer to the problem using a counting sequence based on multiples of a factor in the problem. May use drawing or use of fingers or tally marks to keep track of the count. For example, “I counted by 6s four times using my fingers to help 6, 12, 18, 24”, and recorded $4 \times 6 = 24$.
Building Up (counting by multiples)	Visualises the groups and the multiplication fact but relies on skip counting, or a combination of skip counting and doubling to calculate an answer. For example, “I know 4 sixes are 24 (skip counted by 6) and I need eights so I can double 24 and that’s 48”, and recorded $8 \times 6 = 48$.
Doubling and Halving	Derives solution using doubling or halving and estimation, attending to both the multiplier and multiplicand. For example, “4 times as many as 18. Double 18 is 2 times, double 36 is 4 times, so that’s 72 stamps”. This student doubled the multiplicand.
Multiplicative Calculation	Automatically recalls known multiplication facts, or derives easily known multiplication facts. For example, “I know 8 times 12 is 96 so I just added another 8 to get 104, and that’s 13 eights.”
Wholistic Thinking	Treats the numbers as wholes—partitions numbers using distributive property, chunking, and / or use of estimation. For example, one student rounded the number to nearest ten and then subtracted (compensation strategy) “I know 15 times 6 is 90 and then I took away 12, to get 13 times 6 and that’s 78 $15 \times 6 = 90 - 12 = 78$ ”, another used distributive property, “If it was 8 boxes of 14 I know 8 times 10 and 8 times 4 so 80 and 32 is 112 ($8 \times 14 = 112$, $8 \times 10 + 8 \times 4 = 112$).”

The examples accompanying each definition in Table 1 provide a guide to the classification of the students’ solution strategies.

Results and Discussion

The strategy choices of the 13 students on the six tasks are presented in two different tables. The first table (Table 2) provides the frequencies of strategies used by the students to solve the multiplication word problems pertaining to equivalent groups and times as many semantic structures. The main discussion of the results focuses on Table 3, which provides the strategy choice and task level of difficulty of each student. This closer look at the students’ strategies provides evidence to support the argument that when challenged, students are capable of using sophisticated strategies.

The easy tasks were not included in Table 2 as no students chose them. For each task, students chose either medium (M), challenge (C) or in the case of equivalent groups extra challenge (ExC), so M1 in Table 2 refers to task 1 medium level of difficulty. The equations are included to indicate the number range used across the levels of difficulty.

The black vertical line distinguishes the use of abstracting strategies (to the right of the line), from those of some form of representation (fingers, recording), on the left. Students

who consistently chose multiplicative calculation and or wholistic thinking were considered to be using multiplicative rather than additive thinking. The codes used in the table pertain to the strategies: Transitional counting (TC), Building up (BU), Doubling or halving (DH), Multiplicative calculation (MC), Wholistic thinking (WT). An asterisk indicates the use of visual cues, by the researcher when presenting the task.

Table 2
Frequency of Strategy Choice for Equivalent Groups and Times as Many Tasks (n=13)

Semantic structure	Task No /Diff	Equations	TC	BU	DH	MC	WT
Equivalent groups	*M1	$6 \times 3 = 18$		3			
	C1	$7 \times 8 = 56$		6		1	
	ExC1	$13 \times 8 = 104$				2	1
	M 2	$6 \times 4 = 24$		3			
	C 2	$8 \times 6 = 48$		2		2	
	ExC2	$8 \times 14 = 112$				3	3
	*M3	$5 \times 4 = 20$			1		
	*C3	$6 \times 7 = 42$			5	6	1
	Total strategy choice			20		14	5
Times as many	*M4	$3 \times 6 = 18$	1	2			
	C4	$4 \times 18 = 72$		1	1		8
	M5	$4 \times 6 = 24$	1	4			
	C5	$16 \times 8 = 128$			1		7
	M6	$6 \times \$4 = \24.00	1	4		4	
	C6	$4 \times \$3.50 = \14.00				2	2
		Total strategy choice		3	11	2	6

From Table 2, it can be seen that multiplicative calculation (MC) and wholistic thinking (WT) were the preferred strategies of those who chose the challenge or extra challenge level of difficulty, with the exception of C1, in which building up (BU) was the preferred strategy. It may be argued that these are the more capable students and one would expect them to use multiplicative strategies. An alternative view is that enabling students to engage with number triples beyond what is commonly posed at this level prompts the use of more sophisticated solution strategies. Given students' familiarity with the equivalent groups semantic structure it was expected that multiplicative strategies would be the most frequently chosen strategy for C1.

In contrast, building up (BU) was the preferred strategy by those who chose the medium level of difficulty. It appears that the use of visual cues and the more familiar number triples influenced their strategy choice. One might infer from this that problems involving numbers within students' experiences prompt the use of simpler strategies.

In order to gain a deeper sense of the meaning of these findings, the strategies of individual students are presented in Table 3. The dots indicate task level of difficulty (one dot-medium level; two dots-challenge level and three dots extra challenge level of difficulty) and shading the strategy choice as follows:

TC	BU	DH	MC	WT
----	----	----	----	----

In Table 3 the students are listed according to the frequency of sophisticated strategies and level of task difficulty chosen. For example, Sandy (listed first) consistently chose WT whereas Judy chose MC for four tasks and WT for two tasks. Sandy chose two extra challenge tasks (three dots) and four challenge tasks (two dots) whereas Judy chose one medium task (one dot). Gayle listed last, chose BU for each of the equivalent group tasks for both medium and challenge tasks and TC for the times as many medium tasks.

*Table 3
Strategy Choice and Level of Difficulty by Each Student Across the Six Tasks*

Students	Equivalent Groups			Times as Many		
	1	2	3	4	5	6
Sandy	●●●	●●●	●●	●●	●●	●●
Judy	●●●	●●●	●●	●●	●●	●
Jules	●●	●●●	●●	●●	●●	●
Annie	●●	●●●	●●	●●	●●	●
Mark	●●	●●●	●●	●●	●●	●
Sharne	●●	●●	●●	●●	●●	●●
Nigel	●●	●●●	●●	●●	●●	●
Bindy	●●	●●	●●	●●	●●	●
Danny	●●	●●	●●	●	●	●
Marty	●	●	●●	●●	●	●
Lewis	●	●	●●	●●	●	●
Lyle	●●	●●	●	●	●	●
Gayle	●	●	●●	●	●	●

From Table 3 a clear division is evident between Bindy and Danny in relation to strategy choice and level of difficulty chosen. It is evident that BU is the preferred strategy of Danny, Marty, Lewis and Lyle regardless of level of difficulty chosen, whereas MC or WT were the preferred strategy of Bindy and those above in the table, who mainly chose challenge or extra challenge level of difficulty. An exception was task six, which related to money. All except Lyle and Gayle chose the challenge level of difficulty but some found it too challenging and so asked for the medium problem.

The students of particular interest, in relation to the research questions, are Jules, Annie, Mark, Sharne and Nigel who were identified as “middle group” when the thirteen students were chosen. These students generally chose challenge or extra challenge questions and consistently chose MC or WT for tasks involving harder number triples such as (16, 8, 128) but less sophisticated strategies on problems involving simpler numbers or those with which they were familiar (e.g., multiples of 6 related to their knowledge of Australian rules football), as was evident in challenge task 1 (2 dots). One might infer from this that students who use a binary operation for multiplication have the flexibility of choosing a less sophisticated strategy for easier problems.

Further evidence of this relates to the use of MC or WT by Jules, Sharne and Mark to solve task 5, challenge level of difficulty: “The Phoenix scored 8 goals in a netball match. The Kestrals scored 16 times as many goals. How many goals did the Kestrals score?” The following are abridged excerpts of their solution strategies.

Jules: That’s 16 times 8. It’s 128. I started with 10 times 8 and that equals 80, then 6 times 8 is 48 then added them to get 128. 80 and 40 is 120 and 8 is 128.

Sharne: I can halve 16 to get 8. I know 8 eights are 64 and another 8 eights is 128, because 8 times 8 and 8 times 8 is the same as 16 times 8.

Mark: I know 12 eights are 96 and 4 eights are 32, then I just need to add 32 and 96.

Jules partitioned the 16 into ten and six using his place value knowledge and operated on each separately, using the distributive property. Both Sharne and Mark split the 16 into known facts to use as a starting point. Sharne halved the multiplier and operated on each separately, whereas as Mark split the problem up into 12×8 and 4×8 . These examples indicate the students’ ability to partition number and use the distributive property in order to solve problems mentally.

The number triples of the challenge and extra challenge tasks are similar to those used in studies for students in Grades 4 to 6 (Ell et al., 2004; Heirdsfield et al., 1999) and the evidence presented in this paper indicates that some Grade 3 are capable of solving problems relating to the different semantic structures involving numbers beyond what is expected at this year level and do so using sophisticated strategies.

One unexpected result was the use of WT by Marty and Lewis, two of the lower performing students for task 4, challenge level of difficulty: “Jamie collected 18 stamps. Jack collected 4 times as many. How many stamps does Jack have?” The following are abridged excerpts of their solution strategies.

Marty: Ten, 4 times is 40 and eight 4 times is um 32. 40 and 32 is 72.

Lewis: Four times as many as 18? 20, oh umm, so 4 times? 80, take away umm 8, is umm 72. I took away 10 first and added 2 onto 70, cause it’s easier.

Marty partitioned the 18 into ten and eight and operating on each separately, showing an understanding of distributive property; whereas Lewis rounded the 18 to 20, a number that he could calculate mentally and then compensated by subtracting eight. These responses indicate their ability to use multiplicative rather than additive thinking when presented with a task involving number triples outside the factor structure stipulated by the curriculum at this level.

These findings are in contrast to the conjecture that “students first learn a new strategy to solve problems where the situation is familiar and the relevant number facts are well known” (Mulligan & Mitchelmore, 1997, p. 327).

Conclusion

The findings of this study suggest that students at Grade 3, when challenged, are capable of engaging with problems at higher level of thinking, than would otherwise be the case. Second, students who used wholistic thinking were flexible in their thinking and realised that numbers could be split in a variety of ways. From these findings it is reasonable to infer there is a relationship between strategy choice and number triples: the more difficult the number triples, the more sophisticated the strategy choice; the easier the number triples, the less sophisticated the strategy choice. This is a key finding in that it is

the reverse direction to what one would anticipate, as indicated by the literature, or that seems to be implied by most curriculum resources or texts.

A recommendation for teachers is to pose problems some of the time that extend children's thinking beyond what appears to be commonly the case. By doing so, teachers may gain insights into strategies, which students are capable of but have not demonstrated on simpler problems.

While acknowledging these results are different to those of earlier research, the author is aware there are possibly other explanations for these findings such as students' level of confidence, or their willingness to take a risk, and is sufficiently circumspect about these conclusions. These provide opportunities for further research in this area.

References

- Anghileri, J. (1989). An investigation of young children's understanding of multiplication. *Educational Studies in Mathematics*, 20, 367-385.
- Carpenter, T. P., Ansell, E., Franke, K. L., Fennema, E., & Weisbeck, L. (1993). Models of problem solving: A study of kindergarten children's problem solving processes. *Journal for Research in Mathematics Education*, 24(5), 428-441.
- Clark, F. B., & Kamii, C. (1996). Identification of multiplicative thinking in children in grades 1 - 5. *Journal for Research in Mathematics Education*, 27(1), 41-51.
- Ell, F., Irwin, K., & McNaughton, S. (2004). Two pathways to multiplicative thinking. In I. Putt, R. Faragher & M. McLean (Eds.), *Mathematics education for the third Millennium, towards 2010* (Proceedings of the 27th annual conference of the Mathematics Education Research Group of Australasia, Townsville pp. 199-206). Sydney: MERGA.
- Greer, B. (1992). Multiplication and division as models of situations. In D. A. Grouws (Ed.), *Handbook of research on mathematics teaching and learning* (pp. 276-295). NY: Macmillan.
- Heirdsfield, A. M., Cooper, T. J., Mulligan, J., & Irons, C.J. (1999). Children's mental multiplication and division strategies. In O. Zaslavsky (Ed.), *Proceedings of the 23rd Psychology of Mathematics Education Conference* (Vol.3, pp. 89-96). Haifa, Israel:PME.
- Kouba, V. L. (1989). Children's solution strategies for equivalent set multiplication and division word problems. *Journal for Research in Mathematics Education*, 20(2), 147-158.
- Mulligan, J. (1992). Children's solutions to partition problems. In B. Southwell, R. Perry, & K. Owens (Eds.), *Proceedings of the 15th Annual Conference of the Mathematics Education Research Group of Australasia* (pp. 410- 420). Sydney: MERGA.
- Mulligan, J., & Mitchelmore, M. (1996). Children's representations of multiplication and division word problems. In J. Mulligan & M. Mitchelmore (Eds.), *Children's number learning* (pp. 163-184). Adelaide, Australia: The Australian Association of Mathematics Teachers Inc.
- Mulligan, J., & Mitchelmore, M. (1997). Young children's intuitive models of multiplication and division. *Journal for Research in Mathematics Education*, 28(3), 309-330.
- Steffe, L. P. (1994). Children's multiplying schemes. In G. Harel & J. Confrey (Eds.), *The development of multiplicative reasoning in the learning of mathematics* (pp. 3-40). Albany, NY: State university of New York Press.

The Impact of Two Teachers' Use of Specific Scaffolding Practices on Low-attaining Upper Primary Students

Sarah Ferguson

Australian Catholic University
<sarahferguson@exemail.com.au>

Andrea McDonough

Australian Catholic University
<andrea.mcdonough@acu.edu.au>

This paper reports on two upper primary teachers' use of particular scaffolding practices, individual discussion and the use of manipulatives. The cognitive and affective impact on four low-attaining students in these classes is described. The teachers and students were observed during eight to ten sequential tasks. "Scaffolding conversations" emerged as a common practice for these teachers whilst the use of manipulatives represented a point of difference.

One of the greatest challenges faced by education systems, schools and teachers is supporting students who are low attaining in mathematics. Part of this challenge is that teachers are called on to teach conceptually challenging mathematics to all students, both as a matter of equity and in recognition that conceptual understanding is essential for students to become "proficient and sustained learners and users of mathematics" (Numeracy Review Panel, 2008, p. 62). However, in order to teach using cognitively challenging tasks, teachers need a form of assistance that allows such challenge to remain whilst providing support for low-attaining students. Anghileri (2006) suggested that scaffolding was appropriate for this kind of "constructivist paradigm for learning" (p. 33).

Scaffolding (Wood, Bruner, & Ross, 1976) first emerged as a metaphor to describe a particular type of assistance used to support student learning. Rosenshine and Meister (1992) defined scaffolding as

... forms of support provided by the teacher or another student to help students bridge the gap between their current abilities and the intended goal ... Instead of providing explicit steps, one supports, or scaffolds, the student as they learn the skill. The support that scaffolds provide is both temporary and adjustable. (p. 26)

Scaffolding can take various forms from a "transmissive" style from teacher to student in a "predetermined sequence" to a more fluid exchange in which both student and teacher participate in a "mutual appropriation ... of each other's actions and goals" (Goos, 2004, p. 263). This paper reflects this latter definition.

The case study from which data have been selected for this paper centred around the question, "How does a teachers' use of particular scaffolding practices, while using specific mathematics tasks, impact on low-attaining students cognitively and affectively?" For this paper, two aspects of scaffolding will be discussed: one-to-one discussions between the teacher and students and the teachers' use of manipulatives.

Anghileri (2006) offered a three-tiered hierarchy of scaffolding levels that culminated in conceptual discourse. Anghileri described this third level of scaffolding as "teaching interactions that explicitly address developing conceptual thinking by creating opportunities to reveal understandings to pupils and teachers together" (p. 47). Conceptual discourse focuses on making connections between different ideas in mathematics and on "the communal act of making mathematical meanings" (p. 49). Cheeseman (2009) described such interactions between a highly effective teacher and one young child. These conversations were quite intense, allowing the teacher to gain important insights into that student's understanding and allowing the student to ask questions or make conjectures.



These moments offered rich opportunities for the teacher to scaffold that particular student's understanding through careful questioning, specific explanations, or by making links to situations, representations, or manipulatives that resonated with that student. McCosker and Diezmann (2009) warned that not all conversations between the teacher and a student could be considered scaffolding. This study gave examples of the teacher offering encouragement but asserted that scaffolding differed in that it involved the teacher demonstrating "an awareness of and responsiveness to the students' thinking" (p. 33) and encouragement for "creative and divergent thinking" (p. 27).

The use of manipulatives is often advised as a way of scaffolding learning in mathematics. Within the literature there are many definitions of the term 'manipulatives'. For this study, we drew upon Goldin and Sheteingold's (2001) description of external systems of representation. We also recognise the differences in how manipulatives can be interpreted, as discussed by Boulton-Lewis (1992), in that "some of these are concrete embodiments of mathematical concepts and processes and others are representations inherent in the discipline of mathematics" (p. 1).

Studies have shown that using manipulative materials was successful for developing students' understanding of concepts such as area (Cass, Cates, & Smith, 2003) and fractions (Butler, Miller, Crehan, Babbitt, & Pierce, 2003). Other studies warned that the use of concrete materials could confuse children further if they did not have the mathematical understanding to connect the materials to the relevant concept of skills (Ball, 1992). Ambrose (2002) found that some students, in particular girls, can become "stuck" on using materials instead of developing more sophisticated strategies. Boulton-Lewis and Halford (1992) suggested that some use of representations increased the cognitive load of students, thus inhibiting progress. Sowell (1989) suggested that a key to the successful use of concrete materials was long-term use of the materials and the teachers' knowledge about using the materials. Stacey, Helme, Archer, and Condon (2001) also suggested that the transparency of the materials to illustrate clearly the intended mathematical concept was critical to their successful use.

The literature discussed above suggests that scaffolding conversations have the potential to support students in their mathematics learning but that there are differing findings on value of the use of manipulative materials. The impact each of these strategies might have on low attaining learners of mathematics has not been widely explored in the literature but formed the focus of the wider case study and this paper.

Method

This paper draws on data collected during a case study investigating scaffolding practices of two upper primary teachers and the impact on two low-attaining students in each of these classes. As stated earlier, two aspects of scaffolding are discussed in this paper: one-to-one discussions between the teacher and students and the teachers' use of manipulatives

Participants

The first teacher, Ms B, had five years of teaching experience, with two years experience in teaching Year 5. Two students in Ms B's Year 5 class, Carl and David, were targeted for data collection. Both were operating about 12 to 18 months below expected levels in mathematics according to the *Victorian Essential Learning Standards* (Victorian Curriculum and Assessment Authority, 2006).

The second teacher in this study, Ms L, had eleven years teaching experience. The two target students from Ms L's class were Sophie, a Year 5 girl, and Riley, a Year 5 boy, both operating at about 12 months below expected levels in mathematics according to the *Victorian Essential Learning Standards* (Victorian Curriculum and Assessment Authority, 2006).

Data Collection and Analysis

Though a number of data collection procedures were employed in the research, only some of these are drawn on for this paper. For the teachers, these include a researcher-developed Tasks Questionnaire; a drawing task titled, "a time I taught mathematics well", adapted from the Pupil Perceptions of Effective Learning Environments in Mathematics (PPELEM) procedure (McDonough, 2002); and interviews with the teachers before and after observed lessons. Each lesson was audio-recorded with the teachers wearing a mobile recording device. Data on the target students were gathered via lesson observations and an interview after each lesson. There were two parts to these interviews. Firstly the interview focussed on the students' feelings about the tasks and their teachers' actions. Secondly a short assessment piece was given that aimed to assess understanding of the concept of major focus within the lesson. During the lesson, interactions between the students and their teacher were audio taped. In this way data regarding possible cognitive development and affective factors were collected. Lesson observations occurred over eight to ten sequential mathematics tasks in each class. In Ms B's classroom, all the observed tasks focussed on concepts of decimals, fractions and percent whereas in Ms L's classroom, the tasks focussed on multi-digit multiplication.

Interviews and lessons were transcribed and detailed lesson observation notes written for each observed lesson. These data were analysed using the *NVivo* program (QSR International, 2005). Data from a variety of sources, including the questionnaire and drawing tasks, built up a "rich, thick description" (Merriam, 1998, p. 38) of the teachers' and target students' experiences of their mathematics classrooms. We then "searched for patterns" (Stake, 1995, p. 44), seeking common themes but also recognising instances that differed from such themes in an effort to "come to know the case well" (Stake, 1995, p. 8).

Results and Discussion

This paper will focus on a point of similarity between the two teachers, that is, scaffolding conversations, and a point of difference, which was the teachers' use of manipulatives. The impact of these practices on the target low-attaining students in each class will also be described.

Scaffolding Conversations

Both Ms B and Ms L used conversations with the target students to attempt to scaffold their understandings. The use of these scaffolding conversations emerged as important moments for the students both cognitively and affectively. Drawing on the work of the studies described above, we have defined particular conversations between the teachers and the target students as *scaffolding conversations*. Scaffolding conversations are those interactions that took place between the teacher and individual students where the focus was mathematics as opposed to organisational or behavioural issues, where the teacher showed an awareness and responsiveness to the students' thinking (McCosker &

Diezmann, 2009) and where the teacher appeared to facilitate the development of understanding of mathematical concepts (Anghileri, 2006).

Ms B and Ms L habitually walked around their classrooms during mathematics tasks talking to students individually or in pairs while they worked on the tasks. These interactions often began by the teacher asking a question such as, “How did you get that answer?” or “What are you going to do next?” A scaffolding conversation with particular students usually occurred in ‘chunks’ over the course of a lesson with the teacher coming and going then resuming the next part of the conversation, a process also described by Cheeseman (2009) as *interlinked conversation strings*.

An example of a scaffolding conversation from Ms B’s classroom occurred with David during a lesson on fractions that used Cuisenaire rods. The first part of the conversation centred on Ms B scaffolding the concept that the number of parts in one whole names the fraction, in that case, two parts is halves. Ms B returned later to continue this conversation:

Ms B: So how do you know it’s a quarter?

David began to use the red rods and placed them beside the brown rod.

Ms B: What are you checking to see?

David: What it is. I’m kind of measuring it. (*He was moving small red rods along the longer rod.*)

Ms B: Yeah and what are you checking to see with those red ones?

David: See if it’s a quarter or not.

Ms B: How would you know if it is a quarter?

David: An ordinary guess.

Ms B: No, you’re absolutely one hundred percent right. I’ll tell you that. But how did you know that?

David: Because I went like this ... (*He was moving small red rods along the longer rod.*)

Ms B: How many parts were you checking to see ...? How many parts fit?

David: Four.

Ms B: So how do you know that’s quarters?

David: ‘Cause there’s four pieces.

In this scaffolding conversation, Ms B linked the manipulatives to the concept of the number of parts naming the fraction. David seemed to be ‘on the way’ to understanding this. Through these interlinked exchanges his understanding appeared to be strengthened as later in this lesson David spontaneously offered that three parts would be thirds. David’s affective response was expressed in the following comment after the lesson:

I was happy because that was pretty easy until I got up to number 6, ‘cause I knew it all. Ms B helped me a little bit. She told me the parts. If I was doing good, she’d say “you’re on the right path”, “you are doing good”.

In Ms L’s classroom, the students were working on multi-digit multiplication. Ms L engaged in a scaffolding conversation with Sophie about multiplying 9 times 87:

Ms L: So now, how can you tell me what 9 times 87 is? What can we keep doing here?

Sophie: Keep adding on 87.

Ms L: Until you’ve added it?

Sophie: Until we’ve got 9.

Ms L: Okay, that will give you the right answer so that's one strategy because addition ... multiplication is when we keep adding the same number over and over and over again. So keep adding on for that please.

Although this seemed an inefficient strategy, Sophie demonstrated an awareness that multiplication can be thought of as repeated addition. The teacher made the decision to leave Sophie to follow her strategy but returned after about eight minutes:

Ms L: How are we going here Sophie? Okay if you think ... this is pretty time consuming isn't it? So let's look at ... if it's 9 times 87, do you think perhaps we could use our knowledge ... how do we multiply by 10? So 10 times 87 which would be what?

Sophie: 870.

Ms L: Okay, spot on. But we only want to multiply 9 times so what do we have to take away from 870 to make it correct?

Sophie: Ahhh... 87?

Ms L: Because we've multiplied one extra. So you do 870 take away 87. See if that will help you. That will be a quicker ... if that's going to help you because that's a quicker way of doing it, isn't it?

In this exchange, the teacher offered a more efficient strategy after Sophie had experienced for herself how time consuming her repeated addition strategy was. In her post-lesson interview, Sophie said

I got confused trying to find the answer to 9 times 87. Then I used subtraction. If you do 10 times 87 it will make 870. If you minus 87, it gets to 783. If I kept adding 87 to my answer it would've taken a long time. It was Ms L's idea.

The conversation Ms L had with Sophie appeared to make an impact on her strategy choice. Sophie realized her strategy was inefficient and could see the value in a more efficient strategy suggested by her teacher, so much so that she independently used the strategy in later lessons indicated by the following observation:

She was trying to work out 9×7 . After a minute she said, "I could just do 10 times 7 and take off 7 to get the answer".

Both these examples show that the scaffolding conversations the teachers had with low-attaining students resulted in progress, either by strengthening understanding or illustrating the use of a more efficient strategy. The teacher can be observed holding back initially from telling the students the answer or strategy. In each case, the teacher scaffolded the students' understanding through careful questioning and responded to the students' thinking (McCosker & Diezmann, 2009), emphasising conceptual connections (Anghileri, 2006) that facilitated progress.

The Use of Manipulatives

Both teachers indicated that they felt 'tasks using manipulatives' were most appropriate for low-attaining students (Tasks questionnaire). However, Ms B and Ms L differed in their use of manipulatives. Ms B was observed using manipulatives with her students, including dice, cards, number lines, Cuisenaire rods and puzzle pieces, for all tasks while Ms L used playing cards for one of the observed tasks.

Perhaps an indication of the difference in Ms B and Ms L's approach to manipulatives is that while Ms L drew and labelled 'manipulatives available at all times' in her drawing of teaching mathematics well (drawing task), on the same task Ms B drew and labelled 'students using manipulatives – cards, dice, games, counters'. In interviews with the

teachers, Ms L talked about being dissatisfied with both the organisation of manipulatives so that students had easy access to them and students' resistance to using materials. During one observed lesson Ms L said to the students:

You might want to use concrete materials. If you need to use them or would like to use them, please feel free. We've got the MAB [Multi-based Arithmetic Blocks] at the back. If you think that's going to help you, get it out. You know that. You don't need to wait to be told. Okay?

No students were observed using MAB in this lesson.

A further difference in each teacher's use of manipulative may reflect Boulton-Lewis' (1992) description of manipulatives as 'concrete embodiments' of concepts or as more formal notations, 'inherent to the discipline of mathematics'. Ms L's use of playing cards, the only instance of manipulative use observed in this classroom, was as a tool for generating random numbers, symbols of mathematics.

The impact Ms L's use of playing cards had on Sophie and Riley was mixed. Sophie was observed having difficulty understanding the game and then struggled to correctly answer the multiplication equations to find products. Riley also spent most of the time for this game trying to calculate nine multiplied by eight. Ms L suggested he use an array but Riley didn't know what an array was. Ms L showed him and he drew an array of nine by eight although his final answer was incorrect.

After this lesson Sophie said:

I'm still figuring out what to do, still a little bit confused about finding the answers.

Following the same lesson Riley stated:

[The lesson was] good because it was something different and we get to use playing cards and do the maths questions.

Riley seemed to enjoy the use of the cards in this lesson, although his understanding of products and factors did not seem supported by their use. Sophie recognised her struggle with the task and did not express the same positive response toward using the cards as did Riley.

In contrast, in Ms B's class, manipulatives were distributed to every student and formed an integral part of the tasks, often more aligned with the 'concrete embodiment' idea of manipulatives (Boulton-Lewis & Halford, 1992). Ms B's use of manipulatives seemed to have a positive effect both cognitively and affectively for the target students, Carl and David. As discussed above, David's understanding that the number of equal parts names the fraction was strengthened through his use of the Cuisenaire rods. In a post-lesson interview Carl revealed his affective response to these tasks:

It was pretty fun cause it was about fractions. I got to build stuff.

The difference in Ms B's and Ms L's use of manipulatives seemed to centre around whether their use was a planned part of the task or an optional extra. Ms L had manipulatives available but their use was dependent upon the students making the choice to use them. Neither the tasks themselves nor the teacher required such use. In contrast, Ms B gave the manipulatives to the students and completing the tasks required their use. These differences may be due partly to the mathematical content covered by each teacher. It is possible that fractions, decimals and percent concepts lend themselves more to the use of manipulatives in a way that multi digit multiplication does not. Where manipulatives were used, they appeared to have a positive impact on the students. We can see from the example of David and the rods (above) that manipulatives supported his growing understanding. Furthermore, Carl found such use engaging and motivating. Riley also

indicated a positive response toward the use of playing cards although his understanding did not seem supported by this use. Sophie indicated no response to using the cards and recognised her own confusion during this task. If there were systematic use of manipulatives within Riley and Sophie's mathematics lessons, it would be interesting to have observed the impact of such use on their learning of multi-digit multiplication.

Conclusion

This paper has described two teachers' use of scaffolding conversations and manipulatives and the impact on low-attaining upper primary students. Scaffolding conversations appeared to have a positive impact on the learning and feelings of the low-attaining target students. These conversations illustrated aspects of Anghileri's "conceptual discourse" in that the teachers created "opportunities to reveal understandings" (2006, p. 47). For example, in the conversations reported in this paper, understandings were revealed about the relationship between the number of parts in one whole and the fractional name for such parts or that multiplying by ten and subtracting one set is the same as multiplying by nine.

The teachers utilised manipulatives in different ways. Ms B's students, who used manipulatives frequently, reported positive feelings about using materials. In addition their understanding appeared to be supported by such use. Ms L's students were observed using manipulatives in one lesson with mixed results. This would appear to support Sowell's (1989) assertion that successful use of manipulatives is contingent on the teachers' long term use and familiarity with using materials.

Scaffolding is a complex process often requiring the teacher to make 'in the moment' decisions to respond to individual student understandings. It is hoped that examples such as those offered here will add to the literature on scaffolding and more importantly, demonstrate how it might be enacted in mathematics classrooms.

References

- Ambrose, R. (2002). Are we overemphasizing manipulatives in the primary grades to the detriment of girls? *Teaching Children Mathematics*, 9(1), 16-22.
- Anghileri, J. (2006). Scaffolding practices that enhance mathematics learning. *Journal of Mathematics Teacher Education*, 9, 33-52.
- Ball, D. (1992). Magical hopes: Manipulatives and the reform of mathematics education. *American Educator*, 16(2), 46-47.
- Boulton-Lewis, G., & Halford, G. (1992). The processing loads of young children's and teachers' representations of place value and implications for teaching. *Mathematics Education Research Journal*, 4(1), 1-23.
- Butler, F., Miller, S. P., Crehan, K., Babbitt, B., & Pierce, T. (2003). Fraction instruction for students with mathematics disabilities: Comparing two teaching sequences. *Learning Disabilities Research and Practice*, 18(2), 99-111.
- Cass, M., Cates, D., & Smith, M. (2003). Effects of manipulative instruction on solving area and perimeter problems by students with learning disabilities. *Learning Disabilities Research and Practice*, 18(2), 112-120.
- Cheeseman, J. (2009). Challenging mathematical conversations. In R. Hunter, B. Bicknell & T. Burgess (Eds.), *Crossing divides, Proceedings of the 32nd annual conference of the Mathematics Education Research Group of Australasia* (pp. 113-120). Palmerston North, NZ: MERGA.
- Goldin, G. A., & Shteingold, N. (2001). Systems of representations and the development of mathematical concepts. In A. Cuoco & F. Curcio (Eds.), *The roles of representation in school mathematics* (pp. 1-23). Reston, Virginia: National Council of Teachers of Mathematics.
- Goos, M. (2004). Learning mathematics in a classroom community of inquiry. *Journal for Research in Mathematics Education*, 35(4), 258-291.

- McCosker, N., & Diezmann, C. (2009). Scaffolding students' thinking in mathematical investigations. *Australian Primary Mathematics Classroom*, 14(3), 27-33.
- McDonough, A. (2002). *Naive and yet knowing: Young learners portray beliefs about mathematics and learning*. Unpublished doctoral dissertation, Australian Catholic University, Melbourne.
- Merriam, S. (1998). *Qualitative research and case study applications in education*. San Francisco: Jossey-Bass.
- Numeracy Review Panel. (2008). *National numeracy review*. Retrieved 2 March 2010 from http://www.coag.gov.au/reports/docs/national_numeracy_review.pdf
- QSR International. (2005). *NVivo*. Doncaster, Melbourne.
- Rosenshine, B., & Meister, C. (1992). The use of scaffolds for teaching higher-level cognitive strategies. *Educational Leadership*, 49(7), 26-32.
- Sowell, E. J. (1989). Effects of manipulative materials in mathematics instruction. *Journal for Research in Mathematics Education*, 20(5), 498-505.
- Stacey, K., Helme, S., Archer, S., & Condon, C. (2001). The effect of epistemic fidelity and accessibility on teaching with physical materials: A comparison of two models for teaching decimal numeration. *Educational Studies in Mathematics*, 47(2), 199-221.
- Stake, R. (1995). *The art of case study research*. Thousand Oaks: Sage, CA.
- Victorian Curriculum and Assessment Authority. (2006). Victorian Essential Learning Standards. Retrieved 2 February 2010, from vels.vcaa.vic.edu.au/index.html
- Wood, D., Bruner, J., & Ross, G. (1976). The role of tutoring in problem solving. *Journal of Child Psychology and Psychiatry*, 17, 89-100.

The Predominance of Procedural Knowledge in Fractions

Tricia Forrester

The University of Wollongong
<tricia@uow.edu.au>

Mohan Chinnappan

The University of Wollongong
<mohan@uow.edu.au>

Teachers play a crucial role in the mathematical learning outcomes of their students. The quality of teachers' mathematical knowledge has been of interest to key stakeholders and several lines of inquiry have been running in an effort to better understand the kinds of knowledge that mathematics teachers need to acquire and use to drive their lessons. Despite a decade of research in this area, the interconnections amongst the various strands of knowledge required by mathematics teachers is still unclear. In this report we attempt to investigate this issue by focusing on procedural and conceptual knowledge utilised in the assessment responses of a cohort of prospective teachers.

Background

Two decades ago Shulman (1986), in examining the kinds of knowledge that are essential to teachers' work, identified two categories of knowledge that were deemed to be necessary for effective practice: subject-matter knowledge and pedagogical content knowledge. This seminal work has spawned a number of studies in various domains including mathematics. Ball, Hill and Bass (2005), in taking up this issue, developed a number of new strands in this knowledge cluster, including the now well-established dimensions of Content Knowledge (CK) and Pedagogical Content Knowledge (PCK). There is an emerging consensus that effective mathematics classroom practices need to be anchored by a robust body of CK and PCK. CK refers to knowledge of the concepts, principles, procedures and conventions of mathematics, and PCK indicates the translation of CK into understandings to which learners could relate. While the connections between CK and PCK have received substantial attention, the two major components of CK, namely concepts and procedures, have not been examined with sufficient rigour, particularly in the context of specific strands of primary mathematics. This is a major aim of this study.

The importance of conceptual and procedural knowledge in mathematical understanding and subsequent performance continues to be a parallel issue for mathematics teachers, the research community and other stakeholders (Council of Australian Government (2008). Skemp (1976) took the early steps in highlighting the relative roles of the two in characterising high levels of mathematical performance by focussing on instrumental and relational understanding. He argued that the former was driven by procedural knowledge, the latter by conceptual knowledge. More recently, Chinnappan and Chandler (in press) elucidated the role of mathematics teachers' conceptual knowledge in reducing information processing loads that could be associated with problem solving. In a similar vein, the decoding of structures underlying complex mathematics concepts, which is necessary for deep mathematical understanding, was deemed to be buttressed by robust conceptual knowledge, both by teachers and learners (Mason, Stephens & Watson, 2009).

Broadly speaking, procedural knowledge involves understanding the rules and routines of mathematics while conceptual knowledge involves an understanding of mathematical relationships. The relationship between procedural and conceptual knowledge, and the dependency of one on the other, continues to be a legitimate concern for mathematics teachers and researchers alike (Schneider & Stern, 2010; Schoenfield, 1985). This



knowledge is not static and there is a need to examine the trajectory of this knowledge, throughout pre-service education and beyond, if we are to better understand teachers' practices and their professional needs (Ball et al., 2005).

The research reported here is the first of two phases. In Phase 1 (reported here), we attempt to describe the quality of knowledge of fractions that was evident in a cohort of pre-service (PS) teachers in their first year of teacher education and prior to commencement of their professional experience. In Phase 2 of the study the PS teachers will respond to the similar fraction tasks in the third year of their pre-service course, following further studies and professional experience. Results of Phase 2 are expected to provide insights into changes in both the quality and quantity of PS teachers' CK and PCK.

Conceptual Framework

Our research questions and the interpretation of relevance were guided by a model of mathematical understanding, developed by Bamby, Harries, Higgins, and Suggate (2009), in which representations played a central role. Their representational model of understanding emphasises two facets: connections between internal representations of a concept and the articulation of links among the representations via robust reasoning processes. For example, the concept of multiplications of whole numbers can be represented as a) repeated addition, b) rows and columns in a rectangular array and c) operations in a lattice algorithm. All three constitute defensible representations of the focus concept (multiplication). However, the first two representations are conceptually rich while the last one can be explained purely from a procedural angle. Our decision to use this model was based on our desire to better understand the depth of student teachers' conceptual and procedural understanding.

Purpose and Research Questions

The purpose of the study is to examine the quality of PS teachers' representations of fraction concepts in terms of their demonstration of procedural and conceptual knowledge. This will be addressed by generating data relevant to the following research questions:

1. What is the relative use of procedural and conceptual knowledge when PS teachers represent fraction problems that involve subtraction?
2. What is the relative use of procedural and conceptual knowledge when PS teachers represent fraction problems that involve multiplication?
3. Is there a relationship in the use of procedural/conceptual knowledge by PS teachers when they attempt to represent subtraction and multiplication fraction problems?
4. How robust are the above representations?
5. What are the categories of error committed by PS teachers in their representations?

Methodology

Participants

One hundred and eighty-six students (22 males and 164 females) completed two questions (following) as part of the final assessment task for a first year mathematics content and pedagogy unit. The unit is compulsory and generally completed in the second semester of a four-year Bachelor of Primary Education degree.

Tasks and Procedure

The following tasks were two parts of one question in a fifteen question examination. They were selected from a pool of thirty-two questions given to students in their unit outlines at the beginning of the semester. The pool of questions was designed to examine both content and pedagogical knowledge. These particular tasks were chosen to assess students' conceptual and/or procedural knowledge of fractions and fraction algorithms. While the values of the fractions were different from those given in the unit outline, students had been able to engage with similar questions throughout the session to consolidate their procedural and conceptual understandings.

Task 1: Subtraction Problem involving a mixed number and fractions with different denominators $1\frac{2}{3} - \frac{5}{6}$

There are several separate procedures involved in solving this problem: changing the mixed number to an improper fraction; identifying the lowest common denominator of the minuend and subtrahend; changing the minuend and subtrahend to equivalent fractions; performing the subtraction; checking if the answer can be simplified

Conceptual knowledge of this problem involves an understanding that: the minuend and subtrahend are related to the same size "whole"; $1\frac{2}{3}$ is the same as $\frac{7}{3}$ because one whole is the same as $\frac{3}{3}$; equivalent fractions are the same size; subtraction of the subtrahend involves removing 25 lots of $\frac{1}{6}$.

Task 2: Multiplication Problem $\frac{1}{4} \times \frac{2}{3}$

Procedurally the solution involves: multiplying the numerators together; multiplying the denominators together; simplifying the answer.

A conceptual understanding of this task involves the notion that $\frac{1}{4} \times \frac{2}{3}$ involves finding $\frac{1}{4}$ of $\frac{2}{3}$ or $\frac{2}{3}$ of $\frac{1}{4}$. This entails more than repeating the idea that $\frac{1}{4} \times \frac{2}{3}$ can be expressed as $\frac{1}{4}$ of $\frac{2}{3}$, or what Skemp (1976) described as "rules without reasons" (p. 20). Conceptual understanding involves partitioning $\frac{2}{3}$ into four equal parts to find $\frac{1}{4}$ of $\frac{2}{3}$ or cutting $\frac{1}{4}$ into three equal parts to find $\frac{2}{3}$ of $\frac{1}{4}$.

In undertaking the tasks, students were expected to show all steps, including any visual representations that could be used to demonstrate their thinking. To complete the calculations students could use an algorithm for carrying out a particular operation with fractions. The successful use of an appropriate algorithm would indicate that students have a procedural understanding, what Skemp (1976) defined as *instrumental knowledge* (knowing a rule and being able to use it). Conceptual or relational understanding involves knowing what to do and why (Skemp, 1976). In this case it involves a comprehension of the nature of fractions (equal parts of a whole object or group) including the meaning of the common fraction symbols (as opposed to the misconception common among children that the numerator and denominator are simply two whole numbers) (NSW Department of Education and Training, 2003). Additionally, a conceptual understanding of these tasks involves grasping what happens when multiplying and subtracting fractions.

Coding Scheme

Students' responses to each of the two problems were analysed in terms of the evidence of conceptual and procedural knowledge and coded as per the scheme below. In developing the scheme we were guided by the framework of Bambrly et al. (2009) and analysis of problem representation (Goldin, 2008).

4 – Conceptual with explicit reasoning. Correct algorithm, model supported with language

- 3 – Conceptual, no evidence of reasoning. Correct algorithm, model of concept evident
- 2 – Procedural/conceptual. Correct algorithm and model demonstrates more than a procedural understanding of a concept involved in fraction operations
- 1 – Procedural. Correct algorithm and/or model only of fractions
- 0 – No evidence of procedural or conceptual understanding

Data and Analysis

Quantitative data analyses were conducted with the aid of SPSS version 18. Our analyses focused on the above five categories of problem representation; the scale of our data was nominal.

We set out to examine the relative role of procedural and conceptual knowledge used by PS teachers as they attempted to represent two problems in the area of fractions. The general issue of PS teachers’ proclivity to draw on different proportions of these knowledge components were examined in terms of five research questions. We present the data relevant to each question below.

Research Question 1 - What is the relative use of procedural and conceptual knowledge when pre-service teachers represent fraction problems that involve subtraction?

Figure 1a shows the results of the analysis of frequency of the two knowledge categories for the subtraction problem. Almost double the number of PS teachers activated procedural knowledge in comparison to those that displayed conceptual knowledge. The relatively low instances of scores of 4 indicate a tendency not to elucidate this conceptual knowledge. We also note that a high proportion of responses demonstrate neither procedural nor conceptual knowledge (scores of 0).

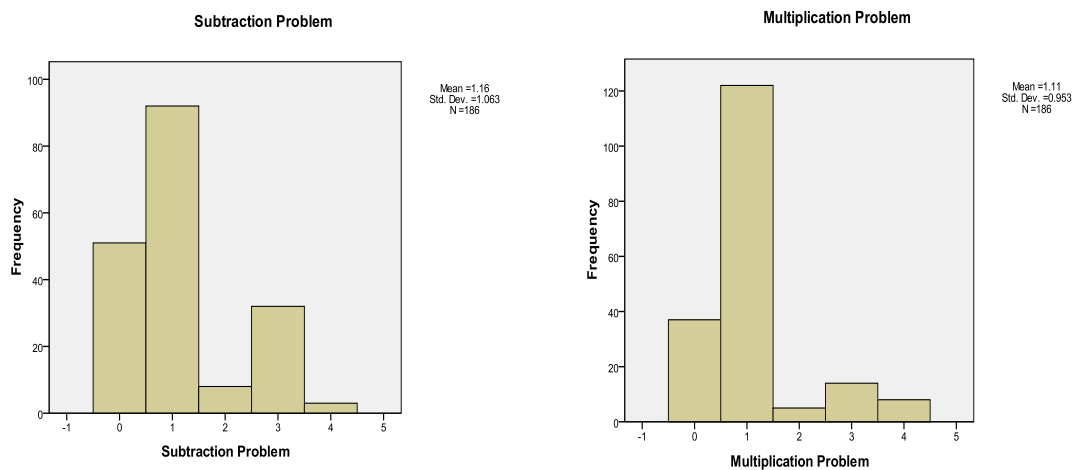

Figures 1a & 1b. Frequency of responses for Subtraction Problem and Multiplication Problems

Research Question 2 - What is the relative use of procedural and conceptual knowledge when pre-service teachers represent fraction problems that involve multiplication?

Almost four times the number of PS teachers activated procedural knowledge components in comparison to those that demonstrated conceptual knowledge in their

solution attempts of the multiplication problems (Figure 1b). About one fifth of responses displayed neither procedural nor conceptual knowledge (scores of 0).

Research Question 3 - Is there a relationship in the use of procedural/conceptual knowledge by pre-service teachers when they attempt to represent subtraction and multiplication fraction problems?

In order to answer Research Question 3, we computed cross tabulations for the categories of scores for the subtraction and multiplication problems. The results of this analysis are presented visually in Figure 2.

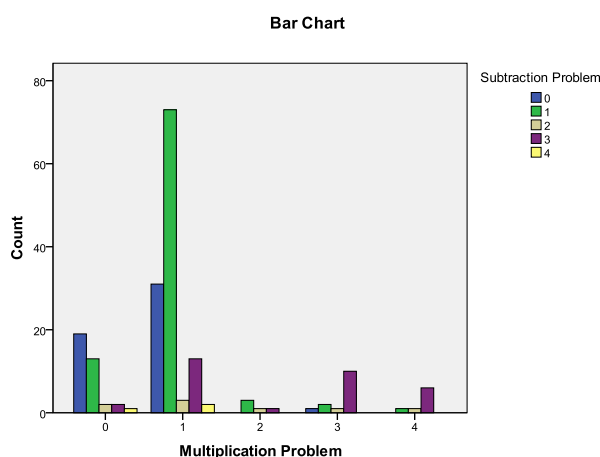
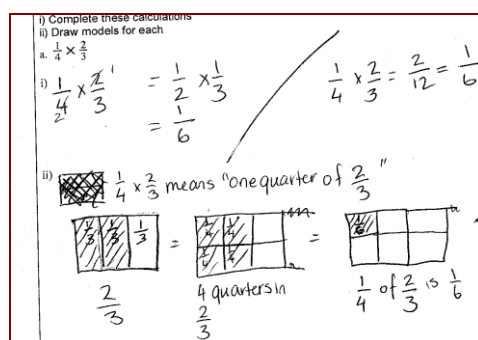
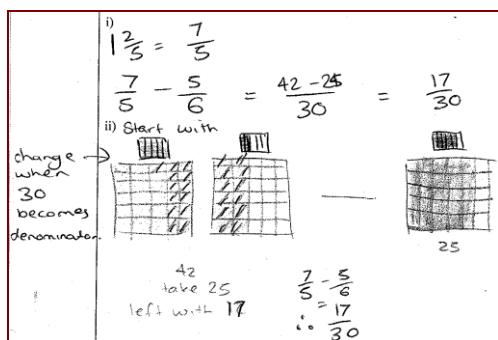

Figure 2: Clustered bar chart within Multiplication Problem

This suggests that there was a similar pattern in PS teachers’ use of procedural and conceptual knowledge in both problems. A two-way contingency table analysis was conducted to evaluate whether representation categories in the subtraction problem were associated with those for the multiplication problem. The two variables were the subtraction problem with five levels of representation and the multiplication problem with five levels of representation. The quality of representations in both the problems was found to be significantly related, $\chi^2(16, N=186) = 75.26, p = .00$, Cramer’s $V = 0.32$.

Research Question 4 - How robust are the above representations?

Our examination of the robustness of representations was informed by the model of Bamby et al. (2009), in that we searched for evidence not only of the construction of powerful representations but also the PS teachers’ abilities to reason about the connectivity among these representations. Figures 3a and 3b provide episodes of robust representations for the subtraction and multiplication problems respectively. In Figure 3a, the student teacher determined an answer using a procedure and converts the problem into visual form, clearly demonstrating equivalence, through the drawing and explanation, before subtracting the second fraction from the first one. In Figure 3b, the PS teacher demonstrated two related procedures for completing the calculation and clearly translated the problem from a symbolic representation to a more meaningful form (“one quarter of”), which is subsequently re-represented in visual form.



Figures 3a & 3b. Examples of robust representations for each task

Research Question 5 - What are the categories of error committed by pre-service teachers in their representations?

We identified nine patterns in the type of errors committed by the PS teachers, five in the multiplication and four in the subtraction question. Here are examples of the two most common error types for each task:

Task 1: Subtraction $1\frac{2}{5} - \frac{5}{6}$

Fifty-one of the one hundred and eighty-six students who completed this examination received a rating of 0 for procedural and conceptual understanding of the subtraction question.

Error A: $\frac{7}{5} - \frac{5}{6} \rightarrow \frac{7}{30} - \frac{5}{30} = \frac{2}{30} = \frac{1}{15}$; subtracting numerators and multiplying denominators. Ten students did not change the minuend and subtrahend to equivalent fractions but subtracted the numerators and multiplied the denominators.

Error B: e.g., $\frac{7 \times 6}{5 \times 6} - \frac{5 \times 6}{6 \times 5} = \frac{42}{30} - \frac{30}{30} = \frac{12}{30}$; an error in making equivalent fractions. Thirteen students made an error in changing the minuend and subtrahend into equivalent fractions. There was a range of different mistakes within this group.

Task 2: Multiplication $\frac{1}{4} \times \frac{2}{3}$

Thirty-eight of the one hundred and eighty-six students who completed the examination received a 0 rating in this question, indicating an absence of both procedural and conceptual understanding.

Error 1: $\frac{1}{4} \times \frac{2}{3} = \frac{3}{12}$; adding numerators and multiplying denominators. Eleven students made this error, all getting an answer of $\frac{3}{12}$ with nine simplifying the answer to $\frac{1}{4}$. It was not possible to determine if the error was in adding, rather than multiplying the numerators, was unintentional, or was a misunderstanding of the correct procedure to multiply fractions.

Error 2: $\frac{1}{4} \times \frac{2}{3} = \frac{3}{12} \times \frac{8}{12} = \frac{24}{12} = 2$; making equivalent fractions and multiplying the numerators. Eight students found equivalent fractions for the multiplicand and multiplier, and then multiplied the numerators together but not the denominators (a procedure which could be a transfer of the knowledge regarding the addition or subtraction fractions with different denominators).

Eighteen of the nineteen students making these two errors produced a model but only modelled the multiplicand, multiplier and/or the product but not the concept of finding $\frac{1}{4}$ of $\frac{2}{3}$.

The dominance of procedural over conceptual knowledge, observed in our analyses of the representations, was also evident in the type of errors made. All of the nine common error groups were related to common algorithmic procedures being applied incorrectly because they were not understood at a conceptual level, which was further evident in the PS teachers' models. When comparing responses to the multiplication and subtraction problems, more PS teachers utilised conceptual knowledge in the subtraction problem than the multiplication task. Interesting, more PS teachers also demonstrated no procedural or conceptual knowledge (receiving a rating of 0), in completing the subtraction problem. This may be due to the multiple procedural steps needed to complete the subtraction task successfully, which allows more scope for error when approached without conceptual understanding. Additionally, none of the PS teachers made procedural or calculation errors while simultaneously demonstrating conceptual understanding in their models.

Discussions and Implications

Our main interest in the present study was to distinguish between the conceptual and procedural knowledge of a cohort of PS teachers in the context of two fraction problems. These research questions were set against the need to describe the quality of our prospective teachers' CK (Ball et al., 2005) early in their teacher education courses and with regard to their professional experience.

A close look into the quality of representations in these tasks indicates that some of the PS teachers who participated in the present study have developed a robust body of conceptual and procedural knowledge of fractions and operations involving fractions. Results indicate that these PS teachers' CK of fractions, in the context of both of these problems, was primarily procedural in nature. This was more pronounced in the multiplication problem. A possible explanation for this may be because this task was somewhat denser conceptually than the subtraction problem and thus provided a richer problem context for the PS teachers to reveal flexibility in their activation and use of conceptual knowledge. The high number of errors in both tasks also indicates that these PS teachers rely heavily on procedural knowledge which, when not supported by conceptual understanding, is difficult to utilise without error and difficult to review for possible mistakes.

From a cognitive perspective, there exists an underlying structure in each of the problems. The unpacking of this structure, we contend, calls for a greater proportion and better use of conceptual knowledge. For instance, the multiplication problem involved fractions as the multiplicand and multiplier. The multiplicative structure of this type of problem is not congruent with the structure of problems involving whole numbers and requires an understanding of the partitioning nature of the multiplication of fractions (Mack, 2001).

The cross-tabulation analyses indicated that PS teachers' patterns of activating procedural or conceptual knowledge in the subtraction and multiplication tasks were not independent. That is, regardless of the problem type, the CK of the PS teachers was mainly procedural in nature. While both strands of knowledge are necessary for teaching, the predominance of the procedural over conceptual, we suggest, is not a healthy situation. Teachers who develop CK that is predominantly procedural cannot be expected to help children develop rich conceptual connections that are necessary for modelling of problems (Lesh & Zawojewski, 2007).

Limitations

The cohort had a wide range of mathematical backgrounds including some who had not attempted mathematics at the HSC level to those with a high level of achievement in HSC mathematics. It is possible that the patterns of results evident in the present study were reflective of these differing backgrounds in mathematics. It would be interesting to examine this issue by analysing the influence of the educational backgrounds of the cohort, and we plan to take this issue up in the next phase (Phase 2) of the study.

Phase 2 of this project will also include a follow-up investigation of the development of PS teachers' CK following professional experience and further studies, including a group of approximately 50 students who will complete additional mathematics content units. We intend to further examine this cohort of PS teachers' procedural and conceptual understandings in light of their previous mathematics experience, exposure to subsequent university content and pedagogy courses, and their professional experience.

References

- Ball, D. L., Hill, H. C., & Bass, H. (2005). Who knows mathematics well enough to teach third grade, and how can we decide? *American Educator*, 5(3), 43-46.
- Bramby, P., Harries, T., Higgins, S., & Suggate, J. (2009). The array representation and primary children's understanding and reasoning in multiplication, *Educational Studies in Mathematics*, 70, 217-241.
- Chinnappan, M. & Chandler, P. (in press). Managing cognitive load in the mathematics classroom, *Australian Mathematics Teacher*.
- Council of Australian Government (2008). *National Numeracy Review Report*. Canberra.
- Goldin, G. (2008). Perspectives on representation in mathematical learning and problem solving. In L.English (Ed.), *Handbook of international research in mathematics education*. New York: Routledge.
- Lesh, R., & Zawojewski, J. (2007). Problem solving and modeling. In F. K. Lester (Ed.), *Second Handbook of Research on Mathematics Teaching and Learning* (pp. 763-807). Charlotte, NC: Information Age.
- Mack, N. K. (2001). Building on informal knowledge through instruction in a complex content domain: Partitioning, units, and understanding multiplication of fractions. *Journal for Research in Mathematics Education*, 32(3), 267-295.
- Mason, J., Stephens, M., & Watson, A. (2009). Appreciating mathematical structure for all. *Mathematics Education Research Journal*, 21(2), 10-32.
- NSW Department of Education and Training. (2003). *Fractions, pikelets and lamingtons*. Ryde, NSW: Author.
- Schoenfeld, A. H. (1985). *Mathematical problem solving*. New York: Academic Press.
- Schneider, M., Stern, E. (2010). The developmental relations between conceptual and procedural knowledge: A multimethod approach. *Developmental Psychology*, 46(1), 178-192.
- Shulman, L. S. (1986). Those who understand: Knowledge growth in teaching, *Educational Researcher*, 4 (15).
- Skemp, R. R. (1976). Relational understanding and instrumental understanding. *Mathematics Teaching*, 77, 20-26.

Becoming More Numerate: The Journey of Tania

Linda Galligan

University of Southern Queensland

<linda.galligan@usq.edu.au>

This is the academic numeracy journey of Tania, who participated in a research study that investigated the academic numeracy skills of nursing students. Tania is a mature aged woman, and her story represents many of such mature aged students as they journey into a largely unknown university culture. The data for this research came from student assignments, surveys, interview transcripts, emails and screencasts. To see the development in Tania's numeracy, this paper utilises the micro- and macrogenetic models from Valsiner, and his approach to dialogic self. We see Tania in different I-positions in particular of becoming a university student, becoming a nursing student and becoming numerate i.e. as being able to use mathematics confidently and competently in a nursing context.

In recent years the term numeracy has been used in schools and while it has been defined in that sphere as “to use mathematics effectively to meet the demands of life at home, in paid work, and for participation in community and civic life” (AAMT, 1998, p. 3), it often takes the guise of basic mathematics. However the use of mathematics within a school context is seen very differently from when it is actually used at work. FitzSimons (2006), using Bernstein's concepts of vertical and horizontal discourse, discussed school mathematics as vertical discourse, and work place mathematics as horizontal discourse. I propose that academic numeracy is somewhat in between these two but being influenced by both and often quite different from both. In the past I have defined academic numeracy in general (Galligan & Taylor, 2008). Here that definition is amended for the nursing context: a critical awareness which allows the nursing student to situate, interpret, critique, use and perhaps even create mathematics confidently and competently in the academic context. This paper is based on a first year nursing course aimed at improving students' academic numeracy and computing skills.

Background: The Nursing Context

In nursing, the numeracy skills required are considerable. In a typical day, a professional nurse is asked to undertake a multitude of tasks, many of which involve mathematics. Tasks include situating and interpreting a patient's chart (temperature, pulse and respiration rates), administering or monitoring medication (e.g. assessing the rate of a IV drip), writing results on charts, and critiquing patients' needs (e.g. how much pain are they in). They also have to undertake these tasks confidently and competently. As Forman and Steen said in 1995 these contexts provide “a rich source of higher order thinking based on lower order mathematics” (p.221). However, the ways nurses complete these tasks are often quite different from what they typically learnt at university. (e.g. Hoyles, Noss, & Pozzi, 2001). At university nursing students are learning not only what nursing will be like, but also the demands of academic life, which requires critical thinking, problem solving, research and written communication skills, all of which can involve some mathematics. Research (e.g. Oldridge, Gray, McDermott, & Kirkpatrick, 2004; Rainboth & DeMasi, 2006) and my own background in supporting nursing students, have suggested that the nursing academic community is concerned with their students' level of mathematics skills not only for nursing but also for university.



Background: Theoretical Frame

In 2008 I discussed the role Valsiner's theory of human development (1997) could play in understanding academic nursing numeracy, specifically to identify what scaffolding is needed to assist teachers to allow students to understand academic numeracy and move forward (Galligan, 2008). Valsiner suggested that teachers 'create microsettings for the learners (within the wider activity context) where the learners can achieve the next moment of understanding themselves' (Cole & Valsiner, 2005, p. 309). Both he and Cole spoke of the concept of "obuchenie", loosely translated from Vygotsky as teaching/learning, where both the teacher and the learner are changed because of the activities organised (Cole & Valsiner, 2005; Cole, 2009). Valsiner also advocated the use of Vygotsky's method of double stimulation in a developmental quasi-natural experimental setting - the double stimulation coming from a Stimulus Object and Stimulus Means (with two stimulus means). In nursing for example, students are provided with a richly structured environment which can be restructured in a goal oriented way (Stimulus Object e.g solving a drug calculation). In this environment, the means to get to that object (Stimulus Means) is through Action Tools (e.g. a formula) accessed through a student's past experience etc. (Stimulus Means 2 e.g. having used the formula before but also other past experiences with mathematics) and the student's semiotic mediation with that Action Tool (Stimulus Means 1: thinking to use the formula or something else) and Stimulus Means 2. The general structure of the method in this study is to observe the initial, intermediate and final state of an event (or goal such as undertaking a drug calculation task), but the concentration is on the unfolding of the intermediate forms, both the ones that eventually turn into final forms and those that don't (described in Galligan, 2008). Within this unfolding attention is given to students' macrogenetic background (Joerchel & Valsiner, 2004) such as past mathematics experiences, network of student support; and students' ability to reflect and self-scaffold (Stimulus Means 2) and their thinking about how to act on the Stimulus Object. In the act of thinking, Valsiner drew from the dialogic self (DS) work of Hermans. DS theory is about semiotically self-regulating self in terms of "dynamic multiplicity of relatively autonomous *I*-positions" (Hermans, 2001). There are two visions of self – externally and internally. Internal positions could be *I*-the student or *I*-the mother. External positions talk about my tutor, my lecture notes, all in relation to *I*-the student; another external position may be my child, my home etc all in relation to *I*-the mother. This DS theory fits well into the adult learning/numeracy contexts. What may develop in the future are the *I*-student; *I*-nurse; *I*-the maths (or non) numerate person etc. To move these positions the teacher scaffolds students towards change and the student self-scaffolds so it is possible to move the *I*-positions.

Method

The research in which this study is placed is a quasi-experimental intervention case study within a first year first semester nursing numeracy/IT course. It takes a multi-method approach using a pre- and post-test, six computer marked tests (CMA's) and other assignments; observation notes; ten semi-structured teaching sessions and eleven interviews. It has three phases (Faltis, 1997) with each phase having data collection at three levels (Level 1: whole cohort of 1st year nursing students; Level 2: one tutorial class; and Level 3: three students). The first phase provides the baseline data of student academic numeracy; the second details the course, how it was taught, how students reacted to the

course and mathematical issues, the third phase investigates numeracy at the end of the course, and compares this to the other phases.

In this paper it is Level 3 that is being discussed via the collected data and a series of microgenetic studies of student numeracy from the interviews. The microgenetic part of the study is essentially phenomenological as it is centred on the human lived-through experience of students becoming more numerate. It is framed in an individual-socio-ecological frame as it involves an active person; within a rich environment; the person acting on that environment; the teacher has an active guiding role; the aim is the transformation that person (Valsiner, 2007).

Results

Tania's Background

The first section of the nursing course was designed to encourage students to see themselves in three ways: Past numerate self (by writing about their past maths experiences); Present numerate self (by reflecting on pre-test answers); Future numerate self (by reading and commenting on an article on nursing students and numeracy). I will let Tania tell you part of her story from the reflection at the beginning of semester:

At school I hated maths. The only time I actually passed the subject in high school was when I had good teachers that actually took the time to work with the students who actually needed help and unfortunately those teachers were far and few between. One year I did manage very good results, but that was in total thanks to a teacher who was just awesome. He actually sat down and walked me through everything.

Later, in interview 5 she repeated this:

... [Teachers have an impact?] Negative impact, I've always grown up thinking I'm dumb at maths and science and if I had different teachers I would have done extremely well

She knows she “really needs to improve [her] basic mathematical skills”, but already realises the importance of confidence as well as competence:

I expect at the end of this course that I will feel far more confident in basic mathematical work. I expect to learn a lot of invaluable material that will make life at university so much easier. The MAT course will give me the basic grounding in mathematics that I need and it will help me feel more confident that I will be able to complete the degree successfully (submission for assignment 1)

From the beginning Tania appeared to be aware of all that was asked of her and undertook tasks seriously. This could be partly due to her previous experience as a beginning Law student, so she knows what university expectations are. For example at the beginning of semester, students were asked to read an article about maths and nursing. Hers was one of the more reflective responses. Her insights into the reading already suggest she has an ability to synthesise an argument:

... It appears from the articles read that each student has a different way that will help them retain what they have learnt. There does not seem to be one single approach to teaching mathematics that works for everyone. And when it boils down to it, students and registered nurses have to be accurate in nursing calculations as it could cause severe illness or death in a patient that has been given an incorrect dosage (submission for assignment 1).

While Tania's past numeracy self was mainly poor, she did, through one teacher, realise there was some potential. Her present numeracy self sees this potential with her

growing in competence and confidence. Her future numeracy self in nursing sees her as proficient and accurate in nursing calculations. As well she sees herself as a university student and the work done this semester will directly affect this “self” in a positive way (i.e. “to make her life easier”).

These different positionings of Tania help to create her mesogenetic story (Figure 1): how her meaning system is helping to structure her becoming numerate future system. Perhaps these “circles” of influence may change in size and thus shape their influence, (or not) on the future.

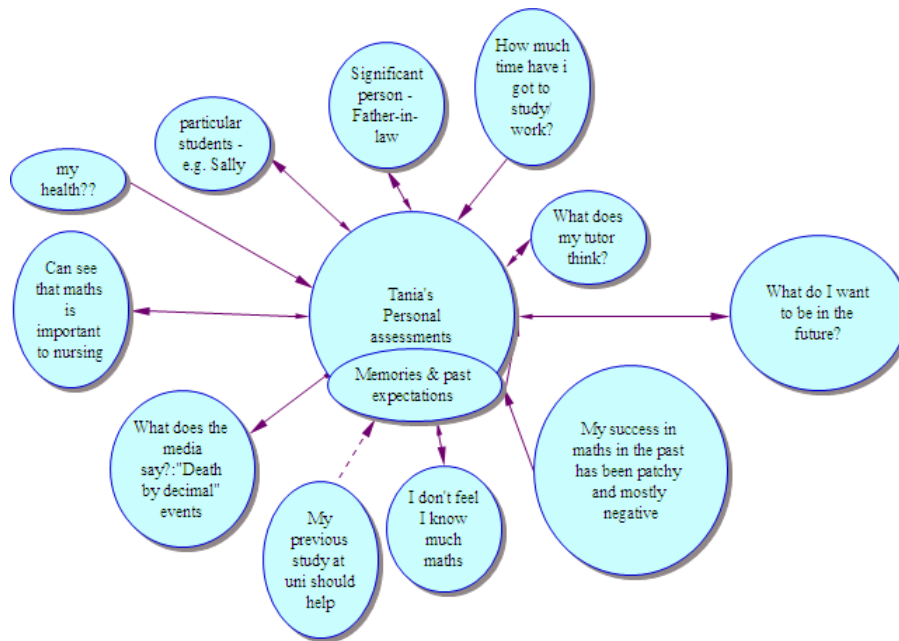

Figure 1. Tania's Mesogenetic model (based on Joerchel & Valsiner, 2004)

Her past mathematics experience may have had such a negative effect on her (Figure 2 (a) on the left) that even with a tutor’s help, and with past university experience, she may not be able to improve her numeracy levels much).

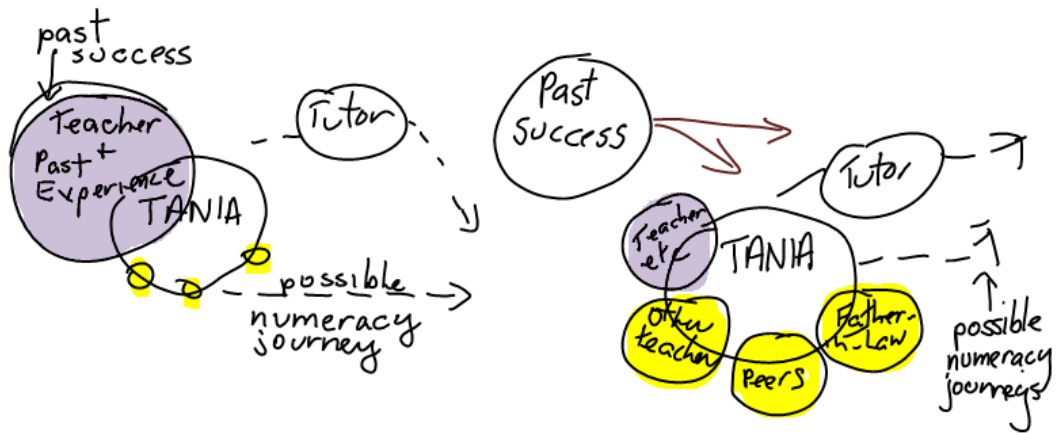

Figure 2. Possible trajectory of learning without harnessing (a) and (b) with harnessing of mesogenetic influences.

If however, an aim at first is to reduce the influence of negative past experience, then other positive influences, such as the memory of the good teacher, her peers telling her that she is “awesome” and her father-in-law being a sounding board outside university, can help her become more numerate (Figure 2(b) on the right) perhaps without tutor scaffolding.

Tania’s Competence and Confidence Journey

The journey from A to B: The quantitative data from the pre-and post-tests and the CMAs give some insight into Tania’s overall levels. Tania got 21/32 in the pre-test (the start of the journey at point A) and 29/32 in the post-test (the journey to B). Her confidence levels rose from an average of 2.58 out of 5 in the pre-test to 4.00 in the post-test. In the CMAs her average mark was 8.17 out of 10 and it ranged from 6 out of 10 in the graphs to 10 out of 10 for percentages and rates, and ratio and proportion. This data, however, tells nothing of how she became more numerate and whether she is, in fact, more numerate.

First the reflective comments from the pre- and post-test give a greater sense of development. Compared to other students, Tania reflected in detail, particularly in the post-test. I now turn to two examples from the qualitative data to investigate this journey.

At the beginning she had no idea about average “I haven’t a clue how to work out an average” (confidence 1). At the end she was still wrong (didn’t divide by 5) but there was a change:

I’m seriously not sure how I got this one wrong. I’ve just recalculated it myself and realised when I sat the exam I must have done something wrong with my calculations on the calculator. Be more careful next time and double check what I consider is the right answer.

In terms of Double Stimulation, the first scenario, where B is the Stimulus Object (i.e. the average problem) promoted by the researcher, Tania simply stops and says she hasn’t a clue. In the background (Stimulus Means 2) all her past experiences of mathematics blocks any attempts to move forward and she simply stops thinking (no SM1).

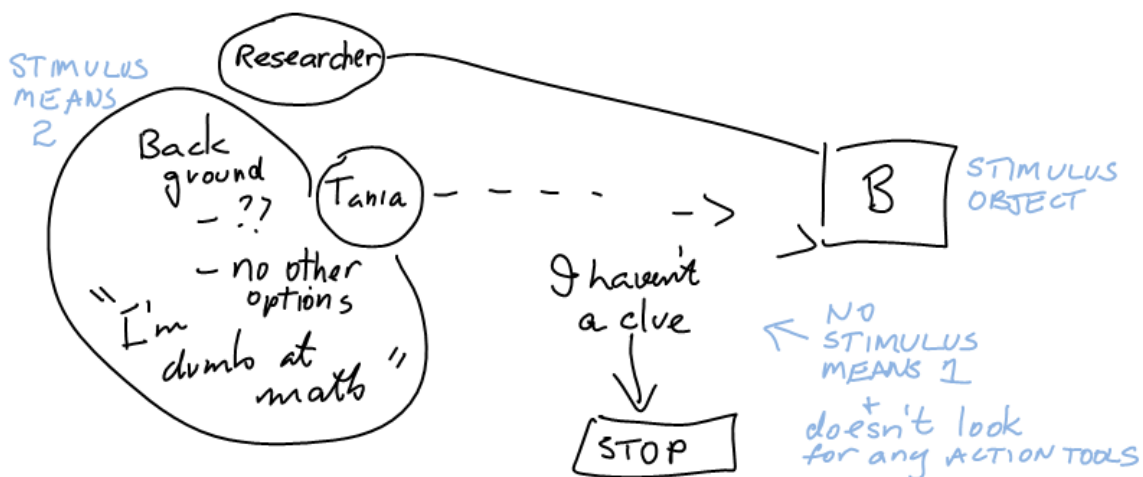

Figure 3. Double stimulation scenario with no development

However in the second scenario, with use of new knowledge and access to other meta-skills such as checking, feeling she should get it right etc (Stimulus Means 1), the background negativity shrinks and she uses other tools to think about the problem. Her confidence is still 3, which means she still must feel some doubt in her ability. Now instead of saying got it wrong and do nothing, she is surprised she got it wrong, has the wherewithal to check, then thinks about what she will do with such problems in the future.

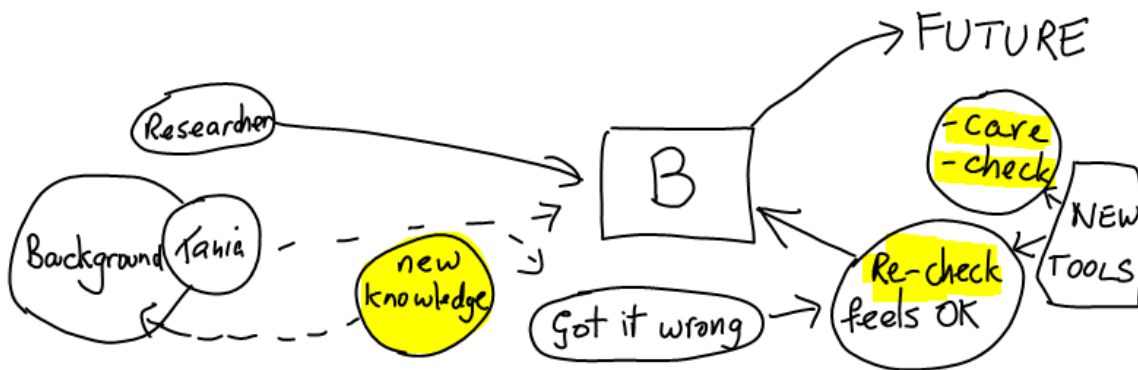

Figure 4. Double stimulation scenario with development

The second example is a question on drug calculation she had “no idea how to do this” with a confidence of 1 in the pre-test. In the post-test she was correct and was looking to her future numerate self. She didn’t complete the confidence level but said:

I am not fully confident with this type of question yet. I definitely need more practice questions like this to feel more confident. I will have to look into this. I am hoping that the medical calculations subject I will be doing next semester will ease my mind and show me how to do these types of equations with ease.

In each of the answers to the pre- and post-tests and the CMAs during the semester, confidence levels and comments help to create a picture of Tania’s numeracy journey.

There are still errors and these errors show that her numeracy journey may not be complete, at times she doesn't read correctly, and there are some aspects that are still troublesome, but overall there appeared to be an improvement in confidence and competence. There is still also some scaffolding needed (e.g. she still refers to notes) and some doubt in some questions but there is an overall gain in her ability to trust herself. At the end of semester survey she wrote:

Absolutely fabulous. learning maths skills that I never even understood in primary school or high school. I can't think of anything [improvement in course] at present...The mat class was awesome. It really helped me realise I could learn some maths.

From these reflections a picture of students' possible next steps is starting to emerge. The action of learning a concept can move from the periphery into the students' knowledge, and can be reflected and promoted, it can also lead to checking and thinking, confidence, transformative thinking about broader maths or nursing issues or thinking of "I" in a new light. There also may be other thoughts or actions present or possible and these may be promoted or not or reflected upon or not.

There were many times along the way where she struggled and asked questions of the course, of the mathematics and of herself. In these sessions I can see more intimately her relationship with the various aspects of mathematics. In some aspects of mathematics, I can see her grow from no understanding to quite good levels of understanding; in others she oscillates between knowing and reverting back to previous states.

If numeracy is about competence and confidence and about being able to situate, interpret, and critique mathematics, then Tania is showing signs of this. In the next semester when she came to a session with me about her solution to a problem, she has this feeling if something is wrong or the answer is too much or too little (line 184):

184. Tania I'm beginning to. I'm not 100 per cent but it's starting to gel because at least – I mean one thing I'm finding that I'm happy with is that I might be doing a calculation the way that [the lecturer] taught us and then going no, the answer – I look at the answer and I go no, if I was a nurse I would realise there's something wrong here..... So I'm beginning to realise that even though my calculations aren't always correct, I'm beginning to see if something looks to me to be way too much or way too little. Then I realise alright, I'm obviously doing something wrong with my calculations... I was trying to explain that to [the lecturer] because he was just saying that we should know all this kind of stuff automatically and I said but we don't. Not everybody is good at maths. But at the same time I've beginning to realise when something looks wrong..

The next day in the second session with her, there was a conversation about drug calculations. Two issues emerged. The first is the fluency with which she now speaks, and the second is the error in reading, which she is still occasionally making. Below I have also included my notes on the conversation.

- | | | | |
|-----|-------------|---|--|
| 40. | Tania | 100 mg per kilo per day and the patients weight is 30 kg so i've got 100 x 30 3000 mg so is 3000 mg divided by strength in stock is 300 mg x 2 = 20 ml per day then I was a little bit unsure about that needed for 2 doses one i am wondering if that 10 ml per per dose or whether it is 40 mls per day was unsure about that one | She is reading this out and is reading "day" instead of "dose" She should have said 20 mg per dose |
| 41. | Facilitator | well this is per dose this is 100 mg per kilo per dose | |
| 42. | Tania | OK so it's a bit different | |
| 43. | Facilitator | And you wrote down day | |

- | | | | |
|-----|-------------|--|--|
| 44. | Tania | when i come to 20 mg 20 ml does it mean 20 mls so is it does that mean its 20 mls times 2 is 40mls per day yeah | And picked up straight away what she had done |
| 45. | Facilitator | So what you have is 100mg per kilo per dose, so then you've multiplied the 100 mg by the 30 to get 3000mg That's 3000mg per dose to get the 3000mg you have to give them 20 mls (yes) per dose | |
| 46. | Tania | So its 20 ml per dose so 40 ml per day [yeah] allright [2 doses] 2 doses see i had here so i calculated it correctly yesterday I had 40 mls today i had 10 ml and i was thinking today is this one right or is that one right? | Must have done this yesterday correctly and was checking |
| 47. | Facilitator | the clue is this here | |
| 48. | Tania | per dose i didnt actually pick up on | |
| 49. | Facilitator | you did you wrote day ..yesterday you must have had dose. Every word is important. | |
| 50. | Tania | hum COOLequals 40 mls per day (writing it) COOL thank you! | |

This drug calculation question was quite complex and she was able to do most of these. She is now reflecting on and checking her work (line 46), but the error was in reading.

Conclusion: Tania's Journey to Date

If Tania's journey is written only from results of tests, then her journal is bare and static. If the scaffolding moments are added to the picture and analysed, at the same time incorporating the constraints and possible future states, a much richer dynamic journey can be seen. At various points in Tania's present (in 2008) the scaffolding phenomena were analysed. External constraints such as the teacher, the material, the environment interacting with internal constraints such as her *I*-positions, the way she was utilising her background of experiences, and acting on the environments all direct (but don't determine) to possible future states.

At a particular point in time it may involve some combination of these. For example if Tania is solving a drug calculation she may gain a bit more understanding of the concept; she may now automatically check her work, but her confidence is such that there is no effect on it, but it may add to her thinking of herself as the new numerate "*T*". What may emerge is a new merged action that automatically incorporated a few of these actions such as checking, understanding and self-scaffolding.

The approach utilising developmental theory of Valsiner, recognises the complex dynamic nature of "obuchenie", the multitude of decisions that a student may make in the course of learning and the influence of a students' mesogenetic processes on learning. Both the constraints and the promotions that a teacher puts in place can assist or inhibit learning, as does the student's own constraints and promotions assist or inhibit learning. In Tania's case, while her background included some negative influences, her own self-scaffolding and her positioning within the learning helped her become more academically numerate.

References

- AAMT (1998). Policy on numeracy education in schools. Adelaide: AAMT, retrieved 12/12/2007 from www.aamt.edu.au/content/download/724/19518/file/numpol.pdf.
- Cole, M., & Valsiner, J. (2005). Actualizing potentials: Learning through psychology's recurrent crises. In Pillemer & P. White (Eds.), *Developmental Psychology and Social Change* (pp. 288-313).
- Faltis, C. (1997). Case study methods in researching language and education. In N. Hornberger & D. Corson (Eds.), *Encyclopedia of language and education: Research methods in language and education (Vol. 8)* (pp. 148-154). Dordrecht, The Netherlands: Kluwer Academic Publications.

- FitzSimons, G. E. (2006). Adult numeracy: Crossing borders of discourse. In M. Horne & B. Marr (Eds.), *Connecting voices: Practitioners, researchers & learners in adult mathematics and numeracy: Proceedings of the 12th International Conference of Adult Learning Mathematics (ALM)*. Melbourne: ACU National.
- Forman, S., & Steen, L. A. (1995). Mathematics for work and life. In I. Carl (Ed.), *Prospects for school mathematics: Seventy five years of progress*. Reston, VA: NCTM.
- Galligan, L. (2008). Using Valsiner. In M. Goos, R. Brown & K. Maker (Eds.), *Navigating currents and charting directions: Proceedings of the 31st Annual Conference of the Mathematics Education Group of Australasia Inc* (Vol. 1, pp. 211-218). Sydney: MERGA.
- Galligan, L., & Taylor, J. A. (2008). Adults returning to study mathematics. In H. Forgasz, A. Barkatsas, A. Bishop, B. Clarke, S. Keast, W. Seah & P. Sullivan (Eds.), *Research in mathematics education in Australasia 2004 – 2007*. Sense Publishers: Rotterdam. pp. 99 -118.
- Hoyles, C., Noss, R., & Pozzi, S. (2001). Proportional reasoning in nursing practice. *Journal for Research in Mathematics Education*, 32(1), 4-27.
- Hermans, H. (2001). The dialogic self: Toward a theory of personal and cultural positioning. *Culture and Psychology*, 7(3), 243-281.
- Joerchel, A. C., & Valsiner, J. (2003). Making decisions about taking medications: A social coordination process [79 paragraphs]. Forum: *Qualitative Research* Retrieved 01/05/2005 from <http://www.qualitative-research.net/fgs-texte/1-04/1-04joerchelvalsiner-e.htm>
- Oldridge, G. J., Gray, K. M., McDermott, L. M., & Kirkpatrick, C. M. J. (2004). Pilot study to determine the ability of health-care professionals to undertake drug dose calculations. *Internal Medicine Journal*, 34, 316-319.
- Rainboth, L., & DeMasi, C. (2006). Nursing students' mathematic calculation skills. *Nurse Education Today*, 26(8), 655-661.
- Valsiner, J. (2000). *Culture and human development: An introduction*. London: Sage.

Bridging the Numeracy Gap for Students in Low SES Communities: The Power of a Whole School Approach

Ann Gervasoni

Australian Catholic University

Ann.Gervasoni@acu.edu.au

Linda Parish

Australian Catholic University

Linda.Parish@acu.edu.au

Cait Upton, Teresa Hadden, Kathie Turkenburg, Kate Bevan, Carole Livesey,
Deirdre Thompson, Melissa Crosswell and Julie Southwell
Ballarat, Sandhurst, Sale and Western Australia Catholic Education Offices

This paper explores the impact of the *Bridging the Numeracy Gap Project* on the whole-number learning of Prep and Grade 1 students living in a low SES community. The findings suggest that an approach that includes a specialist mathematics teacher who provides specialised programs for mathematically vulnerable students, and who works in partnership with classroom teachers to design individual learning plans, and classroom mathematics programs that cater for the diverse range of students' learning needs, has a positive effect on mathematics learning and instruction.

Education is well established as a significant factor in breaking the cycle of poverty for marginalised people in Australia and throughout the world (Zappalà, 2003). Education provides knowledge that ultimately empowers people to access further education, employment and active citizenship. Sadly, educational outcomes for those students living in low Socio-Economic Status (SES) communities and Aboriginal and Torres Strait Islander communities are lower than for students not living in these communities (Commonwealth of Australia, 2008; Zevenbergen & Nieske, 2008). Thus, the current Australian Federal Government has both a continued and renewed emphasis on closing the education gap between these groups of Australians. One initiative launched by the Federal Government is a series of Pilot Projects that seek insight about how to close the literacy and numeracy gap for Australian students. This paper reports on one Pilot that is a collaborative project between 42 school communities, Catholic Education Offices in the regions of Ballarat, Sandhurst, Sale, and Western Australia, and Australian Catholic University.

Background

Key approaches used to improve mathematics in this Pilot are: classroom teachers administering a one-on-one interview-based mathematics assessment using the *Early Numeracy Interview* and associated framework of Growth Points (Clarke, Cheeseman, Gervasoni, Gronn, Horne, McDonough, Montgomery, Roche, Sullivan, Clarke, & Rowley, 2002; Gervasoni, Hadden, & Turkenburg, 2007), having a specialist teacher to assist teachers to use this data to guide instruction and curriculum development at individual, class and whole school levels (Gervasoni & Sullivan, 2007), and using the *Extending Mathematical Understanding Program* (Gervasoni, 2004) in the second year of formal schooling to provide intensive specialised instruction for students who are mathematically vulnerable. For the purpose of exploring the effect of these approaches on students' early school learning, this paper compares the Prep and Grade 1 children's growth in whole number learning at one regionally-based Victorian school to a representative population of



Victorian students. This school is situated in one of the lowest socio-economic-status (SES) communities in the State.

The Early Numeracy Interview and Framework of Growth Points

The *Early Numeracy Interview* (Department of Education Employment and Training, 2001), developed as part of the *Early Numeracy Research Project* (Clarke et al., 2002), is a clinical interview with an associated research-based framework of Growth Points that describe key stages in the learning of nine mathematics domains. This interview and the Growth Points were used in this research to gather the data examined in this paper.

The principles underlying the construction of the Growth Points for the *Early Numeracy Research Project* (ENRP) were to: describe the development of mathematical knowledge and understanding in the first three years of school in a form and language that was useful for teachers; reflect the findings of relevant international and local research in mathematics (e.g., Steffe, von Glasersfeld, Richards, & Cobb, 1983; Fuson, 1992; Mulligan, 1998; Wright, Martland, & Stafford, 2000; Gould, 2000), allow the mathematical knowledge of individuals and groups to be described, reflect, where possible, the structure of mathematics, and enable a consideration of students who may be mathematically vulnerable.

The Growth Points form a framework for describing development in nine domains, including four whole number domains that are the focus of this research: Counting, Place Value, Addition and Subtraction, and Multiplication and Division. The processes for validating the Growth Points, the interview items and the comparative achievement of students in project and reference schools are described in full in Clarke et al. (2002).

To illustrate the nature of the Growth Points, the following are the Growth Points for Addition and Subtraction. These emphasise the strategies children use to solve problems.

1. Counts all to find the total of two collections.
2. Counts on from one number to find the total of two collections.
3. Given subtraction situations, chooses appropriately from strategies including count back, count down to & count up from.
4. Uses basic strategies for solving addition and subtraction problems (doubles, commutativity, adding 10, tens facts, other known facts).
5. Uses derived strategies for solving addition and subtraction problems (near doubles, adding 9, build to next ten, fact families, intuitive strategies).
6. Extending and applying. Given a range of tasks (including multi-digit numbers), can use basic, derived and intuitive strategies as appropriate.

Each Growth Point represents substantial expansion in knowledge along paths to mathematical understanding (Clarke, 2001). They enable teachers to: identify any children who may be vulnerable in a given domain, identify the zone of proximal development for each child in each domain so instruction may be customised and precise, and identify the diversity of mathematical knowledge in a class. The whole number tasks in the interview take between 15-25 minutes for each student and are administered by the classroom teacher. There are about 40 tasks in total, and given success with a task, the teacher continues with the next tasks in a domain (e.g., Place Value) for as long as the child is successful. Teachers report that the *Early Numeracy Interview* (ENI) provided them with insights about students' mathematical knowledge that might otherwise remain hidden (Clarke, 2001). This was an important reason for using the ENI as part of the *Bridging the Numeracy Gap* project.

The Extending Mathematical Understanding (EMU) program

Another key aspect of the approach used in the *Bridging the Numeracy Gap Project* was providing the opportunity for students who were mathematically vulnerable to participate in an EMU program. This is a series of lessons specifically designed by a specialist teacher for the purpose of accelerating students' learning. Groups of three students participate in these lessons for 30-minutes per day, 5 days per week for a total of 25-50-hours depending on student progress. Each lesson centres on whole number learning with specific focuses on quantity (counting and place value), investigations involving addition, subtraction, multiplication, and division problems with an emphasis on the development of reasoning strategies, reflection on learning, and a home task. The EMU program, also used by most schools involved in the ENRP, is taught by specially qualified teachers who have completed a course (at Masters level) that includes 36 hours of course work, a minimum of 25 hours of field-based learning, and a program of professional reading.

An Approach for Improving Mathematics Learning at School A

This paper examines the mathematics learning outcomes for students belonging to a school known as School A and compares progress in learning to students participating in the ENRP. This school is part of a regional Victorian town that is listed by the State Government as one of the five-most disadvantaged communities in the state, and has an enrolment of 200 students who are educated across nine classrooms. Of the Prep-Grade 2 students participating in this project, 28% of their families receive the Education Maintenance allowance, no students have language backgrounds other than English, and no students have severe language difficulties. Only one Prep student has a disability. At the beginning of 2009, 48% of Grade 1 students and 50% of Grade 2s were identified as being vulnerable in at least one number domain. Three of the four Prep-Grade 2 classroom teachers and the Mathematics Co-ordinator were qualified as EMU teachers, and the Mathematics Co-ordinator implemented an EMU program in 2009.

For the past eight years, the school has been implementing a whole school approach to improving mathematics learning guided by the design elements of the Hill and Crévola model (1997). Important features of this approach have been the appointment of a school mathematics co-ordinator to provide curriculum leadership, assessment by the classroom teachers of all students at the beginning of each year using the *Early Numeracy Interview* and the associated Growth Point framework, identification of mathematically vulnerable students, professional learning team meetings during which issues associated with learning and teaching mathematics are discussed, and implementation of the *Extending Mathematical Understanding* (EMU) Program for some Year 1 mathematically vulnerable students.

In 2009, the school agreed to participate in the *Bridging the Numeracy Gap in Low SES and Indigenous communities Pilot Project*. This enabled the school to increase the number of students who participated in an EMU Program, and highlighted the importance of the EMU specialist teacher also working in partnership with classroom teachers for the purpose of designing, implementing and monitoring the impact of individual learning plans for vulnerable students, and participating in professional learning team meetings to provide leadership, advice and professional learning opportunities for classroom teachers.

The purpose of this paper is to determine whether these activities had an effect on the students' mathematics outcomes, as measured by the ENRP Growth Point framework.

Another purpose was to compare the Growth Point distributions of students in School A to that of the ENRP distributions that were representative of Victorian students. This would enable the research team to determine whether or not the Growth Point distributions for students in this very low SES community were similar to Growth Point distributions that were representative of Victorian students.

Children's Whole Number Knowledge

When Beginning School

One key issue for this research was to determine whether the whole number knowledge of students beginning school in this low SES community is similar to the knowledge of students overall. For this purpose the Growth Point distribution of Prep students in School A ($n=18$) was compared to that of the representative ENRP distribution ($n=1711$). Figure 1 shows the distributions for counting knowledge at the beginning and end of the year.

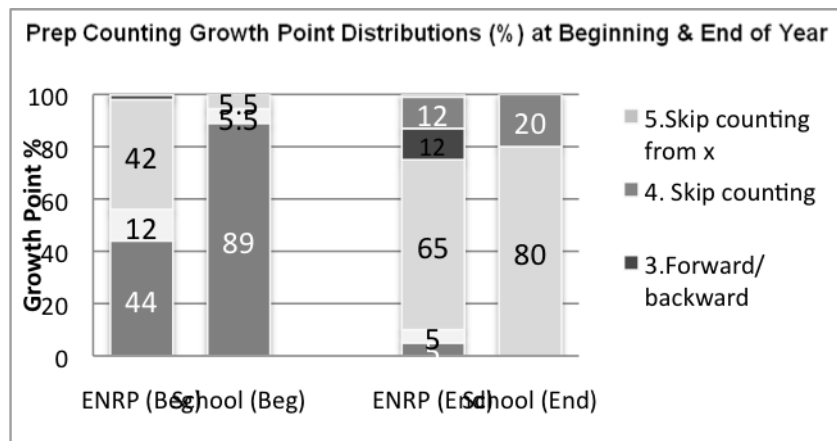

Figure 1. Counting Growth Point Distributions (%) for ENRP (1999) and School A (2009) Prep Students at the beginning and end of the year

The Growth Point distributions for students when they first begin school indicate a large difference between the two groups, with double the proportion of School A students (89%) not yet able to rote count to 20. Further, more than 40% of the ENRP Preps could count a collection of 20 items, compared with hardly any School A students. This data suggests that Prep students at School A have had less experience with school-like counting activities prior to commencing formal schooling, and that becoming familiar with number names and counting sequences will be an important focus of their initial curriculum.

Similar comparisons were made for the domains of Place Value, Multiplication and Division Strategies, and Addition and Subtraction Strategies. However, the Growth Point distributions for School A and ENRP students in these domains were all similar. These comparisons lead to the question as to why such large differences exist between the groups in counting and not in the other domains. One explanation may be that children in this low SES community encounter numbers greater than ten less often than students in other communities. Thus a recommendation for School A is to provide Prep students with many rich opportunities to encounter and explore numbers beyond ten.

Learning Outcomes after One Year at School

The *Bridging the Numeracy Gap Project* enabled School A to allocate more time for the Mathematics Co-ordinator to work with classroom teachers to assist with analysing their ENI data to identify mathematically vulnerable students, to refine their classroom programs to meet the needs of each individual, and to develop their professional knowledge during professional learning team meetings. Examination of the students' Growth Points at the end of Prep demonstrated that they had made significant progress. Figure 1 also shows School A's Prep ($n=15$) Counting Growth Point distributions at the end of the year compared to the ENRP Prep cohort ($n=1675$). The data show that the School A students made good progress in Counting over the year, despite the fact that few students at the beginning could rote count to 20 (Figure 1). By the end of the year the Growth Point distributions were very similar, and this suggests that the school program was successful in bridging the knowledge gap. Figure 2 compares the Growth Point distributions for Addition and Subtraction Strategies of the Prep students at the beginning and end of the year.

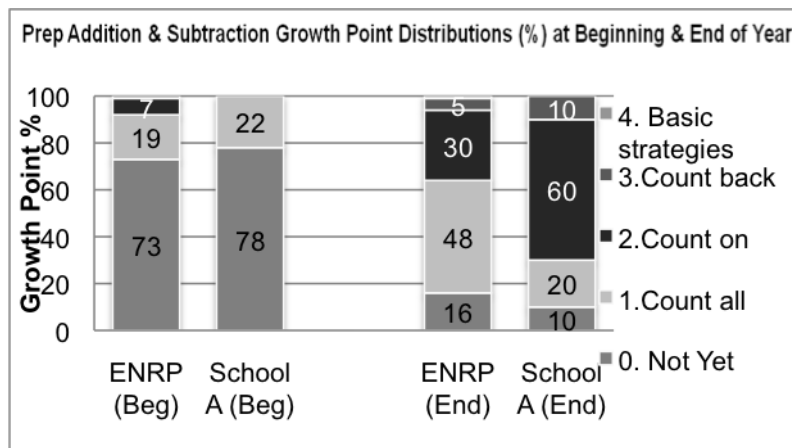

Figure 2. Prep Addition & Subtraction Strategies Growth Point Distributions for ENRP and School A students at the beginning and end of the year

These data suggest that the students in School A ($n=18$) progressed considerably further over the year than did the ENRP cohort ($n=1702$). Seventy percent of School A Preps could at least use the count-on strategy in an addition problem ($9+4$), compared with only 35% of ENRP Preps. This suggests that the Prep program in School A was highly effective in assisting students to develop addition strategies. However, it must be noted that for each domain, there were one or two children at School A, who made little progress in relation to the Growth Point framework across the year.

Progress for Grade 1 Students

An important feature of the Grade 1 mathematics program at School A was the opportunity for mathematically vulnerable students to participate in the *Extending Mathematical Understanding* (EMU) Program, a series of lessons specifically designed and implemented by a specialist teacher. Participation in the Pilot Project meant that School A could offer this opportunity to more students than in previous years.

Figure 3 shows the Counting Growth Point distributions at the beginning and end of Grade 1 for three groups of students: the ENRP cohort in 1999 ($n=1662$), School A students ($n=23$), and School A students who participated in an EMU program ($n=9$).

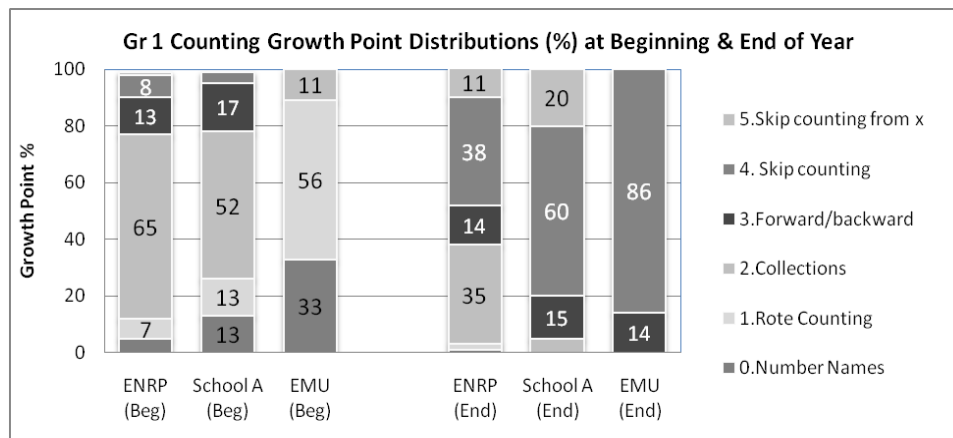

Figure 3. Grade 1 Counting Growth Point Distributions for ENRP (1999), School A (2009) and EMU (2009) students at the beginning and end of the year.

The data show that although a greater proportion of School A students began the academic year on Growth Points 0 or 1, compared with the ENRP students, the students in School A made greater progress overall. Indeed, 80% of School A students compared with 49% of ENRP students reached Growth Points 4 and 5 by the end of the year. Similarly, the students participating in the EMU program all progressed well in counting, with the majority of students reaching Growth Point 4. This suggests that the approach in School A was highly effective for the most mathematically vulnerable students also.

Grade 1 students in School A also made good progress in the other whole number domains. Figure 4 shows the Growth Point distributions for Addition and Subtraction Strategies as an illustrative example.

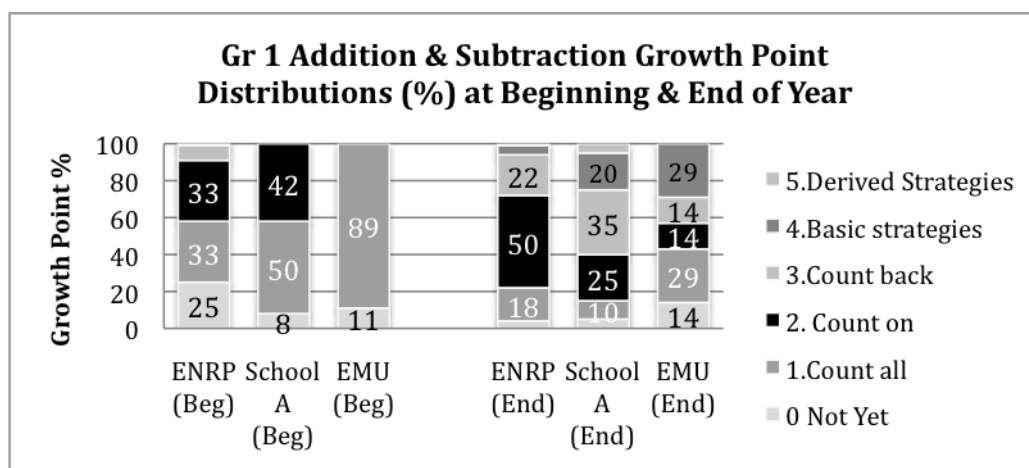

Figure 4. Addition & Subtraction Strategies Growth Point Distributions for Grade 1 ENRP (1999), School A (2009) and EMU (2009) students at the beginning and end of the year.

Figure 4 shows that at the start of the year most students in School A ($n=23$) could at least use the count-all strategy to solve an addition problem, compared with only 75% of ENRP students ($n=1658$), but that none of the EMU students ($n=9$) used the count-on strategy. By the end of the year, about 60% of School A students ($n=20$) and 40% of the

EMU students ($n=7$) were using the count-back strategy or basic reasoning strategies, compared to only 30% of ENRP students ($n=1603$). This indicates a considerable advance for School A students, with only three students not yet using the count-on strategy.

In evaluating the impact of the *Bridging the Numeracy Gap* project on the school community in 2009, the views of the Principal and Numeracy Leader were sought. The Principal made the following statement.

“In light of our school’s context (Low SES community) we were fortunate to fit within the criteria of the Bridging the Numeracy Gap Project and we have been able to strengthen the positive work that we had already begun. In particular the project has enabled:

- All teachers (P-6) to use the [Early Numeracy] Interview to target children’s needs;
- All teachers to be more proficient in analysing data (ENI/NAPLAN/Pupil reports) to identify issues and areas of growth;
- All teachers to increase their understanding of numeracy pedagogy, via PLT (Professional Learning Team) meetings each fortnight and coaching support from the Numeracy leader;
- Up-skilling of all teachers in numeracy practices, i.e.: 3 out of 4 junior school teachers are EMU trained. Thus, improving classroom teaching and reducing the number of children needing additional support;
- Sufficient leadership support in mathematics;
- Our school to raise the profile of numeracy;
- Our school to increase the number of students who can access the EMU program;
- Significant improvements in [maths] outcomes (Assessment tool/NAPLAN/My School/ reports);

The EMU teacher explained that the impact of the Pilot extended to families also.

“The EMU Program has earned a positive reputation in our school with many families keen to know what we are actually doing and how they can support their children at home. Last year (2009) we ran a very successful evening for families and students focusing on the development of mental computation strategies. As part of this evening we also invited the students to ‘teach’ their families some of the rich activities they use in the classroom with their teacher. All families went home with a gift bag containing simple items/activity boards that they could use at home with their children. The response was very positive, with families feeding back that they feel more able to support their child.”

These comments suggest that the Project has both enhanced the learning environment for students, and increased the capacity of the entire school community to enable children to learn mathematics successfully.

Conclusion

The Counting Growth Point data for School A Prep students confirms previous research findings that the mathematical knowledge of children in low SES communities when students begin school is lower than for their peers overall (Griffin & Case, 1997). This does not mean that these students are less able, but suggests that some students’ home environments may not provide them with the type of experiences that prepare them for learning school mathematics. Further, students’ informal mathematical knowledge may be culturally specific, and not be obvious to the teacher during the assessment process (Zevenbergen & Niesche, 2008).

The school community described in this paper has an expert Mathematics leader who provides specialised mathematics programs for mathematically vulnerable students, and works in partnership with classroom teachers to design individual learning plans, and classroom mathematics programs that cater for the diverse range of students’ learning needs. This collaborative and rigorous approach for designing highly effective learning environments is having a positive impact on mathematics learning and instruction.

The findings from this research demonstrate that school communities in low SES areas can “bridge the numeracy gap” in the early years of schooling through providing rich learning environments and specialised instruction for students. Australians rely on schools and teachers in these communities to provide students with an education that enables them to shake off the shackles of poverty and marginalisation.

References

- Clarke, D. (2001). Understanding, assessing and developing young children's mathematical thinking: Research as powerful tool for professional growth. In J. Bobis, B. Perry & M. Mitchelmore (Eds.), *Numeracy and beyond: Proceedings of the 24th Annual Conference of the Mathematics Education Research Group of Australasia* (Vol. 1, pp. 9-26). Sydney: MERGA.
- Clarke, D., Cheeseman, J., Gervasoni, A., Gronn, D., Horne, M., McDonough, A., Montgomery, P., Roche, A., Sullivan, P., Clarke, B., & Rowley, G. (2002). *ENRP Final Report*. Melbourne: Australian Catholic University.
- Commonwealth of Australia (2008). *National numeracy review report*. Retrieved 18 March 2010, from COAG Web site: http://www.coag.gov.au/reports/docs/national_numeracy_review.pdf.
- Department of Education Employment and Training. (2001). *Early numeracy interview booklet*. Melbourne: Department of Education, Employment and Training.
- Fuson, K. (1992). Research on whole number addition and subtraction. In D. A. Grouws (Ed.), *Handbook of research on mathematics teaching and learning* (pp. 243-275). New York: Macmillan.
- Gervasoni, A. (2004). *Exploring an intervention strategy for six and seven year old children who are vulnerable in learning school mathematics*. Unpublished PhD thesis, La Trobe University, Bundoora.
- Gervasoni, A., Hadden, T., & Turkenburg, K. (2007). Exploring the number knowledge of children to inform the development of a professional learning plan for teachers in the Ballarat diocese as a means of building community capacity. In J. Watson & K. Beswick (Eds), *Mathematics: Essential Research, Essential Practice Hobart: MERGA* (Proceedings of the 30th annual conference of the Mathematics Education Research Group of Australasia, 305-314). Hobart: MERGA.
- Gervasoni, A., & Sullivan, P. (2007). Assessing and teaching children who have difficulty learning arithmetic. *Educational & Child Psychology*, 24(2), 40-53.
- Gould, P. (2000). Count Me In Too: Creating a choir in the swamp. In *Improving numeracy learning: What does the research tell us?* (Proceedings of the ACER Research Conference 2000, pp. 23–26). Melbourne: Australian Council for Educational Research.
- Griffin, S., & Case, R. (1997). Re-thinking the primary school math curriculum: An approach based on cognitive science. *Issues in Education*, 3(1), 1-49.
- Hill, P. W., & Crévola, C. A. (1999). The role of standards in educational reform for the 21st century. In D. D. Marsh (Ed.), *Preparing our schools for the 21st century* (Association of Supervision and Curriculum Development Yearbook, pp. 117-142). Alexandria, VA: ASCD.
- Mulligan, J. (1998). A research-based framework for assessing early multiplication and division. In C. Kanes, M. Goos & E. Warren (Eds.), *Teaching mathematics in new times* (Proceedings of the 21st annual conference of the Mathematics Education Research Group of Australasia, Vol. 2, pp. 404-411). Brisbane: MERGA.
- Steffe, L., von Glasersfeld, E., Richards, J., & Cobb, P. (1983). *Children's counting types: Philosophy, theory, and application*. New York: Praeger.
- Wright, R., Martland, J., & Stafford, A. (2000). *Early numeracy: Assessment for teaching and intervention*. London: Paul Chapman Publishing.
- Zappalà, G. (2003). *Barriers to participation: Financial, educational and technological. A report into the barriers to societal participation among low-income Australians*. Camperdown, NSW: The Smith Family. Retrieved March 18, 2010, from http://www.thesmithfamily.com.au/webdata/resources/files/TSF_barrieries_2003.pdf
- Zevenbergen, R., & Nieske, R. (2008). *Reforming mathematics classrooms: a case of remote Indigenous education*. Working Paper No. 2, Brisbane, Qld: Griffith Institute for Educational Research, Griffith University

Auditing the Numeracy Demands of the Middle Years Curriculum

Merrilyn Goos

The University of Queensland
<m.goos@uq.edu.au>

Vince Geiger

Australian Catholic University
<vincent.geiger@acu.edu.au>

Shelley Dole

The University of Queensland
<s.dole@uq.edu.au>

The *National Numeracy Review* recognised that numeracy development requires an across the curriculum commitment. To explore the nature of this commitment we conducted a numeracy audit of the South Australian Middle Years curriculum, using a numeracy model that incorporates mathematical knowledge, dispositions, tools, contexts, and a critical orientation. All Learning Areas in the published curriculum were found to have distinctive numeracy demands. The audit should encourage teachers to promote numeracy in even richer ways in the curriculum they enact with students.

Numeracy, a term used in many English speaking countries such as the UK, Canada, South Africa, Australia, and New Zealand, was originally defined as the mirror image of literacy, but involving quantitative thinking (Ministry of Education, 1959). Another early definition (Cockcroft, 1982) described “being numerate” as possessing an ‘at-homeness’ with numbers and an ability to use mathematical skills to cope confidently with the practical demands of everyday life. In the USA and elsewhere it is more common to speak of *quantitative literacy* or *mathematical literacy*. Steen (2001) described quantitative literacy as the capacity to deal with quantitative aspects of life, and proposed that its elements included: confidence with mathematics; appreciation of the nature and history of mathematics and its significance for understanding issues in the public realm; logical thinking and decision-making; use of mathematics to solve practical everyday problems in different contexts; number sense and symbol sense; reasoning with data; and the ability to draw on a range of prerequisite mathematical knowledge and tools. The OECD’s (2004) PISA program similarly defines mathematical literacy more broadly than earlier descriptions of numeracy as:

an individual’s capacity to identify and understand the role mathematics plays in the world, to make well-founded judgments, and to use and engage with mathematics in ways that meet the needs of that individual’s life as a constructive, concerned and reflective citizen. (p. 15)

Steen (2001) maintained that, for numeracy to be useful to students, it must be learned in multiple contexts and in all school subjects, not just mathematics. Although this is a challenging notion, a recent review of numeracy education undertaken by the Australian government (Human Capital Working Group, Council of Australian Governments, 2008) concurred, recommending:

That all systems and schools recognise that, while mathematics can be taught in the context of mathematics lessons, the development of numeracy requires experience in the use of mathematics beyond the mathematics classroom, and hence requires an across the curriculum commitment. (p. 7)

What such an “across the curriculum commitment” might look like is the subject of this paper. In 2009 we conducted a yearlong study that investigated approaches to help teachers plan and implement numeracy strategies across all Learning Areas in the South Australian school curriculum in Years 6-9. Before beginning our work with teachers, we conducted an audit of the published curriculum framework (Department of Education and



Children’s Services, 2005). This paper addresses the question that guided our audit: What are the inherent numeracy demands of each of the seven Learning Areas (other than Mathematics)? We begin by presenting the numeracy model we developed to synthesise and extend previous work in this area. This is followed by an outline of the audit methodology. A sample evaluation of one Learning Area demonstrates how we conducted the audit. Findings from the entire audit are then summarised, with a discussion of implications for teachers.

Numeracy Model

In Australia, educators and policy makers have embraced a broad interpretation of numeracy similar to the OECD definition of mathematical literacy. For example, the report of a 1997 national numeracy conference proposed: “To be numerate is to use mathematics effectively to meet the general demands of life at home, in paid work, and for participation in community and civic life” (Australian Association of Mathematics Teachers, 1997, p. 15). This definition became widely accepted in Australia and formed the basis for much numeracy-related research and curriculum development.

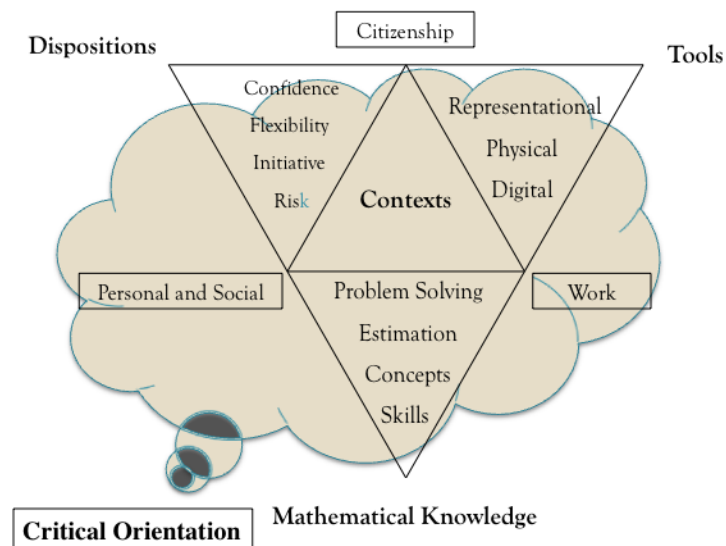

Figure 1. A model for numeracy in the 21st century.

Recently, however, Goos (2007) argued that a description of numeracy for new times needs to better acknowledge the rapidly evolving nature of knowledge, work, and technology. She developed the model shown in Figure 1 to represent the multi-faceted nature of numeracy in the twenty-first century. This model was designed to capture the richness of current definitions of numeracy while introducing a greater emphasis on tools as mediators of mathematical thinking and action. While the model was intended to be readily accessible to teachers as an instrument for planning and reflection, its development was also informed by relevant research, as outlined below.

A numerate person requires *mathematical knowledge*. Internationally, there seems to be agreement that all children are entitled to democratic access to powerful mathematical ideas so that they have the knowledge, skills, and understanding to become educated citizens (Malloy, 2002). In a numeracy context, mathematical knowledge includes not only concepts and skills, but also problem solving strategies and the ability to make sensible estimations (Zevenbergen, 2004).

A numerate person has *positive dispositions* – a willingness and confidence to engage with tasks, independently and in collaboration with others, and apply mathematical knowledge flexibly and adaptively. Affective issues have long been held to play a central role in mathematics learning and teaching (McLeod, 1992), and the importance of developing positive attitudes towards mathematics is emphasised in national and international curriculum documents (e.g., National Council of Teachers of Mathematics, 2000; National Curriculum Board, 2009).

Being numerate involves using *tools*. Sfard and McClain (2002) discuss ways in which symbolic tools and other specially designed artefacts “enable, mediate, and shape mathematical thinking” (p. 154). In school and workplace contexts, tools may be representational (symbol systems, graphs, maps, diagrams, drawings, tables, ready reckoners), physical (models, measuring instruments), and digital (computers, software, calculators, internet) (Noss, Hoyles, & Pozzi, 2000; Zevenbergen, 2004).

Because numeracy is about using mathematics to act in and on the world, people need to be numerate in a range of *contexts* (Steen, 2001). For example, a numerate person can organise finances, make decisions affecting their personal health, and engage in leisure activities that require numeracy knowledge. All kinds of occupations require numeracy, and many examples of work-related numeracy are specific to the particular work context (Noss et al., 2000). Informed and critical citizens need to be numerate citizens. Almost every public issue depends on data, projections, and the kind of systematic thinking that is at the heart of numeracy. Different curriculum contexts also have distinctive numeracy demands, so that students need to be numerate across the range of contexts in which their learning takes place at school (Steen, 2001).

This model is grounded in a *critical orientation* to numeracy since numerate people not only know and use efficient methods, but also evaluate the reasonableness of the results obtained and are aware of appropriate and inappropriate uses of mathematical thinking to analyse situations and draw conclusions. In an increasingly complex and information drenched society, numerate citizens need to decide how to evaluate quantitative, spatial or probabilistic information used to support claims made in the media or other contexts. They also need to recognise how mathematical information and practices can be used to persuade, manipulate, disadvantage or shape opinions about social or political issues (Frankenstein, 2001).

Evaluating the Numeracy Demands of Learning Areas

We were commissioned to conduct a numeracy audit of the South Australian Curriculum, Standards and Accountability (SACSA) Framework (DECS, 2005). The Curriculum Scope is organised around Learning Areas, each of which is defined by Strands comprising Key Ideas that increase in complexity through the years of schooling and Standards that represent expectations of learners. The audit evaluated the numeracy demands of the Arts, Design and Technology, English, Health and Physical Education, Languages, Science, and Society and Environment Learning Areas for the Middle Years (Years 6 to 9), as represented by the relevant Curriculum Scope and Standards statements provided in the SACSA Framework.

Numeracy demands of each Learning Area were evaluated by reference to the elements of the numeracy model in Figure 1. Mathematical knowledge demands were examined by assessing the extent to which the target Learning Area drew on the five Strands of the Mathematics Learning Area of the SACSA Framework: *exploring, analysing and modelling data; measurement; number; patterns and algebraic reasoning; and spatial*

sense and geometric reasoning. A sample evaluation of the numeracy demands of the Society and Environment Learning area illustrates how we carried out the audit of the whole curriculum.

Numeracy Demands: Society and Environment

Mathematical Knowledge

Figure 2 maps numeracy learning demands in Society and Environment onto the Mathematics strands of the SACSA Framework. Shading is used to indicate low (unshaded), moderate, (light shading), and high (dark shading) levels of numeracy learning demands.

Society and Environment Strands	Mathematics Strands				
	Exploring, analysing & modelling data	Measurement	Number	Patterns & algebraic reasoning	Spatial sense & geometric reasoning
Time, continuity & change					
Place, space & environment					
Societies & cultures					
Social systems					

Figure 2. Mathematical knowledge demands within strands of the Society and Environment Learning Area.

The need to make decisions and adopt positions based on evidence and take a data driven approach to argumentation means the mathematical strands of exploring, analysing and modelling data, measurement, and spatial sense and geometric reasoning are particularly relevant. Students can demonstrate changes to aspects of the environment, for example, the rate of deforestation in developing countries, through reference to available data, or consider the advantages of different architectural designs for built environments in hot dry climates.

Contexts

According to the SACSA Framework (DECS, 2005), the study of Society and Environment aims to assist learners to understand the processes that lead to change in the world and, in doing so, to empower them to act in the shaping of the society and environment into which they will grow. The Framework outlines a wide range of contexts that align with students' current and future lives at school, work, and in the community:

The complexities and contradictions arising from rapidly changing technologies; unequal distribution of wealth and power; global interdependence; the dynamic nature of social, economic, political and ecological systems; the changing nature of work, and social practices around paid and unpaid work; and the need for increasingly sustainable social and environmental management practices bring challenges to people in all societies. The concepts and processes employed in society and environment enable learners to think clearly about current issues confronting them and their world. (p. 291)

Dispositions

Students are expected to develop dispositions enabling them “to be active citizens who can make informed and reasoned decisions and act on these” (DECS, 2005, p. 291). While

there is an obvious connection between this aim and the need for mathematically valid approaches to collecting and analysing data, teachers should not assume that the study of Society and Environment would automatically ensure that students develop positive dispositions towards mathematics. Explicit attention also needs to be given to development of mathematical confidence in using appropriate techniques for dealing with problems in real life contexts.

Tools

The use of tools to collect and then analyse the information necessary for a critical approach to decision making is vital to this Learning Area. These tools include representational, physical, and digital tools such as:

- maps and charts for identifying the characteristics of a specific environment (e.g., contours, the paths and interconnectedness of river systems);
- plans for built environments;
- instruments for measuring location and position (e.g., GPS systems and surveying tools);
- on-line data sources (e.g., archival records of rainfall in specific catchment areas);
- digital tools such as spreadsheets or software applications developed specifically for the analysis and representation of data.

Critical Orientation

As the ultimate goal of learning through Society and Environment is to enable students to participate as ethical, active and informed citizens, a critical orientation to viewing information and an analytical approach to the interpretation of data must be embedded within this Learning Area.

Summary of Numeracy Audit Findings

Mathematical Knowledge

Figure 3 synthesises the mathematical knowledge requirements of the seven Learning Areas apart from Mathematics itself. The synthesis was carried out by combining the mappings of numeracy learning demands of each strand in each Learning Area onto the Mathematics Strands. For each of the latter mappings, scores of 2 were allocated for strands with high numeracy demands (dark shading), 1 for strands with moderate numeracy demands (light shading), and 0 for strands with low numeracy demands (unshaded). These scores were then tallied, by Mathematics Strand, for each Learning Area. The total scores for Science Strands were scaled by a factor of 0.75, since Science has four Strands whereas the other Learning Areas have only three Strands each. This procedure resulted in each cell of Figure 3 having a score between 0 and 6. No shading of cells represents low numeracy demand (score of 0-1), light shading represents moderate numeracy demand (score of 2-4), and dark shading high numeracy demand (score of 5-6).

Learning Area	Mathematics Strands				
	Exploring, analysing & modelling data	Measurement	Number	Patterns & algebraic reasoning	Spatial sense & geometric reasoning
Arts	Dark Grey	Light Grey	Light Grey	Light Grey	Dark Grey
Design & Technology	Dark Grey	Dark Grey	Dark Grey	Dark Grey	Dark Grey
English	Light Grey	Light Grey	White	White	Light Grey
Health & Physical Education	Light Grey	Light Grey	Light Grey	Light Grey	White
Languages	White	Light Grey	Light Grey	White	Light Grey
Science	Dark Grey	Dark Grey	Dark Grey	Light Grey	Light Grey
Society & Environment	Dark Grey	White	Light Grey	Light Grey	Light Grey

Figure 3. Mathematical knowledge demands within the Learning Areas of the SACSA Framework.

The level of numeracy demand is highest for Design and Technology, Science, and the Arts; moderate for Society and Environment and Health and Physical Education; and lowest for English and Languages. Despite these differences, however, it is important to recognise that *all* Learning Areas have distinctive numeracy demands in relation to the type of mathematical knowledge required by students in order to demonstrate successful learning. Teachers are ultimately responsible for enacting the curriculum in their classrooms, and they can therefore exploit numeracy learning opportunities in the Learning Areas beyond those implied by the published curriculum.

The strands of mathematical knowledge are also represented to different degrees in the Learning Areas. *Exploring, Analysing and Modelling Data* is most strongly represented in the intended curriculum, followed by *Measurement*, *Number*, and *Spatial Sense and Geometric Reasoning*, with the strand of *Patterns and Algebraic Reasoning* the least strongly represented. It is perhaps not surprising that algebra, as an element of numeracy knowledge, appears to be under-represented in the curriculum as it may be thought that algebraic ideas are abstract and have little connection with real world contexts or Learning Areas other than Mathematics. Nevertheless, it is worth emphasising the potential connection between algebraic reasoning and modelling with data since exploration of patterns and generality in the middle years of schooling can begin with an empirical focus on data collection and analysis.

Contexts

The range of numeracy learning contexts highlighted in the numeracy model of Figure 1 is well represented across the Learning Areas. Each emphasises the value of connecting students' learning to real life contexts that are meaningful for them, whether this involves personal interests, family and community life, leisure pursuits, the physical environment, vocations and careers, diverse cultures, or social, economic, and political systems.

Dispositions

Throughout the SACSA Framework there is evidence of a desire to develop positive dispositions such as perseverance, confidence, resilience, willingness to take risks and show initiative, respect for cultural diversity, and commitment to ecological sustainability. These are admirable goals, but we would argue that dispositions towards learning in one discipline do not automatically transfer to another discipline: it is possible, for example, for students to feel confident about their learning in the Arts but not in Mathematics and not in relation to numeracy more generally. Teachers need to be aware of the damaging effects of negative mathematical dispositions, to look for opportunities to successfully engage their students with the numeracy demands of their Learning Area, and to make explicit to students the positive dispositions that are helping them to achieve this success.

Tools

Representational, physical, and digital tools are used across all Learning Areas. Some of these are specific to the discipline while others are more generically useful. Graphs, diagrams, tables, maps, and plans are commonly used in many Learning Areas, as are measuring instruments, both physical and digital. There is also a strong emphasis on digital tools, software, and web resources. Thus all Learning Areas have specific numeracy demands in relation to accurate and intelligent use of tools to represent and analyse ideas. Students need to become proficient with the tools of each Learning Area, but they also need to be aware that some tools are used in more than one Learning Area and to be flexible in applying tools in different curricular contexts. For example, students may come to believe that Mathematics and Society and Environment promote different approaches to reading and creating maps, or that Science and Health and Physical Education promote different ways of creating graphs that show relationships between variables. Teachers in these Learning Areas need to be aware of any differences in techniques and terminologies associated with the use of these representational tools and to draw students' attention to important similarities between underlying concepts.

Critical Orientation

The SACSA Framework emphasises developing a critical orientation in students across all Learning Areas. Such an orientation cannot be fully enabled without numeracy knowledge, dispositions, and tools, nor can it be convincingly enacted unless learning takes place in a range of real life contexts. Conversely, being numerate requires adopting a critical stance in order to question, compare, analyse, and consider alternatives. The numeracy demands inherent in the Learning Areas should facilitate development of this critical orientation.

Conclusion

The audit of the SACSA Framework for the Middle Years found that all Learning Areas have distinctive numeracy demands in relation to mathematical knowledge, contexts, dispositions, tools, and development of a critical orientation. While the audit was necessarily restricted to the published curriculum framework, by highlighting the ubiquitous nature of numeracy throughout this *intended* curriculum it has opened a window of opportunity for teachers to promote numeracy in even richer ways in the curriculum that they *enact* with students in their classrooms. Developing an appreciation of the numeracy

demands of the intended curriculum, as outlined in this audit, may help teachers become more attuned to the numeracy demands – and opportunities – presented by any learning task in which their students are engaged.

At the time of writing this paper the first Draft Consultation version of the Australian Curriculum in Mathematics K-10 had just been released for comment by the mathematics education community. Numeracy is one of the “general capabilities” to be specifically covered in the curriculum as a fundamental responsibility of mathematics and for application in other learning areas. It remains to be seen as to how successfully the final version of the curriculum achieves this aim through its content statements and achievement standards.

References

- Australian Association of Mathematics Teachers (1997). *Numeracy = everyone's business. Report of the Numeracy Education Strategy Development Conference*. Adelaide: AAMT.
- Cockcroft, W. (1982). *Mathematics counts*. London: HMSO.
- Department of Education and Children's Services (2005). *South Australian curriculum, standards and accountability framework*. Retrieved 11 March 2010 from <http://www.sacsa.edu.au>.
- Frankenstein, M. (2001). *Reading the world with math: Goals for a critical mathematical literacy curriculum*. Keynote address delivered at the 18th biennial conference of the Australian Association of Mathematics Teachers, Canberra.
- Goos, M. (2007). *Developing numeracy in the learning areas (middle years)*. Keynote address delivered at the South Australian Literacy and Numeracy Expo, Adelaide.
- Human Capital Working Group, Council of Australian Governments (2008). *National numeracy review report*. Retrieved 12 January 2010 from http://www.coag.gov.au/reports/docs/national_numeracy_review.pdf
- Malloy, C. (2002). Democratic assess to mathematics through democratic education: An introduction. In L. English (Ed.), *Handbook of international research in mathematics education* (pp.17-25). Mahwah, NJ: Lawrence Erlbaum.
- McLeod, D. (1992). Research on affect in mathematics education: A reconceptualization. In D. Grouws (Ed.), *Handbook of research on mathematics teaching and learning* (pp. 575-596). New York: Macmillan.
- Ministry of Education (1959). *15 to 18: A report of the Central Advisory Council for Education*. London: HMSO.
- National Council of Teachers of Mathematics (2000). *Principles and standards for school mathematics*. Reston, VA: NCTM.
- National Curriculum Board (2009). *Shape of the Australian curriculum: Mathematics*. Retrieved 12 January 2010 from http://www.acara.edu.au/verve/_resources/Australian_Curriculum_-_Maths.pdf
- Noss, R., Hoyles, C., & Pozzi, S. (2000). Working knowledge: Mathematics in use. In A. Bessot & J. Ridgeway (Eds.), *Education for mathematics in the workplace* (pp. 17-35). Dordrecht, The Netherlands: Kluwer.
- Organisation for Economic Cooperation and Development (2004). *Learning for tomorrow's world: First results from PISA 2003*. Paris: OECD.
- Sfard, A., & McClain, K. (2002). Analyzing tools: Perspectives on the role of designed artifacts in mathematics learning. *The Journal of the Learning Sciences*, 11(2&3), 153-161.
- Steen, L. (2001). The case for quantitative literacy. In L. Steen (Ed.), *Mathematics and democracy: The case for quantitative literacy* (pp. 1-22). Princeton, NJ: National Council on Education and the Disciplines.
- Zevenbergen, R. (2004). Technologising numeracy: Intergenerational differences in working mathematically in new times. *Educational Studies in Mathematics*, 56, 97-117.

The Terminology of Mathematics Assessment

Jane Greenlees
Charles Sturt University
<jgreenlees@csu.edu.au>

Standardised testing has received a lot of political and public attention recently in Australia. This paper describes the sense-making of Year 3 students as they interpret items from the 2008 NAPLAN. Results show that student performance changed dramatically when the terminology of an item was modified and subsequently were not a true indication of student mathematical knowledge and understanding. Implications include the need for test designers to carefully consider the terminology included within assessment items and the need for comprehensive analysis of student results.

The introduction of the 2008 National Assessment Program – Literacy and Numeracy (NAPLAN) - across schools in all states and territories heralds a new era in Australian education. Just like reforms and policy changes before, the NAPLAN was deemed necessary to “better the nation’s competitive edge” (Webb, 1992, p.661) and hold teachers and schools accountable for student results. Therefore with such high stakes involved it is important that test results are a reliable and credible representation of student’s knowledge and understanding. But “how well do current standardised mathematics tests reflect the extent and nature of mathematical knowledge and ability that students have?” (Kulm, 1991, p. 72).

Although national standardised testing is new to the Australian education system, the concept of mandatory numeracy tests is not. Nevertheless, what has incrementally changed in the past 10 years is what numeracy is being assessed and particularly the nature and composition of the assessment tasks (Lowrie & Diezmann, 2009). Additionally the idea of making mathematics ‘real’ and relevant by incorporating ‘everyday’ contexts has been a growing trend in schools in the past 30 years (Boaler, 1994). The nationally agreed Statements of Learning (NSL) in mathematics outline in its Year 3 Working Mathematically that students will “actively investigate everyday situations as they identify and explore mathematics” (MCEETYA, 2006, p. 5). It is believed that such an approach would help students realise the relevance of maths as it is applied to their world outside the classroom.

As a result, test designers are attempting to make questions more realistic and possibly authentic but whether this is problematic is yet to be seen. Test items therefore have moved beyond simple word problems and algorithms.

The Four Components of Assessment Items

There are four components of assessment items that need to be implicitly taught within the classroom for student success. These include mathematical content, literacy demand/terminology, contextual understanding and graphics (see Figure 1).

Mathematical content can be defined as the core elements children are taught throughout their school career as outlined in state and territory curriculums. The role of assessment therefore is to examine these mathematical understandings and concepts. However research has found that often other components of a test item, resulting from an attempt to make them more realistic, confound these understandings, thus affecting a child’s performance (see, for example, Abedi & Lord, 2001; Boaler, 1994; Logan &



Greenlees, 2008). In such situations, students tend to use prior knowledge and understanding of general contexts and previous experience to shape their decision making rather than specifically focusing on the task at hand. Consequently, too much misleading information can affect performance (Logan & Greenlees, 2008).

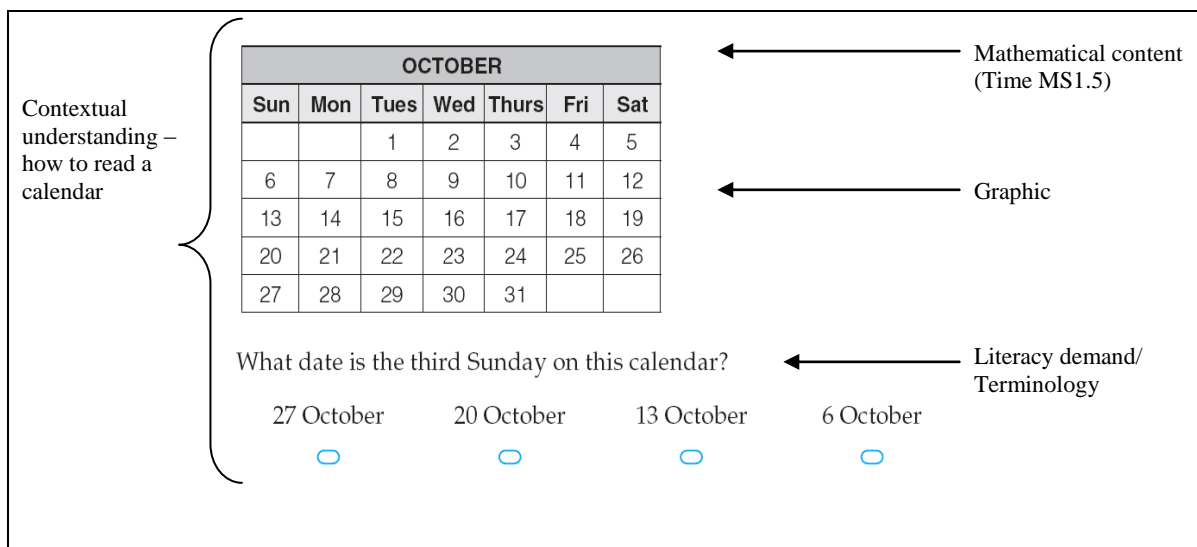

Figure 1 The four components of mathematics assessment items (MYCEETYA 2008a: Year 3 Numeracy Test, Item 12)

In Figure 1 the mathematical content being assessed according to the NSW Board of Studies K-6 Mathematics Syllabus (2002) is outcome MS1.5 – compares the duration of events using informal methods and reads clocks on the half hour. As such students should be able to identify the day and date on a calendar. However in order to do this a child must first decode the graphic according to calendar conventions, understand the context of the use of a calendar as well as comprehend specific terminology associated with the question. As a result, terminology, which is intended to be related to the task gets interpreted within a broader context. In this investigation it is argued that it is difficult to separate the context that surrounds the question from the terminology. Subsequently for an assessment item to be accessible to all students these four elements need to be valid and relevant to the mathematical construct being measured, that is, how to read a calendar. However research has found that often assessment outcomes are “confounded with nuisance variables that are unrelated to the construct” (Abedi, 2006, p. 377) thus threatening the validity of the assessment, in particular the use of unnecessary and unfamiliar terminology.

Background

Mathematics is often associated with numbers and symbols. In fact many people’s mathematical experiences and memories would include the stereotypical times tables in primary school and later on, algebraic expressions and formulae. However the shift towards making mathematics relevant has seen an increase in the literary demand placed on assessment tasks. As Thomas (1988) points out these demands involve both technical terminology and ordinary language. Teachers now have an obligation to “provide opportunities for students to strengthen their understanding of mathematics terminology and concepts” (Adams, 2003, p. 789). In fact specific mathematical terminology was explicitly defined in the NSW Department of School Education K-6 Mathematics Syllabus

(1989) so that teachers could intentionally refer to them as part of the mathematical content.

While there has been an extensive body of literature which address language in mathematics (Adams, 2003; Fuentes, 1988; Perso, 2009; Pugalee, 1999; Wakefield, 2000), Matteson (2006) notes few studies have focused on connections between mathematical literacy and achievement on mathematical assessments. Yet while teachers have some control over the mathematical terminology used in their classroom they have no influence on the unnecessary and unfamiliar linguistic structures used in an assessment task. According to Abedi (2006) it is these language barriers that can “threaten the validity and reliability of content-based assessments” (p. 380). Abedi & Lord (2001) found that minor changes in the wording of test items resulted in significant differences in mathematics performance. For example, “rewording a verbal problem can make semantic relations more explicit, without affecting the underlying semantic and content structure; thus, the reader is more likely to construct a proper problem representation and solve the problem correctly” (Abedi, 2006, p. 380). Abedi & Lord (2001) found that scores on linguistically modified mathematics tests were slightly higher than the original version. This highlights the serious impact unnecessary terminology may have on student performance. The purpose of this paper is to explore and scrutinize the terminology used in test items from the 2008 Year 3 Mathematics NAPLAN, in order to provide informed comment on the interpretation of student results.

Research Design and Methods

This investigation is the beginning of a three-year study that aims to explore the way in which test items are constructed and how this impacts on a student’s capacity to make sense of mathematics. This study will include exploring the relationship between mathematical content, mathematical terminology (mathematical literacy), graphical representations and contextual understanding. The aims of this initial component of the study were to:

1. Analyse student responses and sense-making on standardised test items through a mixed method research design.
2. Examine the effect of modified items on student performance.
3. Identify important components of a test item that positively or negatively influence the validity of student results.

The Participants

170 Year 3 students (aged 8-9 years) from 4 Catholic NSW schools participated in the quantitative phase of the study. The qualitative dimension included 40 students (10 from each school) randomly selected from the original cohort. All participants were from varying socioeconomic and academic backgrounds and participation was strictly voluntary with the available option to discontinue at any time.

Data Collection and Analysis

The following section describes the three phases of the project.

Phase 1. The initial interview. The 40 randomly selected students were interviewed on their thinking processes and strategies used when solving the 2008 NAPLAN (Test A).

Phase 2. The modification. From the interview data, students’ responses were analysed and collated to ascertain the problem-solving processes used to solve respective items. The

analysis revealed that often a correct answer was given yet an incorrect strategy was used. This highlighted an obvious misconception of what the child actually knew and what could be considered an educated guess. It was therefore assumed that by modifying the question slightly it would verify and reveal a true understanding or not. Further similarities between student's interpretations became obvious and the impact certain elements of the item including the graphic and the mathematical terminology had on student success. As a result these items were slightly redesigned without changing the complexity of the question and Test B was created. Test A and Test B were then given to the larger cohort of 170 students in random order. For example in one school Test B was administered first and then followed by Test A, while in another school Test A was before Test B. These two tests were carried out on the same day with the exception of one school where there was a two-day reprieve.

Phase 3. The re-interview. Following the large scale testing, the original 40 students were re-interviewed based on their responses to Test B. Once again these structured, in-depth interviews allowed students the opportunity to verbalise and justify the mathematical processes they used.

Results

This paper focuses on the two items that had the largest effect sizes from Test A (NAPLAN) to Test B (modified test) when the terminology was modified. Thus, this study was concerned with items where student performance (in relation to correctness) changed the most. Table 1 highlights these results.

Table 1
Students' Performances across Test A and Test B

	Item 2		Item 15	
	A	B	A	B
% Correct	95	87	44	95
Effect size (Cohen's <i>d</i>)	.31		-1.34	

Largest versus smallest

Item 2 of Test A (see Figure 2) could be considered quite easy for many of the students with no children getting it wrong in the interview and 95% correct in the mass testing.

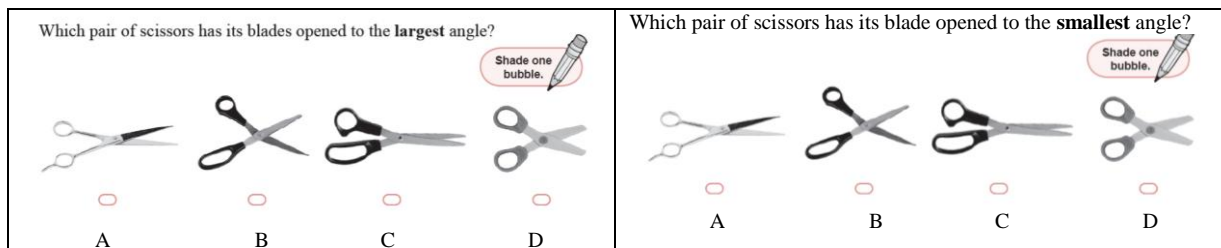

Figure 2 Test A Largest versus smallest
(MYCEETYA 2008a: Year 3 Numeracy Item 9)

Figure 3 Test B Largest versus smallest
(MYCEETYA 2008a: Year 3 Numeracy Item 9)

I chose B because that's pretty small (points to D) and that one's smaller (points to A) and that one's the smallest (points to C) [HT4].

It could therefore be assumed that most of the children had a competent understanding of the mathematical content, that is, SGS2.2.b Identifies, compares and describes angles in practical situations (Board of Studies NSW). However when students were asked to find the smallest angle instead of the largest, only 90% got it correct in the interview and 87% correct in the larger cohort.

I chose B because it is bigger than all the other acute angles. C is the smallest acute and A is the second, D is the third and B is the largest [HT4].

Now when asked to find the smallest angle (C) students still chose the largest (B). While many students were able to justify their mathematical reasoning for choosing B it was often confusing and complicated. Test B results now indicated this was an area of concern and raises questions of teacher competency. The reality is that changing the terminology, not the mathematical content, impacted negatively on student results. It could be argued that performance differed due to familiarity of the item and an automated response from the students as they failed to notice the change in wording from Test A to Test B. However, students involved in the interviews had the opportunity to read the question out loud, drawing attention to the terminology change, and still answered incorrectly to a question in which they originally had shown a competency. Thus, the likelihood of an automatic response was reduced.

Less versus Fewer

It was evident that students found it difficult interpreting some of the terminology in Test A, in particular the word “fewer” in Item 15 (see Figure 4).

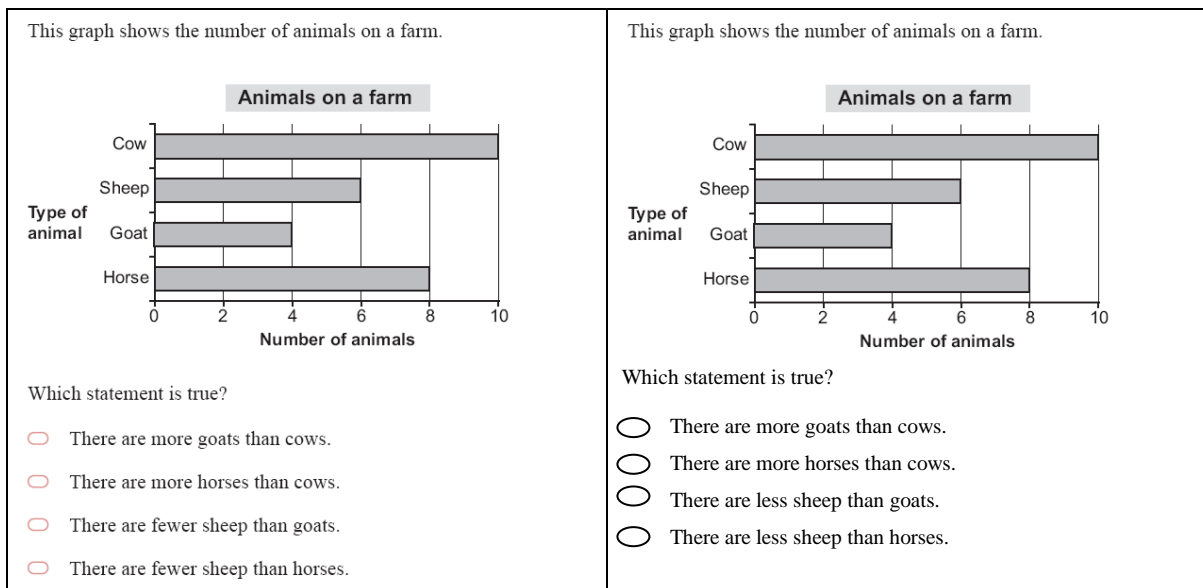

Figure 4 Test A Fewer versus less (MYCEETYA 2008a: Year 3 Numeracy Item 29)

Figure 5 Test B Fewer versus less (MYCEETYA 2008a: Year 3 Numeracy Item 29)

In fact almost half the interview cohort (48%) and over 56% of all students answered this question incorrectly, choosing answer C. When questioned on how they drew their conclusions nearly all students could successfully read the graph but simply did not understand the terminology. For example:

Because it shows on the graph that there's more sheep than goats and this one says that there's fewer sheep than goats and that's what it shows on the graph [SJ1].

I looked A and it wasn't right. Looked at B didn't look right. I looked at C and it looked right and then I looked at D and it didn't look right so I picked C and coloured that in. (So there are fewer sheep than goats. How many sheep are there?) There are 6. (And how many goats are there?) 4. (What's another way of saying that?) There are more sheep than goats [HT5].

It was for this reason that the word 'fewer' was replaced with 'less' in Test B (see Figure 5). According to Quirk & Greenbaum (1993) when making a comparison between quantities there is a choice between these two words, however 'less' is definitely used when referring to statistical or numerical expressions. Subsequently only 5% of all students answered this question incorrectly in Test B.

I looked are there more goats than cows and no because there are only 4 goats and there are a maximum of cows. And I looked at there are more horses than cows and that is not true. There are less sheep than goats and that's not true. And then I looked at there are less sheep than horses and I could see that answer had to be because the horses had 8 and the sheep had 6 and then I coloured answer D [HT5].

With the growing emphasis of standardised testing within the education system it is important that these assessments provide a valid picture of what students know and can do. If we are to read the results of Test A, with no insight into children's mathematical thinking, it could be assumed that over half the students were unable to read a graph correctly. The reality is that 95% could successfully complete the mathematical component of the question but were unable to access the item due to literary restraints. As Abedi (2006) argues, "to provide fair and valid assessment for all students ... the impact of terminology unrelated to content-based assessments must be controlled" (p. 377).

Conclusions and Implications

Given the increased accountability being placed on teachers (and education systems) in relation to national testing, it is imperative that specific items within tests are scrutinised (Diezmann, 2008). If teachers and schools are going to be targeted and held accountable for student's results, we need to guarantee that the assessment is a valid and accurate representation of what students know.

This paper does not suggest that children are ill prepared to engage in mathematics tasks and thinking but rather the phrasing of some of the items in NAPLAN are inappropriate for contemporary teaching and learning. Any mathematical test should be a reflection of children's mathematics performance, not a student's capacity to interpret tasks that are foreign. We therefore need to evaluate what we are actually assessing - mathematical knowledge or a child's individual terminology ability. Teachers should not be expected to teach to the test but in light of the results from this paper if we are not careful this will happen in order to guarantee positive results for their students. Furthermore we need to be assured that slight modifications in terminology do not result in dramatic student performance differences. The reliability of items within the NAPLAN need to be well scrutinised and indeed the items need to assess what is being reported, particularly in our climate of intense accountability.

References

- Abedi, J. (2006). Terminology issues in item development. In S. M. Downing, & T. M. Haladyna (Eds.). *Handbook of test development*. (pp. 377-398). New Jersey: Lawrence Erlbaum Associates, Inc.
- Abedi, J., & Lord, C. (2001). The language factor in mathematics tests. *Applied Measurement in Education*, 14(3), 219-234.
- Adams, T. L. (2003). Reading mathematics: More than words can say. *The Reading Teacher*, 56(8), 786-795.
- Boaler, J. (1994). When do girls prefer football to fashion? An analysis of female under achievement in relation to realistic mathematics contexts. *British Educational Research Journal*, 20(5), 551-564.
- Board of Studies NSW. (2002). *Mathematics K-6 Syllabus*. Sydney, Australia: Board of Studies NSW.
- Diezmann, C. (2008). Graphics and the national numeracy tests. In M. Goos, R. Brown & K. Makar (Eds.). *Navigating currents and charting directions. Proceedings of the 31st annual conference of the Mathematics Education Research Group of Australasia* (Vol. 2, pp. 659-662). Brisbane, Australia: Mathematics Education Research Group of Australasia.
- Fuentes, P. (1988). Reading comprehension in mathematics. *The Clearing House*, 72(2), 81-88.
- Kulm, G. (1991). New directions for mathematics assessment. In G. Kulm (Ed.), *Assessing higher order thinking in mathematics*. (pp. 71-78). Washington, DC: American Association for the Advancement of Science.
- Logan, T., & Greenlees, J. (2008). Standardised assessment in mathematics: The tale of two items. In M. Goos, R. Brown & K. Makar (Eds.). *Navigating currents and charting directions. Proceedings of the 31st annual conference of the Mathematics Education Research Group of Australasia* (Vol. 2, pp. 655-658). Brisbane, Australia: Mathematics Education Research Group of Australasia.
- Lowrie, T. & Diezmann, C. M. (2009). National numeracy tests: A graphic tells a thousand words. *Australian Journal of Education*, 53(2), 141-158.
- Matteson, S. M. (2006). Mathematical literacy and standardised mathematical assessments. *Reading Psychology*, 27, 205-233.
- Ministerial Council on Education, Employment, Training and Youth Affairs (MCEETYA) (2006). *Statements of Learning for Mathematics*. Retrieved 2 November 2009 from: http://www.mceecdya.edu.au/verve/resources/SOL_Maths_Copyright_update2008.pdf
- Ministerial Council on Education, Employment, Training and Youth Affairs (MCEETYA) (2008a). *National assessment program: Literacy and numeracy. Year 3 numeracy test*. Melbourne, Australia: Curriculum Corporation.
- NSW Department of School Education. (1989). *Mathematics K-6*. Sydney: NSW Department of School Education.
- Perso, T. (2009). Cracking the NAPLAN code: Numeracy and literacy demands. *Australian Primary Mathematics Classroom*, 14(3), 14-18.
- Pugalee, D. K. (1999). Constructing a model of mathematical literacy. *The Clearing House*, 73(1), 19-22.
- Quirk, R., & Greenbaum, S. (1993). A university grammar of English. Retrieved February 1, 2010, from: <http://grammar.ccc.commnet.edu/grammar/adjectives.htm>
- Thomas, D. A. (1988). Reading and reasoning skills for mathematics problem solvers. *Journal of Reading*, 32, 244-249.
- Wakefield, D. V. (2000). Maths as a second language. *The Educational Forum*, 64, 272-279.
- Webb, N. L. (1992). Assessment of students' knowledge of mathematics: Steps toward a theory. In D. A. Grouws (Ed.), *Handbook of research on mathematics teaching and learning*. (pp. 661-683). New York: Macmillan.

Mathematics Teachers: Negotiating Professional and Discipline Identities

Peter Grootenboer
Griffith University
p.grootenboer@griffith.edu.au

Julie Ballantyne
University of Queensland
j.ballantyne@uq.edu.au

The professional practice of teachers is shaped and directed by their sense of identity (Beijaard, Verloop, & Vermunt, 2000). All teachers have some conception of themselves as pedagogues, but they also have identities which relate to the disciplines that they are required to teach. Here we report on a project that explored the nexus of these identities with specialist mathematics teachers in secondary schools and generalist teachers who teach mathematics in primary/middle schools. The preliminary findings presented here suggest that when teaching mathematics, teachers often enact a pedagogy that unconsciously reflects their identities as somewhere on the continuum from mathematician to teacher. It appears that 'excellence' as teachers may be associated with teachers viewing themselves as educators first and foremostly, but who have a positive perception of the discipline area, and who are confident in the related Pedagogical Content Knowledge.

Central to all students' school education is the teacher (Boaler & Greeno, 2001; Hayes, Mills, Christie & Lingard, 2006; Zammit, et al., 2007). There are a multitude of research studies that document and support successful teaching practice, but rarely have these studies investigated teacher qualities that go beyond the question of technique (incorporating strategies and approaches used in the classroom). Yet, good teaching goes beyond 'good technique' (Palmer, 1993) – if it were mere technique then it should be well understood by now. Palmer argues that teachers teach from their sense of self – their identity. In the classroom, that identity primarily consists of the way they see themselves as a pedagogue and how they see themselves in relation to their discipline – in this case, as a mathematician. This study focused on the teacher themselves – their identity – and in particular how their teaching practice is conceptualised through their discipline-based, and professionally-based identities (Ballantyne, 2005). The findings here are somewhat preliminary and require further investigation and theorising. To this end we offer some of the initial findings and our early thoughts about the data, but these are tentatively held and hopefully they will promote discussion and debate.

Teacher Identity

There have been many studies that have looked somewhat independently at teachers' knowledge, beliefs and practices, but the concept of 'identity' is a more encompassing conceptual framework. Teacher identity incorporates their personal knowledge, beliefs, values, emotions and practices about teaching, about the disciplines they are teaching, and about themselves as educators (Grootenboer, Smith & Lowrie, 2006). It includes what teachers think and do, but it also encompasses their sense of who they are.

The term identity has been variously defined and there is continuing debate about whether an individual has one identity with many aspects, or if they have multiple identities (Grootenboer, et al., 2006). While finding clarity and theoretical rigour concerning the phenomenon of identity is important, it is not the focus of this paper. Here we take the term as being unproblematic and we do not take a stance on the singularity or plurality of personal identity, although we do acknowledge that this is a simplification of a



complex term. We as authors are far more interested in how teachers see and define their own identities, and implications of such identities to their practice.

Disciplinary and Identity

Teachers are required to teach within and through particular disciplines (e.g., mathematics and music), and the nature of their teaching practice has been shown to vary according to the discipline being taught and the ages of the students (Martinez, 1994). When teachers teach particular subjects, they teach more than just knowledge and skills – they also convey aspects like beliefs, values and emotional responses about the field (Grootenboer, 2006). These discipline-based ‘teachings’ are grounded in the teacher’s disciplined-based identity – i.e., what they know, think, value and do as a mathematician, and they also have a significant impact on their students’ developing discipline-based identities (Eder & McCabe, 2004; Zevenbergen & Grootenboer, 2009). As argued by Ramsey (2000), “it is impossible in any discipline to separate the content from the pedagogy” (p. 37), with the implication being that “teachers never teach something in general – they always teach particular things to particular groups of [students] in particular settings ... most human learning and teaching is highly specific and situated” (Shulman & Sparks, 1992, p. 14). If this is true, then teachers’ professional identities are likely to also be situated within discipline or age level specialisation.

However, teacher identities also include how they see themselves as educators and their professional practice is significantly constituted by their pedagogical identity **and** their discipline-based identity (Ballantyne, 2006). Mathematics teachers’ identities in relation to their mathematical sense of self and their professional sense of self will be foundational to their teaching practice. It is important to note that this is significantly more complicated for primary school teachers who are required to teach across several discipline areas, and may identify primarily as teachers of particular aged students rather than as teachers of disciplines.

Teacher Identity and Teacher Knowledge

Shulman (1987), in his seminal work, theorised the knowledge bases of teaching (content knowledge, pedagogical knowledge and pedagogical content knowledge). Ballantyne’s (2007) study revealed that (in the case of music teachers) pedagogical content knowledge and skills was of most importance to those teachers in the early stages of their careers, and that professional identity appeared to be associated with perceived aptitude in relation to the discipline (and pedagogical content knowledge and skills). In this study we hope to be able to offer a more comprehensive understanding by broadening the focus to identity. This sort of theory would be significant in underpinning practices in teacher education and development, and indeed, to better understand the pivotal work of teachers.

The Study

The data reported on here is part of a larger study conducted in 2009 and 2010 that focussed on mathematics and music teachers. The project was conceptualised as a series of related case studies (Stake, 1995) and employed qualitative methods to explore the professional and disciplined-based aspects of the school teachers’ identities, and the relationship between these aspects of their identities and their teaching practice.

Data Collection

Data were gathered through in-depth interviews, classroom observations and document analysis with both primary generalist teachers and secondary specialist mathematics teachers. The participant group was made up of four secondary school mathematics teachers and four primary/middle school general teachers from schools in South-East Queensland. There was an equal balance of male and female participants and all were experienced teachers (10 to 35 years experience). Participants were selected and invited to participate because they were acknowledged as being good teachers of mathematics by the educational community (for example, one of the participating teachers has received a national teaching award, another was recommended by mathematics teachers from four other schools). A program of data collection was negotiated with each participant, and each included an initial in-depth interview and a classroom observation and follow-up interview. In most cases, a small group of students from the teachers' class were also briefly interviewed.

Semi-structured interviews were the primary mode of data collection, and all the interviews were audio-taped and transcribed. The interviews lasted between 45 and 90 minutes. An initial semi-structured interview was undertaken with each participant and focused on aspects of their professional identity including their personal philosophies, beliefs, values and knowledge about teaching and mathematics, and how these are enacted in their classrooms. These conversational interviews were designed so that participants could experience them as professional discussions about the nature and meaning of teachers' work and their convictions about the pedagogy of mathematics (Kvale, 1996). Follow-up interviews were undertaken to explore aspects of the participant's practice after a lesson had been observed and photographed, and through examining artefacts such as student work samples and programs. To gain a student perspective of the teachers' actions and philosophies, in most cases additional informal interviews were undertaken with students who had been in the class of the participating teacher.

Following the classroom observation a stimulated recall interview was conducted. During the observed lesson detailed field notes were taken and these notes were the basis for a semi-structured follow-up interview where the observations made by the researcher were explored with the participant (Lyle, 2003). The observations were enhanced by photographs of the participant as he/she was engaged in the teaching process. The photographs were used to stimulate recall to prompt discussion about the practices captured, but they were then deleted and not retained as part of the data set. During the reflective discussions/semi-structured interviews, the researcher(s) and the participant viewed and examined the photographs together, stopping as required to discuss and question aspects of the teacher's practice as they emerged. The use of photographs was seen as preferable to video-taping because the still pictures require the participating teacher to discuss and 'fill-in the gaps', whereas a video can be seen as somewhat 'self-explanatory' (Zevenbergen, 2005).

Data Analysis

The data collection process yielded a large data set that included 16 interview transcripts with the participating teachers and 8 group interview transcripts with students. Grounded theory analysis techniques were utilised (Strauss & Corbin, 1998) using the NVivo8 software. The data was initially divided into conceptual units and coded both inductively and deductively (Schwandt, 1997). Once this initial coding was complete, the

researchers began to impose some structure upon the data by developing themes and sub-themes. The structured data set was then used to theorise the central topics of the study, while always returning to the empirical data for verification and exemplification.

Findings and Discussion

Before briefly outlining a few of the key findings, it is important to note one striking feature of the data collection process. Having visited, observed and talked with each of these eight teachers and some of their students, it was clear that they all had different styles and approaches to teaching. They ranged from strict, highly structured classes to quite informal and open lessons, and some teachers used a largely investigative approach while others were more textbook and exercise based. Despite the great diversity in the teachers and the lessons, all the participating teachers have been acknowledged as effective teachers of mathematics by their peers. This indicated to us that there is indeed more to effective mathematics teaching practice than the pedagogical approach and the classroom management style.

The data set generated is large and a wide range of themes have emerged from the data analysis process. Here we will only report on the findings that specifically relate to the teachers' identity as 'mathematics teachers'. In particular, we will focus on their professional identity as an educator, their discipline identity as a mathematician, and the way these two realms interact and are negotiated in their role as mathematics teachers.

Mathematics Teachers as Educators

Without exception, all of the participants identified themselves first and foremost as teachers. While there were many dimensions to the pedagogical aspect of their identity, the two most prominent aspects were relationships and the classroom environment, and clearly these are not distinct elements. The relational basis for their classroom practice was seen as critical to all the participants, although they may have enacted it in different ways. For example, Geoff¹¹ (Middle School, Initial interview) said:

I think so very much so and you've got to connect. That means you've got to be a real person to them, you can have the greatest knowledge in the world but if you can't connect and you can't communicate you're stuffed.

There was a sense throughout all the data collection events that the participating teachers cared deeply about their students, that they knew their pupils well, and they had mutual respect for one another. Similarly, all the participating teachers and their students noted the importance of an engaging and inviting classroom environment. In particular, they noted the importance of "fun" and "humour", and these also helped establish and maintain good pedagogical relationships. The notion of having a teaching identity that is fun and humorous was not meant in a frivolous sense, but rather a notion of being engaging, warm and 'human'.

Mathematics Teachers as Mathematicians

It was prominent that all the participating teachers did not see themselves as mathematicians. Each teacher was specifically asked whether they thought of themselves as a mathematician and without exception they all said "no". A typical response was;

¹¹ Pseudonyms are used throughout this report

No, not really. I'm more of a teacher than a mathematician I think. I love my maths, don't get me wrong but I don't think I'm a mathematician, otherwise I'd be out doing that instead. I kind of think of mathematicians as insular sorts of people and I'm nothing like that, so no I'm not a mathematician, I'm just a teacher who loves maths. (Cathy, Secondary Mathematics, Initial interview)

Cathy's response is indicative of the views of all the participants in that, while she did not accept the label of mathematician, she did acknowledge of love for the subject, but as one who is primarily a teacher. The common belief was that a mathematician is one who only does mathematics, and associated with that view were certain pervasive common beliefs about what a mathematician is like and what they do. These included beliefs about mathematicians being "insular", "geeky", "dry" and "detached from the real world", and their work being "isolated", "disconnected", formulaic and unemotional. Perhaps then it is not surprising that the participants did not want to align themselves with the title 'mathematician'. However, these views do not resonate with the findings of Burton (1999) who found that mathematicians are collaborative and emotive, and in their practice they sought connections and insight. Also, it was interesting to note that the participating teachers wanted their students to see themselves and/or to behave as mathematicians:

However, I like my kids to think of themselves as mathematicians and we explore things so I set up activities that allow the kids to build their understanding and feeding new information as we go along and that sort of stuff. But I want the kids to act as mathematicians. (Tanya, Secondary Mathematics, Second Interview)

Indeed, during the interviews when this point was discussed vis-à-vis their view of themselves as mathematicians, it prompted some reflective consideration.

That said, there was other data that indicated that the participating teachers did espouse and enact mathematical beliefs, values and behaviours, even if they did not feel they were 'mathematicians'. As noted above, all had a passion for mathematics and they enjoyed working on mathematical problems to a greater or lesser degree. One participant discussed the challenge and the joy of finding problems or contexts in the popular media that could be modelled mathematically, and then engaging with this task to see if it was an appropriate activity for his senior mathematics classes.

I think you've got to have the passion about what you do. I think you've got to have that interest - it would have taken me a couple of weeks to actually unpack the Tacoma Narrows Bridge problem, to get it to a point where I knew the kids had a chance of being able to work it through so you've actually got to really understand what's happening. Like the assumptions and stuff like that - assumptions to be able to then allow the kids to have access so I mean it's really fun to do and I think we can actually do a lot more with it, and play around with it. ... If I don't get enjoyment out of it I don't do it really. I mean to say it's got to be fun! (Glen, Secondary Mathematics, Second interview)

Here it is clear that Glen actually enjoyed doing the mathematics himself, but this only occurred in the context of preparing something for the students. As such, this is a point where he is drawing on the mathematical and pedagogical aspects of his identity.

Mathematics Teacher Identity

While the teachers saw themselves primarily as teachers, it was clear that they all had a strong mathematical sense of self, and their professional practice as mathematics teachers developed from both their pedagogical and discipline-based identities. One such example was noted above, where Glen was planning learning experiences for his class, but perhaps where this was most prominent was in the teachers' classroom practice.

During the lesson observations it was clear that the teachers were making many decisions about what to do and say in the classroom. These decisions didn't appear to require a great deal of thought or reflection because the ensuing actions were almost immediate. The decisions were complex as they often involved appraising the mathematics presented and considering the personalities and identities of the particular student(s) concerned. Therefore, a good deal of time was spent in the post-observation interviews discussing the decision-making process as they engaged in the business and complexity of the classroom. It should be noted that the participants found these parts of the interviews quite difficult because they had not overtly considered this aspect of their mathematics teaching before. The photographs and fieldnotes were valuable in recreating particular classroom events for the participating teachers to consider and reflect upon.

Routinely throughout the lessons the teachers were confronted with situations where they had to decide whether to support and protect the students' mathematical identity and when to promote challenge and uncertainty for mathematical growth. Unfortunately, learning mathematics can cause anxiety and stress for many students, and so the participating teachers commented on the importance of being attentive to the students' emotions and their developing mathematical identities. However, students' mathematical development requires times of uncertainty and disequilibrium as they face new material or ideas (Carter, 2008). This means that in mathematical learning situations there is an inherent tension between protecting students' (often fragile) mathematical identities and facilitating unease and discomfort so growth can occur. Furthermore, the teachers regularly responded to different students in different ways. When seeking assistance from the teachers while working on the same problem, some students were offered specific advice and encouragement about what to do next while others were given a probing question. Similarly, on some occasions the teachers gave quite direct instruction or teaching, whereas on other occasions they would allow the students to explore a problem and/or continue with their ideas. When asked whether the decision to do this was based on educational grounds or mathematical grounds, David (Secondary Mathematics, Second interview) said;

Both - it's what I see the kids doing. It's about, like for instance when we were talking about the logarithms and about the language that we use, it's very explicit, this is what I want you to use and there's no negotiation in that sense but other times I'm happy for kids to use communication and justification in a way that they want to use it. So it's based on what I see the kids doing and how their thinking is going and also the fact that I want them to have that mathematical rigor, for want of a better word, that we are using the right language and we are using it in an appropriate context.

Thus, this teacher and his students were engaged in a sort of "dance of agency" (Zevenbergen & Grootenboer, 2009) negotiating the requirements of the discipline and their own agency as doers and makers of mathematics.

In order to decide whether to challenge and let the uncertainty remain, or to alleviate the pressure the teachers needed to have a sound mathematical perspective and a good knowledge and understanding of their students – thus drawing on their mathematical and pedagogical identities (Grootenboer & Zevenbergen, 2008). Furthermore, as noted previously, these decisions are made very quickly as is demanded by the hectic nature of the classroom, and so there is limited capacity for deep thought, and careful and evaluative consideration. Thus, it appeared to us that the decisions were made from their identity as mathematics teachers – from a sense of who they are in that classroom. These mathematical and pedagogical perspectives may well have been developed through a range of factors including thoughtful, reflective and analytical consideration and personal mathematical

experiences, but in the classroom it is the person of the mathematics teacher who must respond and act.

Conclusions and Implications

As was mentioned at the outset, the findings and discussion of this paper are interim in nature, and so we do not claim any firm implications for practice at this stage. That said, we do feel that the data has given rise to some issues that are worthy of further consideration.

Firstly, despite all the participants for this study being selected because they were acknowledged by their peers as good mathematics teachers, their pedagogical approaches and their classroom practices varied greatly. Thus, it appeared to us that effective mathematics teaching cannot be defined in terms of a technique and teaching style, or at least not in terms of these alone. However, what was clear was that each of the teachers had coherent views about how children learn mathematics, and their classroom practice was developed from these beliefs. Therefore, in this study it seemed that a consistent and coherently articulated identity as a mathematics teacher was foundational to effective practice, rather than holding to any particular fashionable or required pedagogical approach – a professional sense of identity.

Secondly, even amongst this community of mathematics teachers, there appears to be some inconsistency about mathematicians and mathematical practice. Perhaps for some of the participants this was related to a sense of modesty and not wanting to over-state their mathematical capabilities. Nevertheless, it is desirable that mathematics teachers have robust mathematical identities, including some pride in owning the label of ‘mathematician’.

Finally, the teachers’ classroom practice was characterised by a stream of quick decisions and actions that seemed to be undertaken with limited consideration. However, these teaching actions can have significant consequences, particularly because what is done cannot be undone (Kemmis, 2008). The sense of immediacy about these decisions and actions – decisions and actions that are the fabric of classroom teaching, indicated to us that they were made from the teachers identity or sense of self. While this idea is difficult to capture and articulate, this notion of ‘who they are’ it appears to be important. This would mean that good mathematics teachers not only have sound mathematical knowledge, pedagogical knowledge, and mathematical pedagogical knowledge, but they are mathematical educators whose identity is imbued with discipline and professional qualities. If this is the case, then teacher development will be about developing the all-round person who teaches mathematics – an identity as a mathematics educator.

References

- Ballantyne, J. (2005). Identities of music teachers: Implications for teacher education. In M. Cooper (Ed.), *Teacher Education: Local and Global: Australian Teacher Education Association Conference Proceedings* (pp. 39-44). Gold Coast: Australian Teacher Education Association.
- Ballantyne, J. (2006). What music teachers want: The emergence of a unified understanding of an ideal teacher education course. *Australian Journal of Teacher Education*, 31(1), 2-11.
- Ballantyne, J. (2007). Integration, Contextualisation and Continuity: Three themes for the development of effective music teacher education programs. *International Journal of Music Education*, 25(2), 160-176.
- Beijaard, D., Verloop, N., & Vermunt, J. D. (2000). Teachers' perceptions of professional identity: An exploratory study from a personal knowledge perspective. *Teaching and Teacher Education*, 16, 749-764.

- Boaler, J., & Greeno, J. G. (2000). Identity, agency, and knowing in mathematics worlds. In J. Boaler (Ed.), *Multiple perspectives on mathematics teaching and learning* (pp. 171-200). Westport, CT: Ablex.
- Burton, L. (1999). The practice of mathematicians: What do they tell us about coming to know mathematics. *Educational Studies in Mathematics*, 37, 121-143.
- Carter, S. (2008). Disequilibrium & Questioning in the Primary Classroom- Establishing Routines That Help Children Learn. *Teaching Children Mathematics*, 15(3), 134-137.
- Eder, D., & McCabe, J. (2004). Bridging social and academic identities: Peer relations, friendship and educational experiences. In T. Urdan & F. Pajares (Eds.), *Educating Adolescents: Challenges and strategies* (pp. 207-236). Greenwich, CT: Information Age.
- Grootenboer, P. J. (2006). The impact of school-based practicum on preservice teachers' affective development in mathematics. *Mathematics Teacher Education and Development*, 7, 18-32.
- Grootenboer, P. J., Smith, T., & Lowrie, T. (2006). Researching identity in mathematics education: The lay of the land. In P. Grootenboer, R. Zevenbergen, & M. Chinnappan (Eds.) *Identities, cultures and learning spaces* (Proceedings of the 29th annual conference of the Mathematics Education Research Group of Australasia, Vol. 2, pp. 612-615). Canberra, Australia: MERGA.
- Grootenboer, P. J., & Zevenbergen, R. (2008). Identity as a lens to understand learning mathematics: Developing a model. In M. Goos, R. Brown, & K. Makar (Eds.), *Navigating currents and charting directions* (Proceedings of the 31st annual conference of the Mathematics Education Research Group of Australasia, Brisbane, Vol. 1, pp. 243-250). Brisbane: MERGA
- Hayes, D., Mills, M. Christie, P., & Lingard, B. (2006). *Teachers and schooling: Making a difference*. Crows Nest, NSW: Allen and Unwin.
- Kemmis, S. (2008). Praxis and Practice Architectures in Mathematics Education In M. Goos, R. Brown, & K. Makar (Eds.), *Navigating currents and charting directions* (Proceedings of the 31st annual conference of the Mathematics Education Research Group of Australasia, Brisbane, Vol. 1, pp. 17-28). Brisbane: MERGA
- Kvale, S. (1996). *InterViews: An introduction to qualitative research interviewing*, Thousand Oaks, California: Sage.
- Lyle, J. (2003). Stimulated recall: A report on its use in naturalistic research. *British Educational Research Journal*, 29(6), 861-878.
- Martinez, K. (1994). Postcards from the edge. In *Knowledge and competence for beginning teaching*. Brisbane, Queensland: Board of Teacher Registration, Queensland.
- Palmer, P. (1993). *To know as we are known: Education as a spiritual journey*. New York: HarperCollins.
- Ramsey, G. (2000). *Quality matters*. New South Wales: Department of Education and Training.
- Schwandt, T. A. (1997). *Qualitative Inquiry: A Dictionary of Terms*. London: Sage.
- Shulman, L. S. (1987). Knowledge and teaching: Foundations of the new reform. *Harvard Educational Review*, 57(1), 1-22.
- Shulman, L. S., & Sparks, D. (1992). Merging content knowledge and pedagogy: An interview with Lee Shulman. *Journal of Staff Development*, 13(1), 14-16.
- Stake, R. (1995). *The art of case study research*. Thousand Oaks, CA: Sage.
- Strauss, A. & Corbin, J. (1998). *Basics of qualitative research: Techniques and procedures for developing grounded theory* (2nd ed.). London: Sage.
- Zammit, K., Sinclair, C., Cole, B., Singh, M., Costley, D., Brown, L., & Rushton, K. (2007). *Teaching and leading for quality Australian schools: A review and synthesis of research-based knowledge*. Sydney: Teaching Australia.
- Zevenbergen, R. (2005). Prioritising the voice of researched: Using photographs to elicit mathematical thinking of participants. In P. Clarkson, A. Downton, D. Gronn, M. Horne, A. McDonough & A. Roche (Eds.), *Building connections: Theory, research & practice*. Proceedings of the 28th Annual Conference of the Mathematics Education Research Group of Australasia (pp. 815-822). Melbourne: MERGA.
- Zevenbergen, R., & Grootenboer, P. (2009). Towards a theory of identity and agency in coming to learn mathematics. *Eurasia Journal of Mathematics, Science & Technology Education*, 5(3), 255-266.

A Network Analysis of Concept Maps of Triangle Concepts

Jin Haiyue

National Institute of Education, Singapore
<haiyue.j@gmail.com>

Wong Khoon Yoong

National Institute of Education, Singapore
<khoonyoong.wong@nie.edu.sg>

Mathematics educators and mathematics standards of curriculum have emphasised the importance of constructing the interconnectedness among mathematic concepts (“conceptual understanding”) instead of only the ability to carry out standard procedures in an isolated fashion. Researchers have attempted to assess the knowledge networks in students’ minds. A technique that has gained popular use in science education over the past three decades is concept mapping. This paper examines students’ conceptual understanding about triangle concepts using concept maps, and an analysis of the maps using degree centralities derived from social network analysis has demonstrated new insights through this novel technique.

Mathematics concepts are logically interconnected. This interconnectedness manifests as coherent knowledge networks, which can be hierarchical or non-hierarchical (web-like). For many years, psychological and educational research on the learning of mathematics has emphasised this interconnectedness as conceptual understanding (Bransford, Brown, & Cocking, 1999; National Council of Teachers of Mathematics, 2000). An important issue concerning this emphasis is how to assess these relationships expressed as cognitive mind maps or knowledge networks so that the information can be used by teachers to plan lessons, and by curriculum developers to take into consideration the psychological, in addition to, the logical knowledge relationships. A technique that has been applied widely in science education over the past three decades is concept mapping.

A concept map can be a “window into the mind” (Shavelson, Ruiz-Primo, & Wiley, 2005, p.1). It is generally defined as a two-dimensional map consisting of nodes representing concepts and labelled lines denoting the relations between pairs of nodes (Novak & Cañas, 2009). These nodes can be mathematical concepts, examples and non-examples of the concepts, diagrams, symbols, and formulas. The labelled lines, also called *linking phrases*, can be verbs or phrases. These labelled lines are usually directional. When two or more concepts are linked, statements are formed, and these statements are called *propositions* (Novak & Gowin, 1984). Thus, a concept map provides an externalised representation in the form of a directed graph of how a person has linked various ideas.

Different methods have been used to interpret the information embedded in concept maps and to score them for assessment purposes. Initially, Novak and Gowin (1984) considered four aspects for scoring: *validity of propositions*, *hierarchy*, *cross links*, and *examples*. An updated version includes six criteria to evaluate the map from the concept level to the whole map: “concept relevance and completeness, correct propositional structure, presence of erroneous propositions, presence of dynamic propositions, number and quality of cross links, and presence of cycles” (Novak, 2010, p. 235). Other researchers in mathematics education have described specific aspects of concept maps rather than use systematic coding (see chapters in Afamasaga-Fuata’I, 2009). While these methods have achieved different assessment purposes, more attention could be given to the properties of individual concepts (nodes). For instance, Jin (2007) counted the number of incoming and outgoing links to each node. The incoming links represent the chance to activate this node from other nodes in the concept map; the outgoing links indicate the power of this node to connect to other nodes. However, examining only these attributes of individual nodes does not provide insights about the whole concept map, including dyadic



properties of directed links. This paper attempts to fill this gap by applying social network analysis to analyse the properties of the individual nodes and the entire map of concept maps created by students.

Social network analysis (SNA) includes several techniques that use the language of mathematics graph theory to study social relations among people within communities. It uses a variety of attributes such as *centrality*, *betweenness*, *closeness*, and *clique* (Degenne & Forsé, 1999; Wasserman & Faust, 1994) to describe such relations. However, we have not found any use of SNA to the study of concept maps. Thus, we attempt to apply SNA to the study of Grade 8 students' concept maps of triangle concepts. Combining this form of analysis with specific discipline (mathematics education in this case) may yield fresh insights about the students' conceptual understanding. In this paper, we will consider only degree centrality analysis, to be defined in a later section.

Methodology

Participants

The participants were 48 Grade 8 students (24 boys and 24 girls) from a junior middle school in Nantong, China. They did not have prior experience of concept mapping.

Training and Concept Map Task

The students first received four 40-minute training sessions on concept mapping. The training, which was developed through several attempts reported in Jin and Wong (2008), was to ensure that the students knew what a concept map was and how to construct meaningful concept maps. Unlike the training programs in traditional concept mapping studies (e.g., Ruiz-Primo, Schultz, Li, & Shavelson, 2001), detailed linking phrases were emphasised in this training. At the end of the training sessions, the students' concept mapping skills (CMS) were tested with a specially designed CMS-Test. Preliminary analysis of the results of the CMS-test indicated that the students had developed the necessary skills to construct meaningful concept maps.

After taking the CMS-test, the students were given a list of eleven concepts related to *triangle*. These concepts were listed in this order (translated from Chinese): *triangle*, *acute-angled triangle*, *right-angled triangle*, *obtuse-angled triangle*, *scalene triangle*, *isosceles triangle*, *equilateral triangle*, *angle*, *symmetry axis*, *median*, and *midline*. These concepts were taken from their Grade 7 mathematics textbook (in Chinese). The students were given a piece of blank paper and were told that they could add extra concepts to their concept maps if they found them related to the given ones. They were allowed to construct either a hierarchical or non-hierarchical map. Thirty minutes were allowed for the students to construct concept maps individually. This was a free-style mapping task (Ruiz-Primo, Shavelson, Li, & Schultz, 2001). This paper reported the network analysis of these student-constructed concept maps.

Data Analysis: Degree Centrality

Degree centrality measures the extent to which a node connects to all other nodes in a network (Knoke & Yang, 2008). In a directed network, there are two separate measures of degree centrality depending on the direction of links: in-degree centrality and out-degree centrality. In-degree centrality of a node counts the number of incoming links directed to the node, and out-degree centrality counts the number of outgoing links from the node

(Durland, 2006). They are defined as IDC (in-degree centrality) and ODC (out-degree centrality):

$$IDC(i) = \sum_{j=1}^n x_{ij} \quad (i \neq j) \quad \text{and} \quad ODC(i) = \sum_{j=1}^n y_{ij} \quad (i \neq j)$$

where x_{ij} is the number of direct links from node j to node i and y_{ij} is the number of direct links from node i to node j . Normally, x_{ij} equals to 0 or 1, and the same for y_{ij} . Thus, $\sum_{j=1}^n x_{ij}$ counts the number of incoming links from the other $(n - 1)$ nodes to node i and $\sum_{j=1}^n y_{ij}$ counts the number of outgoing links from node i to the other $(n - 1)$ nodes.

The total degree centrality (DC) of node i is then defined as $DC(i) = IDC(i) + ODC(i)$. These degree centralities reflect the connectivity of an individual node to other nodes in a network. For different networks consisting of the same nodes, the in-degree and out-degree centralities allow comparison of a node's connectivity across the networks. The larger the in-degree centrality, the higher is the popularity of a node in a network, and the larger the out-degree centrality, the higher is the influence of a node in the network (Durland, 2006).

Definitions of degree centrality can be extended to the whole network. Freeman (1979, cited in Wasserman & Faust, 1994) proposed a generic measure of *group degree centrality* (GDC) for undirected network with n nodes, which was afterwards revised by Wasserman and Faust (1994, p.180) as:

$$GDC = \frac{\sum_{i=1}^n [DC(N^*) - DC(i)]}{(n-1)(n-2)}$$

where $DC(i)$ refers to degree centrality of node i in the undirected network, $DC(N^*)$ denotes the largest degree centrality observed in the network, and the denominator is the theoretically maximum possible sum of those differences.

Group degree centrality is used to measure the extent to which the nodes in a network differ from one another in their individual degree centrality. The larger the group degree centrality, the more uneven is the degree centrality of the nodes in a network (Knoke & Yang, 2008).

The above measure of group degree centrality can be extended to directed networks by considering the directions of the links. Group in-degree centrality (GIDC) and group out-degree centrality (GODC) are defined as follows:

$$GIDC = \frac{\sum_{i=1}^n [IDC(N^*) - IDC(i)]}{(n-1)^2} \quad \text{and} \quad GODC = \frac{\sum_{i=1}^n [ODC(N^*) - ODC(i)]}{(n-1)^2}$$

where $IDC(i)$ refers to in-degree centrality of node i in a directed network, $ODC(i)$ refers to out-degree centrality of node i in the network, and $IDC(N^*)$ and $ODC(N^*)$ respectively denote the largest in-degree centrality and out-degree centrality observed in the network. The denominator refers to the maximum possible sum of differences of in-degree or out-degree centrality. Its value, however, is different from the maximum possible degree centrality for undirected network as defined in GDC . For directed graphs, the maximum out-degree centrality occurs when one particular node has an outgoing link to every other nodes but the other nodes do not have any outgoing links, giving the value of $(n - 1) - 0 = n - 1$. This is repeated $(n - 1)$ times, so the value of the denominator for $GODC$ equals to $(n - 1)(n - 1)$. The same value applies to $GIDC$. A higher $GODC$ indicates more uneven influence among the nodes in a network, while a higher $GIDC$ indicates greater inequality among the nodes' popularity.

A student's concept map is now used to illustrate the above definitions. In this study, the student manually constructed a concept map in Chinese. For ease of presentation, the concept map was translated into English and re-drawn using the software Cmap Tools (available at: <http://cmap.ihmc.us>), as shown in Figure 1.

The concept *triangle* in Figure 1 was linked to 7 out of 10 concepts in the concept map: its out-degree centrality equals to 7.0. However, there were no links from the 7 concepts to *triangle*, so its in-degree centrality is 0.0.

The concept *equilateral triangle* in Figure 1 had two incoming links and one outgoing link; hence, its in-degree centrality is 2.0 and its out-degree centrality is 1.0.

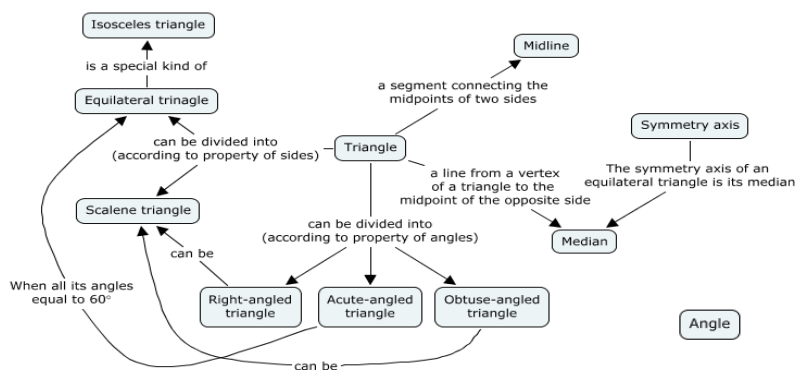

Figure 1. A student-constructed concept map (re-drawn).

The in-degree centrality and out-degree centralities for all the 11 concepts in Figure 1 are given in Table 1. The result shows that *triangle* is the most influential node since it reaches most number of other nodes directly while the other nodes have very low *ODC*. The most popular node identified by *IDC* is *scalene triangle* since it receives the most number of incoming links from the other nodes, although the number (3) is still quite small. Furthermore, the low range of values in *IDC* shows that the difference of the nodes in popularity is relatively small. The concept *angle* is an isolated node in the concept map with zero centralities; it has no link with any of the other nodes.

The total degree centrality in the last column is the total number of the incoming and outgoing links for each node. This score reflects the extent to which a node is connected within a concept map, ignoring the direction of the links. The result shows that *triangle* is well connected in the concept map in Figure 1 and *scalene triangle* and *equilateral triangle* are moderately connected. *Acute-angled triangle*, *right-angled triangle*, and *obtuse-angled triangle* have the same degree centralities; this suggests that these three types of triangles are of the same connectedness with the nodes in the concept map. The relatively low total degree centralities of the remaining five concepts indicate either that the concepts are mathematically less connected with the other concepts, or that the student was not familiar with the concepts. For example, *isosceles triangle* should have more or less the same number of links as *scalene triangle* and *equilateral triangle* since these three types of triangles are defined according to properties about sides, yet it has relatively low centralities compared to the other two types of triangle. Thus, this student may have an incomplete understanding of *isosceles triangles*.

Table 1
In-degree Centralities and Out-degree Centralities of Nodes in Figure 1

Centrality	Out-degree (ODC)	In-degree (IDC)	Total degree centrality (DC)
Triangle	7.0	0.0	7.0
Acute-angled Triangle	1.0	1.0	2.0
Right-angled Triangle	1.0	1.0	2.0
Obtuse-angled Triangle	1.0	1.0	2.0
Scalene Triangle	0.0	3.0	3.0
Isosceles Triangle	0.0	1.0	1.0
Equilateral Triangle	1.0	2.0	3.0
Symmetry Axis	1.0	0.0	1.0
Angle	0.0	0.0	0.0
Median	0.0	2.0	2.0
Midline	0.0	1.0	1.0
Group degree centrality:	0.650	0.210	0.589

The group degree centralities in the last row cannot be interpreted in isolation. Nevertheless, the *GODC* value of 0.650 reflects the large variation in individual out-degree centralities of the nodes: 7 for *triangle* and 0 or 1 for the rest of the nodes. For this student, *triangle* is the sole central concept from which to link to the other concepts. This could arise because *triangle* was the first item of the given list of concepts or it is the most inclusive concept or the super-concept of the list. See further analysis later on.

Findings: Centralities and Conceptual Understanding

Centralities

The above analysis of a single concept map is now extended to the whole group of 48 students. The mean centralities of the whole group are given in Table 2. For ease of comparison, the list of concepts is sorted by the out-degree centralities, followed by the in-degree centralities, instead of in the order the concepts appear in the given list.

The degree centralities in Table 2 show that *triangle* has the highest out-degree centrality but the lowest in-degree centrality. This suggests that *triangle* is the most influential but also the least easily accessible concept (in terms of the direction of links) among the given set of concepts. The high out-degree centrality (6.98) and low in-degree centrality (0.08) together indicate that *triangle* is less dependent on the other concepts in the concept maps (Hannerman & Riffle, 2005).

At the other end, the concepts *symmetry axis*, *angle*, *median*, and *midline* have very low out-degree centralities but average to high in-degree centralities. These four concepts are fairly popular as incoming links so they tend to appear at the end of a conceptual chain. They are not so influential in terms of outgoing links. The concepts *acute-angled triangle*, *right-angled triangle*, and *obtuse-angled triangle* have average in-degree and out-degree centralities, ranging from 1.10 to 1.92. These values suggest that the concepts are relatively popular with incoming links while at the same time are influential at an intermediate level. However, most of the incoming links to them are from *triangle*, while most of their outgoing links are to *symmetry axis*, *angle*, *median*, and *midlines*. Of these three concepts, *right-angled triangle* has the highest out-degree centrality. A possible reason is that, in addition to angle properties, *right-angled triangle* has other properties, which are not

shared by the other triangles, hence, increasing its out-degree centrality. For example, the *median* to the *hypotenuse of a right-angled triangle* equals to half the length of the hypotenuse, and this may have added more outgoing links to *median*.

Table 2

Mean Centralities of Concepts of 48 Student-constructed Concept Maps

Centrality	Out-degree (ODC)	In-degree (IDC)	Total degree centrality (DC)
Triangle	6.98	0.08	7.06
Equilateral Triangle	2.73	1.48	4.21
Isosceles Triangle	2.04	2.19	4.23
Right-angled Triangle	1.92	1.35	3.27
Acute-angled Triangle	1.27	1.81	3.08
Obtuse-angled Triangle	1.10	1.27	2.37
Scalene Triangle	1.00	1.65	2.65
Angle	0.27	2.81	3.08
Median	0.21	1.48	1.69
Midline	0.17	1.44	1.61
Symmetry Axis	0.10	2.23	2.33

Among the other three types of triangles, *scalene triangle*, *isosceles triangle*, and *equilateral triangle*, *scalene triangle* have the lowest out-degree centrality and *isosceles triangle* has the highest in-degree centrality. This suggests that these students had more knowledge about *isosceles triangle* and *equilateral triangle* than about *scalene triangle*, since the first two types of triangles have more special properties not shared by *scalene triangle*. For example, *isosceles triangle* and *equilateral triangle* have *symmetry axis* and *equal angles*, while these properties are not shared by *scalene triangle*. Thus, *scalene triangle* has fewer outgoing links.

The above impressions can also be gained from a consideration of the group total-degree centralities, which range from 1.61 (*midline*) to 7.06 (*triangle*), suggesting that the concepts are of different connectedness levels. Logically, *triangle* is the most inclusive of the given set of concepts. The six types of triangles are located at a medium level since they are less inclusive than *triangle* but more general than *symmetry axis*, *median*, and *midline*. There are differences among these types of triangles: the students had fewer links related to *scalene triangle* and *obtuse-angled triangle*, compared to the other four types of triangles, which are more common. The remaining three concepts, *symmetry axis*, *median*, and *midline*, are special properties of triangles, thus, residing at lower levels of “hierarchy”. *Angle* is also a generic concept, but its out-degree centrality is very low, suggesting that these students did not see how *angle* can lead to the other concepts, as illustrated by its isolation in Figure 1. The above degree centrality analysis is consistent with the attributes of the concepts based on logical considerations. This supports the use of this type of analysis for concept maps to probe student conceptual understanding at an individual level (Table 1) as well as group level (Table 2).

Centralities and Mathematics Scores

As shown above, each concept map can be characterised by two group degree centralities, *GIDC* and *GODC*. The following correlation analysis examines the relations between the degree centralities and the students’ school mathematics achievement.

Results from six school mathematics tests were collected. These six tests were two final mathematics tests of the two semesters in Grade 7, the mid-term mathematics test and the final mathematics test of the first semester in Grade 8, and the mid-term mathematics test and a monthly mathematics test within the data collection period in the second semester of Grade 8. These tests measured achievement in several topics such as *equations* and *quadrilateral*, but their correlations ranged from 0.926 to 0.950, all significant at the 0.001 level (2-tailed). Thus, the average score of the six tests was taken as an indicator or proxy of the student’s School Mathematics Achievement (SMA).

To address the fact that the six tests covered different topics, a specially designed conceptual understanding test (CU-test) on *triangle* was administered one day before the concept map task. This CU-test (triangle) was designed according to the first three levels of van Hiele’s theory of geometric understanding, i.e., *visualisation*, *analysis*, and *abstraction*. The items cover definitions and properties of triangles as well as their relationships. Unlike common school mathematics tests that are mainly about solving problems, the CU-test assesses conceptual understanding. As shown in Table 3, this CU-test was also strongly related to SMA, indicating that both measure some underlying mathematics achievement. The results of the correlation analyses are shown in Table 3.

Table 3.
Correlation Coefficients between Degree Centralities and Mathematics Tests

Centralities	Group out-degree (GODC)	Group in-degree (GIDC)	Group total-degree (GDC)	School math achievement (SMA)
Group in-degree centrality (GIDC)	0.156			
Group total-degree centrality (GDC)	0.866**	0.629**		
School math achievement (SMA)	0.357*	0.470**	0.153**	
CU-test (triangle)	0.550**	0.340*	0.338**	0.815**

* $p < 0.05$ and ** $p < 0.001$.

No statistically significant relation was found between group out-degree centrality and group in-degree centrality. Thus, a concept that is “influential” in terms of its outgoing links to other concepts may or may not be “popular” in terms of its incoming links. The correlations between the in-degree and out-degree centralities and SMA and CU-test ranged from 0.340 to 0.550, which are significant at the 0.05 or 0.001 levels. Besides, the group total-degree centrality had higher correlation coefficients with CU-test (0.338, $p=0.019$) than with SMA (0.153, $p=0.298$). This shows that the degree centralities might relate more to students’ conceptual understanding than problem solving since CU-test emphasises conceptual understanding whereas the school mathematics tests were about problem solving.

Conclusion

This investigation supports the idea that degree centralities from SNA can be adopted for analysing concept maps. The degree centralities provide information about the connectedness of the individual concepts within concept maps, which is not easily detected with traditional methods such as scoring rubrics and anecdotal descriptions. The analysis can be readily completed through counting and simple calculations, and this ease of use will be an advantage to researchers and teachers who are contemplating using a concept map as an additional assessment tool. The concurrent validity of degree centralities for

assessing student conceptual understanding has also been demonstrated through correlation analysis between these attributes and mathematics achievement (in particular on CU-test) reported above.

SNA has other techniques not discussed in this paper. Further research can also investigate concept maps using other SNA measures such as *closeness* centrality and *betweenness* centrality. These measures allow examination of the links in concept maps from multiple views to ensure a fuller understanding of concept maps as well as their relations with students' conceptual understanding and mathematics achievement.

References

- Afamasaga-Fuata'I, K. (Eds.). (2009). *Concept mapping in mathematics: Research into practice*. New York: Springer.
- Bransford, J. D., Brawnn A. L., & Cocking, R. R (Eds.). (1999). *How people learn: Brain, mind, experience, and school*. Washington, DC: National Academy Press.
- Degenne, A., & Forsé. M. (1999). *Introducing social networks* (A. Borges, trans.). London: SAGE Publications. (Original work published 1994)
- Durland, M. M. (2006). Exploring and understanding relationships. In M. M. Durland & K. A. Fredericks (Eds.), *Social network analysis in program evaluation* (pp.25-40). Fairhaven, MA: American Evaluation Association & Wiley.
- Hanneman, R. A., & Riddle, M. (2005). *Introduction to social network methods*. Riverside, CA: University of California, Riverside. Retrieved January 5, 2010 from <http://faculty.ucr.edu/~hanneman/>
- Jin, H. (2007). *A study on middle school students' knowledge network of elementary function* [In Chinese: 中学生函数知识网络的调查研究]. Unpublished master's thesis. Nanjing Normal University, Nanjing, China.
- Jin, H., & Wong, K. Y. (2008, November). *Concept maps as a potential assessment tool in mathematics*. Paper presented at the APERA (Asia-Pacific Educational Research Association) 2008 Conference, Singapore. Available from <http://www.apera08.nie.edu.sg/proceedings/1.31.pdf>
- Knoke, D., & Yang, S. (2008). *Social network analysis* (2nd ed.). Los Angeles, CA: Sara Miller McCune, SAGE Publications, Inc.
- National Council of Teachers of Mathematics. (2000). *Principles and standards for school mathematics*. Reston, VA: Author.
- Novak, J. D. (2010). *Learning, creating, and using knowledge* (2nd ed.). New York: Routledge.
- Novak, J. D., & Cañas, A. J. (2009). The development and evolution of the concept mapping tool leading to a new model for mathematics education. In K. Afamasaga-Fuata'I (Ed.), *Concept mapping in mathematics: Research into practice* (pp.3-16). New York: Springer.
- Novak, J. D., & Gowin, D. B. (1984). *Learning how to learn*. Cambridge: Cambridge University Press.
- Ruiz-Primo, M. A., Schultz, S. E., Li, M., & Shavelson, R. J. (2001). Comparison of the reliability and validity of scoring from two concept-mapping techniques. *Journal of Research in Science Teaching*, 3(2), 260-278.
- Shavelson, R. J., Ruiz-Primo, M. A., & Wiley, E. D. (2005). Windows into the mind. *Higher Education*, 49, 413-430.
- Wasserman, S., & Faust, K. (1994). *Social network analysis: Methods and applications*. New York: Cambridge University Press.

Impact of Context and Representation on Year 10 Students' Expression of Conceptions of Rate

Sandra Herbert
University of Ballarat
<sandra.herbert@deakin.edu.au>

Rate is an important, but difficult mathematical concept. More than twenty years of research, especially with calculus students, report difficulties with this concept. This paper reports on an alternative analysis, from the perspective of multiple representations and context, of interviews probing twenty Victorian Year 10 students' conceptions of rate. This analysis shows that multiple representations of functions provide different rate-related information for different students. Understandings of rate in one representation or context are not necessarily transferred to another representation or context.

Rate is an important mathematical concept needed for everyday numeracy and important for more advanced areas of study, such as calculus. Despite considerable research in the area it remains a troublesome concept to teach and learn. Even many calculus students have found rate particularly troublesome (Ubuz, 2007). Rate is a complex concept comprising many interwoven ideas. It expresses the change in the dependent variable resulting from a unit change in the independent variable and involves the ideas of change in a quantity; co-ordination of two quantities; and the simultaneous covariation of the quantities (Thompson, 1994). Improvement of conceptions of rate held by students who have not yet studied calculus may, in turn, also address some of the difficulties experienced by students studying calculus identified by many researchers. Functions, and hence, rate may be represented numerically, graphically and symbolically. Kaput (1999) emphasises the importance of connections between everyday experiences and these multiple representations. This study investigates the nature of these connections in two particular real world contexts.

This paper builds on Herbert and Pierce (2009) which describes the educationally critical aspects of rate (see Figure 1) resulting from the phenomenographic analysis of the interviews. These aspects provide a framework for further content analysis of the same interview data from the different perspective of context and associated multiple representations of functions resulting from the simulations.

1. rate as a relationship between two changing quantities.
2. rate as a relationship between two changing quantities which may vary.
3. rate as a numerical relationship between two changing quantities which may vary.
4. rate as a numerical relationship between any two changing quantities which may vary.

Figure 1. Critical aspects of rate.

This re-examination of the data is considered appropriate since Boulton-Lewis and Wilss (2007) suggest that data collected for a phenomenographic study can also be analysed in other ways to investigate other research questions, which, in conjunction with phenomenographic results, allow a fuller understanding of the data and, so, determine the impact of context and representation on Year 10 students' expression of their conceptions of rate.



Method

The twenty Year 10 participants, from five different Victorian secondary schools, were selected by their teachers, to represent a range of mathematical ability and a mix of gender. It was expected that these participants had previously experienced constant rate in the form of linear functions (VCAA, 2007). Two interactive computer simulations, one in *Geometer's Sketchpad* (GSP) (Key Curriculum Press, 2006) of a blind partially covering a window (see Figure 2), and the other in *JavaMathWorld* (JMW) (Mathematics Education Researchers Group, 2004) of a frog and clown walking (see Figure 3) were prepared.

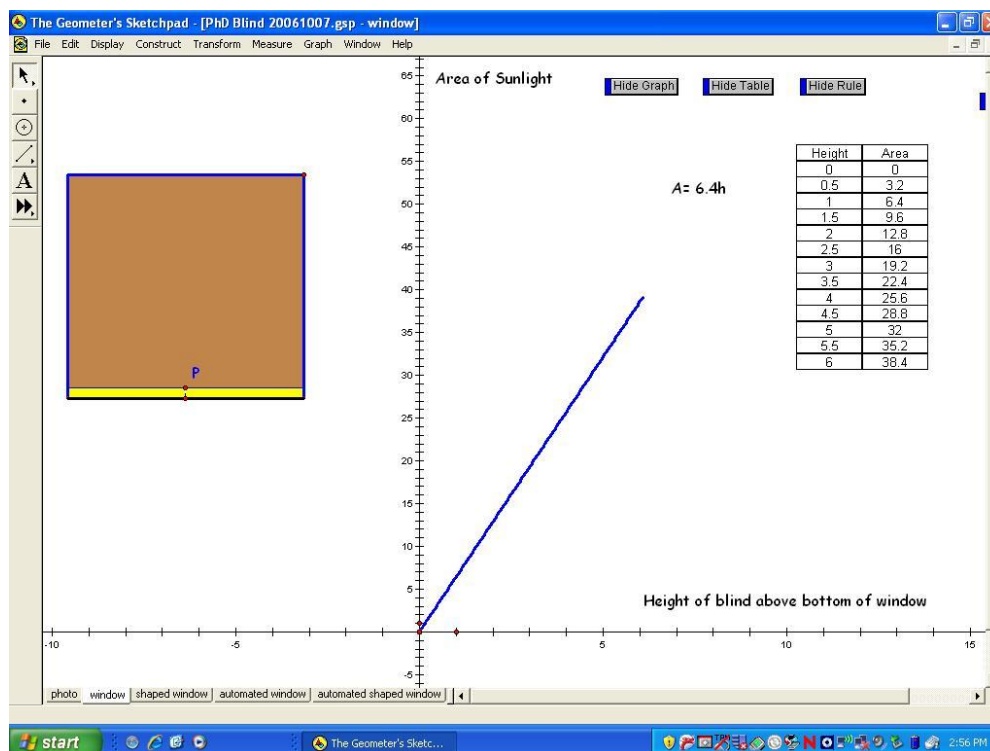

Figure 2. Screen dump of the GSP simulation showing representations.

These two simulations provided participants with concrete examples of rate to facilitate discussion in video-recorded interviews of approximately forty-five minutes in duration. GSP and JMW were particularly well suited for this purpose as they provide easy access to numeric, graphic and symbolic representations, so participants' conceptions of rate could be explored more broadly. In particular, they were chosen to explore participants' expression of their understanding of a rate involving motion compared with a rate where time is not a variable. In the GSP simulation, the context of the blind partially covering a window (see Figure 2) facilitated discussion of the participants' understanding of constant rate, where area and height are the rate-related variables. This facilitated discussion of the participants' understanding of constant rate in a different context where distance and time are the rate-related variables. The JMW simulation involved frog and clown walking at constant speed (see Figure 3) enabling comparison of their speeds. Like GSP, the dynamic links between the numeric, graphic and symbolic representations in JMW enabled the relationship between distance and time to be explored and provided opportunities for discussion of participants'

understanding of constant speed in these representations. Participants were encouraged to explain their reasoning and think aloud as they were presented with different representational forms of rate: the simulation, table of values, graph and rule.



Figure 3. Screen dump of the JMW simulation showing representations.

The content analysis began with a re-examination of the data. Each participant's responses relating to rate were coded by representation (numeric, graphic or symbolic) and context (blind or walking). All responses were examined to discern any impact of the multiple representations and contexts on individual participant's expression of their understanding of rate.

Results

The results are illustrated by appropriate quotations from the interview data. Excerpts were chosen for inclusion within the discussion to: exemplify influences identified in the participants' responses; clarify and justify inferences made by the researcher; and demonstrate the detail of the data. The following sections present a comparison of responses between different representations and contexts demonstrating the relative influence of representations and contexts in participants' expression of their thinking about rate.

Comparison of Participants' Responses to Numeric Representations

The numeric representation in the GSP context (see Figure 2) provided rate-related information to most participants (13). This is illustrated by the responses given to the question "What does the table tell you about the rate that the area of the sunlight is changing?". Eleven participants could see the pattern in the columns of the table and use it

to express the numeric relationship between the variables, for example: “Well, yeah, three point two, there’s a difference between um, [pause] so for every half a metre you get three point two extra” (I15). Whilst two participants provided a qualitative description, for example: “The more height, the more area of sunlight. It’s just going up at a steady rate” (I9). Six participants were unable to give a rate-related response, focusing instead on only one variable, for example: “It’s always like 3.2, it’s always adding 3.2 the area [pause] like 6.4 plus 3. [pause] as a guess. I don’t know. What I’m looking at, it’s from 6.4 to 9.6 its grown 3.2 [pause] in that sort of pattern, mainly” (I2). Three other participants made other responses indicating their lack of awareness of any relationship between the variables of height and area. “It [table] tells you the different heights and the different area of sunlight”(I1).

The numeric representation in the JMW context (see Figure 3) provided rate-related information to all participants. Every participant could express some understanding of the relationship between distance and time. Most participants (14) could even use the information in the table to calculate a numeric rate. This is seen in their responses to the question “What does the table tell you about the rate that the frog and clown are walking?”, for example: “The red one [clown] is walking faster. He’s [clown] going 3.1 metres in 1 minute. He’s [frog] only going 1 metre in 1 minute” (I1). Other participants expressed other interesting aspects of their quantitative understanding of rate in the JMW context. These responses indicate the perceptual nature of participants’ understanding of speed influences their discussion of the relationship between the variables of distance and time, for example: “I can see the clown is walking faster. If you look at the time column at 7 time and look at A. He has covered more distance than B. [I chose 7] because that’s when [clown stopped] I could choose any number before seven because they would still be walking at the same time, I am comparing that with the same time” (I2). Only two participants were unable to give a quantitative description of rate, for example: “Both of them are increasing. I would need distance and that’s the time” (I4).

Comparison of Participants’ Responses to Graphic Representations

In the GSP context the graphic representation provided some information about rate for about half (9) of the participants. This is illustrated by the following quotes, in response to the question, “What does the graph tell you about the rate?”. Four participants could read approximate values from the graph and give a quantitative relationship between the variables, for example: “Well after it every 5 it’s going up roughly, I’d roughly say 30, yeah sorry about 32 and the area of sunlights going up is about 32 [every] 5 metres” (I21). Two participants were aware of the two variables, area and height, involved in the rate, and responded with a description of the relationship between the variables in qualitative terms, for example: “That when the height of the blind, [from] the bottom of the window goes up, the area of sunlight increases” (I15). Six participants expressed their understanding of rate in terms of the shape of the graph, for example: “Just that like it’s always, I dunno, that it’s in a straight line, it means that [rate] is always going to be, like the same” (I5). The graph provided little or no information about rate for more than half (11 out of 20) of the participants. Seven participants demonstrated a lack of awareness of the relationship between the variables involved in the rate and the actual rate, for example: “Um, that the height is 7” (I1). Four participants were aware of the two variables involved in the rate and could read values off the graph, but not see what these values had to with the rate, for example:

I12: Ah, the area of sunlight is 40 and the height of the blind above the bottom of the window is 6.

R: What does that tell you about the rate?
I12: I'm not sure. Would it be the rate increasing?

In the JMW context, the graphic representation context provided some rate-related information to every participant. Five participants could read values off the graph and express them as the numeric rate, for example: "Well he [clown] goes 3 metres per second. Divide 22 by 7. [For the frog] just divide the 10, this number here which is just 10, wait that'd be 1 yeah, yep it'd [speed of frog] be 1" (I13). Five participants demonstrated awareness that the relationship in constant rate is the same regardless of which points a chosen from the graph, for example: "Well a total of 10 metres, that was the maximum, you can really use any point" (I17). Points on the graph were used to give values needed to quantify rate and there was less emphasis on the shape of the graph. Only three participants commented on the connection between the shape of the graph and rate, for example: "The rate stays pretty much the same because the lines don't have any curves in them, they are nice and straight" (I11). Almost all (15) participants attempted to quantify rate as a numerical relationship between the variables of distance and time, for example: "It takes him [frog] 2 metres, 2 seconds to do 2 metres where it takes the clown roughly to do 2 it takes him 6" (I21). Only one participant's description of rate was limited to merely qualitative terms, for example: "It looks like the clown is walking faster Um, because he's covered more metres" (I18).

Some confusion between rate, distance and time is illustrated by the following exchanges. It seems that these two participants have some understanding of the concept of rate, but do not connect it to the word 'rate' in this context. The following two exchanges illustrate this confusion.

R: Can you tell me anything more about the rate the frog and the clown are walking?
I10: The frog is walking about 2 metres per 2 seconds and the clown's walking 6 metres for 2 seconds.
R: Anything else you can tell me about the rate that they're walking?
I10: Frog walked for longer. Clown walked more seconds.

I1: Well, he[clown] walks 22 metres in 7 seconds and then he [frog] only makes 7 metres in 7 seconds
R: So who's walking faster?
I1: That one, the red one.
R: What rate is he walking do you think?
I1: I don't know.

Two participants referred to rate as the result of a formula calculation possibly remembered from science education, for example: "There's a formula for that [pause] yes we did that in science. We have done velocity and that. We have got time and distance, so we have got velocity, distance and time, so 22 metres divided by 7 is [pause] he's (clown) going at 3.14 metres per second. For the frog, I don't know if that would make a difference, I will do it up to 7 [pause] it's doing 1 metre per second. You would get those measurements, of course, and divide the distance by the time" (I4).

Comparison of Participants' Responses to Symbolic Representations

In the GSP context, the participants expressed almost no rate-related comments in response to the question, "what does the rule tell you about the rate?", for example: "That might even be [pause] to be quite honest, I have no idea" (I22). Other participants responded to this same question by translating the symbolic representation into words. Two participants went further by describing the process of substitution of values for height into the rule to calculate the corresponding values of area. These participants did not

isolate the rate from the symbolic representation. Possibly they were trying to tell the researcher as much as they could about the symbolic representation and did not restrict their discussion to rate, for example: “Um, the, for every area of sunlight It’s six point four of the H, so for example one point five the height from the bottom times it six point four and gives how much area of sunlight area there is. I don’t know it’s [the rule] just kind of representing that, every time you lift it up you find the area of the thing, of sunlight increases by six point four times the height, so it’s just a matter of the mathematical formula at the end of how to work out how to do that” (I6). Other responses demonstrated confusion between rate and the changes in the variables, for example: “That the rate of them the height rate is [pause] gets higher as the area of sunlight does” (I5).

In the JMW context, the symbolic representation did provide some rate-related information to most participants. Seven participants could correctly identify the walker from the symbolic representation suggesting that they could connect the rate of the walker with the symbolic representation, for example when responding to the question “This is the rule for one of my walkers, who is it for, the frog or the clown?”, for example: “It would be the clown, the clown’s rule because the frog is nice and easy to work out. He’s just 1. He’s [clown] got roughly 3 here, so 3.1 fits in nicely” (I11). It is difficult to discern what rate-related information participants gained from the rule as the rate had not been varied from the questions relating to the table and the graph, for example:

I18: The clown.

R: How can you tell?

I18: Um, I remembered that.

When a different question was asked “What do you think the rule might be for the clown?” two participants were able to describe the symbolic representation from the previously known rate, for example: “Well if it was around three units per metre, if it was the clown it would be M for metres equals three F, I’m not really sure” (I19).

Seven participant’s choice of response to the question “This is the rule for one of my walkers, who is it for, the frog or the clown?” demonstrated little rate-related reasoning, for example: “I guess the clown” (I2). The following quote demonstrates that this participant was seeking a formula to use to determine their choice of matching a walker to the given symbolic representation. “Clown, because when I worked it out before it is going up by 3.1 and the frog is, it’s quite [pause], I dunno, straight forward. Well for the time, well we can always put distance over time. I can’t remember it. I don’t know if this is going to work. I can’t really remember it but, I’m trying to remember a rule with a particular formula and you need the gradient. Maybe I just, I don’t know” (I17).

Discussion

Analysis of data showed that many participants could obtain information about constant rate from the numeric representation. The graphic representation was often used to determine co-ordinate points along the line to calculate constant rate. Only one participant referred to the gradient of the line and its relationship to rate. Whilst many of the participants were able to communicate ideas about rate in the form of tables and graphs, no participant linked the symbolic representation to rate in the GSP context. It is surprising that no participant expressed the connection of the symbolic representation to gradient, hence rate, as it was expected that their prior experience with the symbolic representation of linear functions (for example see Bull et al., 2004) would have emphasised the meaning of the co-efficient of the variable as gradient. However, in the

JMW context, four participants expressed some connection of the symbolic representation with rate, possibly because of the understanding of speed participants brought to their discussions of rate. These findings indicate that the participants did not move seamlessly between representations and that understandings demonstrated in one representation do not necessarily transfer to other representations. This is consistent with Amit and Fried's (2005) report that questions whether the potential of multiple representations, to enhance students' understanding of functions, is realised in the classroom. It appears that the participants of this study do not transfer their understanding of rate demonstrated in tables and graphs to the corresponding symbolic representation.

Stronger understandings of rate demonstrated in the JMW context were not evident in the GSP context. The GSP context preceded the JMW context for all participants as required by phenomenographic interviewing requirements, so it is possible that this influenced some participants' responses to questions relating to the JMW context. However, this is considered unlikely because the participants were not considered to be gifted mathematically, so it is doubtful that they could have learnt something new so quickly. Even the weakest participants demonstrated better understanding of rate in the JMW context than in the GSP context. These findings indicate that understanding of rate in a JMW context is much stronger than in the GSP context. This is more than would have been expected if understanding developed the GSP context had any effect on the understanding in the JMW context. This suggests that speed is better understood as a rate expressing a numeric relationship between distance and time, than the relationship between area and height in the GSP context. Findings of this study indicate that whilst rate appears to be quite well understood in the context of walking, this understanding does not automatically transfer to the blind context. So, specific instruction connecting rate in a motion context to other rates would be necessary to capitalise on the understanding of rate in a motion context, which many participants seemed to bring from their prior experiences in science classrooms, or experiences outside of the classroom. Alternatively, initial treatment of rate emphasising the covariational approach suggested by Carlson et al. (2002), and utilising speed, density and other rates as examples, rather than substitutions in formulae, may support the development of rate as a numeric relationship. Although the researcher's questions used the word 'rate', some participants spontaneously used the word 'speed' when discussing rate in the JMW context, so for these participants, rate, in this context, seems to be synonymous with speed. So this may be an example the difficulties associated with rate having a label in natural language suggested by Lamon (1999). It appears that speed may be seen as a single entity with little emphasis on the covariance of the variables of distance and time.

Whilst the selection of the participants was intended to result in capturing a wide diversity of conceptions, limiting factors may have been the teachers' selection of the participants from their school; the inarticulate responses given by many participants; or their lack of appropriate vocabulary with which to discuss rate.

Conclusions

This study shows that multiple representations of functions provide different rate-related information for different students and understandings of rate in one representation or context are not necessarily transferred to other representations. Results indicate that speed as a phenomenon is quite well understood by these participants, but this understanding was not necessarily helpful in understanding rate in a context not involving speed. In addition, results indicate that numeric and graphic representations support the

expression of rate-related reasoning, but the symbolic representation was of little value in facilitating participants' expression of their conceptions of rate. This study confirms the notion that rate is a complex concept and informs teachers of the different ways in which students read meaning into the concepts they are learning.

References

- Amit, M., & Fried, M. (2005). Multiple representations in 8th grade algebra lessons: Are learners really getting it? In H. Chick & J. Vincent (Eds.), *Proceedings of the 29th Conference of the International Group for the Psychology of Mathematics Education* (Vol. 2, pp. 57-63). Melbourne: PME.
- Boulton-Lewis, G., & Wilss, L. (2007). Maximizing data use: Mixed qualitative methods. In P. Mayring, G. Huber, L. Gürtler & M. Kiegelmann (Eds.), *Mixed methodology in psychological research* (pp. 15-23). Rotterdam: Sense.
- Bull, I., Howes, B., Kimber, K., Nolan, C., & Noonan, K. (2004). *Maths for Vic 9*. Melbourne, Australia: Pearson Education.
- Carlson, M., Jacobs, S., Coe, E., Larsen, S., & Hsu, E. (2002). Applying covariational reasoning while modeling dynamic events: A framework and a study. *Journal for Research in Mathematics Education*, 33(5), 352-378.
- Herbert, S., & Pierce, R. (2009). Revealing conceptions of rate of change. In R. Hunter, B. Bicknell, & T. Burgess (Eds.), *Crossing divides: Proceedings of the 32nd annual conference of the Mathematics Education Research Group of Australasia*. (pp. 217-224). Palmerston North, NZ: MERGA.
- Kaput, J. (1999). Teaching and learning a new algebra. In E. R. Fennema (Ed.), *Mathematics classrooms that promote understanding*. (pp. 133-155). Mahwah, NJ, US: Lawrence Erlbaum Associates, Publishers.
- Key Curriculum Press. (2006). *Geometer's SketchPad*.
- Lamon, S. (1999). *Teaching fractions and ratios for understanding: Essential content knowledge and instructional strategies for teachers*. London: Lawrence Erlbaum Assoc.
- Marton, F. (1981). Phenomenography: Describing conceptions of the world around us. *Instructional Science* (Historical Archive), 10(2), 177-200.
- Mathematics Education Researchers Group. (2004). *SimCalc Projects*. Accessed August 22, 2005, from <http://www.simcalc.umassd.edu/>
- Thompson, P. (1994). Images of rate and operational understanding of the fundamental theorem of calculus. *Educational Studies in Mathematics*, 26, 229-274.
- Ubuz, B. (2007). Interpreting a graph and constructing its derivative graph: Stability and change in students' conceptions. *International Journal of Mathematics Education in Science and Technology*, 38(5), 609-637.
- Victorian Curriculum and Assessment Authority (VCAA). (2007). *Victorian Essential Learning Standards*. Retrieved May 31, 2007, from <http://vels.vcaa.vic.edu.au/essential/>

Year 11 Advanced Mathematics: Hearing from Students who Buck the Trend

Kai Fai Ho
Murdoch University
<k.ho@murdoch.edu.au>

There are concerns about the trends and patterns in enrolments in senior school mathematics. Shortages of suitably qualified teachers and dwindling students' demand for Advanced Mathematics have led some Western Australian schools to collaborate to provide an otherwise unavailable opportunity for their students to study Advanced Mathematics. It is of research interest amidst the downward trends in enrolment to learn about such students, to hear about their experiences and perspectives. This paper reports parts of the initial findings.

In recent years, trends and patterns in enrolments in senior school mathematics¹² have raised many concerns. Numerous studies have highlighted the downward trend in the number of students enrolled in Advanced Mathematics (for e.g., Ainley, Kos & Nicholas, 2008; Chinnappan et al., 2007; Forgasz, 2006). As reported in Barrington (2006), Advanced Mathematics students as a percentage of Year 12 decreased from 14.1% in 1995 to 11.7% in 2004 across Australia. For Western Australia, the decline was from 12.6% in 1995 to 8.4% in 2004. In an update, Barrington reported that the 2004 enrolment of 11.7% had decreased to 10.2% by 2007 (Rubinstein, 2009).

Underpinning the declining numbers are concerns about shortages of suitably qualified mathematics teachers (Harris & Jensz, 2006; Chinnappan et al., 2007) and *possible* changes in students' interests and perceptions of higher-level mathematics (McPhan et al., 2008). In a report prepared for the Australian Council of Deans of Science (Harris & Jensz, 2006, p. 10), of the 621 schools surveyed across Australia, Elementary and Intermediate mathematics were taught by the majority, while Advanced mathematics was offered by just 64% of the schools. Many schools cited insufficient demand from students for not offering Advanced mathematics while some schools indicated a shortage of qualified teachers. According to Thomas, Muchatuta and Wood (2009), some schools in relatively affluent areas of Melbourne had reported that they had problems recruiting qualified teachers; dropping electives and enrichment classes for Year 10 students in spite of student demand and consequently found insufficient student demand to justify offering Advanced Year 12 Mathematics – a possible case of shortage of qualified teachers in earlier years affecting student demand for Advanced Mathematics in *subsequent* years.

Besides shortages of suitably qualified mathematics teachers, there are other factors that contribute to the dwindling student demand for Advanced Mathematics. McPhan et al. (2008) found, among other things, that the perception of difficulty of higher-level mathematics and the associated heavy workload as well as the greater appeal of less demanding subjects influenced students' decision.

At the broader level, the declining numbers raise strategic concerns about Australia's future, in particular, her ability to produce enough young people with sufficient mathematical background to pursue careers deemed crucial to maintaining Australia's place in the technological world (Rubinstein, 2009; Tao, 2008; Australian Academy of

¹² Based on the categories of Elementary, Intermediate and Advanced Mathematics as described by Barrington & Brown (2005).



Science, 2006). Should the downward trend continues, the long-term outlook does not bode well for Australia and for mathematics education.

Nevertheless, there are high school students who want to enrol in Advanced Mathematics courses. The decline in enrolment is not uniformly distributed; it appears to be more pronounced in poorer suburbs or regions deemed predominantly lower in socioeconomic status. Increasingly, students from such areas, who wish to enrol, face an additional disadvantage of not being able to do so at the schools they attend.

Clearly, attracting and retaining student interest in mathematics is of strategic importance for many reasons (Australian Academy of Science, 2006; Rubinstein, 2009). One way to address the enrolment situation is for a group of schools to collaborate to provide their students with better access than a single school can offer. The current study arose from one attempt to implement such a strategy.

The Study

Five high schools from a region deemed lower in socioeconomic status formed a collaborative partnership to offer Western Australia's Specialist Mathematics¹³ 3A/3B to a combined group of students. In collaboration with a university, the classes were held in its regional campus, providing students with additional resources and support.

The initial enrolment was 18, out of the total of about 1000 Year 11 students in the five schools; less than 2% of the combined cohort. Given the broad backdrop of dwindling enrolments and the 'working class' region the schools were in, it was indeed uncommon for students to enrol. It was of strategic importance that more should be known about them.

The study was designed to address the following research questions:

- What are the backgrounds of these students?
- Why did the students enrol in Specialist Mathematics?
- What or who encouraged their interest in mathematics?
- What or who has helped/hindered in their learning of mathematics?
- What would help them stay on the course?
- (For students who discontinued) Why did they discontinue the course? And what might have supported them to continue?

Besides collecting background information about the students, it was hoped that their responses to the other questions would provide a qualitative dimension to an important area of research. While broader-scaled studies such as the one done by McPhan et al. (2008) had looked into various factors affecting students' choice of subjects, this study investigated students who were already enrolled and why some of them discontinued. It aimed to glean insights into students' experience and perspectives by listening more *directly* to what they say, to lend credence to the student's voice to inform *practice* (Rudduck & McIntyre, 2007).

Method: Questionnaire and Interview

The study involved a small number of students. Data was collected through a questionnaire and individual semi-structured interviews. The items in the questionnaire covered students' background, their experience of mathematics in school and some open-

¹³ Specialist Mathematics is regarded as Advanced Mathematics under Barrington & Brown (2005)'s categorisation of Senior School Mathematics subjects; previously *Calculus* was taken as Advanced Mathematics in Western Australia

ended items including what had helped them stay the course and, for those students who discontinued, their reasons for discontinuing and what might had helped them stay.

The interviews were semi-structured with a prepared set of questions as a guide. The students were asked: (i) their reasons for doing the course, (ii) what or who had influenced their attitudes towards mathematics, (iii) what have helped them in their learning environment, (iv) about students' perspectives of 'status' of mathematics in Australia, in their school, and amongst their peers, and (v) if they enjoy the course. The interviews were transcribed. The content of the transcribed data was analysed to identify the range of responses and themes. An interpretive inquiry approach is adopted to address the research questions.

Results and Analysis

The cohort of ten students in the targeted class comprised nine boys and a girl. The questionnaire was administered and each of the ten was interviewed individually over a period of two weeks. In addition, attempts were made to contact the eight students who had discontinued from the course. Four of these (two boys and two girls) responded; they were given the questionnaire, and three of them were interviewed while the fourth was not available. Because of the constraints of space, this paper will focus on students' responses to the interview questions (i), (iii) and (iv), as well as parts of the interviews with students who discontinued with the course.

Students' Responses to the Interview Questions (i), (iii) and (iv)

(i) *Reasons for enrolling in Specialist Mathematics.* It appears that all students who had enrolled in the Specialist Mathematics course had some aspirations to higher education, particularly going to the university and doing courses related to careers they want to pursue. They considered enrolling in Specialist mathematics as something that they either need or would give them more options in University courses. Dennis's¹⁴ response was typical:

Dennis: I take it because I like maths obviously, and it opens more doors for you to get into Uni. Firstly it highers your TEE score which is always good and also if you can't get into one thing into Uni then you can get into other stuff because you have that basic Maths and even more than basic, you know the foundations, to get into other stuff, so it just opens more courses into Uni.

Jack: Ah, I need it for university, my university degree for Engineering.

Such aspirations are consistent with what McPhan et al. (2008, p. 18) listed as one of the influencing factors "impacting on students' decision to undertake higher-level and further mathematics".

It was fairly obvious that the group as a whole liked mathematics and generally did well in it. One or two students felt that they were not doing very much in their (regular) mathematics classes and were getting good grades without much of an effort. Chris cited the following as one of his reasons for enrolling in Specialist Mathematics:

Um, a good opportunity. I've always just sat around not doing very much in maths and getting an A, so I thought I'd challenge myself um also need it for when I leave school, want to be an Engineer, I need this to get into Uni.

Another student, Eddy, expressed a similar view:

¹⁴ All students' names are pseudonyms

I joined it because I found the mathematics that I was doing, or the general mathematics I was doing at school relatively easy and I like to have a challenge so I thought well this might actually challenge me and I might actually learning something new, so I thought "I'll do this then".

While some took it to challenge themselves, others were encouraged or recommended by their teachers to enrol:

Always been interested in that ... maths ... I guess, and wanted a challenge I guess. And my teachers recommended me for it, so I decided to do it.

Because my teacher came to me and he said "you should do this" and because I've yeah, I've always liked my maths, enjoyed it and I find that was a good choice.

My teacher last year (i.e. Year 10) started me doing the Year 11 math... she said I could probably do Specialist Maths which would challenge me more instead of getting frustrated with the simple maths. So that's mainly why I sign up for it

(iii) *Who or what has helped/hindered in their learning environment?* Many of the students responded that they found the email access to the teacher very useful:

... having constant access to a ... communication with the teacher ... through email has really helped when I get stuck, and stuff like that. Umm ... yeah ... it's very much the only tool I use I guess to learn ... in the environment

They appreciated the constant availability of help, day and night and the speedy response from the teacher, especially when they were stuck with a math problem and did not know what to do. Given that there were only two two-hour lessons per week conducted on Tuesdays and Thursdays at an off-school site, this constant availability of help via the email appears to provide an alternate avenue for students to *access* the teacher. The intensity and the lack of a tutorial or a help session between the lessons proved to be an issue for one of the student (who eventually discontinued with the course). So while some students found the email access to the teacher and her fast response helpful, others did not draw upon this accessibility for one reason or another, preferring face-to-face help sessions.

When asked about what hindered their learning of mathematics, many of the students pointed to their own laziness (often with a laugh):

Um, yeah, my laziness [laughs], and that's about it. I'm pretty lazy, I needed to put in more work and then I'd succeed a lot better.

I'm a bit lazy [laughs]. I can be a bit lazy sometimes and just leave my homework to the last minute.

... the only thing that could hold me back is my own laziness sometimes but besides that I mean you have the book, you have the teacher, you can email the teacher you can ask the teacher, you can even ask the teachers at your own school, I mean the maths teachers anyway. We have the resources and nothing is really blocking us to our own knowledge, it's just our own laziness or willingness that you could say, yeah.

Other forms of hindrances at the individual level include personality traits or habits like being easily distracted and losing concentration especially when stuck with a (math) problem.

On a broader scale, the school's ethos and the prevailing classroom culture can help or hinder the students' learning. To Chris, being in the senior school made a lot of difference; the classroom environment was crucial:

... Teachers in senior school are a lot better than middle school. They are a lot more motivated. The fact that in senior school, doing the tertiary subjects it's only the kids that only really want to be there that are doing those subjects, so you don't have the idiots mucking around all lesson. So the

teacher's attention is focused towards those who want to learn rather than those who are misbehaving.

So for Chris, a teacher's focused attention on learning in the classroom environment made a lot of difference to him. In contrast, a classroom with a number of students who were misbehaving and/or unmotivated to learn takes the teacher's focus away from teaching and hinders the other students' learning.

In the following exchange between the interviewer and Ben, the discussion centred around the idea of 'adjusting' the difficulty level of Specialist Mathematics and some other school subjects:

Ben: ... you can't drop this course (Specialist Maths) down any more, make it any more simple than it is. Because then it wouldn't be the course it is. And you can't make the school courses harder or more challenging because the majority of people that undertake them fail anyway. Like in my chemistry class there's four people passing. So we don't even do work now, the kids that are passing. Because they're so busy trying to get everyone else to pass. So it's pretty much ... the gap is like influenced by what other people want to do, and the amount of work that everyone else wants to put in. So it's pretty bad.

Many would agree with Ben that it would not make much sense to simplify the Specialist Mathematics course further without also changing the nature of the course itself. It is the second point that highlights what might be hindering Ben's learning (albeit in this case it was a chemistry course). He related how the teacher responded to the majority of the students in the class, focusing on 'trying to get everyone else to pass' and somewhat neglecting the four who were passing. A critical mass of uninterested students affects the whole class:

Ben: ... Like there's only three of us in the class that do this (Specialist Mathematics course) in my school; so when we have (mathematics) sessions at school, it's just ... so much harder to get stuff done ...

Ben opined that having a larger number of people doing the same course and wanting the same goals might make the environment more conducive to learning. As it was, with only three of them in his school sharing his interest in mathematics, it was "so much harder to get stuff done."

Ben went on to relate how he felt like he was in a minority group, struggling to learn within the given school context:

Ben: It's not hard. You can still do it. It's not ... you can't cry about it. But it's obviously a disadvantage, if you think about it, being in a public school ... when no one else will work. Can't force them to work. No strict rules or anything like that. Just doesn't help you along I guess ...

When 80% of my school are going to go to TAFE or drop out next year. They don't cater much for university kids, at least university-bound kids. Like my year 10 course counsellor said ... didn't even let me into these courses or any of the physics and chem and that ... they said "no, you'll struggle, you can't do the TEE subjects". I said "well I'll do the work" and they said "yeah we've heard that before, we don't want to let you in" and then ... I finally talked to the principal, had an interview, got into all these courses and now I'm like averaging first, second in the school, and like you know, straight As pretty much so ... it's just they don't get it, I guess.

... Yeah, I don't know if it's like that everywhere, but... it seems... they really don't want to put effort in to get kids to go to uni. Or they'd much rather say "yeah you can just cruise and go to TAFE and we don't really ... we do mind, but ..." yeah... it's all up to you pretty much in a school like that.

The overall ethos in school and the prevailing classroom culture did not make for a conducive learning environment for Ben. Certainly, he felt unsupported in his quest to

want to learn and his aspiration to go to the university. He had to deal with his school's low expectations to avail himself of the opportunities to study the courses that he wanted.

Chris and Ben's views appear to be one aspect of the disciplinary climate discussed in PISA's *Learning for Tomorrow's World* (OECD, 2004, p. 208ff); that the environment in the school and the classroom do help or hinder students' learning very significantly. While Chris and Ben pulled through, one wonders how many did not.

(iv) *Students' perspectives of the status of mathematics in Australia.* The general perspectives that emerge from the interviews were that mathematics was not well 'recognised' or highly valued by students; that mathematics was a difficult and not a very well-liked subject in school. While the students recognised their own particular personal interest in mathematics, they were also aware that they were the exceptions. Many of their peers did not share their liking for mathematics enough to enrol.

Chris: A lot of people could do it (Specialist Mathematics). Um ... for instance there's one girl who is in half of my subjects at school and she's averaging for the subjects she's in with me, 80-90%, but she didn't do this. So she could, I think that was so she could focus on a third science subject, but one of my friends, he could have done this but he was just like "nah, I can't be bothered" and it was going to involve more homework so he was just like "nah".

The issue of perception of status of mathematics was not just a purely personal one. The overall impression from the community affects the perception, in particular the lived day-to-day experience of the individual student immersed within the ethos of the school and the classroom culture. When asked about the status of mathematics at his school, Ben responded:

Ben: ... Um many people... a lot of people don't like doing it. They think... they blame the maths teachers for them not being able to understand and stuff like that, always making excuses, never want to try and learn maths and that. It's pretty bad.

Ben did not think that mathematics was either highly regarded or valued; many of his peers in his school were not willing to put in the effort to learn. He made a comparison with private schools:

... our school's only got three kids doing this course but the private schools have all got up to 80 kids doing similar maths levels so that really puts us in a bad spot kind of thing.

Apparently, going by the perceived discrepancy in the number of students doing higher-level mathematics, the status of mathematics would be deemed somewhat higher in the private schools. This comparison with private schools raises many questions, particularly, of access to resources and social equity. These are pertinent questions but they lie outside the confines of this present study.

Interviews with Students who Discontinued with the Course: A Snapshot

The interview questions were: (i) Why did they discontinue the course? (ii) What might have supported them to continue?

The common themes that ran through the interviews of the three students, who discontinued with the course, were the demanding nature of the course, including the amount of work and homework they had to do, and the appeal of less demanding subjects (McPhan et al., 2008). They found the requirements and the expectations disproportionate to the other subjects they were taking; they found it hard to balance the time and effort required to meet the demands of the course along with the other subjects. The 'decider'

was the poor grades they were getting in their class tests. Mia shared her reasons for discontinuing:

Because ... ah ... 'cause I didn't think it (Specialist maths) was going to be that hard and you have to ... I didn't realise that you had to put so much effort into it like ... Maths like I am doing so well in maths (2A and B) right now and I'm not even doing any work because it was easy. But I didn't realise how much you have to do in the specialist course ... and it was so much it was like you always constantly be doing the work if you want to even get a like a 'C' in it ... and after I did the test I fail ... that I was like well this isn't really cool that I even know if I should be in this anymore.

Travelling to and from the class venue was also mentioned as another reason students cited for tipping their decision to discontinue. Karen alluded to transport as one of the additional reasons she had for discontinuing:

It's kind of travelling from here to Murdoch all the time. And originally when we signed up for the course there was going to be transport to go up there ... and then after that the first lesson, we got told we have to find our own way there. My dad works in the city and my mum works here so they can't get time off so it was really hard for my parents to try and get us up there.

Some alternative arrangements were made but it did not quite work out. She was told then to either take a bus or a taxi. Both options were not viable as her parents did not want her to go on public transport outside of the normal school travel time and taking taxis incur additional financial costs.

On the question of what might have supported them to continue, Mia suggested that a better preparation leading up to the course would have given her a better chance of coping and continuing. She thought the transition from Year 10 Mathematics to Year 11 Specialist Mathematics was "too big for most of us to handle so we didn't really know what we had to do." She suggested that, towards the end of Year 10, students who actually wanted to do Specialist Mathematics could be given some general idea of the topics and even get started on some and that would have made the transition easier or at least less problematic. The idea of preparing Year 10 students was also mooted by a few other students.

Conclusion

The study provided a platform to hear from a group of students who enrolled in an Advanced Mathematics course made possible through their respective schools banding together. The value of hearing from students consists largely in their capacity to alert schools to possible ways of addressing the deficiencies, shortcomings, and/or areas of need (Rudduck & McIntyre, 2007). The initial hearings of the students' voices, as it were, highlighted some things, raised some questions and offered some suggestions.

That the students were able to avail themselves of the opportunity to enrol in the course, continue with it, and found it generally enjoyable suggest that the arrangement was working to some extent. Though the transport problem became an issue for some students, contributing to them leaving the course, the remaining students adapted to the arrangement. If the schools are serious about supporting students, then more logistical support in terms of transporting students to and from the class venue, as well as making provisions for additional help classes are needed.

The question of why some schools are not encouraging and supporting (at least) some of their students to aspire to university education and higher careers must be raised. The experiences and perspectives some of the students spoke of did not reflect an encouraging learning environment. Perhaps there were other more pressing issues affecting the school as a whole. Notwithstanding, it is crucial to engage with this question and clear that more

research is needed to investigate more deeply what the students were telling us about their experiences in school.

In terms of helping the students stay the course, the suggestion offered by Mia was notable – that a better preparation prior to Year 11 might give prospective students a better idea of the demands of the course and thereby better chance of enrolling, continuing and succeeding.

Would schools be alerted to the possible ways of addressing the shortcomings and areas of need, to provide a more supportive and nurturing environment for students who take up Advanced Mathematics? If not, how else can the students buck the trend?

References

- Ainley, J., Kos, J., & Nicholas, M. (2008). *Participation in Science, Mathematics and Technology in Australian Education, ACER Research Monograph No 63*. Victoria: Australian Council for Educational Research Ltd.
- Australian Academy of Science. (2006). *Mathematics and statistics: Critical skills for Australia's future*. Retrieved on 11 November 2009 at <http://www.review.ms.unimel.edu.au/FullReport2006.pdf>
- Barrington, F. (2006). *Participation in Year 12 Mathematics across Australia 1994-2004*. Melbourne, Australia: ICE-EM Publications in Mathematics No. 2, May 2006, ISBN 978-09775254-6-1.
- Barrington, F. & Brown, P. (2005) *Comparison of Year 12 Pre-tertiary mathematics subjects in Australia 2004-2005*. International Centre of Excellence in Mathematics and the Australian Mathematics Sciences Institute. Retrieved 3 November 2008 from http://www.amsi.org.au/images/stories/downloads/pdfs/education/comp_y12_pretertiary_austr_2004-05.pdf
- Chinnappan, M., Dinham, S., Herrington, A., & Scott, D. (2007). *Year 12 students and higher mathematics: Emerging issues*. Paper presented at the AARE, Fremantle.
- Forgasz, H. (2006). *Australian Year 12 Mathematics Enrolments: Patterns and trends – Past and Present*. Melbourne, Australia: ICE-EM Publications in Mathematics. Retrieved 3 November 2008 from: <http://www.ice-em.org.au/images/stories/FileDownloads/1.pdf>
- Harris, K-L., & Jenz, F. (2006). *The preparation of mathematics teachers in Australia*. Retrieved 3 November 2008 from http://www.cshe.unimelb.edu.au/pdfs/Prep_Math_Teach_Aust.pdf
- McPhan, G., Morony, W., Pegg, J., Cooksey, R., & Lynch, T. (2008). *Maths? Why not?* Department of Education, Employment and Workplace Relations, Canberra.
- Organisation for Economic Co-operation and Development (OECD) (2004). *Learning for tomorrow's world*. Paris: OECD.
- Rudduck, J., & McIntyre, D. (2007). *Improving learning through consulting pupils*. London: Routledge.
- Rubinstein, H. (2009). *A National Strategy for Mathematical Sciences in Australia*. Retrieved 5 November, 2009, from http://www.amsi.org.au/images/stories/downloads/pdfs/general-outreach/National_Maths_Strategy.pdf
- Tao, T. (2008). *Mathematics in today's world*. Retrieved 22 February 2010 from <http://www.the-funneled-web.com/Editorial-080409-Tao-guest.htm>
- Thomas, J., Muchatuta, M., & Wood, L. (2009). Mathematical sciences in Australia. *International Journal of Mathematical Education in Science and Technology*, 40(1), 17-26.

‘You might say you’re 9 years old but you’re actually
B years old because you’re always getting older’:
Facilitating Young Students’ Understanding of Variables

Jodie Hunter
University of Plymouth
<jodie.hunter@plymouth.ac.uk>

Student transition from arithmetical understandings to algebraic reasoning is recognised as an important but complex process. An essential element of the transition is the development of a rich understanding of variables. Drawing on findings from a classroom-based study, this paper outlines the instructional tasks and pedagogical actions a teacher used to facilitate her students understanding of variables. The findings affirm that younger students can begin developing understanding of variables and use forms of algebraic notation to represent their mathematical ideas. Carefully designed tasks, specific pedagogical actions and extended discourse were all important elements in facilitating student understanding.

Over the past decade, significant changes have been proposed for mathematics classrooms in order to meet the needs of a knowledge society. One aspect of this change has been an increased focus in both research and curricula reform on the teaching and learning of early algebraic reasoning. This emphasis in part is due to the growing acknowledgment of the insufficient algebraic understandings of many students and the way in which this denies them access to potential educational and employment prospects. To address the problem, one response has been to integrate teaching and learning of arithmetic and algebra as a unified curriculum strand in policy documents (e.g., Ministry of Education 2007, National Council of Teachers of Mathematics 2000). Within this strand, the combination of students’ informal knowledge and numerical reasoning can be used to transition early algebraic thinking. Essential to this transition is a requirement that students develop rich understanding of variables. However, developing such understanding in primary classrooms is challenging. Therefore, the research reported in this paper examines the instructional tasks and pedagogical actions a teacher used with a class of 9 to 11 years olds in order to facilitate them to represent their mathematical ideas using notation and gain a more sophisticated understanding of variables.

In the transition from arithmetical to algebraic reasoning, a deep understanding of variables is important. We know, however, that many young students have limited classroom experiences in exploring variables (MacGregor & Stacey, 1997; Weinburg et al., 2004). A large-scale exploratory study of Year 7-10 students by MacGregor and Stacey suggested that student difficulties could be attributed to both the lack of opportunities to explore variables and their classroom experiences. These researchers found that inappropriate teaching methods such as the use of letters to represent an object led to students viewing letters as abbreviated words. Also a number of the students in the study based their interpretation of symbolic letters on intuition, guessing or false analogies. Similarly, a study by Knuth and his colleagues (2005) with 6th to 8th graders highlighted a range of common misconceptions linked to notation. These included the notion that a single letter variable could only stand for a single number and variables represented by different letters could not be the same number.

We know that students’ algebraic understandings develop with experience (Flockton, Crooks, Smith, & Smith, 2006). Providing opportunities in the classroom for students to



both use notation and explore the concept of variables supports them to deepen their understanding. A study by Weinburg and his colleagues involving middle school students demonstrated that performance in interpreting algebraic notation and understanding of variables as representing multiple values increased over year levels. Other recent research with primary age students advocates that younger students are able to understand and work with algebraic notation. Results of an interview based study carried out with third grade students by Schlieman and her colleagues (2007) found that the students could develop consistent notations such as circles or shapes to “represent elements and relationships in problems involving known and unknown quantities” (p. 59).

Studies involving classroom interventions provide examples of how young children can use variables as a tool to understand and express arithmetical and functional relationships. A classroom intervention study by Carraher and his colleagues (2006) involving third grade students found that the students were able to use formulas to represent functions and treat the symbolic letter in the additive situation as having multiple possible solutions. Another study by Stephens (2005) with Year 7 and 8 students illustrated how a mathematical problem could be used to confront common misconceptions students held about variables. Teachers in the study noted that concentrating on symbolic representations allowed them to address misconceptions. Carpenter and his colleagues (2005) worked with students across the primary grades and found that students who had worked with number sentences were able to easily adapt these to represent generalisations. At the conclusion of the study, 80% of 4th and 6th Graders were able to use variables to express generalisations.

The theoretical framework of this study draws on the emergent perspective (Cobb, 1995). From this socio-constructivist learning perspective, Piagetian and Vygotskian notions of cognitive development connect the person, cultural, and social factors. Therefore, in this paper the learning of mathematics is considered as both an individual constructive process and also a social process involving the social negotiation of meaning.

Method

This research reports on episodes drawn from a larger study, which involved a 3-month classroom teaching experiment (Cobb, 2000). The larger study focused on building on numerical understandings to develop algebraic reasoning. It was conducted at a New Zealand urban primary school and involved 25 students aged 9-11 years. The students were from predominantly middle socio-economic home environments and represented a range of ethnic backgrounds. The teacher was an experienced teacher who was interested in strengthening her ability to develop early algebraic reasoning within her classroom.

At the beginning of the study, student data on their existing numerical understandings was used to develop a hypothetical learning trajectory. Instructional tasks were collaboratively designed and closely monitored on the trajectory. The trajectory was designed to develop and extend the students’ numerical knowledge as a foundation for them developing early algebraic understandings. This paper reports on the tasks on a section of the trajectory that focused on developing understanding of variables. The students were individually pre and post interviewed using a range of tasks drawn from the work of other researchers (e.g., Knuth et al., 2005, Weinberg et al., 2004). The rationale for selecting these questions was to replicate and build on the previous findings of these researchers. Other forms of data collected included classroom artefacts, detailed field notes, and video recorded observations.

The findings of the classroom case study were developed through on-going and retrospective collaborative teacher-researcher data analysis. In the first instance, data analysis was used to examine the students' responses to the mathematical activity, and shape and modify the instructional sequence within the learning trajectory. At completion of the classroom observations the video records were wholly transcribed and through iterative viewing using a grounded approach, patterns, and themes were identified. The developing algebraic reasoning of individuals and small groups of students was analysed in direct relationship to their responses to the classroom mathematical activity. These included the use of tasks, the climate of inquiry, and the pedagogical actions of the teacher.

Results and Discussion

I begin by providing evidence of the initial understandings of the students. I then explain the starting point for the section of the trajectory related to variables. The initial starting point for classroom activity is outlined and I explain how this was used to develop student understanding. A sample of the varied activities, which the students engaged in to explore variables, is provided. I conclude with evidence of the effect of the classroom activities using post student interview data.

Interview Data of the Student's Initial Concepts of Variables

This section presents pre-task interview results. One interview item¹⁵ investigated the use of notation to represent an unknown quantity. Students predominantly used a specific number to represent the unknown quantity (see Table 1). These results demonstrate students' unfamiliarity or reluctance to symbolically represent an unknown quantity.

Table 1
Percentage of Students (n = 25) Using Notation for an Unknown Quantity

	Correct notation e.g., $\blacksquare + 3$ $N + 3 + 2$	Non-standard or incorrect notation e.g., $B + 3 = A$, $A + A = C$	Number as notation e.g., $2 + 3 = 5$	No response
Q. A	24%	4%	60%	12%
Q. B	28%		60%	12%
Q. C	16%	12%	60%	12%

Students working at a higher level [$n = 19$] were asked a further question¹⁶ to elicit their understanding of what a letter meant in a mathematical context. In response to Question A, 6 students responded that the symbol could stand for four and correctly justified this response. However, seven students' constructed their interpretation of symbolic letters by guessing or false analogies. Most frequently, the letter was viewed as an abbreviated word:

Sangeeta: There is sort of a clue in that letter because the reason I said four is because four starts with an f.

¹⁵ What is a mathematical statement or sentence to represent each of the following situations:

- A) I have some pencils and then get three more.
- B) I have some pencils, then I get three more and then I get two more.
- C) I have some pencils then I get three more and then I double the number of pencils I have.

¹⁶ $2f + 3$

A) Could the symbol stand for 4?

B) Could the symbol stand for 37?

In response to Question B, three students stated that the symbol could stand for thirty-seven and justified this response. Ten students stated that the symbol could not stand for thirty-seven. Two students reported that a single letter could only stand for a single digit number.

Rachel: It would have to be ff. It has to be one number.

A further item¹⁷ was used to probe their understanding. Only four students stated that the sentence was sometimes true and justified their response. Five students stated the number sentence could never be true and indicated that they considered different letters in an equation could not represent the same number.

Josie: M and P couldn't stand for the same thing.

The Stepping off Point on the Trajectory

An initial activity¹⁸ involving the use of an algebrafied arithmetic problem was used as a context to engage students in dialogue about variables. The task structure of the word problem provided a context for students to give conceptual explanations of their notation while specific pedagogical actions were important tools to scaffold use of notation. In the first instance, the teacher supported the students to record in a systematic way to emphasise the patterns in the equations. For example, during a whole group discussion, she revoiced a student's explanation scaffolding her to record in a logical manner and placing an emphasis on the patterns in the equations:

Teacher: Nine plus something equals seventeen ... what if the T-shirt was twenty dollars? What would the equation look like if it was twenty dollars?

Specific questioning was used to focus student attention on identification of the constant and unknown in the equations. The teacher first directed the students to identify the similarities and then the differences. In response the students referred to the context of the problem providing a conceptual explanation:

Teacher: Talk to the person next to you about what has stayed the same in all of those equations?

Zhou: The nine because that's how much you have in the bank.

Teacher: What changes in each of those equations?

Gareth: The amount that you have to save.

Sabrina: The cost of the t-shirt.

In the final part of this activity students were asked to use algebraic notation to represent a generalised situation. Students used informal algebraic notation to represent the situation. During the following large group discussion two alternative representations were shared.

Rachel: [writes $\square + 9 = a$] We drew a box plus nine equals a .

Heath: [writes $z - 9 = x$] We did z take away 9 equals x .

¹⁷ Is $h + m + n = h + p + n$ always, sometimes or never true?

¹⁸ If you had \$9 in your bank and wanted to buy a T-shirt for \$17, how much do you need to save? What about if the T-shirt cost \$20 or \$26 or \$40? Have a go at solving the problem ... what changes and what stays the same? Can you find a way to write a number sentence algebraically that someone could use to work out how much they need to save no matter what the cost of the T-shirt?

In subsequent lessons, when solving a further algebraified arithmetic problem¹⁹, the students modelled their recording (see Figure 1) on the student explanation scaffolded by the teacher. This enabled them to quickly identify the unknowns and construct algebraic notation to represent the situation. For example, Heath constructed a solution strategy:

Heath: [writes equation] Triangle divided by five equals spiral.

$35 \div 5 = 7$
 $45 \div 5 = 9$
 $\Delta \div 5 = \odot$
 $60 \div 5 = 12$
 $80 \div 5 = 16$

Figure 1. Solution strategy for the CD player problem.

Developing Further Understanding of Variables through Formalising Functional Rules

Further opportunities were provided for students to construct notations and extend their understanding of variables through the provision of functional relationship problems. For these tasks, students used variables to represent the rules and generalisations their groups had constructed for the functional relationships. For example, a group developed the following rule and explanation:

Rachel: [writes $A \times 3 + 2 = Q$] We did A times three plus two because you always times three and then you add two. We did A for the number of tables.

The teacher used this as an opportunity to further extend student use of formal notation introducing an algebraic convention:

Teacher: [writes $3A + 2 = Q$] I can write it like this three A plus two equals Q because that's like putting brackets around here and plussing two because three A is the same as saying three times A .

The formalisation of generalisations into algebraic rules provided opportunities for students to develop their understanding of notation. For example, during small group work a student recorded a generalisation as $\blacktriangle \times 5 = \blacktriangle$. Another group member disagreed:

Gareth: [pointing to both triangles] But these aren't the same numbers you need to change it from the triangle.

In another lesson, the activity²⁰ provided students the opportunity to extend their understanding of algebraic notation as a quantitative referent. During small group work, the students in one group discussed how their notation linked to the contextual basis of the functional relationship. Building on their notation $S \times 10 + 5$ to represent the functional relationship, their discussion moved their understanding towards a generalised rule:

¹⁹ You would like to buy a CD player that costs \$35. You earn \$5 an hour at your job. How many hours do you need to work? What about if the CD player costs \$45 or \$60 or \$80? Have a go at solving the problem ... what changes and what stays the same? Can you find a way to write a number sentence algebraically that someone could use to work out how many hours they need to work no matter what the cost of the CD player?

²⁰ Vodafone is currently offering a calling plan that charges 5 cents per call and 10 cents per minute..

- 1) How much would a 3 minute phone call cost? 6 minutes? 15 minutes?
- 2) Write a number sentence to show how much a phone call will cost no matter how long you talk for.

Tim: So S is meaning three.
 Ruby: No it is not meaning only three. It is meaning the number of minutes you have had on the phone.
 Tim: So at the moment it is meaning three minutes?
 Ruby: No it is just meaning any number of minutes.

During the whole group discussion which followed the small group work, students also extended their understanding of formal notation. One student notated the generalisation as $P \times 10 + 5 = N$. Another student suggested using the teacher introduced shortened notation:

Rani: Instead of going P times ten couldn't you just go $10P$?

Several other students initially disagreed with this:

Bridget: No because it is a number and a letter.
 Susan: You need to know if you are timesing it or plussing it.

Sensing an opportunity, the teacher again facilitated a discussion of using this notation:

Ella: What does it mean if you see a letter with a number in front of it? What does it mean in mathematics?
 Steve: It's like ten times P because it is an algebraic short-cut.

Confronting Misconceptions About Variables

An important element of extending student understanding of variables was awareness of possible misconceptions. Midway through the study, an examination of an algebraic number sentence revealed that many students maintained the misconception that two different letters in an equation could not represent the same number. For example, during a whole class discussion a student argued that $J + T = T + L$ could never be true because:

Josie: L and J can't equal the same number ... two letters can't represent the same number in the same equation.
 Teacher: So you are saying that J and L can't represent the same number?
 Josie: Yeah but T and T have to.

Other students agreed with Josie's argument.

Sabrina: I think they can if they are in different equations.
 Josie: They can if they are in completely different equations ... these are two equations which are joined so that means that they can't represent the same number.

Collaborative discussion between the teacher and researcher led to revision of the trajectory and the insertion of specifically designed algebraic number sentences²¹ to confront this misconception. The first number sentence reinforced student understanding that the same letter had to represent the same number. Then the second number sentence positioned the students to engage in argumentation in order to confront the misconception. After lengthy discussion the teacher recorded fifteen and fifteen as a possible solution and challenged the students with a question:

Teacher: Can J equal fifteen and B equal fifteen?
 Zhou: Even if they are not the same letters they can still equal the same value... if it is a different letter it still could.

Reflective statements recorded by students after this lesson identified a change in thinking:

²¹ $H + H = 30$ $J + B = 30$

 What could H be? What could J be? What could B be?

Ruby: If it was the same letter it had to be the same number...I thought the different letters couldn't represent the same thing. Now I learned they can represent the same number.

Interview Data of Student Understanding of Variables Post-study

The final interview responses indicated that there had been a considerable shift in student use of notation to represent varying quantities. Table 2 illustrates the percentage of students correctly using notation in response to the questions²².

Table 2

Percentage of Students (n=25) Using Notation for an Unknown Quantity

	Correct notation e.g., $\blacksquare + 3$ $N + 3 + 2$	Non-standard or incorrect notation e.g., $B + 3 = A$, $A + A = C$	Number as notation e.g., $2 + 3 = 5$	No response
Q. A	92%	0%	4%	4%
Q. B	92%		4%	4%
Q. C	44%	44%	8%	4%

Additional questions²³ were used with students working at a higher level ($n = 19$) which examined their understanding of what letters represented in a mathematical context. Significant improvement was demonstrated in their responses. In response to Question A, all of these students stated that the symbol in the equation could stand for six and justified this response. In response to Question B, 17 students stated that the symbol could stand for forty-five and justified this response. However, 1 student maintained the misconception that the variable could only represent a single digit.

A following question²⁴ was also used with these students to investigate their understanding of the concept that a different letter could represent the same number. Fifteen students identified that the number sentence was sometimes true and provided justification for their assertion.

Josie: Sometimes...because e and f could be the same numbers but then they could also be different numbers...b and b have to be the same number and n and n have to be the same number.

However, three of these students maintained that the same number could not be represented by two different letters in an equation.

Matthew: I don't think it's ever true because the first and the last letter are the same but the e and the f aren't the same and one number can't represent two letters.

In the final interview the improved student responses confirmed that the contextual tasks which provided opportunities to explore algebraic notation alongside specific pedagogical actions and extensive discussion had scaffolded student understanding of variables.

²² What is a mathematical statement or sentence to represent each of the following situations:

- A) I have some lollies and then get five more.
- B) I have some lollies, then I get five more and then I get three more.
- C) I have some lollies then I get five more and then I double the number of lollies I have.

²³ $2m + 5$ A) Could the symbol stand for 6? B) Could the symbol stand for 45?

²⁴ Is $b + f + n = b + e + n$ always, sometimes or never true?

Conclusions and implications

This study sought to explore how younger students could be facilitated to represent their mathematical ideas using notation and gain a more sophisticated understanding of variables. Similar to the findings of MacGregor and Stacey (1997) many of the students initially based their interpretation of variables on intuition, guessing and false analogies. They also demonstrated misconceptions described by Knuth and his colleagues (2005).

Initial tasks involving algebraified arithmetic problems provided students with a context to engage in discussion about variables. Both the task structure and specific pedagogical actions by the teacher including questioning and scaffolding to record appropriately supported students to begin using notation to represent a mathematical situation. Further opportunities for exploration of variables were provided through formalising functional rules. The teacher was able to utilise opportunities during these activities to shift students towards more formal notation. Results of this study also support Stephen's (2005) contention that carefully constructed mathematical tasks can be used to confront misconceptions about notation. Many of the students in this study deepened their understanding of variables. However, the small proportion of students who continued to demonstrate misconceptions about algebraic notation in the final interview reinforces the need for students to have multiple opportunities to explore symbolic variables.

Findings of this study affirm that younger students can begin developing their understanding about variables and be encouraged to use forms of notation. Carefully designed tasks, teacher intervention and extended discussion supported students to develop their understanding of notation. Due to the small size of this sample further research is required to validate the findings of this study.

References

- Carpenter, T., Levi, L., Berman P., & Pligge, M. (2005) Developing algebraic reasoning in the elementary school. In T. Romberg, T. Carpenter, & F. Dremock (Eds.), *Understanding mathematics and science matters* (pp. 81-98). Mahwah, NJ: Lawrence Erlbaum.
- Carraher, D., Schliemann, A., Brizuela, B., & Earnest, D. (2006). Arithmetic and algebra in early mathematics education. *Journal for Research in Mathematics Education*, 37(2), 87-115.
- Cobb, P. (1995). Cultural tools and mathematical learning: A case study. *Journal for Research in Mathematics Education*, 26(4), 362-385.
- Cobb, P. (2000). Conducting teaching experiments in collaboration with teachers. In A. Kelly, & R. Lesh (Eds.), *Handbook of research design in mathematics and science education* (pp. 307-333). Mahwah, NJ: Lawrence Erlbaum.
- Flockton, L., Crooks, T., Smith, J., & Smith, L. (2006). *Mathematics assessment results 2005*. National Education Monitoring Report 37. Dunedin: Education Assessment Research Unit.
- Knuth, E., Alibabi, M., McNeil, N., Weinberg, A., & Stephens, A. (2005). Middle school students' understanding of core algebraic concepts: Equality & variable. *Zentralblatt für Didaktik der Mathematik [International Reviews on Mathematical Education]*, 37, 68-76.
- MacGregor, M., & Stacey, K. (1997). Students' understanding of algebraic notation. *Educational Studies in Mathematics*, 33, 1-19.
- Ministry of Education. (2007). *The New Zealand Curriculum*. Wellington: Learning Media.
- National Council of Teachers of Mathematics, (2000). *Principles and standards for school mathematics*. Reston, VA: Author.
- Schliemann, A., Carraher, D., & Brizuela, B. (2007). *Bringing out the algebraic character of arithmetic*. Mahwah NJ: Lawrence Erlbaum.
- Stephens, A. (2005). Developing students' understandings of variable. *Mathematics Teaching in the Middle School*, 11(2), 96-100.
- Weinburg, D., Stephens, A., McNeil, N., Krill, D., Knuth, E., & Alibabi, M. (2004). *Students' initial and developing conceptions of variable*, Paper presented at the annual meeting of the American Research Association, San Diego, USA.

Coming to ‘Know’ Mathematics through ‘Acting, Talking and Doing’ Mathematics

Roberta Hunter

Massey University

r.hunter@massey.ac.nz

This paper adds to a discussion initiated by Askew (2007) about two contrasting views of scaffolding; as a ‘tool for results’ and a ‘tool-and-result’. The study took place in four primary classrooms within a low socioeconomic setting. Two classroom episodes drawn from one of the teacher’s classroom, illustrate the two different perspectives of scaffolding. These are presented and the learning that evolved from each episode is discussed. The paper illustrates that when scaffolding was used as a ‘tool for results’ the learning was restricted but when the students were scaffolded within a tool-and-result perspective the mathematical knowledge and ways of doing and talking mathematics were generative.

In a recent PME paper Askew (Askew, 2007) drew our attention to a need to re-consider the viability of Vygotskian notions of scaffolding within current mathematics classrooms. In this paper, Askew challenged the usefulness of mathematics educators adopting the metaphorical view of scaffolding as a ‘tool for results’. Askew linked this view of scaffolding as a ‘tool for results’ to the recent reform measures introduced in Britain. Within these reform measures, policy makers specify detailed learning outcomes and activity for those involved in teaching mathematics. In recent years New Zealand has followed a similar route with the introduction of a ‘Numeracy Development Project’ (Ministry of Education, 2004a). Similar to the British model, a recently introduced New Zealand Numeracy project has predetermined learning outcomes and a detailed script for teachers to use. Implicitly suggested within this New Zealand model, is the idea of scaffolding as a mediating tool that will give results—student acquisition of mathematical knowledge and strategies through teacher led instruction. In contrast, Askew building on Vygotskian theories interpreted in the work of Newman and Holzman (1997), proposed that mathematics educators should adopt an alternative stance to scaffolding; one in which scaffolding is considered as a ‘tool-and-result’. Within this contrasting perspective scaffolding as the mediating tool, is as much a part of the learning as is what is learnt. This paper explores the concept of scaffolding, as it is used to support student learning in two classroom episodes, and the student learning which emerges as a result. The aim of the paper is to illustrate in two contrasting episodes what happens to students ‘talking and doing mathematics’ like mathematicians when scaffolding as the mediating tool fits within a metaphorical view of it as either a ‘tool for results’, or as a ‘tool-and-result’.

According to Vygotskian thinking, conceptual reasoning developed in mathematics classrooms is a result of interaction between everyday spontaneous concepts and scientific concepts. Scientific concepts involve higher order thinking, which are used as students engage in more proficient forms of ‘doing and talking’ mathematics. Vygotsky (1986) maintained that, “the process of acquiring scientific concepts reaches far beyond the immediate experience of the child” (p. 161). Although his work was not within the schooling system he suggested that school was the cultural medium, with dialogue the tool that mediated transformation of everyday spontaneous concepts to scientific concepts. Vygotsky’s suggestion was not, however, that scientific concepts are separate from spontaneous concepts, nor the act or practice of their development separate from their result. Rather, Vygotsky argued that they were an integral part of both the process and the



outcomes. Askew (2007) illustrated what Vygotsky described in his professional development work with teachers and students. Askew persuasively illustrated that the performance and the creation of mathematical objectives is as much a priority for learning, as is the knowledge learnt. Through the construction of a learning environment in which students were both encouraged and required to talk mathematically, Askew illustrated how the immediate importance of the lesson learning outcome gave way to the bigger priority—that the students learnt to talk and act as mathematicians. Furthermore, through the specific scaffolding they received they learnt that they had the choice to continue to think, talk, and act, like mathematicians when doing mathematical activity.

Scaffolded Mathematical Discourse within Zones of Proximal Development

Whilst the exact nature of how external articulation becomes thought has been extensively debated (Sawyer, 2006), sociocultural theorists are united in their belief that collaboration and conversation are crucial to the transformation of external communication to internal thought. They suggest that this occurs as students and teachers interact in co-constructed zones of proximal development. The zone of proximal development has been widely interpreted as a region of achievement between what can be realised by individuals acting alone and what can be realised in partnership with others (Goos, Galbraith, & Renshaw, 1999). Traditional applications of zones of proximal development were used primarily to consider and explain how novices are scaffolded by experts in mathematical activity. Taking the view Askew (2007) proposed—the tool-and-results perspective—widens the frame and supports ways to consider the scaffolded learning, which occurs when levels of competence are more evenly distributed across the members of the zone of proximal development. Mathematical learning in this form occurs during mutual engagement in collective reasoning discourse and activity (Mercer, 2000). Lerman (2001) describes collective participation in mathematical discourse and reasoning practices as pulling all participants forward into their zones of proximal development which he terms a symbolic space—“an ever-emergent phenomenon triggered, where it happens, by the participants catching each other’s activity” (p. 103).

Defining the zone of proximal development as a symbolic space provides a useful means to explain how participants in classrooms mutually appropriate each others’ actions and goals. In doing so, they are required to mutually engage and inquire into the perspectives taken by other participants. In such learning environments teachers, too, are pulled into the zone of proximal development and are required to understand from the perspective of their students, their reasoning and attitudes (Goos, 2004). Mercer (2000) termed this process of inquiry into each other’s reasoning “interthinking” (p. 141). During interthinking Mercer outlined how the variable contributions of participants create a need for continual renegotiation, and reconstitution of the zone of proximal development. In the extended discourse the contributions are critiqued, refined, extended, challenged, synthesised and integrated within a collective view. At the same time, all members’ mathematical reasoning is scaffolded beyond a level they could achieve alone.

The construct of interthinking—pulling participants into a shared communicative space—extends the view of scaffolding and the zone of proximal development. It supports consideration of the learning potential for pairs or groups of students working together with others of similar levels of expertise in egalitarian relationships (Goos, 2004; Goos et al., 1999). The partial knowledge and skills that group members contribute, support and deepen collective understanding. Opportunities are also provided for the group to encounter mathematical situations, which involve erroneous thinking, doubt, confusion and

uncertainty. Importantly, constructing a collective view is not always premised immediately on consensus. Dissension can also be a catalyst for progress either during, or after, a collaborative session (Mercer, 2000) and to reach consensus, negotiation requires participants to engage in exploration and speculation of mathematical reasoning—an activity, which approximates the actual practices of mathematicians. Such scaffolded activity inducts students into more disciplined reasoning practices. The “lived culture of the classroom becomes in itself, a challenge for students to move beyond their established competencies” (Goos et al., 1999, p. 97) to become more autonomous participants in mathematical activity and talk.

Research Design

This paper reports on episodes drawn from a larger classroom-based design research study (Hunter, 2007a). The study was conducted at a New Zealand urban primary school and involved four teachers and 120 Year 4-8 students (8-11 year olds). The students were from low socio-economic backgrounds and were pre-dominantly of Pasifika or New Zealand Maori ethnic origin. The teachers had completed a professional development programme in the New Zealand Numeracy Development Project (Ministry of Education, 2004a). They reported at the start of the study that their students had poor mathematical achievement levels. They also considered that asking their Maori and Pasifika students to explain their reasoning, or challenge the reasoning of others, had considerable difficulties both socially and culturally for this grouping of students. At the conclusion of the study the students were achieving at a level, which placed them at a sound level of achievement.

A year-long partnership between the researcher and teachers using a design research approach supported the design and use of a ‘Participation and Communication Framework’ and a ‘Framework of Questions and Prompts’. The ‘Participation and Communication Framework’ was designed as an organising tool to assist the teachers to scaffold students’ use of proficient mathematical practices within reasoned inquiry and argumentation. The ‘Framework of Questions and Prompts’ was a tool co-constructed during the study to deepen student questioning and inquiry. More detail (Hunter, 2006, 2007a, 2007b, 2008) of the Frameworks and how these scaffolded teacher change and student change can be found in previous PME and MERGA papers. Student development of mathematical practices is not the focus of this paper. The focus is on how they were inducted into the discourse of inquiry and argumentation, and the ways in which this influenced how they interacted in zones of proximal development. For this paper, two episodes were selected to illustrate how scaffolding was used within the classroom context by one of the teachers and how it influenced the students’ engagement in ‘talking and doing’ mathematics.

Results and Discussion

In the initial stages of the study the four teachers in the research closely adhered to the structured lessons provided in the New Zealand Numeracy Development Project material (Ministry of Education, 2004a). At this early stage in the study the scripted lessons were often followed word for word from the curriculum material provided by the developers. This section illustrates what happens when the scripted lessons scaffold what the teacher does and how they are used as a ‘tool for results’.

Scaffolding as a 'Tool for Results'.

The teacher began the lesson by stating a learning intention that signalled what he expected the outcome of the lesson on fractions should be. He began by reading:

Teacher: So what we are doing today is that we are learning to find fractions of a set.

He continued reading the script (See Ministry of Education, 2004b, p. 7).

Teacher: Here is a farm [draws a cut in two fields on a piece of paper]. The farmer uses an electric fence to make her farm into two paddocks. She has ten animals. Hinemoa you count out ten of those animals [Hinemoa counts out one by one ten plastic animals]. She wants to put one-half of the animals in one paddock and one-half in the other. How many animals do you think will be in each paddock?

Jo: I already know five because five and five are ten.

Without acknowledging Jo's interjection he directed the students:

Teacher: We all need to take ten animals and share them into the two paddocks in our groups. You need to turn to your partners because you are working together in your groups of three and talk about what you are doing.

In their groups, the students took the ten animals, which they counted out one by one into two groups. The only discussion was about counting out the animals one by one, then counting the two sets and agreeing that there are five animals in each set. They each took a turn to do this. The teacher watched and when he observed that all the groups had completed the task he returned to the script:

Teacher: Could we have worked out the number of animals in each paddock without sharing them out?

Jenny: Yes we could say five plus five is ten.

Teacher: [The teacher picks up two groups of five and shows the students] Yes you can use your doubles and say five and five.

He continued the lesson posing similar problems and directing the students to use materials and share out the animals in order to find the answer to the problem. Each time the students completed the task he asked one student to explain what was done:

Hone: We had fourteen bears so one, two, three, four, five, six, seven, eight, nine, ten, eleven, twelve, thirteen, fourteen so seven and seven are fourteen.

The lesson was orderly and the students responded almost as if they were performing, playing a game of turn-taking, sharing out the animals and saying the matching script related to double addition modelled by their teacher. The teacher had followed the script closely. At the conclusion of this lesson he stated that the students now knew how to find a fraction of a set and were ready to move to the next lesson outlined in the curriculum material.

Considering this lesson it appears that both sets of individuals have been scaffolded to play specific roles. The teacher used the script to play out a role in which he can address a specific and narrow learning outcome, which he has detailed at the start of the lesson. The role he took was to show and tell. The students in turn adopted the role he cast them in and played out their role to acquire the specific piece of mathematical knowledge. They were 'talking and doing' mathematics but the question is, "What knowledge of themselves as mathematicians were they developing?" Moreover, "What were they learning about talking and doing mathematics?"

The following section contrasts the preceding lesson episode, which occurred in the first week of the study with a mathematics lesson which took place towards the end of the study.

Scaffolding as a 'Tool and Results'.

As outlined in the Research Design section, extensive scaffolding was provided by the teacher to support students to use a range of proficient mathematical practices including reasoned mathematical explanations, justification and generalisations. Scaffolding was also used to support students to develop a repertoire of questions and prompts to use to inquire into the sense-making of others. In addition, the teachers also paid specific attention to establishing group norms to ensure interthinking occurred. In relationship to the New Zealand Numeracy Development Project, the teacher continued to draw on the curriculum material to provide guidance for his lessons. But then now he no longer followed the script and he wrote problems, which better matched the interests of his students.

In this lesson the teacher wanted the students to explore the strategy of partitioning but he had selected numbers, which support emergence of multiple ways of reasoning towards a solution strategy. The lesson consisted of two components; small group problem solving and then a large group discussion. This episode describes the first section of the lesson in which the students had been placed in groups of three and without teacher-led discussion they were given a problem²⁵ and asked to discuss and develop a number of solution strategies.

- Saawan: What about five times 700 and then...
- Hine: Five times fifty, and then five times six.
- Sonny: Hey mine's the same but mine's starting from the six, fifty, and then seven hundred. Hey all our ways are the same, well kind of, because you can start both ways.
- Saawan: Well let's see if that right...so you say we can start both ways, yeah that's cool it works.

The students began immediately to work together, interthinking, and they constructed a solution strategy using the distributive property. They continued to discuss and explore whether the order of how the factors were distributed affected the solution as they recorded them in the different ways. As Sonny studied the recordings he introduced the group to an alternative idea. This strategy was one that drew on distributing the factor of five rather than the factor of 756:

- Sonny: I have just thought and I know another way. Can you do seven hundred and fifty six times two and then plus it so the times two becomes...becomes times four...equals...
- Saawan: What? Let's write it down.

Sonny was playing with the idea of the generalisation the group had collectively constructed. He introduced it as he thought out loud and Saawan's answer indicated that although he had not yet made sense of what Sonny was saying he was open to the new contribution. Sonny showed that his thinking was still being formed when Hine recorded it vertically as $756 + 756$ and he told her:

- Sonny: No times two is easier.

²⁵ Bart Simpson had five different coloured marbles. He had 756 of each colour and Lisa wants to know how many he has altogether. Can you help him tell Lisa how many he has? Lisa might challenge him to prove he has more than her so can you work out some different strategies he could use?

Saawan followed Sonny's reasoning closely and his argument indicated that he was making a link to their previous reasoning. He then extended his reasoning and that of his peers when he argued that multiplication was repeated addition:

Saawan: Times two yeah but doing it that way is the same way really, you can say it as a plus because that's the same as times like before when we went the other two ways not just one way.

Hine, listening to the exchange crossed out the recording, replacing it with 756×2 . Then Sonny continued with the new thinking as Hine and Saawan tracked closely and examined the reasoning section by section:

Sonny: Seven hundred and fifty six times two equals one thousand six hundred and twelve...

Hine: Wait, one thousand... [Lapses into silence as she records 700×2 then writes 50×2 and 6×5].

All three students examined the recordings and checked the total. Then Saawan took the pen, from Hine and he recorded 1512×2 as he continued to explain:

Sawaan: And then we times, no we add them together then times it by two and add seven hundred and fifty six on to it [Records 3780].

Hine: But hang on how did we get that?

Sonny: [Directs her attention to the recording as he explains] By timsing this by two, and this by two, and then adding.

Hine: [Nods her head] Yeah I get it now.

The teacher had been sitting silently listening and observing the interaction. Then he observed Hine's continuing uncertainty and so he prompted her to question, emphasising that she needed to do so until she had complete understanding

Teacher: You look like you are still a bit puzzled. Look at what he has explained and if you need to, ask more questions. Make sure you are convinced that it works. Think about a good question and ask it.

Hine: Why did you times one thousand five hundred and twelve by two?

Saawan: Because it's like...because then when we times that by two [he points at the second two] it is like that will be like four and then we only have to add seven hundred and fifty six. It's just doubling.

The teacher's prompt for further questioning left the mathematical agency with the students. After closely listening to the student provided explanation he then pressed them to further explore the reasoning:

Teacher: By adding this [He points at $+ 756$] what's another way of saying that because I think maybe that...how could you say it differently instead of saying adding seven hundred and fifty six?

Now Sonny and Hine indicated that the reasoning Saawan introduced had become integrated within their collective understandings:

Sonny: You could multiply it by one...

Hine: Okay, I get it now so multiply by one yeah so when we times two, times two, times one because the whole thing is seven hundred and fifty six times five, so times five yeah, [she laughs then refers to the context of the problem] huh that's a good one Lisa better understand from Bart.

In this second lesson scaffolding took a different form from that reported in the first lesson. Scaffolding had become a tool, which mediated the mutual engagement of all participants in the collective reasoning. The use of *problem solving* groups where mathematical expertise was more evenly distributed across the members changed their interactions. This resulted in each individual's role emerging and changing minute by minute in the discussion, as they were pulled into a shared communicative space. The different contributions scaffolded the group members being extended beyond their own capabilities. Importantly, the mathematical understanding they were developing was of equal importance to what they were learning about acting as mathematicians and 'talking and doing' mathematics.

Conclusions and Implications

The paper sought to explore and examine scaffolding used in two different ways in classroom episodes, and the learning, which emerged as a result. The paper illustrated that when scaffolding is used as a tightly controlled tool within what Askew (2007) describes as a "technical-rationalist view of teaching and learning" (p. 239) the roles the teacher and the students hold and the mathematical talk they use and the knowledge they develop is limited. Likewise, the students' learning to 'talk and do' mathematics in ways mathematicians do, are restricted. However, when scaffolding is used within a widened dimension that affirms both the importance of the construction of mathematical knowledge and the manner in which it is constructed, the learning potential for all participants is enhanced.

This paper confirms the results in Askew's (2007) PME paper but extends these results to show the learning potential available when teachers scaffold students to work together to construct a collective mathematical view within zones of proximal development. As other researchers (Goos, 2004; Goos et al., 1999; Lerman, 2001; Mercer, 2000) have illustrated, the act of interthinking and developing a collective view was a key factor which scaffolded how these students learnt to talk and do mathematics. Of importance too, was careful teacher preparation, which drew on the New Zealand Numeracy Project as a tool for classroom activities rather than a rigidly followed formula. The use of grouping and the careful selection of numbers allowed the lesson to unfold and the students to improvise and play with the numbers, in a form of mathematics, which was generative.

Implications of this study suggest the need for mathematics educators to consider not only the importance of the development of mathematical knowledge but also how it is constructed. In this form scaffolding needs to be metaphorically viewed as a 'tool-and-result'. National projects such as the New Zealand Numeracy Project (Ministry of Education, 2004) have an important place as a professional development tool but teachers need to develop their own script rather than use the materials rigidly.

References

- Askew, M. (2007). Scaffolding revisited: From tool for result to tool-and-result. In J. Woo, H. Lew, K. Park, & D. Seo (Eds.), *Proceedings of the 31st Conference of the International Group for the Psychology of Mathematics Education* (Vol. 2, pp. 33-40). Seoul, Korea: The Korea Society of Educational Studies in Mathematics.
- Goos, M. (2004). Learning mathematics in a classroom community of inquiry. *Journal for Research in Mathematics Education*, 35(4), 258-291.
- Goos, M., Galbraith, P., & Renshaw, P. (1999). Establishing a community of practice in a secondary mathematics classroom. In L. Burton (Ed.), *Learning mathematics: From hierarchies to networks* (pp. 36-61). London: Falmer Press.

- Hunter, R. (2006). Structuring the talk towards mathematical inquiry. In P. Grootenboer, R. Zevenbergen, & M. Chinnappan (Eds.), *Identities cultures and learning spaces* (Proceedings of the 29th annual conference of the Mathematics Education Research Group of Australasia, Vol. 2, pp. 309-318). Adelaide: MERGA.
- Hunter, R. (2007a). *Teachers developing communities of mathematical inquiry*. Unpublished doctoral dissertation. Massey University: Palmerston North.
- Hunter, R. (2007b). Can you convince me: Learning to use mathematical argumentation. In J. Woo, H. Lew, K. Park, & D. Seo (Eds.), *Proceedings of the 31st annual conference of the International group for the Psychology of Mathematics Education*, (Vol. 3, pp. 381-389). Seoul, Korea, The Korea Society of Educational Studies in Mathematics.
- Hunter, R. (2008). Do they know what to ask and why? Teachers shifting student questioning from explaining to justifying and generalising reasoning. In O. Figueras, J. Cortina, S. Alatorre, T. Rojano, & A. Sepulveda (Eds.), *Proceedings of the 32nd annual conference of the International group for the Psychology of Mathematics Education*, (Vol. 3, pp. 201-208). Morelia, Mexico: Cinvestav-UMSNH.
- Lerman, S. (2001). Cultural discursive psychology: A sociocultural approach to studying the teaching and learning of mathematics. *Educational Studies in Mathematics*, 46, 87-113.
- Mercer, N. (2000). *Words and minds*. London: Routledge.
- Ministry of Education of New Zealand. (2004a). *Book 3: Getting started*. Wellington: Learning Media.
- Ministry of Education of New Zealand. (2004b). *Book 7: Teaching fractions, decimals, and percentages*. Wellington: Learning Media.
- Newman, F. & Holzman, L. (1997). *The end of knowing: A new development way of learning*. London: Routledge.
- Sawyer, K. R. (2006). Analyzing collaborative discourse. In K. Sawyer (Ed.), *The Cambridge handbook of the learning sciences* (pp. 187-204). Cambridge: Cambridge University Press.
- Vygotsky, L. (1986). *Thought and language*. Cambridge, MA: The MIT Press.

The Mathematical Needs of Urban Indigenous Primary Children: A Western Australian Snapshot

Chris Hurst

Curtin University

< C.Hurst@curtin.edu.au >

Len Sparrow

Curtin University

< L.Sparrow@curtin.edu.au >

This study considered ways of improving mathematical outcomes for urban Indigenous students. It focused on three primary schools in Western Australia and identified factors that were perceived to be having an impact on student learning. These included expectations for students, attendance rates, parent involvement, student literacy levels, student engagement, and test literacy. Base-line data were gathered to identify mathematical needs — conceptual understanding, place value, calculating beyond finger counting, and an action plan for 2010-2012 was developed to address those needs and to counter factors that may have had an adverse impact on student learning.

This paper documents the progress of a study aimed at investigating the mathematical content knowledge, and engagement with mathematical learning of urban indigenous primary school children in Western Australia. The study is associated with the four-year *Make It Count* project conducted under the auspices of the Australian Association of Mathematics Teachers (AAMT). That project aims to identify practices that will enhance the mathematical learning of such children and, in doing so, “. . . will focus on the school as the unit of change, with all components of the school community — students, teachers and paraprofessional staff, school leaders, parents and parent groups, and the wider community engaged and having roles to play” (AAMT, 2009, p. 1). This paper outlines the study in its establishment phase.

Background

Perso (2003, p. 16) likened the cause of many difficulties faced by Indigenous children in schools as being akin to a clash of cultures, stating that “Aboriginal children bring to these schools a cultural orientation that is not well understood and is often perceived as being deficient”. This is exacerbated by the fact that teachers, most of whom do not come from an Indigenous background, do not fully appreciate the fact that Indigenous children are subject to two quite different sets of family and community expectations. This situation is well encapsulated here:

Before they can begin to master their school ‘subjects’, many students must learn the language, relationships, rules, procedures, and behaviours of school and school learning whilst maintaining their Indigenous identity. The difference between these two environments can be quite stark for many students and this additional ‘learning load’ is one factor that requires understanding and support. (Perso, 2009, p. 1)

Perso (2009) underlined the need for teachers to develop ‘cultural competence’ in order to “. . . demonstrate behaviours and attitudes that engage, build and maintain relationships with Aboriginal and Torres Strait Islander peoples” (p. 1). Consequently, Perso (2009) developed a *Pedagogical Framework for Cultural Competence* that poses for teachers sets of questions



related to various aspects of learning such as expectations and consequences, contextual learning, learning styles and use of language.

This is in keeping with an assertion made by Sullivan (2009) that students' prior knowledge and background must be acknowledged and built upon and that teachers need to look at children not only from a 'mathematical viewpoint' but also consider their complete socio-cultural background. Khan (2009) also supported the notion of 'cultural competence' noting that it needs to develop from a systemic level of awareness to respond to the needs of Indigenous children, and that ultimately, it depends on the effectiveness of the individual teacher. This point, that the "teacher student relationship is monumentally important", was also made by Quinn (2009), and that success is more likely when the curriculum is relevant and appropriate.

Frigo (1999) arrived at similar conclusions in identifying a number of key themes that seemed to exist, mainly relating to the need for culturally appropriate content and strategies to reflect the learning needs of Indigenous children. She particularly noted the complex nature of issues related to language and mathematical learning. In addition, Frigo also noted "It is crucial that teachers are encouraged to have high expectations for all of their students and therefore of themselves" (p. 27).

Difficulties such as cultural differences associated with numeracy and literacy learning by Indigenous children have been acknowledged in Australia (Perso, 2003) and overseas (Agirdag, 2009). These are compounded by the requirements related to 'mathematical language'. Parkin and Hayes (2006) studied the use of word problems with Indigenous children, noting that many were competent with the mathematical processes involved but struggled when problems were embedded in an apparent 'real-life' context. They felt that this was due to children "... not being able to access the language of maths ..." and that this in turn meant that they "... had no way of interpreting the problem, identifying the mathematical processes and consequently completing the task" (Parkin & Hayes, 2006, p. 23). Indigenous children in Australian schools could be regarded as ESL (English as Second Language) learners. For some of them, the language spoken at home is an Aboriginal dialect or 'Aboriginal English', a type of 'kriol' language, or a mixture of English and a local dialect.

Recent literature from the United States presents a number of ideas that would seem to be applicable to the Australian context. A study of four United States schools with at least 30% of their populations being English Language Learners (ELL) revealed that ELLs in the four schools demonstrated substantially higher proficiency in state-wide testing than ELLs in other schools (Aleman, Johnson Jr., & Perez, 2009). The authors attributed the high success rate to four factors. First, the schools set high expectations for ELLs, based on a set of well-publicised benchmarks and collaborative planning among teachers. Second, instruction was focused on deep conceptual understanding as opposed to procedural knowledge, characterised by much student discussion, explanation and writing, as well as constant teacher feedback. Third, a 'culture of appreciation', based on mutual respect for all members of the school community, was evident. Indeed, "Parents perceive that teachers and principals value their children, their children's cultural backgrounds, and themselves" (Aleman et al., 2009, p. 68). Finally, strong, intelligent and caring leadership from school principals in establishing and pursuing clear goals through a team-oriented approach was a vital factor.

Recently, Agirdag (2009) in studying the schooling of language learners in Belgium suggested that the 'meaningful' involvement of parents, family, and the community in schools

was a crucial ingredient of success for English Language Learners. He promoted the idea that the use of children’s ‘home languages’ alongside the general language of instruction (such as English) is preferable to insisting on excellence in say, English, as the first priority. Indeed, “...excluding students’ home languages from the classroom does not assist them; rather, it may hinder their learning process” (Agirdag, 2009, p. 22).

The ideas expressed in the work of both Aleman et al. and Agirdag are supported by Ramirez and Soto-Hinman (2009) who reviewed experiences in a number of United States schools with ELLs. They suggest that the learning experience for ELLs can be greatly enhanced by avoiding culturally based stereotyping, misconceptions and misinformation, and promoting openness and involvement of parents and families. They advocated ‘opening the schoolhouse doors’ and making the school more welcoming and less reliant on the cultural heritage of its teachers but rather that of its children, parents and community. Schools are encouraged to make use of the great resource that is the parent body there before them. “Parent involvement practices do not require teachers to do everything. Recruit, recruit, and recruit parents to work with you” (Ramirez & Soto-Hinman, 2009, p. 81).

Returning to the local context, Howard and Perry (2008) identified the importance of recognising the unique ways in which Indigenous children learn mathematics and the importance of pedagogical reform to acknowledge this. They concluded that all parties involved:

... should collaborate to talk about, reflect upon and make decisions about appropriate actions that need to take place within schools and homes to enhance Aboriginal children’s mathematics learning [and] assist teachers in discussing and identifying ways in which Aboriginal children learn mathematics. (Howard & Perry, 2008, p. 7).

Context

Three primary schools situated in the eastern suburbs of Perth are involved in the project. One is an independent Indigenous school, one a state government run Indigenous school, and the other a state government run mainstream primary school. These three schools form the project cluster and have student populations shown in Table 1.

Table 1
Statistics of participating schools in the cluster

School	Controlling body	Indigenous population	Non-Indigenous population	Number of classes
School #1	Independent school board	48	0	2
School #2	W.A. Education Department	130	1	7
School #3	W.A. Education Department	50	370	17

The schools were purposively chosen as they are of differing types and have different constituent populations. Each school considered factors impacting on mathematics outcomes for its children and planned actions that would aspire to improve those outcomes. Hence, the initial plans, which form the basis of the project, varied from school to school. The plans were to be designed by key members of each school community (the Principal, teachers, School Board members) in collaboration with the researchers, who assumed the role of ‘academic friends’.

Methodology

The initial phase of the larger project was established to investigate the following three questions:

1. What are the needs of this group of Indigenous children in the learning of mathematics?
2. What factors impact these children’s mathematics learning?
3. What factors within the school context could be used to enhance children’s learning of mathematics?

A qualitative, case study approach was used to gather data to answer the questions and to understand the situation in a detailed way. The main data gathering techniques were semi-structured interviews, document analysis, classroom observation, diagnostic interviews, and focus group discussions with the two classes of children (the initial intention of using a survey instrument was abandoned when many children’s difficulties with reading was noted). The method for developing an action plan for each school varied with each school context. In School 1 for example, a broad perspective on the questions was gained by interviewing a range of participants from the school and its community — Principal; staff; Aboriginal and Islander Education Officer (AIEO); School Administrator; children; Chair of the School Board; and an Elder from the Community. These interviews were audio-recorded and were used to inform the development of the initial school profile. In addition, the researchers visited classrooms in the cluster schools and informally observed teaching in action. A similar process was followed in each of the other schools.

In School 1, base-line data about student numeracy and mathematical content knowledge were gathered from diagnostic interviews with children in Years 1 to 7 conducted by teacher education students. The interview instrument used was the interview schedule developed in the Early Numeracy Research Project (ENRP) (Department of Education of Victoria, 2001) and the interviewers were given specific training in its use. In addition, and as a means of triangulation, data from the students’ achievement on NAPLAN tests were collected in the initial stages of the project. In Schools 2 and 3, base-line data were gathered from the implementation of First Steps in Mathematics diagnostic tasks as well as from NAPLAN results.

Results and Discussion

The following discussion is informed by the three research questions, an abridged version of each being offered here as a set of organisational headings.

Mathematical Needs of this Group of Indigenous Children

Counting and place value are two key ideas that underpin mathematical understanding and initial data gathering focused on the children's knowledge of these concepts. Most children were confident in counting by ones both forward and backward when numbers were relatively small but referents such as fingers were often used, even by older children. Similarly, most children were able to recognise, write and name number symbols appropriate to their age level, and most were able to order numbers by size. There appeared to be a need for children to experience a broader view of counting including skip counting, counting from different start points, and moving beyond two digit numbers to bridge one hundred and one thousand. The ability of children to partition numbers in flexible ways seemed to be limited and this impacted on their ability to calculate beyond simple but age appropriate addition and subtraction situations.

Generally, the major need appeared to be for greater flexibility in thinking by the children. This is partly reflected in the previous comment about counting but also encompasses the need to use a range of calculation strategies, particularly with regard to children using their own mental strategies and being able to share and discuss them. As well, they need to be able to make links between addition and subtraction, and multiplication and division. Overall, there appeared to be a need for a much greater focus on the development of conceptual understanding, rather than procedural knowledge. Children generally used a very limited range of strategies when working mathematically and this needed to be broadened.

Children's literacy levels appeared to have a significant impact on their mathematical learning. In particular, a lack of 'test literacy' was felt to contribute to NAPLAN results that were below benchmark achievement. Some teachers in the schools expressed anecdotally that children performed better when given the opportunity to work on similar tasks on a one-to-one basis with a teacher or aide, whereas they tended to give up when confronted with the literacy requirements of test items in a test situation. In general, a lack of knowledge of mathematical terminology detracted from children's ability to solve problems, but also the presence of misconceptions about common terms like 'before' and 'after' caused difficulties for some children. In many instances, children had difficulty in explaining their thinking and this appeared to affect their confidence in solving problems.

Factors Impacting on Children's Mathematical Learning

One factor that was identified across all three schools was the need to raise expectations among teachers, parents, students, and the wider community. This was seen as having a 'flow on' effect on children's attendance, engagement, and learning, and was seen as a key that underpinned the Cluster Plan.

Children's rate of attendance was identified by all three schools as a significant factor though the nature of this varied across each school. In School 1, attendance on particular days of the week was better than on some other days that were not considered as 'school days' by some families. Similarly, attendance at family occasions such as funerals meant that some children were absent for extended periods. Generally, schools considered that about half of the children attended regularly and that about half did not do so.

Attention span of children was noted as an area of concern. A number of children struggled to engage with tasks and were keen to finish them quickly regardless of the result.

As well, many children were easily distracted by activity and movement and were interested to see what others in the room were doing.

There appeared to be considerable variation, in some schools more than others, regarding the level of use by teachers of ‘hands-on’ or manipulative resources. In one school, it was acknowledged that there was a general lack of such resources while in another, there were resources available but teachers were not versed in how to best use them to help children.

The contextual relevance of activities was expressed by some teachers as possibly having an adverse impact on learning. Children appeared to be more engaged when mathematics was embedded in a context that was relevant to their interests, such as sport, and where there was some incentive attached to attending and learning. There appears to be scope in the three cluster schools for embedding mathematical concepts in contexts such as gardens, sport, food and nutrition.

Factors Within the School Context that Could Enhance Learning

Each school has a different context and hence the possible factors that could enhance learning vary from school to school. Notwithstanding, the issue of parent and community involvement in schools was identified as a common factor. In two of the schools, this problem was exacerbated as a large number of parents lived up to 30 kilometres from the school campuses and did not have their own transport. It was felt that there might be a link between this and the rate of student attendance and consequent engagement in mathematical learning and that ways to improve the level of parent involvement should be investigated.

A program of ‘family days’ has been used in two of the schools and it was felt that an extension in the frequency of this program, as well as targeting mathematical activities as a part of the family days, might attract more involvement from parents. Another aspect of the plan to increase parent involvement is to encourage them to visit classrooms and see their children involved in mathematical learning experiences. Initially, this might involve parents participating in informal sessions to make simple hands-on resources for classroom use.

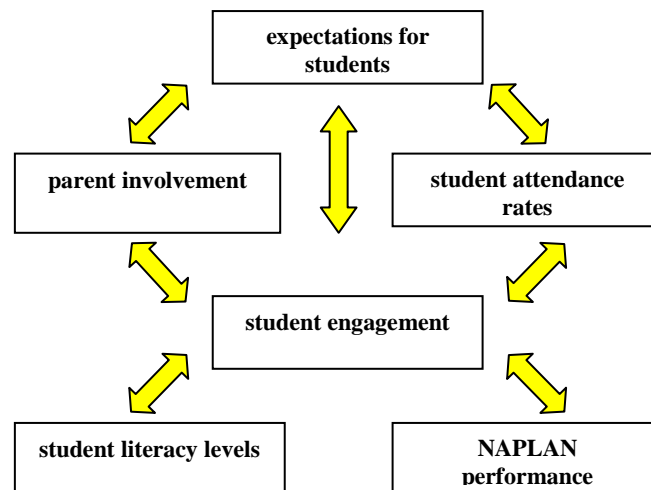

Figure 1. Cyclical relationships among common factors in Cluster Schools

Teacher professional learning, particularly in mathematics teaching, had varied considerably across the three schools, and a similar situation existed regarding the presence on staff of teachers with specific expertise in these areas. It was generally accepted that targeted professional learning in raising student expectations and in programs such as First Steps in Mathematics would benefit staff and would be likely to have a positive impact on student learning. Also, the three schools planned to share staff expertise across the cluster.

It was felt that there is likely to be a complex, almost cyclical relationship among many of the above factors and that effective strategies would be needed to ‘break the cycle’. Figure 1 represents the relationship that was thought to exist in the cluster schools.

A ‘Cluster Plan’

Following consideration of the above common concerns and issues, a Cluster Plan was developed to address them. This plan also addresses the three research questions described earlier. The main features of this plan, with examples of planned actions, are outlined in Table 2. Within the Cluster Plan, there is scope for each school to meet the specific needs of its own students within its own unique context.

Table 2
Summary of Cluster Plan

Overview of outcomes and examples of planned actions	Research question
Raise expectations for student learning <ul style="list-style-type: none"> _ Targeted specific professional learning in expectations _ Specific strategies to improve attendance rates 	Question 2 related to factors on learning
Professional development of teaching and support staff <ul style="list-style-type: none"> _ Shared professional learning and staff sharing across cluster _ Targeted development of conceptual understanding 	Question 3 related to school context factors
Increase parent involvement in educational program of schools <ul style="list-style-type: none"> _ Extend concept of ‘family days’ with numeracy focus _ Train parents to make resources and as classroom helpers 	Question 3 related to school context factors
Increase student engagement <ul style="list-style-type: none"> _ Embed concepts in high interest activities like sport, Indigenous art, and gardens 	Question 2 related to factors on learning
Target specific aspects of curriculum that require development <ul style="list-style-type: none"> _ Develop conceptual understanding rather than procedures _ Develop mathematical literacy base to improve test literacy 	Question 1 related to mathematical needs of children

Conclusion

This study approached the issue of Indigenous children’s mathematics attainment from three viewpoints – specific numeracy and mathematical needs, student related factors that impact on that learning, and factors related to school contexts that could enhance that learning. First, there appear to be a number of aspects of mathematics in which the Indigenous children at these three schools require specific assistance. These are related to the need to develop

conceptual knowledge as opposed to procedural knowledge and linked to this is the need for greater flexibility in the use of key concepts such as counting and place value. Children's literacy levels and test literacy greatly impact on their mathematical learning and test achievement. Second, the level of expectations for, children's achievement, as well as their rates of school attendance, are identified as key factors in their learning. Children's engagement and the use of a range of hands-on resources are also significant. Third, the need for targeted professional learning of teachers to address identified mathematical and numeracy needs is important, as is the need to increase parent involvement in schools.

Note

In this paper, both the words 'Indigenous' and 'Aboriginal' are used. It is acknowledged that use of the word 'Aboriginal' is considered to be inappropriate in some Australian states and its use here is not intended to cause offence. The 'word of choice' in this paper is 'Indigenous', except where a direct citation from another source is made.

References

- Agirdag, O. (2009). All languages welcomed here. *Educational Leadership*, 66(7), 20-25.
- Aleman, D., Johnson Jr., J., & Perez, L. (2009). Winning schools for ELLs. *Educational Leadership*, 66(7), 66-69.
- Australian Association of Mathematics Teachers. (2009). *Make it count: Newsletter No.1*. Adelaide: Author.
- Frigo, T. (1999). *Resources and teaching strategies to support Aboriginal children's numeracy learning*. Australian Council for Educational Research: Melbourne.
- Howard, P. & Perry, B. (2008). *Learning mathematics: Perspectives of Australian Aboriginal children and their teachers*. Retrieved 24 February 2010 from <http://www.emis.de/proceedings/PME29/PME29RRPapers/PME29Vol3HowardPerry.pdf>
- Khan, G. (2009). Presentation given to *Make It Count* Network Meeting, Adelaide, September 2009.
- Parkin, B., & Hayes, J. (2006). Scaffolding the language of maths. *Literacy Learning: the Middle Years 14* (1), 23-35.
- Perso, T.F. (2003). *Improving Aboriginal numeracy*. Australian Association of Mathematics Teachers: Adelaide
- Perso, T.F. (2009). *Pedagogical framework for cultural competence*. Retrieved 17 February 2010 from, <http://makeitcount.aamt.edu.au/Resources/Cultural-competency>
- Quinn, G. (2009). Presentation given to *Make It Count* Network Meeting, Adelaide, September 2009.
- Ramirez, A.Y., & Soto-Hinman, I. (2009). A place for all families. *Educational Leadership*, 66(7), 79-82.
- Sullivan, P. (2009). *Numeracy, mathematics and Indigenous students: What are the big questions?* Presentation given to *Make It Count* Network Meeting, Adelaide, September 2009.

Student Attitude, Student Understanding and Mathematics Anxiety

Michelle Jennison

University of Tasmania

<mhj@postoffice.utas.edu.au>

Kim Beswick

University of Tasmania

<Kim.Beswick@utas.edu.au>

This paper reports on two of ten themes that emerged from a study of the impacts of a fraction teaching intervention on the mathematics anxiety and fraction competence of eight Year 8 students. The themes arose from multiple data sources and relate to Student Attitude and Student Understanding. The students identified practical, hands-on activities and group work as impacting positively on their understanding and their confidence in relation to fractions. The influence of improved understanding and confidence was also recorded as positively affecting student attitudes to fractions in particular and mathematics in general. The study highlights the connections between mathematics anxiety among middle school students and their existing understandings of and attitudes towards mathematics.

Recognised since the early 1970s, mathematics anxiety has been defined as “feelings of tension and anxiety that interfere with the manipulation of mathematical problems in a wide variety of ordinary life and academic situations” (Richardson & Suinn, 1972, p.551). It is regarded as multidimensional (Ma, 1999) having components relating to attitude, cognition and emotion that manifest in inclinations, thoughts, feelings toward mathematics. Each of these components is influenced by a range of other factors including teachers, parents and teaching (Dodd, 1992; Ma, 1999; Goldstein, 1999; Turner et. al, 2002). As well as being considered to have an attitudinal component, mathematics anxiety is also considered to be one dimension of attitude to mathematics (Ma & Kishor, 1997), and in that context can be considered as one end of a confidence-anxiety spectrum.

Hembree’s (1990) meta-analysis of studies of mathematics anxiety amongst school students revealed that mathematics anxiety reaches its peak in Years 9 and 10 with Years 7 and 8 identified as significant in its development (Aiken, 1970; Hembree, 1990). These years are also recognised as a crucial period in the development of students’ mathematical understanding: it is well known that rational number concepts, particularly fractions, present difficulties for many middle school students and that students’ lack of competence with fractions is a major influence on their overall mathematics competence (Siemon, Virgona & Cornielle, 2001). It is, therefore, likely that both cognitive and affective factors play a role in the development of mathematics anxiety in the middle years. Ashcraft and Kirk (2001) explained that favourable attitudes and low mathematics anxiety allow an individual to enjoy and seek out mathematics experiences leading to increased mathematical competence. Conversely, poor attitudes and high anxiety are associated with avoidance behaviour and this leads to decreased mathematical competence. In addition, they found that “higher levels of mathematics anxiety are related to lower available working memory capacity” (p. 236). Their research indicated that whilst the anxiety exists, the student may find it difficult to focus their attention on the task at hand or may have distracting thoughts, which prevent them from engaging with the task further militating against the development of competence.



In spite of the importance of the middle years, the majority of research on mathematics anxiety has involved adult students, often primary pre-service teachers. The study described here attempts to address that gap by focusing on Grade 8 students who experienced mathematics anxiety. The difficulties associated with fraction learning made this a suitable context in which to study relationships among students' mathematical understanding, mathematics anxiety and broader attitudes to the subject.

Alleviating mathematics anxiety and minimising the chances of its development are worthy goals in themselves and even more important given the impact of mathematics anxiety on students' abilities to learn the subject (Ashcraft & Kirk, 2001). To this end Dodd (1992) advocated, "The adoption of more personal and process-oriented teaching methods can help in solving this problem" (p. 296), and in a study of 1197 sixth grade students, Turner et al. (2002) found that "a perceived emphasis on mastery goals in the classroom was positively related to lower reports of avoidance". Avoidance is of course one manifestation of anxiety. It seems that when the emphasis is on understanding rather than on competition and ability, students make efforts to seek help or to improve their understanding, rather than avoid these situations. Uusimaki and Kidman (2005) recommended interventions that empower students to develop confidence as learners and highlighted the benefit of self-reflection and self-monitoring in reducing mathematics anxiety. Journal writing is a specific tool that has been used in efforts to reduce mathematics anxiety and has also been shown to increase student learning (Connor-Greene, 2000).

The Study

The study was designed to monitor in detail the impacts upon mathematics anxiety of a fraction teaching intervention. The research question of particular relevance to this paper was: In what ways is mathematics anxiety related to other aspects of students' attitudes to mathematics and their mathematical understanding?

Instruments

Mathematics Anxiety Questionnaire (MAQ). This 17-item questionnaire was adapted from that developed by Wigfield and Meece (1988) to include items about mathematics anxiety in relation to the topic of fractions as well as in relation to mathematics generally. Responses were sought on 5-point Likert scales ranging from "Not at all" to "Very much."

Fractions Tests. Two tests designed to cover the fraction understandings required at Year 8 level for all students in Tasmanian schools (Department of Education, 2007) were developed for use at the beginning (FT1) and end of the project (FT2). Both were designed in conjunction with the students' usual mathematics teacher. To minimise the possible impact of familiarity with the questions on the results of FT2, the items varied but a similar degree of difficulty was maintained. Rubrics describing levels of performance beyond correct answers were used to classify the students' understanding of each of addition and subtraction, fraction size, equivalence, mixed and improper fractions, and multiplication as low, medium or high, and also to provide an overall rating.

Interviews. Individual interview were conducted with each participant prior to the commencement of the intervention and again at the end. The initial interviews provided

insights into the students' prior experiences of learning mathematics, their knowledge of fractions, and attitudes to mathematics generally and fractions in particular. Questions asked participants to expand upon some of their responses to the MAQ and about their feelings while completing FT1. The second interview aimed to determine whether mathematics anxiety levels had changed and asked participants' about their perceptions of why this had or had not occurred. Informal group and individual interviews conducted throughout the intervention and were aimed at exploring the students' thinking about and developing understandings of fractions as well as their feelings about the topic. Questions included, "How did you feel about the lesson on fractions today?" and "Which part of the lesson did you enjoy most? Why".

Student journals. Each participant kept a journal throughout the intervention. The students were encouraged to reflect upon their feelings and ideas at the end of each lesson, initially with the aid of prompts upon which they could expand. Examples included, "Today I learnt" And "this made me feel ...", and "I felt like this because ...". The students were encouraged to let their feelings flow without worrying about spelling or expression.

Video-taped lesson observation. The intervention lessons were video-taped in order to record non-verbal indications of anxiety and understanding as they occurred.

Participants and procedure

The FT1 and the MAQ were administered, under the supervision of the class' mathematics teacher, to 40 students in two Year 8 mathematics classes in an independent boys' school. Based on the results, eight students who experienced the highest levels of mathematics anxiety, compared with the other Year 8 students at their school were selected to participate in the intervention. The pseudonyms Andrew, Bill, Colin, Darren, Evan, Frank, Gerry and Houston have been used for the eight students. Six intervention lessons commenced after initial individual interviews with each participant had been conducted. The lessons, conducted by the first author, made use of McIntosh and Dole's (2004) mental computation materials, and emphasised the development of conceptual understanding of fractions. Hands-on learning materials were used in order to assist students in visualising fraction sizes and locations of the number line and efforts were made to meet the individual learning needs of the students involved. The lessons involved manipulating cut-out shapes from paper, drawing shapes, working with fractions cards, rolling dice and playing fraction games. Collaborative work was an important feature of each of the lessons and was facilitated by seating all students around a central table. The lessons covered: basic concepts and representations; equivalence (two lessons); ordering; addition and subtraction; and multiplication and division. The FT2 and the MAQ were administered to the eight participants one week after the conclusion of the intervention and the final individual interviews were conducted after this.

A constructivist grounded theory approach applied in two phases (Charmaz, 2006) was used to code all of the interview data, video recordings of lessons, and student journal entries in order to identify themes (Burns, 2000, p. 441). Initial analysis involved open coding in a line-by-line fashion to identify emergent codes in each of the three data types. The data were then re-analysed using these codes to ensure they accurately reflected the data. Axial coding was then applied to make a more coherent and accessible interpretation of what was occurring (Charmaz, 2006). Axial coding provides answers to questions relating to conditions, actions

and consequences. Hence, “when, why, where, how come and by whom and how” and “what happens because of these actions” are the nature of the questions addressed by axial coding. Axial coding provides a thorough coverage of the recorded experience and “a frame for researchers to apply” (Charmaz, 2006, p. 61). To this end, themes or categories were developed. The construction of categories involved the examination of codes from each of the three data types. For instance, ten codes were grouped and categorised using the title, *Student Understanding of Fraction Concepts* (see Table 1). The codes assisted in providing a framework with which to work in an attempt to understand the implications of what was revealed.

Results

Data relevant to the research question that is the focus of this paper derived from the fraction tests, interviews, student journal entries, and the six video-taped lessons. Ten themes, *High confidence and positive attitude, Enjoyment, Improved understanding, Low confidence and self-doubt, Previous experience, Lack of understanding, Memory, Factors affecting learning, Teaching methods, and Teacher and Parental influence*, emerged from open-coding of the interview data. The journal entries gave rise to seven themes; *High confidence and positive attitude, Improved understanding, Enjoyment, Lack of confidence, Lack of understanding, Memory, Teaching methods, and Teacher and Parental influence*. The axial coding phase resulted in a total of 10 categories that reflected the themes from each of the three data types. The two categories that are relevant to this paper are shown in Table 1 along with codes from phase 1 that relate to them, and the numbers of participants who had at least one instance of each code in their interview or journal. For the video data the focus was on the classroom dynamics, rather than on individuals, so when codes for a participant occurred more than once within a lesson as a result of repeated verbal and non-verbal behaviour, all instances were counted and are included in the total number of occurrences. Counting the behaviour as it occurred indicated the prevalence or scarcity of particular behaviours across the lessons.

The *Student Attitude* category focused on behaviours representing attitudes towards mathematics. Most of the behaviours recorded were indicative of positive attitudes. However, in the pre-intervention interviews, only Andrew and Gerry talked about having a confident and relaxed attitude to mathematics. Both were relaxed throughout the intervention and achieved highly on both FT1 and FT2. By the end of the intervention, Andrew, Darren, Frank and Houston indicated confident and relaxed attitudes through their responses in the post-intervention interviews and specific mentions in their journal entries. When asked how his approach to fractions had changed after the intervention compared with before it, Andrew commented, “I don’t really hesitate about it.” In response to the same question, Frank commented, “I feel more confident with maths now ... there’s a better way to solve a problem without trying to rely on the teacher and get it right.” Darren answered the same question by stating: “Knowing how to do fractions, I can help other people if they need help.”

Anderson (2007) found in his study of Year 4, 5 and 6 students that there were “very few responses that show a positive attitude associated with a high anxiety” (p. 101), so it is not surprising that Andrew, Colin, Gerry and Houston, who were identified as having a *confident and relaxed attitude towards mathematics*, also showed a reduction in mathematics anxiety by the end of the intervention as measured by the MAQ. For instance, Andrew appeared relaxed

during the intervention lessons and participated willingly in all of the activities. He never appeared frustrated and always persisted calmly until he had completed each activity. When Andrew was asked to divide a circle into fifths and explain his drawings, he was able to explain clearly and confidently why each of his attempts leading up to the successful attempt did not work. He did not rely on the help of others and other students would sometimes look to him for help. Colin too, demonstrated self-reliance and confidence in his mathematical ability throughout the intervention lessons. When asked to show a third of a collection of cubes, Colin made the correct selection but then questioned whether he had counted correctly. When the other students did not support the answer, Colin continued to reconsider his choice and confidently asserted, “Yes, that is right.” He did not give in to others’ opinions but was confident with his own correct thinking.

Table 1
Categories Related to Student Attitude and Understanding

Category	Related codes	No. students (n=8)		No. Instances
		interviews	journal	video
Student attitude	Confident and relaxed attitude towards mathematics	4	4	-
	Focusing on getting high marks	1	-	-
	Desire to do better at mathematics	1	-	-
	Asking for help	-	-	4
	Carefully considering the mathematics before answering	-	-	1
	Becoming easily distracted	-	-	15
	Totals	6	4	20
Student understanding of mathematics	Finding difficulties with fractions	1	5	-
	Not enjoying mathematics because of lack of understanding	1	-	-
	Guessing the answer	-	-	10
	Trying repeatedly to complete the mathematics without achieving desired results	-	-	6
	Enjoying mathematics because of understanding it	2	2	-
	Improving knowledge of fractions	3	5	-
	Understanding mathematical concepts	-	-	27
	Raising hand to offer response	-	-	9
	Smiling or laughing	-	-	45
	Lacking mathematical understanding	-	-	18
	Totals	7	12	115

Gerry and Houston also seemed to have attained greater confidence in their mathematical abilities by the end of the intervention lessons. Gerry’s responses on the second MAQ indicated that he felt more comfortable answering questions from the teacher and taking tests

and less worried about his ability, compared to others, on assignments. His relaxed but enthusiastic behaviour throughout the intervention and the improvement in his performance on FT2 compared with FT1 may have been influenced by his increased self confidence. Similar to Andrew, Colin and Gerry, Houston's responses on the first MAQ indicated that he valued doing well at school in general and in mathematics in particular. Perhaps consistent with Houston's desire to perform well at mathematics and the importance he seemed to place on the subject, was his response to the following item, which increased slightly from, "not at all" on the first MAQ, to "a little bit" on the second MAQ: Does it scare you to think you will be taking advanced high school mathematics?

Performance on FT1 and FT2 provided data on the students' understanding of fraction concepts. The overall ratings that achieved in the tests are shown in Table 2. Unsurprisingly, given the brevity of the intervention, the understanding of just two students improved sufficiently to change their level. Pre- and post-interviews, journals and the videoed lessons, all of which evidenced the category Student Understanding of Mathematical Concepts provided more nuanced insights.

Table 2
Participants' Overall Fraction Understanding Evident from FT1 and FT2

	Description of understanding	FT1	FT2
Low	Demonstrates little or no understanding of some of all of the following fraction concepts: addition and subtraction; size; equivalence; and multiplication.	Bill, Darren, Evan	Bill, Darren, Evan
		$\frac{3}{4}$	
Medium	Demonstrate some understanding of most of the following concepts: addition and subtraction; size; equivalence; and multiplication.	Gerry, Houston	
High	Demonstrates a solid understanding of all of the following concepts: addition and subtraction; size; equivalence; and multiplication.	Andrew, Colin, Frank	Andrew, Colin, Frank, Gerry, Houston

Students with high levels of fraction understanding, based on the results of FT1, seemed to have positive attitudes to mathematics and were also highly motivated. They demonstrated a focus on getting high marks and a desire to do better. According to Dodd (1992), a lack of confidence in his/herself is one of the major barriers to a student achieving in mathematics. Ashcraft and Krause (2001) acknowledged that favourable attitudes to mathematics and low mathematics anxiety allow an individual to enjoy and seek out mathematical experiences. Meece, Wigfield and Eccles (1988) found that if a student is expecting to achieve highly, they will experience less anxiety compared with a student who expects not to achieve well in mathematics. Unlike the low achieving students in this study who expressed a desire to do better, the high achieving students were proactive in their efforts to improve their performance. For example, they asked for help when they required it and they appeared never to be satisfied with not knowing. Clute (1984) found that having confidence in one's ability to do mathematics may mean having confidence to discover and explore and trust "his or her own methods of mastering the material" (p. 56). For instance, when asked to fold a circle into

thirds without drawing the thirds on the circle first, Houston asked, “Can you fold a circle into thirds? ... I folded it into halves so that you had eight of them and then if you divided it into three, it won’t work.” The students with stronger understanding were also less likely to guess answers, but rather would carefully consider responses to mathematical questions. However, Bill and Evan, whose performances on the fraction tests were low, often showed avoidance behaviour. For instance, when asked to explain his answers, Evan often replied with statements like the following: “I don’t have a clue”; “What if I haven’t a clue where it is meant to be?”; “I don’t know what to do!!” This finding is consistent with Ashcraft and Kirk’s (2001) assertion, that poor attitudes and high anxiety support avoidance behaviour. Dodd (1992) indicated that when self-confidence in one’s ability is low, performance is compromised and avoidance may result contributing to mathematics anxiety. In Lesson 3, students were each given a card with a fraction on it and asked to stand in an appropriate position along a number line at the board. Evan avoided engagement with the relevant ideas while appearing involved. When asked how he chose the position he had, he reacted quickly with, “I am just here because Colin told me to be.”

Throughout the intervention, students exhibited different behaviours as a result of their degree of understanding of the mathematics. A lack of fraction understanding was noted in relation to Evan a total of 11 times throughout the lessons, a greater number than for any other students. There were also fifteen recordings of students ‘Becoming easily distracted and lacking engagement with mathematics’. Fourteen of these related to Evan and one to Bill. Both students were very low achieving according to both FT1 and FT2. Evan’s reluctance to engage was evident in the first lesson to which he brought a basketball. During this lesson, he was often “spinning the ball in his lap”. Hence, in conjunction with a lack of understanding and low achievement levels, Evan seemed to place little, if any, importance upon understanding the mathematical concepts, but rather focused on completing the task quickly and hoping to get the right answer. There were six times throughout the lessons where one or more students tried repeatedly to complete the mathematics without achieving desired results. According to Clute (1984), highly anxious and less able students of mathematics may prefer the expository approach to teaching rather than discovery lessons as they may lack the confidence to discover and explore. This may explain why Evan demonstrated behaviours that indicated he was anxious to give answers quickly, rather than understand the mathematical concepts.

Improved understanding was also linked to enjoyment of the subject. Frank commented in his journal at the end of Lesson 2, that “It made me feel that fractions were a lot simpler” and Frank said, “I’ve learnt many things that don’t make me so anxious now.” Bill wrote in his journal at the end of lesson three, “This activity made me feel fractions are easier than I previously thought.” Five of the eight students recorded an improvement in their understanding of fractions in their journal entries. For example, Gerry wrote, “I think that this has given me more knowledge of fractions which will help me through the test of school.” Similarly, Houston wrote, “From the six lessons I learned a lot. I could even say every lesson I understood something better or things got clearer for me.”

Discussion and Conclusions

The research question of relevance to this paper was: In what ways is mathematics anxiety influenced by other aspects of students' attitudes to mathematics and their mathematical understanding? The findings showed that opportunities for hands-on and interactive work in a supportive and relaxing environment appeared to allow students improved understanding of mathematics, in conjunction with increased confidence in their own abilities. This feeling of empowerment enabled students to develop positive attitudes to learning mathematics. Students described the intervention lessons as "providing an easier way" (Frank) and improving existing understandings (Houston). Several linked cognitive and affective aspects of their experiences, connecting ease of learning with feelings of comfort (Evan) and enjoyment. The pre- and post-interviews revealed that six of the eight students showed increased in confidence and demonstrated a positive attitude by the end of the intervention. And fewer students reported worrying about explaining mathematics to the class.

The findings suggest that it is important for teachers to be aware of both the cognitive and affective aspects of learning and teaching mathematics (McLeod, 1992). They illustrate that for many students, their limited existing understanding of a topic in mathematics or their feelings of inadequacy in the subject, may lead to poor attitudes towards mathematics. It appears necessary for teachers to become aware of individual students' existing understanding of a topic in order to meet students' learning needs adequately. Students also need to be encouraged by their teachers to be involved in their learning, shifting their focus from reliance on others to personal responsibility. Goldstein (1999) emphasised the importance of teacher support and encouragement to students' motivation to understand and achieve. This study used hands-on and interactive activities with students and this appeared to be helpful to this end. However, the type of hands-on work that is provided and the way it is implemented need to be framed appropriately in order to support the learning of individual students.

The findings show the interrelationships amongst student understanding, student attitude and mathematics anxiety. They confirm the wisdom of studying cognitive and affective aspects of learning and teaching together (MacLeod, 1992) and of adopting a holistic approach to engaging students with mathematics (Turner et al., 2002).

References

- Anderson, V. (2007). *An online survey to assess student anxiety and attitude response to six different mathematics problems*. Paper presented at the 30th Annual conference of the Mathematics Education Research Group of Australasia, Hobart, Australia.
- Ashcraft, M., H., & Kirk, E., P. (2001). The relationships among working memory, math anxiety and performance. *Journal of Experimental Psychology*, 130(2), 224-237.
- Ashcraft, M., H., & Krause, J.A. (2001). Working memory, math performance, and math anxiety. *Psychonomic Bulletin & Review*, 14(2), 243-248.
- Burns, R. B. (2000). *Introduction to Research Methods* (4th ed.). French's Forest, NSW: Longman.
- Charmaz, K. (2006). *Constructing grounded theory: A practical guide through qualitative analysis*. London: Sage.
- Clute, P.S. (1984). Mathematics anxiety, instructional method, and achievement in a survey course in college mathematics. *Journal for Research in Mathematics Education*, 15(1), 50-58.
- Connor-Greene, P. A. (2000). Making connections: Evaluating the effectiveness of journal writing in enhancing student learning. *Teaching of Psychology*, 27(1), 44-46.

- Department of Education, Tasmania. (2007). *The Tasmanian Curriculum*. Retrieved February 12, 2007, from <http://www.education.tas.gov.au/curriculum/home>.
- Dodd, A.W. (1992). Insights from a math phobic. *Mathematics Teacher*, 85(4), 296-298.
- Goldstein, L. (1999). The Relational Zone: The role of caring relationships in the co-construction of mind. *American Educational Research Journal*, 36(3), 647-673.
- Hembree, R. (1990). The nature, effects, and relief of mathematics anxiety. *Journal for Research in Mathematics Education*, 21(1), 33-46.
- Ma, X. (1999). A meta-analysis of the relationship between anxiety toward mathematics and achievement in mathematics. *Journal for Research in Mathematics Education*, 30(5), 520-540.
- Ma, X., & Kishor, N. (1997). Assessing the relationship between attitude toward mathematics and achievement in mathematics: A meta-analysis. *Journal for Research in Mathematics Education*, 28(1), 26-47
- McLeod, D. B. (1994). Research on affect and mathematics learning in JRME: 1970 to present. *Journal for Research in Mathematics Education*, 25(6), 637-647.
- McIntosh, A. & Dole, S. (2004). *Mental computation: A strategies approach*. Hobart, Tasmania: Department of Education, Tasmania.
- Meece, J.L., Wigfield, A., & Eccles, J.S. (1990). Predictors of math anxiety and its influence on young adolescents' course enrolment intentions and performance in mathematics. *Journal of Educational Psychology*, 80, 210-216.
- Richardson, F. C., & Suinn, R. M. (1972). The mathematics anxiety rating scale: Psychometric data. *Journal of Counseling Psychology*, 19(6), 551-554.
- Siemon, D., Virgona, J., & Cornielle, D. (2001). *The Middle Years Numeracy Research Project: 5-9*, Final Report. : Department of Education, Employment and Training, Victoria, Catholic Education Commission of Victoria and Association of Independent Schools of Victoria.
- Turner, J. C., Midgley, C., Meyer, D. K., Gheen, M., Anderman, E. M., Kang, Y., et al. (2002). The classroom environment and students' reports of avoidance strategies in mathematics: A multimethod study. *Journal of Educational Psychology*, 94(1), 88-106.
- Uusimaki, L., & Kidman, G. (2005). *Reducing maths-anxiety: results from an online anxiety survey* [Electronic Version]. Australian Association for Research in Education Conference. Retrieved May 1, 2007 from <http://www.aare.edu.au/04oao/kid04997.pdf>
- Wigfield, A., & Meece, J. L. (1988). Math anxiety in elementary and secondary school students. *Journal of Educational Psychology*, 80(2), 210-216.

Upper Primary School Students' Algebraic Thinking

Natcha Kamol
Chiang Mai University
<natcha@chiangmai.ac.th>

Yeap Ban Har
Nanyang Technological University
<banhar.yeap@nie.edu.sg>

This qualitative research study involving 128 students in grades 4-6 was conducted to develop a framework for characterizing upper primary school students' algebraic thinking. Four levels of algebraic thinking were identified from student responses to tasks involving patterns and open number sentences. Level 1 students failed to understand the tasks or answered with irrelevant data. Those at Level 2 understood the tasks but were unable to proceed further. Level 3 students were able to complete the tasks but were unable to link one aspect of the task to another. Level 4 students understood the relationship among various aspects of data and used all aspects of the data.

To improve students' learning in mathematics, it is necessary to understand the developmental mode of their thinking and reasoning. With the nature of mathematics that deals with abstract entities, students have difficulty in understanding mathematics concepts, especially those in algebra. Therefore, thinking, particularly algebraic thinking, is a tool for understanding abstraction (Russell, 1999). Typically, most school mathematics curricula separate the study of arithmetic and algebra. Arithmetic is the primary focus of elementary school mathematics and algebra is the primary focus of secondary school. So, it is difficult for students to transform from arithmetic to algebra. Students in later grades of elementary school should have more experiences of formal study of algebra (Kieran, 2004; National Council of Teachers of Mathematics [NCTM], 2000). A broader conception of algebra emphasises the development of algebraic thinking, rather than just the skilled use of algebraic procedures. Although algebra is not the focus of the *primary* school curriculum, students should be prepared to be familiar with algebra especially generalization. Although algebraic thinking, a tool for learning algebra, is one of the themes for developing students' understanding of mathematics, there are few suggestions of what should be used in the classroom activities, especially in Thailand. The researchers were interested in two key components of the elementary school mathematics, namely, patterns and open number sentences. Existing research on primary school students' algebraic thinking has not yet generated a framework for systematically characterizing students' algebraic thinking based on the cognitive learning theory such as the SOLO (Structure of the Observing Learning Outcome) model of Biggs and Collis (1982). In essence, if an algebraic thinking framework is developed, it would provide detailed cognitive models of students' learning that can guide the construction and planning of mathematics instruction and curriculum as Cobb (2000) have suggested.

Purpose of the Study

The purpose of this study was to formulate a framework to characterize upper primary school students' algebraic thinking in the content areas of patterns and open number sentences.

Theoretical Consideration

Biggs and Collis developed the SOLO Model which suggests five modes of functioning; *sensorimotor, ikonik, concrete-symbolic, formal, and postformal* functions.



Each mode consists of five levels of thinking; *prestructural*, *unistructural*, *multistructural*, *relational* and *extended abstract* levels. The SOLO Model and previous studies related to mathematical thinking or frameworks for characterizing children's mathematical thinking (Biggs and Collis, 1982; Jones, Thornton, Langrall, Mooney, Perry, & Putt, 2000; Mooney, 2002) were consulted in order to formulate a framework for characterizing upper primary school students' algebraic thinking. Since this study focused on upper primary school students, the researcher hypothesized that students were on the concrete symbolic mode of SOLO model. This concrete symbolic mode involves a more abstract process of learning and is considered as a significant shift in abstraction, from direct symbol systems of the world through oral language to the use of second order symbol systems such as written language that can be applied to the real world. Within this mode, even though the SOLO model characterized students into five levels, several previous studies (Jones, Langrall, Thornton, & Mogill, 1997; Jones, et al., 2000; Mooney, 2002) indicated that students responded only to four levels of thinking. They did not respond beyond relational level. Thus, in this study the researcher expected that students can be characterized in four levels of algebraic thinking: *prestructural* (Level 1), *unistructural* (Level 2), *multistructural* (Level 3), and *relational* (Level 4). The upper primary school students' algebraic thinking is referred to the ability of students to use their thinking skills to generalize the patterns and analyze a relationship between numbers on each side of the equal sign.

Methodology

Data Collection and Validation

After an initial framework was developed, the researcher conducted a test and an interview guide in order to collect data to validate the initial framework. The test was tried out with six students as a pilot group, two from each grade, to determine the appropriateness (language and difficulty) of the test and to study the ways students responded to questions. After that, the test was revised again for the final form, illustrated in Figure 1.

The Pattern task

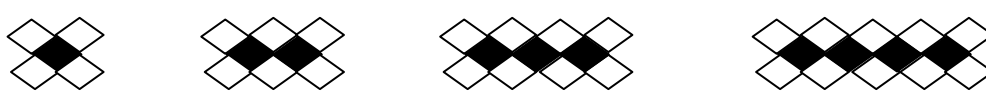

From the bead pictures, answer these questions and show the way of thinking that you use to answer the question.

(1.1) Making beads to be as the pictures by using 5 black beads.
How many white beads are used?

(1.2) Making beads to be as the pictures by using 30 black beads.
How many white beads are used?

(1.3) Making beads to be as the pictures by using 100 black beads.
How many white beads are used?

The open number sentence tasks

1) $8 + 5 = \underline{\quad} + 8$

2) $32 + 45 = \underline{\quad} + 30$

Figure 1. Examples of pattern task and open number sentence tasks.

The interview guide was trialled with the pilot group. The results of the pilot study were transcribed and coded by three coders (the researcher and two coders). The coders were trained by the researcher before they did the coding. The test consisted of three pattern tasks and an open number sentence task incorporating four questions (see the example of a pattern task and the open number sentence tasks in Figure 1). The test was administered to 128 upper primary (4th to 6th) grade school students from three classrooms. Eighteen of the 128 students were chosen for interviewing in order to refine the descriptors in an initial framework. Six students were chosen from each of the three grades. Two students from each grade were selected from the high, average and low achievement groups.

In the process of validating the framework, each of these 18 students was interviewed by the researcher to gain further insight into their thinking. After that, the interviews were transcribed and coded with the students' paper work. Three coders independently coded all 18 student interviews and responses from the paper work. In coding data, the coders based their work on a double coding procedure suggested by Miles and Huberman (1994) and then verified their differences until a consensus was reached. The reliability among the coders was 84%. The results from analysis were used to refine and validate the algebraic thinking framework.

Results

The results of this study consist of two phases. The first phase presents the formulation of the algebraic thinking framework and the second phase presents the results of validating the algebraic thinking framework. This paper describes only the result from the second phase

Refinements to the Initial Framework

The researcher refined the framework to improve consistencies and eliminate discrepancies between the descriptors in the framework and students' responses. Table 1 shows the descriptors of the refined algebraic thinking framework across two key indicators. Underlined statements are those modified in the initial framework so as to represent more closely students' responses in algebraic thinking.

Profiles of Students' Levels of Algebraic Thinking

Based on the results of coded responses, a student was assigned to a level of thinking for each key algebraic situation following agreement of coders and the researcher. Figure 2 shows profiles of 18 students' levels of algebraic thinking for two key components.

From these profiles, 13 students (72.22%) had the same levels of thinking across all two key components. Five students (27.78%) had levels of thinking with one component one level higher or one level lower only.

Table 1

Refined upper primary school students' algebraic thinking framework

Indicator Level	Pattern	Open Number Sentence
Level 1	<p>P11: Unable to explain how the terms in the pattern relate.</p> <p>P12: Unable to find the next term, the near term, the far term, and general term of the given pattern.</p> <p>P13: <u>The reason used to find the answer for the pattern is generated through guessing or citing irrelevant evidences.</u></p> <p>P14: The explanation of the reason is based on empirical method – choosing only a part of the given data to form the conclusion, e.g. using the data from a particular term of the pattern to answer.</p>	<p>S11: Look at the equation in new perspective by transforming it in to “Problem = ____”</p> <p>S12: Not concerned if both sides of the equal sign are equal disabling them to analyse that the number put in the blank must be the one that makes both sides of the equal sign equal.</p> <p>S13: Unable to analyse the function of each of the numbers in the equation nor see the function of each number in the open equation.</p> <p>S14: Find the answer by taking all the given numbers in the open equation to operate and put the product in the blank without concerning in what position the blank is. Such operation is done under the transformation of the open equation into the new one. That is “ – Problem = ____ ”</p>
Level 2	<p>P21: Able to analyse one-dimensional function of the terms in the pattern.</p> <p>P22: Unable to analyse two-dimensional function of the positions of the term and value of the term in such positions.</p> <p>P23: Able to find the next term, and the near term of the given pattern but unable to find the value of the far term and general term of the given pattern.</p> <p>P24: The acquisition of the conclusion is done through conceiving the recursive function as the value of the next term = value of the preceding term + difference between the terms. That is the preceding term is used to find the value of the following term.</p>	<p>S21: View the given open equation in term of “Problem = answer” without being concerned with other numbers in the same side with the answer if any</p> <p>S22: Not concerned if both side of the equation is equal disabling them to analyse the numbers to be put in the blank which would make the both sides equal.</p> <p>S23: Unable to analyse the relationship between number nor see the relationship between each number in the open equation.</p> <p>S24: <u>Find the answer by taking the number in the left side of the equation to add together or to subtract from one another .</u></p>
Level 3	<p>P31: Unable to analyse the function of the value of each term in the pattern of the value of the following term = the value of the preceding term + the difference between the terms.</p> <p>P32: Able to analyse the function between the positions of the term and value of the term in such positions by using induction – to find the formula to represent function that is relevant to the value of the given preceding terms and conclude that the proposed formula is valid for each term regardless of the origin or definition of the numbers used to validate the formula and able to use the formula to find the value of the terms in particular conditions.</p>	<p>S31: View the open equation as “product on the left hand = product on the right hand”</p> <p>S32: Able to analyse that the number to put in the blank of the equation must be the one that makes both side of the equal sign equal.</p> <p>S33: <u>View the open equation in parts disabling them to analyse the relationship between numbers in the open equation nor see the relationship between numbers of the open equation.</u></p> <p>S34: Find the answer by using computational reason. That is to compute the product on one side of the equal sign and subtract it from the remaining numbers on the other side of the equal sign.</p>

Indicator	Pattern	Open Number Sentence
Level		
Level 3	P33: Able to find the formula to represent the general terms of the given pattern enabling them to find the value of the following term, the near term, and the far term, and any other terms of the pattern.	
Level 4	<p>P41: Able to analyse the function of the terms in the pattern of value of the following terms = value of the preceding term + difference between the terms.</p> <p>P42: <u>Able to analyse the function of the position of the terms and value of the term at each position by proving through the condition of the given pattern in a meaningful and logical ways not through the induction. Students at this level could clearly explain the origin and meaning of the numbers appeared in the general formula of the pattern.</u></p> <p>P43: Able to find the formula to represent general terms of the given pattern enabling them to completely find the following term, the near term, the far term, or any other terms in the pattern.</p>	<p>S41: View the given open equation in terms of the left side expression = the right side expression.</p> <p>S42: Able to analyse that the number to be put in the blank of the open equation must be the one that makes both side of the equal sign equal.</p> <p>S43: View the open equation as a whole, not separately look at each part, enabling them to see the relationship between numbers in the open equation.</p> <p>S44: Find the answer by using functional logic through the analysis of the relationship of the numbers in the open equation.</p>

Analysis of Algebraic Thinking at Each Level

In order to generate a final picture of each of the levels of students' algebraic thinking, the researchers chose a student to represent those who had the same level of thinking across two key algebraic situations to illustrate the point.

Level 1 Thinking. Students exhibiting Level 1 algebraic thinking were confused or unable to understand the tasks. They avoided answering the question or answered by guessing basing on irrelevant data.

Wasu, who was studying in 4th Grade, was selected to illustrate a Level 1 algebraic thinker. For the *pattern* problems, Wasu did not understand or was confused about the pattern. He gave an irrelevant answer. He did not know that the given data was a pattern. He did not know how to use the given pattern to answer the question. When finding a specific term as the answer, he could not find any term of a given pattern. In Problem 1 of pattern problems, when asked to find the number of black beads with five white beads, Wasu drew a new figure irrelevant to the given one to answer the question. For the open number sentence, Wasu could read the questions but was unable to understand the questions, especially those with an equals sign. He showed misconceptions about the equals sign, explaining that it was as an operator meaning "the total". When he found a missing number of any open sentence, he carried out the operation with all given numbers such as $8 + 5 = \underline{\quad} + 8$ or $3 + 6 + 9 = 3 + \underline{\quad}$. He answered by counting all given numbers on the question. With question (1) $8 + 5 = \underline{\quad} + 8$, he gave 21 as the answer because he added 8 with 5 and 8. To answer question (2) $3 + 6 + 9 = 3 + \underline{\quad}$ he carried out the operation with 3, 6, 9 and 3. He was not concerned with the equals sign.

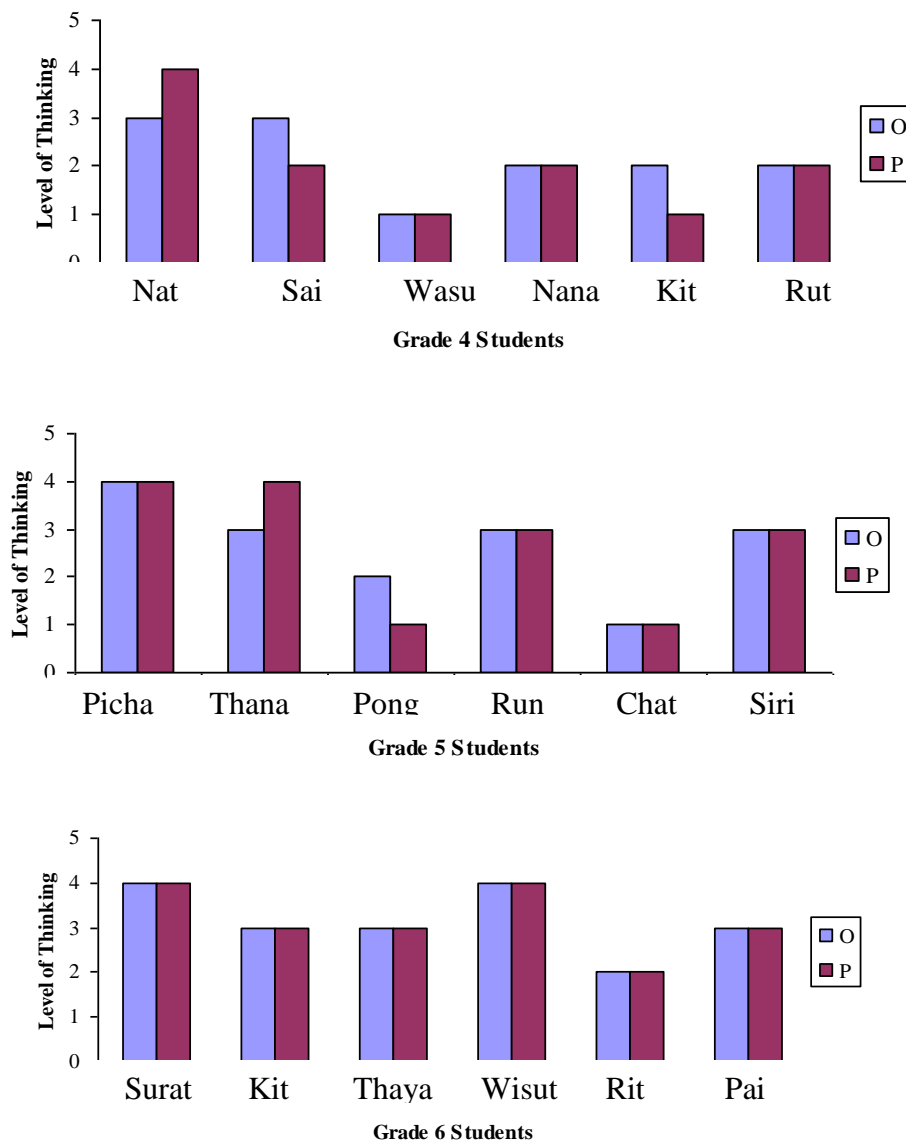

Figure 2. Profiles of Students' Levels of Algebraic Thinking.
(O = Open number sentence; P = Pattern)

Level 2 Thinking. Students with level 2 thinking demonstrated thinking beyond Level 1. They could engage with the tasks and understood the requirement of the tasks, but were not able to proceed further.

Rut, who was studying in 4th Grade, was selected to represent those with Level 1 algebraic thinking. With the *pattern* problems, Rut could find the next term by using a recursive idea. Nevertheless, he could not find the greater or general term of a given pattern. For the first pattern problem, Rut could find the number of black beads with five white beads by drawing the beads like the given pattern and then count the number of the black beads. He recognized that there was a growing pattern with two black beads. When asked to find the number of black beads with 30 white beads or with 100 white beads, a higher term, Rut used the same method to get the answer. This is a wrong answer because his picture was not clear so it was difficult to count the number of black beads. For the *open number sentence*, Rut confused the equals sign with an operator meaning “the

answer”. He found a missing number of an open sentence by computing the given number on the left side of equals sign with the reasonable conclusion that the right side of an open number sentence had only one number. He was not concerned with the given number on the right side of the equals sign.

Level 3 Thinking. Students with level 3 thinking demonstrated an ability to complete the tasks but were not able to link one aspect of the task to another.

Siri who was studying in 5th Grade was chosen to represent Level 3 algebraic thinkers. With the pattern problem, she could find the general relation between terms and position of a term in a giving pattern by using inductive reasoning. With an open number sentence, Siri showed correct understanding of the equals sign. She regarded the equals sign as a relationship between the numbers on each side of the equals sign. She could find the missing number of any open number sentences by using computation.

Level 4 Thinking. Level 4 students were able to see relationships between the given data and demonstrated a meta-cognitive understanding of the relationship among various aspects of data. They also used all aspects of data when solving the problems.

Wisut, who was studying in 6th Grade, was chosen to represent students who were at Level 4 across two components. With the pattern problem, he could prove the general relation between terms and position of a term in a given pattern. He could clearly interpret the meaning of the terms he used. With the open number sentence, he showed his thinking about the equals sign on open number sentence as the relational sign and used the relationship between the numbers on each side of the equal sign to find the missing number of any open sentences correctly which is called ‘relational’ thinking.

Discussion

The profile of students’ levels of algebraic thinking showed strong consistency across the two components. 72.22% of the sampled students demonstrated consistent thinking levels across the two components. The consistency of this framework compared favourably with the evidence in a number of other studies on cognitive frameworks (Jones, et al., 1997; Tarr & Jones, 1997; Mooney, 2002). This consistency confirms that the framework provided a cohesive picture of upper primary school students’ algebraic thinking.

In this study, a framework for characterizing lower secondary school students’ algebraic thinking was formulated and validated. It could be claimed that the validated framework reflected a coherent picture of students’ algebraic thinking offering insight into how algebraic learning of upper primary school students develops. While no claim has been made that the framework is applicable to all students, it provides the teachers with knowledge of students’ algebraic thinking that is applicable well beyond the classroom in which the study was conducted. As a result, this landscape of upper primary school students’ algebraic thinking can be used by curriculum developers and teachers to understand situations of instruction and assessment (Cobb, 2000; Fennema & Franke, 1992).

Acknowledgment

The study was supported by Commission on Higher Education and the Thailand Research Fund (TRF) under grant MRG5080431.

References

- Biggs, J. B., & Collis, K. F. (1982). *Evaluating the Quality of Learning: The SOLO Taxonomy (Structure of Observed Learning Outcomes)*. New York: Academic Press.
- Cobb, P. (2000). Conducting teaching experiments in collaboration with teachers. In Anthony E. Kelly and Richard A. Lesh (eds.), *Handbook of Research Design in Mathematics and Science Education* (pp. 307-334). Mahwah, NJ: Lawrence Erlbaum Associates.
- Fennema, E., & Franke, M. (1992). Teacher's knowledge and its impact. In Douglas A. Grouws (ed.), *Handbook of Research on Mathematics Teaching and Learning*, (pp. 147-164). New York: Macmillan.
- Jones, G.A., Langrall, C.W., Thornton, C.A., & Mogill, A.T. (1997). A framework for assessing and nurturing young children's thinking in probability. *Educational Studies in Mathematics*, 32, 101-125.
- Jones, G.A., Thornton, C.A., Langrall, C.W., Mooney, E.S., Perry, B. & Putt, I.J. (2000). A framework for characterizing children's statistical thinking. in *Mathematical Thinking and Learning*, 2(4), 269-307.
- Kieran, C. (2004). Algebraic thinking in the early grades: What is it? *The Mathematics Educator* (Singapore), 8(1), p. 139-151.
- Miles, M., & Huberman, A., (1994). *Qualitative Data Analysis*. Thousand Oaks, CA: Sage.
- Mooney, E. (2002). A framework for characterizing middle school students' statistical thinking. *Mathematical Thinking and Learning*. 4(1), 23-63.
- National Council of Teachers of Mathematics. (2000). *Principles and Standards for School Mathematics*. Reston, VA: Author.
- Russell, S. (1999). Mathematical Reasoning in the Elementary Grades. In L. V. Stiff and F. R. Curcio (eds.), *Developing Mathematical Reasoning in Grades K-12*, (pp.1-12), Reston, VA: National Council of Teachers of Mathematics.
- Tarr, J., & Jones, G. (1997). A framework for assessing middle school students' thinking in conditional probability and independence. *Mathematics Education Research Journal*, 9, 39-59.

Utilising Year Three NAPLAN Results to Improve Queensland Teachers' Mathematical Pedagogical Content Knowledge

Eduarda van Klinken

Clayfield College

evk@uq.net.au

Poor results in Queensland Year Three NAPLAN Numeracy tests have provided a focus to critically review the classroom practices of lower primary mathematics teachers. This paper outlines how pedagogical content knowledge can be strengthened by emphasising conceptual understanding, by utilising dynamic classroom discourse, by an awareness of bi-dimensional thinking and with an improved understanding of children's typical learning trajectories.

In 2008 the federal government, following international trends, oversaw the first nationally based testing programme in Australia's history. Queensland's poor results in the numeracy component caused considerable alarm, even more so when the resulting state government review highlighted a marked and real decline in numeracy achievement in Queensland since the 1970s (Masters, 2009). The report expressed concerns that teachers lacked *pedagogical content knowledge*; that is, knowledge about "how students understandings in a subject typically develop, how to engage students and sequence subject matter, the kinds of misconceptions that students commonly develop and the most effective ways to teach a subject" (p. 63).

It is the contention of this paper that deepening teachers' pedagogical content knowledge will improve students' mathematical skill development in the years leading up to the Year Three National Assessment Programme – Literacy and Numeracy (NAPLAN). To do this, teachers must utilise the work of various learning theorists, re-balance the emphasis on different aspects of knowledge, increase their awareness of issues related to bi-dimensional thinking and further develop their understanding of children's typical learning trajectories in key topics. Without this, Queensland teachers have the potential to suffer from "shallow teaching syndrome" (Vincent & Stacey, 2008, p. 82), characterised by a dependence on textbooks, low procedural complexity, a high degree of repetition and an absence of reasoning in classroom discussions.

This paper will firstly outline how three influential learning theories can provide a rich platform for teachers as they make day-to-day classroom decisions. The second half of the paper outlines the work of various researchers who have quantified children's typical learning trajectories in mathematical domains that were problematic in the Queensland Year 3 NAPLAN. This pedagogical knowledge assists teachers to critically observe the subtleties of children's responses and to make decisions about where to focus subsequent teaching.

Theories of Learning

When making decisions about how to teach mathematics, it is important that teachers have a deep understanding of how children learn, why some concepts are difficult and how to make teaching choices that will best facilitate students' pathways to mathematical success. Three learning theories will briefly be outlined because of their value in assisting in this task. Cognitive development theories (Siegler & Alibali, 2005) focus on typical developmental steps in children's cognitive development, information processing theories



(Hallahan, Kauffman, & Lloyd, 1996) explore how the brain learns, and socio-cultural theories (O'Shea, O'Shea, & Algozzine, 1998) have an interest in how social interactions shape children's learning.

Cognitive development theories are particularly pertinent to this paper because of the developmental changes that are thought to take place around the age of eight, the median age of Queensland Year Three children during NAPLAN testing. At this age, researchers have observed children as being increasingly able to consider other points of view by taking into account competing dimensions (Case, Okamoto, Griffin, McKeough, & Bleiker, 1996; Goswami, 2008). This bi-dimensional thought process is integral to mathematics: being required, for example, to integrate the value of the hour and minute hand on clocks, the value of tens and ones columns in two digit numbers, the dollars and cents when dealing with money and visualising three dimensional shapes from differing perspectives. These are areas in which many Queensland children performed poorly in the NAPLAN test. Critically, they are also foundational to later mathematical success in secondary school as well as giving opportunities to live independent lives.

The second group of theories, information processing theories, do not place the same emphasis on stages of development, but rather focus on the processes involved in human thinking. These theories are interested in how the brain responds to incoming information, the role of memory, automatised and strategies. They are of particular interest to mathematics teachers because efficient number fact retrieval from long term memory (Baroody, Bajawi, & Eiland, 2009), the flexible use of mathematical strategies (Geary, Hoard, Nugent, & Byrd-Craven, 2007) and an effective memory system are all linked to mathematical performance (Butterworth & Reigosa, 2007).

The role of working memory is of particular interest as it is known to be an important predictor of mathematical proficiency (Wilson & Dehaene, 2007). Swanson and Beebe-Frankenberger (2004) have demonstrated that working memory contributed about 30% to the variability between students' mathematical accuracy when problem solving. Working memory capacity increases with age but remains problematic for many students with learning difficulties. Therefore, there are important implications for teachers as they make decisions on how to teach concepts in an age-appropriate way and seek to understand why children may be having mathematical difficulty. Teachers must find ways of reducing working memory demands by the development of efficient strategies and the linking of new and old learning to promote long-term memory (McGowan, 2009).

Long-term memory, essential for mathematical performance, is facilitated by the development of schemas. Schemas are the connection in memory of similar ideas and are constructed by the individual after experiencing a number of similar situations (Marshall, 1995). Thinking schematically is a powerful tool in mathematical problem solving. Teaching students to think this way has had positive results in research projects with Year Three students, particularly with low-achieving students (Jitendra, Griffin, Deatline-Buchman, & Sczesniak, 2007). Students are taught to approach problems in a "top-down" approach, searching for patterns in structure before depicting these patterns in diagrams aimed at clarifying the dynamic mathematical nature of the problem. Students taught with a schema approach are able to make mathematical links more easily, become more flexible in their approach, improve their computational skills and maintain their skills over time (Griffin & Jitendra, 2008).

An important tool in making the most efficient use of our memory systems is by the use of effective strategies (Siegler & Alibali, 2005). For most children, strategies are constantly developing as they develop more efficient and reliable methods to solve new

problems. By contrast, students that struggle in mathematics rely on oversimplified and inefficient strategies that may be inappropriate to the task (Landeri, Bevan, & Butterworth, 2004). Teachers can facilitate strategy acquisition through classroom discourse that focuses on verbalising strategies, comparing them for efficiency and accuracy (Klein, Beishuizen, & Treffers, 2002). Repetition and revision are important in consolidating strategies and improving their fluency.

The third group of theories, socio-cultural theories, focus on the learning that comes from interaction in society. The theories emphasise the way social discourse, in the form of language and symbols, acts as a means for people to share their ideas, thereby generating new learning. Familiarity with these theories is critical for classroom teachers because of the protracted time students spend interacting with their peers and teachers, either formally or informally. Effective classroom discourse develops conceptual understanding (Kazemi, 2002), improves students' memory for what they have learned (Coffman, Ornstein, McCall, & Curran, 2008), assists in developing a shared understanding of mathematical symbols (Munn, 1998) and is a bridge between concrete and abstract thought (Hopkins, Giffird, & Pepperell, 1999).

Unfortunately, because mathematics is considered to be a subject concerned with symbols, the language of mathematics is not always recognised as important and the particular characteristics of the genre is rarely touched upon in the classroom. Yet an emphasis on teaching the language of mathematics has been shown to be a pivotal point in children's understanding of mathematical tasks (Kenney, 2007). A central argument of Hipwell (2009) is that if teachers are testing mathematical literacies, they need to be planned for and taught.

Teachers need to be aware of complicating factors that are unique to mathematical texts. These include the lack of cue words, the density of the writing, the critical role of small words in giving precise meaning and mathematically specific vocabulary. Texts become more difficult when in the passive voice, when sentence length increases or becomes more complex, when the order of events does not match the order of the required mathematical procedure or when sentences contains negatives that tax young children's developing memory systems (Boaler, 2002; Remillard, 2005).

Mathematical learning is complex and based on the interplay between many skills. This is reflected in the draft of the Australian Curriculum (Australian Curriculum Assessment and Reporting Authority, 2010) which has proposed four strands of mathematical proficiency — conceptual understanding, procedural fluency, problem solving and adaptive reasoning. It is known that the incompatibility between these types of knowledge can lead to systematic mistakes and misconceptions (Westwood, 2000). Teaching procedural fluency in isolation is unlikely to meet with success. Studies where conceptual knowledge has been emphasised above procedural knowledge have found that students with strong conceptual understanding demonstrate knowledge that is more long-lasting and thorough, have greater flexibility in their use of strategies, are more efficient in learning and are more successful in problem solving situations. (Canobi, Reece, & Pattison, 2003).

The development of conceptual understanding is however time consuming. Time constraints on teachers and a desire to reduce the complexity of the task often results in them specifying a procedure, particularly for weaker students (Chan & Dally, 2001). Unfortunately, without conceptual understanding, a student is unlikely to generalise these procedures to similar problems, resulting in them having to learn new procedures for every situation or to unsuccessfully apply one procedure to a related exercise. It is essential then that Queensland teachers have the expertise to spot the “wise point of entry that can move

the student to more sophisticated and mathematically grounded understanding” (Walshaw & Anthony, 2008, p. 32).

Using NAPLAN Results to Improve Teacher Pedagogy

An overview of the Queensland NAPLAN results shows weaknesses in some key areas. Some of the difficulties have already been touched upon in this paper — the language demands of some questions are problematic, students may have a mismatch between procedural and conceptual knowledge and the requirement to process two things simultaneously may cause difficulties for others. There are, however, a few subject-specific concepts that have proven challenging for Queensland Year Three students; namely place value, time, money and geometry. These topics will be discussed in more detail with the aim of outlining what researchers believe may be causing the difficulty as well as providing a necessarily brief overview of learning principles and trajectories that can assist teachers in pacing the development of new skills.

Number Sense

The development of place-value concepts is closely linked to a general “feel for numbers” or *number sense*. Number sense is the confident, reliable and efficient grasp of number concepts as well as the ability to flexibly adjust and invent procedures to suit a given mathematical problem (Wilson & Dehaene, 2007). Queensland teachers in the lower primary years need to develop number sense skills in their students by teaching such subset skills as subitising, fluent forward and backward counting patterns, partitioning of numbers, adding and subtracting strategies, comparison of numbers, estimation and the development of a secure internal number line (Anghileri, 2006; Wright, Stanger, Stafford, & Martland, 2006).

Much can be learned about the development of number sense, and in particular the development of mental strategies, by analysing the core ingredients of the Realistic Mathematics Project in the Netherlands (van den Heuvel-Panhuizen, 2008). This project places emphasis on the critical skills that have been highlighted earlier in the paper; teachers understanding of children’s typical developmental pathways, the importance of discourse, the use of realistic problems as well as the careful development of conceptual understanding. Mental arithmetic and the development of an internal number line are seen as foundational for developing computation and problem solving strategies. Students are encouraged to develop informal strategies that are used as a starting point for classroom discussion; however, there is also an emphasis on students’ learning, recognising and naming commonly used strategies. This gives students a shared language to use with their peers when explaining and justifying their responses. The teacher, with the advantage of specialised training, is able to listen to students’ responses, ascertain the degree of sophistication and move to present appropriate follow-up activities.

Time

Questions relating to time rated poorly on Queensland NAPLAN results. This is not surprising as the reading of clocks is one of the most complex of the major symbol systems that confront children, requiring the manipulation of multiple processes (Meewissen, Roelefs, & Levelt, 2004). It is also an essential life-skill, giving all the more urgency for strong foundational skills. Burny, Valcke and Desoete (2009) have listed the skills for reading a clock as including number sense, operations, fractions, geometry, vocabulary,

linguistics, visuo-spatial, visual imagery as well as an understanding of arbitrary rules or conventions. Teachers instinctively know what Piaget (cited in Smith, 2009) also found, that the concept of time takes years to develop.

Two distinct parameters of time must be connected in the mind of the child for real conceptual understanding to occur. Firstly there is the concept of *experiential time* (e.g., while an hour may take a long time when one is hungry, it is a short time when one is asleep). Experiential time cannot be “played with” or manipulated in teaching situations, but must be experienced. This is in contrast to *logical time*, which can be induced entirely through reasoning (e.g., if one leaves home at 10.00am, an hour’s trip will mean arrival at 11.00am). The complete integration of these two parameters is the aim of classroom tuition (Burny et al., 2009).

Friedman and Laycock (1989) described two distinct developmental levels of clock knowledge that are required before this integration can occur. Teachers must be aware of which level individual students have achieved so that they can provide activities commensurate with their developmental understanding. The most basic level is the ability to look at a digital or analogue clock and read the time. As was discussed earlier, this requires the ability for bi-dimensional thought — simultaneously calculating the movement of the slower moving hour hand and the faster moving minute hand. The second of Friedman and Laycock’s levels is the more difficult task of extracting relationships between times by, for example, comparing times or transforming times by adding or subtracting minutes or hours. These tasks require multiple skills and were particularly difficult for Queensland students.

Further confusing the issue are the literacy issues related to time. A quarter to four, 3.45 and fifteen minutes to 4, bear little resemblance to each other. Moreover, children’s experience of quarters or halves is often related to shape or a number of objects, rather than the precise moment when a moving minute hand crosses a certain point in its cycle (Brizuela, 2005). If Queensland teachers were aware of the specific problems associated with time, they may not approach the teaching of time in the traditional curriculum sense. Instead they may choose to relate time frequently to real life scenarios to develop the idea of experiential time; and remove either the minute or hour hand altogether to reduce working memory demands until students have a secure sense of the varying roles of the clock hands (McMillen & Hernandez, 2008).

Money

Money related problems on the NAPLAN show that while Queensland students were mostly successful in totalling a number of coins, problems that required further mental steps were more problematic. In this topic, the themes of this paper can usefully be applied by teachers: the use of realistic problems and real coins, the developmental of conceptual understanding, a schematic approach to money problems and a focus on number sense, particularly place value.

In one of the few research projects into the development of money skills, Case et al. (1996) have proposed four stages of development, each increasing in complexity. Stage one relates to problems with large and readily apparent differences (e.g., Which is worth more, dollars or cents?). Stage two requires some sort of numerical focus, but only one type of skill is required for its solution (e.g., How much is 50c and 25c?). Stage three requires bi-dimensional thought, when students might compare quantities along two scales such as dollars and cents (e.g., Which is more, \$8.10 or \$2.85?). The final stage requires integrated bi-dimensional thought. Students not only focus on the two different scales,

dollars and cents, but must also perform some sort of operation on the amounts (e.g. If three apples cost \$2, how many apples could you buy for \$10?) These final two stages were tested on a number of questions on the NAPLAN and were amongst the most poorly completed on the test. To improve students' understanding, teachers must be aware of the increasing difficulties provided by various complicating factors in money problems and provide teaching that is in keeping with the current conceptual understanding of the individual student.

Geometry

The final topic covered in this paper is geometry. For most questions relating to geometry in the 2008 NAPLAN, Queensland students achieved less than 50% accuracy, making it a key area of concern for teachers. A leading cause is that teachers themselves have a limited understanding of geometry. They misunderstand important geometric definitions and utilise limited and rigid examples when teaching geometric shapes (Clements, 2004). As it is not possible for students to successfully utilise the deductive thinking that is necessary in their secondary school years if prerequisite geometric foundations are not firmly established, it is imperative that primary school teachers further develop their geometric content knowledge in this area.

Geometry, or spatial thinking, is made up of two main skill-sets — spatial orientation and spatial visualization. *Spatial orientation* is the ability to know where an object is in space and its relationship to the position of other objects (such as in mapping). *Spatial visualisation* is the ability to form a mental picture about 2D and 3D shapes as well as the ability to manipulate them by mentally turning them in some way. It is the area of spatial visualisation that proved particularly difficult for Queensland Year Three students and requires increased teacher focus.

The aim for lower primary teachers is to have students consciously, analytically and verbally classify shapes by referring specifically to properties of shapes, such as the number of sides or angles. By teachers providing the widest possible number of examples, students should gradually progress from classifying shapes by their similarity to other shapes, to a more abstract and sophisticated understanding of their properties. These skills may be developed through drawing, measuring, model making and computer programmes that make motion accessible and dynamic (Clements & Sarama, 2007; van Hiele, 1999).

Kosslyn (1983) identified four processes children need to develop when developing expertise in visual images of shapes. These processes can be developed simultaneously in the classroom. The first process is the ability to generate an image through drawing or to identify an image from a picture or object. Secondly is the ability to refer to the specific properties of a given shape. The third process is to maintain a sense of the image when it is moved into another environment (for example, deciding whether the book in your hand will fit onto a bookshelf). The last of the processes is the ability to transform or operate on an image. Clements (2004) found that the easiest of these transformations is to slide an object; more difficult is flipping and the most complex is rotating an object in some way.

Conclusion

The need for teachers to improve their mathematical pedagogical content knowledge was highlighted by the poor NAPLAN performance of Queensland students (Masters, 2009). This paper has outlined the role learning theories and associated mathematical research can play in giving practical guidance to classroom teachers. These include an

understanding of typical learning trajectories, difficulties associated with bi-dimensional thinking, the need for balance between conceptual and procedural understanding, issues surrounding memory acquisition, the literacy demands of mathematics as well as the importance of classroom discourse in deepening students' thinking.

The challenges for teachers are enormous. Mathematics in the lower primary school covers many topics that need to be squashed into a limited amount of time. A strong pedagogical understanding allows teachers to meet students at their point of conceptual understanding and to move them purposefully forwards. To improve NAPLAN results and, more importantly, to improve children's mathematical proficiency, Queensland teachers must be given the opportunity to develop this expertise through increased access to high quality professional development and the opportunity to critically reflect on their classroom practices.

References

- Anghileri, J. (2006). *Teaching number sense*. London; New York: Continuum.
- Australian Curriculum Assessment and Reporting Authority. (2010). *Draft Australian Curriculum*. Retrieved March 6, 2010. from www.acara.edu.au.
- Baroody, A. J., Bajawi, N., Prija, & Eiland, M. (2009). Why can't Johnny remember the basic facts? *Developmental Disabilities Research Reviews, 15*, 69-79.
- Boaler, J. (2002). Open and closed mathematics: Student experiences and understandings. In J. Sowder & B. Schappelle (Eds.), *Lessons learned from research* (pp. 135-142). Reston, VA: National Council of Teachers of Mathematics.
- Brizuela, B. M. (2005). Young children's notations for fractions. *Educational Studies in Mathematics, 62*, 281-305.
- Burny, E., Valcke, M., & Desoete, A. (2009). Towards an agenda for studying learning and instruction focusing on time-related competencies in children. *Educational Studies, 35*(5), 481-492.
- Butterworth, B., & Reigosa, V. (2007). Information processing deficits in dyscalculia. In D. B. Berch & M. Mazzocco, (Eds.), *Why is math so hard for some children?: The nature and origins of mathematical learning difficulties and disabilities* (pp. 65-82). Baltimore, Md: Paul Brookes Pub. Co.
- Canobi, K. H., Reece, R. A., & Pattison, P. E. (2003). Patterns of knowledge in children's addition. *Developmental Psychology, 39*(3), 521-534.
- Case, R., Okamoto, Y., Griffin, S., McKeough, A., & Bleiker, C. (1996). Exploring the macrostructure of children's central conceptual structures in the domains of number and narrative *Monographs of the Society for Research in Child Development, 61*(1/2), 59-82.
- Chan, L., & Dally, K. (2001). Learning disabilities and literacy and numeracy development. *Australian Journal of Learning Disabilities, 6*(1), 12-19.
- Clements, D. H. (2004). Geometric and spatial thinking in early childhood education. In D. H. Clements & J. Sarama (Eds.), *Engaging young children in mathematics* (pp. 267-298). Mahwah: Lawrence Erlbaum Associates.
- Clements, D. H., & Sarama, J. (2007). Early childhood mathematics learning. In F. K. J. Lester (Ed.), *Second handbook of research on mathematics teaching and learning* (pp. 3-26). Charlotte, NC: Information Age Publishing Inc.
- Coffman, J. L., Ornstein, P. A., McCall, L. E., & Curran, P. J. (2008). Linking teachers' memory-relevant language and the development of children's memory skills. *Developmental Psychology, 44*(6), 1640-1654.
- Friedman, W. J., & Laycock, F. (1989). Children's analog and digital clock knowledge. *Child Development, 60*, 357-371.
- Geary, D., Hoard, M. K., Nugent, L., & Byrd-Craven, J. (2007). Strategy use, long-term memory, and working memory capacity. In D. Berch, B & M. Mazzocco, (Eds.), *Why is math so hard for some children?: The nature and origins of mathematical learning difficulties and disabilities* (pp. 83-106). Baltimore, Md: Paul H. Brookes Pub. Co.
- Goswami, U. (2008). *Cognitive development: The learning brain*. Hove, East Sussex: Psychology Press.
- Griffin, C. C., & Jitendra, A. K. (2008). Word problem-solving instruction in inclusive third-grade mathematics classrooms. *Journal of Educational Research, 102*(3), 187-201.

- Hallahan, D. P., Kauffman, J. M., & Lloyd, ? (1996). *Introduction to learning disabilities* (2nd ed.). Boston: Allyn and Bacon.
- Hipwell, P. (2009). *Towards a whole school approach to literacy teaching: Practical professional development for teachers of literacy at Clayfield College*. Paper presented at the School Literacies Professional Development, Clayfield College, Australia.
- Hopkins, C., Giffird, S., & Pepperell, S. (1999). *Mathematics in the primary school* (2nd ed.). London: David Fulton Publishers.
- Jitendra, A. K., Griffin, C. C., Deatline-Buchman, A., & Sczesniak, E. (2007). Mathematical word problem solving in third-grade classrooms. *Journal of Educational Research, 100*(5), 283-302.
- Kazemi, E. (2002). Discourse that promotes conceptual understanding. In D. L. Chambers (Ed.), *Putting research into practice* (pp. 21-24). Reston, VA: National Council of Teachers of Mathematics.
- Kenney, J. M. (2007). Mathematics as language. In J. M. Kenney (Ed.), *Literacy strategies for improving mathematics instruction*. Alexandria: Hawker Brownlow Education.
- Klein, A. S., Beishuizen, M., & Treffers, A. (2002). The empty number line in Dutch second grade. In *Lessons learned from research* (pp. 41-44). Reston, VA: National council of teachers of mathematics.
- Kosslyn, S. M. (1983). *Ghosts in the mind's machine: Creating and using images in the brain*. New York: W.W. Norton.
- Landeri, K., Bevan, A., & Butterworth, B. (2004). Developmental dyscalculia and basic numerical capacities: A study of 8-9 year old students. *Cognition, 93*(2), 99-125.
- Marshall, S. P. (1995). *Schemas in problem solving*. Cambridge: Cambridge University Press.
- Masters, G. (2009). *A shared challenge: Improving literacy, numeracy and science learning in Queensland primary schools*. Retrieved from <http://education.qld.gov.au/mastersreview/pdfs/final-report-masters.pdf>.
- McGowan, J. (2009). *Working memory*. Brisbane: SPELD.
- McMillen, S., & Hernandez, B. (2008). Taking time to understand time. *Teaching Children Mathematics, 15*(4), 248-262.
- Meewissen, M., Roelefs, A., & Levelt, W. J. M. (2004). Naming analog clocks conceptually facilitates naming digital clocks. *Brain and Language, 90*, 434-440.
- Munn, P. (1998). Symbolic functions in pre-schoolers. In C. Donlan (Ed.), *The development of mathematical skills* (pp. 27 - 46). Hove, East Sussex: Psychology Press.
- O'Shea, J. L., O'Shea, J. D., & Algozzine, B. (1998). *Learning disabilities: From theory toward practice*. Upper Saddle River: N.J. : Merrill.
- Remillard, J. (2005). Examining key concepts in research on teacher's use of mathematics curricula. *Review of Educational Research, 75*(2), 211-246.
- Siegler, R. S., & Alibali, M. W. (2005). *Children's thinking* (4th ed.). Upper Saddle River: Prentice Hall.
- Smith, S. S. (2009). *Early childhood mathematics* (4th ed.). Boston: Pearson.
- Swanson, H. L., & Beebe-Frankenberger, M. (2004). The relationship between working memory and mathematical problem solving in children at risk and not at risk for serious math difficulties. *Journal of Educational Psychology, 96*(3), 471-491.
- van den Heuvel-Panhuizen, M. (2008). *Children learn mathematics: A learning-teaching trajectory with intermediate attainment targets for calculation with whole numbers in primary school*. Rotterdam: Sense Publishers.
- van Hiele, P. M. (1999). Developing geometric thinking through activities that begin with play. *Teaching Children Mathematics, 5*(6), 310-325.
- Vincent, J., & Stacey, K. (2008). Do mathematics textbooks cultivate shallow teaching? Applying the TIMSS video study criteria to Australian eighth-grade mathematics textbooks. *Mathematics Education Research Journal, 20*(1), 81-106.
- Walshaw, M., & Anthony, G. (2008). The teacher's role in classroom discourse: A review of recent research into mathematics classrooms. *Review of Educational Research, 78*(3), 516-549.
- Westwood, P. (2000). *Numeracy and learning difficulties: Approaches to teaching and assessment*. Camberwell: David Fulton Publishers.
- Wilson, A. J., & Dehaene, S. (2007). Number sense and developmental dyscalculia. In D. Coch, G. Dawson & K. W. Fischer (Eds.), *Human behaviour, learning, and the developing brain*. New York The Guildford Press.
- Wright, R. J., Stanger, G., Stafford, A. K., & Martland, J. (2006). *Teaching number in the classroom with 4 - 8 year olds*. London: Paul Chapman Publishing.

Learning Mathematical Concepts Through Authentic Learning

Koh Noi Keng

Nanyang Technological University, Singapore
<noikeng.koh@nie.edu.sg>

Low Hwee Kian

Ministry of Education, Singapore
<low_hwee_kian@moe.edu.sg>

This paper explores the infusion of financial literacy into the Mathematics curriculum in a secondary school in Singapore. By infusing financial literacy, a core theme in the 21st century framework, into mathematics education, this study investigated the impact of using financial literacy-rich mathematics lessons by using validated learning environment instruments. This study is part of a larger study to design, monitor, and evaluate an innovative pedagogical approach of using authentic financial literacy examples to reposition mathematics education in schools.

The authentic teaching of mathematics that explicitly connects mathematical concepts, skills, and strategies to purposeful, relevant, and meaningful contexts, therefore promoting a deeper level of understanding in the classroom, is not a new concept. This has been espoused by various national and international organisations and standards, such as the National Council of Teachers of Mathematics (2000) that highlights the aim towards standards that promote understanding and use of mathematics in everyday life and in the workplace. The Programme for International Student Assessment (PISA) mathematics literacy test assessed students' abilities to apply their mathematical content knowledge and skills to a broad range of real-world problems (OECD, 2007). Meanwhile, one of the cognitive domains for the Trends in International Mathematics and Science Study (TIMSS) comprises reasoning skills to solve mathematical problems set in real life contexts (National Center for Educational Statistics, 2009).

Rationale

The report released by the National Mathematics Advisory Panel (2008) advocated the use of real-world contexts to introduce mathematical ideas. The study discussed preliminary conclusions that for certain populations and for specific domains of mathematics such as fractions, basic equations, and functions, lesson instruction featuring real-world contexts has had positive impact on certain types of problem solving. Another area proposed for authentic mathematics teaching is in financial literacy (FL), which is a core theme of the 21st Century Skills framework (Partnership for 21st Century Skills, 2009). Core concepts of FL such as budgeting, saving, spending, and investing are closely linked with basic mathematical skills as the foundation (Dworsky, 2009; Lipsman, 2004; Lutz, 1999; Roy Morgan Research, 2003; Worthington, 2006). This has, for example, been recognised and developed by the U.S. Department of the Treasury together with the Midwestern University into the "Money Math: Lessons for Life" curriculum. The curriculum, which uses real-world personal financial scenarios to teach mathematical concepts and basic finance to students, is explicitly correlated with the knowledge and skills set forth by the National Council of Teachers of Mathematics (NCTM). (Financial Literacy and Education Commission, 2006)

The importance and relevance of youth FL is becoming ever more critical as both the spending potential and access of young people increases with the increase of affluence in society, such as among Singaporean youth. Fox, Bartholomae, and Lee (2005) noted the importance of one's understanding and knowledge of financial concepts in effective



consumer financial decision making. Most spending and saving habits are developed at an early age and good financial education, beginning even as early as kindergarten, is still seen as the best way to develop this important life skill (Mandell, 2007). According to studies by the National Endowment for Financial Education (NEFE), the most effective financial education comes at critical teachable moments in a person's life (Beck & Neiser, 2009), which occur when a person is motivated by a life circumstance or decision-making event. Understanding this, our study explores the authentic infusion of FL into the Mathematics curriculum of a secondary school in Singapore at the stage of the students' lives when managing personal finance is growing in importance.

Methodology

Authentic learning of mathematics through real-world concepts related to FL was carried out with a group of students from middle-class families in a secondary school in Singapore over a series of six one-hour lessons. Real-world examples related to taxation, foreign exchange, hire purchase, profit and loss, interest rates, and utility bills were introduced as scenarios for discussion and problem-solving of the mathematics questions. These were infused into the lessons with the teacher still covering the standard syllabus content. The effectiveness of the authentic learning of mathematics in the financial literacy-rich mathematics (FLM) classroom environment was investigated. Quantitative research methods using validated learning environment and FL instruments were used to investigate students' perceptions of the classroom learning environment and FL. Focus group discussions provided the qualitative data to illuminate and triangulate the quantitative findings.

Quantitative Data-Collection Instrument

School students' perceptions of their classroom environments were assessed using the Constructivist Learning Environment Survey (CLES) (Taylor, Dawson, & Fraser, 1995; Taylor, Fraser, & Fisher, 1997), which assesses Personal Relevance, Uncertainty, Critical Voice, Shared Control, and Student Negotiation. The CLES was selected because of its ability to characterise specific dimensions of the constructivist learning environment and thus measure students' perceptions of the perceived (actual) and preferred forms of the learning environment and the extent to which these constructivist approaches are present in classrooms, as created by the teachers. The modified version of the CLES has five scales and for the current study, such scales are reflective of the interest in a pedagogy that makes use of students' everyday experiences as a meaningful context for the development of their mathematical content knowledge, skills, and values. The CLES incorporates a critical theory perspective on the socio-cultural framework of the classroom learning environment (Grundy, 1987; Habermas, 1972, 1984) as the students were engaged in mathematical reasoning of the FL issues when applying what they have learnt.

The Cronbach's alpha coefficients for the CLES from past research in various countries are tabulated in Table 1.

Table 1
Internal Consistency (Cronbach's Alpha Coefficient) for CLES in Past Research

Scale	Alpha Reliability Coefficient				
	Taiwan ^a	Australia ^a	Korea ^b	South Africa ^c	USA ^d
Personal Relevance	0.87	0.88	0.78	0.61	0.75
Uncertainty	0.83	0.76	0.79	0.60	0.74
Critical Voice	0.73	0.85	0.80	–	0.77
Shared Control	0.92	0.91	0.87	0.63	0.84
Student Negotiation	0.85	0.89	0.84	0.63	0.85

Note. ^a Aldridge, Fraser, Taylor, & Chen (2000); ^b Lee & Fraser (2001); ^c Aldridge, Fraser, & Sebela (2004) (this study used 4 CLES scales only); ^d Nix, Fraser, & Ledbetter (2005).

Sample

The study involved a purposeful sampling (Merriam, 1998) comprising willing and chosen participants from selected classes of secondary four level students.

- 57 students from 2 classes make up the experiment group, where the classes were taught using FLM lessons.
- A control group of 39 students from 2 classes in the same school and level were taught in the same period using the conventional, whole class instruction for mathematics lessons.

Research Questions

The research questions for this study are as follows:

1. Are students receiving FL-rich mathematics lessons showing a more positive attitude and perception towards their mathematics classroom learning environment as compared to students receiving traditional mathematics only instructions?
2. Are students receiving FL-rich mathematics lessons outperforming students receiving traditional mathematics only instructions in FL scores?

Results

Quantitative results

All students responded to the CLES questionnaire post-intervention. Students also answered a FL questionnaire designed to measure their attitude toward FL and toward the FL Programme. Quantitative analyses of the results are shown in Table 2 and Table 3.

Table 2

CLES questionnaire: Cronbach's Alpha, Mean, Standard Deviation, and T Values of Students' Perception toward Their Actual Course Learning Environment (N=96)

Scale	Number of Items	Cronbach's Alpha		Group 1 (N=57)		Group 2 (N=39)		T value
		Actual	Preferred	Mean	SD	Mean	SD	
Personal Relevance	4	0.73	0.71	3.71	0.67	3.73	0.64	-0.18
Uncertainty	4	0.71	0.73	3.88	0.83	3.87	0.69	0.02
Critical Voice	4	0.83	0.77	3.45	1.05	3.80	0.86	-1.78
Shared Control	4	0.83	0.89	3.14	1.13	3.66	0.79	-2.48*
Student Negotiation	4	0.85	0.84	3.30	0.96	3.60	0.73	-1.76

Note. Group 1 = Experiment group. Group 2 = Control group. From Table 2, the CLES questionnaire is a robust instrument as it has reliability Cronbach's alpha ranking from 0.71 to 0.89. *Significant at $p=0.05$ level.

Table 3

Attitudes towards Maths, FL and FL Programme: Cronbach's Alpha, Mean, Standard Deviation, and T Values of Students' Perception (N=96)

Scale	Number of Items	Cronbach's Alpha	Group 1 (N=57)		Group 2 (N=39)		T value
			Mean	SD	Mean	SD	
Attitude Towards Maths	8	0.92	3.88	0.74	4.00	0.75	-0.79
Attitude Towards FL	12	0.64	4.15	0.32	3.96	0.53	0.66
Attitude Towards FL Programme	12	0.86	3.55	0.66	3.54	0.66	2.02*

Note. Group 1 = Experiment group. Group 2 = Control group. The Attitude towards FL and FL programme questionnaires and Math test scores show adequate reliability (Cronbach's alpha ranked from 0.64 to 0.92). *Significant at $p=0.05$ level.

From Table 2, there was no significant difference between both groups' perception of their classroom learning environment as indicated by the T values for all scales, except on Shared Control. Students in the experiment group have less favourable view on Shared control as compared to their counterparts in the control group. From Table 3, comparison between the two groups' perception indicated that the experiment group students had a lower score on their attitudes towards mathematics. However, this difference was not statistically significant. The difference between the experiment and control groups could be attributed to the fact that the experiment group comprised an academically lower ability group based on streaming of the previous years' school examination results.

On the other hand, the students in the experiment group have more positive views towards FL and FL Programme as compared to the control group students who are of the higher-ability group. More importantly, the difference is statistically significant on the

Attitude toward FL Programme scale. Hence, we can assert that the FL programme may have positive impact on students' attitude.

Qualitative results

Pre- and post- intervention focus group discussions were conducted with 10 selected students from the experiment group in 2 separate groups of 5 students each.

At the stage of the pre-intervention focus group discussion, the students had already been informed by the teacher that FL concepts were to be introduced into their lessons, and they were looking forward to them. Generally, the students already showed a good interest in and enjoyed learning Mathematics. The students also demonstrated awareness of their classroom learning environment by being able to provide practical suggestions of how the lessons could be made more exciting and relevant, such as through the use of technology, group work, games, or project work. A greater interest in the subject was equated with better grades. Acknowledging therefore the importance of application to reinforce knowledge and understanding of the concepts, the students were supportive of the idea for introduction of real-world examples in their classroom as they believed that this would also make the lessons more interesting.

Before the FLM intervention, the students only had a vague understanding of FL as “something about finance” or “something related to the economy”. FL was seen as important for “some people” or for the “needy people”. Many of the students believed that FL should be a separate topic to be learnt and not to be infused into the existing mathematics lessons as this might make the learning and especially preparation for the upcoming national level examinations more stressful with the additional content. The relationship between mathematics and FL did not seem clear to some students. While some could not as yet see opportunities for application of the concepts in their student life, they nevertheless agreed that these were useful.

After the FLM intervention, the students demonstrated an increased awareness of financial literacy, being able to give more descriptive explanations of their understanding.

S1: Initially, financial literacy to me is just about saving money, but I think now, financial literacy is about planning your budget and knowing the difference between a need and a want.

S2: Financial literacy is about how you save your money and how you use and manage your money. It is also about how to look at profits, losses, and cost prices.

In general, they did not face much difficulty in understanding the content of the FLM lessons. Interestingly, the infusion of FL concepts was done so subtly that some students did not even perceive any difference in the mathematics content being taught as it was still according to the textbook syllabus, albeit using real-world examples related to finances as the scenarios for problem-solving. Both a present and future awareness of the utilisation of the mathematics and FL concepts learnt were evidenced during the discussion.

S3: I have learnt how to calculate bills and how to reduce bills so that we can save money.

S4: I know money will grow when I put it in the bank due to compound interest.

S5: I learnt how to see your profits and losses like when you make an investment, you must know when to withdraw your money.

The students demonstrated their FL budgeting skills when given two separate planning scenarios during the focus group discussion. Some even made reference back to their classroom learning, for example, applying what they had learnt in their lessons about

utility bills in planning their household budget, and about comparison of prices and discounts in their use of the class budget to buy gift items.

Summary

This study is part of a larger study to design, monitor, and evaluate an innovative pedagogical approach of using authentic examples to reposition mathematics education in schools. From this study, it is clearly evident that students receiving FLM lessons outperformed participants receiving “traditional mathematics only” instructions in their attitude towards FL, showing both a higher FL score and also demonstrating knowledge and application of FL concepts in their daily-life. Therefore, teachers may want to rethink the way mathematics lessons are taught and replicate this study to evaluate the success of using day-to-day real-life FLM intervention in Mathematics lessons.

References

- Aldridge, J. M., Fraser, B. J., Taylor, P. C., & Chen, C. (2000). Constructivist learning environments in a cross-national study in Taiwan and Australia. *International Journal of Science Education*, 22, 37-55.
- Aldridge, J. M., Fraser, B. J., & Sebela, M. P. (2004). Using teacher action research to promote constructivist learning environments in South Africa. *South African Journal of Education*, 24, 245-253.
- Beck, T., & Neiser, B. (2009). Learning and growing: Lessons learned in financial education. *Community Investments*(Sum), 11-14.
- Dworsky, L. N. (2009). *Understanding the mathematics of personal finance: An introduction to financial literacy*. Hoboken, NJ: John Wiley & Sons, Inc.
- Financial Literacy and Education Commission. (2006). *Taking ownership of the future: The National Strategy for Financial Literacy, 2006*. Retrieved 1 March 2010 from: <http://www.mymoney.gov/pdfs/ownership.pdf>
- Fox, J., Bartholomae, S., & Lee, J. (2005). Building the case for financial education. *The Journal of Consumer Affairs*, 39(1), 195-214.
- Grundy, S. (1987). *Curriculum: Product or praxis*. The Falmer Press: New York.
- Habermas, J. (Ed.). (1972). *Knowledge and human interests* (2nd ed.). London: Heinemann.
- Habermas, J. (Ed.). (1984). *A theory of communicative action: Vol 1*. Boston, MA: Beacon Press.
- Lee, S., & Fraser, B. J. (2001). *High school science classroom learning environments in Korea*. Paper presented at the annual meeting of the National Association for Research in Science Teaching, New York, NY.
- Lipsman, R. L. (2004). *You can do the math: Overcome your math phobia and make better financial decisions*. Westport, CT: Praeger.
- Lutz, D. E. (1999). *The mathematics of personal finance*. Bloomington, IN: IUiverse.
- Mandell, L. (2007). Four keys to a model youth program. *National Credit Union Youth Week. April 22-28, 2007*. Retrieved 1 March 2010 from: http://www.cuna.org/download/svgtn07_d.pdf
- Merriam, S. B. (1998). *Qualitative research and case study applications in education* (Rev. ed.). San Francisco, CA: Jossey-Bass.
- National Center for Educational Statistics. (2009). *Highlights from TIMSS 2007: Mathematics and science achievement of U.S. Fourth and Eighth-Grade students in an international context*. Retrieved 1 March 2010 from: <http://nces.ed.gov/pubs2009/2009001.pdf>
- National Council of Teachers of Mathematics. (2000). *Principles and standards for school mathematics*. Reston, VA: Author.
- National Mathematics Advisory Panel. (2008). *Foundations for success: The final report of the National Mathematics Advisory Panel*. Retrieved 1 March 2010 from: <http://www.ed.gov/about/bdscomm/list/mathpanel/report/final-report.pdf>
- Nix, R. K., Fraser, B. J., & Ledbetter, C. E. (2005). Evaluating an integrated science learning environment using the constructivist learning environment survey. *Learning Environments Research*, 8, 109-133.
- OECD. (2007). *PISA 2006: Science competencies for tomorrow's world. Volume 1: Analysis*. Retrieved 1 March 2010 from: <http://www.pisa.oecd.org/dataoecd/30/17/39703267.pdf>
- Partnership for 21st Century Skills. (2009). *P21 Framework definitions document*. Retrieved 1 March 2010 from http://www.21stcenturyskills.org/documents/p21_framework_definitions_052909.pdf

- Roy Morgan Research. (2003). *ANZ survey of adult financial literacy in Australia: Final report*. Melbourne: ANZ Bank.
- Taylor, P. C., Dawson, V., & Fraser, B. J. (1995). *Classroom learning environments under transformation: A constructivist perspective*. Paper presented at the annual meeting of the American Educational Research Association, San Francisco, CA.
- Taylor, P. C., Fraser, B. J., & Fisher, D. L. (1997). Monitoring constructivist classroom learning environments. *International Journal of Educational Research*, 27, 293-302.
- Worthington, A. C. (2006). Predicting financial literacy in Australia. *Financial Services Review*, 15(1), 59-79.

A Teacher Pair Approach to Adopting Effective Numeracy Teaching Practice

Janeen Lamb

Australian Catholic University
<janeen.lamb@acu.edu.au>

Vince Geiger

Australian Catholic University
<vincent.geiger@acu.edu.au>

While the notion of numeracy as the capacity to make use of mathematics within contexts associated with personal and public life, as distinct from basic mathematical competence, is broadly accepted, forms of professional teacher learning that lead to the effective teaching of numeracy are still the subject of ongoing research. This paper reports on a small scale study which aimed to investigate the potential for pairs of teachers, working with two tertiary mathematics educators, to improve the quality of their teaching of numeracy through reflection on each other's teaching practice. While viewing their teacher pair's lesson via video each teacher identified aspects of the lesson that they could use to improve their own teaching.

The notion of numeracy as the capacity to make use of mathematics within contexts associated with personal and public life, as distinct from basic mathematical competence, has been recognised since at least the time of the *Crowther Report* (e.g., Ministry of Education, 1959) with subsequent reports and influential literature (see for example, Cockcroft, 1982; Steen, 2001) emphasising the importance of numeracy as a focus of schooling. More recently, the OECD Program for International Student Assessment (PISA) has sought to ascertain the standards, among 57 participating countries, of knowledge and skills across the domains of reading, scientific and mathematical literacy that are necessary for full participation in society. PISA's Assessment Framework – Mathematics, Reading, Science and Problem Solving Knowledge and Skills (2003) provides the following definition for mathematical literacy.

Mathematical literacy is an individual's capacity to identify and understand the role that mathematics plays in the world, to make well-founded judgements and to use and engage with mathematics in ways that meet the needs of that individual's life as a constructive, concerned and reflective citizen. (p. 24)

In Australia the issue of numeracy has been the subject of much discussion and research resulting in the following broadly accepted definition.

To be numerate is to use mathematics effectively to meet the general demands of life at home, in paid work, and for participation in community and civic life. (Australian Association of Mathematics Teachers Inc., 1997 p. 15)

The importance of developing the numeracy capacities of young people to accommodate the demands of their current and future lives has also been identified in policy documents such as the *National Numeracy Review* (Human Capital Working Group Council of Australian Governments, 2008) and in the recently released draft curriculum documents for Mathematics, Science, English and History (ACARA, 2010).

While understandings of what is meant by numeracy have converged over time, what constitutes effective numeracy teaching and what forms of teacher professional learning best promote effective classroom practice are still developing fields of study. A large study that included over 2000 students and 90 teachers in the United Kingdom found that highly effective teachers of numeracy tended to engage in mathematics specific professional development on a regular basis over an extended period of time (Askew, Brown, Rhodes,



Johnson, & Wiliam, 1997). These teachers perceived that ongoing professional leaning was critical to their continued development as teachers of numeracy. It was also observed that highly effective teachers were able to assist other teachers to become more effective. Using Askew et al's (1997) study as a starting point, Muir (2008) developed a synthesis of the literature related to effective teaching in numeracy, identifying commonalities across studies and learning contexts. While Muir (2008) concedes that the studies that form the basis of the synthesis operated from varying definitions of numeracy and of what constitutes effective teaching, she identifies the following principles of practice as being central to effective teaching of numeracy: making connections; challenging all pupils; teaching for conceptual understanding; facilitating purposeful discussion; maintaining a focus on mathematics; and possessing and instilling positive attitudes towards mathematics.

While the identification of these principles is helpful in describing teaching actions that lead to effective numeracy teaching, the principles do not in themselves describe how effective teachers of numeracy acquire these ways of working.

In a study which investigated effective pedagogies for the teaching of numeracy in Tasmanian schools, Beswick, Swabey and Andrew (2008) found that the majority of teachers in their study used pedagogies that contributed to supportive classroom environments. However, they also observed a disconnection between the aims of the mathematics curriculum and teachers' actions in relation to numeracy specific pedagogical approaches. These studies highlight the need for ongoing research into improving numeracy teaching, particularly in light of the state and national curriculum priorities.

This paper reports on a small scale study which aimed to investigate the potential for pairs of teachers, working with two tertiary mathematics educators, to improve the quality of their teaching in numeracy through reflection on each other's teaching practice. The processes used to facilitate pairwise reflection will be described and implications of its use in professional learning of effective approaches to teaching numeracy will be discussed.

Theoretical Background

In order to theorise the changes in teaching practice that took place in this study we draw on Millett and Bibby's (2004) model of teacher change within the context of curriculum reform. Millett and Bibby's (2004) model illustrates the local context of curriculum reform and, in so doing, suggests that the role played by a teacher's professional learning community is vital to effective reform. Their model (Figure 1) represents the role of the teacher as central to the implementation of curriculum reform and so a teacher's "personal agency beliefs" and "beliefs about self-efficacy...and academic self esteem" (p. 5) play a part in determining the success or otherwise of the implementation process. Here we are reminded of the cyclical nature of teacher efficacy. With every new task teachers can go through a cycle that begins with a state of *unconscious incompetence* where a teacher is unaware of the limitations of their knowledge, to a state of *conscious incompetence* where a teacher becomes aware of their limitations in respect to a specific aspect of their teaching. A teacher can move from a state of *conscious incompetence* to a state of *conscious competence* following positive efficacy feedback before entering a state of *unconscious competence* where they have no need to dwell on their competency level (Schatz, 2006). Surrounding the teacher is the *situation*, a specific school culture that impacts on the teacher's capacity to change. Finally, the teacher and the situation are located within a wider context that includes influences such as: policy developed by governments and various authorities; professionals external to education; the

private or commercial sector; and the general public or those who are outside the school but are none-the-less interested in education such as parents and the media.

Drawing on Spillane’s (1999) earlier work, Millett and Bibby note that the impetus for curriculum reform often comes from a wider context beyond the school environment that stimulates a “zone of enactment” (p.4) in which the teacher will respond positively or negatively to this external challenge. Critical to a teacher’s response within their *zone of enactment* is the type of support found within a teacher’s professional learning community in which sharing and critical interrogation of their practice takes place. Positive support within the community includes “rich deliberations” that, when “grounded in practice and supported by resources, curriculum change [is] more likely to be operationalised” (p. 4).

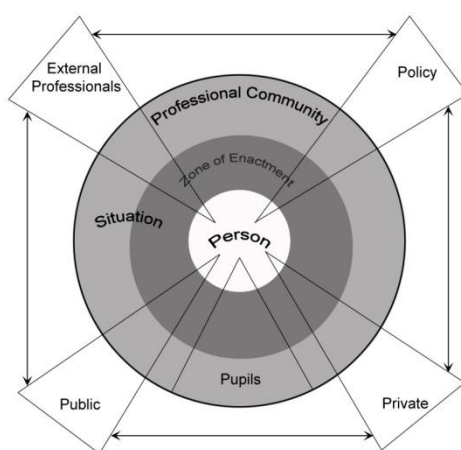

Figure 1. Theoretical model for analysing the context of curriculum reform. (Millett & Bibby, 2004, p.3)

The influence of a teacher’s personal and professional identity on curriculum reform is also supported elsewhere in the literature where efficacy issues in respect to mathematics teaching in primary schools are identified as critical factors (Ball & Bass, 2003; Ma, 1999).

The importance of time, talk, expertise, and motivation in providing the sources of support necessary for positive self-efficacy has been identified by Millett, Brown and Askew (2004). It seemed that time, talk, and expertise complement internal motivation, resulting in “deep change” (p. 245). They also noted that external expertise was deemed to be essential to support teachers’ learning with respect to new content knowledge and content specific pedagogical knowledge. More recent research (Heirdsfield, Lamb, & Spry, 2010) found that another factor critical to developing the motivation that leads to deep change is length of time. This study reports that the two teacher participants needed two years of ongoing assistance from the external expert to provide the necessary expertise for them to develop a sense of agency.

Method

Participants and Procedure

The data reported in this paper is drawn from interactions with and between one pair of Year 7 teachers who participated in a study that involved eight teachers, four each from Years 5 and 7 from one primary school located in the inner suburbs of Brisbane, Queensland and two university-based researchers. The study was conducted over a six

month period in the second half of the 2009 school year. A case study approach (Stake, 2005) was used to document the actions and interactions of these two teachers as they worked together to enhance each other's numeracy teaching practice. The selection of the school was opportune (Burns, 2000) as the leadership of the school invited the researchers to work with staff on a research project that aimed to enhance numeracy teaching practice within the school due to recent disappointing results on NAPLAN tests. All teachers in Years 5 and 7 (two of the years in which NAPLAN testing takes place) were strongly encouraged by the school leadership team to participate in the project.

Two teachers are the focus of this paper. Julie is an experienced teacher with more than 20 years experience who has worked at the school for six years. Stephanie has five years classroom experience with the last two years working at Hillside. Selection of the teachers reported on in this paper was purposive as their cases were chosen for the capacity to illuminate rather than for representativeness (Stake, 2005). In particular, the cases reported on in this paper were selected because of the way these teachers influenced each other's *zones of enactment*.

Data collection methods included classroom observations and field notes, audio and video recording of individual teacher interviews, and audio recording of a pair-wise stimulated recall interview (Meade & McMeniman, 1992) based around a video recording of one teacher's lesson.

This project was designed to provide *time*, through the provision of funded teacher release for teachers to *talk* and reflect on the difficulties identified by the Department of Education Training and the Arts (DETA) in the 2008 NAPLAN testing and Hillside's results in order to *plan* action that would lead to improved student outcomes. *Expert* input came from the researchers working with the teachers in the project. The sharing of expertise in a collaborative and supportive environment was designed to promote *motivation* within this professional learning community. In order to enable this process the project was enacted in four phases.

Phase 1: This first phase of the project involved the researchers introducing the participating teachers to the topic of teaching numeracy by discussing the current research literature in this area. The teachers then reflected on their school's NAPLAN results in light of a review conducted by DETA which analysed student responses. Teachers also examined the most recent NAPLAN assessments for both Years 5 and 7 in order to gain a sense of the type of tasks to which students were required to respond.

Phase 2: Teachers worked collaboratively to vision and then plan a series of lessons that were taught within a life-related context.

Phase 3: Teachers delivered their planned lessons with one lesson in the series for each teacher being video recorded. The lesson chosen was negotiated between the researchers and the teacher. Following each videoed lesson a semi-structured interview was conducted with the teacher.

Phase 4: This final phase involved a discussion of teachers' video recorded lessons. Commentary was provided by the teacher who taught the lesson on intended lesson outcomes and justification of enacted approaches as both teachers and the researchers viewed the video together. This was followed by a discussion between the teaching pair and the researchers which provided opportunity for a critique of the lesson.

Audio and video recordings from each of the phases were transcribed and then examined, in conjunction with other data, for evidence of changes or perturbations to a teacher's *zone of enactment*. Patterns of behaviour were identified initially through observation during the introductory phase of the project. Ongoing changes in behaviour

were identified through classroom observation and triangulated via post lesson semi-structured interviews. New understandings and changes to practice were confirmed during final discussion by re-examining transcripts at all phases of the project. The results from this study are now reported.

Results and Analysis

Phase 1: Introduction and Preparation

The researchers began the introductory session by outlining current research based understandings of best practice in teaching numeracy. After this presentation teachers were asked to review the 2009 NAPLAN numeracy tests for both Years 5 and 7 in order to identify the types of tasks to which students were required to respond. The purpose of this activity was to challenge teachers to reflect on their own teaching practice in the light of the demands placed on their students during the national testing regime. From this activity teachers noted that many questions were embedded in a context and that a number of tasks required students to engage in higher order thinking and problem solving. After some discussion the teachers decided the best way to assist their students on these tests, and also help them develop into numerate citizens, was to include additional open ended or investigatory activities which were embedded in life related contexts.

To support this direction the researchers outlined the data gathering procedures that would be used to assist them to reflect on their own practice. The prospect of being video recorded was of no concern to Julie. She held positive self-efficacy beliefs about her teaching ability and outlined how in a previous school her lessons were regularly video recorded and used as exemplars for pre-service teachers. In contrast, Stephanie was very reluctant to be video recorded. She believed that Julie was a better teacher and was worried that she was more likely to produce a lesson that would demonstrate what not to do. This indicated that Stephanie held low self-efficacy beliefs about her potential to produce a lesson comparable in quality with that of Julie even though neither teacher had previously made extensive use of investigatory and context driven approaches to teaching numeracy.

According to Millett and Bibby (2004) the teachers' *zone of enactment* is the area for potential and possibility. In this study Julie demonstrates both personal and professional self efficacy characteristics that have the potential to promote motivation, providing her with the capacity to engage in curriculum reform. For Stephanie, the new task of developing and delivering lessons on numeracy had pushed her into a state of *conscious incompetence* (Schraatz, 2006) where considerable discomfort was experienced. Consequently, the decision was made, by mutual consent between Stephanie and the research team, not to video her lesson although Stephanie did agree to have her lesson audio recorded. At this stage it appeared that Stephanie was less likely to engage in curriculum reform.

Phase 2: Planning

Both teachers reported discussing their intended lesson approaches on a regular basis. These discussions proved to be a source of positive self-efficacy feedback for both teachers. They described how they both adapted their planned lessons following these discussions to provide purposeful open-ended investigations that would be of interest to their students while challenging their mathematical thinking. These two teachers are clearly changing the *situation* in which they work by stimulating each other's *zones of*

enactment through vicarious experiences. In particular, it can be argued that Julie's positive self-efficacy also gave her the confidence to support Stephanie in pushing the boundaries of her own *zone of enactment*. This in turn empowered Stephanie to make a contribution to Julie's intended lesson approaches reinforcing Julie's motivation and actions, extending her *zone of enactment*.

Phase 3: The Lessons

Julie began her lesson by displaying six packs of different brands of toilet paper asking an open ended question by saying that she didn't know which pack was the best buy and needed her students' help to make a decision. Her students immediately became involved suggesting that she just compare the prices. In response, Julie asked them to provide her with information listed on the packs as she recorded it on the board. It didn't take long before a student realised that the pack contained different numbers of sheets per roll which led to calculations on price per sheet. Some students then noticed that the size of each sheet was different which led them to calculating the area per pack and a follow-up comparison of price. The student then noted that some rolls were one-ply, others two-ply and still others three-ply. New calculations were conducted. Once these aspects of mathematical calculations were completed, Julie asked, "Well what is the best toilet paper for me to buy?" There was division in the classroom and some students claimed other aspects, such as comfort, needed to be considered. One student called out, "How much do you have to spend on toilet paper?" This lesson ended with Julie introducing the topic of budgeting.

Stephanie's lesson began with a list of questions posted on the whiteboard and a newspaper article which selected students read to the class. This article was critical of the Brisbane City Council for increasing parking meters to inner city residential areas from 2900 to 9100, netting an extra \$16 million a year. The article went on to detail that these extra parking meters would be implemented over three phases. Stephanie directed her students to a list of questions on the whiteboard with the first question requiring the calculation of the increase in parking meters. The next question required the calculation of revenue raised per meter and then the money raised per phase of implementation. As these calculations were conducted the students were very surprised by the large amounts of money per meter. As these students had recently completed study on the responsibilities of the Brisbane City Council they began suggesting further increases to parking meters to fund local swimming pools and libraries. Although this activity was set in a life-related context the closed approach limited the potential for student generated follow-up investigations resulting in the task being constrained to one lesson.

Phase 4: Reflection, Discussion and Feedback

This phase of the study involved the teacher pair and the researchers viewing Julie's video recorded lesson and listening to the audio tape of Stephanie's lesson. Prior to Julie's lesson being shown she explained to Stephanie and the researchers her objectives for the lesson and reflected on how she believed she had achieved her objectives. She felt that her students had enjoyed the lesson as indicated by requests for "more like that". At this point it became evident that the role played by the researchers had been instrumental in supporting Julie to experiment with a new teaching approach. After the initial interaction with the researchers, Julie had become convinced that her students would benefit if she made changes to her teaching practice. Julie's positive self-efficacy had enabled her to enact these changes. The proficiency of her performance and positive feedback from the

students and her learning community, which included Stephanie and the two researchers, had changed the *situation* re-enforcing the changes she had made to her *zone of enactment*.

As Stephanie observed with focussed attention the video of Julie's lesson she made comments such as, "that's so clever", "look how those kids are eating out of your hand." When the video was stopped, Stephanie highlighted the points that were important for her. She explained, "Right from the beginning you gave the direction of the lesson over to the kids. You gave them the problem and the toilet paper rolls ... They could have given you the information in any order [a sense of fear of the unknown was evident here] ... I need to let go a bit [realisation of new learning] ... It is so engaging, just look at these kids [positive feedback]."

This pattern of discussion persisted throughout Stephanie's discussion of Julie's lesson. In particular, she noted the open-ended nature of Julie's task and its potential to lead into a range of mathematics topics compared to her own closed, one lesson approach. Also noteworthy was the fact that Stephanie chose not to criticise Julie's lesson in any way and referred only to positive aspects of the lesson that Stephanie thought she should marry with her own practice. In this way, Stephanie did not introduce any issues which might deintensify the momentum for curriculum reform Julie had gained within her *zone of enactment*. In addition, as Stephanie focused on the positive aspects of the lesson which she believed were achievable within her own practice, she reinforced the direction she had taken within her *zone of enactment*.

Interestingly, when Julie had the opportunity to critique the audio presentation of Stephanie's lesson, she adopted the same approach of only commenting on positive aspects of the lesson which Julie thought she could adopt in the future. This had the effect of positively influencing Stephanie's self-efficacy as she received positive feedback on her approach pushing her *zone of enactment* in the direction of the desired curriculum reform.

This session concluded with both teachers stating they would introduce further lessons of the type they had tried during the project and that they believed their students had engaged in learning in a way that they had not noticed when working with mathematics through traditional approaches.

Conclusion

The positive feedback provided by both teachers on each others' attempts to implement curriculum reform was a very important influence on the self-efficacy of Julie and Stephanie. In this *situation* the rich interactions that were grounded in practice resulted in the teachers pushing the boundaries of their respective *zones of enactment*. These changes only took place because the project had provided the teachers with time to talk and the provision of expertise from outside the school, once the researchers were accepted into the teachers' learning community. The opportunity to view each others' classroom practice, facilitated via video recording, was also a critical factor in positively influencing each teacher's *zone of enactment*. This method has implications for approaches to teachers' professional learning as the difficulties of viewing another teacher's classroom within the context of the business of a school day means that, in general, teachers practice remains personal, private and not open to any form of critical interrogation. While the findings of this study are encouraging, further research is necessary to establish whether the approach adopted in this study leads to long term changes in practice. This is especially so given the short term nature of the intervention which challenges advice from the literature on the length of time require to effect permanent change to practice (e.g., Heirdsfield, Lamb, & Spry, 2010). In addition, the effects of negative feedback on teachers' zones of enactment

must also be documented in order to understand self-efficacy feedback cycles that inhibit rather than promote curriculum reform (Schratz, 2006).

References

- Askew, M., Brown, M., Rhodes, V., Johnson, D., & Wiliam, D. (1997). *Effective teachers of numeracy*. London: School of Education, King's College.
- Australian Association of Mathematics Teachers Inc. (1997). *Numeracy = Everyone's Business*, Report of the Numeracy Education Strategy Development Conference. Adelaide: AAMT.
- Australian Curriculum and Assessment Reporting Authority (2010). *Draft Australian National Curriculum*, Retrieved 19 March 2010, from <http://www.australiancurriculum.edu.au/Learn>
- Ball, D. L., & Bass, H. (2003). *Towards a practice-based theory of mathematical knowledge for teaching*. Paper presented at the 2002 annual meeting of the Canadian mathematics education study group, Edmonton, AB.
- Beswick, K., Swabey, K., & Andrew, R. (2008). Looking for attitudes of powerful teaching for numeracy in Tasmania K-7 classrooms. *Mathematics Education Research Journal*, 20(1), 3-31.
- Burns, R. (2000). *Introduction to research methods* (3rd ed.). Melbourne: Longman.
- Cockcroft, W. (1982). *Mathematics counts*. London: HMSO.
- Heirdsfield, A., Lamb, J., & Spry, G. (2010). Leading learning within a PLC: Implementing new mathematics content. *The Montana Mathematics Enthusiast*, 17(1), 93-112.
- Human Capital Working Group Council of Australian Governments (2008). *National numeracy review report*. Retrieved 12 March 2010 from http://www.coag.gov.au/reports/docs/national_numeracy_review.pdf
- Ma, L. (1999). *Knowing and teaching elementary mathematics: Teachers' understanding of fundamental mathematics in China and the United States*. New Jersey: Erlbaum Associates.
- Meade, P., & McMeniman, M. (1992). Stimulated recall: An effective methodology for examining successful teaching in science. *Australian Educational Researcher*, 19(3), 1-18.
- Millett, A., & Bibby, T. (2004). The context for change. In A. Millett, M. Brown & M. Askew (Eds.), *Primary mathematics and the developing professional* (pp. 1-17). Netherlands: Kluwer Academic Publishers.
- Millett, A., Brown, M., & Askew, M. (2004). Drawing conclusions. In A. Millett, M. Brown & M. Askew (Eds.), *Primary mathematics and the developing professional* (pp. 245-255). Netherlands: Kluwer Academic Publishers.
- Ministry of Education (1959). *15 to 18: A report of the Central Advisory Council for Education*. London: HMSO.
- Muir, T. (2008). Principles of practice and teacher actions: Influences on effective teaching of numeracy. *Mathematics Education Research Journal* 20(3), 78-101.
- OECD/PISA (2003). *Assessment framework - Mathematics, reading, science and problem solving knowledge and skills*. Retrieved 12 March, 2010, from <http://www.oecd.org/dataoecd/38/51/33707192.pdf>
- Schratz, M. (2006). Leading and Learning: 'Odd Couple' or Powerful Match? *Leading and Managing: Journal of the Australian Council for Educational Leaders*, 12(2), 40-43.
- Spillane, J. (1999). External reform initiatives and teachers' efforts to reconstruct their practice: The mediating role of teachers' zones of enactment. *Journal of Curriculum Studies*, 31(2), 143-175.
- Stake, R. (2005). *Qualitative case studies*. In N. Denzin & Y. Lincoln (Eds.), *The sage handbook of qualitative research* (Third ed.). Thousand Oaks, California: Sage Publications, Inc.
- Steen, L. (2001). The case for quantitative literacy. In L. Steen (Ed.), *Mathematics and democracy: The case for quantitative literacy* (pp. 1-22). Princeton, NJ: National Council on Education and the Disciplines.

Assessment for Learning Tasks and the Peer Assessment Process

Lorraine Lauf

The University of Queensland
<s4115031@uq.edu.au>

Shelley Dole

The University of Queensland
<s.dole@uq.edu.au>

A program of Assessment for Learning (AfL) was implemented with 107 Year 12 students as part of their preparation for a major external test. Students completed extended mathematics tasks and selected student responses were used for peer assessment purposes. This paper reports on two of the AfL elements, namely task selection and peer assessment as part of the AfL process. The importance of initial task selection in terms of supporting students in building awareness of quality of mathematical arguments is highlighted.

Assessment for Learning (AfL) is a relatively recently coined phrase that, according to Lee (2006) is “a way of shaping learning using evidence of pupils’ understanding” (p. 43). It is not about checklists or criteria, but rather describes the ways in which teachers observe and try to understand student learning, and then use that information to further future learning (Drummond, 2003). Black, Harrison, Lee, Marshall and Wiliam (2004) have defined AfL as any assessment that has as its main priority, the promotion of student learning rather than ranking, or accountability, or of certifying competence. Assessment can be classified as AfL if it provides information that teachers and students can use to modify teaching and learning activities (Black et al., 2004).

AfL is “a body of theory and a range of classroom practices” (Brooks & Tough, 2006, p. 5). It came about because of the need to use assessment in a positive way to both raise standards and to empower students (Black & Wiliam, 1998). Brookhart, Moss and Long (2008) have claimed that AfL “contributes to student ownership of learning more than any other classroom-based practice” (p. 54). The effectiveness of AfL, according to Brookhart (2007) is due to its impact on students’ cognitive and motivational factors; it shows students where they are in their understanding (the cognitive factor) and develops in them a feeling of control over their learning (the motivational factor).

The classroom practices of AfL include four main techniques of questions (or tasks), sharing criteria, self and peer assessment, and feedback. The first technique, questions, is the tasks that students undertake in the assessment process. The students’ responses to the questions are the focus of the AfL process and therefore suitable questions are those that require students to demonstrate their thinking and justify their solutions. The questions must be sufficiently open to ensure a range of responses and solution pathways. In order to complete the questions appropriately, students need to be aware of the criteria for assessment. The second AfL technique is about sharing criteria. Sadler (1987) has suggested that sharing criteria should be done by modelling exercises where the criteria are applied to specific work. Time to apply criteria is an important aspect of AfL as providing students with criteria alone is unhelpful if students don’t know how to apply them to their work. One way of doing this is by using self and peer assessment, and this is the third technique in the AfL process.

Self assessment occurs when students evaluate their own work and make a judgement about its quality. Peer assessment is the same process but students look at the work of others. Self and peer assessment make unique contributions to the progress of learning as, through this process, students come to understand what counts as quality through examples. Feedback is the fourth AfL technique. Feedback can be written, oral or by demonstration, and can be provided individually or to a group (Brookhart, 2007). Feedback



can come from the teacher or from peer assessment. The most useful feedback contains information that a student can use, in that it focuses on the quality of the work and provides suggestions on what to do to improve. This is particularly helpful to lower achieving students as it shows that effort can help them to improve (Boston, 2002).

Implementing AfL is not a simple process. Marshall and Drummond (2006) have stated that implementing AfL effectively is actually difficult to achieve in practice, possibly because there is no simple recipe for it. AfL will look different in every classroom and teachers need to develop ways of incorporating its ideas into their own practice (Wiliam, 2005). Successful AfL is also predicated on teachers' beliefs about the nature of learning and assessment, and is dependent upon the degree to which the teacher values student autonomy and makes this an explicit aim of their teaching. AfL therefore, challenges notions about assessment and the students' role in the assessment process. Few studies provide prescriptive guidelines for AfL, and for mathematics in particular, there is even more limited guidance on how to implement AfL (Wiliam, 2008), compounded by a dearth of tested tasks (Black, et al., 2004). Even less is published literature relating to AfL in a senior (Year 12) Mathematics classroom.

The Study

This study was undertaken with Year 12 students, to explore the potential of AfL in preparing them to undertake a major external exam. In the state in which this study was conducted (Queensland), there are no subject-based external examinations. Instead, all Year 12 students undertake external assessment in the form of a core skills test that examines knowledge and skills. This test, the Queensland Core Skills (QCS) test, is used to compare the achievement of students doing different subjects at different schools. QCS test results are used to scale school results in order to determine overall Year 12 positions of students. The QCS test is high-stakes, and many Queensland high schools spend much time preparing students for it. The test does not assess knowledge of specific Year 12 subjects but rather a set of 49 generic skills, called the Common Curriculum Elements (CCEs). Examples of these are: interrelating ideas/themes/issues; hypothesising; judging/evaluating; criticising; justifying; reaching a conclusion which is consistent with a given set of assumptions; translating from one form to another (QSA, 2009). Although generic, some CCEs are more specific to mathematics, as indicated in the following list: graphing; calculating; estimating numerical magnitude; approximating a numerical value; substituting in formulae; structuring/organising a mathematical argument.

The Queensland Studies Authority (QSA), as the administering body of the QCS test, states that Year 10 knowledge of mathematical operations is assumed. Mathematical (referred to as numeracy) items on the QCS are extended tasks that require higher order mathematical thinking, high-level analysis and problem solving skills. Statistics on school performance on the QCS test are available from the Queensland Studies Authority (QSA). For the school where the research was undertaken, results indicated that there was potential for improvement in students' scores on items that assess the common curriculum elements related to numeracy. The focus of this study was on the specific CCE of structuring/organising a mathematical argument.

The participants comprised all the Year 12 students ($n = 107$) enrolled at a girls' high school in Queensland, Australia. The majority of the girls were 16 or 17 years old. Data sources in this project included four extended mathematics tasks, a survey and interviews. The four tasks used in this study (Barbie, Pegs in Holes, Greek Flag, Pi), were selected on

the basis of open-endedness and requirement of a mathematical argument for solution. A brief description of each of these tasks follows.

The *Barbie* task provides students with a set of measurements of a Barbie doll and an ‘average’ teenage girl: height, leg length, waist, hips, feet, neck length and neck circumference. Students are required to use some of the measurements to develop a convincing mathematical argument showing why it is unrealistic for girls to aim to look like Barbie. The *Pegs in Holes* task asks students to explain which fits better: a square peg in a round hole or a round peg in a square hole? No other information is given and students are expected to set up their own sketch and dimensions of squares and circles. This could be done using formulae for areas of squares and circles, or using specific numbers for the dimensions. Students would need to define ‘fit’ and to calculate the proportion or percentage fit according to their definition. The *Greek Flag* task was taken from a 2008 QCS test. In this task, a picture of the flag is given, together with a brief description of the sizes of the stripes and the ratio of height to length. The question asks students to calculate the exact fraction of blue on the flag and explain their reasoning. The *Pi* task was also taken from a previous QCS test. This task requires the calculation of an incorrect value of π , given a description in words of how to perform the calculation. The task asks students to translate from words into algebra and requires students to show all steps.

The survey was printed on a double-sided A4 sheet of paper and consisted of four sections seeking information on: demographic details, and students’ opinions on QCS in general, QCS preparation, and the AfL process. Apart from the background information items, all other items followed the same format, providing a statement and asking the students to indicate the degree to which they agreed or disagreed (using a 5-point Likert scale) with each statement. The survey was designed to take approximately 5-10 minutes to complete.

The interview consisted of four structured questions: How did you feel about the AfL process? Did the peer assessment component help? How did you find the AfL tasks? Do you feel nervous/apprehensive about the forthcoming QCS test? Please elaborate. The interview took approximately 10-15 minutes.

Procedure

The AfL process can be loosely described as a series of steps, with students presented with tasks, the criteria for task completion discussed and analysed, and students then undertaking the tasks, with student responses used for peer and self-assessment purposes. Students thus receive feedback on the quality of responses in relation to the criteria. To support students’ learning, the process is repeated to enable students to apply their knowledge about criteria to new tasks.

In this study, this was the process followed. But, without clear guidelines, the study proceeded in a somewhat tentative and exploratory manner. Five QCS preparation lessons of approximately 40 minutes each were used for AfL in this study over a course of five weeks. In the first lesson, discussion of quality in relation to a mathematical argument was the focus. Criteria for assessment of extended mathematical tasks were shared with the students. Students were then presented with the *Barbie* task and were given time to discuss possible approaches to the task. Students began the task in the lesson then completed it for homework. Their completed responses were collected by the teacher/researcher who analysed all responses, selecting a variety to share with students in the following lesson. In the second lesson, students analysed the selected responses against the criteria. They were then given the second task, which was completed for homework. This cycle was repeated

for the third lesson and fourth lesson. In the final lesson, students completed the fourth task under test conditions.

Results

This paper focuses on results associated with the process of task selection and peer and self-assessment. Students' responses to Tasks 1 (*Barbie*), 2 (*Pegs in Holes*) and 3 (*Greek Flag*) showed great variety, and served as an excellent resource for self and peer assessment and feedback. Analysis and selection of tasks for the AfL process was for the purpose of stimulating discussion and providing students with opportunities to deepen their understanding of what constitutes quality in mathematical arguments. Therefore, students' performances on these tasks were not collated to determine the number of students who scored at particular levels, but rather were analysed for their potential for classroom use.

In the first lesson, to focus their attention on the concept of quality, students were given a chocolate. While they were eating the chocolate they were asked to find words to describe quality chocolate. This laid the groundwork to ask students to consider criteria for determining quality in relation to a mathematical argument. Standard criteria used in Queensland for assessing extended mathematics tasks were then displayed, and students recognised their own suggestions (but in different words) in these statements. In sharing criteria, it was hoped that students would develop greater awareness of the features of high quality responses to mathematics tasks: correct interpretation of the situation; use of effective and appropriate strategies to solve the problem; language and mathematics used accurately and appropriately; procedures justified; logical reasoning used to develop convincing arguments to support a conclusion or result. The *Barbie* task was then presented and students were given time to discuss possible solution pathways they might take. This discussion time was animated and sustained for approximately 20 minutes. Students completed the task at home and returned their responses the next day. Of the selected responses, the teacher/researcher typed the responses to ensure author anonymity.

Barbie responses 1, 2 and 3 were selected because they provided some impressive use of mathematical calculations and/or use of mathematical procedures, but only at a superficial level. *Barbie 1* provided many percentages and the dialogue was presented with authority. The following is an excerpt:

With the careful use of ratios and percentages it was found that *Barbie's* leg length in real life would be 77% longer than an average teenage girl's...Many more convincing comparisons could be made if needed.

These words attempt to communicate mathematically but are too vague and do not explain the underlying calculations. Furthermore, the 77% is incorrect.

Barbie 2 took a much more structured approach, providing a data table. All the numbers were presented without explanation, but were correct. A ratio approach was used for the calculations. The response, however, did not use the calculated numbers effectively and did not produce a mathematical argument to answer the question. It seemed to expect the reader to come to conclusions without thorough explanation and communication.

Barbie 3 included some complicated ratios that were used to compare *Barbie* measurements with the teenage girl, as follows:

A normal teenage girl has a bust-waist-hip measurement of 88: 72: 96. However when Barbie is enlarged to the average height, her body measures 81.5: 48.3: 75.4

The response did not communicate the basis or method of calculation. The response made other claims about *Barbie's* proportions but the numbers were not believable because they were not explained or justified. This response did not present a convincing argument.

When these first three responses were shown (consecutively) to the students and they were asked to comment on their quality, there was a general agreement that these responses were quite convincing, although they were quite weak in their mathematical argument. The students were impressed with the use of mathematical calculations and the authoritative presentation, referring to criteria statements to support their evaluations. The teacher/researcher needed to intervene to challenge students to critically interrogate the criteria as they analysed the selected responses. Through this process, students came to realise that these first three responses were not very convincing at all. When shown *Barbie 4* response, the students stated that it contained many unsubstantiated numbers and claims; that the numbers were not believable because there was no communication of how they were calculated.

Barbie 5 was deemed to be one of the best responses submitted. It explained clearly why a teenager's height is six times that of *Barbie*, as follows:

When measuring your product it stands at 29cm, a teenage girl's height is approximately 175cm. That means a young girl is six times taller than the Barbie doll.

The response then used this factor of six to scale down the teenager's other measurements:

If the proportions and measurements of the other body parts of the Barbie doll are to be realistic you would divide all the humans' measurements by six.

The response then concluded (correctly) that *Barbie's* waist was the dimension that was most significantly out of proportion.

The most staggering discovery was the difference in the waist measurements. The current Barbie has a waist of 8cm, if this was to be realistic for the height of the Barbie you would divide the average waist of a human by six and find that it is 12cm.

When *Barbie 5* was presented, students commented that it was a simple, well-communicated response. They noted that it used a few well-chosen dimensions, explained the basis for calculations, and communicated findings clearly. For most students, this response highlighted the inadequacies of the previous four responses. The teacher/researcher had very little involvement in this discussion, as students were able to work this out for themselves. This was reassuring for the teacher/researcher as it seemed that the process of peer assessment was having an impact in terms of training students to recognise a quality mathematical argument. Students were then presented with *Pegs in Holes* and after discussing possible approaches, were required to complete it for homework.

For the *Pegs in Holes* task, *Pegs 1* response was selected because it was a fairly common incorrect answer. *Pegs 1* showed a circle with dimensions that fitted into a square with correct calculations of the areas for each. The respondent then tried to fit that particular square into the same circle, without changing the dimensions of either. Of course, the square would not fit and it was impossible to come to a conclusion about which was the better fit. The dimensions of one of the shapes would be required to change for there to be a fit. *Pegs 2* response was chosen because it was a well-presented, elegant solution. Numbers were selected to make the circle fit into the square, and areas were calculated. The method then kept the same square but increased the size of the circle to make the square fit into it. In order to compare the fit of both, the response compared the percentage of wasted space. The lower the percentage of wasted space, the better the fit

would be. *Pegs 3* response took a more algebraic approach because it did not use specific numbers for any of the dimensions – variables were used. It looked at the fraction of the total space used up by the inside shape. The more space used up, the better the fit. This approach demonstrated the concept for all squares and circles that fit into each other, providing a convincing mathematical argument using algebra. The third response concluded as follows:

The circle in the square fits better as the circle takes up 78% of the squares area. A square in a circle the square only takes up 63% of the circles area. Therefore the better fit is the circle within the square.

By the time these three responses were presented, the students seemed to have become more discerning and were more critical when assessing their peers' work. In the third lesson of this AfL sequence, the students were presented with the *Greek Flag* task, and after initial discussion time, were required to complete it for homework.

The third task involved calculating the exact fraction of blue in the *Greek Flag*. Although this question appeared to be relatively straightforward, it was by far the most difficult task to complete correctly. Four responses were selected. *Flag 1* response gave the answer: one-half. This was a very superficial answer and it can be seen clearly from the drawing of the flag that this answer was wrong. *Flag 2* was a slightly better response because it attempted to explain that $\frac{5}{9}$ was blue. This is correct for one of the sections of the flag. *Flag 3* was selected because it was well set out and provided a clear explanation. It divided the flag into three sections, all clearly labelled (top left, top right and bottom), and calculated the amount of blue for each. It then calculated the whole area and explained how it worked out the fraction of blue:

First I measured all the blue sections. Then I calculated the areas of the rectangles and squares by using the formula: $L \times W$. I then measured the length and height of the whole flag and calculated its area. Fraction of blue = $\frac{\text{Total blue area}}{\text{Total area}}$

Unfortunately, despite the detailed explanation, it cannot yield the correct answer. It does not use the given ratio of height to length to determine the dimensions of the various blue sections. Instead, dimensions were measured using a ruler, with the associated measurement error. As a result, it was not possible to calculate the exact fraction of blue and the response did not answer the question, which was to calculate the exact fraction of blue. *Flag 3* demonstrated that, even though mathematical communication is very important, it needed to communicate correct mathematics that answered the question. *Flag 4* was selected because it was a correct answer with a clear explanation of the method. It showed clearly how it scaled up the given ratios of the dimensions of the flag to arrive at useful dimensions for the whole flag as shown:

Given	Height: Length
=	2 : 3
=	1 : 1.5
=	9 : 13.5

So the flag is 9 units high and 13.5 units long.

Total area	= 9 x 13.5
	= 121.5

The response divided the flag into three regions and correctly calculated the area of blue in each. It then proceeded in a similar way to *Flag 3* by adding up all of the blue areas, and working this out as a fraction of the total: $\frac{137}{243}$.

When shown the response by *Flag 1*, the students readily identified the limitation of the response, and similarly for *Flag 2* although the students rated *Flag 2* higher than *Flag 1*. For *Flag 3* however, they were more hesitant to identify the limitations of the response, as they were impressed with the clear presentation of the mathematical argument. The teacher then reminded students of the question and asked them if the exact, rather than estimated area had been identified in the responses. When students were presented with the response by *Flag 4*, they could see the depth of response but also realised the effort required to achieve such a response. When students realised that the task required an actual answer of $\frac{137}{243}$, there was a strong murmur of unrest throughout the room as the majority of students knew that they had not achieved this result. As a previous QCS task, the teacher was able to provide a second level of feedback to the students on each of the four selected responses using QCS criteria. Scoring of this QCS task was via a 7-point scale, with the criteria summarised as follows:

A = correct answer explained	E = one aspect correct
B = one mechanical error	N = unintelligible response
C = correct wording leading to a rounded answer	O = no response
D = two aspects correct	

Only *Flag 4* would score an ‘A’ on a QCS test, with *Flag 3* scoring a ‘C’. In the previous lesson, students were seen to readily attempt the *Greek Flag* task, but the majority of responses were a version of the *Flag 3* response – an estimate rather than an exact solution. Receiving this feedback was visibly unsettling at this point in the AfL program.

Discussion

The purpose of AfL is to promote students’ learning, yet there are few specific guidelines, and none for Year 12 students preparing for a high-stakes test. In this study, the first challenge was finding appropriate tasks. According to Marshall and Drummond (2006), teachers implementing AfL are more successful if they select and sequence questions that demand high quality dialogue, deep thinking, and require clarification and refinement of answers. Such questions require challenging mathematical activity and advanced mathematical communication skills (Black et al., 2004). For this study, the literature provided little practical guidance. The teacher/researcher developed and modified tasks that were very different from each other, but appeared to serve as good AfL questions at two levels: first, their solutions were not immediately obvious and required students to devise a plan of attack, and second, they required extended responses and justification of the solution strategy. Appropriate task selection is the first and critical step in the AfL process as, according to Marshall and Drummond (2006), this affects all subsequent discussion and communication. When student responses to the *Barbie* and *Pegs in Holes* tasks were presented, students grappled with issues of quality in mathematical arguments but were seen to become more discerning in identifying quality as they were presented with more responses. The *Greek Flag* (Task 3), however, was a slightly different story. As previously stated, students had little problem interpreting the task and completing a response. The majority of students’ responses to this task, however, were not of a high quality, with many students providing an estimated rather than precise solution. When students realised that few responses to the *Greek Flag* would result in anything higher than a ‘C’ rating, their confidence in discerning quality was visibly shaken. Knowing this was a previous QCS task, this task in the AfL at this time was quite detrimental. The impact of this particular task highlights the difficulty and consequences of task selection.

Through task analysis, students engaged in peer assessment, reviewing selected responses of their peers against given criteria. Black et al., (2004) have stated that it is through examples that students work out what counts as quality, and this study concurs with this finding. Peer assessment is a vital element in the AfL process. This study highlighted the developmental process of understanding criteria. Initially, students were not sufficiently critical of the mathematical arguments offered in their peers' responses, and students were seen to be convinced by weak arguments in some cases. A further issue that is not overtly addressed in the AfL literature is the public use of students' responses for peer and self-assessment. Although not a major issue in this study, the teacher/researcher was acutely aware of the potential negative impact to a student's self-esteem when her work sample is publicly presented to peers, and so took time to type the selected responses so that students' responses could not be identified by their handwriting. The students, however, appreciated being provided with work samples from their peers as they could compare their own responses to those on display.

Conclusion

This study investigated implementing AfL practices in a numeracy/mathematics context in Year 12. Trialling this in an authentic school situation has shown that this approach can readily be incorporated into a QCS preparation program. The difficulty was finding tasks and compiling a bank of responses, and dealing with students' simplistic solutions to complex tasks. In this study, students needed a lot of guidance to determine quality but, in the short time available, they demonstrated a noticeable increase in their awareness of quality in mathematical arguments. Further research into the effects upon numeracy outcomes for Year 12 students is warranted. This study is a tentative first step in an alternative approach to preparation for high-stakes tests, and the results from it are promising as they have direct practical implications for school mathematics programs.

References

- Black, P., Harrison, C., Lee, C., Marshall, B., & Wiliam (2004). Working inside the black box: Assessment for Learning in the classroom. *Phi Delta Kappan*, 86(1), 9-21.
- Black, P. & Wiliam, D. (1998). Inside the black box: Raising standards through classroom assessment. *Phi Delta Kappan*, 80(2), 139-148.
- Boston, C. (2002). The concept of formative assessment. *Practical Assessment, Research & Evaluation*, 8(9), 1-6.
- Brookhart, S. (2007). Feedback that fits. *Educational Leadership*, 65(4), 54-59.
- Brookhart, S., Moss, C. & Long, B. (2008). Formative assessment that empowers. *Educational Leadership*, 66(3), 52-57.
- Brooks, R. & Tough, S. (2006). *Assessment and Testing: Making space for teaching and learning*. London: Institute for Public Policy Research.
- Drummond, M. J. (2003). *Assessing children's learning*. London: David Fulton.
- Lee, C. (2006). *Language for Learning Mathematics: Assessment for Learning in Practice*. Berkshire: OUP.
- Marshall, B. & Drummond, M. (2006). How teachers engage with Assessment for Learning: Lessons from the classroom, *Research Papers in Education*, 21(2), 133-149.
- Queensland Studies Authority (2009). *About the QCS Test*. Retrieved from www.qsa.qld.edu.au/assessment.
- Sadler, R. (1987). Specifying and promulgating achievement standards. *Oxford Review of Education*, 13 (2), 191-209.
- Wiliam, D. (2005). Keeping learning on track: Formative assessment and the regulation of learning. In M. Coupland, J. Anderson & T. Spencer (Eds.), *Making mathematics vital: (Proceedings of the 20th biennial conference of the Australian Association of Mathematics Teachers*, pp. 20-34). Adelaide: AAMT.
- Wiliam, D. (2008). *More about formative assessment*. Retrieved from www.kcl.ac.uk/ssp/education/research/iccamsfa.html

I liked it till Pythagoras: The Public's Views of Mathematics²⁶

Gilah C. Leder

Monash University

<gilah.leder@education.monash.edu.au>

Helen J. Forgasz

Monash University

<helen.forgasz@education.monash.edu.au>

Gender differences in mathematics learning have attracted sustained attention in Australia and internationally. Over time, female participation in academic fields and careers long considered male domains has improved. Yet recent mathematics achievement data reveal that gender gaps favouring males appear to have re-opened. In our study we explored the Victorian general public's views on gender issues and school mathematics. In general, boys were considered to be better at mathematics than girls, that is, vestiges of the male mathematics stereotype persist.

Prologue

The new focus on nature seems to be encouraging parents to indulge in sex differences even more avidly.... From girls' preschool ballet lessons and makeovers to boys' pee-wee football... the more we parents hear about hardwiring and biological programming, the less we bother tempering our pink and blue fantasies. (Freeman-Greene, 2009, p.11)

Twenty years have passed since the Victorian (Australia) state government conducted a state-wide media campaign, Maths Multiplies Your Choices, to encourage parents to think more broadly about their daughters' careers. Success in mathematics, it was emphasized, often serves as a critical filter to career and employment opportunities. Sex segregation of the labour market, while common, should not be viewed as inevitable. The success of the campaign was measured both directly – many schools subsequently reported an increase in girls' enrolments in mathematics subjects once they were no longer compulsory – and indirectly. A market research company was employed to explore parents' attitudes to their daughters' education and career before and after the campaign (McAnalley, 1991). Since then, in Victoria, there has been no concerted attempt to measure the general public's views about mathematics learning and the role of mathematics in determining males' and females' career options. In this paper we focus directly on this topic.

Providing a Context

Gender Differences in Mathematics Achievement

Publication of student achievement data from large scale testings seems to ensure that gender differences in mathematics learning continue to attract sustained attention from both the research and broader communities, in Australia and internationally. For example, performance data from the National Assessment Program for Literacy and Numeracy tests [NAPLAN] introduced Australia-wide in 2008, and results for Australian students in the two most recent Trends in International Mathematics and Science Study [TIMSS] tests, illustrate that small but identifiable gender differences in mathematics achievement persist.

NAPLAN results for students at all relevant grade levels are shown in Table 1. These results are given considerable media prominence on their release, for “each year, over one million students nationally sit the NAPLAN tests, providing students, parents, teachers,

²⁶ We thank Glenda Jackson and Calvin Taylor for gathering the raw data reported in this paper and for the financial support provided by the Faculty of Education at Monash University.



schools and school systems with important information about the literacy and numeracy achievements of students” (NAPLAN 2009, p. 2). Media reports of performance, including gender differences, often contain simplified summaries of complex data (Forgasz, Leder, & Taylor, 2007). This is not altogether surprising, given reporters’ time and space constraints. That such media accounts often shape and sway public opinion, including views on gender issues, is well documented (e.g., Barnett, 2007; Jacobs & Eccles, 1985).

Table 1
2008-2009 NAPLAN Mean Scores for Grades 3, 5, 7, and 9 - Mathematics

Year	2008		2009	
	M	F	M	F
3	400.6	393.1	397.5	390.2
5	481.6	469.9	492.6	480.6
7	552.3	537.3	549.1	538.0
9	586.5	577.6	592.4	585.6

The most striking feature of the data in Table 1 is undoubtedly the large overlap in the performance of males and females. However, it is also apparent that males consistently outperform females. Similarly, despite much overlap in the performance of females and males on the TIMSS tests, small gender differences in mathematics achievement persist. For the TIMSS 2003 testing, mean scores for males in grade 3 were 3 points higher than those of females; in 2007 they were 6 points higher. Corresponding data for the grade 8 sample were: 12 and 15 points higher for males than for females for the TIMSS 2003 and TIMSS 2007 testings respectively (Thomson, Wernert, Underwood, & Nicholas, 2008).

Possible Explanations

Multiple explanations have been put forward for the continuing gender differences in mathematics achievement. After a detailed review of relevant literature, Halpern et al. (2007) concluded that reasons for the overlap and differences in the performance of males and females were multifaceted, and not able to be explained by a single factor and that “[e]arly experience, biological constraints, educational policy, and cultural context” (Halpern et al., 2007, p. 41) could all play a part. Geist and King (2008) also referred to pervasive societal beliefs about gender linked capabilities and their impact:

Many assumptions are made about differing abilities of girls and boys when it comes to mathematics. While on the 2005 NAEP girls lag only about 3 points behind boys, this is only a recent phenomenon. In the 1970’s, girls actually outperformed boys in all but the 12th grade test.... assumptions about differing levels of ability pervade not just the classroom, but home. (pp. 43-44)

In their detailed model of achievement motivation, and implicitly of academic success, Wigfield and Eccles (2000) highlighted the influence on students’ learning and behaviours not only of learner-related variables but also of the overall context in which learning occurs, that is the attitudes, actual and perceived, of critical “others” in students’ homes and at school, and societal expectations more generally.

Societal Expectations - Public Views about Mathematics

Attempts to measure directly the general public’s views about mathematics, its teaching and its impact on careers are rare. As noted above, this was last done in Victoria

some 20 years ago. (The cumbersome process to obtain approvals for this study, summarised later in the paper, may help explain the scarcity of such research.) A decade ago Sam and Ernest (1998, p. 7) noted that, “there are relatively few systematic studies conducted on the subject of myths and images of mathematics. We need an answer to the question: What are the general public’s images and opinions of mathematics?” Responses to two items framed their subsequent discussion on this topic. Lucas and Fugitt (2007) similarly argued that the public’s views on mathematics and mathematics education were rarely sought. Yet, they found that people (Mid-West USA residents) responding to their 10-item survey were generally interested in, and often well informed about, the way mathematics was taught in schools. The respondents generally believed that a good mathematics education offered young people a better and successful future; schools failed to offer effective mathematics education because too much emphasis was placed on technology and not enough on the basics; teachers often exerted too much pressure and criticism to the detriment of their students’ attitudes to mathematics; and teachers should make learning mathematics more enjoyable. Issues such as these were also explored in the study reported in this paper.

The Study

Aims

The study’s overall aim is expressed concisely in the excerpt, provided below, of the “explanatory statement” needed to be prepared as part of the ethics approval process²⁷. As required, a copy of this statement was given to participants.

We have stopped you in the street to invite you to be a participant in our research study. ...We are conducting this research, which has been funded by [our] University, to determine the views of the general public about girls and boys and the learning of mathematics. We believe that it is as important to know the views of the public as well as knowing what government and educational authorities believe.

To set the scene for our survey, in our first question we asked participants whether they had seen the recent TV advertising campaign *You Can do Maths*, an Australian Association of Mathematics Teachers [AAMT] initiative that “encourages all young people and their families to appreciate the important role mathematics plays in many careers and everyday life” (youcandomaths, 2008)²⁸. Although few respondents (13%) remembered seeing the material, and a further 3% were unsure, the item proved a productive starting point.

Method

Data were gathered at a number of heavy foot-traffic sites in the metropolitan area of Melbourne (two main sites), in a large regional centre, and in a rural city. One morning or

²⁷ In addition to obtaining overall ethics approval, separate requests needed to be made to the councils involved. One council, claiming that they were “already over committed with Charities”, refused our request. While more helpful, others stipulated the precise sites for our data collection, required proof of public liability insurance cover by our “employer”, insisted we have a copy of the approval letter with us during data collection, and asked for an assurance that we would collect and bin any paper work handed out if subsequently dropped on the footpath. A startling range of council officers handled our request: “Manager of Animal Administration Compliance and Response”; “Manager – Traffic and Local Laws”; “Director Community Relations”; “Director Corporate Services”; and “Director of Major Projects”.

²⁸ Winners of a competition to write further scripts for the campaign were announced at about the time we conducted our survey (see e.g., <http://www.youcandomaths.com.au/press-release-nurse.php>)

afternoon (about four hours) was spent at each location. Our goal was to have 50 completed surveys at each site, a minimum number considered adequate for data to be analysed using chi-square tests (Muijs, 2004).

Sample

The public survey sample thus comprised diverse groups located in different parts of the state. The overall sample size was 203: 95 males and 108 females. Of these, 35 were under 20, 90 were aged between 20 and 39, 45 between 40 and 59, and 33 over 60.

The Instruments

To ensure maximum cooperation from those we stopped in the street, we limited our survey to 15 questions. In addition, however, we asked details about age (under 20, between 20 and 39, between 40 and 59, and over 60), and noted whether the respondents were male or female. Further, as well as the readily code-able responses such as “yes”, “no”, “don’t know”, “boys”, “girls”, “the same”, respondents were encouraged to elaborate and explain the reason for their answer; the comments were manually recorded by those administering the public survey. To comply with MERGA paper space constraints, we limit our discussion to items which focused on mathematics, omit those concerned with computers, and list the survey items only as part of the presentation of the results. Selected but representative explanations given by interviewees for their answers are also provided.

Results

When you were at school did you like learning mathematics?

More (129: 63.5%) indicated they had liked mathematics than those who had not (67: 33.0%). The rest (7: 3.4%) were ambivalent. Chi-square tests revealed no statistically significant difference by respondent age or gender (though proportionately more males than females stated they had liked mathematics, ($\chi^2 = 5.099$, $df = 2$, $p < .08$)). Comments included:

In the early years, yes. Later things went horribly wrong. I had a disastrous teacher.

Yes, I liked mathematics. I had good teachers. This is crucial. I was lucky.

I liked it till Pythagoras and letters meant numbers.

I liked it till year 10.

NO! I hated it.

Were you good at mathematics?

Again more respondents (124: 61.1%) claimed that they had been good at mathematics than those who did not (54: 26.6%). Approximately one quarter (24: 11.8%) considered they had been average. Chi-square tests revealed statistically significant differences by respondent gender: more males than females indicated that they had been good students. ($\chi^2 = 9.442$, $p < .05$, $df = 3$. Effect size (ϕ) = .22), but not by age. Explanations included:

I was good at Primary school but I went down in high school.

I'm much better since I left school.

I learnt enough to manage at work.

I was a champion at tables but no good once we got to Pythagoras.

Has the teaching of mathematics changed since you were at school?

Almost half (98: 48.3%) thought mathematics had changed since they had been at school; fewer (84: 41.4%) said they did not know. The rest (21: 10.3%) thought there had been no changes. Some believed the changes had been for the better:

It's easier now. Teachers explain a lot more.

It's better now. In the past you had to learn the work. Now you can ask questions.

There is more use of computers – I hope that's better. But enough time should be spent on mathematics.

Others were more critical:

I imagine that things have changed. For example, now there are electronics and scientific calculators. It's bad. Students don't know how things happen. They just punch in a formula and that's it.

Mathematics is too computerized now.

Probably things have changed. But people don't seem to be able to do much without calculators. My daughter is lazy now with computers.

Chi-square tests revealed statistically significant differences in responses to this question by age ($\chi^2 = 51.514$, $p < .001$, $df = 6$. Effect size (ϕ) = .50), but not by gender. Those in the older two age groups, that is, those aged 40 and over were more likely to say that mathematics teaching had changed; those in the younger two age groups that they did not know.

Should students study mathematics when it is no longer compulsory?

Almost two-thirds (129: 63.5%) of the respondents agreed that students should continue with the study of mathematics, fewer (52: 25.6%) disagreed, and the rest (22: 10.8%) had no clear opinion about this. Chi-square tests revealed no statistically significant differences by respondent gender or age. Again, the additional comments were informative:

No, not if the choice is between language or mathematics.

No, everyone uses calculators at work.

Absolutely. It opens up a lot of career paths and shuts doors if you don't.

Depends on their interests and what they want to do.

Who is better at mathematics, girls or boys?

Just under half (88: 43.3%) of the respondents thought boys and girls were equally good at mathematics; 17% were unsure. Of the remainder more than half thought boys were better (53: 26.1%); fewer believed girls were better (26: 12.8%). Reasons given included:

Boys are always better at mathematics. Girls are good at English.

Boys are better. They like to figure things out.

Girls are better. They can multi-task.

Girls are better in junior school and boys are better in senior school.

Depends on the individual, on their interest. Whichever one spends more time.

Chi-square tests revealed no statistically significant differences in responses to this question by respondent gender or age.

Do you think this has changed over time?

Many respondents (82: 40.4%) thought there had been no change over time.

No, still boys. They are engineered towards mathematics – it's a society thing.

Boys still – it's cultural.

Almost as many (73: 36.0%) were uncertain or ambivalent.

I don't know - I have a son. Boys used to be more competitive but now it seems to be girls.

In Primary school, girls are better. But when they grow up - men are good at mathematics, more so than girls.

The remainder (48: 23.6%) considered that this (whether boys or girls were better) had changed.

Yes. I think it used to be boys. Women now seem more interested in getting educated and going to university.

Girls. Expectations for girls have lifted. They are taking up more mathematics subjects.

Girls now are better. Maybe it is because girls study more, are disciplined and so now achieve the same as boys.

There were no statistically significant differences in responses by gender or age.

Who do parents believe is better at mathematics, girls or boys?

Few (27: 13.3%) thought that parents considered girls to be better. More than double (59: 29.1%) thought parents assumed boys would be better. Similar proportions thought parents believed boys and girls to be the same (65: 32.0%) or stated that they did not know or that it depended on other factors (52: 25.6%). Chi-square tests revealed no statistically significant differences in responses to this question by respondent gender or age.

My parents think boys. But girls and boys are the same I think.

It's changing. It used to be boys.

No difference. Mum goes on about equality.

Girls. I have three daughters. It's a silly question.

Who do teachers believe is better at mathematics, girls or boys?

There were few differences assigned by respondents to the beliefs of parents and teachers. The majority stated either that they did not know (68: 33.5%) or that teachers would expect no differences (63: 31.0%). More (44: 21.7%) nominated boys than girls (28: 13.8%) as being better. Differences in responses by gender or age were not statistically significant.

Boys in my time.

Girls of course, because it's easier to teach and explain to females.

I hope no difference. Teachers are supposed to be impartial.

If you ask my wife she would say boys.

Do you think studying mathematics is important for getting a job?

A clear majority (150: 73.9%) answered in the affirmative.

It's one of the criteria they, that is employers, look at.

It's essential. We all need basic knowledge of numbers.

All jobs have some element of maths.

It's a necessary skill everyone needs. Maths is involved in everything even if people don't realise it.

About the same number disagreed (28: 13.8%) or did not know or were ambivalent (25: 12.4%). Their responses included:

No, it is not vital for all jobs.

Depends on the job – yes if it is relevant. But mathematics teaches logic.

There were no statistically significant differences in responses by gender or age.

Is it more important for girls or boys to study mathematics?

Almost all the respondents (188: 92.6%) considered that it was equally important for boys and girls to study mathematics. Of the remainder, more (9: 4.4%) considered the subject to be more important for boys, very few (3: 1.5%) nominated girls and an equally small number (3: 1.5%) had no clear opinion. There were few elaborated answers. Most of those interviewed felt they had clarified their beliefs in answering previous items.

Chi-square tests revealed statistically significant differences in answers to this question by gender, with proportionately more females stating it was equally important and more males nominating boys ($\chi^2 = 10.563$, $p < .05$, $df = 4$. Effect size (ϕ) = .23), but not by age.

Discussion

The emphasis in our survey was on school mathematics – a subject on which the participants were certainly prepared to reflect. Most, and proportionally more males than females, had apparently liked mathematics at school and thought they had been good, or at least average, in the subject. Older participants were more likely to believe that mathematics teaching had changed since their time at school; younger respondents said that they did not know. From the comments reproduced, and others not listed in the paper, there appeared to be greater concern that technology use had a negative rather than a positive effect on mathematics learning. Participants in Lucas and Fugitt's (2007) study expressed similar fears about the influence of technology on mathematics teaching and learning. The public's beliefs captured in that project about the value of mathematics for future living and careers was mirrored in our study, as was the importance attributed to teachers, who were often mentioned as reasons for having liked or disliked mathematics at school.

Answers to items with a specific focus on boys' and girls' learning of mathematics revealed that many, both males and females, rejected the view that gender is a factor influencing mathematics performance. Nevertheless, there was still a substantial proportion of those surveyed who continued to think that boys were better than girls at mathematics, or were thought to be better, by their parents and teachers. Thus vestiges persist in contemporary society in Victoria, and presumably more widely, with respect to gender stereotyping about mathematics learning and the outcomes of that learning.

Clearly, the design of our study does not allow a direct causal effect to be drawn between the views of the public gathered in this study and the small but persistent gender differences in performance reported in large scale tests of mathematics achievement such as those described earlier in the paper. However, the opinions gathered should not be set aside or trivialised, unless of course, assumptions are made that they do not affect, however subtly, the career aspirations and developing views about mathematics of young people as they grow up in their homes, learn in their schools, mix with their peers, and are exposed to the perspectives and media portrayals of the wider societies in which they live.

The findings strongly suggest the ongoing need to explore, more intensively and extensively, the views of all ‘critical others’ in the lives of students, including the general public, who may influence their future educational and career directions.

References

- Barnett, S. M. (2007). Complex questions rarely have simple answers. *Psychological Science in the Public Interest*, 8(1), i-ii.
- Forgasz, H. J., Leder, G. C., & Taylor, C. (2007). *Research versus the media: Mixed or single-gender settings?* Paper presented at the annual conference of the Australian Association for Research in Education. Retrieved April 27, 2008 from <http://www.aare.edu.au/07pap/for07148.pdf>.
- Freeman-Greene, S. (2009, 7 Nov.). Boys will be boys, but only if we make them. *The Age*, Insight p. 11.
- Geist, E. A., & King, M. (2008). Different, not better: Gender differences in mathematics learning and achievement. *Journal of Instructional Psychology*, 35(1), 43-52.
- Halpern, D. F., Benbow, C. P., Geary, D. C., Gur, R. C., Hyde, S. H., & Gernsbacher, M. A. (2007). *Psychological Science in the Public Interest*, 8(1), 1-51.
- Jacobs, J. E., & Eccles, J. S. (1985). Gender differences in math ability: The impact of media reports on parents. *Educational Researcher*, 14(3), 20-25.
- Lucas, D. M., & Fugitt, J. (2007, May). *The perception of math and math education in the rural Mid West*. Appalachian Collaborative Centre for Learning, Assessment, and Instruction in Mathematics. Working Paper No. 37. Retrieved January 10, 2010 from http://www.eric.ed.gov/ERICDocs/data/ericdocs2sql/content_storage_01/0000019b/80/33/5b/c3.pdf.
- McAnalley, K. (1991). Encouraging parents to stop pigeon-holing their daughters: The “Maths Multiplies Your Choices” campaign. *Victorian Institute of Educational Research Bulletin*, 66, 29-38.
- Muijs, D. (2004). *Doing quantitative research in education with SPSS*. London: Sage Publications.
- NAPLAN (2009). *NAPLAN. Achievement in reading, writing, language conventions and numeracy*. Retrieved December 23, 2009 from http://www.naplan.edu.au/verve/resources/NAPLAN_2009_National_Report.pdf.
- Sam, U. C., & Ernest, P. (1998, Feb. 28). *A survey of public images of mathematics*. Paper presented at British Society for Research into Learning Mathematics. Retrieved January 22, 2010 from <http://www.bsrlm.org.uk/IPs/ip18-12/index.html>
- Thomson, S., Wernert, N., Underwood, C., & Nicholas, M. (2008). *TIMSS 07: Taking a closer look at mathematics and science in Australia*. Melbourne: ACER.
- Wigfield, A., & Eccles, J. S. (2000). Expectancy–value theory of achievement motivation. *Contemporary Educational Psychology*, 25, 68–81.
- Youcandomaths. (2008). Retrieved January 22, 2010 from <http://www.youcandomaths.com.au/index.php>

Examinations in the Final Year of Transition to Mathematical Methods Computer Algebra System (CAS)

David Leigh-Lancaster
Victorian Curriculum and Assessment Authority
<leigh-lancaster.david.d@edumail.vic.gov.au>

Magdalena Les
Victorian Curriculum and Assessment Authority
<les.magdalena.m@edumail.vic.gov.au>

Michael Evans
Australian Mathematical Sciences Institute
<michael@amsi.org.au>

2009 was the final year of parallel implementation for Mathematical Methods Units 3 and 4 and Mathematical Methods (CAS) Units 3 and 4. From 2006-2009 there was a common technology-free short answer examination that covered the same function, algebra, calculus and probability content for both studies with corresponding expectations for key knowledge and key skills. There was also separate technology-assumed examinations comprising common and different multiple choice and extended response questions. In 2009 the two cohorts were of similar size, comprising 7000-8000 students each. This paper analyses student performance for both cohorts with respect to these common items.

From 2006 to 2009 Mathematical Methods Units 1-4 and Mathematical Methods (CAS) Units 1-4 were implemented as parallel and equivalent Victorian Certificate of Education (VCE) mainstream function, algebra, calculus and probability studies. An approved graphics calculator, and an approved CAS were the respective assumed enabling technology. Units 3 and 4 are typically studied in Year 12, and have end-of-year examinations. There was a common one-hour short answer technology-free examination and a two-hour multiple choice and extended response technology-assumed examination. The latter had many common questions and some distinctive questions. In 2009 all students undertaking the mainstream function, algebra, calculus and probability study in Victoria enrolled in Mathematical Methods (CAS) Units 1 and 2 in preparation for the final stage of transition to the to CAS enabled study at Units 3 and 4 in 2010.

The areas of study and outcomes for Mathematical Methods (CAS) encompass those of Mathematical Methods (hereafter referred to as MMCAS and MM respectively) and incorporate common specification of key knowledge and key skills in relation to mental or by hand approaches to mathematical routines and procedures. Thus the common technology-free examination is based on content from the areas of study for MM in relation to Outcome 1: “On completion of each unit the student should be able to define and explain key concepts as specified in the content from the areas of study, and apply a range of related mathematical routines and procedures”. In particular the elaborating key knowledge and key skill statements for this outcome clearly indicate expectations for knowledge, such as exact values for circular functions, and by hand skills, such as differentiation of combined functions using chain, product and quotient rules.

Researchers such as Kokol-Voljc (2000); Brown (2003); Flynn (2003) and Ball and Stacey (2007) have, over the past decade, considered various aspects of assessing mathematical capabilities via examinations where students choose to use mental, by hand or technology assisted approaches, or a combination of such approaches, to tackle a range of questions, as noted by, for example Evans, Jones, Leigh-Lancaster, and Norton (2008). To the best knowledge of the authors, the Victorian parallel implementation of MMCAS and MM is a unique context within which the achievement of two senior secondary



certificate student cohorts comprising like but distinct populations of substantial size can be considered with respect to common assessment instruments and items. While other systems and jurisdictions around the world have also employed a technology-free and technology-active examination structure where the use of CAS is permitted (for example, the College Board *Advanced Placement Calculus AB and BC Program*) or assumed (for example, Danish *Baccalaureat Mathematics*) these systems and jurisdictions have not, to our knowledge, undertaken collection and publication of large scale data of a like kind.

Mean Performance on Items from Examination 1 2006-2009

In 2009, the common one-hour technology-free Examination 1 (VCAA 2009a) comprised 16 items receiving credit or partial credit (that is a question or part of a question allocated one or more marks), with a total of 40 available marks. A simple comparison of the mean scores can be made from the respective 2009 MM and MMCAS Assessment Reports (VCAA, 2009b, 2009c)

Mean score data on Examination 1 over the period 2006-2009 indicates that, in general, the MMCAS cohort performed at least as well as the MM cohort. In particular, for 2009, the distribution of student scores for each cohort across the mark range from 0 to 40 shows that at the very top end of the mark range the performance of the two cohorts is essentially identical; at the very bottom end the performance of the MMCAS cohort tends to be better (with some ‘noise’), while from the low to high mark range the MMCAS cohort consistently achieves a slightly higher score than the MM cohort. This pattern persists when the data is factored for general mathematical ability using the mathematics, science and technology (MST) component of the General Ability Test (GAT), conducted in the middle of the same year, as a control for ability. It should be noted that the MST component of the GAT has only a moderate positive association with study VCE Mathematics achievement, and is hence a partial indicator of study specific mathematical ability.

Performance by Item on Examination 2 in 2009

Examination 2 has the same structure for both MM and MMCAS, comprising a collection of 22 multiple choice questions worth a total of 22 marks, and four extended response questions each of several parts (with partial credit available) worth a total of 58 marks. For both components there are around 70% to 80% common items. These are either *technology-independent* (that is technology is not of assistance, for example a conceptual question) or *technology-active* but graphics calculator/CAS *functionality neutral* (for example a graphing or numerical equation solving question). In the following analysis performance on the common Examination 1 has been used as a control for ability with respect to performance on common multiple choice and extended response items for MM Examination 2 and MMCAS Examination 2.

Common Multiple Choice Questions in 2009

There were 17 out of 22 common multiple choice items the five different items in 2009 being questions 1, 4, 5, 12 and 18. Figure 1 shows the average score on 17 common items from Examination 2 for each Mathematical Methods Examination score out of 40.

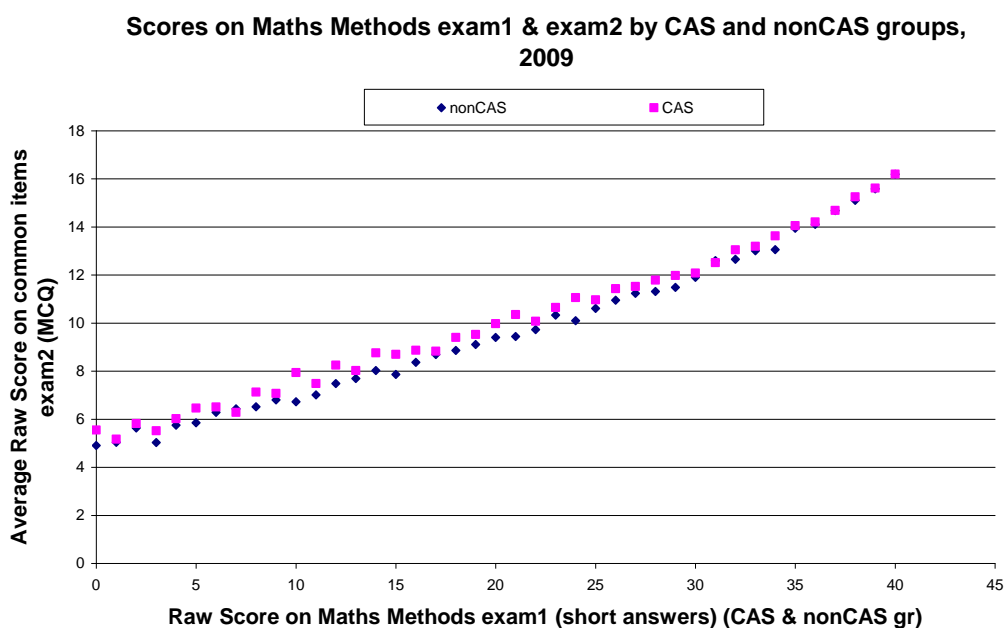

Figure 1. Average score with respect to Examination 1 (technology-free) score.

The largest difference of 1.2 score points occurs for the score of 10. The following histograms in Figure 2a and 2b provide an indication of how many students are in each data point in Figure 1 for MM and MMCAS cohorts respectively:

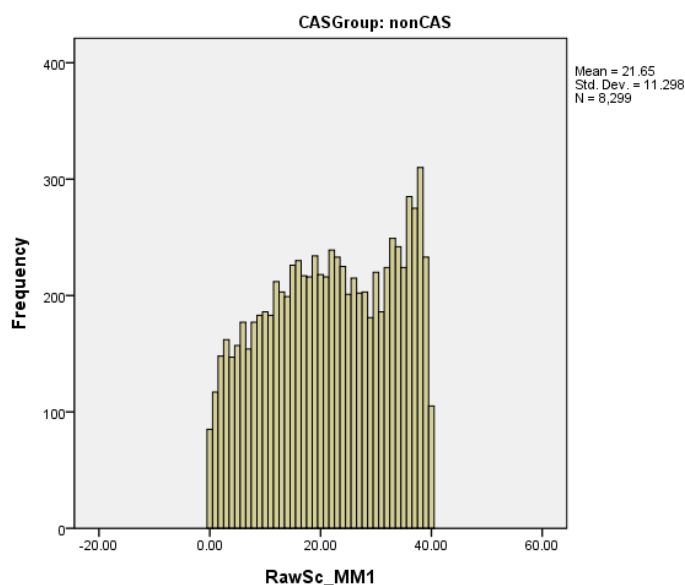

Figure 2a. Histogram for distribution of scores on MM Examination 1 in 2009.

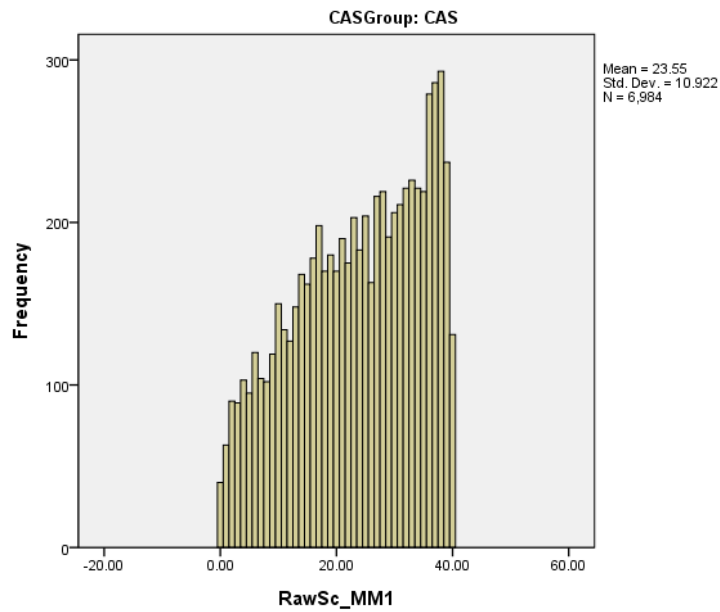

Figure 2b. Histogram for distribution of scores on MMCAS Examination 1 in 2009.

To compare MMCAS and MM cohort differences across Examination 2 multiple-choice items scores while controlling for the results on Examination 1, the Rasch two-dimensional regression model was applied, using *ConQuest* software. Figure 3 shows a comparison of mean raw scores on 17 common multiple-choice items while controlling for students' ability estimated on Examination 1.

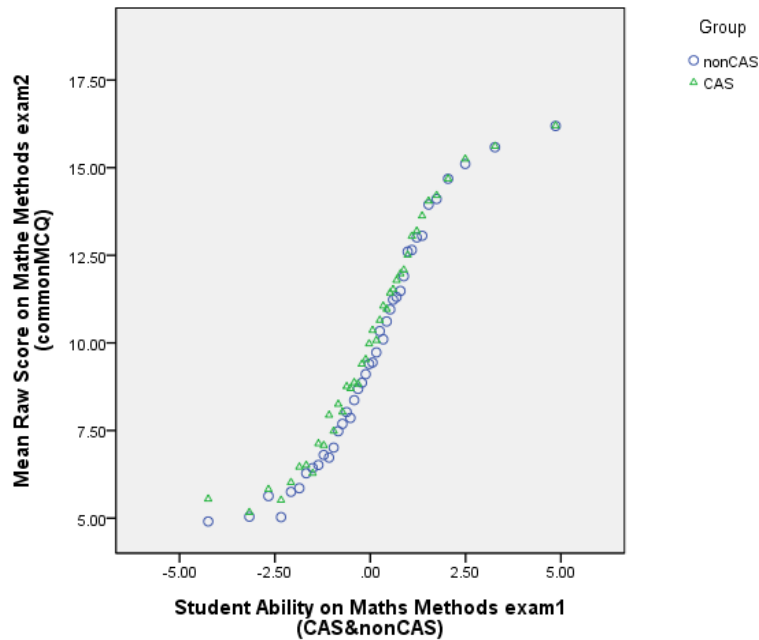

Figure 3. Comparison of student estimated ability (Examination 1) and expected score on common multiple-choice items (Examination 2).

It can be observed again from Figure 3 that the curves for CAS and non-CAS groups are very close, although the average score on common multiple-choice items for the MMCAS cohort is slightly above that for the MM cohort. The largest difference between the expected scores for those two groups is around 1.2 score points for ability close to -1.08 logit on Examination 1.

Common Extended Response Questions in 2009

The extended response component of Examination 2 comprised 32 items on the MM paper and 33 items on the MMCAS paper, with the same total score of 58 from this component for each paper. Of these items, 21 were common for a total score of 35 marks. There were also a range of similar, but not identical items, which have not been included in this analysis. Figure 4 shows the average score on the 21 common items from Examination 2 for each Mathematical Methods Examination score out of 40.

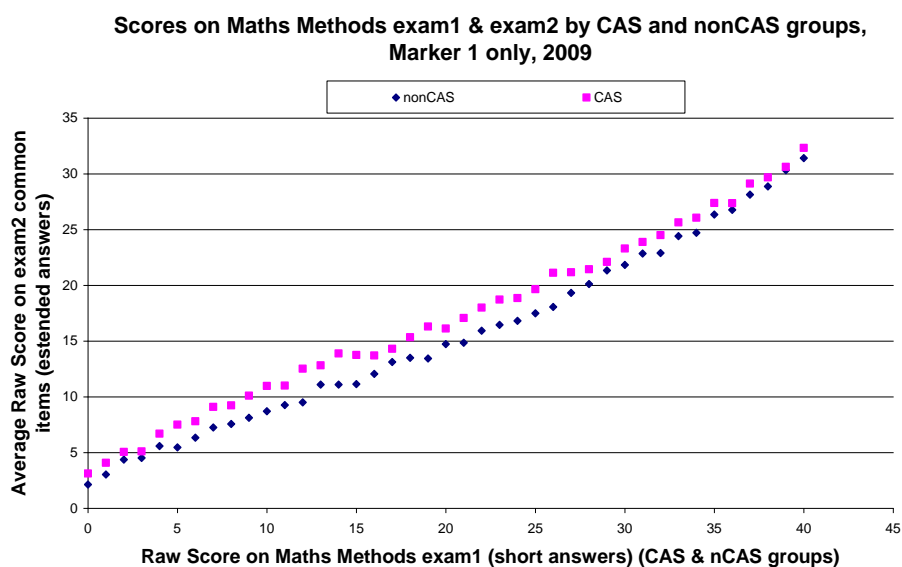

Figure 4. Average score with respect to Examination 1 (technology-free) score.

Figure 4 shows that the average score on Examination 2 common extended answer questions for the MMCAS cohort is slightly higher than that for the MM cohort, except at the very low and top end where the two curves almost overlap. The mean difference is less than 2 score points with the largest difference of 3.1 score points for the score of 26 on Examination 1. The following histograms in Figure 5a and 5b provide an indication of how many students are in each data point in Figure 1 for MM and MMCAS cohorts respectively:

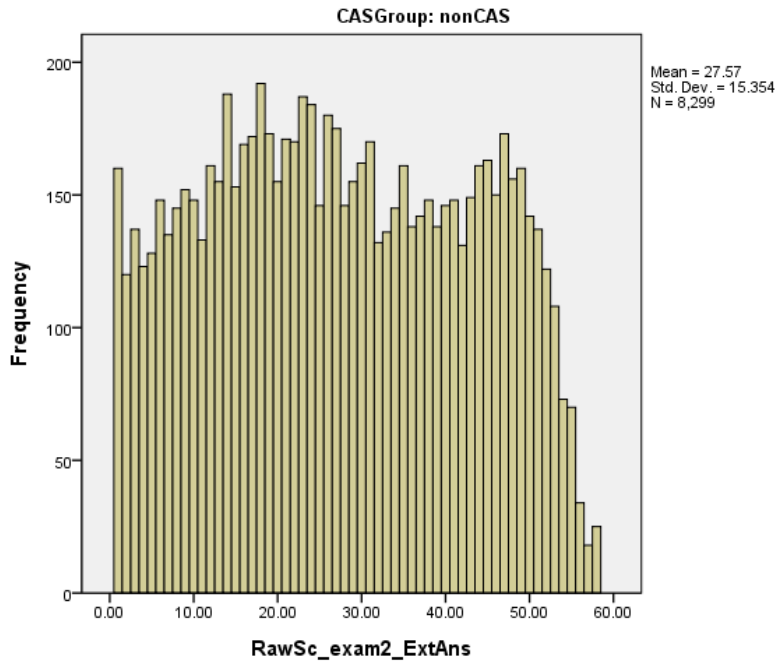

Figure 5a. Histogram for distribution of scores on MM Examination 2 in 2009 (all items).

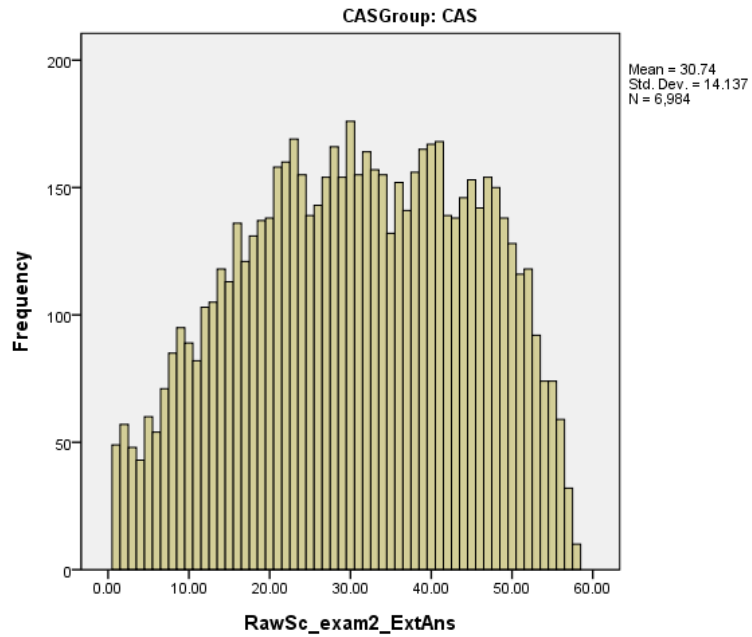

Figure 5b. Histogram for distribution of scores on MMCAS Examination 2 in 2009 (all items).

To compare MMCAS and MM cohort differences across Examination 2 multiple-choice items scores while controlling for the results on Examination 1, the Rasch two-dimensional regression model was applied, again using *ConQuest* software. Figure 6

shows a comparison of mean raw scores on 21 common extended response items while controlling for students' ability estimated on Examination 1.

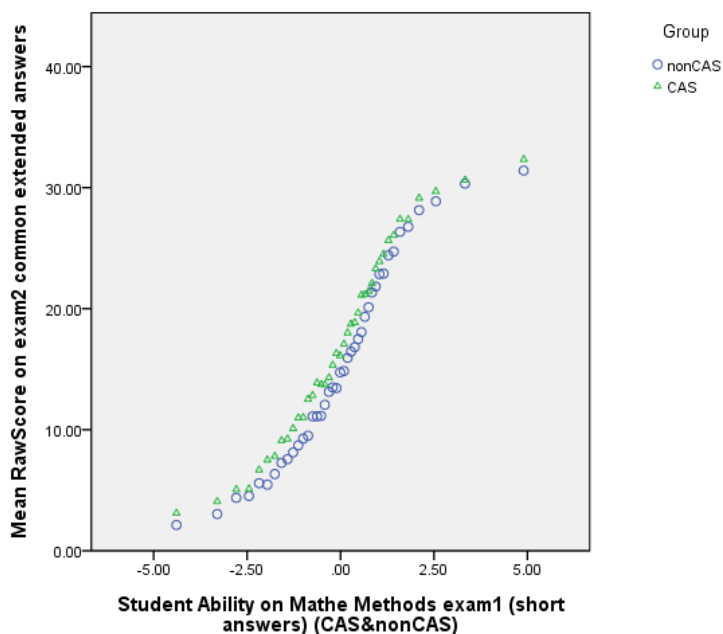

Figure 6. Comparison of student estimated ability (Examination 1) and expected score on common multiple-choice items (Examination 2).

It can be observed from Figure 6 that the curve for the MMCAS cohort is above that for the MM cohort except for the higher range of abilities where curves almost overlap. The largest difference between the expected scores on common extended responses, for those two groups, is around 3 score points for ability close to 0.56 logit on Mathematical Methods Examination 1.

Conclusions

Data from the 2009 *common technology-free* Examination 1 supports preliminary observations from earlier years of parallel implementation and indicates that, in general, the MMCAS cohort performed at least as well as the MM cohort with respect to the sorts of questions set for this examination. Such questions substantially cover expectations for traditional knowledge and mental and/or by hand skills related to the study of functions, algebra, calculus and probability. Similarly, data from *common* items (multiple choice and extended response) on the 2009 MM and MMCAS *technology active* Examination 2, also indicate that, in general, the MMCAS cohort performed at least as well as the MM cohort with respect to the sorts of questions set for this paper which substantially cover a combination of traditional knowledge and by hand skills, and the use of numerical and graphing graphics calculator/CAS functionality.

References

- Ball, L., & Stacey, K. (2007). Using technology in high-stakes assessment: how teachers balance by-hand and automated techniques. In Lim, C.-S., Fatimah, S., Munirah, G., Hajar, S., Hashimah, M.Y., Gan, W.L., & Hwa, T.Y. (Eds.) *Proceedings of EARCOME4 2007 4th East Asia Regional Conference on Mathematics Education*. (pp 90-97) Universiti Sains Malaysia, Penang, Malaysia.
- Brown, R. (2003). *Comparing system wide approaches to the introduction of Computer Algebra Systems into examinations*. Paper presented at the 3rd Computer Algebra in Mathematics Education. (CAME) Symposium, Reims, France.
- Evans, M., Jones, P., Leigh-Lancaster, D., Les, M., Norton, P. & Wu, M. (2008). The 2007 Common Technology Free Examination for Victorian Certificate of Education (VCE) Mathematical Methods and Mathematical Methods Computer Algebra System (CAS). In M. Goos, R. Brown & K. Makar (Eds.) *Navigating currents and charting directions* (Proceedings of the 31st annual conference of the Mathematics Education Research Group of Australasia, pp. 331-336). Brisbane: MERGA.
- Flynn, P. (2003). Adapting “Problems to Prove” for CAS-permitted examinations. *The International Journal of Computer Algebra in Mathematics Education*, 10(2), 103 -121.
- Kokol-Voljc, V. (2000). Examination questions when using CAS for school mathematics teaching. *The International Journal of Computer Algebra in Mathematics Education*, 7(1), 63 - 75.
- Victorian Curriculum and Assessment Authority. (2009a). *Mathematical methods written examination 1*. VCAA. Melbourne. Retrieved 22 March 2009 from:
<http://www.vcaa.vic.edu.au/vcaa/vce/studies/mathematics/methods/pastexams/2009/2009mm1-w.pdf>
- Victorian Curriculum and Assessment Authority. (2009b). *Mathematical methods examination 1 Assessment Report 2009*. VCAA. Melbourne. Retrieved 22 March 2009 from:
http://www.vcaa.vic.edu.au/vcaa/vce/studies/mathematics/methods/assessreports/2009/mm1_assessrep_09.pdf
- Victorian Curriculum and Assessment Authority. (2009c). *Mathematical methods (CAS) examination 1 Assessment report 2009*. Retrieved 20 March 2009 from:
http://www.vcaa.vic.edu.au/vcaa/vce/studies/mathematics/cas/assessreports/mmcas1_assessrep_09.pdf

A ‘knowledge quartet’ Used to Identify a Second-Year Pre-service Teacher’s Primary Mathematical Content Knowledge.

Sharyn Livy
Victoria University
sharyn.livy@live.vu.edu.au

This paper draws on observation of a primary mathematics lesson prepared and taught by a second-year pre-service teacher who lacked mathematical content knowledge. A ‘knowledge quartet’ (Rowland, Turner, Thwaites, & Huckstep, 2009) was used to investigate when and how a pre-service teacher drew on their knowledge of mathematics during primary teaching. Data were collected from field notes, audio recording of part of a lesson, and an interview with the pre-service teacher after the lesson. Discussion focuses on the four characteristics of the ‘knowledge quartet’: foundation, connection, transformation and contingency. Conclusions suggested that pre-service teachers need to continue developing their mathematical content knowledge to assist with future planning and teaching of primary mathematics lessons.

The following study was part of four-year longitudinal investigation of 17 pre-service teachers’ primary mathematical content knowledge, demonstrated during their Bachelor of Education (Prep-12). The relationship between practice, mathematical content knowledge, (MCK) and pedagogical content knowledge (Chick, Baker, Pham, & Cheng, 2006; Schulman, 1987) is the focus of this paper. Lisa’s case, a second-year pre-service teacher is presented. A four-part framework, the ‘knowledge quartet’ (Rowland et al., 2009) is used to map the relationship between her mathematical content knowledge with classroom practice. Lisa, a pre-service teacher with gaps in her MCK, was chosen to find out how the experience of planning and delivering a primary mathematics lesson demonstrated and/or enhanced her MCK and contributed to her awareness of pedagogical content knowledge.

During 2008, only 50% of the cohort ($N = 283$) of second-year pre-service teachers passed a Mathematical Competency, Skills and Knowledge Test (MCSKT). These pre-service teachers also taught in primary schools, on average once a week (30 days each year), in first and second-year for their practicum, known as their project partnership. Therefore half of the pre-service teachers were not necessarily prepared to engage with the mathematical content and the children in their primary practicum classrooms. This paper focuses on the interaction between Lisa’s practice and her MCK during part of a grade three primary mathematics lesson.

Mathematical Content Knowledge Needed for Primary Teaching

The literature suggests MCK needed for teaching is very complex consisting of many features. Knowing and using mathematics for teaching entails making sense of methods and solutions different from one’s own (Ball, Bass, & Hill, 2004). A teacher requires specialised content knowledge, more, not less mathematical knowledge than the average adult and this is unique to teaching (Ball, Thames, & Phelps, 2008).

Reynold’s (1992) review of the literature concluded that effective teachers connect what they know to new information and rely on their subject matter knowledge to create good lessons and explanations for their students. Ma (1999) describes a teacher’s deep knowledge of content as Profound Understanding of Fundamental Mathematics (PUFM), demonstrating breadth, depth, connectedness and thoroughness used for expressing



mathematical solutions. MCK is important and used widely by the teacher within the classroom. A teacher draws on content knowledge to promote students' mathematical reasoning (Ball et al., 2009). The Carpenter, Fennema, Peterson, Chiang and Loef (1989) study investigated teachers' use of knowledge when teaching. They believed students will construct knowledge when the teacher builds on their students' existing knowledge, by adapting instruction to suit students' needs.

Schoenfeld and Kilpatrick (2008) described proficient teachers of mathematics as having many characteristics. One was the ability to use their knowledge of maths in ways to provide the tools to instil understanding or help students with misunderstandings. Teachers implement mathematical knowledge, drawing on: procedural knowledge, procedural fluency, conceptual knowledge and mathematical connections (Ball, 2003; National Curriculum Board, 2009). They demonstrate a broad understanding of the mathematical horizon linking their content knowledge with curriculum content and making connections between them (Ball et al., 2009). It is hoped that primary teachers develop their knowledge of content so they possess knowledge of the mathematical horizon and are aware of the range of strategies students will bring to mathematical tasks (Sullivan, Clarke, & Clarke, 2009).

The 'knowledge quartet'

Rowland and colleagues (2009) developed the 'knowledge quartet' framework to support beginning teachers. During a mathematics lesson, the teachers' actions were identified and recorded by an observer to provide feedback relating to the use of their MCK. There were many ways of looking at describing how the teachers used their MCK. The 'knowledge quartet' (Rowland et al., 2009) classified these into four 'big ideas' or dimensions: foundation, transformation, connections and contingency (Figure 1).

<p>Foundation Is the knowledge a teacher brings to teaching, their content knowledge and beliefs about mathematics.</p>	<p>Transformation Is the choice of examples and representations the teacher uses, focusing on the teachers' knowledge in action.</p>
<p>Connection Identifies coherence and knowledge of the sequence of the topics from lesson to lesson and within the lesson.</p>	<p>Contingency How a teacher responds to a student's unexpected method or comment.</p>

Figure 1. The codes of the 'knowledge quartet' and description for each category (Rowland et al., 2009).

Methodology

Lisa, who was not successful with passing a MCSKT, was selected from a larger longitudinal study because she was similar to half of her second-year cohort. At the time of the study Lisa was 20 years of age, she was enjoying her project partnership experiences and wanted to teach in a primary school on graduation. Prior to the observation reported in this paper she had taught ten mathematics lessons under the supervision of her mentor teacher. Lisa planned the activities presented to the students for the lesson this study is based on.

The study used a qualitative method to analyse the introduction of one primary mathematics lesson during her second-year. The researcher observed the lesson taking field notes. A digital voice recorder was used to record the lesson, which was later transcribed

for analysis. The researcher interviewed Lisa following the lesson, reflecting on her teaching. The interview was also digitally voice recorded and later transcribed.

Lisa's lesson was observed at her project partnership placement, towards the end of second-year, with twenty grade three students from a Catholic primary school. While Lisa taught the lesson, the students were seated at their tables, towards the front of the classroom. The researcher sat at the back of the classroom and did not interact with Lisa or the students during the lesson. The mentor teacher sat at her desk (to the side) and observed the lesson, occasionally interacting with the discussion.

The lesson took 60 minutes to complete. The introduction (i.e., the first 20 minutes) focused on subtraction of two-digit numbers and was used for analysis and discussion for this paper. The interview, after the lesson with Lisa and the researcher, took 40 minutes. The interview questions related to the lesson and other components of the longitudinal study, some interview data was used for this study.

Field notes, the transcription of the lesson introduction and interview were colour coded and matched with Rowland's et al., (2009) four categories from the 'knowledge quartet' (Figure 1). The four categories; foundation, connection, transformation and contingency were discussed with reference to Lisa's lesson to investigate when and what MCK had been demonstrated during the mathematics lesson.

Lesson Synopsis

Lisa's Grade 3 Subtraction Lesson

Lisa settled the students while they were seated at their tables. She stood at the front of the classroom introducing the lesson to the class demonstrating on the whiteboard. She commenced with a bingo game followed by a discussion that focused on drawing and using a subtraction ladder; this section lasted 20 minutes.

The students were asked to select their own numbers from zero to 20 for a three-by-three bingo grid they drew into their workbooks. Detailed instructions were not provided and it was assumed students knew the rules.

Lisa: So we all know how to play bingo? As soon as you get three in a row, you can yell out bingo if you like. We are going to do subtraction problems. How you work it out it is up to you. If you want to use some scrap piece of paper and write it out you can do that or if you want to do it mentally, you might count by twos or fives. If you need to draw a number line you can do that.

Lisa tried to suggest to the students some strategies they could use for their subtraction facts. She did not explain what she meant by "count by twos or fives... draw a number line..." Lisa proceeded to ask subtraction basic facts between zero and twenty while the students located the answers on their bingo grid. After Lisa said one problem she asked a student for the answer, checking as the class completed the game.

Lisa: "Twenty-eight take away eight, Isabel?"

Isabel: "Twenty."

Lisa: "Beautiful!"

For each question, a different student was asked to answer, and Lisa recorded correct responses next to the problem on the whiteboard. Lisa chose the following questions for the students to answer and find on their bingo board: $20 - 8 =$, $14 - 2 =$, $14 - 4 =$, $28 - 8 =$, $8 - 3 =$.

For the main activity, Lisa drew a subtraction ladder onto the whiteboard. (She adapted an idea from a maths book her mentor had shown her.)

Lisa said, “Here is a subtraction ladder, you have probably never seen this before. We are going to make this work downwards... The first number is going to be ten and I want to put 5 here (the numbers were placed in the first and third spaces). I want you to tell me, what subtraction problem I can make to put a number in between? What is a number between ten and five?”

Olivia: “Eight.”

Lisa: “What do I do to get from ten to eight, what subtraction problem?”

Darcy: “Ten take away two.”

Lisa: “Who knows how to work that out?”

Lisa continued to work through this method placing a number into the ladder making it the difference. Then she used the number above it as the minuend to work out the subtrahend. Finally, she recorded the subtraction problem to the side. Figure 2 provides a copy of the subtraction ladder at the beginning of the discussion as well as the completed ladder at the conclusion of the discussion.

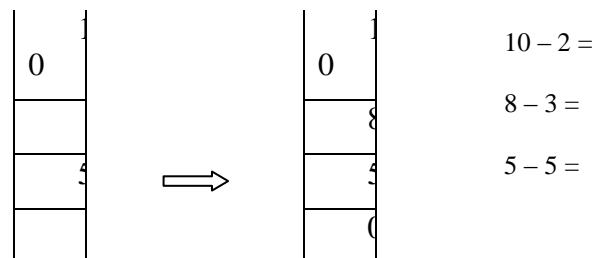

Figure 2. A copy of subtraction ladder at the beginning of the discussion and the same subtraction ladder as illustrated on the whiteboard after the discussion with the students.

Once the first ladder was completed Lisa suggested that these were pretty easy (Figure 2) and proceeded with a new example with larger numbers (Figure 3). For the second example she recorded the digits 50 and 35 into the ladder and asked the students to draw a ladder and use strategies to solve the problem.

Lisa said, “You need 50 at the top and 25 half way down the ladder ... What number might I put here?” (In the second space)

Darcy: “25.” (The student may have been thinking the difference between 50 and 25 is 25 but Lisa prompted a different number)

Lisa: “Maybe count by tens, 25.”

Darcy: “35.”

Lisa: “Yes. Do you maybe want to put 35 in here (she records 35 on whiteboard). OK, 50 take away 35. Write down or draw how you could solve that ... You can draw maybe apples. You might have 50 apples. That’s a bit hard. So you might group them... You might want to use a number line.”

Lisa then asked the students to think of a number to record in the last place on the ladder.

She said, “Could you put 40 in this box?”

Ben replied, “No.”

Lisa said, “Can we do 25 take away 40. No not really. Not properly. We need a number less than 25.”

The students were asked to copy the ladder (Figure 3) and write their own number into the last box of the ladder, before sharing their responses, for example 25 take away 10. The students then moved into three groups to complete further subtraction tasks to conclude the lesson.

50
35
25

Figure 3. A copy of the second subtraction ladder used for providing subtraction questions for the students.

Results and Discussion

Identifying the Principles that Lisa Knew

The lesson introduction and a selection of reflections from Lisa’s interview were further analysed, providing enough data to use with reference to the ‘knowledge quartet’ and the four dimensions; foundation knowledge, transforming knowledge, connection and contingency (Rowland et al., 2009). Discussion of the four categories of the knowledge quartet follows, focusing on Lisa’s MCK implemented during her teaching and reflections from part of an interview after the lesson.

Foundation: For delivery of the introduction of the subtraction lesson, Lisa provided evidence that she could solve 2-digit subtraction problems. The most difficult example was 50 take away 35, during the subtraction ladder task. It is likely Lisa learnt how to subtract 2-digit numbers, as a primary student herself. Lisa was able to listen to the students’ responses and knew the answers without needing to demonstrate her working out. Lisa most likely used a mental subtraction strategy in her head. Because Lisa answered the questions quickly, it could be assumed she was able to use known subtraction facts to work out her answers. This segment of the lesson shows that Lisa had the mathematical knowledge needed for solving a grade three level subtraction problem. It is hoped that she could solve subtraction questions needed for teaching higher grade levels, but this was not demonstrated during this lesson.

During her interview, Lisa thought she was “a bit rough” with her teaching of primary mathematics but felt that by the end of fourth-year she would be much more confident than she was now. She also explained that she felt her MCK was about average. Lisa provided the following reflection when asked to describe her own understanding of primary MCK:

My content is just passing. I think there is a long way to go. After today I know now I needed to do this and I needed to do that and then I will go home and then I will read about it or learn in different ways. Until you are thrown in and experience it, I don’t have an incentive to just read numbers ... I think I am just over average.

This reflection indicates that Lisa is aware she needs to improve her content knowledge but does not clearly articulate what she plans to learn or needs to know. Later in the interview, Lisa said she had a grade five text book she was going to use for revision.

Needing to revise a grade five textbook suggests Lisa currently lacks the content knowledge she would be expected to teach in the upper primary grades.

Connections: Lisa attempted to make connections during the lesson but without depth. She made reference to a previous lesson reminding students they had used a number line. During the interview Lisa vaguely suggested different subtraction strategies the students could use, for bingo, “write it out, do it mentally, count by twos or fives, or draw a number line.” She also mentioned these during her lesson when using the subtraction ladder, but did not elaborate, demonstrate examples or provide materials.

To facilitate student learning teachers need to promote learning by making explicit connections of mathematical topics (Ma, 1999). Booker, et al (2004) says that children will construct meaning by the experiences provided with materials, reflecting and talking about their ideas to promote mathematical discussion of various interpretations. Lisa was aware that students can select a range of strategies when completing subtraction problems. However, she did not demonstrate strategies in depth within her lesson to promote learning. Lisa needs to further extend students’ understanding of the different methods for finding solutions and incorporate these into her lesson to connect students’ knowledge of 2- digit problems as the students explore harder questions.

Lisa made up the questions as she took the lesson. There was no evidence of planning the problems to use with the students, or use of notes from a lesson plan. The questions Lisa selected were more suitable for younger students. The content presented may have not engaged all students in the class. Lisa needs to ensure that she prepares her lessons well, and caters for all learning needs of all students. Further teaching experiences will assist to build coherence of the sequence of topics from lesson to lesson or within the lesson. A teacher catering for all learners would target questions to assist weaker learners and provide harder items to challenge the fluent learners. This would also demonstrate if Lisa had the knowledge to scaffold the level of difficulty of the questions to cater for the range of abilities within her grade three class. She should prepare her questions before the lesson by referring to a sequence for developing the subtraction concepts (Booker et al., 2004, p. 226).

Transformation: There were issues with the use of the subtraction ladder. When Lisa presented her second examples of subtraction problems (Figure 3) she changed the recording structure when using the subtraction ladder. The lesson began with students using the digits in the ladder to record the minuend and difference of the problem ($10 - ? = 8$). This method was then switched using the digits to record the minuend and subtrahend ($50 - 35 = ?$). Lisa was not aware that the subtraction ladder may have been confusing by swapping a change unknown structure to a result unknown structure (Carpenter, Fennema, Franke, Levi, & Empson, 1999).

While Lisa focused on her invented procedures she provided no connections or steps that scaffolded the students’ understanding. The ladder was not an appropriate representation for modelling subtraction or difference concepts and was not useful for demonstrating procedures or mathematical thinking. During Lisa’s interview she explained, “The ladder was a strength of my lesson, which was better than writing up equations.” Lisa was more concerned about engaging the students by using a “game” and a different way of recording equations rather than focusing on mathematical connections.

During the lesson Lisa did not elaborate on the different student responses. Rowland et al., (2009) suggested in their study this could be because of time restraints or because it had been covered in a previous lesson or because the teacher did not have the confidence to

do so. Lisa may not have developed the confidence or skills needed for explaining different strategies elaborating on the students' methods, she could have demonstrated her skill in transforming her MCK. Listening to different students' strategies improves students' mathematical understanding and increases teachers' mathematical knowledge (Empson & Jacobs, 2008).

An inappropriate suggestion was made for solving, "50 take away 35... You can draw maybe apples". Story problems are used to introduce the subtraction concept. Students solving 2-digit problems should model, demonstrating their thinking in tens and extending their basic facts to ten, first without renaming, then with renaming (Booker et al., 2004). For example, the use of popsticks, bundles of tens and ones are used to develop 2-digit subtraction understanding before moving onto base ten materials.

Contingency: Within the lesson one misconception that arose was when Lisa spoke with Ben about whether 40 could be subtracted from 25 and her response was, "Not really". Her response was inappropriate, as $25 - 40 = -15$ and is a true mathematical statement. Maybe her response was affected by the awareness that this subtraction concept would not be introduced at this level and therefore would be too difficult to explain. Nevertheless, Ma (1999, p. 3) discussed a similar example believing that young students' future learning should not be confused by emphasizing a misconception. A better response from Lisa would have been to say, "Yes, it is possible and we can work on that later". Individually, Lisa could then chat with the student, providing an opportunity to explore the concept on a number line.

During the lesson there were no extending questions to challenge students. Lisa was able to respond to the students' comments and responses by asking closed questions requiring a one-word response. Open-ended questions with an open-ended answer would provide an opportunity for Lisa to further demonstrate her skills and knowledge of the topic. The question and answer approach during the lesson controlled the lesson format, ensuring the students were not diverted from her agenda and easy subtraction examples. Harder subtraction questions may have been difficult for Lisa to solve confidently while in front of the whole class.

Conclusion

Ma (1999) says that teachers can demonstrate a wide range of content knowledge, even with basic teaching of subtraction without regrouping. The use of the 'knowledge quartet' framework was able to identify that Lisa was not able to demonstrate a wide range of content knowledge during her lesson.

Findings suggested that a second-year pre-service teacher with gaps in MCK lacked the ability to implement a grade three subtraction lesson that promoted students' mathematical understanding. Lisa used procedures and closed questions, rather than articulate and demonstrate multi-solutions with materials. She did not discuss a range of thinking strategies that promoted learning. Focusing on improving her own mathematical knowledge might assist her with making the connections needed for mathematical explanations and develop the skills needed to acknowledge and use the range of strategies students will bring to each lesson.

Moreover during the follow up interview Lisa did not reflect on the way representations, materials and questions may promote or impede mathematical thinking or on her lack of teaching strategies to scaffold students' learning. While we need to be

careful about drawing generalisations from one case, this study draws on a need for further study on how pre-service teachers' MCK can be enhanced through practice.

References

- Ball, D. L. (2003). *Mathematics in the 21st century: What mathematical knowledge is needed for teaching mathematics?* [Electronic Version], 1-8. Retrieved 17 February 2007 from <http://www.ed.gov/rschstat/research/progs/mathscience/ball.html>.
- Ball, D. L., Bass, H., & Hill, H. C. (2004). Knowing and using mathematical knowledge in teaching: Learning what matters. In A. Buffgler & R. Lausch (Eds.), *Proceedings for the 12th Annual Conference of the South African Association for Research in Mathematics, Science and Technology Education* (pp. 51-65). Durban: SAARMSTE.
- Ball, D. L., Thames, M. H., Bass, H., Sleep, L., Lewis, J., & Phelps, G. (2009). *A practice-based theory of mathematical knowledge for teaching*. Paper presented at the Proceedings of the 33rd Conference of the International Group for the Psychology of Mathematics Education, Thessaloniki, Greece.
- Ball, D. L., Thames, M. H., & Phelps, G. (2008). Content knowledge for teaching: What makes it special? *Journal of Teacher Education*, 59, 389-407.
- Booker, G., Bond, D., Sparrow, L., & Swan, P. (2004). *Teaching primary mathematics, (third edition)*: Frenchs Forest NSW: Pearson.
- Carpenter, T. P., Fennema, E., Franke, M. L., Levi, L., & Empson, S. (1999). *Children's mathematics: cognitively guided instruction*. Portsmouth: Heinemann.
- Carpenter, T. P., Fennema, E., Peterson, P. L., Chiang, C.-P., & Loef, M. (1989). Using knowledge of children's mathematics thinking in classroom teaching: An experimental study. *American Educational Research Journal*, 26(winter), 499-531.
- Chick, H. L., Baker, M., Pham, T., & Cheng, H. (2006). Aspects of teachers' pedagogical content knowledge for decimals. In J. Novotna, H. Moraova, M. Kraka & N. Stehlikova (Eds.), *Proceedings 30th Conference of the International Group for the Psychology of Mathematics Education* (Vol. 2). Prague: PME.
- Empson, S. B., & Jacobs, V. R. (2008). Learning to listen to children's mathematics. In D. Tirosh & T. Wood (Eds.), *Tools and processes in mathematics teacher education* (pp. 257-281). Rotterdam: Sense Publishers.
- Ma, L. (1999). *Knowing and teaching elementary mathematics. Teachers' understanding of fundamental mathematics in China and the United States*. Mahwah, New Jersey: Lawrence Erlbaum Associates, Inc.
- National Curriculum Board. (2009). *National mathematics curriculum: Framing paper* [Electronic Version], 22. Retrieved 1 July 2009 from http://www.ncb.org.au/verve/resources/National_Mathematics_Curriculum_-_Framing_Paper.pdf.
- Reynolds, A. (1992). What is competent beginning teaching? A review of the literature. *Review of Educational Research*, 62(1), 1-35.
- Rowland, T., Turner, F., Thwaites, A., & Huckstep, P. (2009). *Developing primary mathematics teaching. Reflecting on practice with the knowledge quartet*. London: SAGE Publications Ltd.
- Schoenfeld, A. H., & Kilpatrick, J. (2008). Toward a theory of proficiency in teaching mathematics. In D. Tirosh & T. Wood (Eds.), *The international handbook of mathematics teacher education: Tools and processes in mathematics teacher education* (Vol. 2, pp. 321-354): Sense Publishers.
- Schulman, L. S. (1987). Knowledge and teaching: Foundations of the new reform. *Harvard Educational Review*, 57(1), 1-22.
- Sullivan, P., Clarke, D., & Clarke, B. (2009). Converting mathematics tasks to learning opportunities: An important aspect of knowledge for mathematics teaching. *Mathematics Education Research Journal*, 21(1), 85-105.

Web-based Mathematics: Student Perspectives

Esther Yook-Kin Loong
Deakin University
<esther.loong@deakin.edu.au>

This paper presents the results of a survey conducted with students (N=97) whose teachers have used the Web in their mathematics classes. The survey looked at students' attitudes towards learning mathematics and their responses to the use of the Internet for learning mathematics. Factor analyses were used to determine the constructs that underlie the survey. Indices formed were used to explore their relationships with each other and with other variables. Interview findings were able to support and lend insight into some of these results.

This paper draws on the findings of a survey and interviews conducted with students after class observations in Stage 2 of a completed PhD study. Four teachers and their classes were observed when the students worked on Web-based online tasks set by the teacher. This paper presents the results of the survey, which focus on their responses to the use of the Internet for learning mathematics. Factor analyses was used to determine the constructs that underlie the survey. In an attempt to provide a transparent view of the constructs, indices were then developed with the simple sums of variables. Interview findings were able to support and lend insight into some of these results.

Distinguishing Between the Internet and the World Wide Web (or Web)

The Internet is a vast collection of inter-connected networks that are connected using the *TCP/IP* protocols. These protocols or languages support email (SMTP), instant messaging, the World Wide Web (HTTP and HTML), news groups and file transfers (FTP). The Web is thus only a part of the Internet albeit an enormous part. Web documents called web pages are linked to one another via hyperlinks and can contain text, graphics, sounds and videos. Web 2.0 is an improved version of the Web as it allows for collaboration using file formats that allow for interaction whereas in the original Web file formats were not interactive. However, using small Java programs (called 'Applets') and JavaScript, both programming languages, static Web pages can include functions such as animations, calculators, and other fancy tricks. Clearly there are differences between the Web and the Internet but in this paper they have been used interchangeably except where the context suggests otherwise.

Theoretical Framework

Student Engagement in Mathematics

In countries where mathematics is not a compulsory subject after a certain age, the number of students choosing to continue mathematics to advanced levels has been decreasing. In Australia, there have been reports (e.g., Thomas, 2000) that the number of high school students studying advanced mathematical courses continues to decline and that this has been a consistent trend since 1990. There are many reasons why students drop out but various studies have shown that it is often because of the feelings of helplessness and anxiety induced during mathematics learning (Reys, 1998; Buxton, 1981; Tobias & Weissbrod, 1980;). This has to do with students' perception of mathematics and the way



mathematics is taught (Miller & Mitchell, 1994). Teachers need to present or set tasks that allow mathematical understanding and engagement to take place (Flewelling & Higginson, 2001; Fennema & Romberg, 1999) The use of workbook mathematics has also been cautioned against (Romberg & Kaput, 1999; Ollerton, 1999) as it has little value in connecting students' learning of ideas to the real world and tends to isolate mathematics from its uses and from other disciplines. Research (e.g. Hollingsworth, 2003) has shown that in practice the teaching methodology commonly used is still one of demonstration and practice and teacher talk. At the forefront of the argument for change is that of student motivation. The concept of student motivation lies not just in the affective (emotional) aspects such as enjoyment of a particular activity but also in the high quality cognitive engagements in students' activity (Evans, 1991). Can the World Wide Web with its myriad of resources and communication functionalities engage students mathematically and how?

Efficacy of Web-based Mathematics

The Internet as a tool has not been largely exploited for mathematics (see Goos & Bennison, 2008; Barnes & DETE, 2002; Becker, 1999). There are few studies on student uses of the Internet for mathematics and those reported (e.g. Moor and Zazkis, 2000; Gerber and Shuell, 1998; Goudelock, 1999) found students benefitted from the freedom to choose their own pathways but that this need to be scaffolded by teacher direction. While hypermedia-based systems with its affordances of multiple perspectives, collaborative learning, learner-orientation and interdisciplinary learning, have been found to have positive effects on students achievements over traditional instructions (Liao, 1998), teachers should be aware of the advantages and disadvantages this can bring to the similarly hypermedia- based environment of the Web (Liaw, 2001). These disadvantages include learner's background discrepancy, disorientation, over-rich information and ineffective user-interface. Interactive Java applets in the Web often seen as learning objects have been extolled as enhancing the online learning experience (Gadanidis, 2001; Mawata, 1998) but research into learning objects have also shown that students are well aware of what makes for a 'good' or 'bad' learning object and its efficacy for learning (Mussprat & Freebody, 2007).

Interactivity, multiple perspectives and access to rich information in itself is insufficient to engage students. Teachers need to know what makes students engage in a particular activity on the Web if they are ever to use it effectively. It is within this framework of engagement in learning and the role Web functionalities can play in enhancing engagement that this paper is written. This paper seeks to discuss in what ways the Web hold the answer to student engagement in mathematics. How do students view the use of this technology in learning mathematics? Deciphering the response of students who use different types of online materials for their learning will help to determine these materials' motivational value in promoting student engagement.

Methodology

A total of 97 students from three schools in South Australia participated in the study. These students range from Year 8 to Year 12. Table 1 details the compositions of the school settings, the classes and the pedagogical approaches taken.

Table 1

A Summary of the Composition of Classes, School Settings and Pedagogical Approaches

Type of School	Year level	No. of Students	Pedagogical Approach taken with the Web based lessons
Blue Lake High School (Pb)	8	13	Interaction with worked examples, interactive objects and interactive exercises
Longview High School (Pv)	8	16	Interaction with interactive objects and interactive exercises
Blue Lake High School (Pb)	10	12	Information search on Pythagoras theorem
Turnside Grammar School (Pv)	11	16	Directed investigation on loans and repayments
Blue Lake High School (Pb)	12	30	Data search for a Statistic Project
Turnside Grammar School (Pv)	12	10	Data search for a Statistic Project

Note: Pb= Public; Pv =Private

A survey was administered to the students ($n = 97$) after their teachers have used the Web in their mathematics classroom to determine students' attitude and perceptions towards mathematics and the use of the Web for mathematics learning. The mathematics attitude scales were derived from the Fennema-Sherman Mathematics Attitudes Scales (FSMAS) whilst the Internet items were researcher generated. Factor analysis was conducted separately for mathematics attitude items (16 items) and the Internet items (10 items). In this paper, analyses and discussion address findings relating only to Internet items.

Findings and discussion

Students' Response to the Use of the Internet for Learning Mathematics

Cronbach alpha internal reliability for ten items pertaining to students' perceptions of the use of the Internet in mathematics education was 0.9238. A Principal Component factor analysis was conducted on these items for all years ($n = 97$). Oblimin with Kaiser Normalization extracted two factors with eigenvalues equal to or greater than 1. The KMO value was 0.903 and Bartlett's Test of Sphericity was high (678.253) and significant. All variables had MSA above the acceptable level of 0.5. The first factor seems to relate to students' evaluation of the Internet as a tool for learning mathematics and was thus labelled as 'Valuation of the Internet as a tool for learning mathematics'. The second factor seems to relate to students' emotive response when the Internet is being used and was labelled as 'Emotive response to the Internet'. The first factor accounts for 60% of the variance and the second factor 11.5%. Table 2 gives summary information about the factor variables, recoded items and the alpha values. From the factor analysis, simple tallies of the component were obtained by adding all the variable values in the component to form new indices.

Table 2
Summary about Internet Variables

Construct: Valuation of the Internet as a tool for learning mathematics
Learning mathematics with the Internet helps me learn mathematics faster.
I understand mathematics concept better when my teacher uses the Internet to teach.
I wish my teacher would use the Internet to teach mathematics.
I enjoy learning mathematics with the Internet.
I dislike it when my teacher uses the Internet to teach mathematics.*
I think the Internet is very useful for learning.
I don't think it is a good idea to use the Internet in class.*
Cronbach's alpha = 0.9362
Construct: Emotive response to the Internet
I feel nervous when we use the Internet in mathematics *
Feel frustrated when we use the Internet to learn mathematics *
There are lots of interesting materials on the Internet
Cronbach's alpha = 0.7333

Note: * indicates recoded items

To have an idea of what is meant by a low or high level of the construct, tallies based on the scales used in the instrument and the numbers of variables in the factors were computed. This produced a range of indices that reflect to a certain extent the level of agreement as in the original scales. Table 3 shows the range of indices for the new construct 'Valuation of the Internet' and the percentages of students in those ranges. The inter-quartile values obtained from the frequency statistics table show that the first quartile falls within 20 points of the index, the second quartile within 24 points and the third quartile within 28 points of the index. Similar to the Valuation of the Internet construct, the Emotive construct indices were grouped so that they reflect the original scales.

Table 3
Range of Indices for Valuation of the Internet and Students' Response

	Index range obtained	All SD or D	All D or U	All U or A	All A or SA
Valuation of the Internet	7-35	7-14	15-20	21-27	28-35
% of students		8.2	19.6	43.3	28.9
		Associated Inter-quartile ranges			
		≤ 20	20.5 - 24	24.5-28	>28
Percentiles		0-25%	26-50%	75%	100%

The results showed that about 30 % of the students seem to be either agreeing or strongly agreeing that the Internet has value as a tool for learning mathematics but the majority seems to have a moderate valuation of the Internet. A moderate valuation could

suggest uncertainty about the value of the Internet. There could be two reasons why this is so. Firstly, it could suggest that students have not used the Internet sufficiently to be able to make a judgment about its value. There might be a perception that until one has used the Internet in a variety of ways and with sufficient frequency; the value of the Internet is still difficult to decide. The second reason could be that students may find it difficult to decide because its value may differ according to the way it had been used or according to the subject matter in which it was used. The Internet might have been useful with certain topics but not in others; similarly the way in which the Internet has been integrated by their teachers may have been successful in some lessons but not in others. Hence there is indecision about its value. The results show that about 62% of the students seem to have a high emotive response towards the Internet indicating that students are generally well disposed to the use of the Internet in mathematics and are comfortable with it. The following section will discuss the perception of students from different year levels.

Year Differences in Internet Variables

Table 4 shows significances of the independent samples T tests of means on each of the constructs (i.e. ‘Valuation of Internet’ and ‘Emotive Response to the Internet’). The constructs ‘Valuation of Internet’ and ‘Emotive Response to the Internet’ show that Year 8 students are distinctly different in their attitudes to the Internet to the other years. For example, there is a significant difference in the mean valuation of the Internet between Years 8 and 11 at $p=.001$ with Year 8 mean being higher than Year 11 (as indicated by bold typeface). These findings seem to suggest that the Year 8 students value the use of the Internet more highly than older students. This difference seems to be even more pronounced with older students.

Table 4

Significance of Independent Samples t-tests of Means between Year Levels for Different Constructs

	Levels of significance between difference of means of year levels					
	8-10	8-11	8-12	10-11	10-12	11-12
Valuation of Internet	0.011	0.001	0.000	0.925	0.683	0.495
Emotive Response to the Internet	0.048	0.052	0.000	0.872	0.957	0.786

Note: All significances two-tailed with equal variances not assumed. **Bold** indicates the first year measure is greater than the second year measure.

Four possible effects may cause this. The first is that the Internet is a novelty for these Year 8 students who are younger and are still enamoured by the prospect of doing mathematics with a learning tool like the Internet. Older students have probably become used to using the Internet for their studies and so it does not hold much value for them. If novelty effects of the Internet are the cause for the higher valuation of the Internet among the Year 8 students then similar results should have been obtained also for the Year 10 students as interviews with Year 10 students found that many at this year level were also not using a lot of the Internet in their mathematics. However, the results showed that there were no significant differences between Year 10 students and Year 11 and 12 students. This means a second effect is possibly at work, which is the specific pedagogical approach used by the teacher. That being the case, it might be instructive to re-examine the different strategies used for each of the year levels and the different Web resources used.

The approach and type of Web material that the Year 8 teachers employed with their students is different from that used by the teachers for Years 10, 11 and 12. Year 8 students used interactive learning objects, which enabled them to manipulate variables. The students were able to control the learning objects at will. These activities were usually carried out in tandem with teaching done in the classroom. The visuals aided in concept development and reinforcement. Students who have used the interactive learning objects have this to say.

I think it's very creative, and I think it can make lots of people interested in Mathematics...Because it shows you, like you can understand it better because it's coloured and...it explains to you what you have to do and then it just gives you an example. So show you the difference, like to show you how much it is, like on a bar graph, like 40 is less than 50, so it will be less than halfway. (Allan, Y8, Pb)

Doing searches for mathematical proofs and theorems can be both interesting and daunting. It was interesting because the presentations of the proofs were animated and visual but not necessarily easily understood by some.

Proofs ? I didn't really understand them Yeah it did *a bit* like you could see how the triangles move shape and they go into each other, yeah it made it more clear ... (Lennie Y10, Pb)

It's just a lot easier for me to understand and a lot easier to get information from the internet than looking in books. ... Well, they've got different diagrams for different things and stuff and it just pops up information little by little and helps you understand. (Nathan Y10, Pb)

It was daunting in that one had to go through and decide which one to choose to read because of the amount of information.

There are heaps of things on Pythagoras, there's like 20 thousand odd pages on it ... (Lennie Y10, Pb)

Although the approach taken by teachers of Year 10, 11 and 12 students were Web-based, the approach was one of information search and utilizing the richness and authenticity of such information to enhance the perception of mathematics and its application to real life. Although the wealth of information and easy accessibility to a myriad of true-life references was welcomed by the students when they did the projects, many felt that not much mathematics was learnt from such assignments of information retrieval and data collection.

Probably not the understanding of it because it's there for you, you just ... you don't really have to use any brain power, but yeah, I guess understanding through doing the whole assignment, I don't know whether that's due to the internet or not. I wouldn't say it was. (Jenna Y11, Pv).

In this assignment? No, not really. I knew how to do everything. It's just data, you're just reading, not doing mathematics. Yeah, there wasn't mathematics in it. (Margaret, Y 12 Pb).

... it didn't really teach me any additional mathematic skills. It was more that collaboration of data and all that analysis and stuff were things that I had already learnt in class. I didn't really learn much more from the Internet. (Jane Y12, Pv).

Despite the fact that Year 12 students are older and may perhaps be better able to handle the huge information overload, some still have reservations about accessing data from online databases and websites. When asked what was one thing they did not like about doing this project using the Internet one student said it was '...probably the fact that there was so much data to sort through and that probably took a lot of time?' This brings to mind what Liaw (2001) cautioned against with regards to the over-rich information and disorientation.

It cannot be concluded here that the findings about students' valuation of the Internet and their emotive responses to the Internet are a direct result of the teaching strategies described in the case studies. The valuations and emotive responses of these students towards the Internet could be due to a third reason and that is the effect of their experience and engagements with the Internet in other disciplines. These experiences might include exposure to and usage of the Internet in disciplines such as Society and Environment, and English. It could also be due to different teaching and learning approaches at other year levels. Internet access at home may also contribute to a favourable emotive response to the Internet. To study which of these influences play a role in these responses would need a classic experimental control study and is outside the scope of this project.

A fourth reason for the differences in valuation of the Internet and the emotive responses between Year 8 and Year 11 and 12 students could be that as students move up to higher levels where assessments and year-end examinations become more important (particularly in Year 12), assessment related mathematics seem more pressing and relevant than exploration of mathematics concepts. These students may not see value in using the Internet in class unless it is directly related to assessments. Whatever the relative influences of these effects may be there is a clear distinction in the valuation and emotive response to the Internet between the Year 8 students and the Year 11 & 12 students. Future studies could take this investigation further.

Conclusion

There are limitations to the generalisability of the findings in this paper partly due to the small number of students involved as well as the uncontrolled conditions in which the case studies have been undertaken. However as an alternative resource for teaching mathematics, these findings do point to the potential of the Internet to motivate students. Interactive web objects that animate or can be virtually manipulated, and provide feedback to students seem to engage and motivate students better than Web pages of data or information. However animations and the interactive nature of a Web object does not necessary guarantee learning and comprehension among students. Teachers will still have to use their pedagogical content knowledge to determine how a certain interactive object could promote engagement and understanding. It is hence instructive for teachers to know that students want'... learning objects (LOs) that allow interaction with the LO, that allow more control over how to progress through the LO, that do not look like conventional classroom activities, and that are more game-like ...' (Muspratt & Freebody, 2007).

It was surprising that despite the good intentions of the teachers to incorporate real-life scenarios and real data into the mathematics lessons, these have not translated into an appreciation for the use of mathematics in everyday life for the students. For many, the data and information retrieved were just perceived as numbers to be inserted into tables and had no real life relevance. The 'messiness' of real data had not been highlighted and exploited. This has implications for teachers and teacher educators. It may be that to truly harness the potential of the Web for mathematics we need to we step out of the 'clean' confines of school mathematics and engage students in numeracy where mathematical, contextual and strategic know-how (Hogan, 2000) are essential. This is where the interdisciplinary learning and richness of tasks that is afforded by the Web can take place.

References

- Buxton, L. (1981). *Do you panic about maths? Coping with maths anxiety*. London: Heinemann Educational.
- Carpenter, T. P., & Lehrer, R. (1999). Teaching and learning mathematics with understanding. In T. A. Romberg & E. Fennema (Eds.), *Mathematics classrooms that promote understanding* (pp.19-32). Mahwah, N.J.: Lawrence Erlbaum Associates.
- Evans, G. (1991). Lesson cognitive demand and student processing in upper secondary mathematics. In Author (Ed.) *Learning and teaching cognitive skills* (pp. 124-143). Victoria: The Australian Council for Educational Research Ltd.
- Flewelling, G., & Higginson, W. (2001). *Handbook on rich learning tasks: Realizing a vision of tomorrow's mathematics classroom*. Kingston, Ont.: Queen's University Faculty of Education Centre for Mathematics Science and Technology Education.
- Fennema, E., & Romberg, T. A. (Eds.). (1999). *Mathematics classrooms that promote understanding*. Mahwah, N.J.: Lawrence Erlbaum Associates.
- Gerber, S., & Shuell, T. J. (1998). Using the Internet to learn mathematics. *Journal of Computers in Mathematics and Science teaching*, 17(2/3), 113-132.
- Goos, M. & Bennison, A (2008). Surveying the technology landscape: Teachers' use of technology in secondary mathematics classrooms. *Mathematics Education Research Journal*, 20(3), 102-130.
- Goudelock, C. P. (1999). *Effect of the use of an Internet-based 'problem of the week' on high school geometry students problem-solving achievement and attitudes towards mathematics*. Unpublished EdD thesis, Montana State University.
- Hogan, J. (2000). Numeracy-across the curriculum? *Australian Mathematics Teacher*, 56 (3), 17-20.
- Hollingsworth, H. (2003). The TIMSS 1999 video study and its relevance to Australian mathematics education research, innovation, networking and opportunities. In Bragg, L., Campbell, C., Herbert, G., Mousley, J. (Eds.) *Mathematics Education Research: Innovation, Networking, Opportunity: Proceedings of the Twenty-sixth Conference of the Mathematics Education Research Group of Australasia*. Vol.1 (pp.7-16). Geelong: Deakin University.
- Miller, D. L., & Mitchell, C. E. (1994). Mathematics anxiety and alternative methods of evaluation. *Journal of Instructional Psychology*, 21(4), 353-359.
- Moor, J., & Zazkis, R. (2000). Learning mathematics in a virtual classroom: Reflection on experiment. *Journal of Computers in Mathematics and Science Teaching*, 19(2), 89-113.
- Muspratt, S. & Freebody, P. (2007). Students' perceptions of the characteristics of "good" and "poor" digital learning objects. Paper presented at the 2007 AARE Annual Conference *Research Impacts: Proving or Improving?* University of Notre Dame Australia, Fremantle 25-29 November, 2007.
- Ollerton, M. (1999). Learning mathematics through "real-life" problems: Text, context and con-tricks. *Mathematics Teaching*, March, 12-13.
- Reys, R. E. (1998). *Helping children learn mathematics* (5th Ed.). Boston: Allyn and Bacon.
- Romberg, T. A. & Kaput, J. J. (1999). Mathematics worth teaching, mathematics worth understanding. In Romberg, T. A. & Fennema, E. (Eds.), *Mathematics classrooms that promote understanding* (pp. 3-17). Mahwah, N.J.: Lawrence Erlbaum Associates.
- Thomas, J. (2000). Mathematical sciences in Australia: Looking for a future. *FASTS (Federation of Australian Scientific and Technological Societies) Mathematical Science Issues* (3), 31.
- Tobias, S. & Weissbrod, C. (1980). Anxiety and mathematics. *Harvard Educational Review*, 50, 63-70.

The Relationship between the Number Sense and Problem Solving Abilities of Year 7 Students

Jemmy Louange

Port Hedland Senior High School

<jemmy.louange@det.wa.edu.au>

Jack Bana

Edith Cowan University

<j.bana@ecu.edu.au>

This paper reports on a component of a large yearlong study in three Year 7 classes in three different schools. The aim of this research component was to determine the relationship between students' number sense and their problem-solving ability by means of paper-and-pencil tests, classroom observations, and interviews of students and teachers. The results revealed a strong correlation between these two aspects of school mathematics, with important implications for classroom teachers.

This paper reports on one aspect of a much larger study conducted in three schools in the Perth Metropolitan over a one-year period (Louange, 2005). The three schools were an independent boys' school, an independent girls' school and a coeducational public school. One Year 7 primary school teacher, identified by tertiary mathematics educators as being an effective mathematics teacher, was selected in each school for the study. The main study investigated the relationships between, teaching style, learning style, number sense, and problem solving ability in the three Year 7 classes through testing, interviews of students and teachers, and extensive periods of classroom observation over the year's mathematics lessons. The purpose of this paper is to determine the relationship between number sense and problem solving as a facet of the larger study just described.

Background

Both number sense and problem solving are promoted as two of the major areas of emphasis in mathematics education, as evidenced in major curriculum documents (Australian Education Council, 1991; National Council of Teachers of Mathematics, 2000; Curriculum Council of Western Australia, 2005). Thus, there is an urgent need to answer questions such as, "How do they relate to each other in terms of how they are taught, learnt and utilised in solving mathematical problems?" While there have been many studies relating to the two aspects independently, there is a lack of research which focuses on the relationship between the two.

Unfortunately, one possible reason for lack of a combined number sense and problem solving research could be due to the difficulty of divorcing one from the other. Both the terms 'number sense' and 'problem solving' have suffered many diverse definitions. The controversy stems mainly from the fact that number sense is akin to common sense (McIntosh, Reys, Reys, Bana, & Farrell, 1997), which is a necessary tool for solving any problem. Compared to problem solving, number sense seems to have proved to be the most difficult to define, as McIntosh et al. (1997) state:

Like common sense, number sense is a valued but difficult notion to characterise and has stimulated much discussion among mathematics educators (including classroom teachers, curriculum writers, and researchers) and cognitive psychologists. (p. 3)

Thus, while there seems to be general agreement by mathematics educators on a definition of a problem, it is not possible to define number sense in such a straightforward manner. A problem is generally regarded as a situation where both the solution and method



of solution are not obvious. However, number sense is best described by a comprehensive list of characteristics. Without listing them here, we would venture that number sense could be considered as ‘the ability to make sound estimates’, since this ability necessarily incorporates the list of number sense attributes that are usually identified.

In the publication edited by McIntosh and Sparrow (2004) mathematics educators from the UK, Europe, the USA and Australia who are recognised as leaders in the issue of number sense, provide considerable insight for researchers, curriculum developers and mathematics teachers at all school levels. There is an abundance of other material by mathematics educators and researchers on the teaching of number sense, with publications by Anghileri (2000) and Askew (2002) being two examples. Considerable research has been undertaken on problem solving, and the teaching of mathematics through problem solving continues to be a focus of mathematics educators (Schoen & Charles, 2003; Nisbet & Putt, 2000). However, investigations into the links to number sense are lacking. Despite their evident connection, problem solving and number sense are not necessarily synonymous because while number sense is inherent in problem solving, many problems are solved without recourse to number sense (Hiebert et al., 1997). Most definitions of number sense incorporate a sense of problem solving (Denvir & Bibby, 2002), which serves to show that it is virtually impossible to separate the two. Although in these definitions the intention weighs more towards number sense inherent problems, it could also be that number sense ability is intricately linked to mathematics problems, which are devoid of number sense (Anghileri, 2000). Yet there is a lack of research to elucidate the relationship between problem-solving ability and number sense.

In the context of this present research any problem which necessarily requires knowledge and skill in number, to arrive at an acceptable resolution, will involve number sense; while any question for which the solver has no immediate and apparent way of solving will constitute a problem (Thiessen & Trafton, 1999; Reys & Yang, 1998). This study aims to explore what relationships exist between Year 7 students’ number sense and their problem-solving ability.

Methodology

As indicated above, the subjects were three Year 7 primary classes in three different schools, each of which had a full-time teacher identified by a number of tertiary mathematics educators to be an effective mathematics teacher. The study involved both quantitative and qualitative approaches. Pre-tests in both number sense and problem solving were administered to all students at the beginning of the school year, and the same tests were given again at the end of the year. On both occasions the tests were administered over two days, with one test each day in the normal mathematics time-slot. Each item was read to the class to help overcome any possible reading difficulties. During the year, 30 mathematics lessons were observed in each class, which was one lesson per week for each teacher over most of the data collection period. Both teachers and students were interviewed.

The number sense instrument consisted of 45 of the items used by McIntosh et al. (1997) in their international study of number sense in three countries. A sample item is included in the Appendix. The problem-solving instrument consisted of items selected from problem-solving competitions conducted by the Mathematical Association of Western Australia (2000, 2001, 2002). The problem-solving instrument was refined from a pilot study and consisted of eight items – four of which involved number sense and four that were devoid of number sense. A sample of each type is in the Appendix. Each problem

was presented on a single page and students were required to document all their processes and the strategies used. It was considered most important that the process as well as the product be taken into account for each problem. A scoring scale was adapted from Charles, Lester, and O'Daffer (1987) that allocated a score of 0, 1, or 2 for each of the categories Understanding the Problem, Planning a Solution, and Getting an Answer. These three scores were then added to give an overall score for each of the eight problems.

A total of 64 students completed all the assessments and 45 of these were formally interviewed. The 45 were selected in such a manner as to be representative both of the three classes and also their performances on the two initial paper-and-pencil tests. This interview involved each student working aloud to complete two problems of each type, with follow-up questions by the interviewer as appropriate, and using stimulated recall. Half the 64 students were also interviewed informally during the classroom observation sessions over the one-year period. Semi-structured interviews were conducted with each of the three teachers, and there were informal interactions on the occasions of the observations of the mathematics lessons. Observations of significance to the study were recorded during the observed mathematics lessons by the researcher. All data gathering was undertaken by the one researcher.

Results

The results for both the pre- and post-tests of number sense (NS) were combined to give one score. The same was done for the pre- and post-tests of problem-solving (PS) performance to give one basis for comparing the two aspects. The combined scores for number sense were categorised as High (H_{NS}), Medium (M_{NS}), or Low (L_{NS}). The combined scores for problem solving were categorised in the same way. Using the three levels for each skill, the grid of nine cells in Table 1 gives a good insight into the relationship between number sense and problem solving.

Table 1
Number and Percentage of Students within each Score Category for NS and PS

	H_{PS}	M_{PS}	L_{PS}	Total
H_{NS}	12 (18.8)	6 (9.4)	1 (1.6)	19 (29.7)
M_{NS}	5 (7.8)	15 (23.4)	6 (9.4)	26 (40.6)
L_{NS}	1 (1.6)	6 (9.4)	12 (18.8)	19 (29.7)
Total	18 (28.1)	27 (42.2)	19 (29.7)	64 (100)

Note: $N = 64$, with percentages of students shown in parentheses.

The diagonal of matching categories demonstrates a very strong relationship between number sense and problem-solving ability, with 12 students rated high in both, 15 rated medium in both, and 12 rated low in both aspects. There are 11 students rated high on one

aspect and medium on the other, and there 12 rated medium on one and low on the other, so that the relationship for both these sets could be considered as fairly strong. This leaves only two students who scored high on one and low on the other. These results clearly demonstrate a strong relationship between the two aspects overall.

The problem solving instrument consisted of four number-sense-inherent problems (NSIP) and four devoid-of-number-sense problems (DNSP). The 64 students were asked whether they preferred NSIP or DNSP types. Figure 1 shows a scatter plot of the relationship between problem-solving performance and number sense, and also gives each student's preference for either NSIP or DNSP types. A two-tailed Pearson Correlation was applied to the pre- and post- PS and NS combined scores, resulting in quite a strong correlation of 0.77 at the 0.01 level. The coefficient of determination indicates almost 60 percent shared variance, which implies that number sense helps to explain nearly 60 percent of the students' scores on the problem solving test. Although the converse could also be true, triangulation of data obtained from the various forms of data collected, especially those from the interview involving stimulated recall with the solving of four problems, show greater support for a theoretical framework in which problem solving ability level depends more on number sense than vice versa. For instance, for the 45 students interviewed, there was a correlation between their PS scores at the interview and their PS test performance scores ($R = 0.31, p < 0.04$). There was also a significant correlation between the 45 students' interview PS scores and their NS performance scores ($R = 0.55, p < 0.005$).

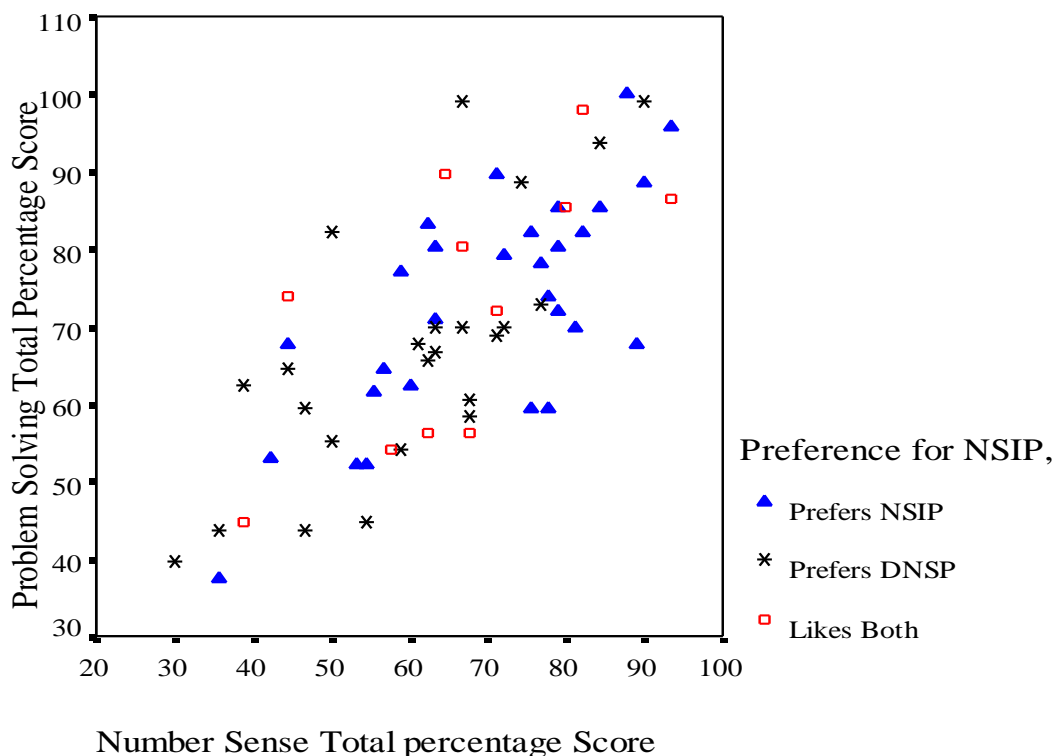

Figure 1. Relationship between number sense and problem solving, with student preferences.

Irrespective of the statistical calculations, Figure 1 clearly shows a strong correlation between the number sense and problem-solving ability of the 64 Year 7 students. Since the students preferences for solving either NSIP or DNSP or both seemed to be related to their number sense and problem solving performance, the scatter plot presented in Figure 1 also shows the distribution of the students' scores according to the type of problems they preferred to solve. Although there was no marked difference between the percentage of students preferring NSIP (45%) and those preferring DNSP (38%) it was found that student preference for solving NSIP was more closely related to number sense performance ($R = 0.69$). Even more striking was the higher correlation of NSIP preference and problem solving scores pertaining to NSI problems ($R = 0.56$) as opposed to a very low correlation between NSIP preference and performance scores for solving DNS problems ($R = 0.29$). These results are graphically supported in the scatter plot presented in Figure 1.

Student interviews revealed that the students considered number sense to be a significant factor in problem solving. Although few used the actual term number sense, it was clear from their descriptions that this was the inference. Table 2 lists the three major factors considered by students to affect problem-solving performance. Lack of number sense often created difficulties, as explained by one student:

I don't think that I did not understand what I read. I understand all these words, but there are calculations to be made, but I don't know which calculation to do. I don't always understand what the numbers, what to do with the numbers.

Table 2

Main Factors Identified by Students as being Responsible for Poor Problem-solving Performance (N = 64)

Factor	Summary of students' most common answer	Count	Percentage
Lack of number sense	Lack of understanding of number facts and how to apply them	45	70
Lack of language proficiency	Not understanding the language; not being able to read properly	36	56
<i>Mathematics anxiety</i>	<i>Afraid to solve any mathematics problems; lack of confidence</i>	31	48

One issue arising from the discussion with the students was the need to work mathematically. This was supported by the three teachers and was summarised quite succinctly through Bob's statement that "without number sense students would find it hard to work mathematically"; and according to Amanda, "it is extremely difficult to work mathematically if one has poor number sense ... because this will make it even more difficult to solve most problems". Yet, as Chantal pointed out, the challenge to overcome this obstacle "is a very big one, given that mathematics is not only about number sense, but also about other concepts and mathematics sense". This notion of "making sense of the mathematics" was explained by Chantal as being "more prominent in making sense of number, as it permeates all other strands of the mathematics curriculum". Such a notion was quite widespread in both practice — through the learning experiences observed — and theory, as expressed by Amanda: "since most problems require number sense, students

with such ability have a great advantage over those with poor or no number sense, when it comes to successfully solving a problem”. All three teachers and the majority (70 percent) of students believed that lack of number sense is a probable major cause of poor performance in solving mathematics problems. Clearly, the link between number sense and problem solving is very significant. Bob reiterated this point when he stated that:

Number Sense is very much like problem solving in the sense that you have to read the problem, try to understand it, plan a way to solve it and come up with a reasonably accurate answer. All these performance components must be assessed in both number sense and problem solving if I am to encourage the students to love working with numbers, and to make sense of what they have learnt.

All three teachers favoured an assessment method that took process as well as product (the solution) into account, thus linking problem solving with assessment. Hence, it was not surprising to learn that Chantal’s comment that “... number sense should be, or maybe I should say must be assessed through problem solving, since it [number sense] involves mainly how students make sense of the number components of a problem” was a view also shared by the other two teachers. Bob’s view, that “assessing for number sense through a problem-based method helps me not only to gauge the student’s content knowledge, but also his thinking process and solution” was a prevalent one among all three teachers.

Conclusion

This study showed that there is quite a strong correlation between the number sense and problem solving proficiency of Year 7 students. The evidence points towards a relationship in which problem solving performance depends upon number sense proficiency more than the latter depending on the former. The relationship is borne out, not only in the results of the paper-and-pencil tests, but also from the views of both the teachers and students. Teaching through a problem-based approach should be a priority for every teacher of mathematics who endeavours to enhance his or her students’ number sense problem solving proficiency. As pointed out by the NCTM *Standards* (2000), both number sense and problem solving are crucial to the learning of mathematics. Number sense and problem solving are linked through assessment, which incorporates consideration of both the thinking process and the final solution by a student. The specific relationship between number sense and the solving of problems, which are devoid of number sense does need some further investigation. Finally, it is clear that teachers need to ensure that problem solving is the focus of their mathematics programs, so that students are always working mathematically.

References

- Anghileri, J. (2000). *Teaching number sense*. New York; London: Continuum.
- Askew, M. (2002). The changing primary mathematics classroom: the challenge of the National Numeracy Strategy. In L. Haggarty (Ed.), *Aspects of teaching secondary mathematics: Perspectives on practice*, (pp. 3-17). London: Routledge Falmer.
- Australian Education Council. (1991). *A national statement on mathematics for Australian schools*. Melbourne: Curriculum Corporation.
- Charles, R. I., Lester, F. K., & O’Daffer, P. (1987). *How to evaluate progress in problem solving*. Reston, VA: NCTM.
- Curriculum Council of Western Australia. (2005). *Curriculum framework: Progress maps*. Perth: Author.
- Denvir, H., & Bibby, T. (2002) *Diagnostic interviews in number sense: One-to-one assessments mapping children’s understanding of number*. London: BEAM Education.

- Louange, J. E. G. (2005). *An examination of the relationships between teaching and learning styles, and the number sense and problem solving ability of Year 7 students*. Unpublished PhD thesis: Edith Cowan University, Perth.
- Mathematical Association of Western Australia. (2000). *Have Sum Fun Competitions*. Unpublished document. Perth: Author.
- Mathematical Association of Western Australia. (2001). *Have Sum Fun Competitions*. Unpublished document. Perth: Author.
- Mathematical Association of Western Australia. (2002). *Have Sum Fun Competitions*. Unpublished document. Perth: Author.
- McIntosh, A., & Sparrow L. (Eds.) (2004). *Beyond written computation*. Perth: MASTEC, Edith Cowan University.
- McIntosh, A., Reys, B., Reys, R., Bana, J., & Farrell, B. (1997). *Number sense in school mathematics: Student performance in four countries*. Perth: MASTEC, Edith Cowan University.
- National Council of Teachers of Mathematics. (2000). *NCTM standards 2000: Principles and standards for school mathematics*. Reston, VA: NCTM.
- Nisbet, S., & Putt, I. (2000). Research in problem solving in mathematics. In K. Owens & J. Mousley (Eds.). *Research in mathematics education in Australasia 1996 to 1999*, (pp. 97-122). Sydney: Mathematics Education Research Group of Australasia.
- Reys, R. E., & Yang, D. C. (1998). Relationship between computational performance and number sense among sixth- and eighth-grade students in Taiwan. *Journal for Research in Mathematics Education*, 29, 225-237.
- Schoen, H. L., & Charles, R. I. (2003). *Teaching mathematics through problem solving: Grades 6-12*. Reston, VA: NCTM.
- Thiessen, D., & Trafton, P. (1999). *Learning through problems: Number sense and computational strategies, a resource for primary teachers*. Portsmouth: Heinemann.

Appendix

Number Sense Item Sample

- How many different fractions are there between $\frac{2}{5}$ and $\frac{3}{5}$? _____
- Circle your answer and then fill in the blanks. _____
- A** None. Why? _____
- B** One. What is it? _____
- C** A few. Give two: _____ and _____
- D** Lots. Give two: _____ and _____

Problem Solving Item Sample Including Number Sense

Peter, Paul and Pat divide \$120 so that Peter gets three times as much as Paul, who gets half as much as Pat. How much does Peter get?

Problem Solving Item Sample Devoid of Number Sense

Alan, Brett, Carol and Dianne went to basketball, cricket, hockey and athletics. Carol didn't go to basketball; Brett couldn't go to cricket; the girl who went to hockey would like to have gone to cricket; and the person who went to basketball was upset she couldn't go to athletics. Who went where?

Teachers' Perceptions of Geometry Instruction and the Learning Environment in Years 9-10 ESL Classrooms

Rinna K. Ly
Curtin University of Technology
Rinna.ly@det.nsw.edu.au

John A. Malone
Curtin University of Technology
j.malone@curtin.edu.au

This paper describes the development of an instrument to assess teachers' views on their geometry instruction and their classroom learning environments in six government high schools in southwest Sydney. The sample consisted of 18 Years 9/10 ESL teachers from participating schools. The study involved completion of a survey form using a modified and expanded *What Is Happening In this Class (WIHIC)* questionnaire for teachers along with participant interviews. The findings indicated that there were positive associations between the learning environment and teachers' views on geometry instruction and the achievement of their classroom goals.

In studying geometry, students are encouraged by teachers to communicate their understanding of geometrical concepts and expressions using their own words, diagrams and the relationships between symbols and diagrams that form basic geometrical knowledge. English is a second language to many students in southwest Sydney schools, a majority of whom migrated from Asian and middle-eastern countries with their families in order to seek new opportunities in Australia. Consequently it is often difficult to teach geometry in this region of Sydney, although multicultural education is being used increasingly to provide a curriculum for the majority of migrant children, and this has been generally successful in enhancing their English-speaking ability while enabling them to retain and maintain their mother language.

This study was designed to examine how ESL teachers in Years 9-10 at six secondary schools located in the region view their geometry instruction and how the classroom learning environment (CLE) is influenced by, and also influences this experience. The need for an encouraging, positive CLE is regarded as of prime importance by ESL teachers in their efforts to assist their students in improving their achievement in geometry (Sperling, 2008; Wetzel, 2009). The study sought to assess teacher views on their CLE and to identify links between these perceptions and teacher success with geometry instruction.

The research questions of the study were:

1. Can an instrument based on a modified *WIHIC* questionnaire be developed and validated in order to assess teachers' perceptions of their geometry CLE?
2. What are the links between these perceptions and teachers' achievements in teaching geometry?

Literature Review

Previous research findings have shown that teachers affect students' learning and that the CLE and teacher differences also affect students' achievement (Fraser, 1994; Hill, Rowe, & Holmes-smith, 1995; Rawnsley, 1998). It has also been established that effectiveness in learning geometry is the result of the CLE, teacher influence on students' learning, and the quality of the teachers – factors that have special significance for those practitioners working with ESL students (Rawnsley, 1998; Sperling, 2008; Wetzel, 2009). Effectiveness in geometry teaching has been the subject of considerable theorising. Much research has investigated the validity of van Hiele's 1986 theory and has focused on teachers' emphasis on geometrical reasoning. Alternatively, Pusey (2003) considers that



each of Piaget's five stages of development – the *sensorimotor; iconic; concrete symbolic, formal, and post-formal stages* – has an important role in learning geometry. Pusey claims that “the nature of students’ development in their geometrical thinking happens over time as they grow older”, the implication being that such development will be more prolonged for the ESL student and that the CLE plays an important role here (Pusey, 2003, p.4). Battista and Clement’s (1995, p.425) recommendation that investigators use “a developmental sequence of reproducing geometrical figures focusing on memory; transformations involving rotation and visual perspective-taking” to examine children’s actions and thoughts in the process of drawing shapes if they want them to organise spatial information in a meaningful way. This also has implications for the ESL student.

At the secondary school level in southwest Sydney, ESL teachers use instructional strategies for teaching geometry that involves drawing diagrams as well as guessing and matching words and geometrical figures; doing sample work on the blackboard and quizzes on paper to show step-by-step the explanations of mathematical problems; solving geometrical problems and brainstorming the meanings of key words and mathematical terminologies. In doing so they are utilizing the strategies proposed by Ding & Jones (2006) who make the point that teachers need to develop a sound pedagogy with considerable resources and activities if they are to improve their geometry teaching. The roles teachers play in adjusting to the interactions of the community through the process of following a curriculum and its associated cultures are most important (Tobin and Fraser, 1998), a sentiment that applies particularly to mathematics teachers dealing with ESL students. Often a lack of communication causes misunderstandings regarding students’ behaviour, students’ and teachers’ interactions and geometrical instruction. Personal experience of the authors has shown that a positive, relaxed, supportive and focused CLE has a significant impact on these students.

One useful strategy used by Southwest Sydney teachers involves problem solving on related similar problems, and students are encouraged to group geometrical word problems into clusters for solving in accordance with a suggestion of Hinsley, Hayes, and Simons (1977). Such a successful pedagogical practice with a diverse classroom population helps to reinforce the ideas behind culturally relevant pedagogy being translated from theory into practice (Baker & Digiovanni, 2005). Successful teachers reflect upon classroom events to reconsider their own personal understandings of mathematics, and teaching mathematics (especially geometry) needs fluid and connected knowledge of mathematics (Bills, 1999).

Methodology

Instrumentation

In this study, a modified learning environment questionnaire that combined the *WIHIC* with items from another instrument – the *My Classroom Inventory (MCI)* – was administered to teachers. The instrument consisted of 54 items in nine scales. It measured teacher perceptions on nine scales of *Student Cohesiveness* and *Satisfaction* containing five items in each scale; *Teacher support*, *Equity* and *Investigation* containing six items in each scale; *Task Orientation* and *Cooperation* containing seven items in each scale; *Involvement* containing eight items; and *Difficulty* containing four items. The items in each scale were scored 1, 2, 3, 4 and 5 respectively for responses “almost never”, “seldom”, “sometimes”, “often”, and “almost always”.

The 18 teachers (13 male and 5 females) were also interviewed. Classroom learning environment research has shifted from systematic observation to the use of a mixed

methodology involving quantitative and qualitative approaches to provide complementary perspectives on research problems (Rawnsley, 1998; Punch, 2000). The purpose of selecting this mixed-method approach was to enhance the quantitative component through the support of the qualitative data.

Data collection and analysis

All teachers completed the modified *WIHIC* questionnaire. Eight agreed to face-to-face interviews, and 10 responded to an interview form by correspondence. Interview methods have been used to investigate teachers' understanding of concepts in science and mathematics because they can reveal issues in students' thinking about these subjects as well as gauge their sensitivity to different teachers' ideas (Treagust, Duit, & Fraser, 1996). Each interview took approximately 10 to 15 minutes. The face-to-face teacher interviews were audio recorded and transferred to the computer for analyzing and backed up the findings of the quantitative data.

Results and Discussion

The index of internal consistency of the *WIHIC* instrument was measured by the Cronbach alpha coefficient (Cronbach, 1951) and the mean correlation with other scales was used as an index of discriminant validity by calculating the mean correlation of each scale with other scales toward teachers' perceptions of instruction in Years 9-10 geometry classrooms and their views of the CLE.

Internal Consistency Reliability of the Modified WIHIC Scales for Teachers

Data analysis of the inter-items correlation matrix in Table 1 and Figures 1 and 2 shows that the Cronbach alpha coefficient (α) of *Satisfaction* is 0.63 and the Cronbach Alpha value based on the standardised item (β) of *Satisfaction* is 0.62, which indicate that in the geometry class, teachers did not believe that students found their work too difficult, and were satisfied with the learning environment. Overall, Table 1 shows that the *Difficulty* scale values are negative both for the Cronbach alpha coefficient ($\alpha = -0.69$) and Cronbach alpha value based on standardized items ($\beta = -0.93$). Teachers' perceptions are very strong in the *Equity* and the *Investigation* scales of the modified *WIHIC* based on standardized items ($\beta = 0.94$ and 0.91), and the Cronbach alpha ($\alpha = 0.94$ and 0.91). The Cronbach alpha values of five scales (*Student Cohesiveness*, *Teacher Support*, *Involvement*, *Task Orientation* and *Cooperation*) are strongly positive (i.e. *Student Cohesiveness* = 0.74, *Teacher Support* = 0.89, *Involvement* = 0.83, *Task Orientation* = 0.77 and *Cooperation* = 0.86). Hence the results indicate that teachers create a strong positive influence in students' perceptions and attitudes towards geometry learning, thus suggesting a positive classroom environment.

Table 2 demonstrates that teachers' perceptions of teaching geometry are positive. The mean scores for all scales increased from 3.01 to 4.45 for the *Teacher Support*. The perceptions of teaching geometry in the classroom learning environments show a narrow standard deviation range of less than 1 (from 0.42 to 0.83). The *Satisfaction* scale indicates a mean of 3.40 and Standard Deviation of 0.57, showing that teachers' perceptions are very positive in the use of the modified *WIHIC* survey to differentiate between teachers' attitudes to teach geometry and the nature of the CLE. As an example, *Teacher Support* rates highly with a mean of 4.45.

Table 1.
Reliability Statistics of the modified WIHIC Scales for teachers

WIHIC Scales	Cronbach's Alpha (α)	Cronbach's Alpha Based on Standardized Items (β)	No. of Items
Student Cohesiveness	0.74	0.71	5
Teacher Support	0.89	0.89	6
Involvement	0.83	0.84	8
Investigation	0.91	0.91	6
Task Orientation	0.77	0.77	7
Cooperation	0.86	0.86	7
Equity	0.94	0.94	6
Satisfaction	0.63	0.62	5
Difficulty	-0.69	-0.93	4

** $p < 0.01$, the sample consisted of 18 Years 9 and 10 teachers in 16 classes

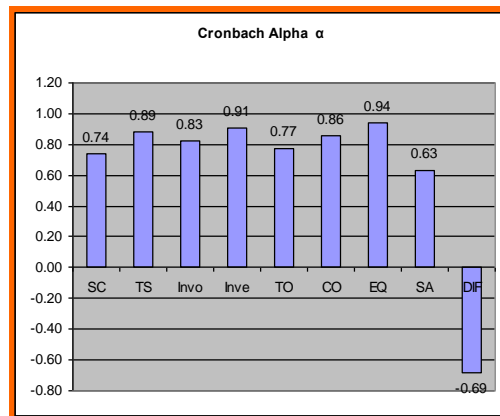

Figure 1. Alpha Reliability of the modified WIHIC scales for Teachers

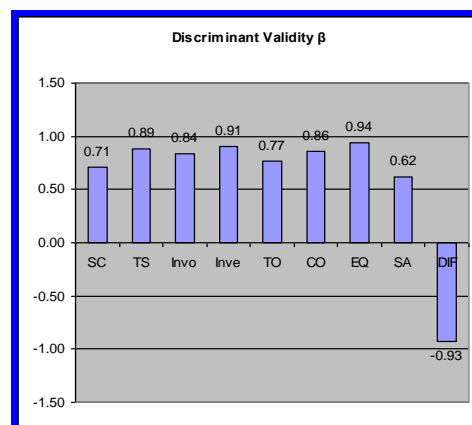

Figure 2. Discriminant validity for teacher details recorded in Table1

Table 2.

Mean scores of modified WIHIC, Standard Deviation and Standard Error Mean for teachers

WIHIC Scales	N	Mean	Std. Deviation	Std. Error Mean
Student Cohesiveness	18	4.21	.47	.11
Teacher Support	18	4.45	.51	.12
Involvement	18	3.69	.56	.13
Investigation	18	3.21	.83	.20
Task Orientation	18	4.10	.52	.12v
Cooperation	18	3.79	.67	.16
Equity	18	4.28	.81	.20
Satisfaction	18	3.40	.57	.13
Difficulty	18	3.01	.42	.10

Confirmation of Teachers’ Perceptions Toward Teaching Geometry Obtained through Interviews

The 18 teachers agreed to face-to-face interviews, and the responses of these teachers to the following four main questions provided information about their instructional strategies, roles and efforts to establish a positive CLE:

- Q. 1: What strategies do you use to create a comfortable classroom environment for your students?
- Q. 2: What teaching strategies do you use to control students who are not engaging in learning geometry in the mathematics classroom?
- Q. 3: In what ways do you help students understand mathematics, especially geometry?
- Q.4: How do you know whether this class has achieved the goals you have set in learning geometry?

The majority of teachers’ responses to Question 1 indicated that their central intentions were to be focused on the special needs of their students, and to have a sense of humour. They endeavoured to lead by example by preparing and organising their work and lesson preparation. Teachers used group discussions to promote understanding. Homework was recorded and records retained. The teachers generally considered that they developed a sense of responsibility among students by having them know the class rules and demanding respect for each other. They attempted to encourage students to work as a team and demonstrate proper behaviours, and they endeavoured to be tolerant. The latter quality was felt necessary to ensure understanding and to ensure good classroom management and positive attitudes among students.

Regarding Question 2, teachers used various strategies to control students who were not engaged in learning geometry. One teacher responded:

Well, I inform and remind students of their expectations and the importance of learning outcomes. I discipline students who misbehave when the class is learning. My work has to be prepared to an appropriate level for them to get on with (Teacher: T2; School: HS1).

Teachers used several strategies to control students who were not engaging in lessons by introducing group activities; using wait-time strategies questions (involving a definite pause between asking a question and requiring students to respond); seeking out reasons why students were not engaging; avoiding problems of lack of interest by making the lesson as interesting as possible, and providing feedback to students. Other strategies to counter misbehaviour involved using verbal warnings; having students work in isolation, lunchtime detention, and imposing school discipline policies:

I need to get students to work on task. To understand is in a student's interest and helps promoting interest in learning (Teacher: T3; School: HS5); and

To reprimand, make students responsible for their consequences. Isolate them to find out the reasons they misbehave; detention and letters home (Teacher: T9; School: HS3).

Responding to Question 3, teachers indicated that they helped students to understand the geometry, by using guided learning individually and by questioning and doing drill:

Individual help as requested; explanation with the class as a whole and individually as required, and examples are graded. Group work and paired work are used particularly for difficult examples by relating to practical problem in conjunction to systematic (structure) explanations in plain English. Practice lots of exercises; heavy use of examples and reinforcement using concrete materials, hand-on activity, various techniques. (Teacher: T1; School: HS1).

Answering Question 4, teachers said that they evaluated students by monitoring homework and class work; by observations and by asking questions to see if their classes achieved the goals they had for geometry. For example:

The first of students' work can tell me whether they understand or not. My role is to evaluate students by monitoring homework, class work, constant observations, tests, questioning, and listening to responses (Teacher: T1; School: HS1).

Teachers described their instructional strategies to assist students in geometry by explaining clearly and demonstrating a variety of techniques and new computer technology suitable for geometry teaching.

Table 1 and 2 demonstrate that the items of each scale in the survey support the instrument's internal consistency reliability and discriminant validity to distinguish between teachers' views towards their geometry teaching and the CLE. The findings of the qualitative component of the study (interviews) consistently supported the responses to the WIHIC questionnaire. The results confirm the validity and reliability of the WIHIC questionnaire that was used with the high school geometry teachers in Sydney. The Cronbach alpha coefficient (the internal consistency reliability) ranged from -0.69 to 0.94 and the discriminant validity ranged from -0.93 to 0.94. The results of the mean scores for all scales increased over the means from 3.01 to 4.45 and the simple correlation analyses from the nine scales of the modified WIHIC show that the associations between teachers' geometry instruction and their views towards their geometry CLE were statistically significant ($p < 0.01$) regarding Satisfaction with learning geometry.

Accordingly, Research Question 1 can be answered in the affirmative. An instrument now exists to assist teachers' in assessing their geometry CLE.

In answering Research Question 2, the results of the study suggest that:

The links between teachers' perceptions of their CLE and their achievements in teaching geometry concern the need for teachers to address five areas (Teacher preparation, Teacher Support, Investigation, Cooperation and Equity) in order to enhance the achievement of students in geometry. These were the major components of a positive CLE. Teachers who emphasise these areas acknowledge the findings of other researchers

who suggest that a positive CLE is needed in addition to teaching skill (Bennett, 1988; Treagust, Duit, & Fraser, 1996). Lessons began with revision to enforce understanding of the geometrical concepts taught earlier. Teachers usually controlled one third of the lesson time in any one period, spent approximately five to ten minutes for house-keeping, and then students spent the remaining time working independently. The teaching approach invariably utilised a traditional teaching method such as blackboard and chalk to display and explain concepts to students. In most schools, the period time for teaching was generally 45 minutes though some lessons were of 30 minutes duration.

Teachers mostly worked on explaining mathematical concepts, with much of their instruction relating to symbols. They considered that their lessons were generally well-structured and planned and took into account tasks and interactions aligned with the goals of geometry learning. The resources/materials that were employed in these lessons were often sparse, though the structure was adequate in providing sufficient time in the lesson for activities and for rounding off lessons with revision. During occasional observations of the teachers by the authors, they were professional in their approach, giving students' confidence in their ability to teach geometry, and their questioning strategies appeared to enhance the students' understanding and ability to solve problems. According to the teachers, all students interacted with them cooperatively and participated in the lessons, asking questions during lessons.

Students' Performances in Geometry

Many students learn geometry in the secondary school lacking the prior knowledge to do so successfully – a situation evident among the students involved in the present study. These students often solved geometrical problems well with visual but not with verbal cues. Geometrical terminology often caused confusion due to students' poor use of spoken English. The goals of geometry learning are to “develop thinking abilities as a foundation for the real world, and to convey the knowledge needed in geometry and to teach how to read and interpret mathematical arguments” (Board of Studies, New South Wales, 2002, p. 12). In the secondary school, geometry in the mathematical curriculum involves recognising and naming geometrical shapes, using the symbolism for geometrical concepts, developing skills with measurement and construction tools (i.e. compass, ruler and protractor), and using formulae in the measurement (Board of Studies, NSW, 2002). The goal in geometry education is for students to develop an understanding of the relevant concepts and communicate about quantities and unknown values through the use of signs, symbols, models, graphs, and mathematical terms. Students require a strong foundation in basic geometrical skills and they need to understand the meaning of mathematical contexts to assist their ability to discuss the subject purposefully.

Conclusion

Other suggestions from the teacher interviews which impact on learning and are realistic for ESL teachers to use in their classrooms are: (1) The use of posters in classrooms; (2) Allowing students to learn in a personally meaningful way, and maintain a positive and receptive climate for questions and answers; and (3) Ensuring that students are aware that they are accepted, respected and welcomed into each class. As a result, schools will have the chance of producing students who can achieve, who possess a sense of satisfaction with the school, and who have a positive perception of their classrooms (Young, 1998).

Outcomes of this study support the finding of Treagust, Duit, & Fraser (1996) who pointed out that using successful teaching methodologies to enhance the understanding of students' learning mathematics will help students of *all* abilities to build onto their own knowledge of mathematics. Teaching methodologies are successful when students understand how to solve problems by applying the different aspects of concepts taught. Teachers need to accept students' and colleagues' ideas as central knowledge in mathematics in order to develop their own personal teaching approaches.

References

- Baker, P. B. & Digiovanni, L. W. (2005). Narratives on culturally relevant pedagogy: Personal responses to the standardized curriculum. *Current Issues in Education*, 8(15). Retrieved from the World Wide Web on 28-02-2010: <http://cie.ed.asu.edu/volume8/number22/>
- Battista, M. T., & Clements, D. H. (1995). Geometry and proof. *Mathematics Teacher*, 88(1), 48-54.
- Bennett, N. (1988). The effective primary school teacher: The search for a theory of pedagogy. *Teaching and Teacher Education*, 4, 19-30.
- Bills, L. (1999). (Ed.). *Towards a pedagogy of mathematics initial teacher education*. Proceedings of the British Society for Research into Learning Mathematics 19(3) November 1999.
- Board of Studies in New South Wales. (2002). *Mathematics Year 9-10, stage 5, support for Advanced, Intermediate and Standard Courses*. Sydney: Author.
- Cronbach, L. J. (1951). Coefficient alpha and the internal structure of tests. *Psychometrika*, 16(3), 297-334.
- Ding, L., & Jones, K. (2006). Teaching geometry in lower secondary school in Shanghai, China, *Proceedings of the British Society for Research into Learning Mathematics*, 26(1), 41-46.
- Fraser, B. J. (1994). Research on classroom and school climate. In D. Gabel (Ed.), *Handbook of research on science teaching and learning* (pp. 493-541). New York: Macmillan.
- Hill, P. W., Rowe, K. J., & Holmes-Smith, P. (1995). *Learning environments and student outcomes in high school senior biology classes*. Paper presented at the annual Meeting of National Association for Research in Science Teaching, Anaheim, USA.
- Hinsley, D. A., Hayes, J. R., & Simon, H. A., (1977). From words to equations: meaning and representation in algebra word problems. In P. A. Carpenter, & M. Just (Eds.). *Cognitive processes in comprehension* (pp. 89-106). Hillsdale, NJ: Erlbaum.
- Punch, K. F. (2000). *Introduction to social research: quantitative & qualitative approaches*. Thousand Oaks, CA: Sage Publications Inc.
- Pusey, E. L. (2003). *The van Hiele model of reasoning in geometry: A literature review*. Unpublished Thesis (M.S.)-North Carolina State University. Retrieved on 14 April 2007 from the World Wide Web: <http://www.lib.ncsu.edu/theses/available/etd-04012003-202147/unrestricted/etd.pdf>
- Rawnsley, D. G. (1998). *Associations between classroom learning environments, teacher interpersonal behaviour and student outcomes in secondary mathematics classroom*. Perth: Curtin University of Technology. URN: adt-wcu 20020729.094016.
- Sperling, D. (2008). *Basic math for ESL teachers*. . Retrieved on 20 March 2010 from the World Wide Web: <http://www.eslcafe.com/idea/idea.cgi?display:1000067987-26234.txt>
- Tobin, K., & Fraser, B. J. (1998). Qualitative and quantitative landscapes of classroom learning environments. In B. J. Fraser & K. G. Tobin (Eds.), *International Handbook of Science Education*.
- Treagust, D. F., Duit, R., & Fraser, B. J. (1996). *Improving Teaching and Learning in Science and Mathematics*, Teachers College, 1234 Amsterdam Avenue, New York, NY 10027.
- Wetzel, D. (2009). *Teaching strategies in math for ESL students*. Retrieved on 1 March 2010 from the World Wide Web: http://continuingeducation.suite101.com/article.cfm/teaching_math_to_ESL_students.
- Young, D.J. (1998). *Characteristics of Rural School: A Longitudinal Study of Western Australian Rural High School Students*. Paper presented to the Annual Meeting of the American Educational Research Association 13-17th April 1998, San Diego, California.

Young Children’s Measurement Knowledge: Understandings about Comparison at the Commencement of Schooling

Amy MacDonald
Charles Sturt University
<amacdonald@csu.edu.au>

This paper presents data gathered during a three-year study that explored the experiences with measurement that children have in prior-to-school and out-of-school contexts, and the ways in which children are able to represent these experiences. In this present investigation, examples of the children’s responses to an open-ended drawing task, collected at the commencement of Kindergarten, are backward-mapped in relation to the draft Australian Curriculum’s Measurement and Geometry strand for Kindergarten, with a focus on the Comparison sub-strand. This data demonstrates that most of the measurement skills described in the Comparison sub-strand of the Australian Curriculum are being exhibited by children at the commencement of schooling, prior to any formal teaching about measurement taking place.

In March 2010 the draft K-10 Australian Curriculum for Mathematics was released for comment and review. The newly framed curriculum has Measurement and Geometry as a strand that covers the notion of “measurement sense” (Joram, 2003). These two content areas have been combined in order to emphasise their interconnections and enhance their practical relevance (Australian Curriculum, Assessment and Reporting Authority [ACARA], 2010). Within this strand, children learn to make meaningful measurements of quantities, choose appropriate metric units of measurement, understand connections between units, and calculate derived measures (ACARA, 2010). In relation to the Measurement and Geometry strand for Kindergarten, the measurement concepts focused on are those of Comparison and Time. This present investigation explores whether the Comparison sub-strand of the Australian Curriculum for Kindergarten reflects the measurement knowledge which children already possess as they commence school.

Background

In the past ten years there have been numerous studies that have examined children’s measurement understanding (e.g. Clarke, Clarke, & Cheeseman, 2006; Curry & Outhred, 2005; Irwin, Vistro-Yu, & Ell, 2004; Stephan, Cobb, Gravemeijer, & Estes, 2001). Some of this work has considered, in particular, young children’s understandings of measurement. Curry and Outhred’s (2005) work on the links between the measurement of length, area and volume contributed the development of the *Count Me Into Measurement* [CMIM] program, designed to assess children’s knowledge of these three measurement concepts. Findings from this study suggest that the order in which certain measurement concepts are addressed in the curriculum may need to be readdressed. Clarke, Clarke and Cheeseman (2006) have similarly worked to develop strategies for assessing the children’s knowledge, with the development of the Early Numeracy Research Project’s [ENRP] task-based interview. While the ENRP interview addressed numeracy more broadly, some measurement tasks were included. Results to the tasks found that most of the children were arriving at school “with considerable skills and understandings in areas that have been traditional mathematics content for that age...this means that expectations could be raised considerably in terms of what can be achieved in that first year” (Clarke et al., 2006, p. 97).



Irwin et al. (2004) considered the importance of young children's informal experiences in the development of their understanding about length measurement in their cross-cultural study of children from New Zealand and the Philippines. Using a series of five tasks, Irwin et al. highlighted the important relationship between children's informal and formal measurement experiences. Their findings suggested that children's informal measurement experiences made a significant contribution to the children's learning of various measurement concepts. However, Irwin et al. suggested that, "the transition from informal to formal measurement needs much more time and care" (p. 22). Bobis, Mulligan and Lowrie (2009) have also emphasised the important role of children's informal understandings, describing these as "a crucial step towards understanding mathematics" (p. 14). Echoing the suggestion of Irwin et al., Bobis et al. highlighted that a significant concern for teachers is the ability to help children make connections between what they already know and the knowledge they will acquire in the classroom. Bobis et al. (2009) stated that:

... the realisation that children already possess a great deal of knowledge before formal instruction occurs has caused many educators to reconsider their beliefs about how children learn mathematics and about the ability of children to individually construct their own knowledge. (p. 14)

In response to this body of research, this present investigation considers the informal understandings about measurement—in particular, the concept of comparison—which children possess as they commence school, and the alignment of these understandings with the curriculum content that they will be presented with in the formal classroom setting.

Research Design and Methods

This paper presents a selection of data gathered during a three-year study that explored the experiences with measurement that children have in prior-to-school and out-of-school contexts, and the ways in which children are able to represent these experiences. In this present investigation, examples of the children's responses to an open-ended drawing task, collected at the commencement of Kindergarten, are backward-mapped in relation to the draft Australian Curriculum's Comparison sub-strand for Kindergarten.

Participants

The data were collected at two schools in regional NSW, with the schools selected to represent the typical variance of the town's population. School A is what can be considered a low-SES school. To position the school within the current Australian educational climate, the 'My School' website states the school's Index of Community Socio-Educational Advantage (ICSEA) value as being 790. As an indication of the significance of this value, the average ICSEA score is between 900 and 1100. In addition, 70% of students are in the bottom quarter; that is, a significantly high proportion of students are educationally disadvantaged compared with the spread of students across Australia. Furthermore, the school has a dominance of Department of Housing residents in the suburb; approximately 45% of students coming from single-parent families; a highly mobile student population; and approximately 40% of students being of Aboriginal and Torres Strait Islander descent. By comparison, School B reflects the more middle-class sector of the population, with an ICSEA value of 994. The student population includes approximately 7% Indigenous students, and about 5% of students are from a non-English speaking background. School B represents a greater rate of educational advantage, with only 25% of students in the bottom quarter.

The participant children had just commenced their first year of formal schooling, known as Kindergarten in NSW. Children in NSW commence Kindergarten in late January. They “must start school by the time they are 6 years old but they may start in the year that they turn 5, provided their fifth birthday is before July 31 of that year. Hence, it is possible for a new Kindergarten class to contain children aged between 4 years 6 months and 6 years” (Perry & Dockett, 2005a, p.65). 31 children from School A completed the task, as did 52 children from School B, giving a total of 83 participants in this present investigation.

Data Collection and Analysis

The data were collected in March 2009, at which time the children had been at school for approximately 6 weeks. It was confirmed by all of the Kindergarten teachers that no formal teaching about measurement had taken place in the classroom up to this point in time. The children were asked to draw a picture of something tall and something short, and then provide a description of their drawing. The task was deliberately designed to be open ended, allowing the children to reflect upon their own personal experiences with the concept, and represent these experiences in a rich manner. Although some children chose to complete more than one drawing, for the purpose of this investigation only one drawing per child was analysed. Analysis was based on the Comparison sub-strand of the draft Australian Curriculum, with the drawings and their accompanying descriptions being coded according to the sub-strand ‘elaborations’, these being:

1. Understanding that comparing is the most basic of measurement ideas and that the key idea is to compare like attributes;
2. Comparing objects directly, by placing one object against another to determine which one is longer or using pouring from one container to the other to see which one holds more;
3. Using suitable language associated with the measurement attributes, such as tall and taller, heavy and heavier, holds more and holds less; and
4. Ordering things by direct comparison such as saying which of the two children is taller by standing back to back or holding an object in each hand and saying ‘this one is heavier than the other one’.

It should be noted, however, that only the first four of the five Comparison sub-strand elaborations have been utilised, as the fifth was not befitting the nature of the task given to the children.

Decisions were made as to which, if any, of these elaborations were represented by each drawing and its description. Once the drawings had been coded, counts per elaboration were made in order to determine the percentage distribution of results across the four elaborations, offering an overall picture of the children’s understanding in relation to the Comparison sub-strand.

Results

The following tables (Table 1 to Table 4) show the proportion of students who were able to demonstrate each of the Comparison elaborations in their response to the drawing task. In addition, an example response has been provided for each elaboration.

Table 1
Elaboration 1

Elaboration	Proportion (N=83)	Example
Understanding that comparing is the most basic of measurement ideas and that the key idea is to compare like attributes.	93%	<p>Figure 1. "That's my Mum and she's tall. That's me and I'm short."</p>

As can be drawn from Tables 1, 2 and 3, the majority of students were able to demonstrate an understanding of the first three elaborations of the Comparison sub-strand at the commencement of Kindergarten. With regard to the first elaboration, almost all of the students (93%) were able to represent a comparison of two objects according to the attribute of height, and could identify which object was 'tall' and which was 'short'. As shown in Figure 1, Chloe was able to represent herself standing next to her mother, and identify that her mother is tall and that she is short. Similarly, Luke drew "a tall tower and a short tower", while Dulce drew a house and a person, explaining, "the house is tall and the person is short."

Table 2
Elaboration 2

Elaboration	Proportion (N=83)	Example
Comparing objects directly, by placing one object against another to determine which one is longer or using pouring from one container to the other to see which one holds more.	89%	<p>Figure 2. "That's when I went and saw an Australian flag and that's me. The flag's taller than me."</p>

The second elaboration refers to the ability to compare objects directly, and, in the case of this specific task, ascertain which object is taller or shorter. As this was a drawing task,

direct comparison could be evidenced by the positioning of the objects along a common baseline. As shown in Table 2, 89% of the children were able to represent objects in this manner and state which was the taller/shorter of the two, as did Brody in his drawing of himself next to a flagpole (Figure 2). Other examples included Sarah, who drew a tree next to a volcano and stated, “the tree is taller”, and Tobias, who described his drawing as “Me and Mum. My Mum’s the tallest.”

Table 3
Elaboration 3

Elaboration	Proportion (N=83)	Example
Using suitable language associated with the measurement attributes, such as tall and taller, heavy and heavier, holds more and holds less.	90%	

Figure 3. “The person is short and the skyscraper is tall. The monster is shorter than the skyscraper but taller than the person.”

The third elaboration requires that children use suitable language associated with measurement attributes, and, as shown in Table 3, 90% of the children in this investigation were able to do so despite having received no formal teaching about measurement at this point in time. Indeed, some children were able to use the appropriate language in quite a complex manner, such as Blake, who offered the following description of his drawing: “The person is short and the sky scraper is tall. The monster is shorter than the skyscraper but taller than the person” (Figure 3). Those children who were not classified among the 90% generally did not use *incorrect* terms, but rather terms, which were not the *most suitable* given the task, explicitly focused on height. Examples of these less-suitable words included “big” and “little”, “giant” and “tiny”, etc.

The final elaboration that was addressed in this investigation required children to order objects based on direct comparison. Similar to the second elaboration, it was expected that the children represent their chosen objects in order along a common baseline, identifying which was the tallest and/or shortest. While only 33% of children’s responses demonstrated this, it must be acknowledged that the task *did* only ask the children to draw something tall and something short, so the representation of more than two objects took some initiative on the child’s behalf. Chelsea achieved this with her drawing of four flowers shown in order of height, and in her description she identified which was the tallest and which was the shortest (Figure 4). Similarly, Nathan drew the members of his family and explained “Dad’s the tallest. Bonnie’s the shortest.”

Table 4
Elaboration 4

Elaboration	Proportion (N=83)	Example
Ordering things by direct comparison such as saying which of two children is taller by standing them back to back or holding an object in each hand and saying 'this one is heavier than the other one'.	33%	

Figure 4. "This flower's the tallest. This is the shortest."

Discussion

The elaborations of the Comparison sub-strand for Kindergarten are organised to reflect a progression in understanding about measurement concepts. To summarise this progression, children's understanding develops from the notion of comparing like attributes through to ordering objects as a result of direct comparison. However, implicit in this progression are a number of specific skills which children exhibit as they develop more sophisticated understandings of comparison.

When considering the notions of 'tall' and 'short', a starting point for young children is often the idea of using themselves as a benchmark – that is, deciding whether they are taller than or shorter than the object being considered. As Bobis et al. (2009) explain, children's natural baseline is their body. Interestingly, very few children in this investigation actually did use themselves as a benchmark, and those who did usually compared themselves to a familiar adult, such as their mother or father. In doing so, these children are also showing a more advanced understanding of comparison by demonstrating an ability to compare two similar objects. Often this involved the comparison of familiar people, not always including themselves. For example, Rhys described his drawing as, "My Dad is a little bit tall. Mummy is a little bit shorter than Dad", while Leteasha drew a series of people and said "Mum is tall. The baby is shortest." Other children chose to draw more generic objects, such as Luke who drew "A tall tower and a short tower", or Brodie who similarly drew "A short box and a tall box." However, the majority of children were able to extend the notion of comparison beyond comparing *same* objects to comparing *different* objects. In some cases, the children did indeed use themselves as the basis for comparison, such as Kyle, who drew a picture of himself and a monster and stated that, "the monster is taller than me", or Lara who drew herself standing next to a tree showing the difference in their heights. But more frequently, children drew two different objects and considered their varied heights.

When considering progression in understanding about comparison, at the most sophisticated level children demonstrate an ability to compare more than two objects. As stated earlier, the task given to the children did not explicitly ask them to draw more than two objects, however many children indeed chose to do so. As with the comparison of two

objects, the comparing and ordering of three or more objects can be considered at two levels: the comparing of *same* objects, and the comparing of *different* objects. The children in this investigation demonstrated both. For example, Wayne chose to draw “a big rope, a short rope, and a middle-sized rope”, whereas Ethan drew “a building, a giant, a lady beetle and a speck of dirt” in descending order of height.

Woven throughout this progression in understanding about comparison is the ability to use the language of measurement in an appropriate manner. With only a small exception, the children in this investigation were able to use language appropriate to length measurement in both a dichotomous manner (i.e. “tall” and “short”), as well as in a comparative manner (i.e. “taller than” and “shorter than”). As noted earlier, the children demonstrated this ability to appropriately use measurement language prior to any formal teaching about measurement taking place. Thus, it can reasonably be assumed that the ability to use such language has evolved out of children’s own informal, personal engagements with measurement. As was evidenced in the drawings, the children have drawn upon a range of rich and personally significant experiences in order to demonstrate their measurement understanding.

Conclusions and Implications

As the data presented in this paper has shown, the children in this investigation demonstrated the comparison skills described in the draft Australian Curriculum for Kindergarten at the commencement of school, prior to any formal teaching about measurement taking place. Of significance is the fact that these skills were exhibited despite the rate of educational disadvantage experienced by many of the participant children.

The fact that children are coming to school with these skills is a positive outcome because it means that the children will be confident with the curriculum material they will encounter in the classroom setting, and their familiarity with the content will enable them to achieve success in their formal learning. However, it must also be considered how these children can be extended beyond their existing understandings so that their classroom engagements will be stimulating and developmental. As Perry and Dockett (2005b) advocate, current learning must be recognised and used so that children are challenged by their mathematics learning and find that mathematics can be an exciting subject. By utilising tasks such as the one described in this paper, educators can not only elicit the prior experiences and understandings of children, but also extend children’s learning in a rich and meaningful manner.

References

- Australian Curriculum, Assessment and Reporting Authority [ACARA]. (2010). *Australian Curriculum Draft Consultation Version 1.0.1*. Available online from <http://www.australiancurriculum.edu.au>
- Bobis, J., Mulligan, J., & Lowrie, T. (2009). *Mathematics for children: Challenging children to think mathematically* (3rd ed.). Frenchs Forest, NSW: Pearson Education Australia.
- Clarke, B., Clarke, D., & Cheeseman, J. (2006). The mathematical knowledge and understanding young children bring to school. *Mathematics Education Research Journal*, 18(1), 78-102.
- Curry, M., & Outhred, L. (2005). Conceptual understanding of spatial measurement. In P. Clarkson, A. Downton, D. Gronn, M. Horne, A. McDonough, R. Pierce, & A. Roche (Eds.), *Building connections: Theory, research and practice*. Proceedings of the 28th annual conference of the Mathematics Education Research Group of Australasia [MERGA] (pp.265-272). Sydney: MERGA.
- Irwin, K.C., Vistro-Yu, C.P., & Eil, F.R. (2004). Understanding linear measurement: A comparison of Filipino and New Zealand children. *Mathematics Education Research Journal*, 16(2), 3-24.

- Joram, E. (2003). Benchmarks as tools for developing measurement sense. In D.H. Clements & G. Bright (Eds.), *Learning and teaching measurement*. 2003 Yearbook of the National Council of Teachers of Mathematics [NCTM] (pp.57-67). Reston, VA: NCTM.
- Perry, B., & Dockett, S. (2005a). "I know that you don't have to work hard": Mathematics learning in the first year of primary school. In H.L. Chick & J.L. Vincent (Eds.), *Proceedings of the 29th conference of the International Group for the Psychology of Mathematics Education [PME]* (vol. 4, pp.65-72). Melbourne: PME.
- Perry, B., & Dockett, S. (2005b). What did you do in maths today? *Australian Journal of Early Childhood*, 30(3), 32-36.
- Stephan, M., Cobb, P., Gravemeijer, K., & Estes, B. (2001). The role of tools in supporting students' development of measurement conceptions. In A. Cuoco (Ed.), *The roles of representation in school mathematics*. 2001 Yearbook of the National Council of Teachers of Mathematics [NCTM] (pp.63-76). Reston, VA: NCTM.

Developing a Framework for the Selection of Picture Books to Promote Early Mathematical Development

Jennifer Marston

Macquarie University

<jennie.marston@mq.edu.au>

The purpose of this paper is to describe the development of a framework to facilitate the selection and evaluation of picture books that may be useful in promoting and developing mathematical concepts in young children. Three types of mathematical picture books were initially recognised with intercoder reliability of 0.92. Seven categories were identified in the framework: Mathematical content; Curriculum content, policies, and principles; Integration of mathematics content; Mathematical meaning; Mathematical problem solving and reasoning; Affordance for mathematics learning; and Pedagogical implementation.

There is a wide range of children's literature, such as picture books and trade books that may directly or indirectly promote mathematics learning. Shatzer (2008) emphasised the importance of choosing literature that both constructs mathematical meaning and makes connections to students' lives. Research suggests that shared book experiences assist in mathematical concept development in the early years (Anderson, Anderson, & Shapiro, 2005; Casey, Kersh, & Mercer Young, 2004; van den Heuvel-Panhuizen & van den Boogaard, 2008). Curriculum bodies (Australian Curriculum, Assessment and Reporting Authority, 2010; National Council of Teachers of Mathematics, 2000) and professional journals such as *Teaching Children Mathematics* and *Australian Primary Mathematics Classroom* encourage the integration of literacy and numeracy to teach mathematical concepts by promoting the use of children's literature. In practice, there has been some implementation of children's literature in mathematics learning through teacher resource books (Griffiths & Clyne, 1988; McDonald, 2009) and through the production of individual and series-based mathematics story books (Neuschwander, 1997). However, there are few guidelines or frameworks that can inform teacher choice or be used to evaluate books for their suitability.

Picture Books for Mathematics Learning

A picture book is defined as a book suitable for very young children, containing multiple visual images. It is often a simple narrative or descriptive text that is intended to be read aloud and shared between an adult and child or group of children (Muir, 1982). For the purpose of this research, "mathematical" picture books are defined as picture books with mathematical content present in both the text and images. The text may be either descriptive or narrative, with the mathematical content:

- (i) perceived to be occurring; these books are written to entertain and the mathematical concepts are unintentional and incidental (e.g., *Alexander's Outing*, Allen, 1992).
- (ii) explicitly referenced; these include counting books and "trade" books (those written in picture book format to specifically teach or develop one or more mathematical concepts), for example, *Minnie's Diner: A multiplying menu* (Dodds, 2004) or series such as *Sir Cumference* (Neuschwander, 1997).
- (iii) embedded; picture books that have been written to entertain as in (i) but include purposefully embedded mathematical ideas, for example, the work of Anno (1997).

Using Picture Books to Develop Mathematical Concepts

Picture books and other forms of children's literature have been used primarily to support an integrated approach to early learning curriculum. Bosma and De Vries Guth (1995, p. 7) asserted that literature is the "thread that weaves" the integrated curriculum together. This integrated approach is considered to make lessons more relevant, as it employs the elements of "engagement" and "connectedness" such as promoted by the Quality Teaching Framework (NSW Department of Education & Training, 2003) and helps children "better understand mathematical ideas and their application to real-world situations" (Whitin, 1992, p. 28). The use of picture books also supports student learning in familiar settings. If students can see mathematics as part of their everyday lives, they will be encouraged to value mathematics more than they would otherwise and build confidence in their own mathematical abilities (Whitin, 1992). Meaningful contexts provided by picture books also afford opportunities for problem solving and mathematical reasoning (Schiro, 1997; Whitin, 1992).

Background Literature

Picture books, not specifically written to teach mathematics, which often include mathematical ideas, images and linguistic terms, have been shown to promote mathematical play, discussion, disposition to mathematics (Young-Loveridge, 2004; van den Heuvel-Panhuizen & van den Boogaard, 2008) and improved mathematical achievement (Jennings, Jennings, Richey & Dixon-Krauss, 1992). Van den Heuvel-Panhuizen and van den Boogaard (2008) found that half the student utterances in their study related to mathematics and of these, most related to number, space and size (Anderson et al., 2005; van den Heuvel-Panhuizen & van den Boogaard, 2008). Anderson et al. (2005) believed that just reading a picture book is not sufficient, but that mathematical talk must be meaningful. However, van den Heuvel-Panhuizen and van den Boogaard (2008) concluded that five year old children do engage mathematically with such texts, even without adult intervention. These studies support the importance of the visual images in picture books, indicating that most of the discourse centred on the illustrations. Casey et al. (2004) showed that students who encountered geometry through specifically written storytelling sagas made greater improvement in mathematical skills than those who studied the geometry without the saga, while Halpern (1996) found adding annotations to a book did not affect the enjoyment but added to student understanding.

A number of studies, including Thomas, Mulligan, and Goldin (2002), emphasised the important role of visual representations and imagery in the development of mathematical concepts in young children. Research in early literacy has also emphasised the importance of visual images and illustrations in representing meaning in the text (Kress & van Leeuwen, 1996; Lewis, 2001). The interrelationship between text and visual images in picture books is critical to understanding how children form concepts, including mathematical concepts. This raises the question of how children interact with developing mathematical language and concepts. Do the visual images provided in picture books encourage the mathematical ideas and representations needed in the development of mathematical concepts and match those constructed by the young readers?

Method

Aims and Research Questions

An exploratory descriptive study has been designed to evaluate the role of picture books in facilitating mathematical development among children in the early years of formal schooling. The questions to be explored are:

- What potential do picture books (of different types) have for facilitating the development of mathematical concepts in young children?
- Do some picture books facilitate discussion of mathematical concepts more than others?

The aims of the research include the development of a framework for identifying and evaluating mathematical content in picture books and analysing students' verbal responses during shared book experiences, in order to assess how books can facilitate the development of mathematical concepts.

A pilot study of child-teacher and child-child talk during shared book experiences will inform the main study. The two parts of the main study will investigate the use of:

- picture books with perceived mathematical content, and
- purpose-written picture books with mathematical content.

These naturalistic studies will involve 54 students, six teachers, and six schools. Small groups of Year 1 children (approximately six years old) and their teacher will be engaged in shared reading of identified picture books with different types of mathematical content. There will be an emphasis on the areas of measurement, patterns and algebra, and problem solving to ascertain whether number and space concepts also predominate in this study.

Frameworks and Instruments for Selection and Evaluation of Picture Books

Some frameworks have been developed for this purpose but they predominantly appear to relate to the usefulness of trade books. After the introduction of the first NCTM standards (1989), criteria were set for the inclusion of trade books in California's mathematics program; these included relevance to the maths concepts, grade appropriateness, suitability for integration, accessibility of resources, and literacy quality (Donahue, 1996). Schiro (1997) and Whitin and Whitin (2001) also emphasised the importance of the literary quality of the books that were to be considered for their mathematical content. The flood of books developed to address the second NCTM standards (2000) was not always of a high literary standard and they were often described as "glorified textbooks" (Hellwig, Monroe, & Jacobs, 2000, p. 139).

Schiro (1997) developed an instrument for both evaluating the mathematical and literary value of books that has been widely used and adapted by others. His eleven mathematical standards, with various sub-categories, consider mathematical accuracy, worthiness, visibility, appropriateness, involvement of the reader in the mathematics, the effectiveness of the presentation, the complementing of the mathematics and story, the availability of resources and mathematical information, the application of the content, and the view it presents of mathematics. Hellwig et al. (2000) produced an instrument with five categories (accuracy, visual and verbal appeal, connections, audience, and the 'wow' factor), while Whitin and Whitin (2001) only emphasised two criteria: books that invite varied response, and books that reflect an aesthetic dimension. Hunsader (2004) reduced

Schiro's (1997) mathematical criteria to six categories to speed up the assessment process and eliminate trivial and repeated or overlapping questions. She also included a five-point scale that allowed books to be scored against each other. Halsey (2005) added a Likert scale to score results and two more criteria to Schiro's (1997) original instrument: overall literary quality and overall mathematical quality.

Developing the Framework

Previous studies using picture books for mathematical concept development have not compared the efficacy of different types of books. The planned study required the selection of appropriate mathematical picture books that addressed the three categories of mathematical picture books described previously. Currently, teachers do not have contemporary criteria on which to base their choice of picture books for use in the classroom. They often impose mathematics on any book or miss mathematical opportunities. Schiro's (1997) instrument is a comprehensive and valuable tool to evaluate children's mathematical trade books. However, this and the subsequent frameworks are limited because they all only appear to address the category of trade books.

The development of a new framework integrates aspects in previous instruments but also takes into consideration the complex range of factors that contribute to the effective use of picture books to promote mathematical problem solving, including recent research in young children's development of mathematical concepts, the importance of the interaction of text and visual images, changes in curriculum (policies and principles), and current pedagogy.

Procedures

A collection of 122 picture books was originally sourced. These included 114 picture books and ten mathematical trade books. To ensure the picture books were current and examples of quality literature, a list of 240 books that had won Australian (e.g., Children's Book Council of Australia, 2009) or international awards in the past ten years was compiled and the books were obtained from libraries or booksellers for the collection. It was anticipated that many, but not all, of these would contain "perceived" or "embedded" mathematics; some are already included in teacher resource books (McDonald, 2009). The trade books were sourced from American book sellers via the internet, as they are not readily available through Australian booksellers or libraries. Two recent books by award-winning authors with researcher-identified "embedded" mathematics and 12 books used by teachers in mathematics learning and teaching for many years (e.g., *Alexander's Outing*, Allen, 1992) were also added to the collection to test the framework's reliability against previous usage.

The books were then read, categorised, and analysed by the researcher for features previously illustrated in the literature. The procedure involved labelling visible mathematical concepts in the text and visual images, identifying the interaction between text and visual images, recording mathematical inaccuracies, and noting opportunities for classroom learning experiences. This process, which occurred concurrently with the development of the framework, also assisted its refinement.

It became clear to the researcher that the three categories of books with mathematical content did exist. Every book analysed by the researcher was found to have some degree of mathematical content; however, the quantity, quality, and potential for use in mathematical learning experiences needed to be evaluated against the framework. To trial the

framework, a total of 50 books from each category (34 with perceived mathematics, eight with embedded mathematics and eight trade books) was randomly chosen by the researcher from the original collection. These books were then evaluated against the expanded version of the framework (see Table 1 below) by the researcher and a Research Assistant, both with education/classroom teacher backgrounds. They independently coded clean copies of the books and the research assistant also categorised the books.

The Framework’s Classification Scheme

The classification scheme developed is summarised in Table 1. This new instrument contains seven categories, each with a series of elements, which are included in the expanded version of the framework, along with examples of books displaying each element. A Likert scale of five levels is included for each element against which a book’s mathematical content and potential for use can be evaluated. A description of each category follows.

Table 1
Classification Scheme

Code	Categories	Definition
MC	Mathematical Content	The content is visible, displayed with accuracy and authenticity in mathematical contexts, and provides opportunities for developing mathematical language.
CPP	Curriculum Content, Policies, and Principles	Mathematical content is consistent with relevant curricula and reflects policies of gender equity, cultural and socioeconomic diversity, inclusiveness, and environmental awareness.
IMC	Integration of Mathematics Content	Mathematical content is linked within and across mathematical strands, across other disciplines, and with Information and Communication Technology.
MM	Mathematical Meaning	The text and visual images are presented in authentic contexts; concepts are developed in an effective, sequential, and interrelated way.
MPS	Mathematical Problem Solving and Reasoning	The text and images afford opportunities for problem solving, problem posing, co-operative strategies, and creative multiple solution paths.
AML	Affordance for Mathematics Learning	The learning experience is motivating, engaging, and enjoyable, and promotes positive values and attitudes towards mathematics and creative intellectual endeavour.
PI	Pedagogical Implementation	The mathematical content in quality picture books is applicable to a variety of learning situations.

The category of *Mathematical Content* addresses the mathematical content presented within the text and visual images — perceived, explicit or embedded. The mathematical content of the book needs to be visible to or recognised by the reader in the title, text or representations (symbols, diagrams, pictures, and actions); this category includes the

appropriate positioning, size and clarity of the mathematical ideas. However, visibility does not determine the amount or quality of the mathematical content. Mathematical content (linguistic terms, concepts, and calculations) and representations should be portrayed accurately. The content ought to provide opportunity for the development of mathematical knowledge and skills (content and concepts) and for students to verbalise mathematics ideas using mathematical language. The text and visual images should demonstrate real life experiences, as mathematical content portrayed in everyday situations provides authenticity.

All countries (and some individual states) have developed a mathematics curriculum for their compulsory years of schooling and/or include guidelines for the early or pre-school years. For example, in Australia there is the Early Years Learning Framework and a national mathematics curriculum (ACARA, 2010) is currently being developed. Therefore the category of *Curriculum Content, Policies, and Principles* is included. However, some education systems not only include policies on content, they also consider principles such as gender, cultural, and socioeconomic equity, inclusiveness, and environmental awareness. In Australia, policy is not developed without the accompanying principles, but this is not the case in all countries. These principles are included in this framework, although it is realised that they may not have the same importance everywhere. As the prime purpose of integrating picture books into the curriculum is to facilitate student learning, the mathematical content needs to correspond to or complement the relevant school curriculum policies and principles at the relevant stage of development.

Integration of Mathematics Content, within mathematics curriculum (e.g., number and patterns), across the mathematics curriculum (e.g., measurement and number), across disciplines (e.g., Mathematics and Science), and with ***Information and Communication Technology*** are included elements. Integration is considered to make lessons more relevant to student learning; for teachers, it also facilitates the delivery of knowledge and skills in mathematics and a variety of disciplines.

The category of *Mathematical Meaning* incorporates four elements. It is important that the mathematics itself is authentic (that is, it arises naturally from the text and is not contrived to present a mathematical concept) and it should develop in an effective and sequential way. The text and visual images should also work together to aid meaning of mathematical concepts. Although there should be connections between the text and visual images, Lewis (2001) stated the degree of interaction can range from symmetrical to contradiction; it is the effectiveness of the interrelationship of the text and visual images that facilitates mathematical meaning.

Mathematical Problem Solving and Reasoning addresses the process strands of the mathematics curriculum. This category explores opportunities in the text and visual images for students to apply the mathematical content of the picture book to everyday situations, to solve and pose problems, and to work collaboratively. It also identifies books with multiple paths and multiple solutions to problems posed explicitly within the text or derived from the text.

Schiro (1997) recognised the importance of a positive view of mathematics in mathematical picture books. *Affordances for Mathematics Learning* includes the way the book motivates and engages students in mathematical concepts and activities, promotes an enjoyable atmosphere, and encourages positive attitudes towards mathematics and mathematics learning. Students should perceive mathematics as a social, useful, intellectual, and worthwhile activity involving active participation, reasoning and creativity.

Pedagogical Implementation identifies how the mathematical content of the picture book promotes inquiry for children without adult intervention and encourages students to revisit the story for its mathematical aspects. For teachers, this category addresses how easily the mathematical content is identifiable and accessible, how easily it can be used and integrated in teaching and learning programs, and whether the ensuing teaching and learning experiences can be adapted for different levels of ability and learning styles. The accessibility and practicality of the resources required or implied for teaching and learning for both teachers and students are also addressed.

Results and Further Research

Analysis of the book categorisation showed intercoder reliability between the Researcher and the Research Assistant of 0.92. The only area of difference was whether the mathematics in four of the books was deliberately placed (“embedded”) by the author or whether it was incidental or “perceived” by the reader. The Research Assistant identified mathematical concepts in all the books, but this does not imply that all of them would be useful for mathematical learning; further coding against a framework is needed. The Researcher and the Research Assistant found the framework easy to use, although both suggested a few minor amendments for clarity of understanding several elements. Further trialling is needed before reliability can be achieved. The Research Assistant reported:

This framework really required me, as a teacher, to think beyond reading a book to what I could do with a book to plan and implement valuable and contextual learning experiences for children making maths both fun and accessible in a non-threatening format.

The purpose of developing this new framework was both to aid effective selection of books for the pilot and main studies and to facilitate the selection and evaluation of any picture book by teachers. However, in the process, it will also identify a range of current picture books with mathematical content for the use of all teachers.

This proposed study will extend previous research on the use of picture books by focussing not only on books with perceived mathematical content, as in previous studies, but also on children’s responses to purpose-written books with explicit and embedded mathematical concepts. There will be an emphasis on the source of student verbal responses and the interaction of the text and visual images. If purpose-written picture books (explicit and/or embedded) are found to provide better opportunities for developing children’s conceptual understanding of mathematical concepts, then the implications for including these picture books in the mathematics curriculum will be justified.

This paper is based on a study conducted under the supervision of Associate Professor Joanne Mulligan as part of a PhD in Education at Macquarie University.

References

- Anderson, A., Anderson, J., & Shapiro, J. (2005). Supporting multiple literacies: Parents’ and children’s mathematical talk within storybook reading. *Mathematics Education Research Journal*, 16 (3), 5-26.
- Allen, P. (1992). *Alexander’s outing*. Ringwood, Victoria: Viking.
- Anno, M. (1977). *Anno’s counting book*. London: Bodley Head.
- Australian Curriculum, Assessment and Reporting Authority (ACARA). (2010). *Australian curriculum*. Retrieved March 15, 2010, from <http://www.acara.edu.au/curriculum.html>
- Bosma, B. & De Vries Guth, B. (1995). *Children’s literature in an integrated curriculum*. Newark, DE: International Reading Association; New York: Teachers College Press.
- Casey, B., Kersh, J. E., & Mercer Young, J. (2004). Storytelling sagas: An effective medium for teaching early childhood mathematics. *Early Childhood Research Quarterly*, 19, 167- 172.

- Children's Book Council of Australia (2009). *Welcome*. Retrieved September 28, 2009, from <http://cbca.org.au/>
- Commonwealth of Australia. (2009) *Belonging, being and becoming*. (EYLF). Retrieved November 3, 2009 from: http://www.deewr.gov.au/EarlyChildhood/Policy_Agenda/Quality/Documents/Final%20EYLF%20Framework%20Report%20-%20WEB.pdf
- Dodds, D. A. (2004). *Minnie's Diner: A multiplying menu*. Cambridge MA: Candlewick Press.
- Donahue, M. R. (1996). *Literature connections in six current math series for grades K -2*. Paper presented at the Annual Literacy Conference, Anaheim, CA.
- Griffiths, R., & Clyne, M. (1988). *Books you can count on; Linking mathematics and literature*. Melbourne: Nelson.
- Halpern, P. A. (1996). Communicating the mathematics in children's trade books using mathematical annotations. In P. C. Elliot & M. J. Kennedy (Eds.), *Communication in mathematics: K -12 and beyond* (pp. 54 -59). Reston, VA: National Council of Teachers of Mathematics.
- Halsey, P. (2005). Assessing mathematics trade books: Do they measure up? *Reading improvement*, 42, 158-163.
- Hellwig, S. J., Monroe, E. E., & Jacobs, J. S. (2000). Making informed choices: Selecting children's trade books for mathematics instruction. *Teaching Children Mathematics*, 7, 138-143.
- Hunsader, P. D. (2004). Mathematics trade books: Establishing their value and assessing their quality. *The Reading Teacher*, 57, 618-629.
- Jennings, C. M., Jennings, J. E., Richey, J., & Dixon-Krauss, L. (1992). Increasing interest and achievement in mathematics through children's literature. *Early Childhood Research Quarterly*, 7, 263 - 276.
- Kress, G., & van Leeuwin, T. (1996). *Reading images: The grammar of visual design*. London: Routledge.
- Lewis, D. (2001). *Reading contemporary picture books: Picturing text*. London: Routledge Falmer.
- McDonald, S. (2009). *Myriad Maths: Maths activities for Book Week books*. Buderim: Firefly Press.
- Muir, M. (1982). *A history of Australian children's book illustration*. Melbourne: Oxford University Press.
- National Council of Teachers of Mathematics (NCTM). (1989). *Curriculum and evaluation standards for school mathematics*. Reston, VA: National Council of Teachers of Mathematics.
- National Council of Teachers of Mathematics (NCTM). (2000). *Principles and standards for school mathematics*, Reston, VA: National Council of Teachers of Mathematics.
- [Neuschwander](#), C. (1997). *Sir Cumference and the first round table*. Watertown MA: Charlesbridge.
- NSW Department of Education and Training (2003). *Quality teaching in NSW public schools. Discussion paper*. Sydney: Author.
- Schiro, M. S. (1997). *Integrating children's literature and mathematics in the classroom: Children as meaning makers, problem solvers, and literary critics*. New York: Teachers College Press.
- Shatzer, J. (2008). Picture power: Connecting children's literature and mathematics. *Reading Teacher*, 61, 649-653.
- Thomas, N. D., Mulligan, J. T., & Goldin, G. A. (2002). Children's representation and structural development of the counting sequences 1-100. *Journal of Mathematical Behavior*, 21, 117-133.
- van den Heuvel-Panhuizen, M., & van den Boogaard, S. (2008) Picture books as an impetus for kindergarteners' mathematical thinking. *Mathematical Thinking and Learning*, 10, 341-373.
- Whitin, D. J. (1992). Explore mathematics through children's literature. *School Library Journal*, 38(8), 24-28.
- Whitin, D., & Whitin, P. (2001). What counts in math-related books for children. *Journal of Children's Literature*, 27(1), 49-55.
- Young-Loveridge, J. M. (2004). Effects on early numeracy of a program using number books and games. *Early Childhood Research Quarterly*, 19, 82 -98

Teacher Change in Response to a Professional Learning Project

Andrea McDonough

Australian Catholic University
<Andrea.McDonough@acu.edu.au>

Philip Clarkson

Australian Catholic University
<Philip.Clarkson@acu.edu.au>

Anne Scott

Australian Catholic University
<Anne.Scott@acu.edu.au>

This paper reports on change in teachers' perceptions of important elements of their role as teachers of mathematics at the conclusion of a two-year professional learning project. Analyses of written responses to survey items indicated shifts in four categories describing important elements of their role: teaching skills, knowledge, concepts; developing problem solvers; facilitating learning by providing quality activities, tasks, and resources; and fostering positive attitudes towards mathematics learning. Teachers attributed these perceived changes to the integration of a number of components within the project.

Teaching is a complex craft involving many skills. It can also involve the artistry and enjoyment of combining these skills into cohesive and effective lessons that are productive learning experiences for students. But as indicated by Hargreaves (1994), teachers each play a key role in the learning experiences of the students they teach:

Teachers don't merely deliver the curriculum. They develop, define it and reinterpret it too. It is what teachers think, what teachers believe, and what teachers do at the level of the classroom that ultimately shapes the kind of learning that young people get. (Hargreaves 1994, p. ix)

We propose that few involved in teacher professional development would be in disagreement with Hargreaves as to the importance of teacher beliefs, along with other factors, for their potential impact on the learning experiences of students. Research indicates that beliefs are commonly seen to be stable (McLeod, 1992) but "can be held with varying degrees of conviction" (Thompson, 1992, p. 129), with the consequence that the more central beliefs are resistant to change (Rokeach, 1968). On the other hand, this implies some beliefs may be open to change by outside influences.

It is generally accepted that there is a relationship between teacher beliefs and teacher practice (Koehler & Grouws, 1992; Philipp, 2007), although researchers report varying degrees of consistency between teachers' professed beliefs and their actual instructional practices (Philipp, 2007). It is noted also that, although current documents encourage a view of mathematical activity as an active process (e.g., Australian Association of Mathematics Teachers, 2006), the majority of teachers appear to maintain traditional forms of mathematics teaching (Franke, Kazemi, & Battey, 2007) that do not necessarily facilitate such mathematical activity. In considering inconsistency in teacher beliefs and practice, Clarkson and Bishop (2000) found a difference between studies that relied solely on self report data by teachers and studies that included some element of observational and/or in-depth discussion over a number of meetings with teachers. Hence they used values to refer to beliefs that a teacher is seen to enact within a classroom, as compared to beliefs that the teacher may or may not embed within their act of teaching. Nevertheless beliefs and values need to be addressed when developing professional learning programs for teachers. It would seem that if teachers are to change their practice in classrooms, then one key necessary element may be a change in articulated beliefs, although this may not be sufficient for practice to actually change. Models of teacher change help in considering this question.



Guskey (1986) claimed that teachers change their beliefs through changing their practice and reflecting on the result. Clarke and Hollingsworth (2002) further developed Guskey's model, viewing the process as cyclical with multiple entry points (see Figure 1). Their model, of what they termed teacher professional growth, took account of four distinct domains that encompass the teacher's world. The model assumes that change occurs through the mediating processes of reflection and enactment.

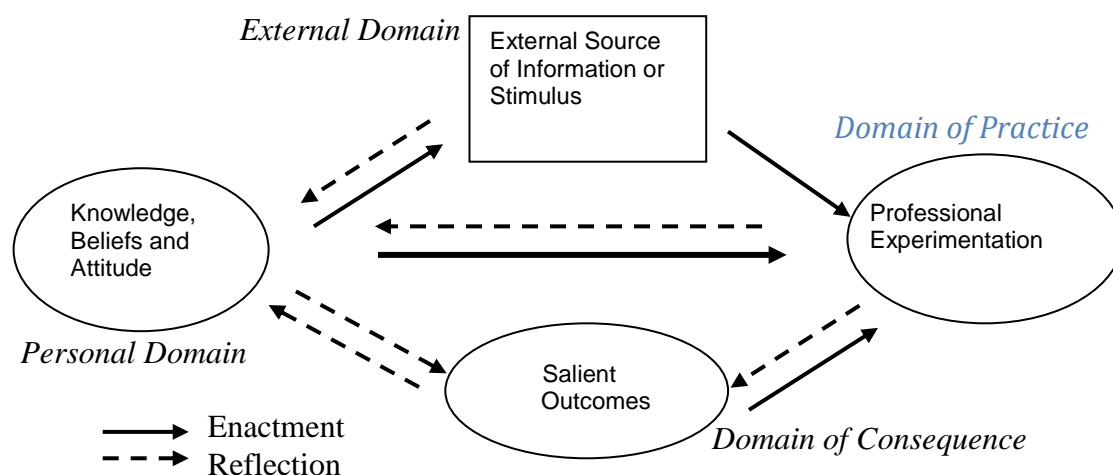

Figure 1. Clarke-Hollingsworth (2002) model of teacher professional growth.

One of the outcomes from the Clarke-Hollingsworth (2002) model is that the validation of the veracity of different beliefs for teachers' needs to be through observation of positive student learning.

Noting this research, it is argued that it is best to devise professional learning programs that are centred on children's thinking and practice in classrooms, and this will impact on teachers' beliefs about the teaching of mathematics as a step in changing their teaching practice. There is some evidence to support this approach (McDonough & Clarke, 2005). Based on these notions, the present study was designed to investigate whether change in teachers' beliefs would occur within a group of teachers who participated in a professional learning project that lasted for two years. The research questions addressed here are:

- What was the nature of the practices the teachers reported at the beginning of the professional development project as compared to the end of their second year of participation?
- If there were changes in what the teachers reported, what did they believe influenced these changes?

The Research Setting and Methodology

The teachers whose responses are reported in this paper taught at eleven Catholic primary schools in and around Melbourne, Victoria. They were involved in a professional learning project titled Contemporary Teaching and Learning of Mathematics (CTLM) (Clarke et al., 2009). The main aim of CTLM was the enhancement of pedagogical content knowledge of teachers, which would lead hopefully to an improvement in student mathematics learning. This project was led by teacher educators from Australian Catholic University (ACU) and sponsored by the Catholic Education Office Melbourne (CEOM).

The content focus of the project in 2008 was on Number, Structure, and Working Mathematically, and in 2009 on Space, Measurement and Chance and Data, with an additional focus on the characteristics of effective teachers of mathematics. Pedagogical aspects for the primary classroom that were given some focus included questioning, assessment, and creating a community of learners. The teachers participated in twelve full days of professional learning over the two years. Between these days, teachers undertook a range of teaching and assessment activities related to the project. They were supported in classrooms, in school professional learning team meetings, and at the professional development days by a variety of people including fellow teachers, CEOM staff and ACU teacher educators and pre-service teachers. During 2008 parent information evenings promoting key aspects of CTLM were held in all schools. It might be said that, in line with principles of good professional development (Clarke, 1994), teachers were supported in a range of ways through the sharing of a vision for teaching mathematics, and the practical support of colleagues, administrators, parents, and others outside the school community.

One aspect of the research component of CTLM was a survey on teacher background and confidence with different aspects of the teaching of mathematics. The data reported in this paper were gathered from a total of 148 teachers in April 2008 and from 98 in October 2009, and reports their responses to two specific items regarding their views on teaching, and one item that asked them what aspects of the project they found most helpful.

While recognising possible limitations of self reported data, and the problematic relationship it has with potential teaching behaviour, we nevertheless judged it appropriate to ask teachers to describe practices that occur in their classrooms, and to communicate what they saw as important elements of their role as primary school teachers of mathematics. We believe that teachers' expressed beliefs are closely related to their actions, although we acknowledge such beliefs may not be sufficient for action.

The first of the two items discussed was an open response item that sought teachers' responses as to what they believed were the important elements in being a mathematics teacher. We were interested to see whether or not their beliefs changed over the two-year period and, if so, whether the changes were in line with the messages emphasised by the CTLM project. The second item was more specific but captured a crucial element of what the CTLM project was built around: communication and the type of activities students were asked to engage with in the classroom. It was anticipated, at the time of commencement of CTLM, that communication in classrooms would likely involve the students listening to teacher talk, with students frequently requested to complete exercises based on material already explained to them. Much of the CTLM project asked teachers to encourage their students to explore possible strategies for solving problems, and then provide explanations for what they had done.

By reporting teacher responses to the two items, we attempt to capture their generalised responses to the project, juxtaposed with specific responses related to a core component of the project. We would hope to see some synergy between the two clusters of responses.

Results and Discussion

In this section we begin by addressing the first research question by reporting findings on two related survey items gathered from all teachers (Years Prep to 6) about their perceptions of aspects of their teaching of mathematics at the beginning and conclusion of the two year CTLM professional learning project. We then consider responses to one questionnaire item that give us insights into the second research question regarding factors of influence.

Four broad categories captured most teacher responses to the open ended item: What do you see as the most important elements of your role as a mathematics teacher of primary-aged students? These categories were

- teaching mathematics (skills, knowledge, concepts etc.);
- developing problem solvers;
- facilitating learning through providing quality activities, tasks, resources; and
- fostering positive attitudes towards mathematics learning.

Due to limitations of time and space on the survey, teachers were asked to respond with one, or at the most two, ideas for this item, with most teachers responding with one idea. Hence one can argue that their responses are probably the most important to them. All teachers at both the beginning and end of the CTLM project completed this item. We have graphed the average number of responses per teacher for each category (see Figure 2).

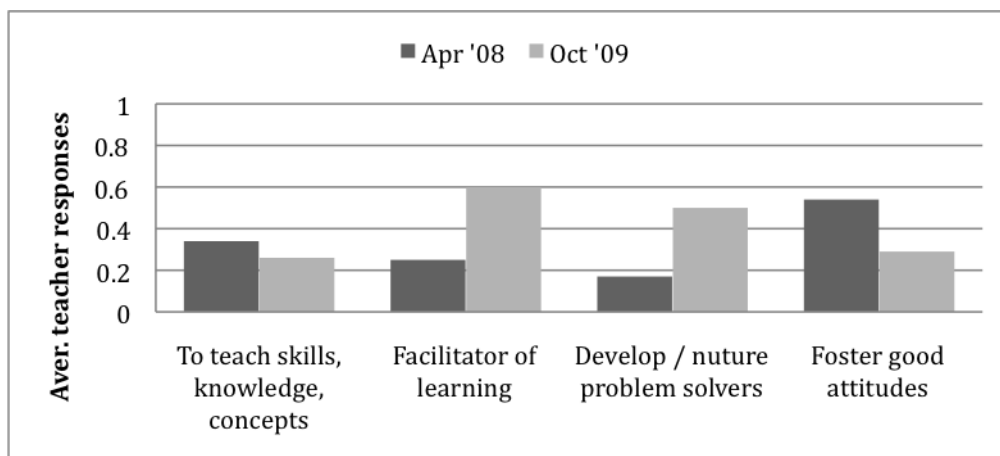

Figure 2. Teachers' perceptions of their roles as teachers of mathematics

These data suggest that the teachers' perceptions about their role changed in important ways over the duration of the project. We comment on three key findings. At the beginning of the project, many teachers indicated that an important element of their role was to teach knowledge, skills and concepts. In their descriptive responses many teachers described ways in which they impart knowledge, skills and concepts so these could be used in the future at secondary school, or in real-life contexts. For example, one wrote: "To teach them the basics and how these are used in different ways so they can relate it to other things." However, by the end of the project, more teachers indicated that they saw themselves as facilitators of learning by providing students with suitable tasks and by asking questions so that students could think more deeply about their ideas. A common sentiment was captured in this teacher's response: "Being a facilitator of their learning [involves] giving them questions and experiences that lead them to come to their own conclusions." Another wrote: "I am the facilitator - the one who encourages and supports the students. I ask questions to promote thinking but I also help students to ask their own questions."

The second finding that is worth noting here is the rise in the number of responses for developing or nurturing problem solvers. For example, one wrote: "To enable the students to see that there is more than one way to get an answer and to realise the correct answer is not the be all and end all." Another common response involved getting students to articulate their thoughts with others. For example, one teacher wrote: "Allow students to

investigate, experiment, share ideas and strategies.” Another commented: “For children to explore alternatives, to feel confident enough to attempt investigations and to identify why they came to their conclusions/answers.”

The third finding concerns students’ attitudes. At the beginning of the project, many teachers considered a key aspect of teaching mathematics was to foster a positive attitude towards mathematics. They expressed this sentiment in very general terms. For example, one teacher stated: “To give children a positive attitude towards maths and to make it fun.” Of course, it is important to be supportive and to foster positive attitudes in mathematics, although we acknowledge that more is needed to produce sound mathematical understanding and critical thinking skills in students. We note in the teachers’ initial responses some emphasis on making mathematics non-threatening. Yet, current thinking in mathematics education (e.g., Australian Association of Mathematics Teachers, 2006) advocates that it is important to also challenge students by providing tasks and experiences which they can ponder, explore, and even struggle with for a short time, so that they will learn to persevere, try different strategies and extend their mathematical understandings. Inevitably some students will find such situations threatening to some degree, particularly if they perceive that there is no safety net provided.

By the end of the project we noted a change, for example, a typical response was: “To get children excited and interested in maths”. This seemed to be a productive way to foster positive attitudes towards mathematics with students. In fact, in many cases, teachers started to make more specific comments on ways to value and support students’ thinking during mathematics lessons which may lead to fostering positive attitudes to learning mathematics. For example, one teacher wrote: “Providing the context, materials, support and encouragement for students to recognise their own style of learning; to provide knowledge and skills, thinking processes and real world experiences to develop and practice problem solving strategies”. Another stated: “To provide experiences that enable students to visualise their maths. To link maths with real life scenarios. To build competency with mental computation/place value. To encourage discussion about maths at home and among peers”. It seems likely that in classrooms where all students’ opinions and strategies are considered, there would be more opportunities to cultivate positive attitudes in mathematics lessons.

The second item from the questionnaire that is of interest is shown in Figure 3. The student behaviours described in (a) and (b) were to some degree de-emphasised during the CTLM project, but behaviours described in (c) through (g) received emphasis at various points in the project.

How often do the students in your mathematics class do the following?
This stem introduced the following:
a) Listen to me present the definition of a term or the steps of a procedure.
b) Perform tasks requiring methods or ideas already introduced to them.
c) Assess a problem and choose a method to use from those already introduced to them.
d) Perform tasks requiring methods or ideas not already introduced to them.
e) Explain an answer or a solution method for a particular problem.
f) Analyze similarities and differences among representations, solutions, or methods.
g) Prove that a solution is valid or that a method works for all similar cases.
For each item, teachers were asked to choose from six alternative columns that were headed: (1) never, (2) less than once a month, (3) 1-3 lessons per month, (4) 1-2 lessons per week, (5) 3-4 lessons per week, or (6) 5 lessons per week.

Figure 3. Item asking teachers for their perceptions of types of student classroom participation

The average teacher responses are shown in Figure 4. If the CTLM project was influencing teachers' teaching, then there would be an expectation that the responses for (a) and (b) would fall, but a rise would be seen for (c) through (g). Indeed this is the result that occurred for these teachers who had been in the CTLM project over a two-year period. The changes for (b) through (e) were 0.4 or less. Such a change on a six-point scale is probably not indicative of real change, although it is gratifying that the movements are in the expected directions. For items (a), (f) and (g) there is a change of 0.5, 0.6 and 0.7 respectively. On a six-point scale such changes are probably indicative of some educationally important movement for these teachers. Noting a fall away from the very traditional approach (a), and a rise in emphasis on analysis (f) and proof (g) suggests that the project has altered what these teachers are attempting to do in their classrooms.

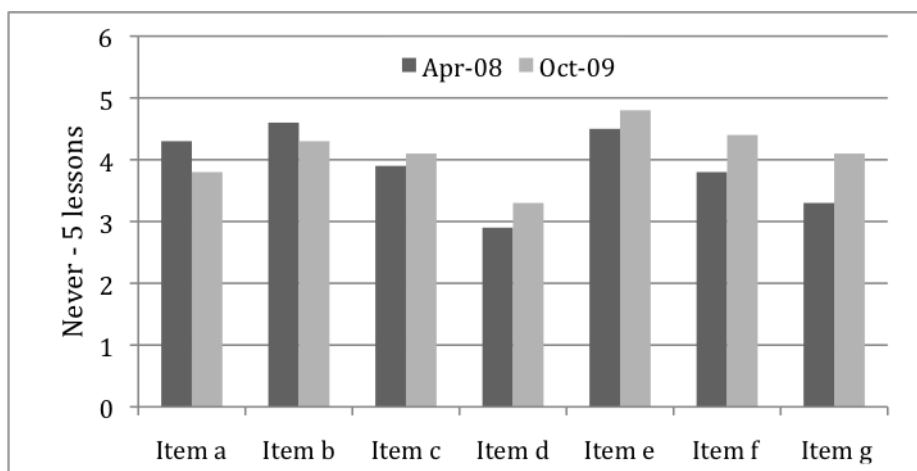

Figure 4. Teachers' perceptions of types of student classroom participation

We suggest there are some interesting points to note by taking the responses to these two items together. The drop in teachers' stated belief that teaching mathematics was about facts and skills is consistent with the change noted for items (a) and (b) where teachers suggest they are telling less in class. We also note that teachers' rising belief that it is worthwhile to be a facilitator and nurture problem solving is consistent with an emphasis on students analysing similarities and differences between solutions and methods, and proving a solution or method is valid in other cases. Overall, these data indicate some shift away from teacher-directed instruction, suggesting the teachers believe more in a non-traditional than a traditional mode of teaching mathematics. The teachers' written responses emphasised exploration and experimentation of concepts through open-ended tasks, and the use of high-order thinking processes such as explanation, evaluation and justification in their second set of responses, and are consistent with their responses in Figure 4, as well with the goals and foci of the CTLM project.

Given that we believe that we detect a change in this group of teachers, we address our second research question: If there were changes in what the teachers reported, what did they believe influenced these changes? At the conclusion of the project teachers responded to an open ended item on the survey: What aspect/s of the CTLM project have been most helpful for you this year (2009), and in what way/s have they been helpful?

Many teachers referred to multiple aspects of the CTLM project in identifying the most helpful aspects of the project and in some cases they used words like 'everything' or 'all of it' and 'useful activities' which made it difficult to distinguish between specific

components; hence, we decided not to represent the data in a graph. However, all but two of the ninety-eight responses were positive about their involvement in the project.

It seemed that the combination of aspects was helpful in achieving a balance between unpacking theoretical principles and considering advice for classroom implementation. Teachers valued the input addressing key issues during the professional development sessions and the flow on support offered to them back at school, for example one wrote: “Change in thinking and the way mathematics is taught in the classroom; PD that has been practical; Being able to trial activities; Planning sessions with [project support staff back at school]”. Comments referring to staff supporting the project back in schools frequently made reference to teachers who were mathematics leaders at their school, Catholic Education Office (Melbourne) staff, and Australian Catholic University staff. Teachers seemed to appreciate that the activities presented to them were ‘ready for classroom use’ as comments such as “the students enjoyed doing them” imply that teachers had used them. An entry which captured the sentiment of the majority was “The ability to have time to read, discuss, do hands on activities has refreshed me as a teacher of maths!” This suggests that teachers valued the project because it provided both time to observe and listen to new ideas, as well as space and support to experiment, gain confidence, and reflect upon new insights and practices. Most teachers thought that they had improved in their teaching as a result of their involvement in the CTLM project.

Conclusion

In the current study teachers were exposed to external sources of information (Figure 1), that is, stimulus through participation in a professional learning project over a two-year period. This involved working with educators from outside their school, but also collaborative research activity within their own school community. In line with Philipp’s (2007) argument that it is more important to support teachers to change beliefs and practice in tandem than to worry about determining which changes first, the CTLM project gave teachers support in their teaching. The data analysed here suggest most teachers who participated in the CTLM project probably changed their beliefs and teaching in ways consistent with the aims of CTLM. Not only is this valuable feedback to the designers of this project as they continue with further groups of teachers, but potentially for other providers of professional learning. Nevertheless we acknowledge the limitations of this study and, echoing earlier points, suggest there is value in more fine-grained analysis of teacher articulated beliefs and their relationship to what actually happens in classrooms, both for the purpose of verification of teacher statements of their practice and views, and to give deeper insights into how teacher change can be stimulated (Clarkson & Bishop, 2000; Speer, 2008).

Acknowledgement

We acknowledge gratefully the support of the Catholic Education Office (Melbourne) and that of Gerard Lewis and Paul Sedunary in particular in the funding of this research.

References

- Australian Association of Mathematics Teachers. (2006). *Standards for excellence in teaching mathematics in Australian Schools*. Retrieved January 15, 2007 from www.aamt.edu.au
- Clarke, D. J., & Hollingsworth, H. (2002). Elaborating a model of teacher professional growth. *Teaching and Teacher Education, 18*(8), 947-967.

- Clarke, D. M. (1994). Ten key principles from research for the professional development of mathematics teachers. In D. B. Aichele & A. F. Coxford (Eds.), *Professional development for teachers of mathematics* (pp. 37-48). Reston, VA: National Council of Teachers of Mathematics.
- Clarke, D., M., Downton, A., Roche, A., Clarkson, P., Scott, A., McDonough, A., Horne, M., Parish, L., & Hamilton, L. (2009). *Contemporary teaching and learning of mathematics 2008: Report to CEO Melbourne*. Melbourne: Mathematics Teaching and Learning Research Centre, Australian Catholic University.
- Clarkson, P. C., & Bishop, A. (2000). Values and mathematics. In A. Ahmed, J. Kraemer & K. Williams (Eds.), *Cultural diversity in mathematics education* (pp. 239-244). Chichester, U.K.: Horwood.
- Franke, M. L., Kazemi, E., & Battey, D. (2007). Mathematics teaching and classroom practice. In F. K. Lester (Ed.), *Second handbook of research on mathematics teaching and learning* (pp. 225-356). Charlotte, NC: Information Age Publishing.
- Guskey, T. R. (1986). Staff development and the process of teacher change. *Educational Researcher*, 15(5), 5-12.
- Hargreaves, A. (1994). *Changing teachers, changing times: Teachers' work and culture in the postmodern age*. London: Cassell.
- Koehler, M., & Grouws, D. (1992). Mathematics teaching practices and their effects. In D. A. Grouws (Ed.), *Handbook of research on mathematics teaching and learning* (pp. 115-126). New York: Macmillan.
- McDonough, A., & Clarke, B. A. (2005). Professional development as a catalyst for changes in beliefs and practice: Perspectives from the Early Numeracy Research Project. In P. Clarkson, A. Downton, D. Gronn, M. Horne, A. McDonough, R. Pierce, & A. Roche (Eds.), *Building connections: Research, theory and practice* (Proceedings of the 28th annual conference of the Mathematics Education Research Group of Australasia, Melbourne, pp. 521-528). Melbourne: MERGA.
- McLeod, D. (1992). Research on affect in mathematics education: A reconceptualization. In D. Grouws (Ed.), *Handbook of research on mathematics teaching and learning* (pp. 575-596). New York: Macmillan.
- Philipp, R. A. (2007). Mathematics teachers' beliefs and affect. In F. K. Lester (Ed.), *Second handbook of research on mathematics teaching and learning* (pp. 257-315). Charlotte, NC: Information Age Publishing.
- Rokeach, M. (1968). *Beliefs, attitudes, and values: A theory of organisational change*. San Francisco: Jossey-Bass.
- Speer, N. M. (2008). Connecting beliefs and practices: A fine-grained analysis of a college mathematics teacher's collections of beliefs and their relationship to his instructional practices. *Cognition and Instruction*, 26, 281-267.
- Thompson, A. (1992). Teachers' beliefs and conceptions: A synthesis of the research. In D. A. Grouws (Ed.), *Handbook of research on mathematics teaching and learning* (pp. 127-146). New York: Macmillan.

Pre-service Students' Responses to Being Tested on their Primary School Mathematical Knowledge

Tamsin Meaney
Charles Sturt University
<tmeaney@csu.edu.au>

Troels Lange
Charles Sturt University
<tlange@csu.edu.au>

The limited mathematical knowledge of pre-service primary teachers is an international concern. The areas of mathematical difficulties have been well documented, which has led to many universities instituting testing regimes to ensure that their pre-service teachers have appropriate knowledge of primary school mathematics. In this study, the pre-service teachers identify some benefits for being tested, but these were often related to having sufficient knowledge so that they did not lose face in front of a class. It is suggested that these students' emphasis on performance rather than competence could exacerbate a reliance on procedural rather than conceptual understanding.

This paper examines pre-service teachers' responses to being tested on their primary school mathematical knowledge. By placing these responses into the background of institutional responses to this concern, it is shown that without care, a testing regime can emphasise the importance of procedural rather than conceptual mathematical understanding to these students.

There has been international concern about pre-service primary teachers' mathematical knowledge. In reviewing research done in Australia, Tobias and Itter (2007) stated, "it is reasonable to conclude that many pre-service teachers may have peripheral beliefs, poor attitudes and feelings about learning mathematics" (p.4). As a consequence of this concern, several research projects have investigated the knowledge that many primary school pre-service teachers have as well as different ways to assess and improve this knowledge base (Goulding, Rowland & Barber, 2002).

The type of mathematical knowledge that pre-service teachers need is seen as being connected to their subsequent careers as primary school teachers. Ponte and Chapman (2008) stated that "[w]hile having strong knowledge of mathematics does not guarantee that one will be an effective mathematics teacher, teachers who do not have such knowledge are likely to be limited in their ability to help students develop relational and conceptual understanding" (p. 226). Skemp (1976) described 'relational understanding' of mathematics as "knowing what to do and why" (p. 21) and so is related to the conceptual underpinnings of the mathematics being studied. Goulding et al., (2002) suggested that:

Beliefs about the nature of mathematics may be tied up with SMK [subject matter knowledge] in the way in which teachers approach mathematical situations. If they believe that it is principally a subject of rules and routines which have to be remembered, then their own approach to unfamiliar problems will be constrained, and this may have an impact on their teaching. (p. 691)

Mathematical knowledge per se will not benefit pre-service teachers. Rather there is a need for them to have relational understandings, if this is the type of mathematics that is most beneficial for the primary students that they will ultimately teach (Ball, 1990). Pre-service teachers' views about the relevance of conceptual understandings may affect their attitudes to mathematics and how to teach it. At the same time, negative attitudes to mathematics may impede pre-service teachers' ability to engage in mathematical content and pedagogical subjects, which could improve their mathematical understandings (Ebbly, 1999).



Institutional Responses to a Perceived Lack of Knowledge of Mathematics

Like other government organisations (see Office for Standards in Education, 1994), the NSW Institute of Teachers (NSWIT) has accepted the need for teachers to have strong mathematical knowledge and recently changed the requirements for graduating primary school teachers. Teachers entering primary teacher education courses need:

Higher School Certificate minimum Band 4 Standard English, or minimum Band 4 English as a Second Language, or minimum Band 4 Advanced English AND Higher School Certificate General Mathematics minimum Band 4, or completion of Mathematics (2 unit). (NSWIT, 2006).

Consequently, NSW universities have adopted selection criteria that have included Band 4, two unit English and Mathematics (NSW Teachers Education Council, 2008). If students enrol in primary teacher education course without appropriate mathematics results from their high school studies then they must also complete a mathematics subject at university of an equivalent standard.

However, knowledge of Year 12 mathematics may not be the most appropriate mathematics for pre-service teachers of primary school students. Tobias and Itter (2007) in their investigation of pre-service teachers' mathematical knowledge found "[t]his study confirms that we cannot presume that pre-service teachers who have completed Year 12 studies in mathematics have sufficient mathematical content knowledge that will enable them to teach mathematics meaningfully" (p. 14).

At Charles Sturt University (CSU), there has also been concern over the mathematical knowledge of pre-service primary school teachers. A shared concern with other regional universities is that pre-service teachers may not have been taught by trained mathematics teachers because of the shortage of these teachers in rural and regional Australia (Tobias & Itter, 2007). Tobias and Itter (2007) hypothesised that this may well have had an impact on pre-service teachers' "mathematical understandings and attitudes" (p. 14).

Consequently, CSU not only requires pre-service teachers to have Higher School Certificate (HSC) Band 4 mathematics, but in 2008 they had to pass a Basic Skills Test (BST) of primary school mathematics topics, such as fractions, decimals, place value. This was done in the first mathematics subject of their Bachelor of Education degree. These requirements presumed that the HSC General Mathematics and the Basic Skills Test provide an appropriate basis to gain pedagogical content knowledge in mathematics.

In 2008, students had to gain 90 percent in a BST, although no marks were awarded to the final grade in their first mathematics pedagogy subject. Students could do the test four times, but if they did not pass then they had to redo the subject. The lecturer provided some support to students. However, at the beginning of the semester, it was presumed that most students would have sufficient knowledge to pass the test and so the limited teaching time (5 x one hour sessions) could be tailored to those students who really needed it. This turned out not to be the case and so these pre-service teachers were directed to numerous web sites and to the university's Learning Support Services who provided individual mathematics support.

Method

The tests consisted of 30 short answer questions that were at Year 7 level. The mathematical topics covered were similar from test to test. Most topics were covered in one question, although some like fractions were covered in several questions. All of the tests were kept. After each test, students were informed whether they had passed. Students who had not passed were provided with information about the areas that they had not

completed appropriately, so that they would know what to study in order to pass the next test. It was hoped that this would help pre-service teachers focus on the conceptual understandings of the topics. However, the students who felt that knowing what answers they got wrong was what was important often resented this.

In the following semester, the pre-service teachers were asked about why they thought they had to do the BST and whether they thought this was a valid purpose. Then, they were asked about how they felt about the test and whether they could suggest alternatives to it. Nine students were interviewed across three focus interviews, in August and September 2008. Although two male students had originally volunteered to participate in the focus group interviews, neither showed up so all the interviewees were female. A research assistant who had had no previous contact with the students was the interviewer. It was felt that students would be more open with a stranger than with the lecturer who had been responsible for giving them the BST in the first semester. Some of the students had passed the BST in the first round whilst others passed on the second, third or fourth rounds.

2008 Pre-service Teachers' Results on the BST

As Table 1 shows the number of students who completed each test declined as the pre-service teachers gained the 90 percent in a test. Although all students had passed the test by the fourth round, the initial tests showed that many students entered their Bachelor of Education studies with very poor knowledge of primary school mathematics. As can be seen in Figure 1, many of their responses suggested that they suffered from similar misconceptions to those of primary school students. However, it is encouraging that by the end of the semester they had learnt sufficient to pass. This suggests that even if they forgot some of what they had learned before going out into classrooms they would be capable of relearning the material.

Table 1
Number of students

Basic Skills Test 1	93
Basic Skills Test 2	62
Basic Skills Test 3	45
Basic Skills Test 4	23

Providing a short explanation in the following lecture easily rectified some topics that many students answered incorrectly in the first test. Other topics, such as place value, were still difficult for a large number of pre-service teachers even at the third test. Figure 1 provides examples of the sorts of difficulties that they had with place value.

State the total value of the underlined digit in 45.06 | tens

State the total value of the underlined digit in 65.03 | 3 tenths.

Figure 3: Two pre-service teachers' responses to place value questions.

2008 Pre-service Teachers' Views on Doing the BST

On the whole, the pre-service teachers recognised that it was important that they knew the mathematical knowledge that they would be teaching. They saw the BST as providing information about whether or not they had this knowledge. However, only one pre-service teacher made any reference that could be considered to illustrate that she needed conceptual understandings so that she could provide appropriate explanations to her future students.

And the kids might need a longer explanation than what you're giving them to start off with so you've got to know how to go into more depth but break it down even further so they can get it. (Interview 2, Student 1)

Although pre-service teachers knew it was important to have the mathematical knowledge for teaching, they felt that studying for the BST might not be a valid way to gain it. In some cases this was related to their views about the sort of mathematical knowledge they needed in the classroom.

Student 2: I personally am good at assignments and not tests because I don't remember anything so I can only do it if I know how to do it and for the basic skills test I had a lot of trouble revising and things and because my dad's mathematical he taught me different ways to do it and when you go out to teach the children you can't use those ways you've got to use the way it states.

Student 3: You actually had to study to the test, you had to actually just get through it. There was no learning how to teach it or anything it was just basically pass it or you don't move on. (Interview 3)

There were queries about how the BST connected to the NSWIT's requirement for HSC Band 4 mathematics.

Student 3: I want to know where this factors in to having a Band 4 in maths because I'm waiting to hear whether I need to do extra-

Student 1: so am I.

Student 3: And how does that figure then if I can pass a basic skills test why do I need to be Band 4 maths? If I have to do it like I don't know where that figures into the whole scheme of things either so it wasn't our question. I don't understand why I have to go to summer school. If I can get 90 percent in the basic skills test and I've done maths on my HSC why do I need to summer school again to get Band 4 maths? (Interview 3)

Other reasons for doing a BST had a performance rather than competence orientation for their learning. The BST was seen as ensuring that pre-service students could show that they had the appropriate knowledge for their university studies and for teaching in classrooms, either whilst on practicum or when they graduated. Pre-service teachers felt they needed to show what they knew (performance), and rarely linked this to being competent in supporting primary school students to learn (competence).

Student 1: I think it's to see that the students are of a particular standard for the course.

Student 2: I reckon it's just seeing what the students know like seeing where they are to sort of work on what they need to know for teaching and so that when they go out they have a background knowledge like if they're put on the spot of how to teach long division then they've actually done it in a funny kind of way. (Interview 3)

Sometimes, the need to do the mathematics was connected to being able to explain it to students, but more usually it was so that they, as teachers, did not lose face in front of the class and other school members.

Student 2: Yeah I think so as well because if you don't know the work and if you don't know how to do it yourself you're not going to be able to teach it.

Student 1: And they're going to ask a hard question and you're just going to be like I don't know how to do it and that doesn't reflect very good on you and then it reflects badly on the school and then the parents will find out and then they'll tell people and- (Interview 1)

Such comments were common and showed that performance in doing mathematics in front of others was a concern. One pre-service teacher saw the BST as contributing to her feeling comfortable about her mathematics knowledge. It is hard to know whether this student was also performance orientated or competency orientated.

To ensure that we have maths knowledge so you feel confident and help us in other subjects I guess.

On the other hand, another pre-service teacher who had had to sit the BST several times before she passed felt that the experience contributed to making her uncomfortable about her mathematics knowledge. Again the emphasis was on performance of the mathematics.

But that basic skills test pretty much demoralises people because it shows what you can't do so if you keep going repeatedly failing most of the time it just breaks you down because you think you can't do it. (Interview 3, Student 4)

These sorts of comments match the anxiety mentioned by students in other studies such as McNamara, Roberts, Basit and Brown (2002). However, some pre-service teachers felt that having four opportunities to pass the test was useful. This tended to be pre-service teachers who had passed on the first round.

Interviewer: The anxiety component to the basic skills test is mainly because of?

Student 1: Fear that they will fail the subject.

Student 2: Yeah that 90 percent rate if you fail that and you're out after 4, you get 4 opportunities, which I think is great I think that's great that you get the 4 opportunities because some people as I say have that fear. I think it's preparation; you've got to be prepared- (Interview 1)

Other pre-service teachers complained that they could not see how the BST fitted in with their other assignments in the subject.

But our assignments never linked to it I don't think anyone used the basic skills test to link anything for assignments, it was just like a one off thing you had to pass. (Interview 3, Student 3)

However, the pre-service teachers were unsure about how the BST could be replaced.

When I said it was really stressful and that I didn't like the fact that we had to do a test but thinking about it it's probably the only way that I could think of assessing and making sure that everyone knew about it. (Interview 2, Student 2)

Nevertheless, many of the students were unhappy about having to do a test. There was discussion whether studying for the test meant they just had to memorise it.

Student 3: Also with being four tests, by the time you got to the fourth one a lot of it you could do from memory, because the last three combined the fourth one, so you really didn't have to think you just had to regurgitate it.

Student 2: But they all had mainly the same structure so you knew what was going to happen it was going to be something on surface area or something on division and time you just knew that what was going to be there so you basically just had to revise everything from the first test.

Student 1: People were basically just learning enough to pass it and again I think it's important to break it all down into how you work it out, how you would go about teaching it. For me I just had to go and learn the basic concepts like all the place value of this and I had to learn all those terms again they were ...

Student 3: That was that thing where it's the net of something and ...

Student 1: Yeah I had to look that up.

Student 2: I remembered that.

Student 1: Just the mathematical terms that weren't quite as solid as maybe they should have been in your head to know what you were trying to get so again I think it's more important to break it down and teach it so you understand it and how you would go about teaching it to somebody else and then maybe see with a test then you see the knowledge that you've gained at the end of the course or something. (Interview 3)

The pre-service teachers blamed their high school mathematics experiences for why they could no longer do primary school mathematics. Many found it to be a real struggle to re-learn the mathematics by themselves. Cooney (1999) pointed out that “often pre-service teachers have a poor understanding of school mathematics [because they] last studied it as teenagers with all the immaturity that implies” (p.165). However, many pre-service teachers at CSU are only seventeen or eighteen when they took this test, implying that the issues faced at school may not be resolved when they reach university. Many wanted procedural rather conceptual understandings as their concern was about passing.

Student 2: Yeah, but I think that we should have probably gone over everything again in class like I personally didn't have too much problem with it but I know there were quite a lot of people that they just don't remember that far back to primary school and they couldn't do a lot of the stuff because as you said we used calculators through high school-

Student 3: So we just forgot everything that we knew basically and some things were hard to learn by yourself. Like you look at it in a book but it's not the same as if someone is showing you or if a teacher teaches you. You might be able to remember how they taught you which would be better to teach the children so I think they need to do more with teaching us how to do specific things, like she did a little bit but not much really. I got mine the second go, I think it was a bit stressing for some of us because some of our friends got it their 3rd or 4th go and I know I was stressed for the second go because I didn't want to fail it again because then it would be even more stressing

Student 1: I found it hard. I passed second time as well and I found it hard the second time to teach myself. I went online and I was going through it and stuff and some of the explanations were hard to understand to get the concept of how you got that and things like that because it just shows you the answer, it doesn't show you what you actually had to do so it was a bit confusing. (Interview 2)

As Tobias and Itter (2007) stated “[p]erhaps, these students have a performance view instilled in their prior learning experiences, where a ‘learn and forget’ attitude prevailed due to a lack of emphasis on understanding during the middle years of schooling” (p. 14). On the other hand, some students recognised that they should have known the material covered in the BST. Yet, they seemed excuse themselves by suggesting that ‘learn and forget’ attitude was the norm.

Student 1: You're so used to using calculators because as soon as you hit high school you just use calculators and you just forget how to do the simple things in your mind.

Student 3: Even times tables.

Student 2: Same but in saying that though a lot of those questions were the basis of maths that you do in high school, so in some ways we probably should still know them, but in another light what happens, in high school just recently like for the mature age students and stuff (Interview 2)

Nevertheless, some pre-service teachers found successful ways to study for the BST and passed on the first or second rounds. It came back to a question of whether the responsibility for the passing the test was that of the pre-service teacher or the lecturer providing the subject. Given that the pre-service teachers were only being tested on Year 7 mathematics, it does not seem unreasonable to expect them to relearn this material themselves so that the university subject can focus on new material.

Student 2: Yeah, I agree if you look at that test the amount of people who pass on the first round and had to keep going obviously there was a need for it, it showed that there were a lot of people either they weren't prepared or they just didn't have enough background. Before that test, I actually went on the website and I don't know if anyone else did and it had maths for teachers on the student learning and a lot of people weren't aware of that site, it had practice questions and everything there

Interviewer: that might be an option for people to prepare.

Student 2: It is if it was more advertised you know how they've got the interact site and there's part of the student notices or whatever put a link in there instead of having it in student life, put the link into [internet resources for the subject] so they can click on it and they can see and it was great and I did that quite a few times and maybe because I'm older I also brought a year 7 text book with basic skills.

Student 1: I bought a maths dictionary (Interview 1)

There was some discussion about the need to have a 90 percent pass mark. On one hand, this was seen as one way of ensuring that students were at an appropriate level.

Student 1: I think getting the 90 percent, I think that's got to stay to make sure that they know the work not guessing it I guess.

Student 2: Yeah, I think the level, the pass level needs to be that high. As far as the testing goes, I don't see it as a problem, actually the test. (Interview 1)

On the other hand, students also saw it as putting too much more stress on them.

Student 1: Too much pressure to be 90 percent pass.

Student 4: 90 percent is too high because for some people, me, when I was at school just last year I could barely get above 70 percent for all these things and then you come here and they're like you've got to get about 90 and it's just like it's pretty much impossible.

Student 3: I've never got 90 percent in anything.

Student 1: But then I think that comes back to the level they want people to have and that's their expectation that at that level of maths you need to be 90 percent. I can see where they come from to say you have to get 90 percent to pass like that's the level they want you to have but a different way of going about it. (Interview 3)

In many ways, the 90 percent pass rate focussed pre-service teachers on the performance of doing mathematics and away from knowing how to be an effective facilitator of primary students' learning. There was also some discussion about when during the semester the test should occur. This was tied into whether or not the students were taught the material or expected to relearn it themselves.

Student 2: I think they need a test like that what they've got but perhaps before they do it there's more instruction like you say. They have a booklet you either work through your own self-paced booklet and that's up to you, then you're responsible for your own learning but you have a self-created booklet with example questions maybe that might be in the test may not be and then put the test on.

Student 1: But then there's also going to be those people that already know a lot of stuff that's going to be in there like they already have a good background of maths that might-

Student 2: But if it's a self-paced module they can finish it quickly and then forget about it. Other people can work through for the first few weeks. (Interview 1)

Throughout the interviews, many pre-service teachers were focused on the performance of doing mathematics. This is perhaps unsurprising given that they had to pass at the level of 90 percent. These pre-service teachers were in their first semester of doing a Bachelor of Education and were not used to seeing themselves as primary school teachers, which may have supported them to see the relevance of having a competency

approach to learning mathematics. Many pre-service teachers may have found it difficult to imagine situations where they would need the mathematical knowledge to support students to understand the concepts behind the ideas. If pre-service teachers are to imagine a different rationale for learning primary school mathematics then the test and other structures around it such as its relationship to other assignments needs to change.

Conclusion

It was clear that without some sort of incentive, pre-service teachers were unlikely to (re)learn the primary school mathematics topics. Even pre-service teachers who had recently completed HSC mathematics struggled with being able to pass the test on their first or second attempts. Consequently, many became stressed. Nevertheless, most recognised that there was a need to check their primary school mathematical knowledge.

However, the way the test was organised resulted in the pre-service teachers reinforcing their views that what was important in mathematics was knowing the rules rather than understanding the concepts behind the rules, so that they could facilitate students' mathematical understanding. Performance rather than competence was seen as why they needed to pass the test. It is unlikely that the requirement to have HSC Band 4 mathematics will disrupt this belief and this may have lasting implications for the pre-service teachers' teaching unless subsequent mathematics pedagogy subjects can alter these beliefs.

Often in teacher education, we instigate new initiatives with the best of intentions. If we had looked only at the pre-service teachers' results in the BST, we would have been able to prove to ourselves the necessity of providing such a test. However, interviewing pre-service teachers provided valuable insights into how these intentions were being thwarted by the circumstances in which the tests were being carried out. Therefore, the views of pre-service teachers have been crucial in our explorations of alternatives to the BST in 2009 and 2010.

References

- Ball, D. L. (1990). The mathematical understandings that prospective teachers bring to teacher education. *Elementary School Journal*, 90, 449-466.
- Cooney, T. J. (1999). Conceptualizing teachers' way of knowing. *Educational Studies in Mathematics*, 38, 163-187.
- Ebby, J.R. (1999). Learning to teach mathematics differently: The interaction between coursework and fieldwork for pre-service teachers. *Journal of Mathematics Teacher Education*, 3, 69-97.
- Goulding, M., Rowland, T., & Barber, P. (2002). Does it matter? Primary teacher trainees' subject knowledge in mathematics. *British Educational Research Journal*, 28(5), 689-704.
- McNamara, O., Roberts, L., Basit, T. N. & Brown, T. (2002). Rites of passage in initial teacher training: Ritual, performance and ordeal and the Numeracy Skills Test. *British Educational Research Journal*, 28(6), 863-878.
- NSW Institute of Teachers (2006). *What qualifications are required for teaching?* Retrieved from: <http://www.nswteachers.nsw.edu.au/What-qualifications-are-required-to-teach-in-NSW.html>
- Office For Standards in Education (1994). *Science and Mathematics in Schools: A review*. London: HMSO.
- Ponte, J. P. d., & Chapman, O. (2008). Pre-service mathematics teachers' knowledge and development. In L. English (Ed.), *Handbook of International Research in Mathematics Education* (pp. 223-261). New York: Routledge.
- Skemp, R. (1976). Relational and instrumental understanding. *Mathematics Teaching*, 77, 20-26.
- Tobias, S. & Itter, D. (2007). Mathematical backgrounds of pre-service teachers in rural Australia: A comparative study. *Proceedings of the 2007 annual conference of the Australian Association for Research in Education*. 14 September 2008 from <http://www.aare.edu.au/07pap/tob07424.htm>

Computational Estimation in the Primary School: A Single Case Study of One Teacher's Involvement in a Professional Learning Intervention

Paula Mildenhall
Edith Cowan University
<p.mildenhall@ecu.edu.au>

Mark Hackling
Edith Cowan University
<m.hackling@ecu.edu.au >

Paul Swan
Edith Cowan University
<p.swan@ecu.edu.au >

This paper focuses on the initial analysis of a study of a professional learning intervention. Using a case study design it was possible to describe one teacher's involvement in this research. The study revealed how the teacher's beliefs and pedagogical content knowledge of computational estimation was altered as a result of participating in the research. This development appeared to have an impact on her approaches to the teaching of computational estimation.

For this study computational estimation is defined as a process in which some or all of the numbers in an arithmetic problem are approximated to simplify the computation of the estimate (Mildenhall, 2009) and it is also being asserted in this study that computational estimation is a component of number sense (Greeno, 1991; McIntosh, 2004). This term is a relatively recent one and has been described by McIntosh, Reys, Reys, Bana and Farrell (1997) as "a person's general understanding of number and operations, along with the ability and inclination to use this understanding in flexible ways to make mathematical judgments and to develop useful and efficient strategies for managing numerical situations" (p. 3). On the basis of this definition, the ability to estimate numerical quantities is an integral component of number sense.

This study investigated the impact of a professional learning intervention that focused on developing teachers' beliefs, knowledge, and practice when teaching computational estimation. It is becoming apparent that teachers' beliefs affect their pedagogical decisions (Carpenter, Fennema, Franke, Levi, & Empson, 1999) therefore it was important to consider how changes in teachers' beliefs might affect classroom practice.

The type of knowledge that teachers require to teach effectively has been defined as pedagogical content knowledge (PCK) (Shulman, 1986). The term PCK includes subject matter knowledge, curricular knowledge and pedagogical knowledge so it was important to observe the teachers' development of these aspects. The research questions addressed in this paper were:

1. How did one teacher's participation in a professional learning intervention develop her PCK, beliefs and teaching approaches about computational estimation?
2. How did the teacher's development of beliefs and PCK about computational estimation inform her teaching approaches?

Theoretical Framework

The theoretical framework for this study was set in a social constructivist and critical paradigm (Crotty, 1998). Table 1 identifies the core component of these theories and explains why this theoretical framework underpins this study.

Table 1



Theoretical Framework

Theory	Justification	Importance for the research
Social constructivism	All tenable statements about existence depend on a world view, and no world view is uniquely determined by empirical or sense data about the world (Patton, 2002, p. 97)	The different world views in the research study are acknowledged, represented, and valued
Critical theory	<i>In this type of inquiry spawned by the critical spirit, researchers find themselves interrogating commonly held values and assumptions, challenging conventional social structures and engaging in social action (Crotty, 1998, p. 157)</i>	This study involves a collaborative group participating in a cyclical process of self- reflection and action in order to bring about change in the understanding and practice of the participants

The Professional Learning Intervention

Factors of effective teacher professional learning were considered in the design of the professional learning intervention. These included, providing on-going support (Hackling, Goodrum, & Rennie, 1999), teachers working in collaboration (Bray, 2002; Keady, 2007) and time spent with students in order to reflect on how the learning in the professional learning situation can be incorporated into the classroom (Bobis et al., 2005; Fennema et al., 1996). Year 6 teachers from low fee, non-government schools were invited to join. These schools are established by religious groups and despite being privately run, still receive government funding based on the socio-economic status of the parents of the school (Independent Schools of Australia, 2007). Wendy (a pseudonym) was one teacher who participated in the year-long professional learning intervention. This paper is a description of her journey.

The initial professional learning day introduced four principles from the research literature. These were that mathematics teaching and learning is effective when it is; active (Franke, Kazemi, & Battey, 2007), metacognitive (McKeachie, Pintrich, Lin, & Smith, 1986), and contextual (Gravemeijer & Terwel, 2000). The fourth principle was that numerical estimation is an integral part of number sense (McIntosh, Reys, Reys, Bana, & Farrell, 1997). The teachers were introduced to six estimation strategies; front end loading, range, compatible numbers, rounding, intuition, and benchmarking (Mildenhall, 2009). They were presented with suggested teaching activities and it was also recommended that 'estimation as a checking device' become part of the normal expectations of teachers and students in the mathematics lessons, that is the sociomathematical norm (Yackel & Cobb, 1996).

The teacher went back to school and trialled the estimation tasks in a way that she thought was pedagogically appropriate. On each of the further three professional learning days there was time for reflection and discussion of the estimation tasks trialled in the classroom and an opportunity to reflect on the research literature. Mathematical tasks were also presented to develop content knowledge. Using an action research methodology

(Somekh, 2006), this cycle of plan, act and reflect ran through three complete cycles ending with a twilight plenary session at the end of the year.

Methodology

The methodology for this case study used purposeful sampling (Merriam, 1998; Patton, 2002) in order to select an appropriate unit of analysis. This unit was the professional learning intervention, which included the teacher participants and their students. Convenience sampling was also undertaken (Merriam, 1998) so that one teacher’s journey in this professional learning could be analysed.

Data Collection

Multiple data collection methods were used to maximise the evidence available to answer the research questions and to increase the internal validity of the study (Merriam, 1998). Table 2 illustrates how the data was collected in order to capture the longitudinal nature of the study.

Data Analysis

The data, which were predominately qualitative, were entered and analysed using the computer software NVIVO 8 (QSR, 2008). Apriori coding by the researcher created the initial themes of teacher beliefs, pedagogical content knowledge, and teaching approaches of computational estimation. These were created as tree nodes in NVIVO 8. Inductive coding then took place as themes emerged from the data to identify the individual teacher’s beliefs, PCK, and teaching approaches. Table 2 illustrates how the data analysis was categorised into three sections in order to capture teacher change in PCK, beliefs and teaching approaches. In this way it was also possible to interpret how these changes may have impacted their teaching approaches.

Table 2

Data Collection and Analysis

Data analysis section	Data collection instrument	Data analysis
Beginning of the study	Semi-structured 1st teacher interview	Qualitative data recorded, transcribed, and then entered and analysed in order to create themes using NVIVO
	1st professional learning day initial reflection	
During the school year	Focus group student interviews	Quantitative pre-test data entered and analysed using SPSS
	Multiple choice computational estimation student pre-test	
	Participant observation of 1 st visit to classroom (work samples collected)	
	Participant observation of 2 nd PL day	Qualitative data recorded and transcribed and then entered and analysed in order to creating

Midyear-6 months into the study	Participant observation of 2 nd visit to classroom (work samples collected)	themes using NVIVO
	Semi-structured 2 nd teacher interview	
	Participant observation of 3 rd PL day	
End of study-final term of the school year	Participant observation of 3 rd visit to classroom (work samples collected)	
	4 th Professional learning twilight session	Qualitative data recorded, transcribed, entered and analysed to create themes using NVIVO
	Semi-structured final teacher interview	
	Focus group student interviews	
Multiple choice computational estimation student post test	Quantitative post test data entered and analysed using SPSS	

Results

Development of Wendy's Beliefs

At the beginning of the professional learning intervention Wendy had the belief that estimation was useful as a checking device when doing algorithms as shown in Table 3. Table 3 reveals how, as the study progressed, these beliefs had broadened so that Wendy now saw computational estimation as a strategic number sense activity as well as checking device.

Table 3
Wendy's Beliefs during the Study

Data collection instrument	Qualitative data
1 st Interview	I find children need it [estimation when doing procedural mathematics] ... Is the answer going to be bigger or smaller. So what do we need to do?
2 nd Interview	... and I think they are seeing the value of estimating gradually whereas before when it was a text book thing they don't see the point
4 th Professional learning session	... what I think is so important is the number sense aspect of it [computational estimation] ... <i>but they [the computational estimation strategies] made so much sense to me ,that is</i>

	<i>what amazed me</i>	<i>De vel op me nt of We</i>
3 rd Interview	I think doing those problems that didn't have right answers really helped with that [broaden the students perception of mathematics]	

Wendy's Pedagogical Content Knowledge

Wendy did not have any knowledge of computational estimation strategies other than rounding at the beginning of the project. At the end of the professional learning intervention she was asked to summarise how she thought computational estimation should be taught. She had developed new pedagogical approaches:

Using lots of practical activities; Starting with numbers the children understand and can relate to (in the lower grades). Building to higher numbers; Games; Journaling of their understanding; Children need to understand why they are estimating.

She also developed a growing understanding of the estimation strategies. When asked how she would rate her awareness of estimation strategies at the beginning compared to the end, she said, "oh I only knew rounding really, so now I know lots".

Development of Wendy's Teaching Approaches

Before the intervention Wendy did not teach students how to undertake computational estimation using a variety of strategies and taught the estimation strategy 'rounding' procedurally as an algorithm. After the intervention Wendy spent time teaching students that computational estimation could be part of their problem solving repertoire in mathematics. In the 3rd classroom observation Wendy provided a learning task where the students had to collaboratively plan a trip to a park. There were many opportunities for the students to use the computational estimation strategies including working out how far it was from the school to the park, the cost of the barbeque items and the itinerary. The example below is taken from the start of the lesson where Wendy reminded the students how the estimation strategies could be useful:

We have to bring in the estimation strategies we have been talking about because the prices will vary from day to day. We can only have an estimate 'cos we can't really have an accurate amount ... You need to use friendly numbers, if we are looking at prices and something cost \$3 .99 and you need 10 or 12 or 15 packets of them, what would you probably do with the \$3.99?

Discussion

Over the period of the professional learning intervention Wendy's beliefs about computational estimation changed. She now perceived that computational estimation could be a strategic number sense activity rather than just another step for checking procedural algorithms. Wendy was able to understand the computational estimation strategies herself and she believed that they were appropriate to be taught to Year 6 students. This acceptance of the strategies is a positive sign that primary school teachers may be able and willing to incorporate the variety of computational estimation strategies into their teaching repertoire.

Wendy's enhanced beliefs and PCK appeared to inform her teaching approaches as noted in classroom observations of her teaching. She used her increased content knowledge

of computational estimation strategies in her discourse with the students. She also implemented estimating problem solving tasks set in contexts, which were not part of her teaching repertoire before the study began. This suggests that she had learnt new pedagogical approaches whilst being involved in the professional learning intervention.

Conclusion and Implications

It is not possible to generalise from this single case study and it is also important to acknowledge that, as this research is set in a social constructivist theoretical framework, this research is conducted from the particular world view of the researcher. This case study showed that the intervention enabled the teacher to enhance her computational estimation PCK and this appeared to change her teaching approach of estimation. Initial analysis of student pre and post test data would appear to indicate that students benefitted from their teacher being involved in this professional learning. Further cases are being considered as part of a larger study that should provide an even deeper understanding and these findings will be reported at a later date.

References

- Bobis, J., Clarke, B., Clarke, D., Thomas, G., Wright, R., & Young-Loveridge, J. (2005). Supporting teachers in the development of young children's mathematical thinking: Three large scale cases. *Mathematics Education Research Journal*, 16(3), 27.
- Bray, J. (2002). Uniting teacher learning: Collaborative inquiry for professional development. *New Directions for Adult and Continuing Education*, 94, 83-92.
- Carpenter, T., Fennema, E., Franke, M., Levi, L., & Empson, S. (1999). *Children's mathematics: cognitively guided instruction*. Reston, California: Heinemann.
- Crotty, M. (1998). *The foundations of social research: meaning and perspective in the research process*. Sydney: Allen & Unwin.
- Fennema, E., Carpenter, T., Franke, M., Levi, L., Jacobs, V., & Empson, S. (1996). A longitudinal study of learning to use children's thinking in mathematics instruction. *Journal for Research in Mathematics Education*, 27, 403-434.
- Franke, M., Kazemi, E., & Battey, D. (2007). Understanding teaching and classroom practice in mathematics. In F. Lester (Ed.), *Second handbook of research on mathematics teaching and learning* (pp. 225-256). Charlotte, North Carolina: National Council of Teachers of Mathematics.
- Gravemeijer, K., & Terwel, J. (2000). Hans Freudenthal: A mathematician on didactics and curriculum theory. *Journal of Curriculum Studies*, 32(6), 777-796.
- Greeno, J. (1991). Number sense as situated knowing in a conceptual domain. *Journal for Research in Mathematics Education*, 22(3), 170-218.
- Hackling, M., Goodrum, D., & Rennie, L. (1999). *A proposal for a collaborative Australian secondary science program*. Perth: Edith Cowan University.
- Independent Schools of Australia. (2007). *Independent Schooling in Australia: Snapshot 2007*. Retrieved 5/3/2010, 2010, from <http://www.ais.wa.edu.au/images/member/Bulletins/c110-ISCA-snapshot2007>.
- Keady, W. (2007). *The impact of professional learning on science teachers' beliefs about assessment and their assessment practice*. Unpublished doctoral dissertation. Edith Cowan University, Perth.
- McIntosh, A. (2004). Where we are today. In A. McIntosh & L. Sparrow (Eds.), *Beyond written computation* (pp. 3-14). Perth: MASTEC.
- McIntosh, A., Reys, B., Reys, R., Bana, J., & Farrell, B. (1997). *Number sense in school mathematics*. Perth: MASTEC.
- McKeachie, W., Pintrich, P., Lin, Y., & Smith, D. (1986). *Teaching and learning in the college classroom: A review of the research literature*. Ann Arbor, Michigan: National Centre for Research to Improve Postsecondary Teaching and Learning, University of Michigan.
- Merriam, S. (1998). *Qualitative research and case study applications in education*. San Francisco, California: Jossey-Bass.

- Mildenhall, P. (2009). A study of teachers' learning and teaching of computational estimation: Getting started. In B.Kissane, M.Kemp, L. Sparrow, C.Hurst & T.Spencer (Eds.), *Mathematics it's mine: Proceedings of the 22nd biennial conference of The Australian Association of Mathematics Teachers* (pp. 153-158). Fremantle: AAMT.
- Patton, M. Q. (2002). *Qualitative research and evaluation methods* (3rd ed.). Thousand Oaks, California: Sage Publications.
- QSR International. (2008). NVIVO 8. Melbourne: QSR International Pty Ltd.
- Shulman, L. (1986). Those Who Understand: Knowledge Growth in Teaching. *Educational Researcher*, 15(2), 4-14.
- Somekh, B. (2006). *Action research: A methodology for change and development*. New York: Open University Press.
- Yackel, E., & Cobb, P. (1996). Sociomathematical norms, argumentation, and autonomy in mathematics *Journal for Research in Mathematics Education*, 27(4), 458-477.

Gap Thinking in Fraction Pair Comparisons is not Whole Number Thinking: Is This What Early Equivalence Thinking Sounds Like?

Annie Mitchell

Australian Catholic University
<annie.mitchell@acu.edu.au>

Marj Horne

Australian Catholic University
<marj.horne@acu.edu.au>

Gap thinking has been categorised as one of several whole number strategies that interfere with early fraction understanding. This study showed that this claim is not supported by interview data of Grade 6 students' gap thinking explanations during a fraction pair comparison task. A correlation with equivalence performance was uncovered, leading to the suggestion that the additive nature of gap thinking may actually reveal the (erroneous) additive nature of students' early engagement with equivalence concepts.

Gap thinking is a misconception prevalent in explanations of mental comparisons of the size of two fractions. It is most striking in incorrect attributions of equivalence. For example, Clarke and Roche (2009) found that 29% of the Grade 6 children gave a gap thinking explanation when asked which was larger, $\frac{5}{6}$ or $\frac{7}{8}$, claiming both fractions were "equivalent, because they both require one bit to make a whole" (p. 129). Gap thinking may affect a quarter of our students and other studies show that it is present in Years 4, 6, and 8. It is worth a closer look.

Literature Review

Pearn and Stephens (2004) use the phrase gap thinking to describe a Year 8 student's comparison of $\frac{3}{5}$ and $\frac{5}{8}$: $\frac{3}{5}$ is larger because "there is less of a gap between the three and the five (in the first fraction)" than there is between the "five and the eight (in the second fraction)" (p. 434). They distinguish this from comparing-to-a-whole thinking in which the students claim that $\frac{2}{3}$ is bigger than $\frac{3}{5}$, because $\frac{3}{5}$ "is two numbers away from being a whole" while $\frac{2}{3}$ "is one number away from being a whole" (p. 434). Clarke and Roche (2009) combine these two strategies in their definition of gap thinking. Post and Cramer (1987) describe the same strategy in Grade 4 children who believe $\frac{3}{4}$ and $\frac{2}{3}$ are equal because "the difference between numerator and denominator in each fraction was one." (p. 33). Cramer and Wyberg (2009), give the example of a child who claims $\frac{3}{4}$ to be bigger than $\frac{5}{12}$ because " $\frac{5}{12}$ still has 7 more to go" as opposed to $\frac{3}{4}$ which has "one more to go. So it should be bigger." (p. 241). These examples all describe gap thinking, as it is called in Australia, and categorise it as one form of whole number thinking.

There are descriptions of other whole number thinking strategies that are not gap thinking. Clarke and Roche (2009) describe higher or larger numbers in which the student compares numerator 1 with numerator 2, and then denominator 1 with denominator 2. For example, $\frac{7}{9}$ is larger than $\frac{3}{4}$ because "7 and 9 are bigger than 3 and 4" (p. 131). Earlier American research describes this same strategy as whole number dominance, where $\frac{3}{5}$ is less than $\frac{6}{10}$ because "3 is less than 6, and 5 is less than 10" (Behr, Wachsmuth, Post & Lesh, 1984). Pearn and Stephens (2004) include higher or larger numbers in their definition of gap thinking, unlike us. Denominator (bigger/bigger) comparisons are also described as whole number dominance where the larger denominator is taken to signify the larger fraction (Behr et al., 1984).

In the literature, the three strategies; gap thinking, higher or larger numbers, and denominator (bigger/bigger), are all classified as examples of whole number thinking. This



model of cognitive development would suggest that these strategies should be apparent before other more sophisticated fraction understandings are evident amongst students. It seems self-evident that students need to resolve these misconceptions in order to successfully integrate their increasing fraction knowledge.

Successful strategies for fraction size comparisons include residual thinking and benchmarking (see e.g. Behr et al., 1984; Clarke & Roche 2009). Residual thinking is a mathematically correct strategy useful for comparing fractions that are one away from the whole. $5/6$ is one sixth away from the whole and $7/8$ is one eighth away from the whole. As one eighth is smaller, $7/8$ is closer to the whole. Residual thinking represents a successful transition from comparisons to the whole, in same denominator contexts, to considering the size of the pieces in pairs with different denominators. Benchmarking (transitive reasoning in the Rational Number Project research) is a strategy in which a child compares fractions to a self generated benchmark such as a half. For example, $5/8$ is larger than $3/7$ because $3/7$ is less than a half and $5/8$ is more than a half.

Benchmarking draws upon equivalence. Recognising the fraction pair $2/4$ and $4/8$ as equivalent can draw on either scale relationships – the bottom number is double the top number in both fractions; or functional relationships – 2 pizzas for 4 people is as much as 4 pizzas for 8 people (see e.g. Kieren, 1992). Ways of introducing equivalence include generating equivalent fractions and recognising the same fraction in different measure representations (Wong & Evans, 2007). Kieren cautions that drawing on equivalence as an internalised strategy in other tasks is not apparent in half the age cohort until age 12, and full common denominator reasoning occurs later (1992). Fraction pair comparisons, therefore, are relevant to all levels of the primary school.

Methodology

Instead of using Kieren's earlier five-part model encompassing part-whole, measure, quotient, operator and ratio sub-constructs as much of the research literature does, it is possible to reconcile the activities and strategies of fraction size comparisons with the three underpinning constructs of his later four part model – partitioning, equivalence and unit-forming. The earliest comparisons, making unit fractions and comparing them, fits into the partitioning construct. Comparing related fractions, such as $3/8$ and $7/8$ involves partitioning and unit-forming actions. Exploring how $2/4$ is as much as $4/8$ engages with quantitative equivalence. Unit-forming, seeing fractions as units, as sums of other amounts, also relates improper and proper fractions. For example, $2/4$ is 2 one-quarters, and two-quarters of a whole, and 4 two-quarters are 2 (see Kieren, 1992; 1995). In this framework $4/2$ is larger than $2/4$ because $4/2$ is four halves which is a recognisable amount to the student.

Clinical interviews provide an opportunity to gather rich data on children's descriptions of their mathematical strategies (DiSessa, 2007). For this study, 88 Grade 6 students from three metropolitan state schools in Melbourne were interviewed on a one-to-one task-based interview. Children were not told the correctness of their answer, but asked to explain their thinking. No teaching took place during the interview. All interviews were audio-taped and more than half were also video-taped. All the interviews were conducted by the first author. To be coded as correct, the child had to give the correct answer and an explanation of a mathematically correct strategy. A record sheet with dot points of strategies identified in the literature was used and any other strategy was noted during the interview. All strategies were given a code and entered into a spreadsheet. Specific tasks, for example, the fraction pairs, were double coded from the video recordings by another researcher

familiar with the strategies described in the literature. For the gap thinking strategy, all instances identified by either coder, including those only audio-taped, were transcribed providing a full set of transcripts of gap thinking explanations. A further code was used, possible gap, which indicated that the explanation was possibly gap thinking but that there was not enough evidence in the child's response to be sure. All coding describes the first (or self corrected) preferred strategy. Gap thinking, possible gap (pgap), higher or larger numbers, denominator (bigger/bigger), and denominator (bigger/smaller) strategies were given separate codes.

The eight fraction pair questions are the same as used by Clarke and Roche (2009): $3/8$ or $7/8$, $2/4$ or $4/8$, $1/2$ or $5/8$, $2/4$ or $4/2$, $4/5$ or $4/7$, $3/7$ or $5/8$, $5/6$ or $7/8$, $3/4$ or $7/9$. The children were shown a card with the two fractions as symbolic inscriptions and were asked, please point to the larger fraction or tell me if they're the same. After they stated or pointed to their answer they were asked, and how did you work that out?

The interview was wide ranging and parts of four separate tasks had an equivalence component. Thirteen questions were identified as drawing on equivalence understanding. Eight of the questions required the children to recognise either a) $4/6$ or $6/9$ as two thirds, b) $2/12$ as one sixth, or c) $3/12$ and $2/8$ as a quarter, and there were length, area (equal parts and non-congruent parts) and discrete contexts. Two further questions used concrete materials (golden beans) and required the child to generate an equivalent fraction (having thrown something out of six) and to rename their answer of $3/9$ or $1/3$ which had been modelled with the golden beans. Another question, the fraction pair $2/4$ or $4/8$, required the child to recognise equivalence in a symbolic inscription. Two final questions required the application of equivalence. One was the fraction pair $3/7$ or $5/8$. The other was the addition, using symbolic notation, of $1/2 + 1/3$. Both were identified as connected to equivalence by a factor analysis, and subsequent checking of the coding and the children's inscriptions showed that all correct answers successfully used benchmarking or common denominators respectively. The fraction pair $1/2$ or $5/8$ was NOT included in the equivalence categorisation because it was possible for children to think of $5/8$ as a half, a unit in itself, plus a bit, and not use the equivalence $1/2 = 4/8$. Of course, many did use equivalence knowledge, if they had it, to solve this question. Two questions were common to both the fraction pairs and the equivalence category.

Results

The following quotations are of children's responses to the fraction pair $5/6$ or $7/8$.

- They're the same because five sixths has got one more to become a whole. And seven eighths it also has one more to become a whole.

- They're the same.
[Interviewer] And how did you work that out?
Because five out of six is one piece left and seven out of eight is one piece left.

- They're the same.
[Interviewer] How do you know?
Because there's both, because the top numbers are both one less than the bottom numbers.

- They're the same.
[Interviewer] And how did you decide?

Cause they're both two thirds, that's another way to say them. Cause seven plus one is eight and five plus one is six.

– They're the same.

[Interviewer] And how did you decide?

Because they're like. Five sixths there's one more. There's one more sixth to make a whole. And it's one more eighth.

– They're the same.

[Interviewer] And how did you decide?

Because they both need one more to be coloured in.

All of these responses were coded as gap thinking in the fraction pair $5/6$ or $7/8$. Both a gap answer and a gap explanation were needed for positive identification. This was especially true in other pairs when a gap thinking strategy and a mathematically correct strategy would give the same fraction. For example, in the pair $3/7$ or $5/8$ the correct answer is $5/8$ but the fraction with the smaller gap is also $5/8$, and it is possible to get the right answer for the wrong reason. In contrast to the examples above, fractional language, such as one-sixth, sometimes did indicate a grappling with the size of the pieces and consideration of the numerator and denominator, and in those cases, the child was not coded as demonstrating gap thinking, nor possible gap thinking. In contrast, in our categorisations, the only children who were coded as gap thinking in the pair $3/8$ or $7/8$ were those who chose the larger gap with a gap thinking explanation similar to those above. As complement-to-one thinking is correct in the $3/8$ or $7/8$ context, similar explanations to those above, with the choosing of the smaller gap, were not coded as gap thinking. Gap thinking explanations sound like successful how-close-to-the-whole thinking misapplied to inappropriate fraction pairs, rather than whole number thinking misapplied to fractions. While one other child claimed the fractions were the same in $5/6$ or $7/8$ but had a faulty residual explanation, this pair, with its distinctive gap answer, enables us to see the full range of gap thinking explanations transcribed above.

We can hear in the first four explanations similar descriptions to those in the literature. There is the complement-to-one strategy – “one more to become a whole”. There is the gap as a “bit” – “one piece left”. There is attention to the numerical difference between numerators and denominators – “the top numbers are both one less than the bottom numbers”. Also, there is the string of equivalences – $5/6$ is $7/8$ is $2/3$ is $3/4$ is $9/10$, if we include all responses to this question. What the fraction pair $5/6$ or $7/8$ also reveals is that using the fractional language of sixths and eighths does not automatically rule out gap thinking. The influence of part-whole counting and shading activities rather than activities framed in partitioning, unit forming and equivalence actions, may be being described by the child who says, “They both need one more to be coloured in”.

Some fraction pairs were more difficult than others to compare, as shown below in Table 1. Not every pair elicited gap thinking. Around a quarter of the students did not give a correct answer to the pairs $2/4$ or $4/8$ nor $2/4$ or $4/2$, but none of their incorrect answers were gap thinking. The highest proportion of gap thinking occurred on the pair $5/6$ or $7/8$ where half of the students demonstrated this strategy. This is higher than the 29% reported by Clarke and Roche (2009), but this cohort was not chosen to be representative. Overall, 54% of the students demonstrated gap thinking one or more times during the eight fraction pair questions. Choosing the larger gap was uncommon and only four children did this.

Table 1

Frequency of Success on Fraction Pair Questions and the Incidence of Gap Thinking

Pair	3/8	7/8	2/4	4/8	1/2	5/8	2/4	4/2	4/5	4/7	3/7	5/8	5/6	7/8	3/4	7/9
Success	90.9%	73%	54.5%	72.2%	20.5%	13.6%	12.5%	6.8%								
Gap	2.3%	0%	6.8%	0%	22.7%	21.6%	50%	23.9%								
Pgap	0%	0%	0%	0%	10.2%	3.4%	0%	8%								

Of the 88 students, 4 did not get any of the eight pairs correct. There were 20, 14, 17 and 16 students who were successful on only 1, 2, 3, or 4 of the fraction pairs respectively. So, around 80% of the students were successful on four pairs or less. There were 6, 3, 3, and 5 students who were successful on 5, 6, 7 or 8 pairs respectively. If we are to find whole number thinking strategies, then it is expected that this cohort would be able to show it to us with its spread of performance on fraction pair comparisons.

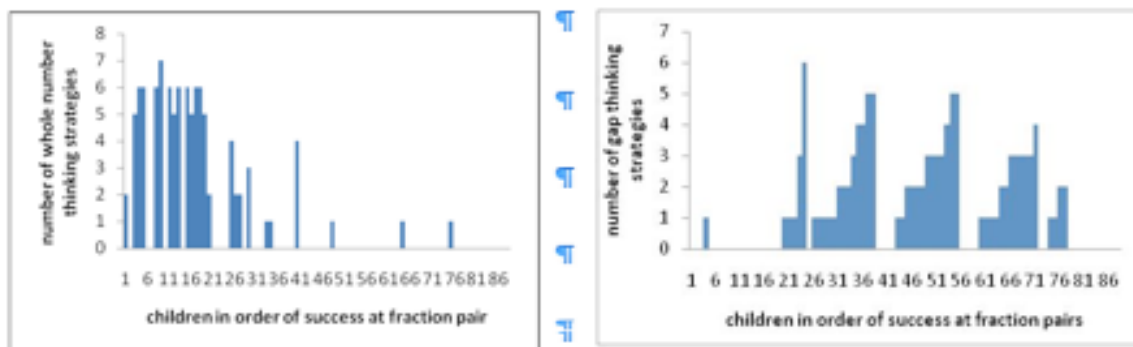

Figure 1 Higher and larger numbers, and denominator (bigger/bigger) thinking (left), gap thinking (right).

The graph of the incidence of higher or larger numbers and/or denominator (bigger/bigger) thinking (see Figure 1 above) where each bar represents one student and is ordered from lowest to highest success, shows a high frequency (many students) and a high intensity (many explanations) of these whole number thinking strategies in the 24 students who had no success or only one correct fraction pair (represented by the first 24 bars on the graph). On the gap thinking graph, however, only 6 of these same 24 children demonstrated gap thinking (represented by the bars before child 26). Higher or larger numbers and denominator (bigger/bigger) thinking is the first preference of only four students (the last four bars) who are successful on 3 or more of the pairs. Gap thinking lingers and there is a range of intensity (number of explanations per student), from no use of gap thinking to five gap thinking explanations, in the middle performers. Gap thinking, higher or larger numbers, and denominator (bigger/bigger) thinking were not often used for different fraction pairs by the same child. If we just look at the three strategies a) gap thinking and b) higher or larger numbers and/or denominator (bigger/bigger) thinking, we see that 42% used gap thinking only, 17% used the other two forms of whole number thinking only, 12.5% used both strategy types, and 28.4% used neither (used other strategies).

Using Kieren’s framework of partitioning, equivalence and unit forming to describe fraction comparisons leads us to consider equivalence as a possible factor in success at fraction pair questions. As 29 out of 88 students had no success or only one equivalence

question correct (see Table 2 below), it is possible to describe the incidence of whole number thinking in students with a range of performance on equivalence tasks.

Table 2
Spread of Equivalence Questions Correct

Correct	0	1	2	3	4	5	6	7	8	9	10	11	12	13
No. of students	14	15	4	8	2	3	9	10	6	6	2	4	5	0

The incidence of higher or larger numbers and denominator (bigger/bigger) thinking, see Figure 2 below, is most prevalent in the students who have success on three or less equivalence questions.

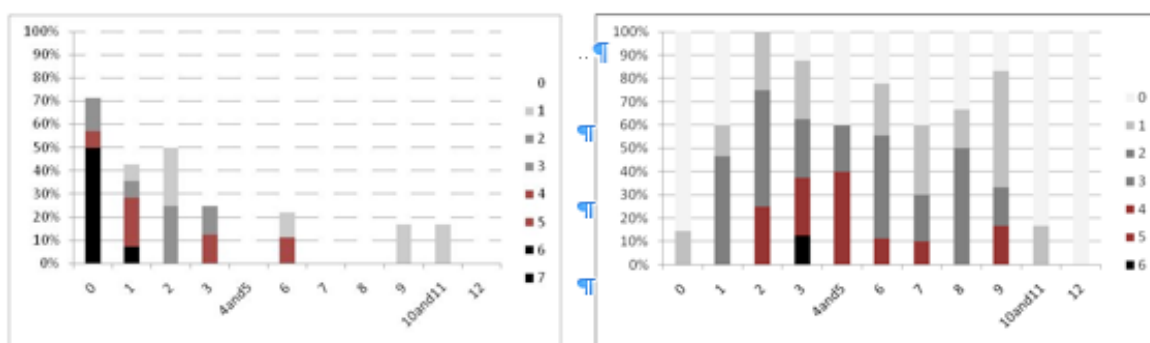

Figure 2. The correlation of higher and larger numbers, and denominator (bigger/bigger) thinking (left) and gap thinking (right) with performance on equivalence questions.

Gap thinking, on the other hand, does not match the predicted pattern for whole number thinking. It appears that at the same time that equivalence becomes a concept ‘on the radar’ for these children, gap thinking also emerges. Gap thinking is almost non-existent in children for whom equivalence is possibly not a concept that they have engaged with in their personal fractional understanding (despite classroom exposure). There are two children who demonstrated gap thinking and who were not correct on any equivalence questions. One we might think of as an outlier as this was her only gap thinking explanation and she chose the larger gap, a much less common variation of gap thinking. The other child, while getting none of the equivalence questions correct, did correctly identify $5/8$ as larger than $1/2$, unlike all of the other 12 students who had no success on this nor on the 13 equivalence questions. Equivalence is ‘a shadow on her radar’. The other 12 students were giving many incorrect explanations for the fraction pairs but none were using a gap thinking strategy. For the students who had success with two of the equivalence questions, and so were not yet competent with all of the contexts for equivalence, all of them demonstrated gap thinking on at least one fraction pair. The highest intensity (the number of gap thinking explanations out of eight) occurred in the group of students who were successful on three equivalence questions. Gap thinking is a strategy that lingers, however, in students with more than beginning equivalence understanding. The frequency of gap thinking decreases dramatically in the group of students who are successful on 10 to 12 equivalence questions. If we include all possible gap thinkers, those coded *gap* and *pgap*, the graph looks similar (not pictured), with greater intensity at similar points to the graph above.

Discussion

The data supports the idea that higher or larger numbers and denominator (bigger/bigger) thinking may be whole number thinking strategies. This is because these strategies are used by the low performers but seem to be less preferred as the students engage with fraction ideas, as demonstrated by increasing success in either fraction pair questions or equivalence questions.

Gap thinking is not a strategy that is clearly present before other emerging fraction knowledge. It is not overly represented in students categorised as low attaining by fraction pairs performance. Their errors are mostly for other reasons. It seems to have increased frequency after the other whole number strategies wane. Only 12.5% of students use both gap thinking and higher or larger numbers and/or denominator (bigger/bigger) thinking, so these strategies do not co-exist in the students' repertoires very often. The data does not support the idea that gap thinking is a whole number thinking strategy.

Most students who do not have equivalence on their radar do not use gap thinking. At the same time as the initial engagement with equivalence thinking begins, however, gap thinking emerges strongly in both frequency and intensity. In the early stages of this engagement with equivalence ideas, by equivalence score 3, the highest intensities are found – students using gap thinking on 4, 5 or 6 questions out of 8. As students become more competent with equivalence, gap thinking lingers, but is much less prevalent by the time students are successful on most of the equivalence questions that were offered. It is timely to remember Kieren's caution about the time it takes to internalise equivalence. Success on 10 to 12 equivalence tasks is really only beginning equivalence knowledge.

It may be worthwhile to screen for gap thinking. The fraction pair $5/6$ or $7/8$ had the highest gap thinking response. There were only three students who demonstrated gap thinking on some other pair and not this one, so this question should identify most gap thinkers. However, while it screens for frequency, it does not offer useful data on intensity. For 15 out of the 44 students who used gap thinking on this pair, this was their only instance of this strategy. It also does not provide information on whether a child is at the beginning, middle or end of their gap thinking journey. Equating fractions that both have the numerator one less than the denominator is a misconception that appears early in gap thinking; from our transitional student described earlier with equivalence as 'a shadow on her radar' and no success on equivalence tasks, through every level of equivalence knowledge from success on one question until success on ten questions. It is the first variation of gap thinking to appear and the last to disappear.

We cannot claim to reveal the mechanism that triggers gap thinking because our data collection provides us with descriptive information, rather than evidence for cause and effect. But we can suggest explanations that fit with the data. If we attend to what the children actually say in their gap thinking explanations we can see that they find great mathematical comfort in the (erroneous) idea that $5/6 = 7/8 = 2/3 = 3/4 = 9/10$. Gap thinking and equivalence are linked here.

However, it would seem that children's gap thinking explanations do not have much connection with equivalence concepts because they are about the difference between numerator and denominator, an additive relationship rather than the proportional relationship described by equivalence. But this is how experts see equivalence. Maybe, the additive explanations about difference, in all their variations, are how students think about equivalence when they are just beginning to engage with this new idea that a fraction could have more than one name. If, when equivalence first 'appears on the radar' for students, their non-integrated understanding had (erroneous) additive aspects, then these

understandings would sound a lot like gap thinking. Maybe this is what the data is telling us.

Gap thinking does not appear to be a whole number thinking strategy, and it appears at the same time as the first engagement with equivalence concepts. Its application is successful in comparing fraction pairs in a common early context – fractions with the same denominator between 0 and 1, which may add to the difficulty of discarding it as a useful algorithm. Early equivalence contexts often involve doubling or halving, which can appear additive. Gap thinking explanations may provide a window into the extent of additive thinking in children’s early engagement with equivalence concepts.

Acknowledgements

The authors wish to thank Anne Roche and Doug Clarke for their help in developing tasks and record sheets and double coding the data.

References

- Behr, M., Wachsmuth, I., Post, T. & Lesh, R. (1984). Order and equivalence of rational numbers – a clinical teaching study. *Journal for Research in Mathematics Education*, 15, 323-341.
- Clarke, D. M. & Roche, A. (2009). Students’ fraction comparison strategies as a window into robust understanding and possible pointers for instruction. *Educational Studies in Mathematics*, 72, 127-138.
- Cramer, K. & Wyberg, T. (2009). Efficacy of different concrete models for teaching the part-whole construct for fractions. *Mathematical Thinking and Learning*, 11, 226-257.
- DiSessa, A. (2007). An interactional analysis of clinical interviewing. *Cognition and Instruction* 25, 523-565.
- Kieren, T. (1992). Rational and fractional numbers as mathematical and personal knowledge: Implications for curriculum and instruction. In G. Leinhardt, R. Putnam & R. A. Hattrop (Eds.), *Analysis of arithmetic for mathematics teaching* (pp. 323-371). Hillsdale, NJ: Lawrence Erlbaum.
- Kieren, T. (1995). Creating spaces for learning fractions. In J. T. Sowder & B. P. Schappelle (Eds.), *Providing a foundation for teaching mathematics in the middle grades* (pp. 31-65). Albany: State University of New York Press.
- Pearn, C. & Stephens, M. (2004). Why you have to probe to discover what Year 8 students really think about fractions. In I. Putt, R. Faragher & M. McLean (Eds.), *Mathematics education for the third millennium: Towards 2010* (Proceedings of the 27th annual conference of the Mathematics Education Research Group of Australasia, Townsville, pp. 430-437). Sydney: MERGA.
- Post, T. & Cramer, K. (1987). Children’s strategies in ordering rational numbers. *Arithmetic Teacher*, 35, 33-35.
- Wong, M. & Evans, D. (2007). Students’ conceptual understanding of equivalent fractions. In J. Watson & K. Beswick (Eds.), *Mathematics: Essential research* (Proceedings of the 30th annual conference of the Mathematics Education Research Group of Australasia, Tasmania, pp. 824-833). Adelaide: MERGA.

Connecting the Points: Cognitive Conflict and Decimal Magnitude

Bruce Moody
The University of Waikato
<bmoody@clear.net.nz>

This paper reports on an investigation into managing cognitive conflict in the context of student learning about decimal magnitude. The influence of prior constructs is examined through a brief review of the literature. A micro-genetic approach was used to capture detail of the teaching intervention used to facilitate development in student thought. A framework for considering cognitive conflict in lesson design is presented, and a case is made for the use of measurement tasks to generate data.

Proficiency with decimal numbers is essential for progress in school mathematics and for financial and statistical literacy in adults. Student difficulties with decimal numbers are well documented. In New Zealand for example, recent reports showed that only 50% of Year 8 students could identify tenths and hundredths and even fewer were able to correctly order decimal numbers (Flockton, Crooks, Smith & Smith, 2006; Young-Loveridge, 2007). This paper reports on part of a larger study into how students engage with the cognitive demands of new material that contradicts their previously-held schemata. A specific focus of decimal magnitude has been selected because while the causes of student misconceptions have been clarified, an ongoing lack of student achievement indicates a need to address further the factors that will help design more successful teaching interventions (Okazaki & Koyama, 2005).

Background

In *variation theory*, learning is seen as attending to those features in novel problems that are similar to, or vary from, existing knowledge. Variation theory occupies a niche within Piaget's equilibrium model of learning. Points of both connection and distinction need to be recognised by students when encountering new situations. This enables the self-perception that one's thinking needs re-organisation (Runesson, 2005). *Cognitive conflict* is a term used to describe the tension created when new evidence is recognised by the student as contradicting previous knowledge. The agency is with the learner as the teacher can only provide situations of *potential conflict*. Resolution of that conflict may result in new learning, as points of both connection and difference are recognised and responded to. This process has been termed *re-constructive generalisation* (Harel & Tall, 1991).

A failure to recognise the disjunctive elements of new problems may lead to the mis-application of previous understandings about number. This process has been termed *expansive generalisation* (Zazkis, Liljedal & Chernoff, 2008). With regard to errors concerning decimal magnitude, researchers have found almost complete correspondence between student answers and their underlying schema (Nesher & Peled, 1986). This is evidence that these answers are not mistakes in terms of the students' perspective but indicative of their conceptual understanding.

There are two common expansive generalisations regarding the magnitude of decimals. One is where students think that the decimal point serves to separate two, whole-number systems and is often termed *whole-number thinking*. Students transfer the whole number truth that 'longer is larger' to decimals. To decide relative magnitude, students view the



whole number sections first and make a decision if these are unequal. If not, they then look at the length of the section after the decimal point e.g. 1.23 is regarded as smaller than 2.5, but larger than 1.8. Another is where a ‘shorter is larger’ system is applied, resulting from students misapplying their understanding of denominators. A larger denominator indicates a smaller fraction (given identical numerators). The system results in 0.6 being interpreted as sixths, and therefore larger than 0.65, as this is interpreted as sixty-fifths. Students who make errors with decimal magnitude typically apply one of these systems or a sub-variant of them (Steinle & Stacey, 1998).

It is not the existence of prior constructs per se that is the problem, rather it is their durability in spite of teacher-provided evidence to the contrary, the ‘obstinacy factor’ (Harel & Sowder, 2005). Research suggests that primitive schemata are deeply embedded and difficult to change (McNeil & Alibali, 2005). Counter-examples to prior constructs are not necessarily effective catalysts for change as the novelty of new, externally-provided information can be unrecognised, compartmentalised or disregarded by students (Zazkis & Chernoff, 2008). Disequilibrium is avoided when students fail to recognise any contradiction and simply assimilate new material into their previous way of thinking. They operate with systems that are consistent with their internal schemata and are confused as to why some of their answers are regarded as incorrect by the teacher. Cognitive conflict is also avoided when students uncritically adopt the algorithms advocated by teachers. For example, some students are told to line up the decimal points or to add zeroes (sic) to make decimals of equivalent length in order to ascertain magnitude. These students may temporarily comply with a procedure but may subsequently revert to behaviours consistent with their prior construct (Siegler, 2000).

The diagram below serves to summarise possible learning experiences and educational outcomes.

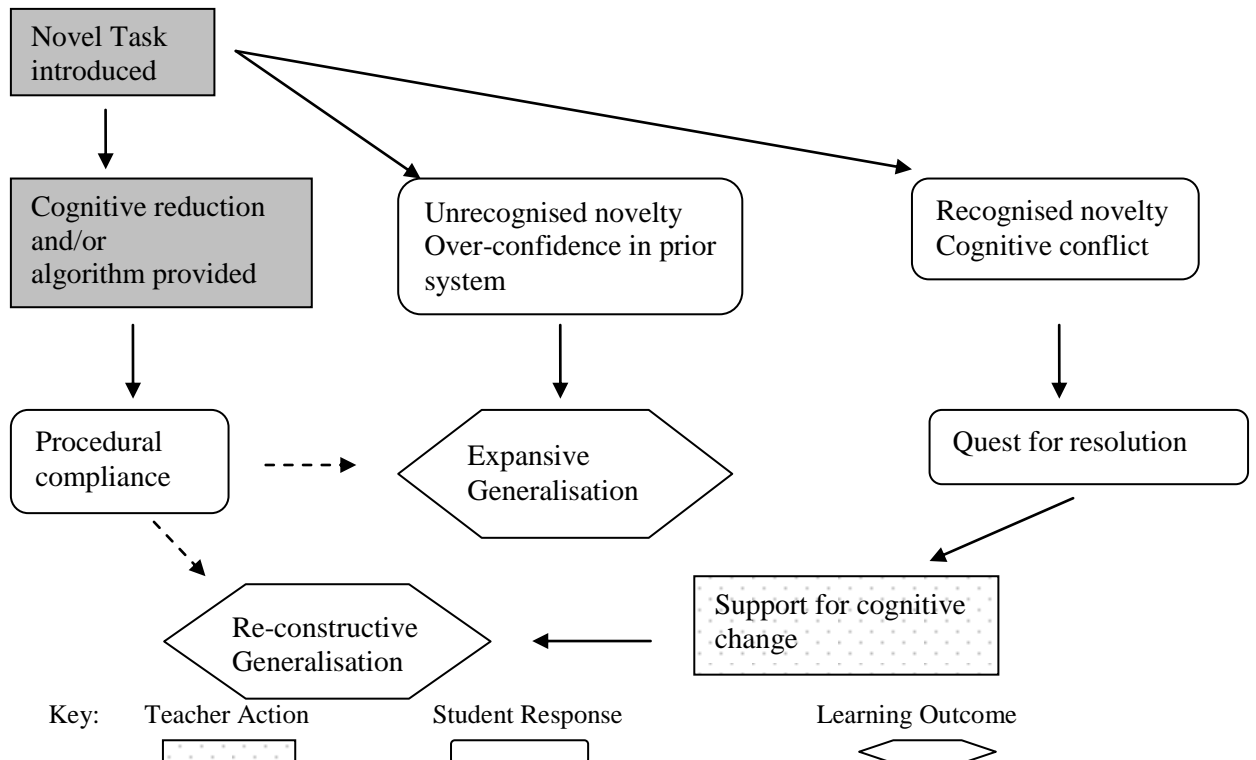

Figure 1. A Framework for Considering Cognitive Conflict in Lesson Design (Adapted from Moody, 2008)

Understanding decimal magnitude requires integration of the place-value convention of recording digits in columns with fractional understanding of denominators. Existing student constructs need not be regarded as problems but as sites to anchor new meaning. The linkage of new symbols and systems to concrete referents is seen as an important first step in understanding new concepts (Goldin & Shteingold, 2001). Equipment may faithfully represent the mathematics from the teacher's understanding, but it is the perspective of the student that will determine its efficacy as a learning tool (Stacey, Helme, Archer & Condon, 2001).

Situations where students have been creators of the evidence that produce cognitive conflict are seen as having great potential to initiate change. If students anticipate a particular result but are subsequently confronted with one that is unexpected, it may initiate deeper consideration of the prior construct, an activity that has been termed 'reflection on activity-effect relationships' (Simon, Tzur, Heinz & Kinzel, 2004). Some studies have shown that real-life experiences, whether enacted in the classroom or recalled from outside it, have facilitated shifts in thinking about decimals (e.g. Irwin, 2001). Measurement offers a powerful means of engaging students with number because relative magnitude is transparent. Students have a concrete reference for the symbol used to describe the quantity (Sophian, 2008). Use of metres and centimetres does not always help with decimals however as the common use of language (e.g. 1 metre and 45 centimetres for 1.45m) may reinforce the whole-number expansive generalisation.

In order to investigate the mechanism of conceptual change, intense collection of in-situ data of student engagement with a situation of potential conflict is required. Standard cross-sectional studies lack the temporal resolution to capture evolving (rather than evolved) competence and the subtlety of interactions as learning occurs (Lamon, 2007; Seeger, 2001). These considerations led to the adoption of micro-genetic methods (Siegler, 2007).

Method

Six students who were 'at, but not above' national expectations in mathematics were involved after consultation with the classroom teacher, the parents and the students themselves. They could order unit fractions but had received no formal teaching of decimals. In the study I was both the teacher and the researcher.

A design experiment model was used (Cobb, Confrey, Di Sessa, Lehrer & Schauble, 2003). Baseline data were collected via a personally modified version of the Decimal Comparison Test (DCT) designed by Stacey & Steinle (1999). The DCT has 30 pairs of decimals for comparison by magnitude. A group interview was also conducted. From these data, 5 intervention sessions were planned of approximately 45 minutes each. While a likely sequence of events was mapped, this methodology allowed for ongoing reflexive interaction between student responses and teacher initiatives (Gorard, Roberts & Taylor, 2004).

The enacted plan had sessions that focused upon the iteration of non-unit fractions including tenths, an introduction to decimal notation via equipment use, practical measurement tasks, games using decimals, and a brief exposure to additive tasks. No notes or formal procedures were given to the students. Instead, tasks were presented and conversations arose as students engaged with them, sometimes between pairs of students, as well as individual and group discussions with me. All dialogue was recorded using audio-tape and supplemented with collections of student work and personal field notes. These data were complemented by pre-and post-intervention interviews and written tasks.

Much of the practical work in sessions 2 and 3 centred upon the use of a commercial product known as Pipe Numbers. Pipe Numbers are a set of plastic tubing cut to scale with 1, 1/10 and 1/100 pieces. They are a linear model of the number system and conceptually identical to the Linear Arithmetic Blocks (LAB) described by Helme and Stacey (2000). The portability of Pipe Numbers enhances their suitability for use in measurement tasks.

Results

This section documents evidence of the initial and final thinking of all of the participants and especially tracks the learning of Grace and Wini (as representatives of the two common expansive generalisations) via samples of conversation and written work.

Table 1
Details of Participants

Pseudonym	Gender	Ethnicity	Age	System Descriptor	Consistency Score*
Mary	F	Pakeha	9	No pattern	n/a
Ripeka	F	Maori	9	Longer larger	100
Tame	M	Maori	9	Longer larger	100
Grace	F	Pakeha	10	Longer larger	100
Wini	F	Maori	10	Shorter larger	93
Aroha	F	Maori	10	Shorter larger	87

* The consistency score is the percentage of answers that conform to the system descriptor.

During session 1, the students made models of non-unit fractions, including using the Pipe Numbers to model tenths. They were introduced to the convention that a fractional quantity involving tenths could also be represented in decimal notation, e.g. 3/10 as 0.3. The following excerpt comes from session 2 of the intervention. Students were again making models of numbers using the Pipe Numbers equipment but were given a new challenge.

Teacher: See if you can make this one, 0.12.
Wini: That's twelve!
Teacher: OK, see what you will make. [Not giving validation or refutation, but simply asking that the task be carried out].
Wini: Twelve! Got it! (Showing a model that used twelve tenths).
Teacher: So you've put twelve of those tenths on, OK, what does that symbol tell us? (Pointing to zero).
Wini: Zero.
Teacher: How many ones is that? (Pointing to 0.12 written on the board).
Wini: Zero.
Teacher: But your one (meaning her model) is bigger than 1. (Wini went away and returned a few minutes later with a new model).
Teacher: OK, you're using some of those little ones. You've got ten tenths and two of those little ones. (Wini was making another model using twelve pieces). So you've made me a whole one and those little ones. You've made me 1.02.
Wini: I don't get it!
Teacher: That's OK, I never said this one would be easy, it is hard.

As the teacher, I resisted the urge to 'help' her and thus bypass her personal agency to learn. Wini adjusted her model by replacing one of the one-hundredth pieces with a one-tenth piece. Her model still involved twelve pieces, but a new piece of feedback was possible.

Teacher: That is 1.11

Wini: (After a pause) Oh!

She then adjusted her current model to the correct one, gave me an expectant look, and then received a nod. She had used the information received from my responses (1.02 and 1.11) and reinterpreted how the task would be completed. Her responses to subsequent tasks showed that she had not merely interpreted the physical model but was engaging with the underlying place value concept.

In session 3, students measured and recorded lengths of objects in the room. Recording and presenting each set of measurements on A3 paper allowed the students to see and discuss each other's data.

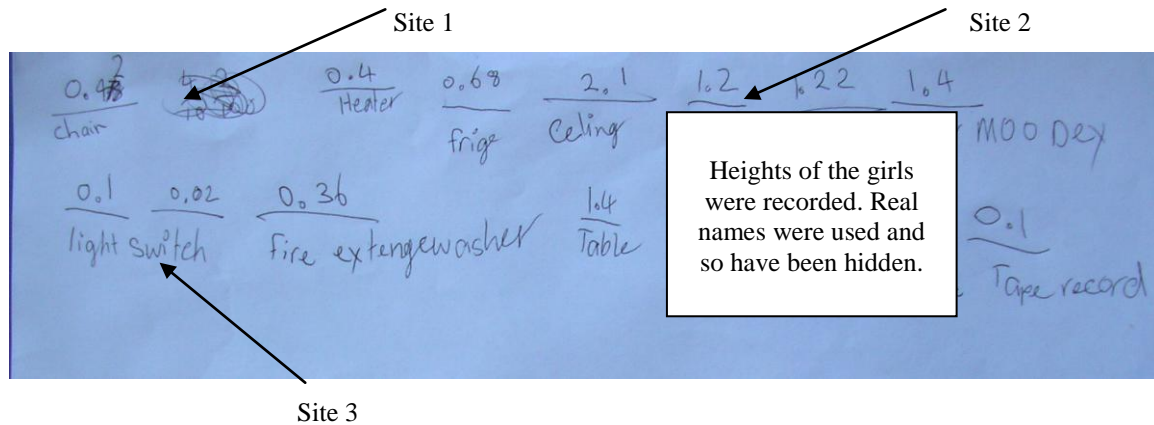

Figure 2. Photograph of Student Work by Grace and Wini

Table 2
Comparison of Students' Initial and Final Responses to the DCT

Pseudonym	Initial System	Consistency	Final System	Consistency
	Descriptor	Score	Descriptor	Score
Mary	No pattern	n/a	Correct to 2dp	90
Ripeka	Longer larger	100	Correct	93
Tame	Longer larger	100	Correct	97
Grace	Longer larger	100	Correct	97
Wini	Shorter larger	93	Correct	100
Aroha	Shorter larger	87	Correct	100

Each student was then directed to three pairs of examples from their two DCT scripts and asked to explain why they had made changes. Their scripts were unmarked so as not to provide external validation of either response. The student's new answer is underlined.

Wini: (0.55 and 0.555) Five thousandths more. (Previously a 'shorter is larger' system was used.)
 Grace: (0.75 and 0.8) It's larger, it has an extra tenth; when I first started I thought that (pointed to 0.75) was the highest because of seventy-five. (Previously a 'longer is larger' system was used.)

The students' knowledge of decimals was re-assessed after 6, then 16 months and found to be secure.

Discussion

The initial data showed that 5 of the students were consistently working from secure prior constructs as predicted by earlier research (e.g. Neshet & Peled, 1986; Steinle & Stacey, 1998). These constructs can be described as expansive generalisations as the

procedures arising from them can be explained as the misapplication of a previously observed rule (Harel & Tall, 1991; Zazkis et al, 2008).

In accordance with the application of variation theory (Runesson, 2005), the similarities and differences between prior knowledge and new evidence arose in meaningful ways for the students. The cognitive conflict this awareness created was managed by the teacher in order to address the issue of resistance to change (McNeil & Alibali, 2005; Zazkis & Chernoff, 2008). For example, in the transcript excerpt from Session 2, Wini was confronted with two ‘truths’ that could not simultaneously co-exist. 0.12 must represent twelve tenths according to her whole-number schema, but the knowledge that ten tenths was equivalent to one whole was also known to be true from her understanding of fractions. The conflict arose from the unexpected result (Simon *et al*, 2004) and resolving this tension is a vital part of re-constructive generalisation according to Harel & Tall (1991). The benefit of simultaneously using concrete referents (Stacey et al, 2001), realistic problems (Irwin, 2001) and measurement tasks (Sophian, 2008) can be seen when examining three items from the work sample of Grace and Wini shown in Figure 2.

At site 1, the chair’s measurements were originally recorded as $\frac{4}{10}$ and $\frac{2}{100}$. This indicated that the students were initially thinking in fractional terms from using the Pipe Numbers and then applying their new proficiency with decimal notation. They could interact with one place value column at a time. The common pronunciation of “point four two” does little to convey meaning. Encouraging students to decode the symbol as four tenths and two hundredths may help reinforce the connection between the new symbol and the more familiar expression of that quantity. As Goldin and Scheingold (2001) suggested, developing clear links between quantity, vocabulary and symbol is critical for new understanding.

At site 2, the girls knew that they were very similar in height but in ‘longer is larger’ terms, 1.22 is much bigger than 1.2, while in ‘shorter is larger’, it’s much smaller. This was a meaningful context where two decimals can be demonstrated as being of similar size despite there being a different number of digits used to represent the quantity.

At site 3, the length of the switch (0.02), was seen as smaller than the entire light fitting (0.1), and thus attention was drawn on the place value of the digits used to record the measurement. This stands in contrast to the large number of Year 8 students in the NEMP study who could not distinguish 0.7 from 0.07 (Flockton et al, 2006).

Decimals in the context of games and in tasks that did not use pipe numbers were important in establishing whether place-value thinking was changing or simply mastery of a new manipulative was being exhibited. It appeared that the students were able to see past the materials to the mathematics in that they were applying place-value language to make decisions concerning magnitude and were extending such discussions beyond tenths and hundredths, the limit of the physical representation. For example, in the student-initiated discussion of thousandths, the students had begun to consider the decimalisation process as generalisable. They started to discuss the equipment in terms of what it *could be*, rather than what it *was*. It is these glimpses of insight into how small experiences can lead to conceptual change that micro-genetic study is especially suited to capture (Siegler, 2007).

The final DCT data indicated that all students had improved in their ability to order decimal numbers. It was inferred that this was due to a reconstruction of their place value schemata as they had not been given any new procedures to adopt. The high consistency scores showed that the students were working from stable schema. This did not imply that

their previous schemata had been totally eliminated from their thinking but that currently the new conception was clearly dominant (Siegler, 2000).

Conclusion

This study investigated the mechanism of conceptual change with respect to decimal magnitude. This was in response to continuing reports of student difficulties (e.g. Flockton et al, 2006) and in recognition that the change process is complex and required further investigation (McNeil & Alibali, 2005). Its findings demonstrate that it is possible to stimulate cognitive conflict by involving students in practical tasks and providing them with feedback on the contradictions that arise between new evidence and prior thinking. It is thought that student production of evidence was an important factor in initiating steps towards conflict resolution. The need to unambiguously communicate measurements may have helped the students to appreciate why they should discontinue use of an expansive generalisation. Self-realisation of the reasons for change is a factor in countering the durability of primitive schema (Harel & Sowder, 2005). As Zazkis and Chernoff (2008) suggested, students who exercise personal agency when faced with potential cognitive conflict are more likely to respond to counter-examples with new learning than those where expert opinion is simply presented to them.

In agreement with Sophian (2008), the findings of the study also showed that the use of a measurement-based system to represent numbers has much to commend it. Combining this system with practical activities allowed for student engagement with issues of decimal notation as these arose in context. Their resolution could proceed at the pace of student thought and at student-chosen moments without the teaching agenda being compromised. As Siegler (2007) suggested, the use of a micro-genetic approach allowed for the capture of important details of student learning. These provided insight into the thoughts of students as learning occurred. It is suggested that further studies are undertaken into the mechanisms whereby situations of potential cognitive conflict result in student re-conceptualisation, particularly in areas of known learning difficulty.

References

- Cobb, P., Confrey, J., Di Sessa, A., Lehrer, R., & Schauble, L. (2003). Design experiments in educational research. *Educational Researcher*, 32(1), 9-13.
- Flockton, L., Crooks, T., Smith, J., & Smith, L. (2006). *Mathematics assessment results 2005*. Ministry of Education, New Zealand.
- Goldin, G., & Shteingold, N. (2001). Systems of representations and the development of mathematical concepts. In A. A. Cuoco & F. R. Curcio (Eds.), *The roles of representation in school mathematics* (Vol. 2001 Yearbook, pp. 1-23). Reston, VA: National Council of Teachers of Mathematics.
- Gorard, S., Roberts, K., & Taylor, C. (2004). What kind of creature is a design experiment? *British Education Research Journal*, 30(4), 577-590.
- Harel, G., & Sowder, L. (2005) Advanced mathematical thinking at any age: Its nature and development. *Mathematical Thinking and Learning*, 7(1), 27-50
- Harel, G., & Tall, D. (1991). The general, the abstract, and the generic in advanced mathematics. *For the Learning of Mathematics*, 11(1), 38-42.
- Helme, S., & Stacey, K. (2000). Can minimal support for teachers make a difference to students' understanding of decimals? *Mathematics Teacher Education and Development*, 2, 105-120.
- Irwin, K. (2001). Using everyday knowledge of decimals to enhance understanding. *Journal for Research in Mathematics Education*, 32(4), 399-420.
- Lamon, S. (2007). Rational numbers and proportional reasoning: Toward a theoretical framework for research. In F. Lester (Ed.), *Second handbook of research on mathematics teaching and learning*. (Vol. 2, pp. 629-668). Reston, VA: NCTM.

- McNeil, N., & Alibali, M. (2005). Why won't you change your mind? Knowledge of operational patterns hinders learning and performance on equations. *Child Development*, 76(4), 883-899.
- Moody, B. (2008). *Connecting the points: An investigation into student learning about decimal numbers*. Unpublished Masters thesis, University of Waikato, Hamilton, NZ.
- Nesher, P., & Peled, I. (1986). Shifts in reasoning. *Educational Studies in Mathematics*, 17(1), 67-79.
- Okazaki, M., & Koyama, M. (2005). Characteristics of 5th graders' logical development through learning division with decimals. *Educational Studies in Mathematics*, 60(2), 217-251.
- Runesson, U. (2005). Beyond discourse and interaction. Variation: A critical aspect for teaching and leaning mathematics. *Cambridge Journal of Education*, 35(1), 69-87.
- Seeger, F. (2001). Research on discourse in the mathematics classroom: A commentary. *Educational Studies in Mathematics*, 46(1), 287-298.
- Siegler, R. (2000). The rebirth of children's learning. *Child Development*, 71(1), 26-35.
- Siegler, R. (2007). Cognitive variability. *Developmental Science*, 10(1), 104-109.
- Simon, M., Tzur, R., Heinz, K., & Kinzel, M. Explicating a mechanism for conceptual learning: Elaborating the construct of reflective abstraction. *Journal for Research in Mathematics Education*, 35(5), 305-329.
- Sophian, C. (2008). Rethinking the starting point for mathematics learning. In O. Saracho & B. Spodek (Eds.), *Contemporary perspectives on mathematics in early childhood education* (pp. 21-44). Charlotte, NSTUDENT Information Age Publishing.
- Stacey, K., Helme, S., Archer, S., & Condon, C. (2001). The effect of epistemic fidelity and accessibility on teaching with physical materials: A comparison of two models for teaching decimal numeration. *Educational Studies in Mathematics*, 47(2), 199-221.
- Stacey, K., & Steinle, V. (1999). Decimal comparison test. Retrieved February 8, 2006, from <http://extranet.edfac.unimelb.edu.au/DSME/decimals/SLIMversion/tests/comptest.shtml>
- Steinle, V., & Stacey, K. (1998). The incidence of misconceptions of decimal notation amongst students in grades 5 to 10. In C. Kanes, M. Goos & E. Warren (Eds.), *Teaching mathematics in new times: Proceedings of the 21st annual conference of the Mathematics Education Research Group of Australasia* (Vol. 2, pp. 548-555). Gold Coast, Qld.: MERGA.
- Young-Loveridge, J. (2007). Patterns of performance and progress on the numeracy development projects: Findings from 2006 for years 5-9 students. In *Findings from the New Zealand numeracy development projects 2006* (pp. 16-32, 154-177). Wellington, NZ: Learning Media.
- Zazkis, R., & Chernoff, E. (2008). What makes a counterexample exemplary? *Educational Studies in Mathematics*, 68(3), 195-208.
- Zazkis, R., Liljedahl, P., & Chernoff, E. (2008). The role of examples in forming and refuting generalizations. *ZDM The International Journal on Mathematics Education*, 40(1), 131-141

A Decade of MERGA Theses

Judith A. Mousley
Deakin University
judym@deakin.edu.au

The MERGA website has a list of the titles of the last 10 years of Australasian mathematics education Masters and Doctoral theses, with linked abstracts. After a discussion about the socially-determined nature of document analysis, this paper reports the results of an interpretive document analysis of the web page and the pages of abstracts, with a focus on (a) numbers of theses, by year and by institution; (b) methodological approaches used; (c) countries where data were collected; and (d) theses topics. Begle's (1979) framework of mathematics education domains is used to categorise 3 descriptors for each thesis.

The Mathematics Education Group of Australia (MERGA) website page headed *Recent Australasian Theses in the Field of Mathematics Education* (MERGA, 2010) lists mathematics education Masters (by research), PhD, DPhil, and EdD theses written or supervised by Australians and New Zealanders from 2000 to 2009. This list is not a complete list, for reasons given below, but it gives a good sample—280 theses at the time this paper was written. The website includes theses by Australasians, no matter where they graduated, as well as those of international students enrolled in Australasian universities. While the majority of graduates listed are or were MERGA members, some are/were not; but an analysis of the titles and abstracts gives a general sense of the work of Australasian higher degree by research (HDR) students in the area of mathematics education. Such analysis helps to identify strengths and limitations of this aspect of the work of MERGA members and the broader mathematics education academic community.

Educational inquiry based on document analysis captures the individual, so its aim is to understand rather than to generalise or predict. The actions of members of a sub-set of society at a particular time are recognised as "objects" worth studying, rather than replicable phenomena. The result is usually categories of description that have common elements, often so interrelated that it is hard to discuss one without reference to others (Cope, 2000; Herbert & Pierce, 2009), but the categories give structure to reporting and discussion of the results (Akerlind, Bowden & Green, 2005).

Even though the resulting theory is "grounded" in the data (Glaser & Strauss, 1967), researchers involved in document analysis need to decide on what the categories will be—what to draw out of the raw data and how to group these phrases. Such decisions are socially constructed because understanding of aspects of documents is influenced by social contexts because the areas of interpretive focus and the ways data are manipulated are socially determined (Patton, 2002; Van Manen, 1990).

There are three reasons for my use of the seminal theoretical framework developed by Begle (1979) for this analysis of the MERGA webpage. First, Begle identified a range of critical variables for the teaching and learning of mathematics, specifically. He described five major domains: *Teachers*, *Curriculum*, *Students*, *Environment*, and the *Instructional process*, noting the extent to which each impacts on students' achievements in mathematics. Second, this framework seemed initially to provide a simple, yet all-encompassing, framework for analysis of mathematics thesis topics. Third, Begle's framework was used by Graham Jones (1987), a life member of MERGA, to show how Begle's work was relevant to the young MERGA community, so it seemed appropriate to use it for this HDR analysis many years later.



The Website and Methodology

The web page and its associated pages of abstracts were compiled by the author, using the online thesis lists of the Australian Council for Educational Research, via the Cunningham Library website (ACER, 2010); the Australasian Digital Thesis Program data base constructed by the Council of Australian University Librarians (CAUL, 2010); the data bases available via Royal Melbourne Institute of Technology Publishing's *Informat* service (RMIT, 2010); and details emailed to me by authors and supervisors.

For each of the 280 theses, the website lists author, title, and institution of enrolment—grouped by year of completion. Most titles are linked to electronic abstracts, and some abstracts have links to the full text of the relevant theses. Whether the title only, title and abstract, or full text are available depends mainly on the year of publication, because until 2004 many university libraries did not file electronic abstracts or full texts of theses. This practice is now almost universal for recent theses in both Australia and New Zealand.

However, the MERGA webpage does not contain a complete list of relevant theses. ACER, CAUL, and RMIT record details sent to them by university librarians and research officers, and some are better at doing this than others. They also trawl university sites for records. Further, while many MERGA members (supervisors or students) have noted missing theses and provided the relevant details, other mathematics educators have not. Thus the titles used—the 280 listed at the beginning of March 2010—could be considered a comprehensive sample that is representative of a larger body of work, but certainly not statistically representative. Other theses have been added since March, so this paper is a snapshot in time.

The web-page details for each thesis (year, title, and institution) were extracted from the MERGA webpage and entered into a spreadsheet. From this record, the numbers of thesis completions from each country, for each year, and for each institution were determined. With a focus on research topics, the titles and abstracts were then scanned visually for key words that were entered into the spreadsheet—3 per thesis. The 840 descriptors were then grouped according to Begle's (1979) five domains, and some sub-domains, for discussion. The level of schooling involved and the broad methodological approaches (such as quantitative, qualitative, action research) were then recorded—often necessitating access to the full text if this were available. No attempts were made to decipher the types of qualitative research into categories such as phenomenology, hermeneutics, existentialism, etc., although “case study” was such a common descriptor that its use was noted separately. If a title or abstract indicated that a graduate was from a country other than Australia or New Zealand, this was also recorded.

By counting the number of words or phrases in each category and sub-category the details available were converted to the numbers reported below. While there is some discussion of phenomena across factors, these were merely observations that I found interesting and I made no systematic attempt to undertake a cross-factorial analysis. Access to the full texts of the theses would be needed for a thorough cross analysis and it would be appropriate to use analyses of variance measures of significance.

Results and Discussion

This section focuses first on changes in the numbers of theses recorded, by year and then by institution. The second focus is on research approaches used to collect thesis data, and the third on levels of mathematics education, followed by a short account of countries where data were collected. The topics of the theses are then allocated to Begle's domains.

Numbers of Theses

While acknowledging that the sample is not a complete list, especially for 2009 which is waiting on notifications for the last half of 2009, it is interesting to note the number of theses recorded, for Australia and New Zealand institutions from 2000 to 2009 (see Figure 1). It seems that there was a major decrease between 2002-3 and 2005-6 in Australian theses, but that can be explained by the federal government initiative in mid-2001 that tied both funding and the numbers of future funded HDR places to thesis completion rather than research training (thesis supervision). In 2002 and 2003, many HDR students—and particularly part timers—were pressured and supported to complete and submit theses, resulting in an artificial bulge in 2002 and 2003. In fact, analysis shows that most of the bulge came mainly from 2 institutions (see Figure 2). On the other hand, the New Zealand figures have been comparatively steady, with between 3 and 6 completions being recorded annually since NZ university libraries joined the CAUL reporting process in 2002.

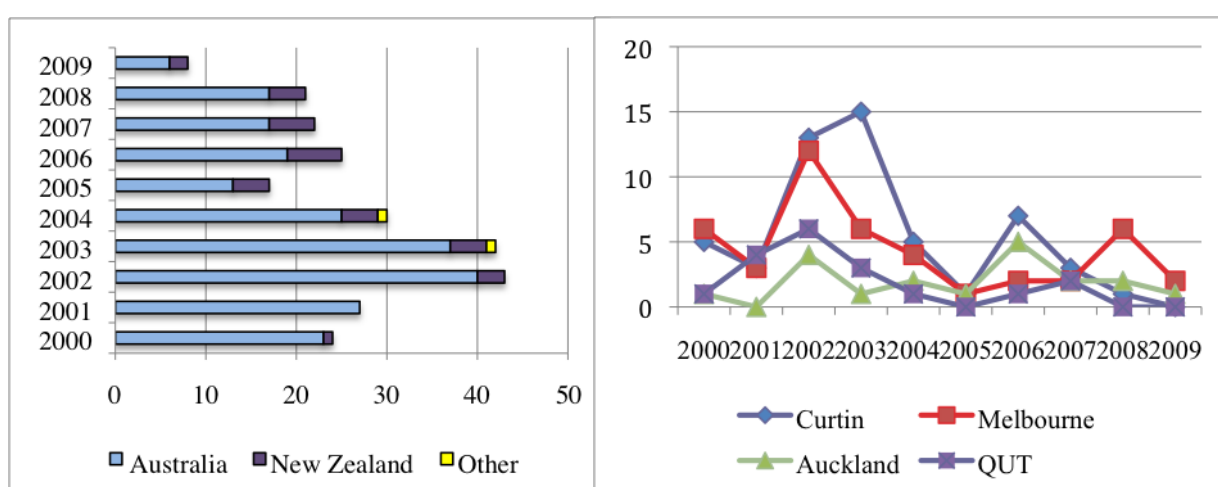

Figure 1: Numbers of theses listed from 2000 to 2009, by country.

Figure 2: Theses listed from 2000 to 2009: 4 most productive institutions.

A point that really must be stressed here is that high numbers of completions do not correlate with high quality theses, the hours spent on supervision, or the nature and quality of the student experience or the thesis. The number of completions per institution (see Figure 3 below) is a product of many factors including previous completion numbers, HECS scholarships other funds and subsidies, student choice based on facilities, part time work availability, or more ephemeral aspects such as universities' and supervisors' reputation. The nature of the local and student populations are also relevant, with some universities typically attracting more international students, people willing to study at a distance, and/or students from specific countries.

The establishment of the funded national centre also had long-term effects on student numbers at Curtin University, although staff needed to work hard to establish and maintain a strong research student base and reputation. Staff also make a difference, especially when they attract external funding that can be applied to research training and part time tutoring or when they have developed a strong and appealing research agenda. Further, I noted a number of MERGA members from New Zealand and the Pacific Islands who had studied in Australia, so this would have lessened potential numbers of completions for New Zealand institutions.

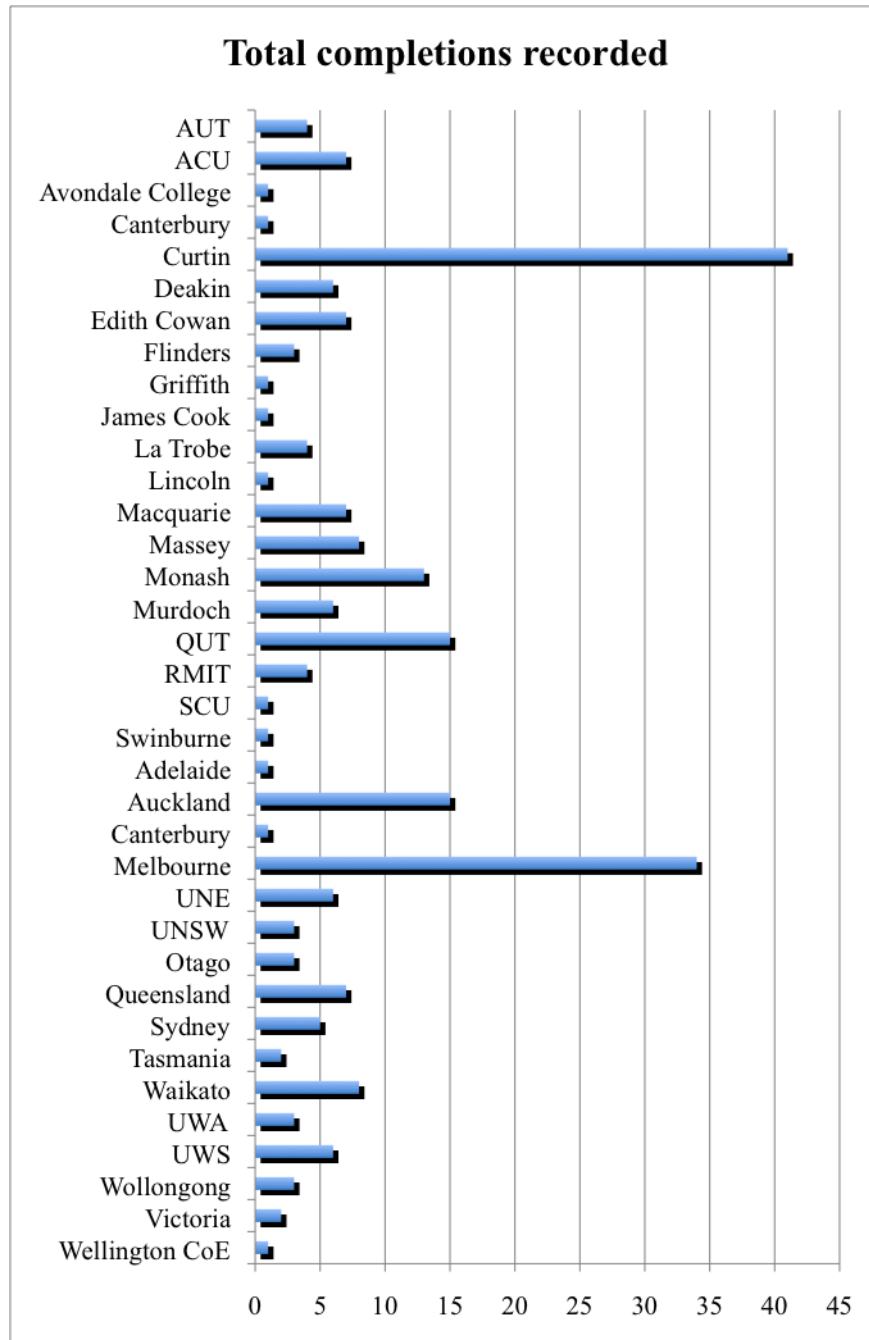

Figure 3: Theses listed, by institution.

Research Methods

Of the 280 theses listed on the website, 18 (6%) used quantitative methods only; 218 (78%) used qualitative methods only, including 37 (21%) that were described as case studies; 11 (4%) used a combination of quantitative and qualitative methods; and 7 (2%) used action or participatory research. The methods were unclear from the abstracts of 41 theses (14.64%).

I noted that Melbourne University had a higher percentage of quantitative studies than other universities that had 3 or more completions, while Curtin University had a relatively high percentage of case studies.

Country of Data Collection

I was interested to note that HDR data had been collected in at least 25 non-Australasian countries, because supervision of higher degrees is one way for Australians and New Zealanders to have an impact on mathematics education research and teaching in other countries, particularly in developing regions.

The 46 theses involved included 17 (37% of the 46) for the S.E. Asian region and 16 (35%) in Africa and Mauritius. For single countries, South Africa headed the list (9, or 20%), followed by Indonesia, Malawi, and Singapore (5, or 11% each).

Levels of Mathematics Education

The majority of theses were about teaching mathematics, as expected, but many of their titles and abstracts did not give information about the level of schooling. It was very clear, though, that where the level *was* specified (225 theses) there were many more where the researchers had attended to secondary education than to any other level (see Figure 4).

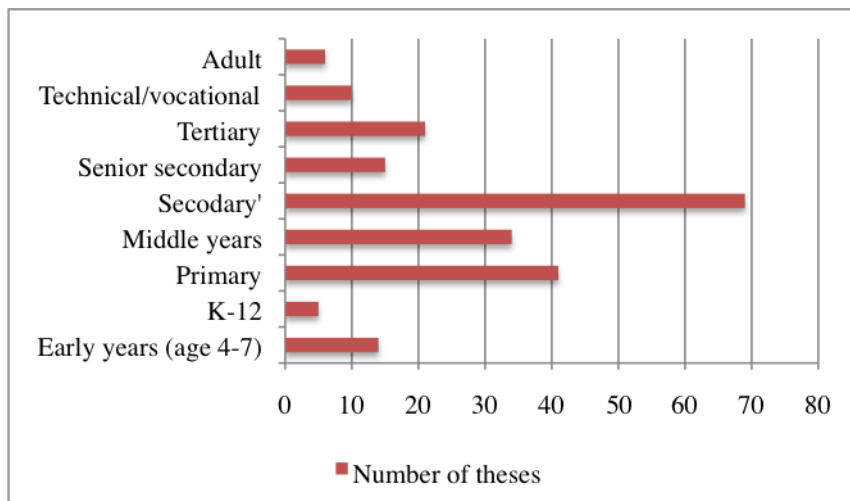

Figure 4: Levels of schooling

Topics of Theses

I experienced no problems allocating each of the 840 descriptors to one of the domains used by Begle (1979). The result is shown in Figure 5.

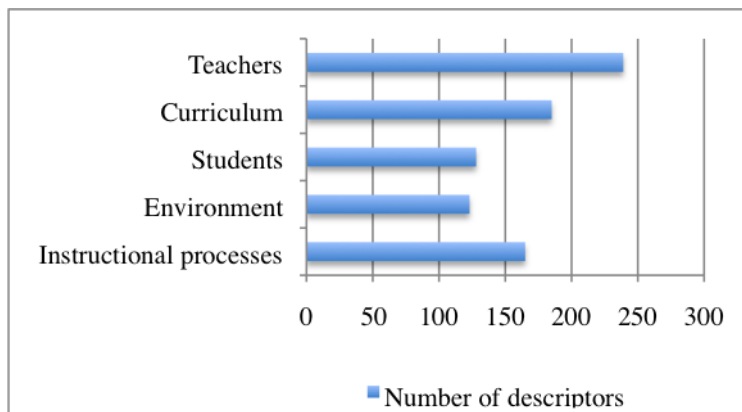

Figure 5: Descriptors allocated to Begle's 5 domains of mathematics education

Teachers. There were 239 theses that focused on teachers. The major category was teacher development, which included professional development (50, 20% of the *Teachers* category) and pre-service teacher education (42, or 18%). Teachers’ beliefs and values were a focus in 49 theses (20%). Teachers’ knowledge was a topic of 47 theses (20%), including 23 theses that focused on pedagogical content knowledge. Planning, mentoring and interpersonal skills were the foci of smaller numbers of theses about teachers.

Curriculum. Of the 185 *Curriculum* entries, 105 focused on content areas, as shown in Figure 6, below. Because of the large number of theses about rational number (15, or 15% of the *Curriculum* entries, including 7 on decimal fractions), these were not included with other Number entries that were mainly about computational processes and thinking.

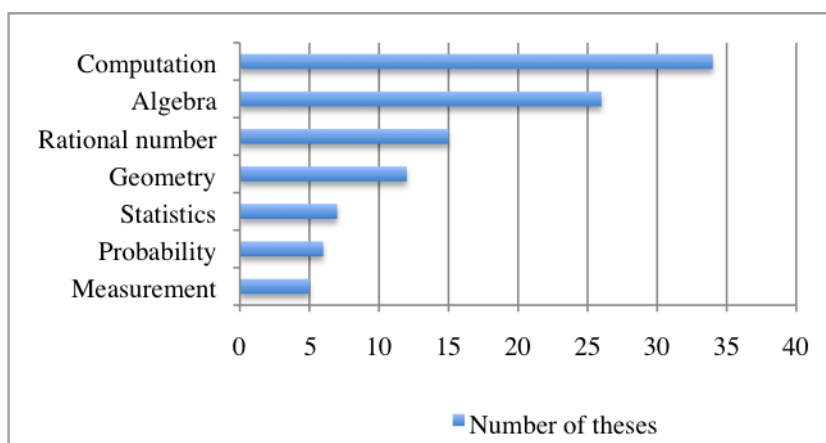

Figure 6. Content areas that were the focus of theses.

Theses referring to non-content aspects of the curriculum numbered 80. These included curriculum reform and politics (25, or 43% of *Curriculum*), problem solving (25, 14%), developing number sense (12, 6%) and integrated curriculum (10, 5%).

Students. There were 128 theses that focused on students (15%). This category included 44 (34% of the *Students* category) about affective factors and students’ perceptions of mathematics and maths classes. The other *Students* categories were family/SES factors (28, 21%), language/NESB (25, 20%), knowledge/ability (18, 14%), and gender-focused studies (13, 10%).

The Educational Environment. A total of 123 studies referred to the educational environment (15% of all descriptors). External factors included policy and standards (6, or 5% of the *Environment* category). School and social factors accounted for 16 descriptors recorded (13%). The classroom climate was a popular topic (27, 21%), as was collaboration and peer interactions (31, 25%), which Begle (1979) included in *Educational Environment*. The major descriptor in this category, however, was assessment (33, 27%), including only 3 theses that focused on broad-based (state or national) assessment.

Instructional Process. This category was noted 165 times (20% of all descriptors), and 3 sub-categories were noted. First, tools (textbooks, manipulatives, games, and technology) had the majority of mentions (99, or 60% of the *Instructional processes* category—see Figure 7). A break-down of the technology entries is shown in Figure 8.

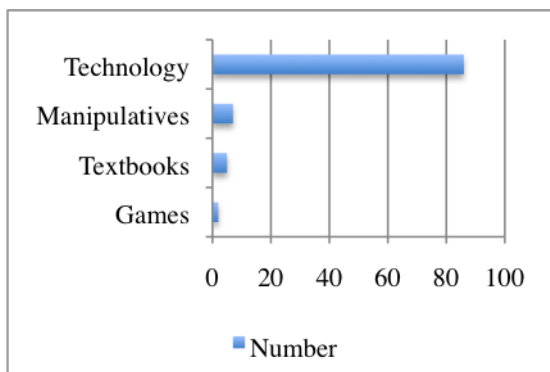

Figure 7: Sub-categories of Tools.

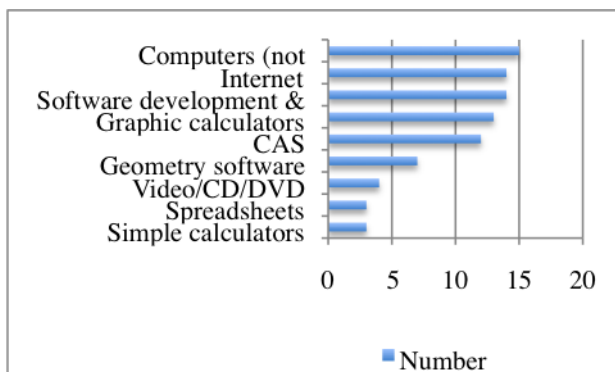

Figure 8: The Technology entries.

The second sub-category of *Instructional processes* was used when authors referred to specific theories of learning (40 entries, or 24% of this category), as shown in Figure 9. The final sub-category in *Instructional processes* was for teaching approaches (26 entries, or 16% of this category), as illustrated in Figure 10.

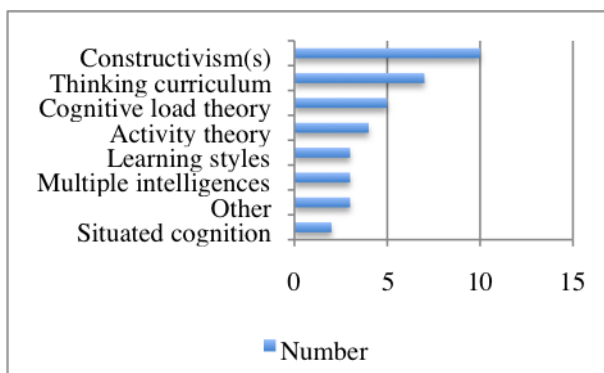

Figure 9: Learning theories entries.

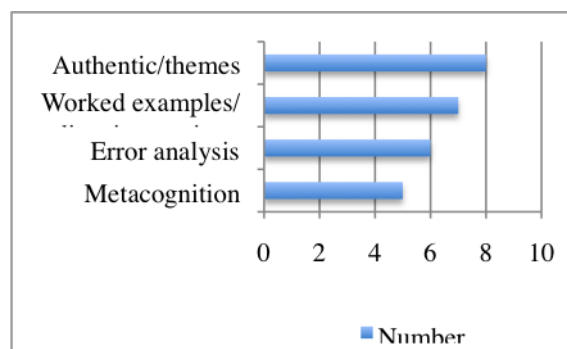

Figure 10: Teaching approaches entries.

Conclusion

The analysis is a snapshot of two aspects of the scholarship of MERGA members and the broader mathematics education community over the past decade—the completion and supervision of higher degrees by research theses. In summary, one could note:

- a fairly steady (except for an artificial bulge) number of thesis completions in mathematics education in Australasia;
- a rate of completions that seems to have fallen off in the last few years;
- major differences between institutions in numbers of thesis completion;
- about 12 times as many qualitative studies as quantitative studies;
- a wide range of countries being sites for data collection, with potential for major contributions to local mathematics education research communities;
- a heavy focus on the “Number and algebra” strand(s) of national curricula;
- many theses examining the use of a range of technologies; and
- application of a number of learning theories.

One could also note a wide variety of thesis topics, spread relatively evenly over the 5 domains of Begle’s (1979) framework, which proved to be a useful and inclusive set of categories and sub-categories for sorting the thesis descriptors, despite that fact that it was created 30 years ago.

References

- Akerlind, G. , Bowden, J. & Green, P. (2005). Learning to do phenomenography: A reflective discussion. In Bowden, J. A., & Green, P. (Eds.) *Doing developmental phenomenography* (pp. 74–100). Melbourne: RMIT University Press.
- Australian Council for Educational Research (ACER, 2010). *Cunningham Library: Recent Australian digital education theses*. Retrieved March 3, 2010, from <http://www.acer.edu.au/library/acquisitions/digit-theses.html>.
- Begle, E. G. (1979). *Critical variables in mathematics education*. Washington, DC: Mathematics Association of America and National Council of Teachers of Mathematics.
- Cope, C. (2000). *Educationally critical aspects of the experience of learning about the concept of an information system*. Unpublished PhD Thesis, La Trobe University, Bundoora, Vic.
- [Council of Australian University Librarians](http://www.adt.caul.edu.au/) (CAUL, 2010). *Australasian Digital Thesis Program*. Retrieved March 3, 2010, from <http://adt.caul.edu.au/>.
- Glasser, B. G., & Strauss, A. L. (1967). *The discovery of grounded theory: Strategies for qualitative research*. Edison, NJ: Aldine Transaction.
- Herbert, S. & Pierce, R. (2009). Revealing conceptions of rate of change. In R. Hunter, B. Bicknell, & T. Burgess (Eds.), *Crossing divides: (Proceedings of the 32nd annual conference of the Mathematics Education Research Group of Australasia, Vol. 1, pp. 217–224)*. Palmerston North, NZ: MERGA.
- Jones, G. (1987). *Critical variables in mathematics education revisited*. Keynote address presented to the 10th annual conference of the Mathematics Research Group of Australia, held in Townsville, July 1987.
- Patton, M. Q. (2002). *Qualitative research and evaluation methods*. Thousand Oaks, CA: Sage Publications.
- Royal Melbourne Institute of Technology (RMIT, 2010). *Informit*. Retrieved March 3, 2010, from <http://www.informit.com.au/>.
- Van Manen, M. (1990). *Researching lived experience: Human science for an action sensitive pedagogy*. Albany NY: State University of New York Press.

Using Video-Stimulated Recall as a Tool for Reflecting on the Teaching of Mathematics

Tracey Muir
University of Tasmania
Tracey.Muir@utas.edu.au

This paper reports on the use of a reflective technique that incorporated video-stimulated recall to encourage reflection on practice. The author videotaped a series of mathematics lessons conducted by an experienced teacher, which were then collaboratively viewed and discussed, with the aim being to bring about changes in the teacher's practice. The findings indicated that the video footage was a powerful medium that stimulated deliberate reflection and led to changes in teaching approaches that were consistent with mathematical reform recommendations.

Recent research into effective teaching of mathematics has suggested that there are significant differences between teachers (Carroll, 2005), which invariably impact upon the quality of mathematics instruction offered to students. Professional learning has the potential to influence mathematics instruction, in that it can provide opportunities to influence teacher knowledge and beliefs and to expose them to practices that are consistent with the mathematical reform agenda. This agenda has an emphasis on written and verbal communication, working in co-operative groups, making connections between concepts and a focus on the process, rather than the answer (NCTM, 2000). While some mathematics teachers have embraced the mathematical reform, and emphasise conceptual understanding, thinking and problem solving, many students continue to experience mathematics that is dominated by memorisation and drill, without any meaningful context (Reys, 2002). While the reform agenda has influenced the nature of professional learning offered to teachers, evidence of sustained changes in teachers' practice has been limited. This may be partly attributable to the delivery of the process, such as employing a "top-down expert" approach, which often fails to engage teachers (Hargreaves & Fullan, 1992) and rarely leads to sustained changes in pedagogical practice. The study discussed in this paper describes the case of a personalised professional learning experience conducted with a practicing teacher, using video-stimulated recall of mathematics lessons. Specifically the research questions were:

In what ways, if any, does video-stimulated recall support reflection on one's mathematical practice?

What changes in practice (if any) occurred as a result of video-stimulated recall?

According to Day (1998), documentation of cases in which an external collaborator works with teachers over time is limited, and specific curriculum areas have been neglected in the reflection literature (Muir & Beswick, 2007). This paper adds to the limited research through providing details of an individual teacher's experience with a video-stimulated recall process that enabled him to reflect on his practice. In doing so, it also addresses the need for detailed descriptions of the process of teacher change (Clarke, 1997).



Theoretical Framework

Professional Learning and Change

Muir and Beswick (2007) identified that professional learning should be grounded in teachers' learning and reflection on classroom practice. Success is more likely to occur if this learning takes place as close to the teacher's own working environment as possible, provides opportunity for reflection and feedback, involves a conscious commitment by the teacher, and uses the services of a consultant and/or critical friend (Lovitt & Clarke, 1988).

Much of the mathematics professional learning documented in Australia at least, has focused the development of teachers' mathematical pedagogy through teachers' involvement in projects such as Count Me In Too (Bobis & Whitton, 1999) and the Early Years Numeracy Project (Clarke, Sullivan, Cheeseman & Clarke, 2000). Common features of these programs were that they were based around teachers' understanding of a particular intervention program or framework and involved facilitators working intensively with teachers to improve their practice and enhance student learning. Reports of such projects have detailed benefits to the participants and changes in teachers' practice, although it is often difficult to attribute improvements directly to the program, as other variables, such as leadership factors, may have resulted in the favourable outcomes observed.

The professional learning experience detailed in this paper differs from these approaches in that it was based on observation of teachers' current practices, and while aimed at developing appropriate pedagogical practices, did not advocate a prescribed program or framework. In common with other studies (e.g., Clarke, 1997; Day, 1998; Geiger & Goos, 2006; Olsen & Kirtley, 2005), a partnership was formed with a teacher educator who provided opportunity for professional dialogue to occur. Clarke (1997) for example, found that the role of the researcher in assisting to guide the teachers' reflections was a significant influence in bringing about changes in one teacher's practice. While the teacher in Olsen and Kirtley's (2005) study also found this to be beneficial, the critical factor in bringing about change was attributed to the opportunity to experience mathematics in a new way and continued engagement in professional learning.

Reflection and Video-Stimulated Recall

As both Clarke (1997) and Day (1998) found, the help of a critical friend was beneficial, and even essential, in enhancing reflection on practice. Research also indicates that video-stimulated recall has also been found to enhance reflection (e.g., Rosaen, Lundeberg, Cooper, Fritzen & Terpstra, 2008). Although also used with students (e.g., Tanner & Jones, 2007), in this context, the video stimulated process refers to a collaborative inquiry between the teacher and researcher, with the dialogue focused on thinking about aspects of practice (Powell, 2005). Powell (2005) found that video-stimulated reflective dialogues enabled teachers to articulate their thinking and feelings by defining a focus and context for inquiry into their professional practice. Both Day's (1998) and Powell's (2005) research involved the use of video footage to stimulate reflection by experienced teachers, but it appears the documentation of this process as it applies to practicing mathematics teaching is not extensive. Researchers such as Hennessy and Deaney (2009) have used video-stimulated recall to encourage teachers to articulate their pedagogy across a range of subject areas, while others such as Rosaen, et al. (2008) have used the technique with interns. Specifically, Rosaen et al.'s (2008) study examined the differences between what the pre-service teachers noticed when reflecting on lessons from

memory compared to when they viewed video footage of their lessons. They found that when using videotape, more specific observations were made, the statements were focused on instruction rather than classroom management, and the focus moved away from self and onto the children. Davies and Walker (2005) also provide an example of video footage being used to examine teachers' mathematical content knowledge and to document teachers' abilities to 'notice' significant mathematical instances. Their findings also support the recommendations of the use of a 'significant other' in that the teachers in their study, even with the use of video footage, needed guidance in order to learn to notice these moments and to respond appropriately.

Methodology

The study reported on in this paper was part of a larger study, which involved two main phases. The first involved the observation and videotaping of a sequence of mathematics lessons involving three upper primary teachers, while the second used an action research approach to engage the teachers in a process termed Supportive Classroom Reflection (SCR). The concept of SCR involved combining professional learning with enacted classroom practice and was designed to encourage the teachers to interpret, reflect on, and enhance their teaching of mathematics (for details of the SCR process, see Muir & Beswick, 2007). The teachers were not required to attend workshops or meetings off-site and collaborative viewing of the video footage occurred at the teachers' respective schools.

Jim, the teacher who is the focus of this paper, had been teaching for approximately 10 years. At the time of the study he was currently teaching in a Grade 5/6 class in a small primary school. A total of five of Jim's numeracy lessons were observed and parts of the lessons involving teacher led discussions were videotaped and transcribed within hours of observation. Field notes were also used to document aspects of the lessons, which were not captured on videotape. Following each lesson, the video footage was viewed by the researcher and Jim; discussions related to viewing the footage were audio-taped and promptly transcribed. A private room was used for the viewing of the video footage with Jim, prior to which he was asked to make any comments about the lesson he had just conducted and whether or not there were any incidents that particularly stood out. The aim of this was to contrast these comments with the comments made during and after the video footage, both in terms of which aspects he chose to reflect on and also to determine whether or not the video footage helped to increase the depth of reflections, as Rosaen et al. (2008) found. During the viewing of the footage, Jim (and the other teachers) was encouraged to make comments and/or pause the video at any time. The researcher also paused the video at certain points, mainly to clarify the teachers' intentions or to discuss a 'teachable moment' (Muir, 2008) or critical incident. Examples of these incidents, as they occurred for Jim, are provided later in this paper.

Each week the researcher visited Jim's classroom, videotaped an arranged mathematics lesson and viewed and discussed the lesson observed. This formed part of an action research cycle (Hopkins, 1993) that allowed for the possibility of providing evaluative feedback within and between the cycles of action and monitoring phases, enabling the next step to be influenced by the results of the intermediate analysis of the data from the previous stage. Specifically, the action research cycle involved the following steps:

1. Observe/gather information (collaborative viewing of video footage of lesson by researcher and teacher)
2. Analysis and interpretation (collaborative discussion of what happened in the lesson)

3. Formulation of plan (what will happen in the next lesson?)
4. Act/experiment (teach the lesson)

This cycle was repeated for each of the lessons observed. Each teacher was also asked to identify a focus area to work on; Jim chose to focus on teaching for conceptual understanding so weekly discussions occurred around this.

Data analysis commenced during the data collection process and units of analysis were created through ascribing codes to the data (Miles & Huberman, 1984). Data analysis for the SCR process was responsive, with categories derived from the teachers' responses, including the nature of reflective responses (self, practice, students) and the levels of reflection (technical, deliberate, critical; for a more detailed description of these levels see Muir & Beswick, 2007). Classroom observation data were also analysed according to categories and these were often referred to in subsequent discussions with the teachers. For example, quantitative counts were kept on the types of questions asked by teachers and the results of these counts were discussed with the teachers in the week following the lesson. The results and discussion that follow particularly look at the impact that viewing the video footage had on Jim's practice and the nature of his reflective comments that occurred as a result of viewing the footage and engaging in professional dialogue with the researcher.

Results and Discussion

Lesson One Observation and Reflection

The first lesson that was observed and videotaped followed a didactic approach in that the teacher modelled a particular process for students to follow. The students had previously been working on short division problems using single-digit divisors and the aim of this lesson was to build on this and introduce division with two-digit divisors. Students were seated on the floor in front of the whiteboard and the lesson began with a discussion on how to divide \$15 between four people. The division algorithm was modelled with contributions from the class, along with the process used to obtain an answer with a decimal remainder. The example of 764 divided by 15 was then written on the board using the standard division algorithm. This was again worked through as a class, with the emphasis being on following the same process used for single-digit divisors. Students were then given three problems to solve individually and were encouraged to use 'scrap paper' to record their guesses at how many multiples of the number (divisor) would be required to reach, or almost reach, the number. After students spent about twenty minutes working on the problems, the class gathered again in front of the whiteboard and strategies students used to multiply the divisor were shared. The lesson concluded with a discussion on how students felt about completing the problems.

Prior to watching the video footage, Jim indicated that he was quite pleased with how the lesson went. He was critical about his lack of confidence in using specific mathematical terms (e.g., divisor, dividend) as the following excerpt shows:

I think personally it's really poor on my part not being confident enough to use the specific mathematical terms, which I know is really important um cause we're trying to get the mathematical language through that um so that's not an oversight, but probably lack of planning on my part um and knowledge about using the recurring [decimals] and so it's something that I need to brush up or rebrush up on make sure I know it for next time, so they've got those answers there which they're genuinely interested about ...

During the viewing of the video footage, Jim made comments about himself, his practice and the students. He made personal reflections about his failure to model the

correct mathematical terminology and stated that he “was quite embarrassed about that”. Further on in the session, Jim’s personal comments indicated that he was quite critical of himself and sought reassurance from the researcher:

With regard to planning, I know what I want to achieve, but as far as that – should I be doing that more? [I] tend to rely on what’s happened in the past.

Several reflective comments were made about his practice, often in response to the researcher’s questioning:

R: Was there anything you particularly noticed from the video footage that you didn’t reflect on immediately following the lesson?

J: Questioning – some of the kids were taking the questions a bit further – you have to have a balance between the information you just hand out – sometimes I asked the question and gave the answer too quickly ... there were 5 or 6 main characters (involved in the discussions) – maybe I could try a strategy of talk to the person next to you – or small groups would be better ... time factor – it was a pretty big block of time – that was more obvious from the video – not an appropriate length of time to have them sitting there

Jim recognised that the discussion around decimals and recurring decimals was problematic:

... because you see that ‘recurring’ – that was almost a flippant comment when we first started, and now they’ve picked up on it, so probably shouldn’t even have introduced it until a later stage.

This last comment provided the opportunity for professional conversation to occur, and partly led to Jim selecting a focus on conceptual understanding as a goal to work on throughout the SCR process.

The researcher also encouraged Jim to make observations about individual students:

R: Are there any concerns with individuals – that you don’t think you cater for?

J: Um, I think there’s 2 or 3 real weakies ... that was probably above them – out of their reach um, so I mean from time to time, what I should be doing is taking them back to the simple division and those processes and going right back yeah, but as I say, in small groups that can happen – but no, I think I cater for those kids that are up there and there’s extension and teach the middle and try and bring them up – so I hope I’ve got them covered – but I know it’s different from somebody on the outside looking in.

In summary, the video footage provided a mechanism for deliberate reflection (Muir & Beswick, 2007) to occur in that Jim and/or the researcher identified ‘critical incidents’ and an explanation or rationale was offered. Jim also reflected critically, when he stated that the whole group discussion was limited to a few participants and offered an alternative approach. Jim was primarily critical about his demonstrated lack of knowledge in regard to using the correct terminology, providing the opportunity for more students to participate actively in the discussion and maintaining a focus on conceptual understanding. The following description of the second lesson observed for Jim and his subsequent reflective comments illustrate how he changed his teaching approach in the next week to address the concerns he raised.

Lesson Two Observation and Reflection

The second lesson observed for Jim represented a distinct contrast to the one observed the previous week. As before, students were seated on the floor in front of the whiteboard, but Jim began the lesson by introducing students to a scenario that had the effect of totally engaging and motivating the students as the following excerpt illustrates:

Now I have a little problem that I want you to help me with. The parents and friends association are on my back – they’re nasty, nasty people – and I know some of your parents are involved in it – but they’re still on my back – and they want to know what this class is going to do for the fair in November – and I have an idea and hopefully it’ll get the parents and friends off my back so this is the idea that I’ve got. The idea is that we move out all the bookshelves and desks out of the classroom – we move them all out and we seal off the computer room and we fill the classroom right up to the top with jelly.

Jim’s goal for the lesson was for students to develop an understanding of the concept of volume, but rather than adopt a didactic approach as he did in the first lesson, he instead presented the scenario and invited students to investigate how they would work out how much jelly would be required to fill the classroom. The children were immediately captivated by the task and enthusiastic about working in small groups to formulate a plan to carry out their investigation, including finding the volume of the classroom (although the term ‘volume’ was not actually used). The lesson concluded with the groups sharing some of their preliminary findings with the whole class.

Jim was quite critical of what occurred in last week’s lesson and his initial comments revealed that he further reflected on this lesson following the first SCR session:

Well I wasn’t happy with last week’s performance, um, and I wanted something I guess to build my confidence, and just having a look through the elements of effectiveness, I just thought that one of the areas that I wanted to develop in was getting the kids trying to explain ... their responses through the investigation um, and I know that’s where you’re coming from and we should have these open investigations and um, I just thought I’d give that a go, because it’s not probably how I would normally operate and I’m trying to I guess improve my effectiveness as a teacher so I’m looking for ways to develop ... I was depressed after last week - no but it’s good because I got to see how I interact with the kids, ... and I wasn’t happy with it and I just thought what sort of rubbish am I handing out to these kids? But at the same time, at the end of the year, they’re still achieving, they’re still getting results, but I think that we can do that in better ways ... I thought it was – seeing it – if I was sitting there and watching a teacher teach that, I would have thought oh gees, and there were a few times, like lemon juice in a wound, sort of thing [cringes] ... I think that as a professional, working through that and seeing areas of deficiency and trying to work on them is really important, so that’s where I’m coming from at the moment

The above comments demonstrate critical reflection and indicate that watching the video footage was a significant stimulus in enabling Jim to view his teaching objectively. Furthermore, he implies that in the past he tended to evaluate his teaching effectiveness on ‘getting results’ and that were other elements that should be considered:

I thought I was reasonably good at teaching maths and yeah, looking back the results are there of the kids’ achievement but as I said there are different ways to go about it and perhaps, instead of the chalk and talk, the um, getting the kids to come at the answers probably gets more meaning behind it

As previously mentioned, Jim’s approach to his second lesson was a stark contrast to the first one observed and was more in line with mathematical reform practices, such as teaching for understanding, with an emphasis on thinking and problem solving. This was a deliberate decision on Jim’s behalf as the following comment shows:

... having the materials there for them to work with, having the concrete aids, which were one of the other things there [referring to effective characteristics] which you know, I think I said last week, I tend not to use the concrete aids as much – it’s been more number sort of oriented, it’s been grade 5/6 – that sort of thing – which I want to change because um, I think I was just lazy in the class, because I don’t believe it.

Jim also indicated that while he perceived volume to be “easier than number to investigate”, he anticipated that “by seeing how far I can come along here will change my

other teaching, whereas division is probably more difficult to teach that way". Jim also indicated in this session that he had "gone away and read up on" mathematical concepts such as volume in order to address the lack of mathematical content knowledge that he felt occurred in the previous week's lesson.

Summary

Jim's reaction to the initial video footage and the subsequent viewing sessions showed that like Rosaen et al. (2008), he found it to be a powerful medium in revealing aspects of his practice that he had not previously considered. During the course of the study the video footage enabled him to gain a realistic picture of the experiences he was offering to the students and he regularly deliberately reflected on his mathematics lessons and made appropriate changes in subsequent lessons. In a post-study interview conducted a month after the observations ceased, Jim acknowledged that the video footage was instrumental in enabling him to reflect and change aspects of his practice:

Well for me I mean I was forced to reflect because I was sitting there looking at it, thinking oh my God this is you know, this has to change, and now you know when I'm teaching it's in the back of my mind, it's oh, what if [researcher] was here watching this, would this be what I want to see on the video ... and I'm thinking is this a teachable moment or is this something that we can come back to later, and if it's detracting from what we're focusing on, so I'm thinking about those sorts of things.

Jim's reference to the researcher also acknowledges the role of the 'significant other' and supports the findings from other researchers (e.g., Clarke, 1997; Davies & Walker, 2005; Day, 1998) that this role is crucial in encouraging critical reflection. Not unlike the teacher in Olsen and Kirtley's (2005) study, Jim was motivated to change after he experienced the teaching of mathematics in a new way and identified that this was beneficial to the students. Similarly, he acknowledged that his lack of mathematical knowledge in some areas was of a concern and needed to be addressed.

In summary then, while acknowledging that the results discussed here represent the case of only one teacher, they do indicate that for the duration of the study at least, and in the presence of the researcher, Jim did adapt his mathematical practice to be more aligned with mathematical reform recommendations, including an increased emphasis on teaching for conceptual understanding. Furthermore, his comments throughout the reflective viewing sessions and in a follow-up interview validate the influence of the video footage on bringing about these changes. It is hoped that the case reported here will encourage other researchers to engage in similar personalised professional learning opportunities and document their experiences accordingly.

References

- Bobis, J. & Whitton, D. (1999). *Count me in too 1998 report*. Sydney: NSW Department of Education & Training.
- Carroll, J. (2005). Developing effective teachers of mathematics: Factors contributing to development in mathematics education for primary school teachers. In P. Clarkson, A. Downton, D. Gronn, M. Horne, A. McDonough, R. Pierce & A. Roche (Eds.), *Building connections: Research, theory and practice* (Proceedings of the 28th annual conference of the Mathematics Education Research Group of Australasia pp. 201-208). Sydney: MERGA.
- Clarke, D. M. (1997). The changing role of the mathematics teacher. *Journal for Research in Mathematics Education*, 28(3), 278-301.

- Clarke, D., Sullivan, P., Cheeseman, J., & Clarke, B. (2000). The early numeracy research project: Developing a framework for describing early number learning. In J. Bana & A. Chapman (Eds.), *Mathematics education beyond 2000* (Proceedings of the 23rd annual conference of the Mathematics Education Research Group of Australasia pp. 180-187). Perth, WA: MERGA.
- Davies, N., & Walker, K. (2005). *Learning to notice: One aspect of teachers' content knowledge in the numeracy classroom*. In P. Clarkson, A. Downton, D. Gronn, M. Horne, A. McDonough, R. Pierce & A. Roche (Eds.), *Building connections: Research, theory and practice* (Proceedings of the 28th annual conference of the Mathematics Education Research Group of Australasia pp. 273-280). Sydney: MERGA.
- Day, C. (1998). Working with the different selves of teachers: Beyond comfortable collaboration. *Educational Action Research*, 6(2), 255-275.
- Geiger, V. & Goos, M. (2006). Living in the gap: A tale of two different types of researchers. In P. Grootenboer, R. Zevenbergen & M. Chinnappan (Eds.), *Identities, cultures and learning spaces* (Proceedings of the 29th annual conference of the Mathematics Education Research Group of Australasia pp. 254-261). Adelaide, SA: MERGA.
- Hargreaves, A., & Fullan, M. (1992). *Understanding teacher development*. New York: Teachers College Press.
- Hennessy, S., & Deaney, R. (2009). "Intermediate Theory" Building: Integrating multiple teacher and researcher perspectives through in-depth video analysis of pedagogic strategies. *Teachers College Record*, 111(7), 1753-1795.
- Hopkins, D. (1993). *A teacher's guide to classroom research (2nd Ed.)*. London: Open University Press.
- Lovitt, C. & Clarke, D. (1988). *Mathematics curriculum and teaching program (MCTP) Activity bank volume 1*. Canberra: Curriculum Development Centre.
- Miles, M. & Huberman, A. M. (1984). *Qualitative data analysis: A sourcebook of new methods*. Newberry Park, CA: Sage Publications.
- Muir, T. (2008). "Zero is not a number": Teachable moments and their role in effective teaching of numeracy. In M. Goos, R. Brown & K. Makar (Eds.), *Navigating currents and charting directions* (Proceedings of the 31st annual conference of the Mathematics Education Research Group of Australasia, Brisbane, pp. 361-367). Adelaide, SA: MERGA.
- Muir, T., & Beswick, K. (2007). Stimulating reflection on practice: Using the supportive classroom reflection process. *Mathematics Teacher Education and Development*, 8(Special issue), 74-93.
- NCTM, (2000). *Principles and standards for school mathematics*. Reston, VA: NCTM.
- Olsen, J. C. & Kirtley, K. (2005). The transition of a secondary mathematics teacher: From a reform listener to a believer. In H. L. Chick & J. L. Vincent (Eds.), *Proceedings of the 29th conference of the International Group for the Psychology of Mathematics Education* (pp. 25-32). Melbourne: PME.
- Powell, E. (2005). Conceptualising and facilitating active learning: teachers' video-stimulated reflective dialogues. *Reflective Practice*, 6(3), 407-418.
- Reys, R. (2002). *Reform math education*. Retrieved 19 January 2010 from <http://www.csmonitor.com/2002/1115/p09s01-coopo.html>
- Rosaen, C. L., Lundeberg, M., Cooper, M., Fritzen, A., & Terpstra, M. (2008). Noticing noticing. *Journal of Teacher Education*, 59(4), 347-360.
- Tanner, H. & Jones, S. (2007). Learning from children about their learning with and without ICT using video-stimulated reflective dialogue. In J. Watson & K. Beswick (Eds.), *Essential research: Essential practice* (Proceedings of the 30th annual conference of the Mathematical Education Research Group of Australasia, pp. 708-716). Adelaide, SA: MERGA.

Partial Metacognitive Blindness in Collaborative Problem Solving

Kit Ee Dawn Ng
National Institute of Education
Nanyang Technological University
<dawn.ng@nie.edu.sg>

This paper investigates the impact of group dynamics on metacognitive behaviours of students (aged 13-14) during group collaborative problem solving attempts involving a design-based real-world applications project. It was discovered that group dynamics mediated the impact of metacognitive judgments related red flag situations and metacognitive failures. The existence of partial metacognitive blindness was also discovered and two contrasting phenomena could result from this because of differing group dynamics.

There has always been sustained interest in investigating factors influencing problem solving success (e.g., Ang, 2009; Chan & Mansoor, 2007; Garofalo & Lester, 1985; Schoenfeld, 1985; Scott, 1994; Stillman, 2004). Researchers have also been looking into group collaborative processes which facilitate and impede problem solving success (e.g., Artzt & Armour-Thomas, 1990, 1992; Goos, 1997, 2002; Lioe, Ho, & Hedberg, 2005). This paper discusses the role of metacognition in group problem solving during a design-based mathematical applications project based on a larger study conducted with lower secondary students (aged 13-14) at three Singapore government schools. In particular, the impact of group dynamics on *metacognitive blindness*, a concept developed by Goos' (1997, 2002), which affects the quality of mathematical outcomes during collaborative problem solving will be examined. For a more in-depth understanding of partial metacognitive blindness, a brief review of pertinent literature is presented here.

This study adopts Flavell's (1976) definition of metacognition which highlights two inter-related components, metacognitive knowledge and metacognitive regulation:

Metacognition refers to one's knowledge concerning one's own cognitive processes and products or anything related to them...Metacognition refers, among other things, to the active monitoring and consequent regulation and orchestration of these processes in relation to the cognitive objects or data on which they bear, usually in the service of some concrete goal or objective. (p. 232)

Metacognitive knowledge is about *awareness* of how factors (i.e., person, task, and strategy) act and interact to influence the outcome of a thinking process (Flavell, 1981) such as decision making. Metacognitive regulation is concerned with the use of *control* processes (e.g., monitoring, selection, and management) for instance during a problem solving experience. In real-life, it is a challenge documenting the use of metacognitive knowledge and regulation processes, particularly in the midst of small group interactions influenced by group dynamics. Hence, this study has attempted to identify only *overt behaviours* which could be indicative of intra- or inter-personal metacognitive monitoring and regulation. Although metacognitive monitoring behaviours may at times lead to subsequent regulatory actions, it may often be the case that one is observed without the other.

However, as much as the presence of metacognitive behaviours is crucial for favourable problem solving outcomes (Schoenfeld, 1985), researchers have found that the quality of the nature of metacognitive interactions (Stillman & Galbraith, 1998) is just as important. Goos (1997, 2002) identified three *red flag* situations in her study of group collaborative problem solving process: (a) lack of progress, (b) error detection, and



(c) anomalous or strange results. According to Goos, red flag situations are distinguished from routine monitoring behaviours (e.g., assessment of knowledge, approach, outcomes) which served to confirm that the problem solving process is on the right track. Metacognitive red flags can occur at critical junctures where the problem solvers are faced with important decision making pertaining to the success or failure of their attempts. Thus, purposeful, conscious, and at times drastic actions (e.g., pausing for reflection, backtracking, re-doing the problem in another way) may be warranted to change problem solving pathways.

Nonetheless, subsequent metacognitive regulatory behaviours (or the lack of them) in reaction to red flag situations also play a large role in savaging or sabotaging the problem solving situation. Goos (2002) identified three types of *metacognitive failures* displayed by problem solvers in reaction to red flags. These are described by the metaphors of “blindness”, “vandalism”, and “mirage”. Metacognitive blindness occurs when a problem solver did not notice his or her likelihood of impending failure in solving the problem, opting for instance to continue with an inappropriate approach. Metacognitive vandalism comes into play when problem solvers decide to take destructive action to deal with a deadlock situation (e.g., changing the conditions of the problem so as to suit the fixed mindset of the problem solver). Metacognitive mirage takes place when problem solvers mistakenly change course of actions upon perception of difficulties which in fact do not exist.

Metacognitive judgements for appropriate regulatory behaviours as well as metacognitive failures in reaction to red flag situations are recognised by this researcher to be crucial to the success of group collaborative problem solving. These are often mediated by existing group dynamics. Given the focus on metacognition in the Singaporean mathematics curriculum framework (Curriculum Planning and Development Division, 2006), there are still limited studies to date within the Singaporean context investigating the impact of group dynamics on metacognitive failures, specifically, that of metacognitive blindness. This impact in turn will have a bearing on the quality of mathematical outcomes during collaborative problem solving. In one such study on primary school students (aged 12), Chan and Mansoor (2007) discovered that inter-personal regulation of thinking during collaborative problem solving raised the level of metacognitive thinking such that group members are more impervious to metacognitive failures. However, there was no analysis of the nature of red flag situations and likely metacognitive failures from their sample. Very little was mentioned about the nature of group dynamics and how this has affected the groups’ metacognitive judgements, and hence the quality of their mathematical products from their problem solving attempts.

Research Questions

Findings to the following two research questions will be presented in this paper:

- How is metacognitive blindness manifested during collaborative problem solving in a design-based applications project?
- In what ways do group dynamics impact on metacognitive blindness during collaborative problem solving?

Research Design

Research Task

A design-based applications project primarily involving mathematics, science, and geography was implemented in 16 classes of students ($n = 617$) from grades 7 and 8 (aged 13-14) in two educational streams (high and average) across three Singapore government secondary schools. The project followed the theme of environmental conservation and was completed through 15 weekly meeting sessions. Students worked in groups of four to design an environmentally friendly building at a location of their choice within Singapore (Figure 1). Each group was given some project-related tasks (e.g., research on available land space) during the meeting sessions to help them work towards their building design. Supporting materials developed by the researcher according to the guidelines set by Singapore Ministry of Education were used for some of these sessions. In particular, two student-group case studies (Groups 1 and 2) based on their selected participation in two mathematical tasks with written components will be reported in this paper: (a) cost of furnishing and fitting out a selected area in the building (i.e., flooring, painting, appliances, and furniture) and (b) hand-drawn scale drawings of the actual building. Towards the end of the project, student-groups constructed physical scale models of their buildings from recycled materials based on their drawings.

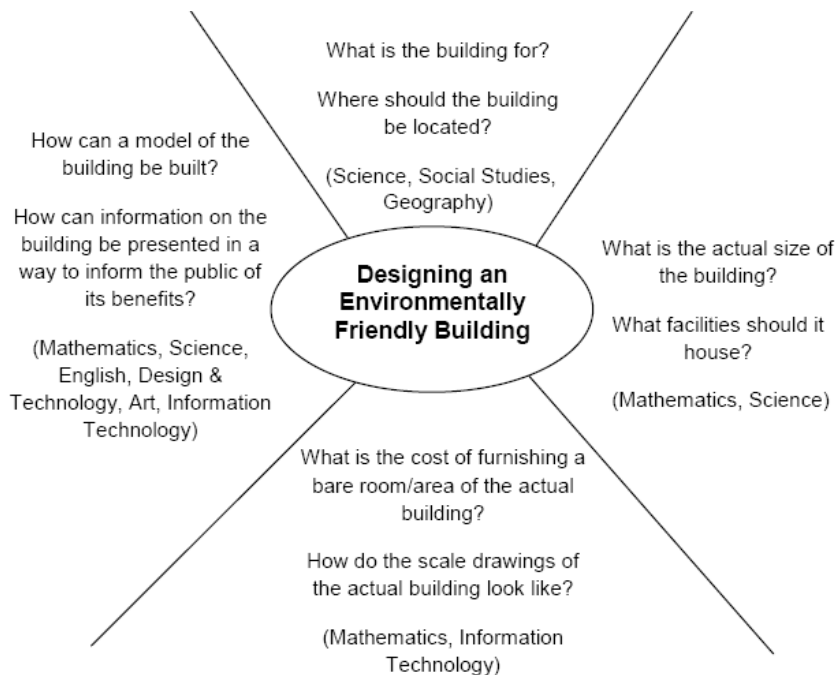

Figure 1. Framework of researcher-designed project.

Setting and Sample

Student participation during the study was facilitated using the project-based approach (Quek, Divaharan, Liu, Peer, Williams, & Wong, 2006). There were no special instructions for teaching intervention. Participating classes had at least one teacher with mathematics, science, geography, and design and technology specialisation facilitating each meeting session. The teachers used their usual facilitation methods and they could reorganise the

sequence of the proposed materials and adapt the provided resources, except for the stated tasks (a) and (b) above.

The researcher tracked the progress of ten case-study groups ($n = 38$, two students excluded due to technical difficulties) throughout the project in their weekly discussion sessions during curriculum time. These included five groups in each stream with the maximum of one group from a class. Students formed their own groups and each group consisted of students with mixed-ability in mathematics.

Data Collection Methods

A multi-site multi-case-based approach (Yin, 2009) was adopted in data collection and analysis. Documentary (i.e., copies of students' work, field notes), audio-visual (i.e., video-generated data), and verbal evidence (i.e., interview-generated data) were collected.

Each of the ten groups was videotaped during their in-class discussions on (a) and (b) above. Individual group members also participated in video-stimulated recall interviews within one week of their discussions. In addition, written work from the groups (i.e., notes, research materials, resources, drafts, drawings, and task sheets), project files, and final products of the project were collected for analysis along with their teachers' comments and grades. The researcher took lesson observation notes focusing on given instructions and the nature of teacher scaffolding as well.

Analysis Procedures

Audio-visual evidence was the main source of data for analysis for the purposes of this paper. Documentary and verbal evidences were used to triangulate findings. Student-group interactions on the tasks (a) and (b) above were coded using a cognitive-metacognitive analysis framework adapted from Schoenfeld (1985), Goos (2002), and Artzt and Armour-Thomas (1992). However, only the results derived from coding of various red flag situations (i.e., lack of progress, error detection, strange results) and instances of metacognitive failures (i.e., blindness, vandalism, mirage) will be reported here.

Findings

In an extension of Goos' research (1997, 2002), it was discovered in this study that *partial metacognitive blindness* exists in group collaborative problem solving process. Partial metacognitive blindness occurs when a red flag situation was detected and possibly surfaced by at least one member of the group (i.e., red flag alert raised) while others were blind to it. This is compared with *total metacognitive blindness* where a red flag situation was completely missed by all group members.

Interestingly, both positive and negative problem solving outcomes could arise from the effects of partial metacognitive blindness. A desirable mathematical outcome may occur when appropriate and immediate regulatory actions were adopted by group members who detected a red flag situation even though others were blind to it. On the other hand, metacognitive vandalism, where inappropriate regulatory actions were manifested by any group member against the expectations of others within the group, could drastically alter the course of action towards problem solving failure or nonsensical solutions.

Partial Metacognitive Blindness, Productive Group Dynamics, and Improved Mathematical Outcomes

Table 1 details the occurrences of partial metacognitive blindness in Group 1. For this group, desirable mathematical outcomes resulted due to timely and appropriate regulatory actions by members of the group in reaction to partial metacognitive blindness of one member. {} brackets represent translated verbal interactions in Standard English. [] brackets record gestures or physical actions undertaken by group members.

Table 1
Excerpt from Group 1 Detailing Partial Metacognitive Blindness During Scale Drawing Task

Speaker	Line	Contents
Sani:	1	1 is to 1 your scale? 1 is to 1 is to 5?
	2	{So what do you mean? Is the scale you forgot 1 cm representing 1 metre or 1 cm
	3	representing 5 metres?}
Choon:	4	[Checking possibility of a guess, also beginning to ask a series of questions in an
	5	attempt to detect possible mistakes in logic.] Then square metre....how many
	6	square metre?
		{What is the area of the building in square metres then?}
Fanny:	7	[Guessing, cannot remember] 1 is to....err...
Choon:	8	You mean {the} model... {Do you mean the scale for the physical scale model for
	9	our building? But this doesn't make sense.}
Fanny:	10	[Guessing again.] 1 cubic metre... (Red Flag – Error in Mathematical Concept)
Choon:	11	[Mistake detected.] You mean 1 cm ³ equals to 5 square metre?(Red Flag Alert)
Fanny:	12	[Referring to a guessed scale for the actual building that they have decided to make
	13	their drawings based on. Fanny was confused with the units of area and volume
	14	used.]
	15	Why not? Why 1 cm ³ cannot be {cannot represent} 5 square metres?
		(Metacognitive Blindness)
Choon:	16	[Questioning Fanny about her mathematics understanding]
	17	5 square metres? 5 square metres? {Are you sure 1 cm ³ equals 5 m ² ?} (Red Flag Alert)
Fanny:	18	{Do you mean} 5 {m} by 5 {m} by 5 {m}?(Metacognitive Blindness)
Choon:	19	5 square metre{s} is not 5 {m} by 5 {m} by 5 {m}... (Regulatory Action – Correcting Misconception to Change Approach in Scale)
Kit:	20	[Agreeing with Choon.] {5 square metres is} 5 {m} by 5 {m}!

Group 1 was in the middle of discussing the appropriateness of the scales chosen to make their scale drawings of the building. Choon, the dominant group member who was also the leader of the group, “interrogated” Fanny intensively (lines 11 and 17) and provided red flag alerts to help her realise her confusion between area and volume (lines 10, 14, and 18). The group members were trying to remember the scale they had decided upon earlier for the drawings representing their environmentally friendly shopping centre. Fanny, the recorder for the group, did not bring her notes from an earlier discussion. Sani and Choon were prompting her to remember what she had recorded. Instead, Fanny made guesses about the chosen scale revealing her metacognitive blindness and confusion about the mathematical concepts of area and volume.

Table 2

Excerpt from Group 2 during cost of furnishing task

Speaker	Line	Contents
Ken:	1	[In Mandarin.] The most we budget our toilet furnishings as one million dollars!
	2	
Alan:	3	Hey... {\$} 5000...5000...
Ken:	4	No...not enough...
Alan:	5	{\$}5000 enough already...
Ethan:	6	{\$}10,000! {\$}10,000! (Red Flag – Error in Logic)
Alan:	7	[To Ethan, exclaiming in horror.] The bathroom \$10,000! {\$}5000, that's already
	8	too much for furnishing the bathroom! (Red Flag Alert)
Ken:	9	Here put in one more zero can already [Adds in one more zero to the original
	10	budget of \$1000 on the worksheet, making it \$10,000.] (Metacognitive Blindness, Metacognitive Vandalism)
Alan:	11	[To Ethan, in Mandarin.] This is only a bathtub, are you sure it cost{s} so much to
	12	furnish it?! We only use a little of it everyday! (Red Flag Alert)
Ken:	13	[Shouting at Alan, irritated.] Shut up! [Decided on the cost of bathtub on behalf of
		the group.] (Metacognitive Blindness)
Alan:	14	[To Ken.] I give opinion... you ask me to shut up... so I shut up loh! [Angry at
	15	Ken's outburst towards him, decides to keep quiet for the rest of the time]
Ethan:	16	[Pointing to Alan and Ken.] You two shut up!
Ken:	17	[To Ethan and Alan.] How long you want? {What are the dimensions of the toilet?}
Alan:	18	[Refused to answer Ken.]
Rean:	19	[Looks on, keeping quiet.] (Red Flag Situation Ignored Deliberately)
Ken:	20	[Mumbling to himself, calculating the area of the toilet floor.] 30 time{s} 30 is 900
		{m ² } (Metacognitive Blindness)
Ethan & Alan:	21	[Look away, staring outside the classroom.]
Ken:	22	[Continues to mumble to himself.] One thousand...
Ken:	23	[To Ethan and Alan, commenting on the total cost of furnishing after calculations.]
	24	Wow! This is already over our budget! (Red Flag – Anomalous Result) (Red Flag
	25	Alert)
Ethan & Alan:	26	[No comments.]
Ethan:	27	[In Mandarin.] Add in one more “zero” and make it \$100,000 as the furnishing
	28	budget... (Metacognitive Blindness, Metacognitive Vandalism)
Alan:	29	[In Mandarin.] Skip the bathtub! {Do not include the bathtub in the toilet!}...this is
	30	a toilet. (Red Flag Alert)
Ken:	31	Okay...add in two “zeros”... {He changes the budget to \$1,000,000.}
		(Metacognitive Blindness, Metacognitive Vandalism)
Alan:	32	This is a toilet...your school toilet don't have bathtub! {I am reminding you that we
	33	are actually estimating the cost of furnishing a toilet at our school and so the budget
	34	for furnishing costs need not be so high.] (Red Flag Alert)
Ken:	35	[Shouting, for the sake of winning the argument for having \$1,000,000 as the
	36	budget.] Hey...toilet in the hotel lah! (Metacognitive Blindness)
Alan:	37	[Disagrees with CB, shaking his head.] What hotel?!

It was apparent from the excerpt in Table 1 that Choon had large social influence with the group. Choon directed questions (lines 8, 11, and 17) towards Fanny in an authoritative tone and consequently tried to present her with the correct mathematical concept (line 19). Here, Choon's timely and appropriate monitoring and regulatory actions respected by others managed to redirect the subsequent flow of cognitive-metacognitive interactions towards a more accurate scale representation, thereby altering the work outcome positively.

Partial Metacognitive Blindness, Counter-Productive Group Dynamics and Negative Mathematical Outcomes

In contrast, Table 2 shows an excerpt from Group 2, outlining how metacognitive vandalism occurred after partial metacognitive blindness, negatively affecting the quality of mathematical outcome from the problem solving process.

The group was trying to come to a consensus about the budget they would set aside for furnishing a toilet in their environmentally friendly school. Alan and Ethan reviewed the feasibility of Ken's ideas and raised red flag alerts (lines 6, 7 to 8, 11 to 12) at appropriate junctures. However, Ken, a loud dominant member of the group, exhibited an inappropriate regulatory behaviour when he rudely terminated the exploration approach in order to halt his peers' critique of his ideas (line 13). This resulted in others being unwilling to contribute further to the discussion (lines 18 to 19, 21, 26). With no one in the group allowed to check his work, Ken continued to exhibit metacognitive blindness towards red flag situations of error in logic (line 20) until he himself raised a red flag pertaining to anomalous result (line 25). However, the existing group dynamics was so counter-productive that Ken still persisted in being metacognitively blind to his unrealistic estimations of the budget (lines 31 to 36), spurred on by the erroneous misconceptions of Ethan (lines 27 to 28).

In this group Ken controlled the flow of interactions through his choice of whether to give due recognition to the red flag alerts of others and corresponding regulatory actions. Ken's choice was affected by his attitude towards the other group members and his desired quality of work to be produced. Either way, there was a large impact brought upon the group's interactions, resulting in poor work quality.

Discussion and Conclusion

It was discovered that group dynamics mediated the impact of metacognitive judgments related red flag situations and metacognitive failures. In an extension of Goos' study (1997, 2002), this author recorded the existence of partial metacognitive blindness during group collaborative problem solving. Partial metacognitive blindness when mediated by productive group dynamics can lead to an improvement in mathematical outcomes of the problem solving process (see Table 1). On the other hand, partial metacognitive blindness when mediated by counter-productive group dynamics may well result in less-than-desirable mathematical outcomes and could be detrimental to the subsequent problem solving attempts by the same group (see Table 2).

In addition, it was also discovered that dominant members in the group played a large role in controlling group dynamics. When red flag alerts were raised, these dominant members very often served as "gate-keepers", making conscious choices to either allow for metacognitive blindness to continue or stepping in to divert the flow of interactions towards positive results. Hence, intervention programmes targeted at elevating the

mathematical outcomes of group collaborative problem solving within the context of the Singaporean school system may well begin with cultivating good social behaviours during group work such that fruitful mathematical discussions can arise when group members are respected for their views.

References

- Ang, K. C. (2009). Mathematical modelling and real-life problem solving. In B. Kaur, B. H. Yeap & M. Kapur (Eds.), *Mathematical problem solving: Yearbook 2009* (pp. 159-182). Singapore: Association of Mathematics Educators.
- Artzt, A. F., & Armour-Thomas, E. (1990, April 16-20). *Protocol analysis of group problem solving in mathematics: A cognitive-metacognitive framework for assessment*. Paper presented at the Annual meeting of the American Educational Research Association, Boston, MA.
- Artzt, A. F., & Armour-Thomas, E. (1992). Development of a cognitive-metacognitive framework for protocol analysis of mathematical problem solving in small groups. *Cognition and Instruction*, 9(2), 137-175.
- Chan, C. M. E., & Mansoor, N. (2007). *Metacognitive behaviours of primary 6 students in mathematical problem solving in a problem-based learning setting*. Paper presented at the redesigning pedagogy, culture, knowledge, and understanding: Centre for Pedagogy and Practice Conference National Institute of Education, Singapore.
- Curriculum Planning and Development Division [CPDD]. (2006). *Mathematics Syllabus*. Singapore, Ministry of Education: Author.
- Flavell, J. H. (1976). Metacognitive aspects of problem solving. In L. B. Resnick (Ed.), *The nature of intelligence* (pp. 231-235). Hillsdale, NJ: Lawrence Erlbaum.
- Flavell, J. H. (1981). Monitoring social cognitive enterprises: Something else that may develop in the area of social cognition. In J. H. Flavell & L. Ross (Eds.), *Social cognitive development* (pp. 272-287). New York: Cambridge University Press.
- Garofalo, J., & Lester Jr, F. K. (1985). Metacognition, cognitive monitoring and mathematical performance. *Journal for Research in Mathematics Education*, 16(3), 163-176.
- Goos, M. (1997). *Self-directed and peer-assisted thinking in a secondary mathematics classroom* [Electronic Version]. Annual conference of the Australian Association for Research in Education, Nov30-Dec4. Retrieved July 30, from <http://www.aare.edu.au/97pap/goosm264.htm>
- Goos, M. (2002). Understanding metacognitive failure. *Journal of Mathematical Behavior*, 21(3), 283-302.
- Lioe, L. T., Ho, K. F., & Hedberg, J. G. (2005). *Thinker-Listener pair interactions to develop students' metacognitive strategies for mathematical problem solving*. Paper presented at the ICMI Regional Conference: The Third East Asia Regional Conference on Mathematics Education.
- Quek, C. L., Divaharan, S., Liu, W. C., Peer, J., Williams, M. D., Wong, A. F. L., et al. (2006). *Engaging in project work*. Singapore: McGraw Hill.
- Schoenfeld, A. H. (1985). *Mathematical problem solving*. Orlando, FL: Academic.
- Scott, N. (1994). Profiles of some non-routine problem solving episodes. In G. Bell, D. Wright, N. Leeson & J. Geake (Eds.), *Challenges in mathematics education - constraints on construction: Proceedings of the seventeenth annual conference of the Mathematics Education Research Group of Australasia* (Vol. 2, pp. 531-538). Lismore: MERGA.
- Stillman, G. (2004). Strategies employed by upper secondary students for overcoming or exploiting conditions affecting accessibility of applications tasks. *Mathematics Education Research Journal*, 16(1), 41-70.
- Stillman, G. A., & Galbraith, P. L. (1998). Applying mathematics with real world connections: Metacognitive characteristics of secondary students. *Educational Studies in Mathematics*, 36(2), 157-194.
- Strauss, A., & Corbin, J. (1998). *Basics of qualitative research: Techniques and procedures for developing grounded theory*. Thousand Oaks, CA: Sage.
- Yin, R. K. (2009). *Case study research: Design and methods* (4th ed.). Thousand Oaks, CA: Sage.

Changing our Perspective on Space: Place Mathematics as a Human Endeavour

Kay Owens

Charles Sturt University

<kowens@csu.edu.au>

This paper collates some of the systematic ways that different cultural groups refer to space. In some cases, space is more strongly identified in terms of place than in school Indo-European mathematics approaches. The affinity to place does not reduce the efficient, abstract, mathematical system behind the reference but it does strengthen its connection to the real world of place. This review of research uses a critical approach to develop an ecocultural perspective on spatial referencing. It refers to studies on the Polynesian Wayfinders; the Garma project at Yirrakala in the Northern Territory of Australia identifying Yolgnu sense of position; original field data mainly from Papua New Guinea; and on the work of linguists who have recorded and analysed the ancient languages of the Pacific region. The paper provides the mathematics educator with a richer perspective on position and a way of understanding the thinking of students with language and cultural backgrounds other than English. The Indigenous languages of Australia form a basis for ways of thinking spatially for specific groups of Indigenous students.

For many years the strand of space and geometry has begun with a focus on language. Early childhood experiences emphasise the use of prepositions like “in”, “on”, “inside” and words like “left” and “right”. This is followed with giving position in space in terms of orthogonal dimensions with an origin from which to mark off segments or to delineate points. Location is usually considered in terms of an orthogonal coordinate system (Uttal, Fisher, & Taylor, 2006, p. 2). Students may begin with locating on one dimension before using two and three orthogonal dimensions. The use of x and y axes numbered from zero with positive integers are later developed for positions described in terms of negative to positive numbers. This system is a basis for the visual representations of algebraic relationships.

The early prepositional world of identifying place (e.g., on the table in the house) and referring to constructions with blocks is followed by mapping familiar places. In primary schools mapping tends to move from more pictorial representations with some indication of direction to those showing relative lengths and greater accuracy in terms of angles formed by intersecting lines representing roads or paths (Owens, 2000; Owens & Geoghegan, 1998). Mapping is introduced as a plan view, but there may be few links to maps used everyday or to those with contour lines. Furthermore, the way places are described and represented in big space using landmarks is generally not linked to descriptions of spaces that can be within a person’s immediate space such as on a piece of paper or in a room.

The use of polar coordinates referencing by direction (e.g., an angle from north) and distance from the reference point is often left to higher school levels. The use of direction by turning through an angle and moving a certain distance was central to LOGO geometry and this geometry has returned to early childhood education with the availability of programmable toys (Highfield, Mulligan, & Hedberg, 2008).

However, what school systems currently fail to realise is the diversity of ways in which location in space can be described systematically by different cultural groups. One way of exploring this is through language.



Methodology

This study consists primarily of a literature review of the ways that different people refer to a place or position in space. It draws mostly on linguistic data presented in original research papers but also in some secondary sources (e.g., Tuan, 1977; Worsley, 1997). In addition, the study draws upon original data obtained by both semi-structured interviews and story telling by people who speak one of the 800 languages in Papua New Guinea (PNG). The critical approach taken in this review is based on an ecocultural perspective that considers place when referencing space. The spatial references relate to people's place, cultural activities, and language. Much of the data comes from Indigenous communities whose relationships with place ensure spatial referencing is closely linked to their holistic world view.

There are many different Indigenous groups within Australia. Elders are the knowledge keepers and respected people of the community. Indigenous people identify with their language group and continue their cultural knowledge as best they can despite the varying degrees of loss due to poor colonising practices. For example, people use song-lines to maintain the connection with the route that is taken when traversing their land. The Galma study comes from the Yolgnu people at Yirrakala who have two clans, the Yirritja and Dhuwa.

The languages of the Pacific especially those of PNG are central to this study. The early waves of languages of PNG are grouped together as Papuan although there are several quite distinct Families and Isolates. Oral and recorded data were obtained on the following languages: Abau, in the Sandaun Province in the west of the mainland; Alekano in the Eastern Highlands Province; and Yupno in the Madang Province towards the east. Later migrations of people to PNG have resulted in languages classified as Austronesian. Kilivila, an Oceanic variant, is spoken by people who live on the Trobriand Islands in the far south east of PNG. Oral data also comes from an Australian language, Wiradjuri (in New South Wales), which is being revived.

Central to traversing space and linking places is navigation, a mathematical activity. Studies that form a basis for the discussion in this paper are by Akerblom (1968) on the Caroline, Marshall, and Gilbert Islands; Lewis (1973) on the Caroline Islands; Bryan (1938), Davenport (1960), and Spennemann (1998) on the Marshall Islands; as well as Davis (2010), Worsley (1997), and the University of Pennsylvania Museum (1997) whose website provides dynamic images to assist understanding.

Results

Issues Related to Spatial Reference Systems

In western mathematics, position is generally referred to in terms of two orthogonal dimensions with the speaker at the centre. The spatial frame denoted by the directions—north, south, east, and west—was also common across Asia and Africa but not elsewhere. However, this static frame was an issue by the 6th century BC for the Greeks viewing the world as a sphere, so they divided the heavens into zones and the earth into five latitudinal zones.

Reference to space that is far distant is problematic. Saukteaux Indians of Manitoba know of distant landmarks referred to by the points determined by the course of the North Star, the sun, and the home of the four winds (Tuan, 1977). Pacific navigators divide the plane of the earth into roughly 32 equal parts by marking the rising and setting of star constellations. The Australian and PNG Indigenous peoples know of trading partners far

away, and in some cases, dance routines represent the directions of these places. Even European folklore linked people to their environment; for example, the north were hardy, the south easygoing (Tuan, 1977).

Space as Place

One reason for the diversity of spatial frames of reference is the connection between the space and the holistic view of people's lives. The denoted space bears other connotations. For the Chinese the four sides of the rectangle were represented by animals. Ancient Greece used planetary gods – east connotes light, white, sky and up while west is darkness, earth and down. For the Pacific navigation there are star songs. For Europe zodiac star signs link with patterns of farm work like the coming of rain, breeding flock, harvest, mowing, raking (Tuan, 1977). Space is closely linked with time, and distance may be associated bodily with time taken to cover the distance. The time factor may also link to the stories of the past. For example, to walk a trek in Kaveve village (Eastern Highlands Province, PNG) will be to walk the story of the half-man who lived in that place. A community project in the Blue Mountains (on the outskirts of Sydney) involves maps, pathways and “song-lines” (Cameron, 2003). There are many such stories across PNG and Australia. Thus a place-based view of mathematics links position to the understanding of place and people's relationship with the place.

Space as place may have special personal or relational characteristics, and the spatial system may represent forces of nature and society. For the Yolgnu (Northern Territory, Australia) every person and every other thing is either Yirritja or Dhuwa. The division of land is dependent on the sacred sites with the nature of Yirritja or Dhuwa diminishing with distance so there are indistinguishable or grey areas too. (This referencing of space is not by an orthogonal grid.) The creation of the sites comes from the dreaming creatures who created the clans, are responsible for the sacred sites, and who maintain the power by observing appropriate ceremonies and through painting, dance and song (Thornton & Watson-Verran, 1996). “There is a metaphorical force essential for their way of life and sustaining their world” (Watson-Verran & Turnbull, 1995).

Kinship patterns and relational concepts are central to Yolgnu thought. A balance is achieved by using both Yirritja and Dhuwa knowledge for they have different knowledges. In discussing and drawing the various places, Larry (a clan Elder) represents the connectivity of the water flow, thus a line is not a Cartesian mapping but a topological mapping in western mathematical terms. However, such a description (topological mapping) does not present the fullness of the representation. Each place has connections with activities carried out by ancestors such as a place for camping when visiting, or a place for washing cycad nuts to remove poisonous chemicals. A walking track was Larry's responsibility and he would maintain it in song-lines, ceremonies and practices (Thornton & Watson-Verran, 1996).

The place where negotiations occur is roughly the shape of a stingray which buries its tail in the sand just as Larry and the ancestors before him buried their spears in the sand when negotiating a peaceful solution for revenge. Thus the shape and the place are metaphors and powerful images for complex ideas. Activity is set in kin relations, land rights and responsibilities, and sacred understandings. The land is constituted by living it. The conventions of the map representation are interpreted in terms of systematic relationships. The Yolgnu system of spatial knowledge (*Djalkiri*) is detailed and provides a means by which a person can find his/her way anywhere across the land. The structures of

the various forms of representation in ceremonies and everyday living and as found in the land itself locate space appropriately in the footsteps of the ancestors.

Another example of referencing space in maps without orthogonal axes is that of the Sámi (Indigenous people of Scandinavia). These maps provide a view from the North Pole and the map is demarcated by winds, rivers, and the routes of the reindeer (Jannok Nutti, 2009). In a similar way, the referential system for the Abau of PNG comprises the rivers, and the points on the river where certain activities take place. Different groups wash at different places in the river and so they mark these as fixed places. Any point on land can be given by reference to the distance from one of these points. The side of the river is indicated by stating the left or the right from the line of flow.

By contrast, the Yupno divide their valley area into a quadrant and can refer to these areas in terms of uphill and downhill. However, to describe a route meant reference to the landmarks of villages, resting-places and rivers. Wassman (1997) noted that the descriptions and even more the map drawing (both of which are not generally required in everyday communication except with people from outside) that some sense of walking the route was involved. For example, a slightly longer line represented a difficult time-consuming stretch of the track. Left and right in the language refer only to the body and extensions (e.g. a spear) so would not be used in a route description. In other areas of PNG, distance was marked by a stone's throw or a day's walk but short distances may be measured by body parts, sticks or ropes.

Locating and Communicating

One of the main features of natural language is its 'contextuality' – and it is in this context-boundness that language, perception, and cognition meet. ...Space, our perception of space, and our orientation in space are basic for human action and interaction in a number of domains- Konrad Lorenz even regards our spatial cognitive capacities as one of the roots for human thinking (Senft, 1997, p. 2)

From a perspective based on Indo-European languages we might consider that space is initially referred to in terms of the planes associated with the body. These are the central vertical planes providing (a) left and right and (b) front and back. The third plane may be at our feet as the plane of the ground providing a height dimension. Such a way of referring to space is consistent with a three-dimensional orthogonal Euclidean approach that provides for pathways, areas and volumes. The natural symmetry of the left-right plane and the expectation that one is standing in a vertical position underlie these expectations. The speaker's position and orientation are important referentials.

In many Indo-European referencing systems the speaker or the listener is distinguished but it is also possible to locate in terms of the third object or to allow the context to provide the meaning (Senft, 1997). For example, a ball in front of the tree may mean in front of the tree in alignment with the front of the house, not between the speaker and the tree. Static configurations may use the way one faces but a dynamic configuration may be more about alignment or parallel relationships. Furthermore, metaphoric and extended use of words may be linked by visuospatial reasoning (Lakoff, 1987). For example, "over" is used in a number of ways associated with position and action on a hill or other object. Such words and oppositional concepts such as "here" and "there" are very much determined by sociocultural experiences. English also changes when "it is cold here" is reported as "it is cold there" (Ehrich, 1991, cited in Senft, 1997). Finally the words may be symbolic. "Over the top" refers to a person's exaggerated expression, and "behind" and "front" may be used for denoting people's status in different ways in different languages.

Some words have an emphatic purpose (like the *su* in Turkish, Ozyürek, 1998, cited in Senft, 2004b). Similar emphatics are evident in Papuan languages (Tupper, 2007). Such emphatics can indicate value or other meanings required to understand the reference to place. For example, the same or similar word is used in some Arabic dialects for “right”, “south” (once flourishing Yemen) and “plenty”.

Linguistic Diversity in Referencing Space

Position depends on frames of reference and the semantics of the language. In general, space is referred to by local and directional prepositions or postpositions (e.g. denoted in English by “at, on, in, behind, in front of”); locatives - local or place adverbs (“here, there”); dimensional or spatial adjectives (“high, low, wide”), demonstratives (“this, that”), static and dynamic motion verbs (“to stand, to come, to go, to bring, to take”); directionals (e.g., “to, into”); and presentatives (“there is”) (Senft, 1997, p. 8). These are called deictic systems and there is a large variety of these systems across languages. In addition, languages have gestures such as pointing or raising the eyebrows to indicate position.

The number of terms used in any one language may vary. Senft (1997) presents an argument made by others that the more man-made spaces in a society, the smaller the size of the spatial deictic system. He gives as examples the fact that English has two terms (“here, there”) but Yup’ik Eskimo has 30 terms, East Eskimo has 88 terms. This is partly attributed to the man-made function given to the object associated with the position. For example, “the key is in the door” or “the satellite is in space”. The locative markers of a language impose an implicit classification on spatial configurations. Indo-European categories are topological relationships (e.g. proximity, inclusion, surface, contact), Euclidean notions, and functional notions concerning typical uses.

Prepositions or postpositions generally provide a connection that is obvious by the expected relationship between objects e.g. the book on the table. For this reason, prepositions are frequently minimal and may or may not impact on word order. The Alekano language (from an area in the Eastern Highlands, PNG) has up to 15 slots or positions for different types of words and relationships between words in their sentences (Tami, 2007) presenting a more complex way of connecting objects than that presented in English. The Wiradjuri language has one positional suffix for being “next to a person”, another for “coming to a person” and another for “going away from a person”. These suffixes are attached constantly to nouns, a feature which Codrington (an early contact linguist) (1885) noted by saying of Melanesians and Polynesians that they continually introduce adverbs of place and of direction such as “up and down, hither and hence, seaward and landward”.

For the Anindilyakwa from Groote Island, northern Australia words like “below” would be used for a canoe on the sea but not on the land, and it was the same as the word used for “in” the shelter which was only over and not surrounding the person. Interestingly some words involving motion like “come” and “go” were the same and might require the context to determine the speaker’s intention (Worsley, 1997). Many alternative perspectives have been presented by linguists in the Australasian region (see papers in Senft, 2004b; 1997).

One example of a deictical system that can be found in a number of Papuan and Austronesian languages includes words which refer to a place quite distant, ones that encode medial distance and ones that imply proximity with visibility impacting on choice of words. The expectation of distance varies between languages so the Wiradjuri have a word for “here”, another for “there nearby”, and another “there” referring to an object or

person across the visible space. Sometimes words vary with the use of gestures (e.g. Saliba, Milne Bay, PNG, from Margetts, 2004; Wiradjuri; Yolgnu). In other examples, words vary with addressor and/or addressee or a third person or object as reference point. The number of people involved may also modify the words to be used (e.g., Samoan, from Mosel, 2004).

Local landmarks and environmental features may be used to denote places and the position of objects. For the Iaai on Uvea island (New Caledonia), the word for “down” is used for “west” and “sea” since the mountain is in the east and the land slopes down to entry into the sea in the west. Hence, the word for “east”, “land”, and “up” also reflects the geography and ecology of the island (Ozanne-Rivierre, 2004). In contrast, compass points or cardinal points may be denoted from the way a person is facing (Harris, 1989). In addition, dimensional axes, usually in reference to the body are used but in some cases, the position of the axes can be moved which happens in Kilivila (Senft, 2004a). Such diversity merely hints at the diverse ways of thinking spatially.

A further consideration in discussing locating and communicating is the way in which a group might reach a decision about a place. In other words, it may not be a single or small number of words that locate or describe an object or person but it might be part of a larger discussion about the position or object. It is the discussion itself that can be significant to the speakers (cf. Salzmann, 2006 on disease in Mindanao, Philippines). Similar data were recalled in discussions on measurement of pigs, land, and food in exchanges in Papua New Guinea.

Direction and Travel

Some intricate ways of describing place and space for navigating in the Pacific Ocean provide important knowledge in understanding an ecocultural perspective on space. Uses of star charts in “wayfinding” occurred in the large Polynesian routes such as from Hawaii to Tahiti (Davis, 2010; Polynesian Voyaging Society, ~2003). Islands are out of sight and without a magnetic north compass, these sailors had sophisticated and skilled ways of travelling. Some sailors travelled thousands of kilometres. In the Carolinian Islands, the tilting of the head to 45° provides a kinaesthetic means of selecting the angle of inclination to view the star constellations and note which one is at the point of rising or setting (Worsley, 1997).

Children learn the star positions on a star compass of 32 points. Stones are used to learn the main positioners first and gradually the various games become more complex. These star positions vary over the course of the year as the earth is on a tilt. One game, island hopping, requires the correct order of names of islands on a particular star direction. The sailors also have sea roads that are taken regularly which take account of the swells and currents. Routes are combined and reversed in the games which have various nautical names. Some places on a sea road are given names of sea fauna or flora. For example, from Puluwat to Eauripie (University of Pennsylvania Museum, 1997) spots called whales 1 to 6 provide a day’s sail to a spot directly south of an island. Dragging is a game naming sea places from an island that is not their own. The idea of a right-angle turn (breadfruit picker symbol) or zigzag route is developed.

Implications for Mathematics Education

There are several reasons to be aware of the ecocultural and sociolinguistic aspects of mathematics education. First, mathematics education acknowledges the cultural diversity

of mathematics. The brief discussion above illustrates how rich Indigenous cultures are in referencing position in space and how limited a Eurocentric view of mathematics can be. This richness assists students to appreciate that mathematics is created by man, it is developing and changing and has a purpose. Broadening students' views of how to reference position in space provides for further developments of systems for referencing. For example, topological approaches expanded views beyond the Cartesian coordinate system and brought huge advantages to the studies of mathematics and related sciences.

Second, it provides connectivity with culture and place. Connectivity is an important aspect of all quality teaching but especially in terms of the way we teach mathematics, not in a narrow disconnected way but in a way that is rich, purposeful, interesting, and related to people's lives. When we ask children to map their classroom or their route from home to school, we are connecting to the students. However, we should extend this idea to developing a sense of place. It should be about mapping where their cubby house is, why it is significant, why their environment is significant and thus establish the importance of valuing our land (Sobel, 2008).

A third purpose relates to a study of language in a multicultural world. Some of the aspects of language related to position are relatively simple to follow. In particular, the Australian Indigenous languages can be referred to in mathematics. For example, the postpositional choices for Wiradjuri are relatively easy to understand although we must be careful not to isolate the language from the culture.

By extension, an ecocultural perspective assists the teacher of Australian Indigenous students to have a greater appreciation of the cultural heritage of their students. In areas where Aboriginal English is prevalent, the underlying local language (e.g., Wiradjuri) will influence the expressions of the students. An understanding of these can assist in bridging from Aboriginal English to Standard Australian English. Positional language is one small aspect of this because it is generally embedded in the deixis of the language. When students struggle with English prepositions or add an intonation to a word or sentence, this may reflect the deictical structure of the local language.

It was Thornton and Verran-Watson's perception that the use of a reference point could be a link to school mathematics work on grids. The differences between the two forms of mathematics could be juxtaposed to assist with school learning. In school mathematics, the wind is named by the direction it blows from, whereas in Yolgnu it is where the wind blows **to**, just as the shadow is opposite the position of the sun. For the Yolgnu, the cusped sandbank and crocodile tail can be placed in any direction unlike the school way of placing north at the top of the vertical page.

Finally, a brief study of linguistics situated around mathematics can assist teachers with English as a first language to appreciate the complexity of learning for students from a diversity of language and cultural backgrounds other than English. School mathematical concepts are not merely expressed in English but the language brings certain connotations of culture which may or may not be evident to the student.

References

- Akerblom, K. (1968). *Astronomy and navigation in Polynesia and Micronesia*. Stockholm: Ethnografiska Museet.
- Bryan, E. H. (1938). Marshall Islands stick chart. *Paradise of the Pacific*, 50(7), 12-13.
- Cameron, J. (2003). Educating for place responsiveness: An Australian perspective on ethical practice. *Ethics, Place and Environment*, 6, 99-115.
- Codrington, R. H. (1885). *The Melanesian languages*. Oxford: Clarendon Press.
- Davenport, W. H. (1960). Marshall Island navigational charts. *Imago Mundi*, 15, 19-26.

- Davis, W. (2010). *The wayfinders - Why ancient wisdom matters in the modern world*, Lecture 1, Season of the Brown Hyena, 2009 Massey Lectures' ABC Radio National. Perth, Australia: University of Western Australia.
- Harris, P. (1989). *Mathematics in a cultural context*. Geelong, Victoria: Deakin University Press.
- Highfield, K., Mulligan, J., & Hedberg, J. (2008). *Early mathematics learning through exploration with programmable toys*. Paper presented at the 32nd conference of the International Group for the Psychology of Mathematics Education in conjunction with PME-NAXXX, Morelia, Mexico.
- Jannok Nutti, Y. (2009). Sámi education in mathematics - A school development action research project. *Journal of Australian Indigenous Issues*, 12, 177-185.
- Lakoff, G. (1987). *Women, fire, and dangerous things: What categories reveal about the mind*. Chicago: University of Chicago Press.
- Lewis, D. (1973). *We, the navigators*. Honolulu: University Press of Hawaii.
- Margetts, A. (2004). Spatial deixis in Saliba. In G. Senft (Ed.), *Deixis and demonstratives in Oceanic languages* (Vol. 562, pp. 37-58). Canberra, Australia: Pacific Linguistics.
- Mosel, U. (2004). Demonstratives in Samoan. In G. Senft (Ed.), *Deixis and demonstratives in Oceanic languages* (Vol. 562, pp. 141-174). Canberra, Australia: Pacific Linguistics.
- Owens, K. (2000). Students' mapping and spatial knowledge. *Square One*, 10(1), 17-21.
- Owens, K., & Geoghegan, N. (1998). *The use of children's work samples for deciding learning outcomes and level of development in spatial thinking*. Paper presented at the 22nd annual conference of International Group for Psychology of Mathematics Education.
- Ozanne-Rivierre, F. (2004). Spatial deixis in Iaa. In G. Senft (Ed.), *Deixis and demonstratives in Oceanic languages* (Vol. 562, pp. 129-140). Canberra, Australia: Pacific Linguistics.
- Polynesian Voyaging Society. (~2003). from <http://pvs.kcc.hawaii.edu/index.html>
- Salzmann, Z. (2006). *Language, culture, and society: An introduction to linguistic anthropology* (4th ed.). Boulder, Co: Westview Press.
- Senft, G. (2004a). Aspects of spatial deixis in Kilivila. In G. Senft (Ed.), *Deixis and demonstratives in Oceanic languages* (Vol. 562, pp. 59-80). Canberra, Australia: Pacific Linguistics.
- Senft, G. (2004b). *Deixis and demonstratives in Oceanic languages*. Canberra: Research School of Pacific and Asian Studies, The Australian National University.
- Senft, G. (Ed.). (1997). *Referring to space: Studies in Austronesian and Papuan languages*. Oxford: Oxford University Clarendon Press.
- Sobel, D. (2008). *Childhood and nature: Design principles for educators*. Portland, ME: Stenhouse Publishers.
- Spennemann, D. (1998). *Essays on the Marshallese past: Traditional Marshallese stickchart navigation*, from <http://marshall.csu.edu.au/html/essays/es-tmc-2.html>
- Tami, P. (2007). *Linguistic structure of Alekano*. Paper presented at the Papuan Linguists Conference.
- Thornton, M. B., & Watson-Verran, H. (1996). *Living maths*. Abbotsford, Victoria: Yirrkala Community School and Boulder Valley Films.
- Tuan, Y.-F. (1977). *Space and place: The perspective of experience*. London: Edward Arnold.
- Tupper, I. (2007). *Emphatic pronouns in Namia*. Paper presented at the Papuan Linguists Association Conference.
- University of Pennsylvania Museum. (1997). *Traditional navigation in the western Pacific: A search for pattern*, from <http://www.enm.museum/sites/Navigation/Intro.html>
- Uttal, D. H., Fisher, J. A., & Taylor, H. A. (2006). Words and maps: Developmental changes in mental models of spatial information acquired from descriptions and depictions. *Developmental Science*, 9(2), 221-235.
- Wassmann, J. (1997). Finding the right path. The route knowledge of the Yupno of Papua New Guinea. In G. Senft (Ed.), *Referring to space: Studies in Austronesian and Papuan languages*. Oxford, UK: Oxford University Press.
- Watson-Verran, H., & Turnbull, D. (1995). Science and other indigenous knowledge systems. In S. Jasanoff, G. Markle, Perersen & T. Pinch (Eds.), *Handbook of science and technology studies* (pp. 115-139). London: Sage.
- Worsley, P. (1997). *Knowledges: Culture, counterculture, subculture*. New York: The New Press.

Experiences of Learning and Teaching Mathematics: Using Activity Theory to Understand Tensions in Practice

Shaileigh Page

Flinders University of South Australia
<shaileigh.page@flinders.edu.au>

Julie Clark

Flinders University of South Australia
<julie.clark@flinders.edu.au>

This paper originates from a larger qualitative study exploring how teachers incorporate the affective domain into the primary mathematics classroom. This paper analyses teacher's experiences of mathematics and explores, using activity theory, how these experiences impact their teaching. An important factor to emerge from the data was teacher's own experiences learning mathematics and how this shaped their mathematical identity.

This paper is part of a larger qualitative study focusing on how teachers incorporate the affective domain into the primary mathematics classroom. The affective domain is an ambiguous construct but is commonly defined as a broad term encompassing feelings, emotions, attitudes and values that are attached to an idea, subject or object (Leder & Forgasz, 2006). Researchers suggest the affective domain is ever present in the classroom but often an incidental accompaniment to the mathematical learning (Goldin, 2000). Researchers also state that the affective domain is critically important in all teaching and learning but especially in mathematics (Evans, 2006; Hannula, 2006; Leder & Forgasz, 2006; McLeod, 1992; Schuck & Grootenboer, 2004).

This paper focuses on two participants and their experiences in teaching and learning mathematics. Participants' experiences are the focal point because over recent years there has been an increasing focus on teachers and their classroom practice (English, 2008). This focus is important because teacher's personal beliefs, attitudes, theories and experiences have a pivotal role, one which is described as "one of the most important influences on learning" (Zevenbergen et al., 2004, p.6). Therefore, teacher experiences and perceptions about mathematics are important to understand and analyse when focusing on pedagogy. English (2008, p. 6), even state that more research is needed into "how and what teachers learn from experience". This article discusses how identities and experiences have shaped pedagogical decisions as it "provides a way to connect cognitive, affective, social and cultural issues" (Ponte & Chapman, 2008, p. 243).

The Research Approach

This qualitative research adopted a critical ethnographic case study approach and involved five teachers located at "Hillsview Primary School" in Adelaide. The staff at Hillsview Primary School (referred to as Hillsview) identified the need for more discussion and collaboration as teaching is often an isolating profession (Fullan, 1997), so a Professional Learning Group (PLG) was established in partnership with the participants and the school. A PLG is a process of collective and collaborative learning within a group of people "who share a concern or passion for something they do and learn how to do it better as they interact regularly" (Wenger, 2004). The PLG was a safe and supportive environment which gave the participants many opportunities to critically engage with current literature and to develop and reflect on new teaching strategies to incorporate the affective domain. Along with a PLG, three individual interviews, reflective journals, and classroom observations combined to produce rich and detailed data. The rich qualitative data was analysed using Activity Theory (AT).



Broadly defined, Activity Theory is a cross-disciplinary framework and a descriptive tool for understanding, analysing and explaining different forms of human activity (Sannino, Daniels, & Gutierrez, 2009). This framework “transcends the dichotomies of micro- and macro-, mental and material, observation and intervention in analysis and redesign of work” (Engeström, 2000, p. 960). The main unit of analysis is the activity system. A second generation system (Cole & Engeström, 1993) is used in this research and is referred to in discussions concerning Alice and Nick.

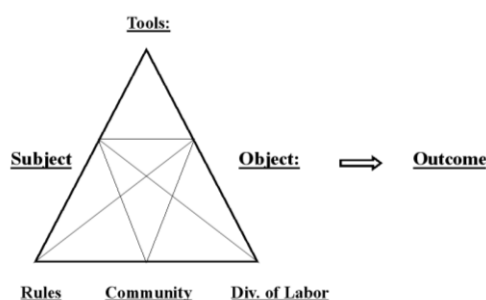

Figure 1. Second Generation Activity System (Cole & Engeström, 1993).

Activity Theory highlights the subject, the object of the action and the tools used within the action. This theoretical lens also focuses on the rules, division of labour and the community that guides and shapes the action and the outcome (as illustrated in Figure 1). The subject is the individual and/or group outworking the action and being impacted by or influencing the tools and the object. The object of the action refers to the aim of the activity system that is reached through the subject using the mediating tools and processes, concepts and/or mechanisms to achieve an object. The rules are the explicit and implicit rules and norms that guide and restrict the activity, the division of labour explains the break down of power and tasks within the activity system, whilst the community is the social context in which the subjects belong. These three things facilitate and constrain the development of action. Finally, the outcome describes the end result from investigating the activity system (Engeström, 1999, 2003; Miettinen, 1999). The nodes of the activity system are italicised in discussions pertaining to Alice and Nick, referring the reader back to the activity system. In activity systems “equilibrium is an exception and tensions, disturbances, and local innovations are the rule and the engine of change” (Cole & Engeström, 1993, p. 8). Tensions and disturbances were created as the participants wrestled with incorporating the affective domain into their mathematics classroom.

Context of the Study

Hillsview Primary School was selected from numerous other schools as they had a detailed strategic plan, which aligned with the purpose of the study and they also had many experienced teachers who were willing to be involved and passionate about mathematics. The Year 3-5 teachers from Hillsview were invited to participate because of the well-documented ‘slump’ in mathematics that can occur within these year levels (Luke, et al., 2002). The results of two participants are explored in this article.

Alice

Alice has been a teacher for 29 years. During this time she has taught in many different school settings both in the country and metropolitan areas. At Hillsview, Alice is a contract teacher who works three days a week teaching Year 5. Alice shares the teaching load with the Deputy Principal, Nick. As a child, Alice remembers mathematics as something she “really, really hated” (Int.1). She recalls being perceived by her teacher, family and other classmates as “not being very good at maths” (Int.1). Despite these negative experiences, she learned to persevere and continued in mathematics to Year 11 and Year 12. Alice explains: “I did struggle through it but I could see it was a necessity” (Int.1). She recalls having no hands-on materials to help her grasp concepts and it was purely a numbers and a mental discipline – something that “just wasn’t meant to be enjoyable” (Int.1). Alice’s teaching style focuses on strong relationships and on having fun – characteristics that were never present in her mathematics classroom growing up!

Nick

Nick’s diverse teaching career has spanned over three decades. He has taught most year levels at some time or another and he has held various positions and leadership roles at the District level. His leadership style focuses on strong relationships and humour and he provides a high level of pastoral care to staff, students and parents when appropriate. Nick is Deputy Principal for three days of the week and teaches Year 5 for the other two days. Nick was always very fond of mathematics as a child and today he still “loves maths” (Int.1) He lived on a farm and grew up with mathematics being a natural part of his everyday life. In his first interview, he reminisced from his childhood, about counting turkeys they were to sell at market, and calculating their weights. Nick explains: “I loved mentally doing maths... I have always loved it and generally [I have] done really, really well” (N, Int.1). Nick is passionate about mathematics and his passion reflects in his deep knowledge, skill and application of this subject.

Results

Alice and Nick’s activity systems and tensions are explored and compared. In particular attention is drawn to participants teaching experiences, learning experiences and their teaching pedagogy in the mathematics classroom. In the following discussion AT is used to describe how teacher experiences cause tensions within the activity system and how they may give rise to pedagogical decisions and changes.

Alice’s Activity System

Alice’s own experiences in mathematics have significantly shaped her beliefs about teaching and learning. Alice is passionate about making mathematics enjoyable and for students learning to be life-long. In her classroom, there is a lot of group work, discussion and use of hands-on learning and visual aids. The heartbeat of Alice’s classroom is based on strong relationships, humour and encouragement. The students are encouraged to try hard at maths even if they are not always successful. She has established a classroom culture where trying and doing your best is the most important thing. She makes time for all students – especially the ones who struggle in mathematics. Within her activity system there are two tensions that significantly shaped her teaching pedagogy.

Tension within the subject. Alice's negative experiences as a learner of mathematics have shaped her significantly, resulting in a lack of confidence in her mathematics teaching. Alice desires to teach students to take risks, enjoy mathematics and to deeply learn mathematics (object) but she is aware of the gaps in her own skills and ability in mathematics. This causes a tension within the subject as she desires for mathematics to be fun and enjoyable but she has very few enjoyable experiences of mathematics herself, to draw upon. The following extract from Interview 2 illustrates the tension within the subject of Alice's activity system:

Maths is not my forte, it never was ... I certainly don't have self confidence. I guess I question what I do 90% of the time ... I think you can question too much and I guess the personality trait for me is that I question what I do all the time because I don't fully believe that its quite good enough, there must be another way or something else must work better than what I've been doing but I do now that I'm good at what I do. (Alice, Int. 2)

This tension opened a significant doorway into past experiences. Alice's honesty encouraged others in the PLG to be honest about their experiences too. These negative experiences resulted in Alice lacking some confidence in teaching mathematical concepts. Interview's, PLG discussions and classroom observations made it evident that this was an important issue to deal with and discuss before moving onto new or different pedagogy in mathematics.

Tensions between subject and community. Due to Alice's lack of confidence, she is driven to develop and discuss useful classroom strategies. Alice reflected during her final interview that she favours sharing teaching practice and practical resources (tools) within the Professional Learning Group rather than philosophical discussions. Alice, a teacher who had negative experiences in mathematics as a learner and who questions her teaching practice, desires strategies that have been tried by others, have worked in others classroom. Others in the PLG (community) were more advanced from having wider community experiences within the field of education and were ready to move past the practicalities of teaching. Such participants valued deep philosophical discussions upon which teaching and teaching strategies are based. The following extract from Interview 3 explains the tension developed within Alice's activity system as the various motives of other participants came to light during the meetings:

Let's share the practical ideas that actually work, and put that in a toolbox and you know, move it on. There are some in the group who like the philosophical discussions, and they are really interesting, and yes they're the basis of how we learn and all the rest of it, but I want the practical stuff, that's what I want to come out with, is the practical stuff, but that's a personal comment, you know, and that's in no way a slight on anybody else. (Alice, Int. 3)

The tensions present in Alice's activity system related to her experiences, perceptions and knowledge. No resolutions were reached, but the PLG provided a safe and supportive environment to share these experiences and tensions, leaving Alice with strategies to work towards resolutions.

Nick's Activity System

Nick's activity system is founded on two beliefs. Firstly, he believes that mathematics is everywhere and connects to all aspects of students' lives. Secondly, he believes that wellbeing is central to all learning. Nick is driven by his *outcome* or endeavour to incorporate the affective domain into mathematics and his *object* is to teach so that students are empowered, life-long learners, and work like mathematicians. Nick favours

tools such as student and self reflection, strong and safe relationships within the classroom and connecting mathematics to all learning to act on this *object*. His underlying motive for teaching maths with these goals is that the knowledge and the skills student learn, will benefit them later on in life and prepare them for Year 6. Within this activity system there are various tensions that have developed over the course of the study and two key tensions are emphasised.

Tension between community and object. Perhaps one of the most difficult and immediate tensions Nick had to face was between the student (community) perceptions of mathematics and the object of creating numerate mathematicians. This tension was revealed in the first interview with Nick who suggests that he has been aware of this tension for a significant period of time. From the beginning of the study it was evident through Nick's first interview that he is passionate about teaching mathematics in such a way that students learn that mathematics is everywhere. Nick explained, however, that this way of teaching mathematics seems to be problematic for some students, as they believe that mathematics is simply adding and subtracting and working from a textbook. The students in his classroom often prefer conventional mathematics where they can add and subtract and demonstrate their speed at doing so, but Nick wants their skills to be further developed so they can apply the mathematical knowledge to real life situations. The following extract from Interview 1 begins to suggest this tension between the students in the community and the object of numerate mathematicians:

So there's a batch of kids where it doesn't work if they've got to think to hard because they want it to be easy – they want to show off their amazing ability to be fast and smart. What they can't do is apply very well ... In other words if it's not an exercise on the board then they don't do so well. (Nick, Int.1).

Nick was raised with mathematics as a common language used to describe the farm, the world he lived in. The students in his class were not used to mathematics being a language – instead they perceived it as a school subject that required paper and pen and lots of mental computations. This was a constant tension throughout the duration of the study. Another tension was between the rules of the system and Nick's object.

Tension between the rules and object. In Nick's final interview he reflected on his priorities within teaching mathematics. One priority early in his career was to cover the mathematics curriculum (*rules*), and produce good academic results for all students in this learning area. Nick is obviously expected to teach the whole curriculum and thus he felt restricted in choice of alternate pedagogy. Nick believes that the process of learning maths is more important than correct answers. The thing that is valued is the process of learning and the process of thinking like a mathematician, where maths is viewed as a cognitive and affective entity. He struggled to find strategies teaching the expected curriculum and simultaneously developing mathematics lovers. The following extract from Interview 3 begins to suggest a tension between the curriculum, the need for students producing good mathematics results and the development of mathematically literate and autonomous students:

I think I was too driven by success and achievement, and the content, rather than the process. So, that's my passion, and then, I guess I apply the same sort of thinking and process in my classroom. And I do get frustrated in the classroom, because sometimes the curriculum's so big. (Nick, Int.3)

According to Nick, the curriculum (*rules*) is big and sometimes frustrating, but he had decided to focus on the process of learning mathematics rather than focusing on the size of the curriculum. His leadership experience tells him that curriculum is important and must

be taught and but his many years of teaching experience indicate that authentic learning is equally important. This tension caused Nick to reflect on the opposing views of curriculum versus numerate students (*object*) and from this reflection came a significant resolution.

Resolution. The *object* of Nick's activity system was to teach students (*community*) to think and work like mathematicians, but he was aware that their perceptions of maths would hinder this. This primary tension gave rise to new ways of teaching. Nick resolved this primary tension by creating a whole school initiative called a 'Math-a-thon'. Nick was aware that perceptions of mathematics were very narrow and limited. He was also aware that the curriculum (*rules*) was too large to adequately teach well within the school year. He designed a maths trail for all students and encouraged parent and community participation. It was a huge event, which made maths fun – although Nick reported that many of the students still complained that they had to 'think too hard'. Nick believed the Math-a-thon helped change student and parent perceptions of maths and impacted the student's affective domains – their feelings about maths. Nick also felt that the Math-a-thon integrated the curriculum, thus making it more manageable. It took the focus away from achievement, although that was still measured, and emphasised the process of using the mathematical knowledge students had. This event only lasted two days but the learning that occurred in the months leading up to the event integrated the curriculum and placed mathematics and numeracy at the forefront of the school day. The tensions within Nick's activity system gave rise to whole school change in the teaching and learning of mathematics.

Discussion and Conclusion

From examining the activity systems of the two participants it is clear that background experiences, attitudes and beliefs are strongly influential in shaping tensions and in determining their responses to such disturbances in their activity systems. Alice's negative experiences as a learner of mathematics lead to significant subject and community tensions, which she addressed through openness and discussions with others in the PLG. Her tensions were limited at a classroom level, as she wrestled with her day-to-day teaching of mathematics. Nick's broader leadership perspective and confidence in mathematics lead to tensions and resolutions beyond the everyday classroom pedagogical issues. As Alice deals with the primary tensions and grows in confidence she may be liberated to address higher level concerns outside of her immediate classroom.

This case study comparison of two teachers has many implications for mathematics education and research. Firstly, it is imperative that time and space is given for teachers to reflect on their own mathematical identity and how this is shaping their teaching. Secondly, it is important that time is given to teachers to discuss, reflect and explore pedagogies.

In conclusion, the findings of this study contribute to wider discussions on teacher education and development and reinforce the understanding that teachers own identity and experiences prior to entering the classroom are significant and must be given attention by educators and the wider research community within mathematics education.

References

- Cole, M., & Engeström, Y. (1993). A cultural-historical approach to distributed cognition. In G. Salomon (Ed.), *Distributed Cognitions: Psychological and Educational Considerations* (pp. 1-46). New York: Cambridge University Press.

- Engeström, Y. (1999). Activity theory and individual and social transformation. In Y. Engeström, R. Miettinen & R. Punamäki (Eds.), *Perspectives on Activity Theory* (pp. 19-38). Cambridge, UK: Cambridge University Press.
- Engeström, Y. (2000). Activity theory as a framework for analyzing and redesigning work. *Ergonomics*, 43(7), 960-974.
- Engeström, Y. (2003). *Cultural-historical activity theory*. Retrieved 1 June 2007, from <http://www.edu.helsinki.fi/activity/pages/chatanddwr/chat/>
- English, L. (2008). Setting an agenda for international research in mathematics education. In L. English (Ed.), *Handbook of international research in mathematics education* (2nd ed., pp. 3-19). New York: Routledge.
- Evans, J. (2006). Affect and emotion in mathematical thinking and learning. In J. Maasz & W. Schloeglmann (Eds.), *New mathematics education research and practice* (pp. 233-255). The Netherlands: Sense Publishers.
- Fullan, M. (1997). *Change forces: Probing the depths of educational reform*. USA: Braun-Brumfield.
- Goldin, G. A. (2000). Affective pathways and representation in mathematical problem solving. *Mathematical Thinking and Learning*, 2(3), 209-219.
- Hannula, M. (2006). Affect in mathematical thinking and learning. In J. Maasz & W. Schloeglmann (Eds.), *New mathematics education research and practice* (pp. 209-232). The Netherlands: Sense Publishers.
- Leder, G. C., & Forgasz, H. J. (2006). Affect and mathematics education: PME perspectives. In A. Gutierrez & P. Boero (Eds.), *Handbook of research on the psychology of mathematics education: Past present and future* (pp. 403-427). Rotterdam, The Netherlands: Sense Publishers.
- Luke, A., Elkins, J., Weir, K., Land, R., Carrington, V., Dole, S., & Stevens, L. (2002). *Beyond the middle: A report about literacy and numeracy development of target group students in the middle years of schooling*. Unpublished Report for Department of Education, Science and Training.
- McLeod, D. B. (1992). Research on affect in mathematics education: A reconceptualization. In D. A. Grouws (Ed.), *Handbook of research on mathematics teaching and learning* (pp. 575-596): National Council of Teachers of Mathematics.
- Miettinen, R. (1999). Transcending traditional school learning: Teachers' work and networks of learning. In Y. Engeström, R. Miettinen & R. Punamäki (Eds.), *Perspectives on activity theory* (pp. 325-344). Cambridge, UK: Cambridge University Press.
- Ponte, J., & Chapman, O. (2008). Preservice mathematics teachers' knowledge and development. In L. D. English (Ed.), *Handbook of International Research in Mathematics Education* (2nd ed., Vol. 1, pp. 223-261). New York: Routledge.
- Sannino, A., Daniels, H., & Gutierrez, K. D. (2009). *Learning and expanding with activity theory*. New York: Cambridge University Press.
- Schuck, S., & Grootenboer, P. (2004). Affective issues in mathematics education. In B. Perry, G. Anthony & C. M. Diezmann (Eds.), *Research in mathematics education 2000-2003* (pp. 53-73). Australia: Mathematics Education Research Group Australia.
- Wenger, E. (2004). *Communities of Practice a capability-development approach to strategy: Interactive workshops*. retrieved 10 October 2009 from <http://www.ewenger.com>

Facilitating the Development of Proportional Reasoning through Teaching Ratio

Linda Parish
Australian Catholic University
<linda.parish@acu.edu.au>

If the ability to reason proportionally seems to be a good indication of likely success in further mathematical pursuits (Lamon, 1999), how do children develop this ability, and how can teachers facilitate this? In this present study, six ratio/rates task-based assessment questions were trialled on ten students from Grades 5 to 9 in an attempt to describe the developing understanding of students within this construct of rational number. Tentative points of growth (or stages of understanding) are suggested, with some implications for the classroom teacher.

This study was part of a Master of Education project to design an assessment interview to identify the points of growth, or stages of development, in children's thinking about ratio problems. Ratio is a sub-construct of rational number (Kieren, 1976) that requires proportional reasoning. The purpose of 'growth points' is to describe the developmental pathway children typically follow, and to inform teachers of where children have reached developmentally so that further learning can be targeted to their zone of proximal development. Two questions are explored in this paper: how do children typically develop ratio understandings, and can teachers use this knowledge in order to facilitate the development of proportional reasoning?

Theoretical Background

Proportional reasoning has been called the backbone, the cornerstone, the gateway to higher levels of mathematics success, and is considered as a "capstone" of primary school mathematics (Kilpatrick, Swafford & Findell, 2001; Lamon, 1999; Lesh, Post & Behr, 1988). Proportional reasoning involves "making multiplicative comparisons between quantities" (Wright, 2005, p. 363), together with "the ability to mentally store and process several pieces of information" (Lesh, et al, 1988, p. 93). An example of such a problem is, if three lollies cost ten cents, how much will twelve cost? According to Lamon (1999), "proportional reasoning is one of the best indicators that a student has attained understanding of rational numbers" (p. 3).

Kieran, 1976, cited in Clarke, Sukenik, Roche, and Mitchell, (2006), Lamon, (1999), and Wright, (2005) identified five sub-constructs of rational number – fractions as part-whole comparisons, fractions as measure, fractions as an operator, fractions as quotients, and fractions as ratio, or part-part comparisons. There are functional differences in each of these sub-constructs, but they are inter-related and it is believed that, if fractions are taught with a holistic approach, they can provide many contexts and representations that promote higher order thinking and develop proportional reasoning (Lesh et al, 1988).

This paper considers the sub-construct of ratio and rates. Ratio is a part-part comparison. For example, '3 lollies for 10 cents' describes a ratio between an amount of money and the amount of confectionery that can be bought with that amount of money. A ratio becomes a rate when it implies a constant, indicated by per. For example, 80km per hour describes a ratio between a measure of distance and a measure of time where for every one hour, 80 kilometres is travelled, implying that in three hours 240 kilometres will



have been travelled. Rates can also be varying, such as monetary exchange rates, or the rate of acceleration, but these types of rates are not considered here.

The Assessment Interview

Within the sub-construct of ratio, Lamon (1993) identified four types of problems that are semantically distinct. The questions included in the interview were chosen, and/or designed, based on these four semantic types of ratio problems (see Figure 1). Ten students of mixed ability were interviewed, five from Grade 5, four from Grade 6, and one Year 9 student.

<i>Lamon's Ratio Semantic Types</i>	<i>Summary of Assessment Interview Questions</i>
<p>1. Part-Part-Whole where the 'whole' is described in terms of two or more 'parts' of which the whole is composed.</p>	<p>Questions 1 & 2: Green Paint = 1 blue: 3 yellow. Christmas M & Ms – there are half as many greens as reds (adapted from Witherspoon, 2002)</p>
<p>2. Associated Sets where the relationship between two elements is only defined within the problem situation itself.</p>	<p>Questions 3 & 4: Ghost Drops – 3 for 10c – confectionary and money. Oranges and Lemons – combined to make a punch 2:3 vs. 3:5 – which is more orangey? (Lamon, 1999, p. 181)</p>
<p>3. Well-Chunked Measures where two measures are compared to give a third, inclusive measure.</p>	<p>Question 5: Adelaide Trip – kilometres per hour = speed. 160km in 2 hours; 360km in 4 hours – how long will it take to get to Adelaide (600km)?; at what speed am I travelling?</p>
<p>4. Stretchers and Shrinkers problems where the ratio between two measures is preserved, or fixed, when a figure is enlarged (stretched) or scaled down (shrunk).</p>	<p>Question 6: Two rectangles – $6 \times 8 \rightarrow ? \times 12$ – what is the height of the enlarged rectangle? (Lamon, 1993, p. 44)</p>

Figure 1, Semantic Types and Related Problems

Observations from Question 1 – Part-Part-Whole

Green Paint = 1 blue: 3 yellow. “If I added two more blues, how much more yellow would I need?” established the students’ concept of “homogeneity” (Lo & Watanabe, 1997, p. 219), a recognition that a relationship exists that needs to be preserved – for every one blue, three yellows are required – which is a necessary and important element of proportional thinking (Lo & Watanabe, 1997). Half the students interviewed showed this implicit understanding. The others, except for one, applied an additive strategy – if you add two to the blue, you will need to also add two to the yellow – and one appeared to simply guess, “you’d add two, maybe three” yellow.

The second part of this question, “How much yellow and blue paint do I need to make 28 litres of green paint?” measured students’ ability to reverse the process of ‘building-up’, to a ‘breaking-down’, by recognising the ratio as a unit in itself. Of the five who correctly answered the first question, four recognised the ratio-unit of four litres, “there are 4 litres altogether and $4 \times 7 = 28$, so there’d be 7 blue and therefore 3×7 (21) yellow,” with one describing it as “28 divided into quarters; $\frac{1}{4}$ is blue, $\frac{3}{4}$ is yellow.” One employed what Lo and Watanabe (1997), in their research on developing ratio and proportion schemes, describe as a *ratio-unit/build-up strategy*: recognising 1:3 as a ratio-unit and ‘building up’

from that – 1:3 → 2:6 → 3:9 →... (see Figure 4). One girl was stumped with this question, not recognising the unit of four, “I counted the yellows by 3, and counted how many times I counted the 3, but then I got lost.” Interestingly, one Grade 6 boy who had used an additive strategy in the first part of this question, recognised the ratio-unit and calculated correctly explaining, “I thought 4 x what = 28?, and then I did ... 7 x 3 = 21.”

The final part of this question (how much yellow and blue paint would I need to make 10 litres?) enabled an assessment of a higher order thinking strategy, using a non-integer scalar proportion. Only Nathan (Year 9) got this question correct, although Michael (Grade 5), after much consideration, decided he could use the same process as before – divide 10 into quarters (which is 2½), but then incorrectly calculated 2½ x 3 as 6½. Two girls, who had been correct up to this stage, both said, “It can’t be done, you’d have to have 8 litres or 12 litres.” The boy who had been correct calculating the 1:3 = 7:21 ratio but had previously used an additive strategy, applied a mixture of both for this question – (starting with the initial 1:3) “I doubled it, which was 2:6, then I did 3 blues, which gave me 9 litres (3:6), then I added ½ to each (3½:6½) to make 10 litres”

Observations from Question 2 – Part-Part-Whole

Christmas M&Ms. “I have nine red and green M&Ms, there are half as many greens as reds, how many reds and how many greens do I have?” (adapted from Witherspoon, 2002) assessed students’ ability to interpret and understand the common *language* of ratio, ‘half as many’, ‘three times as many’, ‘half as many again’. Six students answered this question quickly and correctly, with one using an algebraic-type explanation, “If I can find the amount of red and then halve that ..., because red + ½ red = 9.” One Grade 5 girl was correct with the 6 and 3, but was confused with the term ‘half as many’, deciding it was functionally the same as ‘twice as many’. Three others simply halved the 9.

Observations from Question 3 – Associated Sets

Ghost Drops cost 3 for 10c: how much would 15 cost; how many could I buy for 80c? Associated Set problems were identified by Lamon (1993) as eliciting more relative thinking in more students than the other semantic types. She concluded that this was because of the highly pictorial and/or manipulative nature of these tasks. It was certainly true that students thought more relatively with the Ghost Drops problem, all students except for two solved it with relative thinking, although none of them used pictures or tally marks to solve it. They used either Lo and Watanabe’s (1997) *ratio-unit/build-up strategy* (3:10 → 6:20 → 9:30 → etc.) (three students), or scalar reasoning (3:10 = 15:?, and 3:10 = ? :80) (five students). One employed a functional reasoning strategy (i.e., finding a unit value for one Ghost Drop – if 3 = 10c, then 1 = 10 ÷ 3c), but then ignored the ‘extra bit’ (0.33 cents). Tanya (Grade 5), who for everything else either used visual judgement or ‘just guessed’, solved the Ghost Drop problem with a form of patterning – listing 3s, skip counting until she reached 15 then counted down her list in 10s to 50 for the first part of the question, then continued to count to 80 in 10s and wrote down corresponding 3s and added them up to solve the second part of the question (see Figure 2).

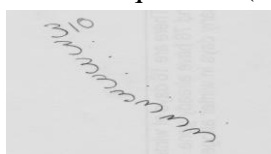

Figure 2. Tanya’s 3s pattern.

One student did not approach the Ghost Drop problem ‘logically’, ignoring some of the given values (15 Ghost Drops = 15 x 10 = \$1.50; and 80c would buy $80 \div 3 = 26$ Ghost Drops with 2c left over).

Observations from Question 4 – Associated Sets

Oranges and Lemons – 2 orange: 3 lemon & 3 orange: 5 lemon, which is more ‘orangey’? The Oranges and Lemons task (Lamon, 1999) elicited more additive thinking or visual judgement than any other task (seven students), even though some described it in terms of ratio (2 to 3, and 3 to 5). Nathan (Year 9) and Briony (Grade 6) compared each ratio correctly, but in different ways (see Figure 3).

Michael (Grade 5) solved this problem by forming two fractions that he could compare easily, “ $2/5 \times 3 = 6/5$ and $3/8 \times 3 = 9/8$, and $1/5$ is more than $1/8$ so $2/5$ (A) would be more orangey.”

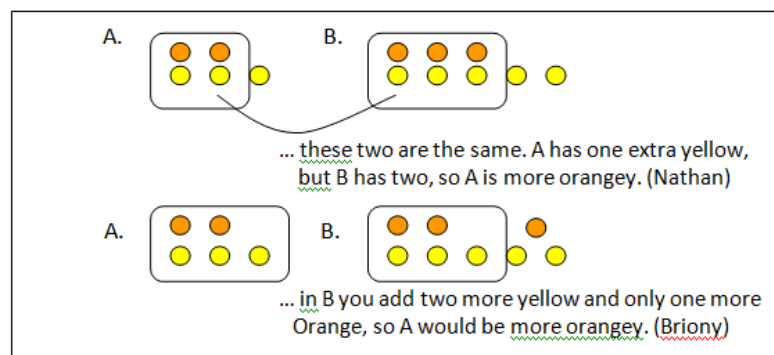

Figure 3. Ratio comparisons.

Observations from Question 5 – Well-Chunked Measures

The Adelaide Trip. This question was more difficult in that it used larger numbers (Lo & Watanabe, 1997), as well as a non-integer scalar relationship. The larger numbers elicited a different approach from students who had been comfortable with multiplicative reasoning in previous questions. To determine how long it would take to get to Adelaide, all students reverted to a ratio-unit/build-up strategy, with some being limited to a ratio-unit of 2hrs = 160km, while others recognised the ratio-unit of 1hr = 80km and $\frac{1}{2}$ hr = 40km. No-one recognised the structure $1:80 = ?:600$, but the reality is that a *ratio-unit/build-up* approach is probably the more efficient strategy to use in this instance anyway, suggesting that ‘more sophisticated’ does not automatically equate to ‘most efficient’. However, it may also be worth considering supplying calculators at this stage of the interview to remove the constraint of manipulating larger numbers mentally. Would different strategies be employed if these constraints were removed?

The second part of the Adelaide Trip question asks, “What average speed am I travelling?” Only one Grade five student recognised the speed element of this question (Lamon, 1993), even Michael, who showed very strong reasoning skills in all other questions was totally stumped. The five students (from Grades 6 and 9) who did get this question correct, all knew the answer straight away, recognising that “if I did 160km in 2 hours, then I did 80km in one hour, which is 80km/hr.” Two others just guessed “because the speed limit is 100km/hr”.

Observations from Question 6 – Stretchers and Shrinkers

Enlarged Rectangle. Lamon, from her findings in her 1993 study, suggested that *Stretchers and Shrinkers* problems should only be introduced after students have developed multiplicative thinking. It was certainly very obvious in this interview that it was only those students who showed strong multiplicative reasoning in previous questions that saw Lamon’s (1993) Enlarged Rectangle task as a relative problem, but even this was not predictable – Nathan (Year 9) had answered all previous questions correctly, but reverted to an additive strategy for this one.

Proposed Points of Growth (or Stages of Understanding)

The development of ratio and proportional reasoning is difficult to measure, as growth in understanding does not appear to be necessarily linear across all problem types, and, indeed, not all ratio problems are solved most efficiently by the more sophisticated strategy. However, the following are general observations.

Students with little or no understanding of ratio problems may attempt a visual judgement or just guess, but even at this level these guesses may be reasonable, or they may be completely off the mark in terms of the required goal of the task.

As students begin to recognise the significance of the numbers in ratio problems they will initially try to ‘keep the balance’ by adding equivalent amounts to each value. This is an additive strategy, and does not maintain ‘relativeness’.

In the Ghost Drop problem, ‘How much would 15 Ghost Drops cost?’, Tanya wrote a list of threes – adding them together as she wrote them down – and stopped when she reached 15 (see Figure 1). Inhelder and Piaget (1958, cited in Lamon, 1993) called this preproportional reasoning because, “children achieved correct answers without recognising the structural similarities on both sides of the proportion equation” (p. 41).

Students who recognise the need to preserve an equivalent relationship between two values are starting to think relatively, and use a multiplicative strategy to ‘build up’ to a new value. Lo and Watanabe (1997) coined the phrase ‘*ratio-unit/build-up method*’, as these students were able to consider the ratio ‘3 for 10c’, for example, as a composite unit (Kilpatrick et al, 2001), and then build this unit up (see Figure 4).

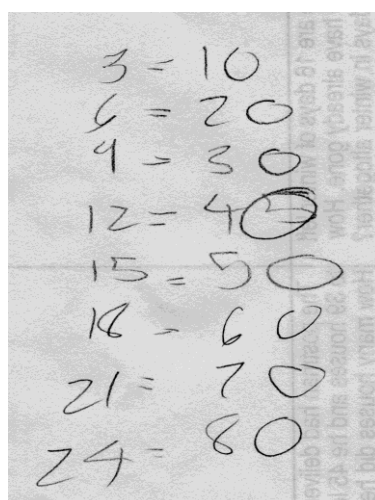

Figure 4. Ratio-unit/Build-up Strategy.

The next stage seems to be recognition of functional and scalar relationships. In functional reasoning a student is able to determine a unit value and multiply by this. For example, in the problem “‘3 for 10c’ and ‘10 for 35c’, which is better value?”, students can determine that if 3 cost 10c then one Ghost Drop will cost 3.33 cents, and 10 of these will be 33.3c, which is less than 35c. Scalar reasoning determines the multiplicative relationships between A and C in $A/B = C/D$. For example, 3 Ghost Drops (A) for 10c(B) = ? Ghost Drops (C) for 80c(D): $D = B \times 8$, therefore $C = A$ (i.e., 3) $\times 8$.

The most sophisticated level of ratio reasoning observed was being able to manipulate large and/or non-integer scalars (Lo & Watanabe, 1997), for example, in the Adelaide Trip question, 160km(A) in 2 hours(B) = 80km(C) in 1 hour(D) = 600km(E) in ? hours (F). $E = C \times 600/80$, therefore $F = D \times 600/80$. Based on these findings points of growth (or stages of understanding) in the learning of fractions as ratio could be described as (see Figure 5):

	Growth Point	Description
0	Not Apparent	- Cannot comprehend the required ‘goal’ of the task.
1	Visual/Ignore	- Uses visual judgement or just guesses; ignores or does not consider individual values.
2	Additive	- Early attempts at quantifying, but using constant additive strategies rather than multiplicative relationships.
3	Pre-proportional Reasoning	- Pattern recognition and replication, but without recognising the multiplicative structure (non-reversible).
4	Ratio-Unit/Build-Up	- Recognises the ratio as a unit and can build up this unit maintaining the relative structure of the individual values (reversible).
5	Functional & Scalar Reasoning	- Can determine a unit value and multiply by this; can determine the multiplicative relationship between A & C in $A/B = C/D$.
6	Quantitative Proportional Reasoning (Lamon, 1993)	- Uses algebraic-type methods to represent and solve complex proportion problems.

Figure 5. Proposed Points of Growth (in understanding) for Fractions as Ratio

Some Implications for Teaching

Traditionally ratio as proportion is not taught before secondary school, and yet all the primary students interviewed were able to connect with at least some of the ratio interview tasks. Many of the tasks simulated familiar situations for the students, especially ratio as a rate (for example, cost per item, kilometres per hour), and all the primary school students appeared to have some intuitive understanding of how to solve at least some of the tasks in the assessment interview. Indeed, they tended to use more intuition than the secondary student who often tried to remember a rule or formula he knew he had been taught. Lamon (1999) argues that young children can see and understand part-part comparisons more naturally than part-whole comparisons. For example, they will describe  as $2/3$ rather than $2/5$. Vergnaud (1983) stated, “It is difficult and sometimes absurd to study separately the acquisition of interconnected concepts.” (p. 127). So one question to consider is, is it necessary, or at all beneficial, to postpone ratio instruction until post-primary school? Do children need to be able to think multiplicatively before they can understand ratio, or does learning about ratio help them to think multiplicatively? For example, eight out of the ten students interviewed in this study understood the term ‘twice as many’ (Christmas M&Ms). Of these eight, only half recognised the multiplicative structure of the Green Paint question. If problems like the Green Paint question were used as an introduction to ratio instruction with a ratio of $A:B = 1:2$, *together with* the

description ‘there are twice as many Bs as As’, children using an additive method for expanding the ratio (see Figure 5), would quickly recognise that adding the same to each value does not maintain the ratio of ‘twice as many Bs’, and would need to re-evaluate, and explore number patterns that do maintain this relationship.

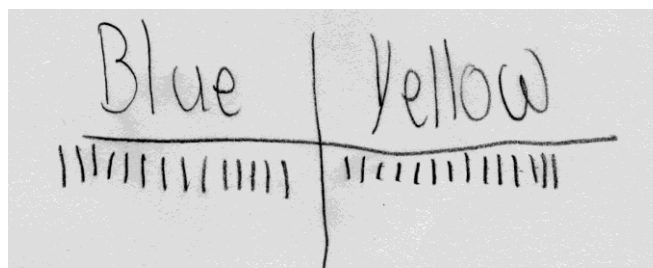

Figure 5. Additive method for calculating how many blues and yellows required to make 28L green paint.

The *ratio-unit/build-up* strategy, using Ratio Tables and/or Double Number Lines (see Figure 6) proved a useful tool in early work with proportional situations (Kilpatrick et al, 2001). The use of these could help children organise their thinking and help promote the move from additive to multiplicative reasoning.

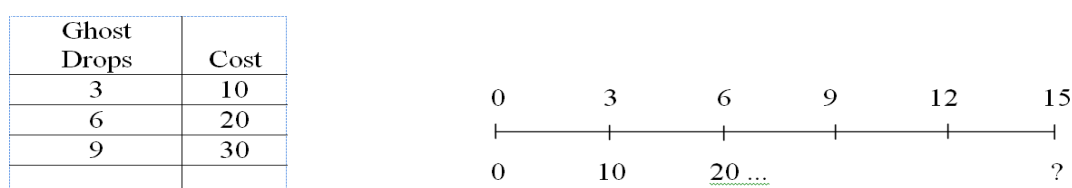

Figure 6. Ratio Table and Double Number Line.

Many children seem to intuitively organise their thinking this way. For those who do not, these tasks could be useful tools to introduce and discuss. Lamon (1993) also talked about using problem types that lend themselves to being re-presented with manipulatives or pictures.

One of the most interesting observations made during the study was that most of the students interviewed were not proficient with their multiplication facts, and they all became frustrated with this realisation when their thinking processes were interrupted by having to stop and work out, for example, 3×8 . Ratio/proportion problems that require multiplicative thinking, give students a reason for knowing their multiplication facts, apart from ‘tables challenges’ and other rote exercises. Something that provides meaning and purpose to a students’ learning appears to be a great motivator.

There is much children’s literature available that could be used to initiate discussion about relative size. Stories such as *Counting on Frank* (Clements, 1991) and *The Librarian Who Measured the Earth* (Lasky, 1994), and books like *Incredible Comparisons* (Ash, 1996), all provide contexts for discussing ratio and/or rates, and build children’s concept of proportional understanding (Thompson, Austin & Beckman, 2002).

Conclusion

In terms of proposed points of growth for understanding fractions as ratio, this exploration of children's understanding of the sub-construct of ratio and rates under the enormous umbrella of 'proportional reasoning' is merely the tip of the iceberg. For this study only a small sample of students were interviewed; there may well be other types of strategies – correct and incorrect – that students typically employ, that would describe other stages of growth in children's thinking. The questions chosen for the assessment interview may also be limiting in assessing all of the possible stages of growth. However, the points of growth identified here may give teachers a starting point for identifying and understanding students' thinking in terms of proportional reasoning with ratio problems, and a greater understanding of where and how to move each student forward in their learning.

Due to the findings of primary school children's intuitive understandings of ratio, the consideration of beginning 'fractions as ratio' instruction earlier than secondary level of schooling may be something worth exploring – as long as this instruction allows for a development of the intuitive understandings, and not just an introduction of procedures and ratio formulae. Teacher understanding of the concept of ratio is another area not discussed that has a huge impact on children's learning. All are important areas for future research.

References

- Ash, R. (1996). *Incredible comparisons*. London: Dorling Kindersley.
- Clarke, D. M., Roche, A., Mitchell, A., & Sukenik, M. (2006). Assessing fraction understanding using task-based interviews. In J. Novotna, H. Moraova, M. Kratka, & N. Stehlikova (Eds.), *Proceedings of the 30th Conference of the International Group of Psychology of Mathematics Education* (Vol. 4, pp. 337-344). Prague: PME.
- Clement, R. (1991). *Counting on Frank*. Milwaukee: Gareth Stevens Publishing.
- Kieren, T. (1976). On the mathematical, cognitive and instructional foundations of the rational numbers. In R. A. Lesh (Ed.), *Number and measurement: Papers from a research workshop* (pp. 101-144). Athens, GA: ERIC/SMEAC.
- Kilpatrick, J., Swafford, J., & Findell, B. (2001). *Adding it up: Helping children learn mathematics*. Washington, DC: National Academy Press.
- Lamon, S. (1999). *Teaching fractions and ratios for understanding: Essential content knowledge and instructional strategies for teachers*. Mahwah, NJ: Lawrence Erlbaum.
- Lamon, S. J. (1993). Ratio and proportion: Connecting content and children's thinking. *Journal for Research in Mathematics Education*, 24 (1), 41-61.
- Lasky, K. (1994). *The librarian who measured the earth*. Boston: Little, Brown & Co.
- Lesh, R., Post, T., & Behr, M. (1988). Proportional reasoning. In J. Hiebert & M. Behr (Eds.), *Number concepts and operations in the middle grades* (Vol. 2, pp. 93-118). Reston, Virginia: Lawrence Erlbaum.
- Lo, J. & Watanabe, T. (1997). Developing ratio and proportion schemes: A story of a fifth grader. *Journal for Research in Mathematics Education*, 28 (2), 216-236.
- Thompson, D. R., Austin, R. A., & Beckmann, C. E. (2002). Using literature as a vehicle to explore proportional reasoning. In B. Litwiller & G. Bright (Eds.), *Making sense of fractions, ratio and proportions* (pp. 130-137). Reston, Virginia: National Council of Teachers of Mathematics.
- Vergnaud, G. (1983). Multiplicative structures. In R. Lesh & M. Landau (Eds.), *Acquisition of mathematics concepts and processes* (pp. 127-174). Orlando, Florida: Academic Press, Inc.
- Witherspoon, M. (2002). Fractions: In search of meaning. In D. Chambers (Ed.), *Putting research into practice in the elementary grades: Readings from journals of the National Council of Teachers of Mathematics* (pp. 134-136). Reston, Va: NCTM.
- Wright, V. (2005). Proportional reasoning: Some rational thoughts. In J. Mousley, L. Bragg, & C. Campbell (Eds.), *Mathematics: Celebrating achievement* (pp. 363-375). Melbourne: Mathematical Association of Victoria.

An Ethnographic Intervention using the Five Characteristics of Effective Teacher Professional Development

Sitti Maesuri Patahuddin
State University of Surabaya
<s@maesuri.com >

This paper is aimed to describe an ethnographic intervention study of supporting a Low Use Internet (LUI) teacher to use the Internet for his professional development. Five characteristics of effective professional development were identified and applied. This description is followed by a reflection on the process to get a deeper insight about factors that could support and restrict teachers in making positive changes in his mathematics teaching.

Ethnography means literally to write about people (Burns, 2000) or to create a picture of a group's "way of life" (Wolcott, 1988, p. 188). In a more focused sense, ethnography is fundamentally an effort to find out about a group of people to be able to describe their socio-cultural activities and patterns (Burns, 2000; Freebody, 2003).

As a qualitative research method, ethnography was initially used in sociology research and particularly in anthropology. Its purpose was to uncover social, cultural, or normative patterns of a particular culture. Yet, this method has been accepted by many educational researchers as a tool to gain a rich insight about what actually happens in identifiable situations in education, such as in a classroom or in a school (Freebody, 2003; Hammersley, 1990). Ethnography is also commonly used in research on mathematics education (e.g., Millroy, 1992).

According to Burns (2000), ethnography tries to capture the complexity of "something" using multiple techniques instead of describing the ideal or imaginary condition. Ethnography aims to report this situation in a sensible way. Further, according to Wolcott (1988), ethnography attempts to discover what actually happens in real situations. Therefore, ethnography needs to investigate from inside the context, that is, in its natural setting. This means that the researcher, to some extent, may take part in daily activities in a chosen setting.

In contrast to typical quantitative methods, ethnography usually does not follow a pre-determined linear process (Burns, 2000; Wolcott, 1988). Therefore, it can only be planned beforehand in a general sense. The flexibility of ethnography becomes advantageous because it allows the researcher to capture the essence of social phenomena, which are usually very dynamic (Freebody, 2003). Ethnography can be conducted at single or multiple sites. The researcher needs to explore a site over time and raise new questions for further exploration (Freebody, 2003).

In ethnography, the researcher is directly immersed in the setting (Fetterman, 1989; Freebody, 2003). As such, as stated by Freebody (2003), two demands are placed on the ethnographic researcher: to act as an observer and data collector as well as a participant in the setting. This requires specific skills of the ethnographer as a key instrument within the study.

In this study, an ethnographic intervention was implemented. The term of *intervention* was used to indicate that in conducting this research, even though the researcher aimed to gain rich insight from inside naturally, the researcher particularly also intended to encourage a teacher to develop his professionalism by taking advantages of the internet.



This ethnographic intervention provided a more authentic PD (Professional Development) program and it was guided by the Five Characteristics Effective Professional Development (5cEPD) framework (Patahuddin, 2007). According to this 5cEPD framework, effective professional development: (1) is on-going; (2) is collaborative and aims to promote and connect participants in learning communities; (3) is student-oriented, focusing on student-centred approaches to teaching; (4) takes into consideration the individual teacher and his/her context; and (5) has as its prime focus the enhancement of pedagogical content knowledge. How this framework shaped the work of the researcher is discussed in this paper.

Design of the Study

Jack (anonymous) volunteered to take part in this study. He is a Year 2 teacher who had not made use of the Internet for professional development but had a willingness to do so.

I spent six months with Jack, visiting his classroom two to four days each week. Then I left his school but continued online communication. The purpose was to determine the extent to which Jack might use the Internet whilst I was not present. I returned to Jack's classroom after a break of approximately two months and stayed for a further two months. In total, I spent over 500 hours being a participant observer in Jack's classroom.

Multiple methods were used to gather data, namely questionnaire, interview, fieldnotes, written and non-written sources. The questionnaire and introductory interview were to gather information on his professional background, teaching approaches, the characteristics of the class environment, and to what extent he incorporates technology in general and the Internet in particular.

The questionnaires were supplemented by a face-to-face interview, with questions relating specifically to the items on the questionnaires. This interview was semi-structured, and occurred at the beginning of work with Jack. The semi-structured interview was for the purpose of seeking clarification of Jack's responses to the questionnaires. Unstructured interviews were implemented at strategic points throughout.

Fieldnotes were made by the researcher. These were supported by several videoed mathematics lessons. Informal discussions between Jack and researcher during and after classes were also documented.

Other data sources were printed and written sources. These included the mathematics syllabus, the ICT syllabus, notes about mathematical websites, and/or e-mail documents of professional communication. Non-written sources included lists of Internet "favourites" on the classroom computer and/or tracking of teachers' steps in using the Internet via the "history" in the websites.

Data analysis of this study referred to what Hammersley and Atkinson (2007) stated below.

In ethnography, the analysis of data is not a distinct stage of the research. In many ways, it begins in the pre-fieldwork phase, in the formulation and clarification of research problems, and continues through to the process of writing reports, articles, and books. Formally, it starts to take shape in analytic notes and memoranda; informally, it is embodied in the ethnographer's ideas and hunches (p.158).

An Ethnographic Intervention

My journey with Jack was not predetermined but emerged in response to my daily interactions with him, which were shaped by the research on effective professional

development programs using the Internet and the nature of the ethnographic approach. My aim was to assist Jack to reach the point where he would continue to develop his skills and expertise in using the Internet over time.

My work with Jack was characterised by five distinct phases. In Phase 1, at the beginning, I actively identified online resources and organised them into blogs, unobtrusively demonstrating a way of working with students in groups using the Internet, and showing directly several mathematical websites. My aim in Phase 1 was to capture Jack's interest in the use of the Internet for learning and teaching mathematics. In the second phase, Jack started to search for websites, sharing websites with other teachers, as well as presenting particular websites to other teachers in his school workshop. However, in this phase, Jack and I faced some challenges in facilitating the use of the Internet by students for their learning. Phase 3 was characterised by feelings of frustration. Jack seemed to think I was there to help the students in the classroom, leaving me feeling that, while I expected Jack to engage with the Internet, he wanted me to do it for him. I made a time to talk with Jack so that I could clarify the direction of my work. An outcome of this interview was me locating websites to match Jack's teaching program (Phase 4). This was a task I did not want to do. However, this received most positive feedback from Jack about my time in his classroom. In the last phase, after leaving Jack's classroom for about two months I continued e-mailing websites, but Jack did not reply to any of my e-mails. When I returned to his classroom, however, I found several significant changes in Jack's use of the Internet in his mathematics teaching.

Although it seemed that this teacher developed only slowly in his use of the Internet, if at all, the findings are significant in underscoring the non-linear, interactive and contingent nature of authentic professional development, particularly in finding appropriate time and methods in promoting the use of the Internet. Even though this authentic professional development program did not optimise Jack's use of the Internet as his learning and teaching tool, this research did support Jack to see and experience the potential of the Internet.

An Ethnographic Intervention with the 5cEPD Framework

This section discusses the study's substantive findings regarding this ethnographic intervention with the 5cEPD Framework.

Ongoing Professional Development

Effective professional development should be on-going (Abdal-Haqq, 1996; Little, 1993). The Internet can assist in this regard because its potential as a source of information and as a medium of communication enables teachers to find information anywhere, at any time. The Internet also enables teachers to communicate with other teachers, even allowing them to ask experts about teaching problems and issues. They do not have to wait for a workshop to get information and to share ideas with other teachers/educators (e.g., Dede, 2006; Stephens & Hartmann, 2004).

In relation to my work with Jack, there was evidence to show Jack continued his learning using the Internet. During my absence from his classroom, for example, Jack had explored websites I had identified for him (as he transferred them to the *Favourites* section of his computer). More exciting is the fact that, three months after completion of working with Jack, and during which time Jack had relocated overseas to another school, Jack emailed me, stating "I was just on your blog looking at some of your great resources." This

comment indicates that, after a significant period of time, he was still accessing the resources that I had compiled for him. These two positive signs are not sufficient to indicate clearly the longer term impacts of Jack's ongoing professional development strategies, but they provide evidence of a growing awareness of the professional development potential of the Internet for this individual teacher.

Despite these positive outcomes, one significant factor that inhibited and limited the process of ongoing professional development from a distance was my difficulty in establishing regular email communication with Jack, even though the Internet was available at his home and school. Emailing online resources to Jack often had uncertain results, particularly when Jack neither replied to my emails nor commented on the online resources provided. This demonstrates that, on the one hand, the Internet has much educative potential but on the other hand, using it can present new challenges to teachers. Having access to email involves additional work and time. Reading and replying to emails require time on the part of teachers who already have a busy schedule. The question is, under what conditions would teachers be able to benefit from accessing email?

Collaborative Professional Development

Many researchers claim that professional development is more effective when it is collaborative (e.g., Little, 1993; Wilson & Berne, 1999). One of the great potential advantages of the Internet is that it can be a tool for collaboration; for connecting teachers locally and globally to enable collaboration (e.g., Newell et al., 2002).

Effective professional development aims to promote and connect participants in learning communities (Abdal-Haqq, 1996; Little, 1993; Wilson & Berne, 1999). It must provide teachers with opportunities to interact with peers (Abdal-Haqq, 1996), and also to talk about specific subject matter, about students' learning, and about teaching (Wilson & Berne, 1999). It ensures collaboration by facilitating conversation among teachers which in turn leads to shared experience, shared investment in thoughtful development and a fair and rigorous testing of selected ideas (Little, 1993).

In designing the professional development program for Jack, I significantly considered the collaborative aspect. I attempted strategies such as seeking opportunities to connect Jack with existing online professional communities (e.g., Oz teacher and Math Forum). Jack appeared to work collaboratively, both with me or his colleagues, but hardly at all in the virtual world. Collaboration between Jack and myself was evident, for example, in the way investigative learning projects on multiplication were developed together. Jack's collaboration with his colleagues was illustrated on many occasions, such as when Jack and other Year 2 teachers worked together to plan their teaching program and when Jack shared information about websites in a workshop at his school and on several other occasions. However Jack seemed to find it more difficult to engage in online, rather than face-to-face, collaboration. It appeared that Jack much preferred the latter and this is supported by the following comment taken from a discussion with Jack:

From my experience, I don't think teachers at this school anyway would dedicate the time to do something online, because teaching, I suppose, is a social kind of job, not like a job in an office. I think, teachers value face-to-face interaction rather than using the computer for learning.

Given the supposed benefits of online collaboration, this finding raises the important issue of why Jack responded the way he did. Perhaps, the most intriguing issues to emerge are those of time, personal preference, and context. The personal situation of Jack, especially his busy schedule and his preference at this stage for face-to-face collaboration,

appeared to be the main factors for his not yet embracing the potential of the Internet as a collaboration tool for his professional development. In terms of his context, Jack was a beginning teacher who spent most of his time organising his teaching plans and he found in his school a very positive collaborative atmosphere among the teachers. I was available to support him directly. Jack may see little need to do online collaboration. Perhaps in a new situation, especially if he feels isolated, he may join a discussion group. It may be just a matter of time before Jack embraces the Internet as a tool for personal development because he lives in a growing digital environment.

Gibson and Oberg (2004) found that few teachers use the Internet for collaboration. The results of the present study may provide additional insight into the factors that influence the lack of teachers' use of the Internet to collaborate with others.

Student-oriented Professional Development

Teacher professional development is effective when student learning outcomes show improvement (Abdal-Haqq, 1996), hence professional development should be student-oriented in nature. The Internet can provide different learning resources to cater to different learning styles/ approaches. For example, the Internet provides virtual manipulatives, it can assist students visualise mathematical concepts, it provides a variety of representations of mathematical concepts, and it also provides mathematical games. Such a range of resources can assist teachers in understanding students' different learning approaches, and finding resources to cater to them.

My efforts in relation to Jack were designed to assist him to use the Internet to find professional resources compatible with both his instructional goals in mathematics and his students' needs. I worked with individual students using websites I had found and continually pointed out students' enthusiasm in learning mathematics when using the Internet. My work with students enabled me to identify different online learning resources that matched their strengths.

Jack's response was mixed. He attempted to use the Internet in his teaching, but this was through whole-class instruction and using the data projector.

... because I find it is easy with a data projector because you can do it for a whole class at once. And I think, they can all sit down, they can all see it rather than have them to use the computers. And then I think I prefer to do it that way then have the children back to their desks and doing an individual activity from there, like maths textbook or something from the board, as a consolidation because we only have four computers and I don't have time to supervise them all.

He wanted to allow students to work independently at the computers in their free time, but found that they needed continual assistance that he did not have time to give.

I've got four Internet programs, but some kids get to the end of the program and don't know what to do, or they have a problem, and then I have to stop what I am doing. Some times I am collecting notes and talking with kids and also trying to get my head around what I am trying to do for the day. I am getting my worksheets organised, or finding the roll, or doing million other things that need to be done. So, you know, having the computers there, having the games up for the kids to use, it's good but I don't have the time to really come over to them.

Jack indicated a willingness to engage students in learning with the Internet, but other factors appeared to inhibit him in such undertakings.

A positive aspect of student-oriented professional development is that I could directly locate Internet resources for individual students. Implementing the professional development model directly in Jack's classroom was a positive aspect, yet it did not have the desired effect. While many researchers argue that the Internet is a powerful tool for

enriching students' mathematics learning, many ICT professional development programs have failed to explain how teachers integrate what they learn in professional development programs into their classrooms (e.g., Gibson & Oberg, 2004; Gibson & Skaalid, 2004). Studies based on programs which take teachers outside of the classroom often fail to address the issue of compatibility with the actual characteristics of the students and their learning environment. The present research indicates the value of supporting teachers in their own classrooms. However, this is not sufficient, as offering new ideas to Jack seemed to compete with other classroom priorities and presented a challenge to his teaching style.

Considering the Individual Teacher and School Context

Borko, Mayfield, Marion, Flexer, and Cumbo (1997) and Abdal-Haqq (1996) suggested that professional development should take into consideration the classroom/school context of the teacher, and also treat teachers as active learners who construct their own understanding.

I made a conscious effort to treat Jack as an adult learner and a professional throughout this study, especially by valuing his constructive ideas. I often asked Jack's ideas/judgement on websites before offering them to students and he suggested several websites that I should offer to his groups of students. I also expressed my willingness to learn from Jack's experiences. In terms of context, I took note of the fact that Jack's classroom had four computers with good Internet connection but noted also they were rarely used by students for learning. I often thought of opportunities to propose the use of the Internet to enrich students' learning with students working in small groups at the connected computers. Also, knowing that Jack's school encouraged professional sharing among teachers, I suggested that Jack should share information about websites relevant to his mathematics teaching with other teachers teaching the same year levels and Jack responded positively, because he reported to me his websites presentation to other teachers in his school workshop.

However, considering the individual and the context proved to be very difficult in many ways. Understanding the individual teacher is a long process. Working with Jack for a period of approximately eight months, I had been gradually developing my understanding about him. I found that this changed over time. For example, on a critical occasion when I suggested that Jack could let students use the Internet during the morning period for free morning activities, I thought Jack could manage the activity as I had been giving him lists of websites relevant to his teaching programs. However, he found it too much of a challenge to organise the students. To sum up, this study suggests that understanding a teacher is not always a simple task and the level of understanding could influence the way we work with the teacher in a professional development program.

Enhancing Pedagogical Content Knowledge (PCK)

Effective professional development should enhance teachers' PCK, that is knowledge of multiple ways of representing mathematical content to students (Chick, Pham, & Baker, 2006). Little (1993) highlights that professional development should also focus on crucial problems of curriculum and instruction. The Internet can assist in this regard, through reading of other teachers' experiences, accessing professional reading material, discussing specific teaching problems with experienced teachers, or joining online conferences.

In my work with Jack, all strategies I used were part of my attempt to promote effective pedagogy in general, and PCK in particular such as teaching strategies for

promoting student learning of content. I did not have a specific or well-structured plan made in advance. Most strategies emerged as a result of ongoing observations and analyses of Jack's teaching context. For example, as I noticed that Jack often incorporated drill and practice, I suggested more investigative approaches and websites aimed at conceptual understanding and application of mathematical concepts. When I noticed Jack provided few activities that catered for various interest and ability needs of his students, I offered many different online resources for particular mathematical topics that he was teaching at the time. I also offered websites that contained some teaching ideas that had been developed by professional organisations.

Some positive changes were noted. We shared tasks in developing an investigative approach to teach multiplication. Jack's efforts in implementing an investigative approach led to discussions about the investigative problems and the ways technology could be integrated. Jack was seen to change some of his routines in the classroom. Jack was also seen to increase the use of the Internet as his own learning tool through his exploration of the websites I had listed in his program. However other aspects of enhancement were limited. Jack's undertaking of mathematics investigations resulted in children spending a lot of time drawing and colouring in rather than developing deep learning of multiplication concepts. Jack's notion of encouraging students to enjoy mathematics was through playing of games but his selection of games also seemed to provide little opportunity for deep learning. Jack's approach to assessment in mathematics was limited to tests of skills.

Despite these limitations, the aim to connect Jack to the educative potential of the Internet was partly achieved. It was always my expectation that he would take advantage of the Internet technology for his future professional learning, and the fact that he emailed me from his new school overseas "I was just on your blog looking at some of your great resources." suggested a continued use of the Internet that he may use in the future for greater individual professional development to challenge existing pedagogy and PCK.

Concluding Comments

In this study, the relationships between ethnography and 5cEPD are very strong. The 5cEPD is well-matched with the nature of ethnography. *Ongoing* professional development can be achieved since ethnography requires the researcher to conduct the study for a significant period of time. *Collaboration* is an element of 5cEPD and also a principle of ethnography, where the researcher who is living in the context must develop a good professional relationship with the participants and attempt to gain the trust of the teachers and students. A *student-oriented approach* can be applied since the researcher spends a great deal of time as a participant observer and getting to know students' characteristics and their mathematics learning needs. Additionally, *considering the individual and the context of the teacher* is possible to apply because the ethnographer must be inside the context. Lastly, *enhancing PCK* is the aim of this program. This process will be enhanced by the ethnographic research process, since observation and ongoing analysis of classroom practices for a protracted time enables the researcher to verify a teacher's actual understanding of concepts related to teaching. Thus, this design enables the researcher to gain access from the inside to the context and simultaneously to apply the 5cEPD.

This study further highlighted that teacher professional development is a complex issue. Even though the Internet-Authentic Professional Development Model was developed in consideration of the five characteristics of effective professional development (5cEPD), the model did not adequately explain some issues in the professional development process as I discussed more detail in the previous MERGA paper (Patahuddin, 2008).

Acknowledgement

This paper is a part of my PhD thesis at the University of Queensland, supervised by Prof. Merrilyn Goos and Dr. Shelley Dole.

References

- Abdal-Haqq, I. (1996). *Making time for teacher professional development*: ERIC Publications.
- Borko, H., Mayfield, V., Marion, S., Flexer, R., & Cumbo, K. (1997). Teachers' developing ideas and practices about mathematics performance assessment: successes, stumbling blocks, and implications for professional development. *Teaching and Teacher Education*, 13(3), 259-278.
- Burns, R. B. (2000). *Introduction to research methods* (4th ed.). Frenchs Forest, N.S.W.: Pearson Education.
- Chick, H. L., Pham, T., & Baker, M. K. (2006). Probing teachers' pedagogical content knowledge: Lessons from the case of the subtraction algorithm. In P. Grootenboer, R. Zevenbergen & M. Chinnappan (Eds.), *The 29th Annual Conference of the Mathematics Education Research Group of Australia (MERGA)* (Vol. 1). Canberra: MERGA Inc.
- Dede, C. (2006). *Online professional development for teachers: Emerging models and methods*. Cambridge: Harvard Education Press.
- Fetterman, D. M. (1989). *Ethnography. Step by step* (Vol. 17). Newbury Park, London, New Delhi: Sage Publications.
- Freebody, P. (2003). *Qualitative research in education: Interaction and practice*. London: Sage Publications.
- Gibson, S., & Oberg, D. (2004). Visions and realities of Internet use in schools: Canadian perspectives. *British Journal of Educational Technology*, 35(5), 569-585.
- Gibson, S., & Skaalid, B. (2004). Teacher professional development to promote constructivist uses of the Internet: A study of one graduate-level course. *Journal of Technology and Teacher Education*, 12(4), 577-592.
- Hammersley, M. (1990). *Classroom ethnography: empirical and methodological essays*. Philadelphia: Open University Press.
- Little, J. W. (1993). Teachers' professional development in a climate of educational reform. *Educational Evaluation and Policy Analysis*, 15(2), 129-151.
- Millroy, W. L. (1992). An ethnographic study of the mathematical ideas of a group of carpenters. *Journal for Research in Mathematics Education. Monograph*, 5, 1-210.
- Newell, G., Wilsman, M., Langenfeld, M., & McIntosh, A. (2002). Online professional development: Sustained learning with friends. *Teaching Children Mathematics*, 8(9), 505.
- Patahuddin, S. M. (2007). Encouraging a novice teacher to use the Internet in primary school mathematics. In L. C. Sam (Ed.), *The 4th East Asia Regional Conference on Mathematics Education (EARCOME 4)* (pp. 259-266). George Town, Penang: School of Educational Studies, Universiti Sains Malaysia.
- Patahuddin, S. M. (2008). Use of the Internet for teacher professional development and for teaching mathematics: supports and inhibitors. In M. Goos, R. Brown & K. Makar (Eds.), *The 31st Annual Conference of the Mathematics Education Research Group of Australia (MERGA)* (Vol. 2, pp. 399-405). Brisbane: MERGA Inc.
- Stephens, A. C., & Hartmann, C. E. (2004). A Successful professional development project's failure to promote online discussion about teaching mathematics with technology. *Journal of Technology and Teacher Education*, 12(1), 57-73.
- Wilson, S. M., & Berne, J. (1999). Teacher learning and the acquisition of professional knowledge: An examination of research on contemporary professional development. *Review of Research in Education*, 24, 173-209.
- Wolcott, H. F. (1988). Ethnographic research in education. In R. M. Jaeger (Ed.), *Complementary methods for research in education* (pp. 187-249). Washington, DC: American Educational Research Association.

Exploring the Relationship between Mathematical Modelling and Classroom Discourse

Trevor Redmond
AB Paterson College
<trd@abpat.qld.edu.au>

Joanne Sheehy
AB Paterson College
<jsy@abpat.qld.edu.au>

Raymond Brown
Griffith University
<ray.brown@griffith.edu.au>

This paper explores the notion that the discourse of the mathematics classroom impacts on the practices that students engage when modelling mathematics. Using excerpts of a Year 12 student's report on modelling Newton's law of cooling, this paper argues that when students engage with the discourse of their mathematics classroom in a manner that promotes the communication of ideas, they employ mathematical modelling practices that reflect the cyclical approaches to modelling employed by mathematicians.

Knowing what mathematics to use in a problem situation, knowing when to use it and how to use it are powerful expressions of mathematics competence (National Council of Teachers of Mathematics 2000). However in some classrooms, students' development of mathematics competence is limited to working out of a text book where the answers are provided and little opportunity is given to making thinking visible (Boaler, 2001). As a consequence some students are not given the opportunity to see the expression of mathematics competence as being relevant to out of classroom experiences. Using mathematical modelling to explore mathematics empowers students by allowing them to engage meaningfully with multiple contexts of mathematics use (Galbraith, 1995). Mathematical modelling requires making ideas visible. When thinking is made visible, ideas are able to be revisited for the purpose of making them consistent with the requirements of the task and consistent with the conventions of the mathematics being employed. For the purpose of this paper we adopt Galbraith's (1989) definition of 'open' mathematical modelling which refers to the entire process of doing the mathematics leading from formulating the original problem situation to designing a mathematical model to validate thinking. In short, this approach to mathematical modelling may be said to embody the following cyclical practices (a) making assumptions, (b) formulating questions, (c) developing and interpreting solutions, (d) verifying models, and (e) reporting, explaining, and predicting results (Galbraith, 1989).

Theoretical Framing

Learning in mathematics is a social activity (Schoenfeld, 2002). When students are provided with an appropriate task, a suitable structure to interact with that task, and scaffolded in their interactions with each other, a form of classroom discourse may be brought about where students are provided with multiple opportunities to construct sophisticated understandings of a mathematics concept or procedure. Within such classroom discourse, the understanding that is demonstrated by an individual student becomes part of the collective understanding of the group (Wertsch, 2002). However, when undertaking an assessment task it is generally accepted that the understanding that is demonstrated is that of the individual. While there are a variety of tools that can be used to assess understanding that range from formal examinations to group projects, the authoring of individual mathematical reports that can be worked on over a period of time and that encourage students to conference with their peers, teachers and others, is an important mechanism for assessing student understanding. In most instances the final product of such



an authoring process is accepted as an individual representation by the student of their analysis of a task and a report of their synthesis of strategies for dealing with the task and the mathematical assumptions upon which conclusions are based. However, even though the end product is accredited to an individual student the process of authoring that product is inherently social, as the student often has discoursed drafts of the work with the teacher and with peers. What is of interest to this paper is how the discourse of the classroom may be evidenced in the authoring of an individual mathematical report.

Method

The *school context* referred to in this study is a metropolitan P-12 College that has a mathematics programme from Year 6 through to Year 12 with a major focus on mathematical modelling. Using the framework, ‘Teaching for Understanding’ (Perkins, 1992), the mathematics department of this College has identified a sequence of generative topics that are explored to develop an understanding of mathematical concepts using mathematical modelling. The Year 12 classes referred to in this paper comprised female and male students studying the Queensland Studies Authority Mathematics B curriculum.

Task content focused on an individual mathematical report given to Year 12 classes of students. The task asked students to use the practices of mathematical modelling to investigate Newton’s Law of Cooling. The task is represented in Figure 1.

Task Content

Newton’s law of Cooling states:

The rate at which a body cools is proportional to the difference between the temperature of the body and the temperature of the surroundings.

In this task you are to investigate this statement and determine what it means from a practical point of view.

You will investigate a situation that directly relates to this statement by looking at an experiment that contains a ‘hot mass’, and using the N-Spire and temperature probe or thermometer collect the data of a mass cooling.

As part of the investigation, you will be required to analyse the data you collected, decide on the most appropriate model for this data set and build an equation for that model.

You will then use this information to investigate the Newton’s Law of Cooling.

In addition, you are required to identify the set of attributes required for Newton’s Law of Cooling to hold true.

Figure 1. The task.

The task was an out-of-class task enacted over a 6-week period designed to provide summative feedback to students regarding their competence in developing a mathematical model.

Pedagogical context focused on Collective Argumentation (CA) (Brown & Renshaw, 2000). Students in the Year 12 classes reported in this paper were encouraged to engage in CA when doing mathematics. CA is an approach to teaching and learning that is based on five interactive principles. The first principle, the ‘generalisability’ principle, requires that students stop and think about the problem that has been posed in terms of what mathematical concepts and procedures might be useful in building a solution. Students are encouraged to make links with prior knowledge, procedures and understandings. Initially these links may not be strong but as the discussion with the other members of the group and the teacher occur in this and later stages of the process there are opportunities for these links to be strengthened. The second principle, the ‘objectivity’ principle, requires that ideas, relevant to the task are objectified and communicated to other members of the group.

Third, the ‘consistency’ principle requires that ideas which are contradictory to each other or that belong to mutually exclusive points of view must be resolved through discussion. The fourth principle is ‘consensus’. Consensus requires that all members of the group understand the agreed approach to solving the problem. If a member of the group does not understand a concept or procedure, there is an obligation on that student to seek clarification, and a reciprocal obligation on the other group members to assist. Finally, in implementing the fifth principle, ‘recontextualisation’, students re-present the group response to the class for discussion and validation. The principles of CA are used by teachers and students to guide engagement in the discourse of their mathematics classrooms. The aim of this discourse is to enable students to analyse mathematical tasks, to synthesise strategies to undertake those tasks, and to communicate solutions and conclusions to others. This paper explores how the discourse of Year 12 classrooms may be evidenced in the authoring of one student’s report that required her to model generalisations developed from investigating Newton’s Law of Cooling. The report of this student (Jane) was chosen for analysis because Jane had been exposed to the Principles of CA when doing mathematics for a number of years and regularly used those principles to engage in the discourse of her Year 12 mathematics classroom.

Analysis of Segments of Student Work

The analysis focuses on Jane’s first draft of her mathematical report. As Jane had been exposed to the Principles of CA to engage in the discourse of her classroom for a number of years, the analysis looked for evidence of her incorporating the principles of CA into her mathematical report. We will not be considering the report in total but, due to word constraints, consider sections which link to the principles - Generalisability, Objectivity, Consistency, Consensus, Recontextualisation.

Generalisability

Jane begins her draft report by detailing what she understands the task to involve (see Figure 2). She outlines the process she is going to employ to investigate Newton’s Law of Cooling. That is, Jane evidences the principle of Generalisability, as she clarifies her understanding of the task and details the approach she is going to adopt. She represents the task from a practical point of view. In doing so, Jane identifies the variables of room temperature, temperature of the probe, and the temperature of the cup, as being important. In the report, Jane does not disclose why she considers these variables to be the ones that need to be controlled, out of the many that are available, but she does indicate procedures that she is going to adopt in an attempt to control them.

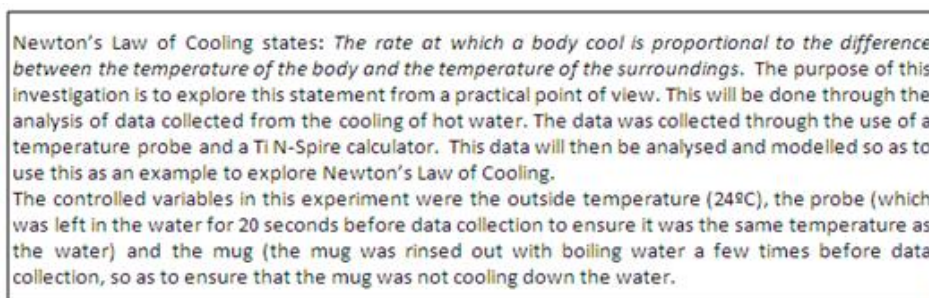

Newton's Law of Cooling states: *The rate at which a body cool is proportional to the difference between the temperature of the body and the temperature of the surroundings.* The purpose of this investigation is to explore this statement from a practical point of view. This will be done through the analysis of data collected from the cooling of hot water. The data was collected through the use of a temperature probe and a Ti N-Spire calculator. This data will then be analysed and modelled so as to use this as an example to explore Newton's Law of Cooling.

The controlled variables in this experiment were the outside temperature (24°C), the probe (which was left in the water for 20 seconds before data collection to ensure it was the same temperature as the water) and the mug (the mug was rinsed out with boiling water a few times before data collection, so as to ensure that the mug was not cooling down the water.

Figure 2. Identifying variables.

As seen in Figure 2, Jane has chosen to use graphing calculator technology and a temperature probe to collect data. The use of technology and probe were identified in the task as one method Jane could use to collect data, but, in the end, was a choice she made. Jane's choice of technology provides a clue as to the thinking that Jane is employing. In identifying the variables that need to be controlled and by indicating her choice of the technological tool that she is going to use to assist her investigation, Jane has established a way of thinking and operating about the task. This way of thinking and operating is consistent with the principle of Generalisability that she has been encouraged to use, over a number of years, to direct her initial thinking about a task so that she can engage in the discourse of her mathematics classroom. Through identifying variables and indicating her preferred tool of representation, Jane is able to enter into discussion with others about the task, ask questions of others, share ideas with others, and to monitor her understanding. Jane has also provided a representation of her thinking that can be compared with others who may have highlighted or de-emphasised the same variables and use of technology. As such, Jane's way of initially thinking and operating is consistent with the practice of mathematical modelling that requires a mathematician to formulate assumptions and procedures upon which to base an investigation. This consistency is again demonstrated as Jane objectifies her thinking about the task (see Figure 3).

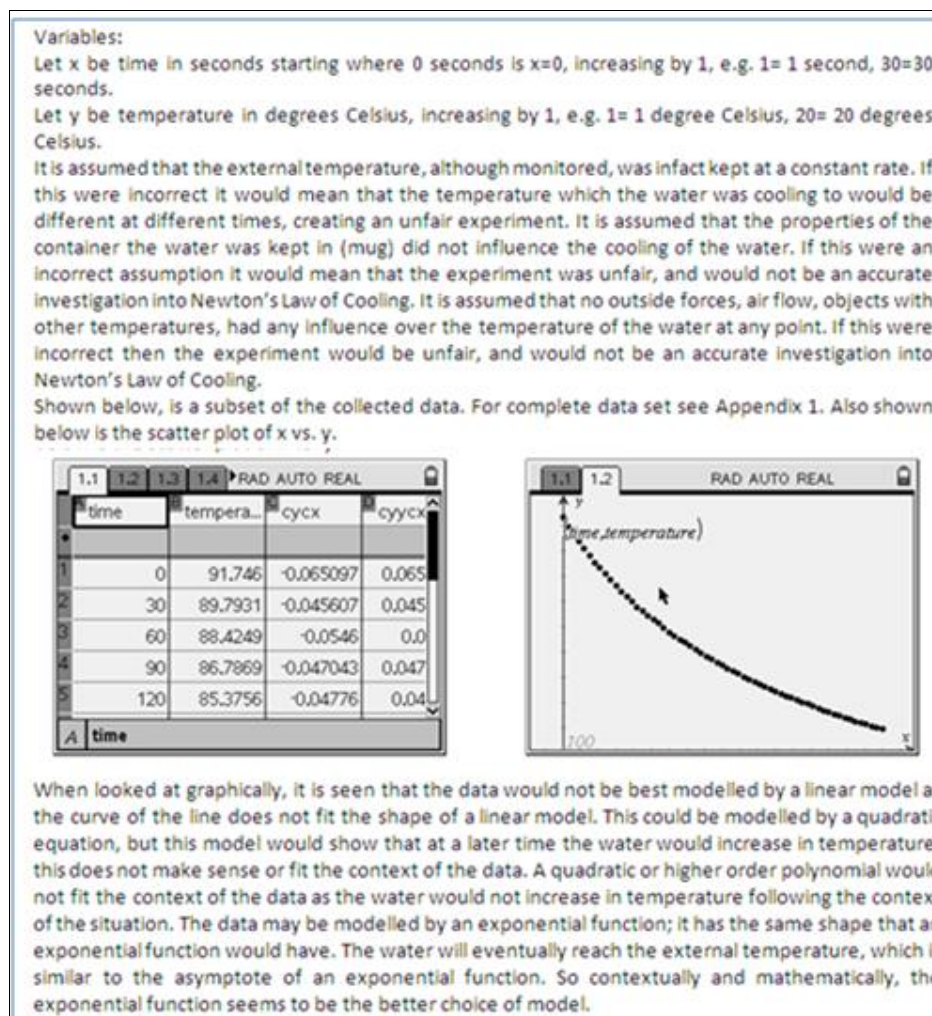

Figure 3. Contextualising thinking.

Objectivity

As seen in Figure 3 Jane has contextualised her thinking about the task to the context of a ‘fair experiment’. That is, Jane situates her thinking and the procedures within the practices of a ‘fair experiment’ comparing what she does to the scientific assumptions upon which a ‘fair experiment’ is based so as to keep her investigation on track. In many ways Jane compares her ideas with the practices of a scientific experiment and explains those comparisons using the practices of mathematics.

In this way, Jane takes her work from the individual to the social plane of reasoning, allowing herself to see what is the same and what is different about her ideas and submitting her ideas to practices that may assist her to view her thinking and procedures from an objective perspective.

This objectivity sets her up for not submitting a report that just looks authoritative, but is authoritative according to the practices of mathematics. In other words, the approach that Jane has taken speaks to the mathematical modelling practice of formulating and solving and requires her to engage in repeated cycles of attaining consistency within her thinking about and doing the mathematical report (see Figure 4).

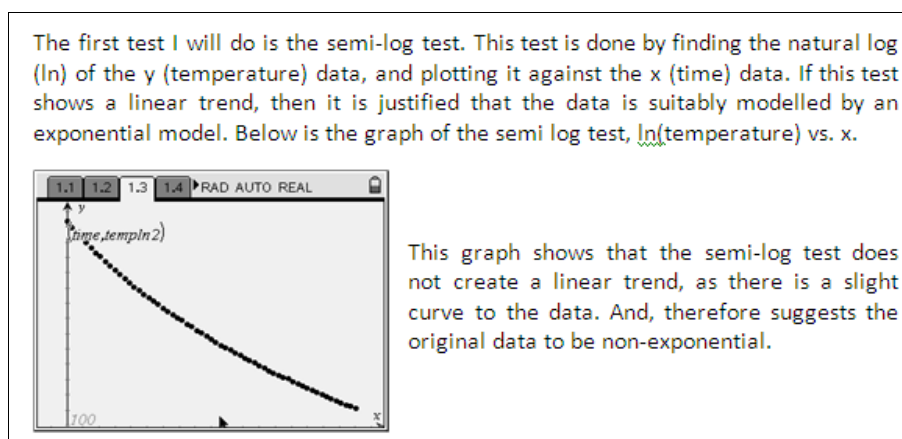

Figure 4. Testing the data.

Consistency

Within Figure 4 we can see the principle of Consistency operating as Jane gathers and shares evidence about the data fitting an ‘exponential’ model that satisfies disciplinary constraints. However, in order to satisfy the principle of consistency, Jane needs to justify her ideas and to become conscious of ways of modelling the data that may better fit task requirements. We see this happening in Figure 4 as Jane becomes conscious of “a slight curve” that suggests the “original data to be non-exponential”.

In the process, Jane allows her processes of thought as well as the product of her thinking to become visible and open to change. This relates to the modelling practice of interpreting which Jane pursues as she tries to gain consensus between her thinking and the thinking of the mathematical community as represented by her teacher (see Figure 5).

Consensus

After feedback Jane re-represents her ideas by comparing the change in the values of y divided by change in the values of x versus y graph, noting that the data “follows a linear

trend”. Jane then verifies this trend by representing a “linear regression of the data”. In other words, through questioning her own thinking, Jane conducts further inquiry and attains a consensus between her thinking about the task that is based on understanding. In this way, Jane takes the display of her thinking from the individual to the collective plane of functioning as she attempts to use the language of mathematics to express and to verify her thinking. This shift from the individual to the collective is verified in Jane’s use of language as she uses the pronouns ‘us’ and ‘we’, attempting to regain consistency (see Figure 6) in her thinking – a practice that relates to the modelling practice of verifying.

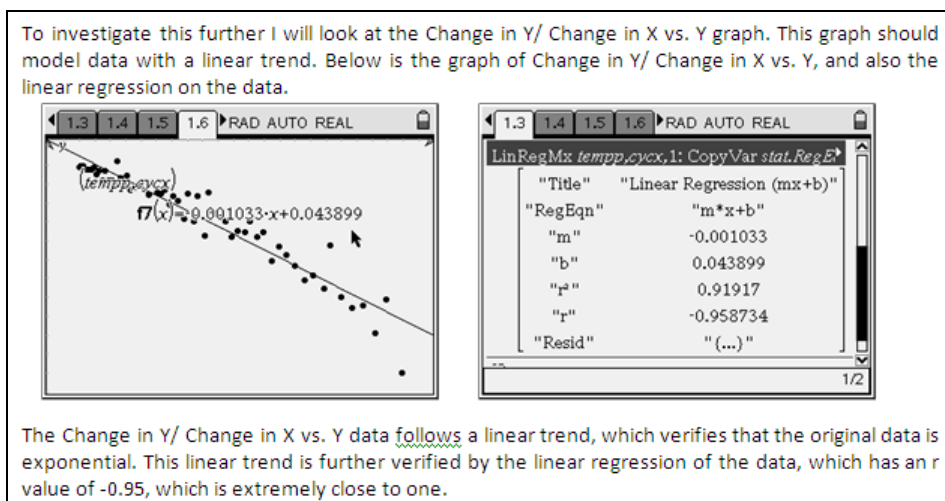

Figure 5. Verifying thinking.

The Change in Y/Change in X vs. Y verifies that the original data can be accurately modelled by a linear function, and also indicates to us that there was some error in the semi-log test. This could be that the asymptote is not 0 for the data, which is not yet accommodated for, by the semi-log test. We controlled the outside temperature to be 24° C, so this should be the asymptote. However, even after manipulation to the semi-log test to accommodate for an asymptote of 24° C, the graph did not show linear trend. Therefore to find the asymptote of the data I will use the equation $d = \frac{M_1 \cdot y_2 - M_2 \cdot y_1}{M_1 - M_2}$. (For how this equation was found see appendix 2.)

When these variables are substituted for values we get the final equation to be:

$$y_1 = 91.746$$

$$y_2 = 89.7931$$

$$d = \frac{(-0.00103 \cdot 91.746 + 0.0439) \cdot 89.7931 - (-0.00103 \cdot 89.7931 + 0.0439) \cdot 91.746}{(-0.00103 \cdot 91.746 + 0.0439) - (-0.00103 \cdot 89.7931 + 0.0439)}$$

$$= 42.6214$$

This is done for all values of y, and all are found to have the same asymptote of 42.6214. This value is extremely different from the controlled value of 24° C. This however may be explained in that the water was kept in a mug, and thus only a small amount of the water was being cooled by the air. Also this air would also have been heated by the heat escaping from the water.

Figure 6. Rethinking the asymptote.

Consistency Revisited

In attempting to regain consistency in her thinking, Jane declares that there “was some error in the semi-log test” and attributes this error to the value of the asymptote. Jane then

represents the task in the form of the graph substituting values to find a value for the asymptote using the data and the graph of change in Y divided by change in X versus Y.

However, the value for this asymptote is unexpected. Jane then attempts to make this value consistent with the re-representation of her thinking about the task by explaining the value in terms of the “small amount of the water being cooled by the air” and the transfer of heat. Through re-engaging the principle of consistency to guide her investigation, Jane is regulating her attention to the requirements of the task, conceptualising the task within a different set of assumptions and integrating her ideas with scientific understandings. This integration assists Jane to re-gain consensus in her thinking (see Figure 7).

Consensus Revisited

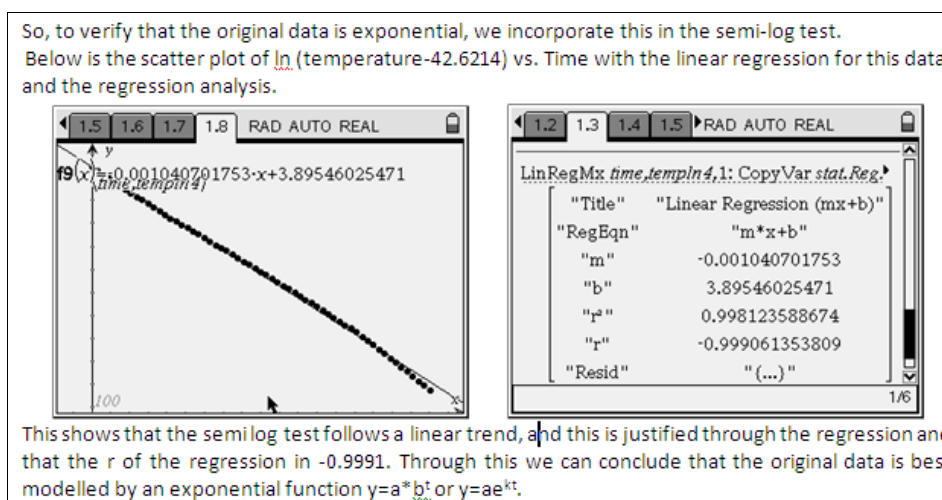

Figure 7. Validating thinking.

Jane’s incorporation of the new asymptote into the semi-log test allows Jane to gain consensus between her original representation and her re-representation of the task. In the process, Jane verifies her original approach to doing the task and surrenders the idea that the data is non-exponential. The re-representation of the temperature versus time plot and the construction of the regression analysis reflect her developing understanding of the task. In the process, Jane, again uses the pronoun ‘we’, acknowledging that her report goes beyond herself to incorporate the discourse of her Year 12 classroom.

Conclusion

This paper explores the notion that the discourse of the mathematics classroom impacts on the practices that students engage when modelling mathematics. The student whose report was analysed represented her approach to doing mathematical modelling as being one that displayed practices that were congruent with those employed by mathematicians. However, in the process of informing those practices, Jane situated herself within a collective, that is, the discourse of her Year 12 classroom. Through situating herself within this discourse Jane produced a report that not only represented her thinking about the investigation in an objective manner, but a report that evidenced engagement in repeated cycles of consistency and consensus. As such it could be expected that through providing students with access to classroom discourses (e.g., Collective Argumentation) that

privilege the cyclical practices of mathematical modelling, such practices would be evidenced in the reviewing and editing that students make public when authoring drafts of assessment reports. Such reviewing and editing processes may not only provide insights into student competency, but also insights into the way students represent their engagement with the discourse of their mathematics classroom. For Jane, her draft report would suggest that she is an active participant in the discourse of her mathematics classroom. Whether this relationship between student authoring of assessment reports and their participation in discourse holds true for students other than Jane is a question for further research.

References

- Boaler, J. (2001). Mathematical modelling and new theories of learning. *Teaching Mathematics and its Applications*. 20(3), 121-127.
- Brown, R.A.J., & Renshaw, P.D. (2000). Collective argumentation: A sociocultural approach to reframing classroom teaching and learning. In H. Cowie and G. van der Aalsvoort (Eds.), *Social interaction in learning and instruction: The meaning of discourse for the construction of knowledge* (pp. 52-66). Amsterdam: Pergamon Press.
- Galbraith, P. (1989). From applications to modelling. In D. Blane & M. Evans (Eds.), *Mathematical modelling for the senior years* (pp. 78-86). Parkville: The Mathematical Association of Victoria.
- Galbraith, P. (1995). Assessment in mathematics: Developments, innovations and challenges. In L. Grimison & J. Pegg (Eds.) (1995). *Teaching secondary school mathematics*. (pp. 289-314). Sydney: Harcourt Brace.
- National Council of Teachers of Mathematics (NCTM). (2000). *Principles and standards for school mathematics*. Reston, VA: Author. Retrieved from <http://www.standards.nctm.org>.
- Perkins, D.N. (1992). *Smart schools: Better thinking and learning for every child*. New York: The Free Press.
- Schoenfeld, A.H. (2002) A highly interactive discourse structure. In J. Brophy (Ed.), *Social constructivist teaching: Its affordances and constraints* (Volume 9 of the series *Advances in Research on Teaching*) (pp. 131-170). New York: Elsevier.
- Wertsch, J. V. (2002). *Voices of collective remembering*. New York: Cambridge University Press.

Assessing the Number Knowledge of Children in the First and Second Grade of an Indonesian School

Rumi Rumiati

PPPPTK Matematika¹⁾

<r.rumiati.10@scu.edu.au>

Robert (Bob) Wright

Southern Cross University

<bob.wright@scu.edu.au>

An assessment approach from Mathematics Recovery was used to document the number knowledge of 20 first-graders and 20 second-graders in an Indonesian school. Sixteen first-graders were at the advanced-counting-by-ones stage and fourteen second-graders were facile. As well, fifteen first-graders and eleven second-graders were at the level of an intermediate concept of 10. Other findings were nine of the second-graders used the erroneous 'subtract smaller from larger bug' and five first-graders used Jarimatika (Chisanbop). Results are discussed in light of the literature.

An important part of teaching children well is first to understand if they already have some degree of number knowledge. Vygotsky's theory of learning, related to his notion of the Zone of Proximal Development (Vygotsky, 1978), proposes that students learn best if they are challenged within close proximity to, and slightly above, their current level of development. However, in Indonesia, teachers seldom begin teaching number by considering children's current number knowledge. They emphasize the teaching of procedures, such as the standard written algorithm, rather than developing children's strategies (Marsigit, 2004).

There are many studies in the English language literature that investigate children's number knowledge (e.g. Clarke, 2006; Gervasoni, 2007). However, research studies involving Indonesian children are rare. This paper reports a study that aimed to document the number knowledge of first- and second-graders in an Indonesian school including their strategies used to solve number problems. This paper also aims to identify possible ways of improving the teaching of early number in Indonesian schools.

Literature Review

The emphasis on detailed assessment as a basis for teaching has strongly influenced recent initiatives in early number learning by several school systems, especially in English speaking countries. In Australia, drawing on the work of Wright, the developer of Mathematics Recovery (MR) (Ewing-McMahon, 2000), several systemic initiatives have been implemented to change the approach to instruction in number in the early years (Perry & Dockett, 2007). These include *Count Me in To* in New South Wales, the *Early Numeracy Program* in Victoria and the *New Zealand Numeracy Development Project* (Bobis, Clarke, Clarke, Thomas, Wright, Young-Loveridge & Gould, 2005). The assessment approach used in the MR program has been acknowledged as distinctive and enables detailed documentation of children's current number knowledge (Williams, 2008).

A model of stages in strategies in early arithmetical learning (Steffe & Cobb, 1988) and a model of levels in base-ten arithmetical strategies (Cobb & Wheatley, 1988) have been adapted by the Mathematics Recovery Program to document children's progress in arithmetical learning. This study used an assessment theory, technique and tools developed and used in this program (Wright, Martland & Stafford, 2006).



Method

Study site

The study was conducted in an elementary school in Yogyakarta, Indonesia. The school is a co-educational Islamic-based private school catering for children from the first to the sixth grade. The data was collected in February and March 2009, around the middle of the second half of the Indonesian school year. There were 167 children in the first grade and 172 children in the second grade.

Participants

All children in the first and second grades were given a one-minute basic number facts test for addition and one for subtraction adapted from Westwood (2000). In each class, the children were listed from the highest to the lowest score on this test. Then the children were divided into five groups with approximately equal numbers in each group. The first group contained the highest listed and so on. One child from each group was selected by the teachers and asked whether they agreed to be interviewed. If a child refused, then another child from his/her group was selected, and so on until for each group, there was a child who agreed to be interviewed. In total there were 20 first (11 boys and 9 girls) and 20 (9 girls and 11 boys) second grade children who agreed to be interviewed. Their parents' consent was sought. The mean age of the first-graders was 7 years and of the second-grades was 7 years 11 months. All the interview sessions were videotaped. During the selection and data collection process, the Australian Human Research Ethics Committee guidelines about recruiting children for research were strictly followed.

Interview

The interview consists of two parts. The first part, strategies in early arithmetical learning was conducted to determine children's stages in early arithmetical learning, and the second part, base ten arithmetical strategies was conducted to determine children's level in base-ten arithmetical strategies.

Stages of Early Arithmetical Learning (SEAL). The SEAL model used in MR is adapted from Steffe and Cobb (1988). The SEAL sets out a progression of stages in early arithmetical learning. The child is asked to solve number problems involving collections of counters, which may be screened. An addition task for example, involves presenting 7 red counters and 5 blue counters, screening the collections and asking how many counters there are altogether. The interviewer observes how the child solves the problem. If the child is unsuccessful, the counters are unscreened. If the child is successful, their strategy is noted. Furthermore, the child's stage is determined using the model shown in Table 1.

Base Ten Arithmetical Strategies (BTS). The BTS model used in MR is adapted from Cobb and Wheatley (1988). Three types of tasks are presented; ten and ones tasks using ten-dot strips, uncovering board tasks and horizontal written number sentences. For the first two types, the interviewer observes whether the child increments by tens or counts on. For the horizontal written number sentences such as $42+23$ (no-carry addition), $38+24$ (carry addition), $26-12$ (no-borrow addition) and $41-24$ (borrow addition), the interviewer observes the child's strategies. Furthermore, the child's level is determined using the model shown in Table 2.

Table 1
The model for stages of early arithmetical learning

Stage	Name of stage	characteristic
0	Emergent	Cannot count visible items
1	Perceptual	Can count visible items only.
2	Figurative	Can count invisible items, but starts from one.
3	Advanced-counting-by-ones	Can count invisible items, using a counting-on strategy to solve addition or missing addend tasks, and may use a counting-back strategy (counting back-from or counting-back-to) to solve missing subtrahend or removed items tasks.
4	Facile	Can use non-counting-by-one strategies, such as doubles, add through ten, compensation, etc.

Adapted from Wright, et al., 2006

Table 2
The model for the development of base-ten arithmetical strategies

Level	Level	characteristic
1	Initial concepts of ten	Not able to see ten as a unit composed of ten ones. The child solves tens and ones tasks using a counting-on or counting-back strategy.
2	Intermediate concepts of ten	Able to see ten as a unit composed of ten ones. The child uses incrementing and decrementing by tens, rather than counting on by ones to solve an uncovering board task. The child cannot solve addition and subtraction tasks involving tens and ones when presented as horizontal written number sentences.
3	Facile concepts of ten	Able to solve addition and subtraction tasks involve tens and ones when presented as horizontal written number sentences by adding and/or subtracting units of ten and ones.

Adapted from Wright, et al., 2006

Data Analysis

The videotapes were reviewed and transcribed. The transcriptions consisted of descriptions of the child's words and actions during the interview. The transcriptions were written in Indonesian language and then translated to English language. Based on the transcriptions, a description of each child's strategies was written and general insights about their strategies were noted. Furthermore, each child's stage and level were determined using the models in Tables 1 and 2. Notes were made about distinctive features of each child's strategies. Two phenomena related to children's number knowledge emerged during the data analysis. These are the use of an erroneous algorithm called the 'subtract smaller from larger bug' (Brown & Van Lehn, 1982) and the use of the Jarimatika (chisanbop) method (Wulandari, 2004). These phenomena are discussed in detail in the results and discussion section.

Results and Discussion

Table 3 shows the numbers of first- and second-graders at each stage. No children were found to be in the emergent, perceptual or figurative stages. Two explanations of this are: 1) The interview was conducted in February-March and the school started in July of the previous year. Thus first-graders were already in the elementary school for eight months and second-graders for one year and seven months. As well, children were in the kindergarten school for at least one year before starting elementary school. So, they were used to solve number problems without seeing real objects. 2) In the first semester of first grade, children were taught one-digit addition. In an informal discussion the teacher said she taught the children about counting-on. She taught that the easiest way to do one-digit addition such as $7+5$ is by saving 7 in their head, making 5 with their fingers and then counting on, 8,9,10,11,12. Thus the children in the study had already been taught a count-on strategy. Sixteen of the 20 first-graders and six of the 20 second-graders were in the advanced-counting-by-ones stage while four first-graders and 14 second-graders were in the facile stage. Children in the facile stage solved most of the tasks quickly or used a non-count-by-ones strategy such as using doubles or an adding through ten strategy.

Table 3
The numbers of first- and second-graders at each stage of early arithmetical learning

Stage	Name of Stage	First grade	Second grade
0	Emergent	0	0
1	Perceptual	0	0
2	Figurative	0	0
3	Advanced-counting-by-ones	16	6
4	Facile	4	14

Table 4
The numbers of first- and second-graders at each level of base ten arithmetical strategies

Level	Name of level	First Grade	Second Grade
1	Initial concepts of ten	5	4
2	Intermediate concepts of ten	15	11
3	Facile concepts of ten	0	5

Table 4 shows the numbers of children at each level of base ten arithmetical strategies. Fifteen first-graders and 11 second-graders were at the intermediate concepts of ten level, that is they were able to see ten as a unit composed of ten ones but were not yet facile in solving written number tasks. Five second-graders were able to solve successfully all types of addition (no-carry and with-carry) and subtraction written tasks (no-borrow and with-borrow) mentally, and were judged to be at the facile concepts of ten level. No first-graders were judged to be at this level. This is to be expected because at the time of the interviews, the first-graders were just starting to learn two-digit addition and subtraction in class, while the second-graders had already learnt this topic.

Among the five second-graders, three children successfully imagined the standard column algorithms for addition and subtraction. One child used a jumping strategy (N10)

and one child used a splitting strategy (1010) (Beishuizen, 1993). Data analysis also showed that 11 second-graders used an erroneous algorithm, and nine of these used ‘the smaller from larger bug’ in which, for example they say that $31-23=12$ or $41-24=13$. Three first-graders who had already learned the standard written algorithm at home also used this erroneous algorithm.

Further findings were that many children used fingers, and across the children there were several strategies. To solve $7+5$ for example, some children directly opened 7 fingers and continued counting 8, 9, 10. When they ran out of fingers they closed all fingers and then opened two fingers sequentially. Other children simultaneously opened five fingers and closes them sequentially, saying 8, 9, 10, 11, 12. The first example shows that some children re-used their fingers to symbolise numbers above 10. This is the same as the method used by Korean children as reported by Fuson and Kwon (1992). For some first-graders use of fingers seems to be like a vestige. As well, five first-graders used the Jarimatika method. This involves using fingers to count as learned in an out-of-school course, along with other strategies. Some children were confused when their result using Jarimatika differed from their result using another strategy.

An erroneous algorithm ‘the subtract smaller from larger bug’

‘The subtract smaller from larger bug’ has been identified by many researchers as one of the errors frequently made by children (e.g. Young & O’Shea, 1981; Brown & VanLehn, 1982; Ashlock, 1982). The teaching of the standard written algorithm has been identified as a factor which contributes to this error. This has led to the suggestion to defer the teaching of standard written algorithms until later years of schooling, and to wait until children have a strong conceptual understanding of tens and ones. In the early years it is better to support children to invent their own algorithms (Kamii, 1998).

Netral is a first-grader who has already learned the no-carry and carry addition standard written algorithms at home. He solved $42+23$ by adding 2 and 3, and then 4 and 2, and solved $38+24$, by adding $8+4=12$ (counting with fingers), adding 1 to the result of $3+2$ and then answering 62. He solved $26-12$, by subtracting 2 from 6 and 1 from 2. When asked to solve $31-23$, he tried to use the same strategy. However, he was confused when trying to subtract 3 from 1. He changed his answer 3 times, saying that $1-3=2$, $1-3=3$ and $1-3=0$. Given that he had not learned a procedure for borrow-subtraction problems, his three answers seemed meaningful to him. However, it seems that he was not satisfied with these answers. His case indicates that he used the erroneous algorithm ‘the subtract smaller from larger bug’ because he had been taught the standard written algorithm for addition, and tried to use it to solve subtraction problems. Use of these algorithms may constrain a child’s ability to reflect on the ten structure of the number system (Ebby, 2005). Working from the right (ones), Netral seems unaware of the tens value of the digits on the left side.

Limas, a second grader who had already been taught all of the standard written algorithms for addition and subtraction, used the erroneous algorithm ‘the subtract smaller from larger bug’ without hesitation because in her opinion this was the easiest way to find the answer. This finding accords with that of Hatano, Amiwa and Inagaki (1996) that even though children already know the ‘correct’ procedure, the buggy algorithm could be an attractive variant to save them from a long meaningless procedure. Furthermore, Limas also said that the easiest way to solve two-digit addition and subtraction is to work from right (the ones) to left as told by her teacher, instead of working from left to right which children who invent their own strategy usually do (Thompson, 1994). This finding suggests that Limas prefers to use the standard written method, which was taught by her teacher

instead of using her own thinking. This is likely to have serious consequences for her overall mathematics achievement in the future.

Use of the Jarimatika method by the first-graders

Jarimatika or Chisanbop is an abacus-like method (Sun, 2008) of doing basic arithmetic attributed to a Korean tradition, in which the numbers 1 to 9 are symbolised by fingers on the right hand (Figure 1), and the numbers 10 to 90 are symbolised similarly using the fingers on the left hand. Using two hands, one can display any number from 1 to 99, and perform addition or subtraction by closing and opening the fingers.

1 2 3 4 5 6 7 8 9

Figure 1. Fingers representation for numbers 1 to 9 (adapted from Wulandari, 2004)

To carry out an addition such as $21+55$ (Figure 2), first 21 is symbolised, then both thumbs are opened (55). The result can now be read on both hands as 76.

\longrightarrow \longrightarrow
 21 +55 76

Figure 2. Addition $21+55$ using the Jarimatika method (adapted from Wulandari, 2004)

When there are not enough fingers to complete addition or subtraction, the method involves the use of complementary numbers of 5 (called little friends) and 10 (called big friends). Therefore children have to be facile with combinations of 5 and 10. To carry out $9+4$ for example (Figure 3), children recall that the big friend of 4 is 6, so they have to open the forefinger of the left hand which symbolises 10, and close the thumb and little finger of the left hand which symbolises 6. In this way the task $9+4$ is changed to $9+10-6$.

\longrightarrow \longrightarrow
 9 +4 13

Figure 3. Addition using Jarimatika method (adapted from Wulandari, 2004)

Rahman, a first grader who has learned Jarimatika in an out-of-school course, consistently made mistakes for one-digit addition such as $7+6 (=14)$, $8+7 (=10)$ and $6+7 (=15)$. Only once did he solve an addition task correctly and quickly. This was $5+6$. He said that he knows $5+5=10$ and then add one more. He kept changing between the Jarimatika method and other strategies, and his answer did not indicate reflective thinking.

His case is similar to Nitas. As shown in the following excerpt, Nitas, a first-grader who had learned Jarimatika and also the standard written algorithm at home, seems confused about which of those methods to use.

- Interviewer : So, how would you solve this (show card 31–23)?
Nitas : (She tries to use Jarimatika. She stops her attempt and suddenly say the answer) 12.
Interviewer : How did you get 12?
Nitas : I used the way mom taught me.
Interviewer : How?
Nitas : $3-2=1$, $1-3=2$
Interviewer : How about the way you are taught in the Jarimatika course?
Nitas : She tries to use Jarimatika again but fails and is back to her previous answer) 12
Interviewer : Please take time, and try again by using the Jarimatika method.
Nitas : (She uses Jarimatika, and she looks hesitant) 8.
Interviewer : So, according to Jarimatika the answer is 8, and according to mom's method the answer is...
Nitas : 12.
Interviewer : Which one is the correct answer?
Nitas : 12

The cases of Rahman and Nitas suggest that the Jarimatika method and the standard algorithms can be confusing and inhibit children from using intuitive reasoning. Rahman who showed an ability to use his own reasoning to answer $5+6$, relied on using his taught Jarimatika method, without considering whether it produces the correct answer. While in Nitas's case, it is clear that she doesn't use intuitive reasoning at all. Rather, she merely attempts to recall methods taught to her.

Conclusion

The results show that the first- and second-graders in this study already have some degree of arithmetical knowledge. Most first graders were in the advanced-counting-by-ones stage in which they are able to solve number problems using a counting-on or a counting-back strategy. Most second graders were in the facile stage in which they can solve number problems using a non-counting-by-ones strategy. Most of them are also able to see ten as a unit composed of ten ones but are not yet facile in two-digit addition and subtraction problems. Their strategies were influenced by the teaching approaches used in their school, home and out-of-school number lessons, which did not always positively enhance their reasoning and problem solving ability.

The first grade of Indonesian schools, includes teaching of the standard written algorithms to solve two-digit no-carry addition and no-borrow subtraction and in the second grade, two-digit carry-addition and borrow-subtraction are taught. Researchers have warned about the harmful effects of teaching algorithms in the early years when children have not developed adequate understanding about tens and ones. The findings of this research accord with this, and indicate that instead of teaching procedures or algorithms, teachers should facilitate children's development of their own strategies and reasoning (Beishuizen & Anghileri, 1998; Kamii, 1998).

Furthermore, the findings from this study do not support the teaching of the Jarimatika method to young children. Similar to teaching standard written algorithms in the first and second grade, teaching the Jarimatika method to children at those grade levels may confuse them and tend to inhibit their use of reflective thinking and their ability to develop strategies which are meaningful to them.

References

- Ashlock, R. B. (1982). *Error patterns in computation* (3rd ed.). Columbus, Ohio: Charles E. Merrill.
- Beishuizen, M. (1993). Mental strategies and materials or models for addition and subtraction up to 100 in Dutch second grades. *Journal for Research in Mathematics Education*, 24, 294-323.
- Beishuizen, M. & Anghileri, J. (1998). Which mental strategies in the early number curriculum? A comparison of British Ideas and Dutch Views. *British Education Research Journal*, 24, 519-538.
- Bobis, J., Clarke, B., Clarke, D., Thomas, G., Wright, R., Gould, P., et al. (2005). Supporting teachers in the development of young children's mathematical thinking: Three large scale cases. *Mathematics Education Research Journal*, 16(3), 27-57.
- Brown, J. S., & VanLehn, K. S. (1982). Towards a generative theory of "bugs". In T. P. Carpenter, J. M. Moser & T. A. Romberg (Eds.), *Addition and subtraction: A cognitive perspective* (pp. 117-135). Hillsdale, NJ: Erlbaum.
- Clarke, B. (2006). The mathematical knowledge and understanding young children bring to school. *Mathematics Education Research Journal*, 18(1), 78-102.
- Cobb, P., & Wheatley, G. (1988). Children's initial understanding of ten. *Focus on learning problems in mathematics*, 10(3), 1-26.
- Ebby, C. B. (2005). The powers and pitfalls of algorithmic knowledge: A case study. *The Journal of Mathematical Behavior*, 24(1), 73-87.
- Ewing McMahan, B. (2000). Scaffolding: A suitable teaching characteristic in one-to-one teaching in Maths Recovery. In Bana, J. and Chapman, A., (Eds.), *Proceedings of the 23rd Annual Conference of the Mathematics Education Research Group of Australasia*, Vol. 1, 417-23. Perth: MERGA
- Fuson, K. C., & Kwon, Y. (1992). Korean children's single digit addition and subtraction: numbers structured by ten. *Journal for Research in Mathematics Education*, 23, 148-165.
- Gervasoni, A. (2007). Children's number knowledge in the early years of schooling. In J. Watson & K. Beswick (Eds.), *Mathematics: essential research, essential practice* (Proceedings of the 30th annual conference of the Mathematics Education Research Group of Australasia, Hobart, Vol. 1, pp. 317-326). Adelaide: MERGA.
- Hatano, G., Amaiwa, S., & Inagaki, K. (1996). "Buggy algorithms" as attractive variants. *The Journal of Mathematical Behavior*, 15(3), 285-302.
- Kamii, C. (1998). The harmful effect of algorithms in grade 1-4. In L. J. Morrow & M. J. Kenney (Eds.), *The teaching and learning algorithm in school mathematics, Yearbook 2008*. Reston, VA: NTCM.
- Marsigit. (2004). *Mathematics program for international cooperation in Indonesia*. Retrieved from http://www.criced.tsukuba.ac.jp/pdf/08_Indonesia_Marsigit.pdf
- Perry, B., & Dockett, S. (2007). Early childhood mathematics education research: what is needed now? In J. Watson & K. Beswick (Eds.), *Mathematics: Essential research, essential practice* (Proceedings of the 30th annual conference of the Mathematics Education Research Group of Australasia, Hobart, pp.870-874). Adelaide: MERGA.
- Steffe, L. P., & Cobb, P. (1988). *Construction of arithmetical meanings and strategies*. New York: Springer-Verlag.
- Sun, H. (2008). Chinese young children's strategies on basic addition facts. In M. Goos, R. Brown, K. Makar, (eds). *Navigating current and charting direction*. (Proceedings of the 31th annual conference of the Mathematics Education Research Group of Australasia, Brisbane). Adelaide: MERGA.
- Thompson, I. (1994). Young children's idiosyncratic written algorithms for addition. *Educational Studies in Mathematics*, 26 (323-345).
- Vygotsky, L. (1978). *Mind in society: the development of higher psychological processes*. Cambridge, MT: Harvard University Press.
- Westwood, P. (2000). *Numeracy and learning difficulties: Approach to teaching and assessment*. London: David Fulton
- Williams, P. (2008). *Intervention in mathematics in primary schools*. UK: Department for children, schools and families.
- Wright, R. J., Martland, J., & Stafford, A. K. (2006). *Early numeracy: assessment for teaching and intervention*. London: Paul Chapman Publishing/Sage.
- Wulandari, S. P. (2004). *Jarimatika: penambahan dan pengurangan*. Jakarta: Kawan Pustaka.
- Young, R. M., & O'Shea, T. (1981). Error in children's subtraction. *Cognitive Science*, 5, 153-177.

Enactivism and Figural Apprehension in the Context of Pattern Generalisation

Duncan Samson
Rhodes University
d.samson@ru.ac.za

This paper seeks to establish a research framework for an investigation into the extent to which pupils are able to visualise figural cues in multiple ways within the context of pattern generalisation. Enactivism, along with the constructs of knowledge objectification and figural apprehension, are identified as forming an ideal theoretical framework for such a study. Although largely theoretically driven, this paper also presents results from an initial pilot study in order to contextualise the theoretical milieu.

Numerous mathematics educationalists and researchers have advocated a multiple representational view of pattern generalisation within the classroom - not only to explore the notion of *equivalence*, but to encourage pupils to critically engage with the underlying physical structure of the pictorial context as seen from alternative viewpoints.

By way of example, a typical pedagogical strategy is to suggest various equivalent algebraic expressions for the general term of a pictorial pattern. Pupils are then encouraged to arrive at plausible explanations for each expression by referring to the physical structure of the provided context. Figure 1 illustrates a typical example.

Shape 3 Shape 5

Look at the diagrams shown above. Shape 3 requires 11 matchsticks while shape 5 requires 17 matchsticks.

(a) Write down an algebraic formula that will determine how many matchsticks are needed to build the n^{th} shape.

(b) Terry says the formula is $2(n+1) + n$ while Jeff says the formula is $1 + 3(n-1) + 4$.
By referring to the diagram, explain how Terry and Jeff arrived at their respective formulae.

Figure 1. A typical question encouraging a multiple representational view of pattern generalisation.

While such a pedagogical approach may be useful for some pupils, for others it may well create additional complications. Not only is there an inherent ambiguity in the structure of the algebraic expressions – in the above example, $2(n+1)$ represents 2 multiples of $(n+1)$ matches while $3(n-1)$ represents $(n-1)$ multiples of 3 matches – but an additional cognitive burden is placed on pupils who write algebraic expressions in non-standard format (e.g., $n \times 3$ as opposed to $3n$).

This paper approaches multiple representations from a more fundamental level, and seeks to investigate the extent to which pupils are able to visualise figural cues in multiple ways within the context of pattern generalisation. A literature review reveals that very little empirical research has been done in this area. This paper forms part of a broader study which seeks ultimately to shed light on the embodied processes that either assist or hinder

pupils' abilities to visualise figural cues in multiple ways within the context of pattern generalisation.

Visualisation

Visually mediated approaches to pattern generalisation tasks set within a pictorial context provide for an interesting interplay between two different modes of visual perception: sensory perception and cognitive perception (Rivera & Becker, 2008). These different modes resonate with Fischbein's (1993) theory of figural concepts, and the notion that all geometrical figures (or *figural objects*) possess, simultaneously, both conceptual and figural properties. Mariotti (as cited in Jones, 1998) stresses the dialectic relationship between figure and concept as an important interaction in the field of geometry, a relationship that can create tension from a student's perspective. It is suggested that a similar tension is likely to underlie visual strategies applied to pattern generalisation tasks set within a pictorial context.

In an attempt to elucidate this visual tension, primary importance will be placed on the notion of figural *apprehension* as espoused by the French psychologist Raymond Duval (1995). Although Duval's notion of figural apprehension was developed within a more classical geometry context, it can, with only slight modifications, be adapted readily to other contexts involving geometrical figures. Four different modes of apprehension of a figure are pertinent to this paper - perceptual, sequential, discursive and operative.

Perceptual apprehension refers to the initial apprehension of a figure - what we see in a perceived figure at first glance as determined by the unconscious integration of Gestalt laws of figural organisation. *Sequential apprehension* relates to the emergence of sub-figures or elementary figural units, which stem from either the construction of the perceived figure, or a description of its construction. *Discursive apprehension* is a process of perceptual recognition during which certain gestalt configurations gain prominence due to an association with discursive statements accompanying the geometric figure. *Operative apprehension* relates to the various ways by which a given figure can be modified while retaining the properties of the figure, for example by a reconfiguration of the whole-part relation through a recombination of elementary figural units.

Figure 2 shows possible outcomes for each of the four modes of figural apprehension based on the given visual stimulus. Perceptual apprehension subdivides the given figure into squares and triangles based on the Gestalt laws of closure and good form. This could potentially lead to a complicated algebraic expression for the general term, which would need to take into account overlapping matches: $T_n = 4n - (n - 1) + 3(2n) + 6 - (2n + 2)$. Sequential apprehension could arise from noticing that the construction of each subsequent term requires the insertion of a 7-match additive unit. This has the potential to yield the general expression $T_n = 7n + 5$. Discursive apprehension may be invoked by accompanying the visual stimulus with the wording "for 2 squares you need a total of 19 matches", thus foregrounding the structural unit of the square. This could potentially yield the general expression $T_n = 4n - (n - 1) + 2(2n + 2)$ where, after counting squares and adjusting for overlapping units, the remaining matches are seen as V-shapes around the perimeter. Finally, operative apprehension may allow the visual stimulus to be seen in terms of horizontal lines, vertical lines, V-shapes above and below, and a constant 2 matches at either end. Expressed algebraically, this yields $T_n = 2n + (n + 1) + 4n + 4$.

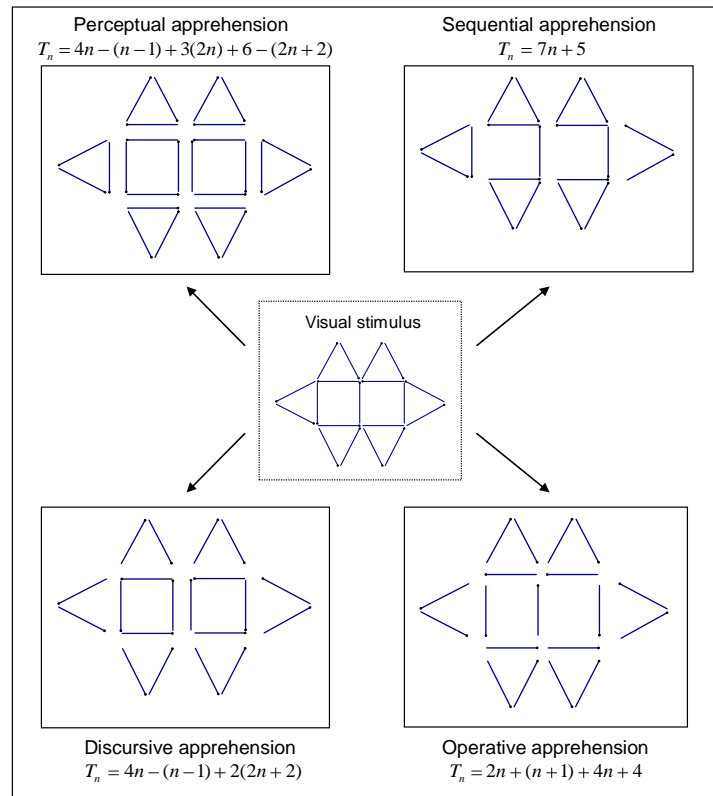

Figure 2. Possible outcomes for different modes of figural apprehension.

Duval (1998) makes the pertinent point that most diagrams contain a great variety of constituent gestalts and sub-configurations – far more than those initially identified through perceptual apprehension, or those made explicit through construction or accompanying discursive statements. Critically, it is this surplus that constitutes the *heuristic power* of a geometrical figure since specific sub-configurations may well trigger alternative solution paths.

Within the context of pattern generalisation, perceptual apprehension may on occasion be sufficient to generalise a given figural pattern. However, perceptual apprehension will not necessarily evoke gestalts, which are appropriate to the generalisation process. An inability to move beyond mere perceptual apprehension of a figure can lead to what Duval (1999) refers as *heuristic deficiency*. In order to actualise the heuristic potential of a diagram it is necessary not only to be aware of the scope of the diagram but also to be able to use it flexibly. Being able to see a diagram in multiple ways thus necessitates a move beyond perceptual apprehension. From a cognitive standpoint, this raises an important question: What are the embodied processes that either hinder or assist pupils in moving flexibly between different modes of apprehension?

Within the context of figural pattern generalisation, the processes of visualisation and generalisation are deeply interwoven. Pattern generalisation rests on an ability to *grasp* a commonality from a few elements of a sequence, an awareness that this commonality is applicable to *all* the terms of the sequence, and finally being able to use it to articulate a direct *expression* for the general term. There are two important aspects of this notion of generalisation: (a) a *phenomenological* element related to the grasping of the generality, and (b) a *semiotic* element related to the sign-mediated articulation of what is noticed in

the phenomenological realm (Radford, 2006). The research methodology and underpinning theoretical framework need to be sensitive to both these aspects of figural pattern generalisation. Enactivism along with the theoretical construct of *knowledge objectification* (Radford, 2008) have been identified as ideally meeting this critical requirement.

Enactivism

Enactivism is a theory of cognition that draws on ideas from ecology, complexity theory, phenomenology, neural biology, and post-Darwinian evolutionary thought. The basic tenet of enactivism is that there is no division between mind and body, and thus no separation between cognition and any other kind of activity. Enactivist theory brings together action, knowledge and identity so that there is a conflation of doing, knowing, and being (Davis, Sumara, & Kieren, 1996). Within an enactivist framework, cognition is not seen as a representation of an external world, but rather as “an ongoing bringing forth of a world through the process of living itself” (Maturana & Varela, 1998, p. 11). Thus, cognition is viewed as an embodied and co-emergent interactive process where the emphasis is on *knowing* as opposed to *knowledge*.

For the enactivist, the act of perceiving something is not a process of recovering properties of an external object rather, “perception consists of perceptually guided action” (Varela, as quoted in Lozano, 2005, p. 26). Thus, we perceive things in a certain way because of the manner in which we relate to them through our actions (Lozano, 2005). This idea is succinctly stated in Maturana and Varela’s 1998 aphorism: “*All doing is knowing, and all knowing is doing*” (p. 26). Thus, knowledge depends on “being in a world that is inseparable from our bodies, our language, and our social history – in short, from our *embodiment*” (Varela et al., 1991, p. 149). For Varela et al. (1991), who build on Merleau-Ponty’s phenomenology, it is critical that we see our bodies as both physical (biological) structures as well as lived, phenomenological structures. Thus, *embodiment* has an important double sense: “it encompasses both the body as a lived, experiential structure and the body as the context or milieu of cognitive mechanisms” (Varela et al., 1991, p. xvi).

As Davis (1995) comments, language and action are not merely outward manifestations of internal workings, but rather they are “visible aspects of ... embodied (enacted) understandings” (p. 4). For Davis et al. (1996), enactivism prompts us not only to consider the formal mathematical ideas that emerge from action, but to give close scrutiny to those preceding actions – “the unformulated exploration, the undirected movement, the unstructured interaction, wherein the body is wholly engaged in mathematical play” (p. 156). As Núñez, Edwards and Matos (1999) argued, the nature of situated cognition cannot be fully understood by attending only to the social and contextual factors. Learning and thinking are also situated “within biological and experiential contexts, contexts which have shaped, in a non-arbitrary way, our characteristic ways of making sense of the world” (Núñez, Edwards, & Matos, 1999, p. 46).

From an enactivist stance the perception of a given figural cue is not merely a visual process. Rather, perception needs to be considered as a fully *embodied* process. It is thus vital that the research methodology, both in terms of data capture and data analysis, takes appropriate cognizance of this embodied notion of perception. It is this issue that the following section seeks to address.

Perception and Knowledge Objectification

Perception is a complex cognitive activity related to the *manner* of our acquaintance with the objects of perception, in other words the *activity* that mediates our experience with objects (Radford, Bardini, & Sabena, 2007). An interrogation of the *embodied* processes of perception thus needs to focus on the phenomenological realm of students' experience in order to emphasize the subjective dimension of knowing (Radford, 2006). Radford (2008) refers to the process of making the objects of knowledge apparent as *objectification*, a multi-systemic, semiotic-mediated activity during which the perceptual act of noticing progressively unfolds. The objects, tools, linguistic devices and signs used by individuals in social meaning-making processes to achieve a stable form of awareness, he refers to as *semiotic means of objectification*. Such semiotic means of objectification could include: Words and linguistic devices; metaphor and metonymy; gestures; rhythm in speech and gesture; graphics and the use of artefacts.

Such a multi-semiotic view of knowledge objectification takes cognisance of the *principle of non-redundancy*, the notion that different semiotic systems allow for different forms of expressivity (Radford, 2006). In addition, it displays an enactivist sensitivity for the process of objectification in which the interplay of a variety of semiotic means/systems is seen to have a fundamental role in knowledge formation and in which cognitive activity is seen as being "... embodied in the corporality of actions" (Radford et al., 2007, p. 508). The theoretical construct of knowledge objectification is thus ideally suited to an enactivist theoretical framework in which there is a purposeful conflation of *doing*, *knowing*, and *being*.

Of particular interest to the research project are those pivotal moments when pupils move between different modes of apprehending a given figural pattern. By means of careful analysis of the data stemming from various semiotic means, this research seeks ultimately to characterise and provide rich descriptions of these pivotal moments.

Methodology

This study is oriented within the conceptual framework of qualitative research, and is anchored within an interpretive paradigm. The research makes use of an instrumental case study approach, the research participants being a mixed gender, high ability Grade 9 class of approximately 25 learners from an independent school in Grahamstown, South Africa. This non-probability purposive sampling is supported by experience from previous research (Samson, 2007), which suggests that high ability learners are more likely to constitute "information-rich cases" (Patton, 1990, p. 169) given the data collection protocol and the nature of the patterning tasks under consideration.

From an enactivist methodological stance, this study is characterised by the use of multiple perspectives and the continuous refinement of methods and data analysis protocols over both time and form (e.g., audio-visual data examined repeatedly in different forms (video and transcript) and in conjunction with additional data retrieved from field-notes and participants' worksheets). The use of multiple data sources and approaches to data handling is in turn a form of triangulation.

Results

In an initial pilot study, individual participants were provided with two non-consecutive terms of a figural pattern and were asked to provide, in the space of one hour, different visually mediated expressions for the n^{th} term of the pattern. The pilot study

the structure in terms of n matches along the bottom and $n-1$ matches along the top, and the \surd portion of his expression was in fact an algebraic simplification of $2n-1$. Grant went further to describe the $[n-1]$ as representing the “top gap-filling matches”, a metaphorical visualisation of the spaces created between the inverted V-shapes formed by the two central series of parallel matches. Grant then re-wrote his expression for the n^{th} term as $n+n+n+[n-1]$.

There seems to be an interesting tension between two different modes of operative apprehension as evidenced by Grant’s semiotic means of objectification of his general expression. Figural modification has been accomplished by means of a recombination of various elementary figural units in two different ways. Although Grant ultimately presented the expression $n+n+n+[n-1]$ as being representative of his visual perception of the figural pattern under investigation, his initial formula was \surd . Although he maintained that he had written \surd as an algebraic simplification of $n+[n-1]$, the $2n-1$ may well have been unconsciously inspired by his original counting procedure in which the rhythmical pairing of the top and bottom matches was central in alerting him to the non-paired match in the bottom row.

Concluding Comments

It was the purpose of this paper to establish a research framework for an investigation into the extent to which pupils are able to visualise figural cues (objects with both spatial properties and conceptual qualities) in multiple ways within the context of pattern generalisation. Enactivism, along with the construct of knowledge objectification, were identified as forming an ideal theoretical framework for such a study, while the notion of figural apprehension proved central in elucidating visual tension. An initial pilot study revealed that some pupils have a surprising facility to visualise figural cues in multiple ways, while a meta-analysis of research participants’ semiotic activity proved particularly revealing in terms of the process of visualisation.

The cognitive significance of the body has become one of the major topics in current psychology. Furthermore, the use of multiple representations has been acknowledged as playing a central role in problem solving, the learning and understanding of mathematical ideas, and the development of a deeper appreciation for the interconnections between mathematical concepts. By focusing on issues of visualisation and pattern generalisation, central components of mathematical activity, this study adds to an important pedagogical discourse by engaging with the critical notion of mathematical accessibility. Hamilton (2006) comments that, “... learning refers to transformations that expand the learner’s potential range of actions” (p. 4). Pedagogical insights gleaned from the broader study seek ultimately to empower pupils with appropriate strategies to interpret figural patterns in multiple ways by moving flexibly between different modes of apprehension, thus creating the potential for just such transformations.

Acknowledgement

The financial assistance of the National Research Foundation (NRF) towards this research is hereby acknowledged. Opinions expressed and conclusions arrived at are those of the authors and are not necessarily to be attributed to the NRF.

References

- Davis, A. B., Sumara, D. J., & Kieren, T. E. (1996). Cognition, co-emergence, curriculum. *Journal of Curriculum Studies*, 28(2), 151-169.
- Davis, B. (1995). Why teach mathematics? Mathematics education and enactivist theory. *For the Learning of Mathematics*, 15(2), 2-9.
- Duval, R. (1995). Geometrical pictures: Kinds of representation and specific processings. In R. Sutherland & J. Mason (Eds.), *Exploiting mental imagery with computers in mathematics education* (pp. 142-157). Berlin: Springer.
- Duval, R. (1998). Geometry from a cognitive point of view. In C. Mammana & V. Villani (Eds.), *Perspectives in the teaching of geometry for the 21st century* (pp. 37-52). Boston: Kluwer.
- Duval, R. (1999). Representation, vision and visualization: Cognitive functions in mathematical thinking. Basic issues for learning. In F. Hitt & M. Santos (Eds.), *Proceedings of the 21st Annual Meeting of the North American Chapter of the International Group for the Psychology of Mathematics Education, Volume 1* (pp. 3-26). Cuernavaca, Morelos, Mexico.
- Fischbein, E. (1993). The theory of figural concepts. *Educational Studies in Mathematics*, 24(2), 139-162.
- Hamilton, M. (2006). *Enactivism: a theory of learning for the 21st century*. Retrieved April 11, 2008, from http://www.emr.vic.edu.au/Downloads/Enactivism_theory_learning.doc
- Jones, K. (1998). Theoretical frameworks for the learning of geometrical reasoning. *Proceedings of the British Society for Research into Learning Mathematics*, 18(1&2), 29-34.
- Lozano, M. D. (2005). Mathematics learning: Ideas from neuroscience and the enactivist approach to cognition. *For the Learning of Mathematics*, 25(3), 24-27.
- Maturana, H. R., & Varela, F. J. (1998). *The tree of knowledge: The biological roots of human understanding* (Rev. ed.). Boston, MA.: Shambhala.
- Núñez, R. E., Edwards, L. D., & Matos, J. F. (1999). Embodied cognition as grounding for situatedness and context in mathematics education. *Educational Studies in Mathematics*, 39, 45-65.
- Patton, M. Q. (1990). *Qualitative evaluation and research methods* (2nd ed.). Newbury Park, CA: Sage.
- Radford, L. (2006). Algebraic thinking and the generalization of patterns: A semiotic perspective. In S. Alatorre, J. L. Cortina, M. Sáiz, & A. Méndez (Eds.), *Proceedings of the 28th Annual Meeting of the North American Chapter of the International Group for the Psychology of Mathematics Education, Volume 1* (pp. 2-21). Mérida, Mexico: Universidad Pedagógica Nacional.
- Radford, L. (2008). Iconicity and contraction: a semiotic investigation of forms of algebraic generalizations of patterns in different contexts. *ZDM Mathematics Education*, 40(2), 83-96.
- Radford, L., Bardini, C., & Sabena, C. (2007). Perceiving the general: The multisemiotic dimension of students' algebraic activity. *Journal for Research in Mathematics Education*, 38(5), 507-530.
- Rivera, F. D., & Becker, J. R. (2008). Middle school children's cognitive perceptions of constructive and deconstructive generalizations involving linear figural patterns. *ZDM Mathematics Education*, 40(1), 65-82.
- Samson, D. A. (2007). *An analysis of the influence of question design on pupils' approaches to number pattern generalisation tasks*. Unpublished master's thesis. Rhodes University, Grahamstown.
- Varela, F. J., Thompson, E., & Rosch, E. (1991). *The embodied mind: Cognitive science and human experience*. Cambridge, MA.: MIT Press.

Mathematics Registers in Indigenous Languages: Experiences from South Africa

Marc Schäfer
Rhodes University
<m.schafer@ru.ac.za>

Through reporting on an initiative in South Africa that aimed to provide epistemological access to teachers and learners of mathematics (and science) through translating mathematical concepts into two indigenous languages, this paper argues for the urgent development of mathematical registers in indigenous languages for mathematics and science. The pilot research reported on in this paper indicates that the use of a multilingual concept literacy book impacted noticeably on the code-switching practices of selected teachers who switched between English and Xhosa in their teaching of mathematics.

It goes without saying that the understanding of key concepts in mathematics and science is fundamental to the teaching and learning of these disciplines. Research confirms that one of the key dimensions to understanding concepts is language. The intimate relationship between language and the understanding of concepts is well documented. For example, the poor performance of South African learners in the 1995 and 1999 Trends in International Mathematics and Science Study (TIMSS) is largely ascribed to the problem that learners and teachers have in studying and teaching through English as a second or even third language.

To address this problem a multilingual learning and teaching resource and support book (Grade 9 – 10 levels) was developed at the Centre for Applied Language and Literacy Studies and Services in Africa (CALLSSA) at the University of Cape Town in collaboration with Rhodes University and the University of KwaZulu Natal. The book provides detailed meanings and explanations for key mathematics and science concepts in Zulu, Xhosa, Afrikaans, and English. It is argued that when learners and teachers have access to these concepts in their own languages, they can transfer such understanding to their dealing with English as the language of learning and teaching (LoLT). The book was validated through a collaborative process involving the three universities. The validation process was enhanced by a research process of trialling and evaluating the book with practicing teachers in their classroom setting. This *inter alia* included an investigation of:

1. the accuracy of the concept explanations in the four languages used;
2. the appropriateness of the translations;
3. the general effectiveness of the book as a learning and teaching resource.

The research involved the participation of Grade 10 teachers in the Western Cape, Eastern Cape, and KwaZulu Natal of South Africa. This paper aims to share some of the experiences encountered in the development of this book by briefly describing the development process and the content of the resource book, and also highlighting some of the research issues that were encountered with special reference to code-switching practices as a central pedagogical strategy in many South African classrooms. Against the backdrop of each South African child's constitutional right to be taught in the language of his/her choice, this paper argues for the urgent development of mathematics (and science) registers in indigenous languages.



Concept Literacy – a Brief Theoretical Discussion

The problem of language proficiency as an obstacle to learning mathematics and science is well documented (Adler, 2001; Howie, 2002; Setati, 2005). Young, van der Vlugt and Qanya (2004) suggest that this problem can be addressed at two inter-related levels: (a) concept understanding and use, and (b) language/discourse contexts and forms in which these concepts are embedded.

The notion of *concept literacy* that framed the development of the multilingual resource book can be described as “understanding, through reading, writing and appropriate use, basic learning-area specific terms and concepts in their language contexts” (Young et al., 2004). Kilpatrick, Swafford and Findell (2001), describe conceptual understanding as a critical component of mathematical proficiency that is necessary for anyone to learn mathematics successfully. Conceptual understanding implies an understanding of knowledge that not only revolves around isolated facts but includes an understanding of the different contexts that frame and inform these facts. Kilpatrick et al. (2001) suggest that, “students with conceptual understanding ... have organized their knowledge into a coherent whole, which enables them to learn new ideas by connecting those ideas to what they already know” (p. 118). The framework of interwoven strands of mathematical proficiency in Kilpatrick’s model identifies conceptual understanding as one of the strands that is essential to the development of understanding mathematical concepts, operations, and relations.

But what is a concept? The idea of a concept is controversial and difficult to define. It ranges from a personal idea or construct to a statement that is universal and generic. The definition that underpins the development of the multilingual resource book under scrutiny, suggests that a concept is a “mental picture which has a standard and universally accepted meaning” (Young et al., 2004). Similarly, the notion of literacy is difficult to pin down as it no longer simply refers to the ability to read and write. Young et al. (2004) argue that literacy implies a capacity to recognise, reproduce and manipulate the conventions of text, spoken and written, shared by a given community. Concept literacy therefore emphasises the interaction between context and content. It is a process that is dynamic and that changes over time as the concept is internalised and understood. From a Vygotskian and constructivist perspective this implies that concept literacy involves the modification of prior conceptions and experience. Fundamental to this process is of course language proficiency. Young et al. (2004) correctly argue that it is therefore likely that modifying one’s prior knowledge if one is learning in an additional language (a language other than the first language) can be problematic, particularly if one is not proficient in that additional language.

Although Kilpatrick et al. (2001) suggested that conceptual understanding “need not be explicit” (p. 118), it is asserted that verbalisation, and thus language, is a key factor in conceptual understanding. Language and conceptual understanding are inseparable. It is thus important that for effective teaching of mathematical concepts to happen, a shared mathematical register should exist in the language of instruction. In most multilingual communities in Africa, such as South Africa, this is not the case.

For most South African teachers and students of mathematics and science, the LoLT in these disciplines is English – an additional language that for many is difficult to understand and use. To address these difficulties CALLSSA embarked on developing and writing a learning and teaching resource and support book for Mathematics and Science. This book provides detailed meanings and explanations for key concepts in Xhosa, Zulu, Afrikaans and English within the framework of the Revised National Curriculum Statement (RNCS)

at a Grade 9 – 10 levels. It lists about 60 key RNCS mathematics and science concepts that are grouped under the themes of time, space, and number for mathematics, and energy, matter, earth, and life for science. Very importantly, attention is also given to the everyday English meanings of these specific concepts. As Young et al. (2005) note, the words and language forms of mathematics and science often differ markedly from those of everyday use of the same words. For example, concepts like power, force, revolution, work, and pressure have very different everyday meanings to their specialised meanings in mathematics and sciences.

The development of the book was a collaborative process with teachers of mathematics and science in the Western Cape, Eastern Cape, and KwaZulu Natal, and validated by expertise in mathematics and science education, Xhosa, Zulu, and Afrikaans from across South Africa. In its introduction the book acknowledges some of the dilemmas that were faced in the translation and explanation of concepts:

We are very aware of questions about which Xhosa or Zulu words or terms for these concepts are 'correct', standardised forms. We have, wherever possible, tried to ensure that our uses of both Xhosa and Zulu are correct. Until these two languages, and other African languages, are fully standardised, our text must serve as an interim attempt to offer translation equivalents in Xhosa and Zulu for English concepts dealt with in this book. We think it is better to present work close to the ideal as a starting point rather than to have nothing available! (Young, D., van der Vlugt, J., & Qanya, S., 2005, p. vii).

Teachers from across the three provinces participated in the development phases of the book by trialing sections of the initial manuscript and providing feedback on their experiences. Lessons were videotaped and deconstructed with the participating teachers. Issues such as inaccuracies in translations and the use of inappropriate and inaccessible diagrams were identified and noted. These were then incorporated in the final version of the book. The book was marketed in all the provincial education departments of South Africa, and those provinces where Xhosa and Zulu are particularly prevalent have ordered copies for their teachers.

Code-switching and Some Tentative Research Results

South Africa is a multicultural and multilingual country with a diversity of 11 official languages. Although the Language-in-Education Policy insists that the LoLT in the first four years of schooling is mother-tongue, the use of code-switching is common practice in most schools where the home language of teachers and learners is not English. In South Africa these are mostly schools that, in the apartheid years, were classified as black or township schools. Code-switching is the practice where “an individual (more or less deliberately) alternates between two or more languages” (Baker, 1993, pp. 76–77). As Setati notes, code-switching “can be between languages, registers and discourses” (2005, p. 91). In the South African classroom, code-switching would typically involve an indigenous language and English. Despite policy that states that the medium of instruction changes to English after Grade 4, the practice of code-switching is often sustained for the entire duration of schooling. It is argued that code-switching can be a powerful and effective pedagogical tool to overcome language barriers to teaching and learning. As Setati and Adler (2001) noticed, many teachers in South Africa have a dual task of teaching both mathematics and English at the same time. It goes without saying that by the same token learners also have to cope with the language of mathematics and the language in which it is taught – and this in many instances is a second or even third language.

Recent preliminary pilot research in the Eastern Cape by Thokwe and Schäfer (2009) explored how the Concept Literacy book in question impacted particularly on the code-switching practices of selected Xhosa-speaking Grade 10 mathematics teachers. Four teachers with similar code-switching practices were involved in the pilot study. The code-switching practices of two of the teachers were observed and documented over a number of lessons before they were introduced to the Concept Literacy book. Their use of the two languages (English and Xhosa) was recorded over a period of time and is illustrated in Figure 1, which shows a combined analysis of their code-switching practices.

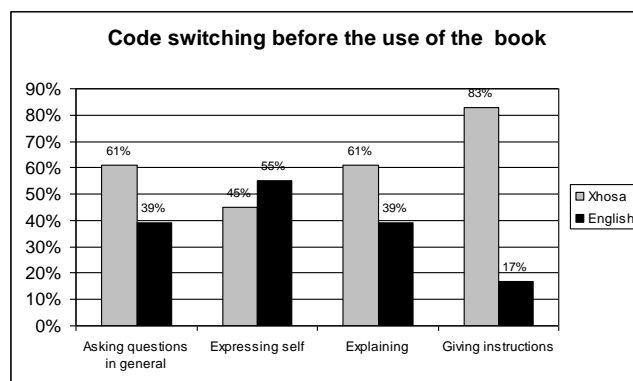

Figure 1. Code-switching practices of two teachers before the use of the Concept Literacy book.

It is interesting to note that when giving instructions, both teachers preferred to use the vernacular. This trend however changed when the teachers started to explain and illustrate mathematical concepts and terms. The use of English became more prominent and the practice of code-switching increased. This is illustrated in the following conversation:

Consider the situation whereby *siza kuthatha ii triangles zethu ezimbini sizibeke on top of one another. What I'm trying to say is this* [drawing 2 triangles adjacent to each other]. Translation: **Consider the situation whereby *we will be taking our two triangles and put them on top of one another. What I'm trying to say is this*** [drawing 2 triangles adjacent to each other]

If you say now all angles of a triangle are equal, *ingaba i angle inye kuzo err ndicinga ukuba..... Ingaba inye iza kuba how many?* (Teacher and learners respond simultaneously.) **“Ngu 60 degrees.”** Translation: **If you say now all angles of a triangle are equal, *is it that one of the angles err.. I think that..... How many will one of them?*** (Teacher and learners respond simultaneously.) **“It is 60 degrees.”**

“In other words, *ukuba siza kuthi le yi parallelogram, so that means eli cala lingapha liza kuba parallel kwela cala lingaphaya and eli lona libe parallel kweli lingaphaya.*” Translation: **“In other words, *if we say that this a parallelogram, so that means this side here will be parallel to that side on the other side and this one will be parallel to the one on the other side.***

The above scenario is, however, not surprising if one considers the lack of a mathematical register in Xhosa and the dearth of mathematical resources and texts in that language. There are many constraints in mother-tongue education. As Probyn (2002) stated, “... there are [numerous] linguistic and economic constraints on mother-tongue education: the fact that indigenous languages have not been used for academic purposes means that the necessary terminology and textbook resources have not been developed” (p. 10).

After using the book over a period of two terms, the code-switching practice of two teachers was once again observed and documented. This is illustrated in Figure 2, which shows a combined analysis of their code-switching practices over a period of time.

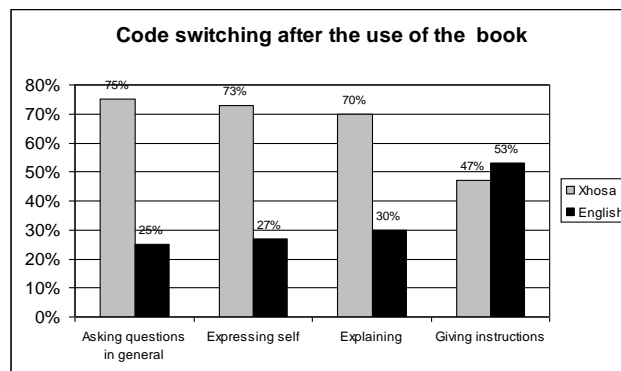

Figure 2. Code-switching practices of two teachers after the use of the Concept Literacy book.

It is interesting to observe that after the Concept Literacy Resource book intervention the use of Xhosa increased markedly for the following categories of communication: asking questions, expressing self, and explaining. Notwithstanding the small sample and the tentative nature of the pilot, this suggests that the Concept Literacy Resource book had an impact on the code-switching practices of the participating teachers. Their use of their first language increased and they appeared more confident in using Xhosa in mediating mathematical concepts.

In general, the Concept Literacy Resource Book was well received and initial classroom visitations revealed the following:

1. *Deep Xhosa versus everyday Xhosa.* A number of the teachers felt that the Xhosa that was used in the resource book was at times difficult to understand. They felt that the translations were dominated by ‘deep’ Xhosa – sometimes also referred to as rural, old, traditional, or formal Xhosa as opposed to ‘township’ Xhosa – also referred to as everyday or modern Xhosa. According to the teachers, many of the learners expressed similar sentiments.
2. *Inconsistent use of Xhosa.* In some instances it was felt that the translation used in the text was not consistent with some of the dictionaries to which the teachers had access (Schäfer, 2005).
3. *Assistance in conceptualisation.* A number of teachers said that the Xhosa text assisted in their own conceptualisation of a particular concept. This also applied to many of the learners who were provided with photocopies of the text in various lessons (Schäfer, 2005).
4. *More comprehensive translation.* There was widespread consensus that the entire book needed to be translated into Xhosa and not just the key concepts (Schäfer, 2005).
5. *Texts in mother-tongue.* Many of the teachers felt that they themselves were not aware of the existence of some of the Xhosa terminology and were surprised when they encountered some of the terms in their own language. There was consensus that a standardised Xhosa mathematical register needed to be developed as soon as possible. There was a strong commitment from the teachers to the preservation of Xhosa and many felt that it was important to teach through the medium of Xhosa.

It was, however, also recognised that in an era of globalisation and market-driven economies, the dominance and power of English cannot be ignored (Schäfer, 2005).

6. *Resistance to Xhosa*. There was resistance to the use of Xhosa by some learners. They felt that English was the international and dominant language and hence they needed to learn mathematics and science in that language. Incidentally, numerous teachers commented that a similar sentiment existed amongst some parents who felt that teaching should be done through the medium of English and not through the mother-tongue (Schäfer, 2005).
7. *Support of textbooks and other learning areas*. The resource book was used to support the textbook in lesson preparation and implementation. Some teachers photocopied pages out of the book to hand to the class (Schäfer, 2005).

Conclusion

Our research into the use of the Concept Literacy Resource book shows that a multilingual text of this nature is long overdue and could play an important role in enhancing the role of indigenous language in the teaching and learning of mathematics in South Africa. The development of a mathematics and science register in all indigenous languages is fundamental to the realisation of the vision that asserts that each child should have the choice of his/her language of instruction.

References

- Adler, J. (2001). *Teaching mathematics in multilingual classrooms*. Dordrecht: Kluwer.
- Baker, C. (1993). *Foundations of bilingual education and bilingualism*. Clevedon: Multilingual Matters Ltd.
- Howie, S. (2002). *English language proficiency and contextual factors influencing mathematical achievement of secondary school pupils in South Africa*. Doctoral Thesis, University of Twente, Enschede, Netherlands. Enschede: PrintPartners Ipskamp.
- Kilpatrick, J., Swafford, J., & Findell, B. (Eds.) (2001). *Adding it up: Helping children learn mathematics*. Washington DC: National Academy Press.
- Probyn, M. (2002). *Teachers' voices: Teachers' reflections on learning and teaching through the medium of English as a second language*. Unpublished master's thesis, Rhodes University, Grahamstown, South Africa.
- Schäfer, M. (2005). Concept Literacy in Mathematics and Science: A collaborative project in Xhosa, Zulu, English and Afrikaans. *Proceedings of the 1st African Regional Congress of the International Commission on Mathematical Instruction (ICMI)*, Johannesburg.
- Setati, M. (2005). Mathematics education and language: Policy, research and practice in multilingual South Africa. In R. Vithal, J. Adler, & C. Keitel (Eds.), *Researching mathematics education in South Africa* (pp. 73–109). Cape Town: HSRC Press.
- Setati, M., & Adler, J. (2001). Between languages and discourses: Language practices in primary multilingual practices in mathematics, science and English language classrooms in South Africa. *Language and Education*, 16(2), 128–149.
- Thokwe, T., & Schäfer, M. (2009). Investigating code-switching of English Second Language (ESL) teachers in the teaching of mathematics: A grade 9 & 10 case study. In M. Schäfer & C. McNamara (Eds.), *Proceedings of the 17th Annual Meeting of the Southern African Association for Research in Mathematics, Science and Technology Education (SAARMSTE)*, Grahamstown.
- Young, D., van der Vlugt, J., & Qanya, S. (2004). *Tread softly because you tread on my concepts...* Unpublished paper delivered at SAALA Conference, University of the North, July 2004.
- Young, D., van der Vlugt, J., & Qanya, S. (2005). *Understanding concepts in mathematics and science: A multilingual learning and teaching resource book in English, IsiXhosa, IsiZulu, Afrikaans*. Maskew Miller Longman: Cape Town. Developed by the Concept Literacy Project at the University of Cape Town.

Using Concept Cartoons to Access Student Beliefs about Preferred Approaches to Mathematics Learning and Teaching

Matthew Sexton
Australian Catholic University
<matthew.sexton@acu.edu.au>

Curriculum reforms in the teaching of mathematics have encouraged a move away from sole memorisation of facts to the construction of deeper levels of understanding. With this reform, teachers of mathematics are called to act as facilitators of the construction of mathematical knowledge. However, some research suggests that students believe that their teacher's role is one that would be more aligned with the transmission of knowledge. This paper reports an aspect of a small-scale pilot study that sought to illuminate the beliefs that students hold about their preferred mathematics learning environments. It also highlights the role that 'concept cartoons' played in making known these beliefs.

Researchers have used the term 'student voice' in recent years to describe a number of concepts related to education and schooling (e.g., McCallum, Hargreaves, & Gipps, 2000; Veugelers & de Kat, 2002). Student voice can encompass ideas related to the beliefs and perceptions that students might hold regarding their teachers (Pratt, 2006; Taylor, Hawera, & Young-Loveridge, 2005) to the way that curriculum is organised and taught (Alerby, 2003; Kinchin, 2004). This paper reports an aspect of a small pilot study, which drew upon the work of Kinchin (2004). The study aimed to make known the beliefs that upper-primary school students held about their preferred mathematics learning approaches, and explored the possibility of using concept cartoons (Keogh & Naylor, 1999) as a means of accessing student voice related to these preferences.

Background

There are different uses for the term 'belief' within the psychology and mathematics education research communities (Hart, 1989). Rokeach (1968) described beliefs as any simple conscious or unconscious proposition, inferred from what a person says or does. Beliefs are related to and interact with emotions and attitudes (McLeod, 1992; Rokeach, 1968). When seeking to understand children's school experiences, their articulations of beliefs are considered important (McCallum et al., 2000; Rudduck & Flutter, 2000). Rudduck and Flutter (2000) interviewed primary and secondary school students and found that students hold strong beliefs about their experiences of school and ways of improving their schooling. Beliefs may impact upon children's reactions to, or interpretations of statements, actions and products of situations involving the learning of mathematics (McDonough, 2002). They can also influence the nature of students' participation in mathematics lessons and affect the way that students learn in specific situations (Franke & Carey, 1997; Kinchin, 2004; Taylor et al., 2005).

To engage in purposeful and meaningful learning, students need to develop an understanding and appreciation of the expectations set for them by their teacher (Kinchin, 2004). Skemp (1976) warned of issues related to mismatches between the respective learning goals of students and teachers. When describing relational and instrumental understanding, Skemp proposed that a damaging mismatch occurs when students seek to understand mathematics in a relational way but the teaching is directed to understanding it instrumentally. Fewer short-term problems are evident if the opposite occurs. In recent



years, Tsai (2003), after studying Taiwanese science classrooms, referred to this type of mismatch as an 'epistemological gap'. If this mismatch of beliefs is present in the classroom, there is potential for negative emotions, primarily frustration, to manifest in the classroom setting for both teacher and student. Another product could be a lack of meaningful learning (Kinchin, 2004).

Studies have shown that students hold a range of beliefs about teachers, from viewing the teacher as a person who facilitates learning to seeing the teacher as the person who transmits facts and information for memorisation (Kinchin, 2004; Taylor et al., 2005; Tsai, 2003). For example, if a student perceives the teacher as the manager of learning, then that student is likely to respond with passivity in the mathematics lesson. In some cases, only a very small number of students view the teacher as a facilitator of learning (Pratt, 2006; Taylor et al., 2005). These students believe that the teacher's role is like that of a 'mentor' and it is thought that these students take an active role in the teaching and learning process. It would appear that most students assign a role to the teacher that implies the idea of the transmission of knowledge or manager of the learning environment (Civil & Planas, 2004; Pratt, 2006; Taylor et al., 2005). These ideas reiterate the findings of McDonough (2002) that most of the students in her case studies preferred a style of teaching where they received information from the teacher.

Franke and Carey (1997) claimed that the use of carefully selected questions could provide insights into the perceptions that students hold about mathematics. McCallum, Hargreaves and Gipps (2000) supported this claim, through research using interviews, reporting that young students have the capacity to describe a variety of learning strategies and conditions to assist them in their learning. Talking to and listening to students discuss their beliefs about the teacher's role is one way of making known the perspectives of children (McDonough, 2002; Taylor et al., 2005). Data about beliefs have been collected typically through questionnaire and interview use (McLeod, 1992).

There is, however, research that supports the use of pictorial representations as a means of accessing insights into student beliefs (Alerby, 2003; McDonough, 2002). McDonough reported on the effectiveness of the Pupil Perceptions of Effective Learning Environments in Mathematics (PPELEM) procedure as a way for teachers to access student beliefs about mathematics. Students were required to draw an experience of a time when they learned mathematics well and participate in a short interview with an adult, usually a teacher, discussing questions used to gain further insights into the student's beliefs. McDonough reported that this tool can be used to investigate student beliefs and inform teachers in their practice to better meet student learning needs. The PPELEM procedure can also act as a means for students to become more reflective about their learning.

Concept cartoons are learning and teaching tools used primarily in science education to explore scientific concepts (Keogh & Naylor, 1999). The cartoons share some common traits with those used in comic strips, but rather than being designed for humour, they aim to present to students the opportunity to interpret and understand concepts. Concept cartoons include a pictorial representation of characters in settings familiar to students along with the use of written language in speech bubbles (Keogh & Naylor, 1999; Kinchin, 2004). The familiar settings and characters give relevance to the ideas that are being presented. It is important that alternative conceptions, statements or questions pertaining to a central idea are presented within the cartoon. In most cases, alternative viewpoints are presented by characters engaging in a dialogue through the illustrator's use of speech bubbles and written language. Due to the characters' dialogue, students have the freedom to make judgements that agree or disagree with the views expressed by the characters

without feeling threatened about expressing their own opinion publicly (Kinchin, 2004). Concept cartoons are primarily intended to act as a teaching and learning tool but they have also been proven to work effectively as a cognitive and affective assessment strategy (Keogh & Naylor, 1999; Kinchin, 2004).

In response to the literature, a small pilot study was developed to inquire into the use of concept cartoons (Keogh & Naylor, 1999) as a means of accessing student beliefs about their preferred approaches when learning mathematics, illuminating the possible presence of epistemological gaps (Tsai, 2003) in mathematics classrooms.

Method

The participants in the study were 75 students completing their sixth and seventh year of primary school (Grade 5 and 6 in Victoria) who ranged in ages from 10 to 13 years. The four classroom teachers invited to participate in the study had experience ranging from four to 35 years of teaching in primary schools. The school in which the study took place was a Catholic primary school located in an outer-western suburb of Melbourne.

A questionnaire, incorporating the use of two modified concept cartoons (Keogh & Naylor, 1999), was used to gather data that described the students' and teachers' beliefs about their preferred approaches to mathematics learning and teaching. The cartoons were created drawing on ideas from research literature (Ali, 2004; Brewer & Daane, 2002; Cobb, 1994; Kinchin, 2004). These cartoons can be found in Figures 1 and 2. The dialogues in the speech bubbles could be deemed as characterisations or stereotypes of behaviourist and constructivist approaches, respectively. Such characterisations provide clarity for the students so that they could gain a picture of the differences in the approaches presented in both cartoons.

As can be seen, the dialogue in the characters' speech bubbles details actions by the teacher and the students that are aligned with either behaviourist or constructivist learning approaches. The participants were asked to complete the questionnaire by selecting the cartoon that best matched their preferred approach to learning and teaching mathematics, that is, either 'Cartoon A' or 'Cartoon B'. To limit any potential reading difficulties, the dialogue in the speech bubbles was read out loud to the participants by the researcher.

The participants were also invited to record any supporting information by completing the sentence stem "I chose this cartoon because..." A small selection of students was chosen to elaborate upon their written responses by participating in a short interview. These students were selected based primarily upon comments or statements that needed further explanation.

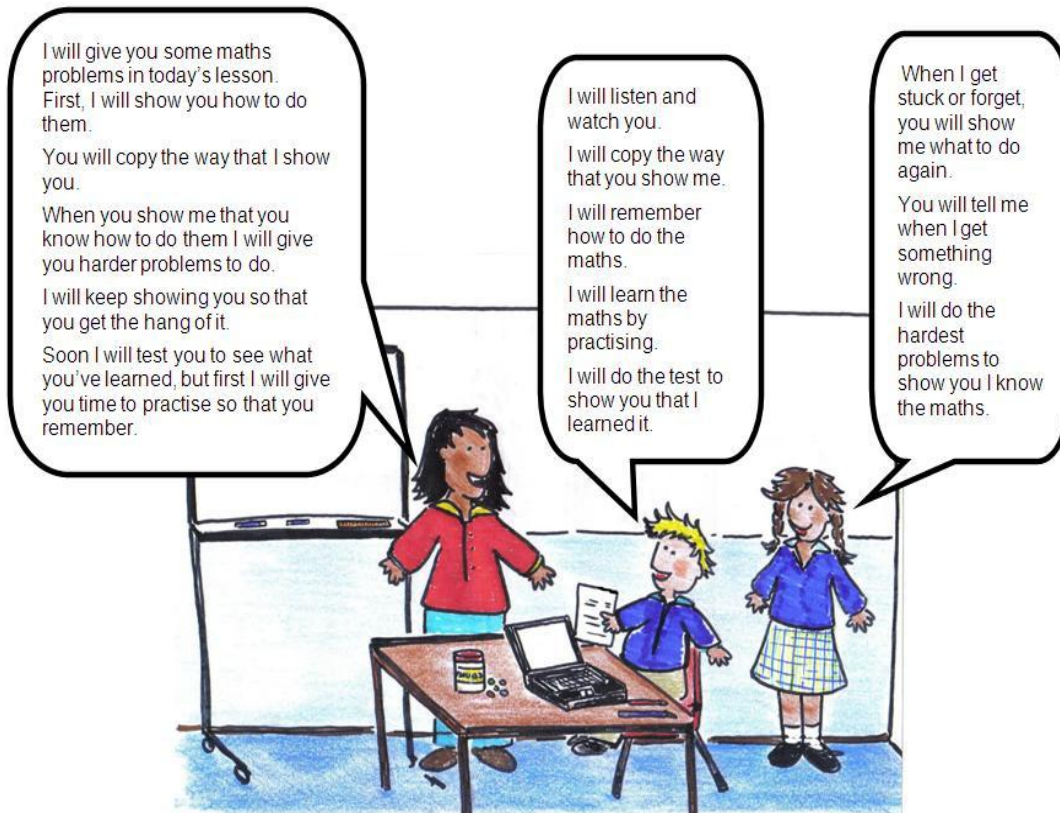

Figure 1. The concept cartoon (Cartoon A) that depicts a behaviourist approach to learning

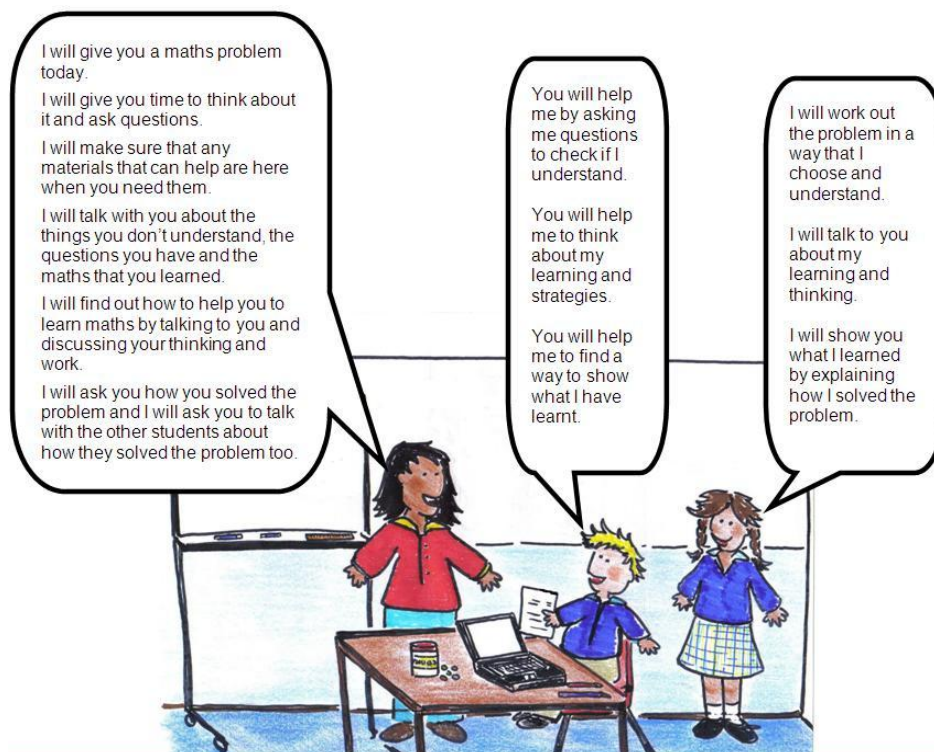

Figure 2. The concept cartoon (Cartoon B) that depicts a constructivist approach to learning.

Results

All names used within this report are pseudonyms. The data that relate to student preferences according to classroom membership and insights from a number of interviews are reported here. Three of the teachers, Ms Ruzic, Mr Brook and Ms Gallo, believed that their preferred approaches to teaching were aligned with those practices depicted in Cartoon B (constructivist approach). However one teacher, Ms Costa, stated that there was a place for the practices represented in both cartoons. Ms Costa explained that the practices described in Cartoon A were similar to ones that she employed at the beginning and end of a unit about a particular mathematics topic. Ms Costa continued her explanation by reporting that the practices depicted in Cartoon B were ones that were used during the unit of work. The data that relate to the student preferences according to their classroom grade are in Table 1.

Table 1

Frequency of Student Preferences for Learning Environments by Classroom (n=75)

Cartoon type	Ms Ruzic	Mr Brook	Ms Gallo	Ms Costa	Total
Behaviourist (<i>Cartoon A</i>)	10	10	3	2	25
Constructivist (<i>Cartoon B</i>)	10	8	13	10	41
Combination (<i>Cartoon A & B</i>)	0	0	0	9	9

These data show that all students were able to choose a cartoon that described their preferences. There appears to be a near equal spread of preferences by students in the classrooms of Ms Ruzic and Mr Brook. Nearly half ($\approx 50\text{--}55\%$) of the students in these two grades showed a preference for a learning approach that matched the one chosen by their classroom teacher. The preferences of the students in Ms Gallo's classroom appear to be most aligned with those of their teacher. Approximately four-fifths of students ($\approx 81\%$) in this class chose the approach that mirrors the preference of Ms Gallo. The only students who chose a combination of the cartoons were students in Ms Costa's grade. Nearly two-fifths ($\approx 43\%$) of the students in this classroom showed a preference for learning that combined aspects of the behaviourist and constructivist approaches. The greatest discrepancies between beliefs held by the teachers and students appear to be present in the classrooms of Ms Ruzic, Mr Brook and Ms Costa.

The space for written explanations on the concept cartoon questionnaire provided opportunities for the students to elaborate on their choice of cartoon. A number of themes emerged from the written explanations of the students who chose Cartoon A (behaviourist classroom). The most common theme pertained to the importance of the teacher showing and modelling procedures. For example, during an interview, Demi, a Grade 6 student in Ms Ruzic's class, revealed beliefs about the role that she has assigned to her teacher:

It's her job to show me exactly what to do. I like seeing the way to do it and seeing all of the steps. Sometimes she doesn't do that, though.

Other emerging themes in the students' responses concerned the 'need for the teacher to show the 'right' way of doing the mathematics', 'time to remember what had been taught in lessons through revision', and 'tests as a means of providing feedback on performance'.

Mikey, a Grade 6 student taught by Mr Brook, participated in an interview. When asked to discuss his written explanation, Mikey said

I wrote that down because it is important to understand by real learning. Real learning is learning that I understand for myself...I don't see copying the teacher as real learning...that's just remembering. If I understand it, I don't need to remember it. I get it...it makes sense. You need to make sense of maths.

Analyses of the written responses from the students who chose Cartoon B (constructivist classroom) revealed some interesting themes. The most frequent themes included the 'importance of discussion with peers', 'exploring and using self-constructed strategies', the 'value of working with other students to compare solutions and strategy uses', the 'importance of using questions in learning', the 'place of mistakes or errors when learning' and the 'need to understand the mathematics being taught'. In many cases, more than one theme was recorded by these students.

Madison, a Grade 5 student taught by Ms Costa, chose a combination of cartoons. In a follow-up interview, Madison elaborated upon her written explanation by saying

I like it when Ms Costa shows me how to do the sums step-by-step and when she keeps showing me. When I get it, I like to see how someone else does it so I learn a different way.

The written responses from students who chose a combination of cartoons revealed fewer themes than those questionnaires completed by students choosing Cartoon A and considerably less than the questionnaires completed by those who chose Cartoon B. The themes of 'opportunities to learn other solution strategies after being shown procedures by the teacher' and 'opportunities for students to make their own decisions about use of materials' featured in the responses from these students.

Discussion

One of the aims of this study was to gain information about the potential use of concept cartoons (Keogh & Naylor, 1999) to inquire into student beliefs. The concept cartoons acted as an assessment tool that allowed access into student beliefs about their preferred learning environments. This study confirms findings from other studies that visual imagery, as used in the concept cartoons, can be an engaging and useful way of assessing student affect (Alerby, 2003; Kinchin, 2004; McDonough, 2002). These cartoons provided an opportunity for students to reflect upon their preferences when learning mathematics and make these known to others.

Anecdotal data reveal that overall the students responded positively to the use of the cartoons in the questionnaire. However, the use of the term 'cartoon' was misleading for some students (Keogh & Naylor, 1999). Some students made this known by commenting that they were expecting to see characters that resembled those seen in a popular television program. Researchers and teachers will need to be mindful of discussions about the term 'cartoon' when using concept cartoons with students.

The inclusion of a written explanation proved to be important. Further insights were accessed via opportunities to elaborate further on choices. Each student was also able to provide reasons for their choice of cartoon, although the degree to which they were able to articulate these thoughts varied from student to student.

The findings from this study suggest that, not surprisingly, the presence of 'epistemological gaps' extends beyond science learning and teaching (Tsai, 2003) to mathematics classrooms in upper-primary school settings. The presence of this type of mismatch in beliefs was most evident in three of the four classrooms involved in the study. It must be acknowledged here that it is not known to what extent the teachers' practices were actually aligned with their stated or actual beliefs because this was not the focus of

the study. Despite this, the data do suggest that approximately one-third of students involved in the study could be at risk of not fully understanding the mathematics that is being taught, their participation in mathematics lessons may be limited or negative emotions towards mathematics may be experienced by these students (Kinchin, 2004; Pratt, 2006; Taylor et al., 2005).

The data collected via the questionnaire confirm that students do hold beliefs about the way that they learn and the teacher role (Civil & Planas, 2004; Pratt, 2006; Taylor et al., 2005). It could be argued that through their written responses, the students demonstrated understanding of characteristics that define behaviourist and constructivist approaches. The findings also support the idea that within the one classroom, the beliefs that students hold can be varied (Franke & Carey, 1997) and as learners, students have the capacity to describe strategies and conditions that best support their learning (McCallum et al., 2000) when given the opportunity.

A challenge for teachers lies in supporting students to come to an understanding and appreciation of the expectations of practices within the mathematics classroom. Careful consideration must occur to ensure that teachers are not just transmitting information about these expectations but providing opportunities for students to reflect upon and understand these expectations and 'ways of working'. The joint-construction of sociomathematical norms (Yackel & Cobb, 1996) by the teacher and students could be an opportunity to make explicit the expectations of learning and teaching behaviours. If the teacher's role is to facilitate the construction of mathematical knowledge and to support higher-order thinking, teachers need to make explicit the reasons for their actions in mathematics lessons. In one way, this might make clearer the expectations of the learning actions for the students, thus leading to the possible reduction in any 'epistemological gaps' (Tsai, 2003) or mismatches in beliefs (Skemp, 1976).

This study has important implications for the classroom, especially when it comes to developing understanding and meaningful participation in mathematics by all students. If current education reforms in mathematics education tend to be moving away from the reception and memorization of knowledge to the construction of deeper levels of meaning and understanding (Ali, 2004; Brewer & Daane, 2002; Cobb, 1994; Kinchin, 2004), then attention needs to be paid to knowing more about the preferences of students with whom teachers work and making efforts to minimise the possible presence of epistemological gaps in mathematics classrooms.

Conclusion

This study was designed to gain insights into the beliefs of upper-primary school students about their preferred approaches to mathematics learning. It had a second important aim, which was to test the effectiveness of using concept cartoons to gain these insights. The findings highlight the important need of accessing student beliefs about their preferred approaches to learning mathematics because students and teachers may not always share a common set of beliefs about these approaches. Even though reforms are moving away from procedurally orientated classrooms, it would appear that many students prefer behaviourist approaches when learning mathematics. The concept cartoons have provided a way of accessing information about student learning preferences. These cartoons, used primarily in science education, have proven to be a purposeful assessment tool and a useful way of accessing 'student voice'.

For the future, possible research ideas concerning concept cartoons include extending their use as a potential pedagogical tool in mathematics. The concept cartoons could be

studied as a stimulus that teachers use to initiate classroom inquiries where students formulate mathematical arguments as responses to the characters, confirming or challenging information contained within the cartoon. Concept cartoons warrant further research and application in mathematics classrooms.

References

- Alerby, E. (2003). 'During the break we have fun': A study concerning pupil's experience of school. *Educational Research*, 45(1), 17-28.
- Ali, A. (2004). Applying constructivism in a traditional environment. *Academic Exchange Quarterly*, 8(1), 71-75.
- Brewer, J., & Daane, C. J. (2002). Translating constructivist theory into practice in primary-grade mathematics. *Education*, 123(2), 416-421.
- Civil, M., & Planas, N. (2004). Participation in the mathematics classroom: Does every student have a voice? *For the Learning of Mathematics*, 24(1), 7-12.
- Cobb, P. (1994). Where is the mind? Constructivist and sociocultural perspectives on mathematical development. *Educational Researcher*, 23(7), 13-20.
- Franke, M. L., & Carey, D. A. (1997). Young children's perceptions of mathematics in problem-solving environments. *Journal for Research in Mathematics Education*, 28(1), 8-25.
- Hart, L. E. (1989). Describing the affective domain: Saying what we mean. In D. B. McLeod & V. M. Adams (Eds.), *Affect and mathematical problem solving: A new perspective* (pp. 37-45). New York: Springer-Verlag.
- Keogh, B., & Naylor, S. (1999). Concept cartoons, teaching and learning in science: An evaluation. *International Journal of Science Education*, 21, 431-446.
- Kinchin, I. M. (2004). Investigating students' beliefs about their preferred role as learners. *Educational Research*, 46(3), 301-312.
- McCallum, B., Hargreaves, E., & Gipps, C. (2000). *Learning: The pupil's voice*. Retrieved September 25, 2006, from <http://plinks.ebscohost.com/ehost/pdf?vid=10&hid=102&sid=8473e132-d83d-40ce-b815-8cafdb6747a0%40sessionmgr4>
- McDonough, A. (2002). *Naïve and yet knowing: Young learners portray beliefs about mathematics and learning*. Unpublished doctoral thesis. Australian Catholic University.
- McLeod, D. B. (1992). Research on affect in mathematics education: A reconceptualization. In D. A. Grouws (Ed.), *Handbook of research on mathematics teaching and learning* (pp. 575-596). New York: Macmillan.
- Pratt, N. (2006). 'Interactive' teaching in numeracy lessons: What do children have to say? *Cambridge Journal of Education*, 36(2), 221-235.
- Rokeach, M. (1968). *Beliefs, attitudes, and values: A theory of organisational change*. San Francisco: Jossey-Bass.
- Rudduck, J., & Flutter, J. (2000). Pupil participation and pupil perspective: 'Carving a new order of experience'. *Cambridge Journal of Education*, 30(1), 81-89.
- Skemp, R. R. (1976). Relational understanding and instrumental understanding. *Mathematics Teaching*, 77, 20-26.
- Taylor, M., Hawera, N., & Young-Loveridge, J. (2005). Children's views of their teacher's role in helping them learn mathematics. In P. Clarkson, A. Downton, D. Gronn, M. Horne, A. McDonough, R. Pierce & A. Roche (Eds.), *Building connections: Research, theory and practice* (Proceedings of the 28th annual conference of the Mathematical Research Group of Australasia, Melbourne, pp. 728-734). Melbourne: MERGA.
- Tsai, C. C. (2003). Taiwanese science students' and teachers' perspectives of the laboratory learning environments: Exploring epistemological gaps. *International Journal of Science Education*, 25, 847-860.
- Veugelers, W., & de Kat, E. (2002). Student voice in school leadership. *Journal of School Leadership*, 12, 97-108.
- Yackel, E., & Cobb, P. (1996). Sociomathematical norms, argumentation, and autonomy in mathematics. *Journal for Research in Mathematics Education*, 27(4), 458-477.

How to Build Powerful Learning Trajectories for Relational Thinking in the Primary School Years

Max Stephens

The University of Melbourne

[<m.stephens@unimelb.edu.au>](mailto:m.stephens@unimelb.edu.au)

Dian Armanto

The State University of Medan

[<armanto_dian@yahoo.com>](mailto:armanto_dian@yahoo.com)

There are now strong arguments for building closer links between children's understanding of numbers and number operations and the beginning of algebraic (relational) thinking in the primary school years. Rarely, however, do Australian mathematics textbooks give enough guidance for teachers to use good activities in the classroom to promote algebraic thinking. By contrast, Japanese mathematics textbooks introduce students to relational thinking about number sentences, starting from the first grade. The idea of a learning trajectory – or trajectories – seems a fruitful way of looking at how this is achieved and what it might mean for the teaching of Number and algebra in the primary years.

In its scoping paper, *Shape of the Australian Curriculum: Mathematics*, the Australian Curriculum and Reporting Authority (ACARA, 2009) undertook to strengthen the links between the teaching of Number and algebra. Referring especially to the middle and later primary years, the paper argued that “An algebraic perspective can enrich the teaching of number” (ACARA, 2009, p. 6). Likewise, in its report, *Algebra: Gateway to a Technological Future*, The Mathematical Association of America (2007) argued that “We need a much fuller picture of the essential early algebra ideas, how these ideas are connected to the existing curriculum, how they develop in children's thinking, how to scaffold this development, and what are the critical junctures of this development” (p. 2). A clear learning trajectory, supported by carefully planned activities and good problems, will be important to demonstrate the kind of scaffolding advocated in these two documents.

Rationale for a Learning Trajectory for Relational Thinking

The development of algebraic thinking depends on the recognition and analysis of patterns that are important components of the young child's mathematical development (Sarama & Clements, 2009, p. 319). Patterns such as subitized patterns, patterns in the number words of counting, “one-more” patterns of counting, numerical patterns, arithmetic patterns, spatial patterns and array structures are typical early childhood practice in patterning (Wu, 2007). Patterning is the search for mathematical regularities and structures, to bring order, cohesion, and predictability to seemingly unorganized situations and facilitate generalizations beyond the information directly available (Sarama & Clements, 2009, p. 319). As a process, a habit of mind in understanding mathematics, Mason, Stephens, and Watson (2009) point out that pattern recognition is based on an assumption that patterns are present and that things that seem to be the case will continue to be the case; emphasising that, for students, investigating patterns sometimes means seeing “the general in the particular” or at other times seeing a “particular case as an instance of a general mathematical truth” (p. 21).

Baroody (1993) mentioned that students learn to find and extend numerical patterns – extending their knowledge of patterns to thinking algebraically about arithmetic. However, we know that this does not happen automatically for children, and that it is heavily dependent on how they are taught. The ability of children to invent, learn, apply, justify, and otherwise reason about arithmetic problems, demonstrates that algebraic thinking can



be an implicit but significant component of primary children's learning of mathematics (Sarama & Clements, 2009). Students also can recognize that equality is preserved if equivalent transformations are made on both 'sides' of a situation, from balance scales to sets of objects, verbal problems, and written equations (Schliemann, Carraher & Brizuela, 2007).

According to Molina, Castro and Mason (2007), when students think relationally, they consider the number sentence as a whole, then analyse and find the structure and important elements or relationship to generate productive solutions. Related research by Carpenter and Franke (2001) and by Stephens (2007, 2008) showed that relational thinking occurs when students see the equals sign as a relational symbol, focus on the structure of expression, and carry out reasonable strategies to solve the number sentence attending to the operations involved.

These key ideas are assumed in most textbook treatments of algebra which typically start at junior secondary school, where it is introduced as generalised arithmetic. Appreciation, understanding, and comprehension of these ideas are necessary for continued development of and success in algebraic thinking throughout secondary school. In this paper we argue that the foundations for this kind of thinking need to be laid in the primary school years. By analysing students' textbooks used in Japan, this paper will illustrate a possible learning trajectory for teaching relational thinking for students and teachers.

A Concept of Learning Trajectory

In an abstract sense, learning trajectories are descriptions of students' thinking as they learn to achieve specific goals in a mathematical domain. In more concrete terms, a learning trajectory is a conjectured path through a set of instructional tasks designed to produce those mental processes or actions hypothesized to advance students' thinking in a particular domain. It begins with a preliminary design of prototypical instructional activities, followed by teaching experiments, and ends with a retrospective analysis. This iterative process of (re-)designing and testing (Gravemeijer, 1999) aims at building a local instructional theory on how to teach specific topics.

Learning trajectories need pedagogical and theoretical constructs (Simon, 1995). Three elements appear to be essential: a set of clear mathematical goals, a clearly marked out pathway through the curriculum along which students can be helped to reach that goal, and a coherent set of instructional activities or tasks, matched to levels of students' mathematical thinking and prior experience, that support these mathematical and pedagogical goals. Teachers need to be particularly careful not to assume that students can see situations, problems, or solutions as adults do. Similarly, when they interact with students, teachers also should consider their actions from the students' point of view (Sarama & Clements, 2009, p. 17). Building good learning trajectories in textbooks helps teachers to think about what objectives should be established, where to start, how to know where to go next, and how to get there (Carpenter, Fennema, Peterson & Carey, 1988).

An Example of a Japanese Learning Trajectory

The learning trajectory of teaching mathematics in Japanese textbooks is quite clear in developing a close link between calculation and relational thinking. The development of students' relational thinking starts in the first grade of primary school. The examples used in this paper are taken from the most popular textbook series for primary schools in Japan – the Tokyo Shoseki (2006) series. The focus in this paper is on the development of

relational thinking about subtraction and addition in Grades 1 to 3 and the development of relational thinking about division in Grades 4 to 6. A detailed examination of relational thinking about multiplication is not possible here. It is hoped that, by using these chosen areas, several powerful and interconnected learning trajectories can be demonstrated.

First Grade



Figure 1. Exploring subtraction relationally in Grade 1

Figure 1 presents three activities that might take place over several lessons or even longer. These are explorations in looking for patterns and relationships, as opposed to “find the answer”. Firstly, working in a small group, students look for number sentences, deliberately left in uncalculated form, whose value is equivalent to a number that is named by the student at the head of the table (the answer to each subtraction is written on the back of the cards if students need to check). Here, students see that different subtraction sentences can have the same number as their answer, and become familiar with “what numbers are represented by what sentence”. In the first grade, other activities include arrays of cards representing addition. Regular computation methods feature too in all grades.

Initially, those subtractions “with the same answer” are not presented in any systematic form. Subsequently, by working individually (see the middle figure above) students are given a set of cards with the same subtraction questions on the face side, and are asked to place together on the board subtraction sentences that match the various numbers (answers). This more systematic activity focuses on finding (and discussing) different subtraction sentences that produce a given number (answer).

Thirdly, students are presented with the cards arranged by the teacher in an array. This activity builds on the preceding two activities and assumes that students are already comfortable with having sentences in uncalculated form; and that all students know that several subtraction sentences can represent the same number. In the first phase of this activity, students are asked to look at how the cards have been arranged vertically. Teachers may ask students to extend a given vertical column by using a given card or creating a new card. In other cases, the teacher may make gaps in the array which students are expected to fill in. Here, students are asked to find patterns for generalising the relationships that identify the sequence of numbers in a given column. Students might notice, for example, that in each column each card has the same starting number; or that the number of cards in each column grows as one moves from left to right; or that the second number in each column increases as one goes down. These insights are shared with the whole class.

Then, the same questions are applied to how the cards are arranged horizontally. Finally, the teacher or a student may name a given number – shown in the figure as 6 – and

ask students to find all the cards which have answers equivalent to this number. Students need to see that these cards all sit along a diagonal (shown above using a bar which we have inserted). Students are expected to describe how the numbers on the cards change as one moves along a diagonal. A related activity might be to look for all the cards in the array that represent the number 5, and so on. This carefully designed activity, spread over several lessons, helps students to understand that several subtraction sentences can represent the same number. Leaving the sentences in uncalculated form is essential to discussing the various relationships between numbers on the cards – horizontally, vertically and diagonally. As Mason, Stephens and Watson (2009) argued, structural (or relational) thinking relies on students learning to apply these multiple perspectives.

Second Grade — Here, subtraction sentence cards use larger numbers, as shown in Figure 2. Here, as in Grade One, the focus is on subtraction sentences with the same answer. However, larger numbers are used and the shift to a more systematic array takes place more quickly. Once again, it is expected that students are comfortable working with sentences in uncalculated form. In Figure 2 on the left, students are asked to line up the cards in order beginning with the smallest minuend and ending with the largest. Here students are asked to find the relationship among six subtraction sentences, all of which are equivalent to 28. A student might think that when the minuend (first number) increases by 1 the subtrahend (the number being subtracted) has to increase by one in order for the difference to remain the same. Students can also see which of the six cards represents the easiest calculation for them to make. The student in the frame on the right asks what will happen to the subtrahend if 84 is increased to 88 – increasing by one is not always necessary! Decreasing is also possible. Molina et al. (2007) emphasise this flexible aspect of relational thinking.

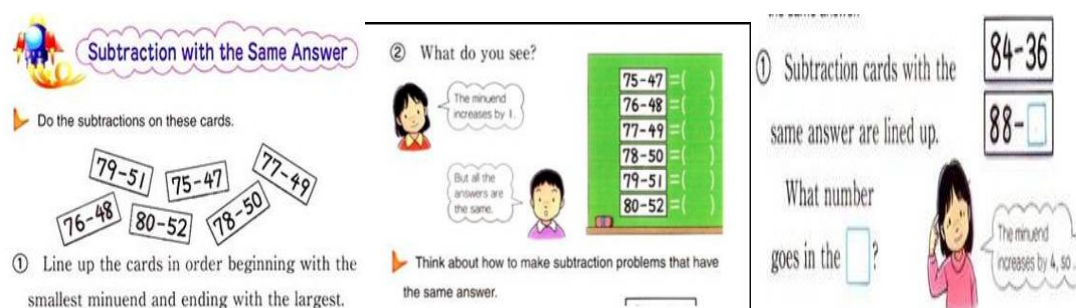

Figure 2. Exploring subtraction relationally in Grade 2

The pairing of $84 - 36$ with $88 - \square$ is quite deliberate, as is the use of an empty box to denote a missing number. Clearly, $88 - 40$ is easier. So a link between relational thinking and calculation is maintained in the Japanese textbook. Working with equivalent number sentences using subtraction is essential if one is to calculate intelligently, for example, in thinking about $234 - 99$, or $87 - 39$. It is a vital component of this learning trajectory.

Third Grade — In the third grade, the link between relational thinking and calculation is very clearly illustrated by the following two activities involving addition and subtraction (see Figure 3). Number sentences involving multiplication are also introduced in this grade.

1 Let's look at a way to do the following calculations more easily.

① $298 + 120$ ② $308 + 197$

$298 + 120 = \square$ $308 + 197 = \square$

add 2 subtract 2 add \square subtract \square

$300 + 120 = \square$ $308 + 200 = \square$

It's easier if we use numbers ending in zeros.

You have to decrease the answer by the number that was added to get a number with zeros.

2 Let's look at a way to do the following calculations more easily.

① $500 - 198$ ② $305 - 99$

$500 - 198 = \square$ $305 - 99 = \square$

add 2 add 2 add \square add \square

$500 - 200 = \square$ $305 - 100 = \square$

You have to increase the answer by the number that was added to get a number with zeros.

Do these problems by using the above method.

① $210 + 197$ ② $499 + 350$ ③ $199 + 299$

④ $400 - 199$ ⑤ $600 - 297$ ⑥ $200 - 95$

Figure 3. Exploring addition and subtraction relationally in Grade 3

Working with number sentences in uncalculated form, students are invited to transform a given expression into an “easier-to-calculate” expression, involving the same operation. The original addition question $298 + 120$ is transformed to $300 + 120$, for which the answer is 420. Having obtained this answer, students have to think whether this answer is too large or too small in relation to the original question. Here, since a larger number has been added, the answer obtained is larger (by two) than the answer to the original question. Therefore, two has to be subtracted from the answer. In the case of subtraction, taking away a larger number (in this case 200) means that one has taken away too much and the answer obtained is smaller (in this case, smaller by 2) than the answer to the original question. Therefore, two has to be added to the result of $500 - 200$ to get the answer to the original question. This method is distinct from, but clearly complements, the activity involving equivalent subtraction sentences in Grade 2. Students can now also reason that $500 - 198$ is equivalent to $502 - 200$. Teachers are expected to discuss these two methods. Relational thinking tends to branch out in different directions, as Schliemann et al. (2007) emphasise.

Fourth Grade — In the fourth grade, Japanese students learn to think relationally about division. Once again, students are expected to focus on the left-hand side of the expression. Using sheets of origami paper, students are invited to think what will happen if the individual sheets are replaced by bundles of ten and later by bundles of five.

The link to calculation is again clear, as the three examples shown at the bottom right of Figure 4 show. Students are expected to think independently before transforming each expression. The first example may be simplified by dividing both the dividend and divisor either by three or by ten, but equally both could be divided by 30. In the third example, students have several options: dividing both the dividend and divisor by 5 or 25, or multiplying both by 4. Relational approaches to division are returned to again in Grade 6.

4 Different Ways to Divide

The properties of division

1 There are 150 pieces of origami paper. If each person gets 50 papers, how many people can share the papers?

Let's think about the problem by imagining that the papers are in bundles of 10!

$150 \div 50 = 3$

$\downarrow \div 10$ $\downarrow \div 10$ equal

$15 \div 5 = 3$

$150 \div 50 = 3$

$\uparrow \times 10$ $\uparrow \times 10$ equal

$15 \div 5 = 3$

2 Let's think about the problem by imagining that the papers are in bundles of 5!

$150 \div 50 = 3$

$\downarrow \div 5$ $\downarrow \div 5$ equal

$30 \div 10 = 3$

$150 \div 50 = 3$

$\uparrow \times 5$ $\uparrow \times 5$ equal

$30 \div 10 = 3$

In division, when you multiply (or divide) both the dividend and the divisor by the same number, the quotients will remain the same.

① (1) $90 \div 30$ (2) $4800 \div 80$ (3) $800 \div 25$

Figure 4. Exploring division relationally in Grade 4

Sixth Grade — Here, students are invited to think again about division by providing different division sentences which have the answer 4 (see Figure 5 below). In the figure on the right, these different answers have been re-arranged starting with 4 and finishing with the highest number 40 so that students are able to investigate the structure of equivalent division sentences.

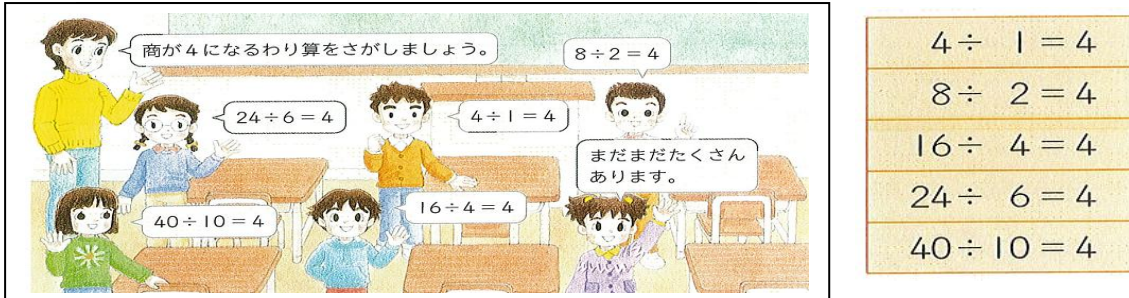

Figure 5. Teaching division relationally in Grade 6

The teacher uses the various division sentences and their repeated answer of 4 (see the right of Figure 5 above) to promote understanding the relationships between the numbers involved in these sentences. Students apply multiple perspectives to explain the relations: top-to-bottom, bottom-to-top, pair-wise comparisons, as Mason et al. (2009) point out.

When the relational properties of division were introduced in Grade 4, the dividend and the divisor were both reduced by a factor of 10, and later by 5 (see Figure 4). Here dividends and divisors are arranged with the smallest numbers at the top, and so dividends and divisors may be multiplied by the same factors without changing the result. A more systematic and formal treatment (shown in Figure 6 below) shows students that when the dividend is multiplied by 6, the divisor should be multiplied by 6 as well. But, as the frame on the right shows, dividends and divisors can be divided by the same factor as well. Being able to think relationally about division has clear pay-offs, as Wu (2007) shows, when students encounter division by decimals, and convert a decimal divisor into a whole number; and this same thinking is very helpful for understanding division by a fraction.

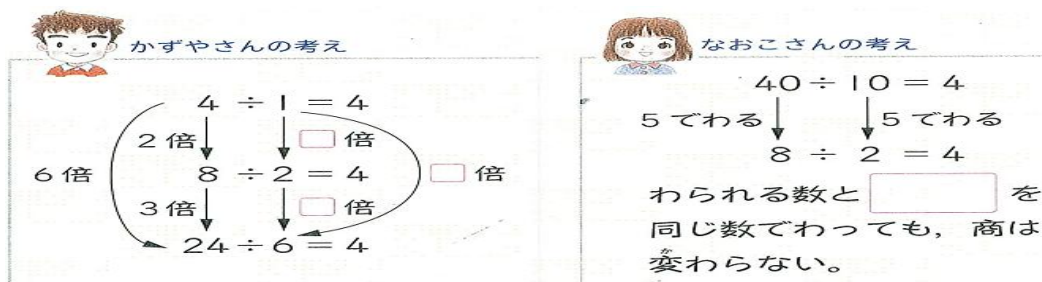

Figure 6. More relational thinking using division in Grade 6

By the end Grade 6, clear links have been built between calculation and relational thinking across the four operations – multiplication and division, and addition and subtraction – and how they behave differently. In these activities, teachers and students focus on the relationship of the numbers involved rather than looking first to calculation. Computation is used for reassurance and validation.

Building a Stronger Learning Trajectory

It can be seen that this mainstream Japanese textbook focuses on creating learning trajectories where students think deeply about the relationships in number sentences using each of the four operations. As Jacobs, Franke, Carpenter, Levi and Battey (2007) show, relational thinking has the added benefit of enhancing and supporting fluency of and efficiency in calculation. These learning trajectories are designed so that all students can engage with the problems presented to them. Of course, some will learn more than others, but the textbook authors ensure that key ideas are revisited again at different grades of the primary school. While this is intended to provide a strong foundation for starting algebra in junior high school, in a sense, algebraic thinking has already started in the primary school. The learning trajectories shown here are not simple and linear, but complex and “branchy”. Students are expected to choose transformations that make sense for them – not to follow a lock-step method. The activities chosen have to be rich enough for every student to engage and conceptually strong to develop key ideas and to promote deep mathematical thinking. Even from the examples above, some students will notice that the direction of compensation in equivalent division sentences is not unlike the direction of compensation for equivalent subtraction sentences.

As the Japanese examples show, computational knowledge is essential to lead students to relational thinking, and relational thinking has the potential to help students understand computation better and to perform it more fluently. As students move along this trajectory, they are expected to grow in confidence in using a variety of relational words, such as “equivalent to” or “means the same as” or “has the same value as”. Other relational words need to be used, such as “difference between”, “product of”, “quotient” and so on. As they move through the primary school, they will use relational words in more complex and more varied sentences, such as “The answer will be the same (in a subtraction) if each number is increased by the same amount”, or “The difference remains the same”, or “We can make this addition (or subtraction, multiplication or division) easier to calculate by changing the numbers in the following way”, or simply saying “We know the answers are equivalent”. We should expect that all students are able to think this way – some will be more fluent than others, of course, but learning to think relationally should be something that all students can develop to some degree and use in calculating more efficiently.

Japanese textbooks give just as much attention to computation and correct calculation, but they have a clear learning trajectory, which progressively develops relational ways of thinking about the four number operations. This learning trajectory is continuous and systematic throughout the primary years. We should assume that not all Japanese students are ready to understand relational ideas the first time they are introduced, but they will have many other occasions to think relationally about number sentences. Japanese textbooks develop strong patterns of relational thinking by the end of primary school. They do this not by having longer and heavier textbooks but by carefully chosen examples and a well developed learning and teaching trajectory. This is an area that many other countries could well consider for their teachers and students.

References

- Australian Curriculum and Reporting Authority (2009). *Shape of the Australian Curriculum: Mathematics*. Canberra: Author.
- Baroody, A. (1993). *Problem solving, reasoning, and communicating (K-8): Helping children think mathematically*. New York: Merrill/Macmillan.

- Carpenter, T. P., Fennema, E., Peterson, P., & Carey, D. (1988). Teachers' pedagogical content knowledge of students' problem solving in elementary arithmetic. *Journal for Research in Mathematics Education*, 19, 385 – 401.
- Carpenter, T. P., & Franke, M. L. (2001). "Developing algebraic reasoning in the elementary school: Generalization and proof". In H. Chick, K. Stacey, J. Vincent, & J. Vincent (Eds.), *The Future of the Teaching and Learning of Algebra*, (Proceedings of the 12th ICMI Study Conference, pp. 155-162). Melbourne: University of Melbourne.
- Gravemeijer, K. (1999). Developmental Research: Fostering a Dialectic Relation between Theory and Practice. In J. Anghileri (Ed.). *Principles and Practice in Arithmetic Teaching*. London: Open University Press.
- Jacobs, V. R., Franke, M. L., Carpenter, T. P., Levi, L., and Battey, D. (2007). Developing children's algebraic reasoning. *Journal for Research in Mathematics Education*, 38(3), 258-288.
- Mason, J., Stephens, M. & Watson, A. (2009). Appreciating Mathematical Structure for All. *Mathematics Education Research Journal* (MERJ), 21(2), 10-32.
- Molina, M., Castro, E., & Mason, J. (2008). Elementary students' approaches to solving true/false number sentences. *Revista de Investigacion en Didactica de la Matematica* PNA 2(2), 75-86.
- Sarama, J., & Clements, D. (2009). *Early Childhood Mathematics Education Research: Learning Trajectories for Young Children*. New York: Routledge.
- Schliemann, A., Carraher, D., & Brizuela, B. (2007). *Bringing out the algebraic character of arithmetic*. Mahwah, NJ: Lawrence Erlbaum Associates.
- Simon, M. (1995). Reconstructing mathematics pedagogy from a constructivist perspective. *Journal for Research in Mathematics Education*, 26(2), 114-145.
- Stephens, M. (2007). Students' emerging algebraic thinking in the middle school years. In J. Watson & K. Beswick (Eds.), *Mathematics: Essential Research, Essential Practice*, (Proceedings of the 30th annual conference of the Mathematics Education Research Group of Australasia, pp. 678-687). Adelaide: MERGA.
- Stephens, M. (2008). Some key junctures in relational thinking. In M. Goos, R. Brown & K. Makar (Eds.), *Navigating currents and charting directions* (Proceedings of the 31st annual conference of the Mathematics Education Group of Australasia, pp. 491-498). Brisbane: MERGA.
- Tokyo Shoseki (2006). *Mathematics for Elementary School* (Textbook Series translated in to English – almost all). Tokyo: Tokyo Shoseki Publishing.
- The Mathematical Association of America (2007). *Algebra: Gateway to Technological Future*, edited by V. J. Katz. MAA: Author.
- Wu, H. (2007). *Whole numbers, fractions and rational numbers*. Berkeley, CA: University of California.

Students' Opinions about Characteristics of Their Desired Mathematics Lessons

Peter Sullivan
Monash University

Doug Clarke
Australian Catholic Uni.

Helen O'Shea
Monash University

As part of a larger project, we examined how students describe their ideal mathematics lesson. We found that the students' comments were similar to the characteristics that are often used by researchers to delineate the features of effective teaching. In particular the students liked clear explanations, they recalled lessons that used materials that allowed connections to their lives, felt the mode of grouping to be important, and many liked to be challenged. There was diversity in the types of lessons that they described indicating that variety is also important. Teachers are encouraged to pay attention to opinions of students on the pedagogies they value.

Although our overall project, *Task Types and Mathematics Learning*²⁹ (TTML) (see O'Shea & Peled, 2009 for a description of the project) focuses on tasks, this is a report of research into student opinions about features of their ideal mathematics lesson. Our interest in lessons arose from a realisation that effective learning is not solely dependent on the quality of the tasks, but also the way the teacher implements the task, and whether the students are able to take advantage of the opportunities that working on the task might offer them.

The project draws on the Stein, Grover, and Henningsen (1996) model of task use, in which they describe how the features of the mathematical task as set up in the classroom, and the cognitive demands it makes of students, are informed by the mathematical task as represented in curriculum materials, and influenced by the teacher's goals, subject-matter knowledge and knowledge of students. This in turn informs the mathematical task as experienced by students and creates the potential for students' learning. This report is seeking to elaborate the latter aspects of the Stein *et al.* model.

There are many lists of characteristics of effective teaching, which are generally compiled theoretically, or from surveys, or from descriptions of exemplary teachers (see Clarke & Clarke, 2004; Hattie & Timperley, 2007; Education Queensland, 2010). For example, the following is the advice that we give to teachers, extracted from various similar lists that are readily available. We have added a code in brackets to allow discussion of these later.

Identify big ideas that underpin the concepts you are seeking to teach, and communicate to students that these are the goals of the teaching (*clarity*).

Build on what the students know, both mathematically and experientially, including creating and connecting students with stories that contextualise and establish a rationale for the learning (*building on experience*).

Engage students by utilising a variety of rich and challenging tasks, that allow students opportunities to make decisions, and which use a variety of forms of representation (*variety and challenge*).

²⁹ TTML is an Australian Research Council funded research partnership between the Victorian Department of Education and Early Childhood Development, the Catholic Education Office (Melbourne), Monash University, and Australian Catholic University. Barbara Clarke is also a researcher on the project but otherwise exceeded the limit for submission for the conference.



Interact with students while they engage in the experiences, encourage students to interact with each other including asking and answering questions, and specifically planning to support students who need it, and challenge those who are ready (*interacting and adapting*).

Adopt pedagogies that foster communication and mutual responsibilities by encouraging students to work in small groups, and using reporting to the class by students as a learning opportunity (*grouping*).

It seems, though, that there have been few attempts to ask students what they think of such advice, or even what alternate advice they would offer. This is a report of our attempt to gather data on the latter.

Seeking Students' Views

There have been substantial efforts to seek students' views about aspects of mathematics learning. These include nuanced approaches to students' attitudes (Hannula, 2004; McLeod & Adams, 1989) addressing psychological considerations such as identity, autonomy and social connectedness, as well as liking, enjoying, and seeing the purpose and potential in mathematics. There has also been sustained study of students' beliefs about the nature of mathematics and the way it is learned (e.g., Leder, Pehkonen, & Törner, 2002; Pajares, 1992), the values they attribute to mathematics, the way it is learned, and its uses (e.g., Bishop, 2001), the ways in which students are motivated (e.g., Middleton, 1995), and the ways that students connect learning opportunities with the way they see themselves (such as whether they can get brighter through effort), and the subject (such as whether effort leads to success) (Dweck, 2000). Zan and di Martino (2010) extended this work, arguing that there have been no connections established between attitudes and achievement, and that the emphasis should move from measuring attitudes to describing them. They questioned the often cited causal link from beliefs to emotions to behaviours, and argued that negative attitudes are just as powerful in influencing behaviour as are positive attitudes. They argued for more narrative approaches to describing student attitudes, including with large samples, with the goal of understanding behaviour. We agree with this approach and sought to extend this to seeking students' views about lessons. The questions guiding this aspect of our work were:

What do students say, unprompted, about the characteristics of lessons that they value?

How do the themes identified in the students' responses about lessons match with the perspectives in the literature generally?

Responses of Students to Pre-determined Prompts about Lessons

The data below were taken from a larger survey designed to gather responses on aspects of lessons and tasks from a cross-section of students in Years 5 to 8. The items on general aspects of pedagogy were adapted from Clarke et al. (2002) and Sullivan et al. (2009), and the items on lessons were written for this purpose. The survey was piloted with some classes of students in schools similar to those in the project, and we interviewed students in those classes to seek clarification of confusing responses. After some revision, we administered the survey.

We asked each school to nominate one of the project teachers to co-ordinate the administration of the survey across all classes of students in the target years to ensure that the students completed the survey individually and seriously. The results were entered professionally, including double checking of the entries. There were 940 students in 96 classes across 17 schools who completed the survey.

Narrative Descriptions of Students' Perceptions of Desired Characteristics of Mathematics Lessons

We sought students' perceptions of the desired characteristics of mathematics lessons through their narrative responses. It was hoped in this way to gain insights into which lesson characteristics students valued most, rather than through their ratings of lesson characteristics described by us. We did this by seeking:

- open-ended responses to particular prompts on the overall survey; and
- free-format essays by students from two schools.

These approaches and the students' descriptions are described in the following sections.

Responses from the Overall Survey on Desired Lesson Characteristics

One of the prompts on the survey asked the students to write a free format response to the following:

Think about all the maths lessons you have EVER BEEN IN. Now think about the best maths lesson you have EVER BEEN IN. Describe what you did in that lesson.

The responses were generally informative but brief. The following are examples of medium-length responses.

We played the grand final of maths football. You have to answer questions and if you get them before you aponint (sic) the football goes closer to your goal. We won.

We did long jump outside and then we measured everyones and then put it in a chart.

All responses were read and preliminary categories for grouping the students' responses identified. The various responses were then coded by a second researcher, and adjustments made to the categories. To indicate the types of responses given by students, and the ways that we applied the codes, the following are some illustrative sentences and phrases allocated to particular categories. We coded as:

game that taught us maths general statements such as "we played maths games on the computer", and more specific statements such as "we coloured in some boxes on a fraction we roll 2 dice whatever fraction you get you colour in".

particular topic statements such as "we added fractions. We learnt how to add them with different dimoniaters (sic)", "algebra (sic) would be the best lesson because I was good at it", "I liked percentage. At the start of the term I couldn't understand but when my friend's and my teacher helped me it became easy as + and -", "when I was learning about decimals", "learnt how to add and subtract mixed numbers and turn them into improper fractions".

particular operation statements such as "I was starting to learn multiplication and I got it so easy and I loved it."

used or made a model general statements such as "when we did hands on activities" and more specific comments such as "smarties maths. We used smarties to work out fractions (colours). It was really fun!", "when we were making the maps of a town with 24 houses", and even (!) "when we drew Cardoids, Mystic Roses Hyperbola".

That last comment was of course delightful to read but it was clear that all of the 940 students were able to describe a lesson they liked. The number of comments coded in the various categories are summarised in Table 1. Note that one student might have comments coded in more than one category.

Table 1:

Number of Student Comments in Various Categories of the “Best” Mathematics Lesson (n = 930)

Category of response	Total mentions
Game that taught us maths	184
Competition or test on maths we know	83
Outside activity	59
Particular topic e.g. Measurement	395
Real-life problem e.g. Water in tank, maths to make food	49
Used or made a model e.g. Pita bread for fractions	258
Particular operation e.g. Multiplication	119
Learned mathematics I didn't know before	16

The most striking aspect is the diversity of lesson elements students chose to mention. We had perhaps anticipated that students would like games, real life problems, and use of models, but were surprised at the number of responses that focused on a particular topic. To explore this further, Table 2 presents some of the above categories combined.

Table 2:

Combined Categories of Responses to Characteristics of Best Lesson (n =930)

Category of response	Total mentions
Engaging pedagogies (Game, outside activity, real life, etc)	633
Topic, operation, or learned maths	530

In other words, close to half of the students in describing their “best” mathematics lesson referred to a specific topic, and just over half mentioned pedagogy. This surprised us. We had earlier asked students to rate their level of confidence that they can do mathematics using the prompt “*How good are you at mathematics?*” To explore whether a reference to a topic was a characteristic of a particular type of student, we compared the responses given by the lowest third of the students on their self rating of confidence, and those given by the highest third. Table 3 presents the number of responses in each of the categories in the previous table.

Table 3:

Number of Students in Combined Categories broken down by Self Rating of Confidence

Category of response	Low (n= 337)	High (n = 292)
Engaging pedagogies (Game, outside, real life)	233	187
Topic, operation, or learned maths	174	177

There was a slight tendency for the students who rated themselves as confident to mention a topic. Nevertheless the interesting feature is that many students who rate themselves as lacking confidence at mathematics mention a topic, while many of those students who rate themselves as confident referred to an aspect of pedagogy.

These tables, taken together, indicate that the pathway to student engagement is not solely through creative pedagogies, and that many students recalled as a best lesson one in which the learning of a specific topic was the memorable feature. It is also notable that many students mentioned both a creative pedagogy and a topic: for example, going outside to do measurement. We infer that these students see lessons as about learning, and the topic they mentioned is connected to this learning. At the same time, many students refer

to particular engaging pedagogies, and so teachers need to consider this in their planning as well. We suspect that finding interesting ways to help students learn a particular topic is the ideal combination.

To explore the reasons behind the students' descriptions of their best lesson, we also invited them to answer, in free format:

Why did you choose that as the best maths lesson ever (that is, what made it best)?

Again categories were created, and progressively refined. The following were the categories that seemed to capture the major themes, along with an illustrative example of some students' statements:

Challenging: "It was one of the most challenging maths lessons, and the feeling of achieving the answer was great", "I like that maths lesson because you had to think"

Easy: "I chose that one because it wasn't too hard for me", "Because we didn't have to do any work"

Fun/interesting: "Because we had fun" "It was entertaining and fun because it was a race to win a game"

I learned something new: "Because I learnt how to times decimals"

I'm good at this: "Because I was the only person that knew it", "I chose that as the best maths lesson because I'm really good at"

Went outside: "We got outside, in the fresh air and did real life mathematics", "We got to run around and use our brains at the same time"

Worked in groups: "I really love working in groups and I think that working in groups makes me think better", "We got to do stuff with friends"

Made a model: "We did more 'hands on' than paper and pen", "I love creating things and we got to make a robot"

Table 4 presents the frequencies of statements coded in this way for this prompt:

Table 4:

Frequencies of Particular Responses Explaining their Choice of a Best Lesson (n = 930)

Category of response	Number of mentions
Challenging	89
Easy	65
Fun/interesting	502
I learned something new	179
I'm good at this	101
Went outside	47
Worked in groups	51
Made a model	80

Again the diversity of comments is noteworthy. The most frequently used code, with around 45% of responses overall, was the *fun/ interesting* category indicating that this is indeed an important aspect of planning mathematics learning experiences. There were 369 responses that referred to learning something new, to facility at the task, and to challenge, indicating that some students respond to these aspects as well. It seems that the advice to teachers is to devise "fun/ interesting" ways for students to learn something new while they are being challenged.

In summary, the main impression from these responses is their diversity, and there is clearly a range of ways in which students respond to lessons. There were two trends in

their lesson descriptions of, on one hand, students recalling effective teaching of a content topic, whereas there were others who remembered interesting aspects of the pedagogy. In explaining their choice of lesson, the main category of responses related to fun/ interesting, but learning something new was also frequently cited.

Students' Essays on their "Ideal Maths Class"

We also sought students' views on lessons and teaching through a particular prompt seeking narrative responses. We asked Years 5 and 6 students at two of the schools where teachers developed a lesson sequence using task types (a different aspect of our overall project) to write an essay, the particular prompt of which was:

Write a story about your ideal maths class. Write about the sorts of questions or problems you like to answer, what you like to be doing and what you like the teacher to be doing in your ideal maths class.

The intention was to gain insight into what the students recalled about their mathematics classes, and it can be assumed that these responses can be taken as indicative of the lesson features that the students liked. The following is an example of a typical student's essay, presented as it was written:

My favorite maths would start with a 10 min introduction were the teacher explains the game to all of us and still allowing time for questions. The games would be 2+ people for a competition and people will split into groups and will organize who plays who 5 min every one will be playing at all times unless there is an odd amount of people we will play for 25 min. at the end of the Lesson the groups will figure out who was the winner and people can share what they Learnt Liked and strategys they used. Sharing is for 10 min. for my second option I would do real life problems Like 250 grams of sugar for \$10.50 or 750 grams for \$33.15. I like real life problems because they could help me one day and its set out differently than math. for this the explanation is for 5 min this is because you don't need to explain the rules.

This response is illustrative of the detailed way that students responded to the prompt. In fact all of the students gave a thoughtful and detailed response. In this response there were three key elements: the use of a game; the use of real life problems; and the mention of the grouping of students.

Each of the responses was read, and a preliminary set of codes established. A second reader then used the first set of codes and added others as appropriate. Where a sentence or phrase could be categorised in two places, this was done.

The first characteristic of the responses overall was the diversity of aspects on which individual students commented, again suggesting that there is no commonly agreed ideal lesson, and there are many ways that students experience engaging lessons. The following indicates trends or themes in the responses. Since it seemed that there were aspects of the responses idiosyncratic to the particular schools, the responses from the two schools are discussed separately.

In the outer suburban school, there was a total of 39 students in two classes, one Year 5 ($n=21$), the other Year 6 ($n=18$). Unless otherwise stated the responses were from both classes. In this school, the Year 6 class mainly responded in point form, and so multiple aspects were mentioned by many students.

Thirty students included a desire for materials in their ideal lessons, and some mentioned specific examples such as teddy bears, robots, alarm clocks, class market, and mapping. These are not the structured materials that teachers would expect to see in such responses. There were also 25 specific references to working outside (12 Year 5, 13 Year 6). Given that one suspects that this happens quite rarely, this is a surprising result. It is worthy of note that some students in the survey also mentioned going outside as their best

lesson. Fourteen students mentioned a connection to practical aspects such as food, money, and newspapers.

There were 25 specific mentions of working in groups as part of their ideal class, and a further 15 mentions of working in pairs. Note that there were also 9 students who wrote that they preferred to work alone. The ways of working in class are clearly important for students, and however the teacher intends that the student work, the reason for this needs to be clarified for the students.

There were 22 students who wrote that they liked to be challenged, and 15 students wrote that they liked open-ended tasks or those that had more than one answer, although all 15 were from the Year 5 class. Twenty-three students liked to be helped by the teacher, although most of these were also from Year 5. A further 14 students, again mainly from the Year 5 class, wanted their teacher involved by circulating, listening or sitting down with the students. Interestingly many of these students indicated that they preferred to work uninterrupted by the teacher or their peers.

Nineteen students wrote that they liked clarity in both the lesson goals and in teacher explanations, using phrases such as “makes sure we understand”, “gives examples” and “explains focus of lesson”.

In the inner suburban school, there were three mixed Years 5 and 6 classes involving 65 students. There were similarities in the responses of the students across the classes. Fifty students wrote that the ideal lesson included working in groups, in pairs, or with friends, but 10 wished to work alone. Twenty-two students mentioned explanations and 7 referred to the teacher’s interactions with students. Twenty-six students claimed to like a challenge. Nineteen specifically mentioned fun or enjoyment, 22 mentioned games, 17 mentioned specific hands-on activities, 13 mentioned specific measurement activities, and 15 gave examples that connected learning to their lives. As with the other school, 18 students saw their ideal lesson as being outside!

Both schools were technology rich, and it was therefore interesting that very few students mentioned working with computers or other technology. Perhaps they saw the availability of technology as a given, but the scarcity of such mentions may require some further investigation.

In summary, it seems that the responses to this prompt about an ideal lesson seemed dependent on the teacher. In synthesising the responses, students like lessons that used materials (although these were not structured materials), were connected to their lives, were practical with some emphasis on measurement, in which they worked outside, with the method of grouping being important, and over half of the students claim to like to be challenged. Some implications of these issues are discussed below.

Summary and Conclusion

All students we asked had clear views on the nature of mathematics lessons, and were prepared to articulate those views. In terms of the hypothetical descriptions of effective teaching given above, we argue that:

- *clarity* was important given the prominence of mentions of specific topics, and the importance to students of clear explanations;
- *building on experience* was important in terms of the mentions of use of materials (although these were not structured materials), and connections to their lives;
- *variety* was perhaps the key theme in both aspects of the data and this variety is needed because different students like different approaches;

- *challenge* is important since it was mentioned unprompted by many students; and
- *grouping* seemed important to students as a way of learning.

The advice above termed *interacting and adapting* was also prominent in the responses, although in this case perhaps in the direction opposite to that indicated by the advice. Some students emphasised that they only wanted to be helped when needed, while others wanted to work uninterrupted by either classmates or teachers.

In general, the results seem a very strong endorsement of the earlier list of recommendations to teachers, noting that the endorsement comes from the very people who most need interesting and engaging lessons: the students.

References

- Bishop, A. J. (2001). What values do you teach when you teach mathematics? In P. Gates (Ed.), *Issues in mathematics teaching* (pp. 93-104). London: Routledge Falmer.
- Clarke, D., Cheeseman, J., Gervasoni, A., Gronn, D., Horne, M., McDonough, A., Montgomery, P., Roche, A., Sullivan, P., Clarke, B., & Rowley, G. (2002). *Early numeracy research project: Final report*. Australian Catholic University and Monash University.
- Clarke, D. M., & Clarke, B. A. (2004). Mathematics teaching in Grades K–2: Painting a picture of challenging, supportive, and effective classrooms. In R. N. Rubenstein & G. W. Bright (Eds.), *Perspectives on the teaching of mathematics* (66th Yearbook of the National Council of Teachers of Mathematics, pp. 67-81). Reston, VA: NCTM.
- Dweck, C. S. (2000). *Self-theories: Their role in motivation, personality, and development*. Philadelphia: Psychology Press.
- Education Queensland. (2010). *Productive pedagogies*. Downloaded in January 2010 from <http://education.qld.gov.au/corporate/newbasics/html/pedagogies/pedagog.html>
- Hannula, M. (2004). *Affect in mathematical thinking and learning*. Turku: Turun Yliopisto.
- Hattie, J., & Timperley, H. (2007) The power of feedback. *Review of Educational Research*, 77(1), 81-112.
- Leder, G., Pehkonen, E., & Törner, G. (2002). *Beliefs: A hidden variable in mathematics Education*. Dordrecht: Kluwer.
- McLeod, D. B., & Adams, V. M. (1989). *Affect and problem solving*. New York: Springer-Verlag.
- Middleton, J. A. (1995). A study of intrinsic motivation in the mathematics classroom: A personal construct approach. *Journal for Research in Mathematics Education*, 26 (3), 254-279.
- O’Shea, H. & Peled, I. (2009). The Task Types and Mathematics Learning research project. In R. Hunter, B. Bicknell, & T. Burgess (Eds.) *Crossing divides* (Proceedings of 32nd annual conference of the Mathematics Education Research Group of Australasia, Volume 2, pp. 714-718). Palmerston North, New Zealand: MERGA
- Pajares, M. F. (1992). Teachers’ beliefs and educational research: Cleaning up a messy construct. *Review of Educational Research*, 62(3), 307-332.
- Stein, M. K., Grover, B. W., & Henningsen, M. (1996). Building student capacity for mathematical thinking and reasoning: An analysis of mathematical tasks used in reform classrooms. *American Educational Research Journal*, 33(2), 455-488.
- Sullivan, P., Prain, V., Campbell, C., Deed, C., Drane, S., Faulkner, M., McDonough, A., Mornane, A., & Smith, C. (2009). Trying in the middle years: Students’ perceptions of their aspirations and influences on their efforts. *Australian Journal of Education*, 5(2), 176-191.
- Zan, R., & di Martino, P. (2010). “Me and maths”: Toward a definition of attitude grounded on students’ narrative. *Journal of Mathematics Teacher Education* 13 (1), 27-48.

The Multifaceted Variable Approach: Selection of Method in Solving Simple Linear Equations

Salma Tahir
Macquarie University
<mrs_galaxy@hotmail.com>

Michael Cavanagh
Macquarie University
<michael.cavanagh@mq.edu.au>

This paper presents a comparison of the solution strategies used by two groups of Year 8 students as they solved linear equations. The experimental group studied algebra following a multifaceted variable approach, while the comparison group used a traditional approach. Students in the experimental group employed different solution strategies, namely balancing method, working backwards and guess and check for solving different linear equations, whereas students in the comparison group tended to use a single, procedural approach. It is concluded that the multifaceted approach developed students' concepts not only of variables but also of equations.

Students' understanding of core algebraic concepts of variable and equivalence influences their success in solving problems, the strategies they use, and the justification they give for their solutions (Knuth, Alibali, McNeil, Weinberg, & Stephens, 2005). Students who interpret letters as specific unknowns and not as generalised numbers or variable quantities learn the procedures of manipulation and substitution without assigning any meaning to the symbols (Booth, 1995). Misconceptions about the variable, such as "whenever a letter stands alone it is equal to 1" and "letters and numbers are detached", are also responsible for student difficulties in equation solving (Perso, 1991). These misconceptions are carried forward into concepts like equality and equation solving and students think that the meaning of the equality sign is always an instruction to find the answer by carrying out some calculation (Kieran, 1981). Students misapply rules for transforming equations, which could be due to misinterpretation of algebraic expressions or not understanding the given situation (Nunes, Bryant, & Watson, 2007). The results of the National Assessment of Educational Progress indicated that mathematics instruction in Year 8 focused on learning skills and procedures rather than developing reasoning ability or communicating ideas effectively (Mitchell, Hawkins, Jakwerth, Stancavage, & Dossey, 1999).

Different teaching approaches such as a functional approach, a problem solving approach and a generalisation approach have been suggested from time to time as a way of teaching beginning algebra. However, research has also indicated a range of difficulties associated with each of these approaches (Booth, 1988; Küchemann, 1981; Sfard & Linchevski, 1994). Trigueros and Ursini (2001) presented a teaching model to approach the study of algebra. In this 3UV model, they suggested that three aspects of variables — namely unknown, variable and generalised number — should be studied one by one and then these three aspects should be integrated so that students can acquire a holistic concept of variable. The effectiveness of this teaching model is not supported by any reported research. The fact is that the aspect of a variable as an unknown quantity is automatically included in the other two aspects (variable as a function and variable as a generalised number). However, generalised numbers associate variables with multiple values and are not sufficient to indicate the relationship between quantities, which is an essential ingredient in representing a problem algebraically. Therefore it is necessary for variable as a function to be studied together in parallel with generalised number using multiple



representations and real contexts so that a complete meaning can be associated with the term ‘variable’. After studying variables in Year 7 students can then move on to symbol manipulations and the solution of linear equations in Year 8 — a *multifaceted variable approach*.

In earlier research (Tahir, Cavanagh, & Mitchelmore, 2009), found that students who were taught using a multifaceted variable approach did attain a deeper understanding of the variable concept. In this paper, we investigate whether this improved understanding of variables helped the students in solving linear equations. The hypothesis is that students who are taught using a multifaceted approach will be more successful in solving linear equations. To test this hypothesis, the equation solving strategies of students taught using the multifaceted variable approach were compared with those used by students who were taught in a traditional way.

Solution Strategies

When students are presented with an equation such as $x + 5 = 8$, they usually see it as an arithmetic process and they prefer to use guess and check or working backwards as a strategy to solve this equation. It is not until they come across an equation of the type $2x + 5 = x - 7$, with x on both sides, that they are forced to think of an equation as an object to be operated upon to solve it (Sfard & Linchevski, 1994). Kieran (1992) presented a summary of strategies used by students to solve a linear equation, namely, known facts, counting techniques, guess and check, cover up, working backwards, and formal operations. These equation solving strategies can be arranged from least to most sophisticated as guess and check, using known facts/counting strategies, inverse operations, working backwards then guess and check, working backwards then known fact, working backwards and transformations (Linsell, 2009). The most sophisticated strategy of transformations is understood by very few students (Linsell, 2009).

Method

The study was conducted in a girls’ secondary school in Sydney where some teachers used our multifaceted variable approach to teach algebra. This two year, longitudinal study was completed in two phases. Phase 1 was conducted with students and teachers of Year 7 and focused on the concept of variable acquired by the students. The error analysis indicated that experimental classes demonstrated a deeper conceptual understanding of variable as compared to the comparison classes in Year 7 (Tahir, Cavanagh, & Mitchelmore, 2009). Phase 2 was conducted with the same cohort of students then promoted to Year 8, and with their same teachers when the classes were learning how to solve simple linear equations. Phase 2 focused particularly on the students’ solution strategies since they are not only alternative approaches to solving equations but they also represent different stages of conceptual development (Filloy & Sutherland, 1996).

Sample

The sample consisted of four classes graded by the school on the basis of their mathematical ability at the beginning of Year 7. Students of Set1 (high ability, 26 students) and Set3 (medium ability, 26 students) formed the comparison group and students of Set2 (medium Ability, 27 students) and Set4 (low ability, 19 students) formed the experimental group. The experimental group was taught using the multifaceted variable approach; they studied three aspects of variable (unknown, generalised number, and functions) in Year 7 before moving on to manipulation and solution of linear equations using real contexts in

Year 8. The comparison group studied patterns for generalisation but spent most of their Year 7 lessons learning to manipulate and simplify algebraic expressions. In Year 8 they also studied symbol manipulation and the method of solving simple linear equations.

Phase 2

Phase 2 covered the Year 8 algebra lessons. A meeting with the teachers of experimental group took place at the beginning of this phase. Results of Phase 1 were discussed and “Working mathematically: Patterns and Algebra” Workbook B (McMaster & Mitchelmore, 2008) was given to the teachers of experimental group. The syllabus arrangement of both groups is given in Table 1.

Table 1
Syllabus arrangement of classes

Sample	Topics
Comparison Group	Translate between words and algebraic symbols, expand, simplify and factorise algebraic expressions and fractions including expressions with indices, solution of simple linear equations
Experimental Group	Algebra in spreadsheets, simplify and factorise algebraic expressions and fractions, solution of simple linear equations

Set1 completed the entire Year 8 algebra course in seven weeks (six lessons/week) whereas Set2, Set3 and Set4 required an additional two weeks (eight more lessons) to complete the algebra course. During these two weeks Set1 was involved in enrichment work in algebra, including algebraic fractions, linear inequalities and solving simultaneous equations.

After nine weeks of algebra teaching, a test designed by their teachers in consultation with the first author was administered to all students. Set1, Set2 and Set3 was given the same test but some questions were replaced by easier questions for Set4 (the low ability class). This test included multiple choice, short response and extended response questions on algebra and geometry. In the algebra section, students were given two multipart, short response questions targeting algebraic manipulations (addition, subtraction, multiplication, division, factorisation, and expansion) and two separate questions where they were required to solve simple linear equations. One week after the algebra test, students were given a separate 15 minute algebra quiz designed by the first author. This quiz was intended to assess the skills of identifying equivalent equations as well as transforming one equation into another to show the equivalence. With easy access to computer algebra systems (CAS) and calculators which can solve a simple linear equation, the recognition of equivalent equations and the skill of transformation of an equation into another has become central for success in algebra (Ball, 2001).

During algebra teaching, one lesson per week of each class was observed by the first author. After the algebra test, 5-6 students of varying ability, selected by their teachers, were also interviewed by the first author. This paper will focus on similarities and differences between the experimental and comparison group in the selection of solution strategies for solving a linear equation, in order to investigate which approach might be more suitable for teaching linear equations.

Results and Discussion

The linear equations solved by students in the algebra test given after nine weeks of algebra teaching test are listed in Table 2 as Q1. Table 2 also shows as Q2 the quiz given a week after the algebra test.

Table 2

Linear equations solved by all classes in algebra test.

Q1 Solve

i) $n + 6 = 4$

ii) $7x = 56$

iii) $\frac{p}{5} = 9$

iv) $3(m - 1) = 18$

v) $\frac{p}{5} + 6 = 9$

vi) $7x - 2 = 5x + 8$

Q2 Which of the following equations can be transformed to $x - 2 = 0$? For the ones that can be transformed to $x - 2 = 0$, show how you realised this.

a) $2x = 4$

b) $4 = 2x$

c) $\frac{x}{2} = 4$

d) $4x = 2$

e) $x + 1 = 3$

f) $x - 3 = 1$

For Q1, student responses were allocated a score of 1 for correct and 0 for incorrect, and a total score was calculated by adding their marks in all six equations. One way ANOVA indicated significant differences between all four participating classes ($F(3, 86) = 6.10, p < 0.001$). A Bonferroni post hoc test showed no significant difference between Set1 and Set2 or between Set3 and Set4, all other differences being significant.

The mean of all participating students considered as one sample indicated that the linear equations in Q1 were numbered in order of the difficulty level. Moreover, the simple one step linear equations given in part i, ii and iii of Q1 could be classified together at a lower difficulty level and the two-step linear equations given in part iv, v and vi were at a comparatively higher difficulty level (see Table 3).

Table 3

Mean and Standard Deviation of all students

Equation	$n+6=4$	$7x=56$	$p/5=9$	$3(m-1)=18$	$p/5+6=9$	$7x-2=5x+8$
Mean	0.97	0.94	0.93	0.69	0.65	0.63
Standard Deviation	0.17	0.24	0.26	0.47	0.48	0.49

Solution strategies used for Q1

The solution strategies selected by students were the balancing method, working backwards, guess and check, and some students just gave their answer without any calculation or justification.

1. Balancing method (B): for example $2x = 4$, dividing both sides by 2 results in $\frac{2x}{2} = \frac{4}{2}$ giving answer as $x = 2$.

2. Working Backwards/Inverse Operations (WB): for example $2x = 4$ (inverse of multiplications is division therefore) $x = \frac{4}{2} = 2$ or for $x + 1 = 3$, $3 - 1 = 2$ therefore, $x = 2$.
3. Guess and Check (G&C)/Known fact: for example: $2x = 4$ as $2 \times 2 = 4$, $x = 2$ or $x - 3 = 1$ as $4 - 3 = 1$ therefore $x = 4$.
4. Answer without justification (Ans): answer given without any calculation or justification.

The percentage of all student responses in each category, pooled across all parts of Q1, was calculated for each participating class. The resulting percentages are represented in Figure 1. Recall that Set1 and Set3 were the comparison classes and Set2 and Set4 the experimental classes.

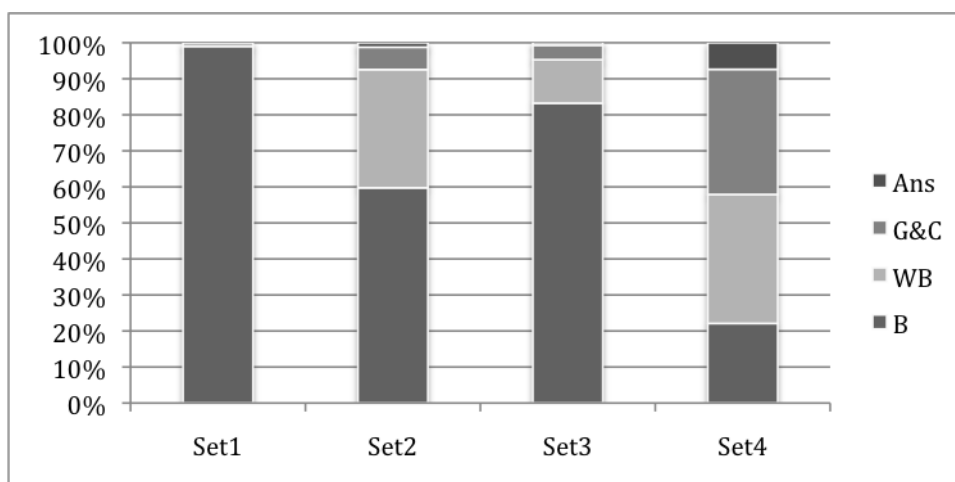

Figure 1. Distribution of various solution methods used by participating classes in Q1 (B: Balancing method, WB: Working backwards, G&C: Guess and check, Ans: Answer).

In Set1, all students used the balancing method to solve all of the linear equations, except for one student who chose working backwards in part iv of Q1. It is worth noting that the balancing method was the only method which was used by their teacher in algebra lessons. In Set3, the main method selected to solve linear equations was again the balancing method (74% of responses). Some students who were not successful in using the balancing method reverted back to arithmetic methods such as guess and check (12%) and working backwards (4%) This class was also taught using the balancing method to solve equations in their lessons and guess, with check as an alternate way of finding the solution of a simple linear equation. In some instances the teacher also explained the balancing method by demonstrating the procedure of working backwards.

The teachers of Set2 and Set4 used the given teaching resource (McMaster & Mitchelmore, 2008) which focused on the meaning of variable in each problem. Students in experimental group (Set2, Set4) mostly used the method of inverse operations and less time was spent on the balancing method.

Despite these differences, the comparison groups (success rate: 85%) and experimental groups (86%) were equally successful in using the balancing method to solving the given equations. For example, 89% students of Set2 were able to correctly solve part vi of Q1, as compared to 81% students of Set1. It appeared that the experimental group's extensive use

of the working backwards strategy had helped them understand and use the balancing method as accurately as the high ability class.

It is interesting to note here that the percentage of responses in Set2 that showed the balancing method was smaller than the percentage of such responses in Set3. Therefore it is not always necessary that high ability students automatically choose a more sophisticated method to solve an equation. Furthermore, the selection of solution strategy made by the experimental classes depended upon the equation to be solved. Sometimes the students in the experimental classes were more successful in selecting a suitable strategy to correctly solve linear equations than those in the comparison group; for example, Set 4 used guess and check in part v of Q1 more successfully than Set3, who mostly used the balancing method).

Students used the following three methods to solve Q2, namely the transformation method, the substitution method, the comparison method. Also, some students just solved the equations one by one and did not select any equation as an answer.

1. Transformation method (T): Transform each equation one by one (using balancing method or inverse operations/working backwards). For example: $x + 1 = 3$, subtract 3 from both sides to get $x + 1 - 3 = 3 - 3$, thus $x - 2 = 0$. Or solve the equation first as $x + 1 = 3$, $x + 1 - 1 = 3 - 1$, $x = 2$, and then transform as $x - 2 = 2 - 2$ giving $x - 2 = 0$
2. Substitution method (S): Solve equation $x - 2 = 0$ as $x = 2$, then substitute $x = 2$ in the given equations one by one; if the equation is true, then mark it as the answer. Or solve each equation and substitute answer in equation $x - 2 = 0$ to verify.
3. Comparison method (C): Solve the equation $x - 2 = 0$ as $x = 2$ first, then solve other equations one by one using any method such as balancing method, working backwards or substitution, .if the answer is also $x = 2$ that equation is marked as the answer.
4. Solve the equations by any method of choice like balancing, working backwards, guess and check or substitution then a) select some equations as equivalent to the given equation $x - 2 = 0$ without giving any justification (Answer without justification (Aj)) or b) no equation selected as an equivalent equation (Equation not identified (Ai)).
5. Equivalent equations identified without solving the equation (As): Equivalent equation selected without solving the equation.
6. Not solved or incorrectly solved (NA): Equation not solved or incorrectly solved and no equation is selected as answer.

The percentage of student responses in each category, pooled across the various parts of Q2, was calculated for each class and is shown in Table 4.

Table 4
Percentage of student responses using various methods in Q2

	T	S	C	Aj	Ai	As	NA
Set1	13	63	5	16	0	1	1
Set2	16	29	6	33	11	3	2
Set3	7	19	1	56	0	15	1
Set4	8	2	0	17	55	0	18

Note: T: Transformation method, S: Substitution method, C: Comparison method, Aj: Answer without justification, Ai: Equation not identified, As: Answer without solving equation, NA: Not solved or incorrectly solved and no equation selected as answer.

Students who used the transformation method were operating on an equation algebraically rather than numerically, and slightly more responses in the experimental group (22%) crossed this boundary than in the comparison group (20%). The percentage of responses which used the substitution method decreased with the ability level of the class. Note that the comparison classes started algebraic manipulations with finding unknowns in an algebraic expression in Year 7 and then they moved on to the balancing method to solve a linear equation. Thus the inclination to solve each equation mainly by using the balancing method and then using a substitution method to answer the Q2 was most likely due to the frequency of these two methods in their lessons.

The mean percentage of students selecting an equation as their answer without giving justification was highest in Set3 (56%) and not giving any answer after solving the equation was highest in Set4 (55%) (not surprising, as this class had not studied the topic of equivalent equations in their lessons). Set1 and Set3 have studied equivalent equations before the quiz and Set2 had also completed this topic during their algebra lessons.

Discussion and Implications

Students' selection of a solution strategy depended extensively on the strategies employed by their teachers to solve linear equations in their lessons. The experimental group selected a solution strategy which they thought was more suitable to solve the given equation, and they were more successful in solving some linear equations as compared to the comparison classes. For example, 74% students in Set2 chose the balancing method to solve $7x - 2 = 5x + 8$ and 89% of them were able to solve this question correctly, as compared to 81% students of Set1 — despite the fact that Set1 was the highest ability class who also studied advanced topics such as simplifying expressions with indices, factorisation of algebraic fractions and solving simultaneous linear equations. This result suggested that the experimental group was not automatically solving each question by the same method practiced in the class. They were dealing with each equation on its merit.

The comparison classes used the balancing method throughout their lessons. However, more students in the comparison classes used substitution or comparison methods to show the equivalence of two equations. This finding suggests that they were associating equivalence of equations with finding a common numerical solution of the given equations. Whereas the experimental classes had spent less time on manipulation of algebraic terms and on solving equations by the balancing method, still more students in the experimental group used a transformation method to show the equivalence of two equations as compared to the comparison group. It was also very encouraging that some

students in the low ability experimental class linked equivalence of an equation with finding a transformed equation.

The results of Phase 1 showed that students who used a multifaceted variable approach acquired a deeper understanding of variable (Tahir, Cavanagh, & Mitchelmore, 2009). The results of Phase 2 suggest that they also formed a deeper understanding of equations, and were equally successful in solving linear equations as the comparison group. The experimental group came in contact with problems based on real contexts, and had to think about the variable involved and decide on a suitable solution strategy. The reinforcement of a strategy by solving many exercises may give students an advantage in getting good marks, however this does not mean that they are learning algebra with understanding. It appears that a multifaceted variable approach does help students learn algebra with understanding.

References

- Ball, L. (2001). Solving equations: Will a more general approach be possible with CAS? In H. Chick, K. Stacey, J. Vincent, & J. Vincent (Eds.), *The future of the teaching and learning of algebra: Proceedings of the 12th ICMI Study Conference*, (pp. 48-52). Melbourne: University of Melbourne Press.
- Booth, L. R. (1988). Children's difficulties in beginning algebra. In A.F. Coxford & A. P. Schulte (Eds.), *The ideas of algebra, K-12, 1988 Yearbook*, (pp. 20-32), Reston, Va.: NCTM.
- Booth, L. R. (1995). Learning and teaching algebra. In L. Grimison & J. Pegg (Eds.), *Teaching secondary school mathematics*, (pp. 104-119). Melbourne: Harcourt Brace & Company.
- Filloy, E., & Sutherland, R. (1996). Designing curricula for teaching and learning algebra. In A. Bishop, C. Keitel, J. Kilpatrick, & C. Laborde (Eds.), *International handbook of mathematics education*, (pp. 139-160). Dordrecht, The Netherlands: Kluwer.
- Kieran, C. (1981). Concepts associated with the equality symbol. *Educational Studies in Mathematics*, 12, 317-326.
- Kieran, C. (1992). The learning and teaching of school algebra. In D. A. Grouws (Ed.), *Handbook of research on mathematics teaching and learning*, (pp. 390-419). New York: MacMillan.
- Knuth, E.J., Alibali, M.W., McNeil, N. M., Weinberg, A. & Stephens, A. C. (2005) Middle school students' understanding of core algebraic concepts: Equivalence & variable. *ZDM*, 37(1), 68-76.
- Küchemann, D. (1981). Algebra. In K. Hart (Ed.), *Children's understanding of mathematics: 11-16* (pp. 102-119). London: John Murray.
- Linsell, C. (2009). *A hierarchy of strategies for solving linear equations*. In R. Hunter, B. Bicknell, T. Burgess. *Crossing Divides: Proceedings of 32nd conference of Mathematics Education Research Group of Australasia*. Palmerston North, New Zealand: MERGA
- McMaster, H., & Mitchelmore, M. (2008). *Working mathematically: Patterns and Algebra, Stage 4, Part B*. Sydney: Workingmaths.
- National Centre for Education Statistics (1999). *Student work and teacher practices in mathematics*. Retrieved December 12, 2009 from <http://nces.ed.gov/Pubsearch/pubsinfo.asp?pubid=1999453>
- Nuffield Foundation (2007). *Key understandings in mathematics learning*. Retrieved February 12, 2010 from http://www.nuffieldfoundation.org/go/grants/education/page_683.html
- Perso, T. F. (1991). *Misconceptions in algebra: Identification, diagnosis and treatment*. Unpublished doctoral thesis, Curtin University of Technology, Perth.
- Sfard, A. & Linchevski, L. (1994). The gains and pitfalls of reification: the case of algebra. *Educational Studies in Mathematics*, 26, 191-228.
- Tahir, S., Cavanagh, M., & Mitchelmore, M. C. (2009). *A multifaceted approach to teaching algebra: Students' understanding of variable*. Paper presented at the 33rd Conference of the International Group for the Psychology of Mathematics Education, Thessaloniki, Greece.
- Trigueros, M., & Ursini, S. (2001). Approaching the study of algebra through the concept of variable. In H. Chick, K. Stacey, J. Vincent, & J. Vincent (Eds.), *The future of the teaching and learning of algebra: Proceedings of the 12th ICMI Study Conference*, (pp.598-605). Melbourne: University of Melbourne
- Thanks are extended to Assoc. Prof. Michael Mitchelmore for his extended support, draft editing and advice throughout this research project.*

Interactive Whiteboards and all that Jazz: Analysing Classroom Activity with Interactive Technologies

Howard Tanner

Swansea Metropolitan University

howard.tanner@smu.ac.uk

Gary Beauchamp

University of Wales Institute Cardiff

gbeauchamp@uwic.ac.uk

Sonia Jones

Swansea Metropolitan University

sonia.jones@smu.ac.uk

Steve Kennewell

Swansea Metropolitan University

steve.kennewell@smu.ac.uk

The term ‘orchestration’, has been used to describe the teacher’s role in activity settings incorporating interactive technologies. This musical analogy suggests pre-planned manipulation of events to generate ‘performance’ leading to learning. However, in two recent projects we have observed how effective teaching and learning is often based on serendipity and improvisation – characteristics more often associated with jazz. This paper explores how a jazz analogy can be useful when analysing classrooms in which serendipitous events were exploited and performances were improvised

During the last decade, interactive whole-class technologies (IWCTs) such as interactive whiteboards (IWBs) have become increasingly prevalent in classrooms. In the course of two funded studies (see Kennewell et al., 2009a; 2009b), a framework of classroom use of ICT was developed (Tanner et al, 2005; Beauchamp & Kennewell, 2010) which examined the orchestration of activity settings (Tharp & Gallimore, 1988). Emerging from this work was the need to take account of serendipity in learning situations. It was clear from our observations that in effective learning environments, teachers and learners often moved outside the constraints of pre-determined orchestration and began to improvise.

Background

Teachers regard IWBs as valuable for gaining and maintaining the attention of students and find them useful for collating resources for instant selection and display during the course of lesson activity (Smith et al., 2005). However, the extent to which the interactive features of IWBs are valued is less clear. Beauchamp and Kennewell (2008) suggested that the key affordance for action during learning tasks is the immediate, contingent feedback to students that is characterised as ‘interactivity’. The term ‘interactive’ is used in different ways in the literature concerning whole-class teaching and we distinguish technical interactivity (physical interaction with the device) and pedagogic interactivity (interaction between students and others in the classroom designed to bring about learning) (Smith et al., 2005). It is pedagogic interactivity which appears to be most significant for effective learning (Tanner et al., 2005; Kennewell et al., 2008).

The impact of IWCTs on learning is dependent on the mediating role of the teacher (Hennessy et al., 2007), and it is pedagogic rather than technical interactivity that is usually critical. When technical interactivity is prioritised over pedagogic purpose, some relatively mundane activities may become over-valued (Moss et al., 2007). Sadly, in UK schools interactive pedagogy is often quite limited in scope. Lessons with IWBs are more often dominated by whole-class teaching than those without and demonstrate a more rapid rate of interaction between teacher and pupils (‘pace’), albeit at a rather superficial level, with



pupils generally offering short responses rather than dialogic exchanges (Smith et al., 2006).

Pedagogic interactivity in whole-class teaching may be classified according to the degree of control allowed to the pupils over the trajectory of the lesson (Tanner et al., 2005). This ranges from a 'lecture' approach with a high level of teacher control at one end of the scale through 'funnelling questioning', 'probing questioning' and 'focusing and uptake questioning' to 'collective reflection', at the other end. This scale has been used to analyse teaching episodes with and without the use of ICT, and there is some evidence that shifting the nature of pedagogical interactivity towards greater student influence may be more important in improving the quality of learning (Kennewell et al., 2009a).

There is evidence that with effective teacher mediation IWCTs can support more dialogic interaction and 'the most effective use of IWBs seems... likely to involve striking a balance between providing a clear structure for a well-resourced lesson and retaining the capacity for more spontaneous or provisional adaptation of the lesson as it proceeds' (Gillen et al., 2007, p.254). Hennessy et al., (2007 p.298) claim that 'the strength of the IWB lies in its support for shared cognition, especially articulation, collective evaluation and reworking of pupils' own ideas, and co-construction of new knowledge'.

In analysing teacher mediation of ICT and other resources in the classroom, the idea of 'orchestration' is helpful (Kennewell et al., 2008). This construct extends the idea of 'scaffolding' and concerns the planned and responsive manipulation by the teacher of the features of the classroom setting (including students, resources, and less tangible features such as culture and ethos) to support the goal-related actions carried out by students and the development of common or collective knowledge.

When the culture of the classroom and the features of the task and the technology support it, pupils may sometimes orchestrate features of the setting for themselves. We have observed this less classical form of orchestration in some effective learning contexts.

Extending the musical analogy

In music, orchestration is a systematic, [pre]considered organisation of instruments or voices. (Scholes, 1980) This includes deciding how they will be combined and sequenced in performance. In the classroom analogy this could be equated to how the teacher chooses to combine and sequence different features of the setting and student or teacher voices.

Classical orchestration normally leads to choices being written down in a score which is largely fixed, although the conductor may interpret this in different ways, just as teachers can interpret a lesson plan in practice. In schools, the widespread use of ICT for pre-prepared slide presentations reinforces the musical analogy of a fixed 'score' for a lesson (Beauchamp & Parkinson, 2005). In the classical genre, the trajectory of the performance is under the control of the conductor. Consequently, the success of performance (lesson) is normally attributed to the conductor (teacher) and not to the players (learners).

When teachers first began to experiment with IWCTs, their practices often followed this classical analogy (Beauchamp & Parkinson, 2005; Smith et al., 2006). However, classical orchestration does not model more flexible pedagogical approaches, which use IWCTs to support more spontaneous and dialogical interactions with pupils.

We have observed (Kennewell et al., 2009a) many effective lessons in which teachers encourage pupils to express their own ideas for public discussion and contingent response, in an approach described by Alexander (2004) as 'dialogic' teaching. IWBs have often been used to support this process by providing a public site for the co-construction of knowledge which can be placed under the control of pupils who are taking the lead for the

moment. This style of orchestration is more characteristic of jazz in which the musician's unplanned improvisations in response to stimuli from other players mirrors the teacher's ability to respond in the moment to spontaneous ideas from pupils who have taken the lead.

Improvisation

Improvisation may be defined as 'the conception of action as it unfolds, drawing on available cognitive, affective, social and material resources' (Kamoche et al. 2003 p.2025) Two forms of improvisation characterised by Kernfield (1995) seem helpful in analysing classroom activity. 'Paraphrase improvisation' is characterised by the 'ornamentation of an existing theme' whilst 'formulaic improvisation' by the 'artful weaving of formulas'. This latter type of improvisation is helpful when analysing less classical forms as it is dynamic and responsive. In the classroom, we refer to this as 'dynamic orchestration', in which planned activities are rearranged and redesigned during the lesson in response to matters that arise, whereas paraphrase improvisation involves ideas on subject matter being elicited and developed by pupils in a more limited sense within a planned lesson structure.

For example, a class of 13 to 14-year-olds was taught about reflection using software from NGfL Cymru (<http://www.ngfl-cymru.org.uk>). Shapes and mirror lines were drawn and dragged on a grid. Reflections in lines and construction lines were available options.

Initially, a triangle was displayed on the IWB. Pairs of pupils discussed the position of a reflection in $x=2$. A volunteer was invited to the board to draw the reflected triangle in approximately the correct position using IWB board tools. He was then asked to justify his answer. He struggled to explain and the teacher asked contingent, probing questions to clarify how he had visualised the reflection. Members of the class were invited to evaluate his solution and justify their claims. Their suggestions included counting diagonal distances, counting squares in the x and y directions, or drawing construction lines.

Pupils were invited to the board to demonstrate their ideas. The teacher asked probing questions about their reasoning and focussed attention on salient features and limitations of strategies. Finally, the software confirmed the position of the reflection under the lines drawn by pupils and the construction lines were inserted.

The teaching had incorporated a degree of improvisation as the teacher responded to the pupils' unpredictable and varied responses. The context was very structured, however, and the degree of improvisation afforded was limited by the task and the context.

The pattern of interaction was repeated with more examples before a paper and pencil exercise based on a worksheet of similar, but progressively more difficult, tasks. The final, most challenging, example was a polygon crossing over a mirror line at 45° to the axes. Towards the end of the lesson, several pairs of pupils had partial or incorrect solutions to this problem. Others had become "stuck" and unsure of how to proceed.

The diagram was displayed on the IWB for a plenary discussion. Pupils volunteered ideas but no-one gave an accurate answer immediately. Class discussion followed, with pupils arguing their own cases. The teacher questioned to help pupils clarify their thoughts, but suspended evaluation of suggestions. Eventually two pupils came to the board together and with the help of suggestions from the class managed to construct an accurate reflection.

Significant improvisation was required from pupils, albeit within an environment structured by the task and the technology. Extensive modifications were made to the process in a complex, but structured conversation between multiple voices which was dialogic in character. Pupils made exploratory and tentative suggestions, some of which

were taken up and made the focus of discussion by the teacher. Other comments by pupils were cumulative in character as the board became a space for collective thinking.

Finally, the teacher invited the class to reflect on what they had learned about strategies for constructing reflections, drawing out the weakness of purely intuitive approaches in more complex questions. The teacher orchestrated contributions from a range of voices, in a flexible manner to summarise the learning that had occurred. This demanded improvisation from pupils as well as the teacher in a cumulative, reflective dialogue.

Jazz and Pedagogical Approaches

Jazz musicians face a challenge in balancing the risk of failure with the creative tension involved in embracing mistakes and using them to form creative new pathways for action. This parallels research contrasting positive teaching approaches, that are apparently safer in their production of clear arguments, with those based on cognitive conflict in which the production of erroneous conceptions are actively sought. The relative success of conflict based approaches demonstrates the value of exposing such errors (see, for example, Bell, 1993; Muller et al, 2008). It could be argued that mistakes are more likely in a minimal structure, rather than a fully notated classical score. However, such ‘mistakes’ can also provide the catalyst for creativity as new and unexpected situations present themselves.

Neyland (2004) suggested an interdependent set of characteristics of the jazz metaphor: (i) complexity (not complicatedness), (ii) an optimally minimal structure, (iii) the primacy of creative and spontaneous improvisation, (iv) challenging (‘playing outside’) established structures, (v) pursuit of ideals, and (vi) ethical know-how. The last of these includes the notion of ‘effortless mastery’, which is a mode of learning. This process is quite different from repetitive practice of techniques, and leads to effortless (but not habitual) performance in which new ideas are created, seemingly independent of conscious effort.

Players in the classroom have a range of instruments at their disposal – ICT as well as the more traditional ones such as ones of voice, pen/paper, etc. Individual skill levels with the instruments varies and the role of the teacher is to draw the best from the players by allowing varying degrees of freedom and structure within the features of the environment. Loosened structure and increased freedom are characteristic of a move towards a more improvisatory use of ICT. This is analogous to the jazz musician for whom the musical score is only a starting point or guide and not an end in itself. In the jazz genre, the lesson plan and resources may provide only a loose framework for performance. This contrasts strongly with the current fashion in official guidance for tightly pre-determined objectives. One of the challenges for teaching in the jazz genre is the ability to make decisions in the moment to provide the contingent responses which are characteristic of improvisation.

Another feature of the jazz genre is that there may be no apparent conductor, although in reality one of the players is likely to be leading. Change of control may be signalled by offering the lead to another player and becoming one of the band. Similarly, teachers may temporarily hand over the lead to pupils and this is often signalled by relinquishing their position at the front of the class - ‘standing away’ from the board (Lewin et al., 2008 p.297).

An example of improvisation and change of lead was seen during a lesson with 10 year old pupils who had undertaken a practical investigation to find out the total scores obtained when rolling two dice 50 times. The scores obtained by each group were collated on the IWB to find the overall frequency with which each total had occurred. As the totals were displayed some pupils spontaneously began to suggest reasons for the emerging patterns.

Pupil: Sir, 7 will be the most likely total as you can make 7 in lots of ways, but a 2 you can only get in 1 way

(Although the teacher had not planned to do this analysis until the subsequent lesson he improvised in a contingent response to these suggestions and invited one pupil to explain)

Teacher: Go on, please explain. I'm interested in your ideas. Can you use the board to show us what you mean? Come on, you take over. I'll sit in your seat.

The pupil then moved to the board and took the lead, addressing the class who listened attentively whilst she repeated her reasoning and started to write out some number pairs:

but $2 = 1 + 1$
 $7 = 4 + 3$
 $7 = 1 + 6...$

After she finished her explanation she looked to the teacher for comment and he returned to the front and took back the lead. The pupil had been improvising, as her contribution was unplanned. The teacher continued to improvise as he asked the class for comments and invited pupils to the board to explain how other scores could be generated.

In this short performance, all the players (learners and teacher) were listening to and responding to what others were playing (contingent response). On occasions there were solos (learners at the front) while others were content to maintain their place in the band – although they still had to be listening and responding to the soloist.

The Goal of Lesson Activity Subversive Improvisation

When musicians are playing jazz together, they are likely to share an understanding of their aims for the performance. However, when pupils perform classroom activities, they do not always share the same goals as their teachers. There are often two sets of goals: those concerned with products and those concerned with the learning process. Pupils are often focused on task completion and have goals associated with completing an exercise or a product, to gaining marks, rather than the teacher's learning goals (Kennewell et al., 2008).

The following episode is taken from a lesson with 32 13-year-old pupils. A circus of three activities was to be studied in turn by each of three groups of pupils. Each activity was to be completed in approximately 15 minutes. We focus here on one of the activities – sequences.

The lesson had started with the teacher demonstrating all three of the activities to the whole class and leaving the sequences activity on the IWB for the first group of 11 pupils to attempt. The software gave sequences of numbers that were connected by an unknown, two-part, linear function such $2n + 3$

5 7 9 11 13

Two “sliders” underneath the sequence allowed pupils to adjust the coefficients of the two terms in the sequence in an expression that appeared in a box marked “answer”. When an expression was entered, the sequence for that expression appeared underneath the original sequence for comparison.

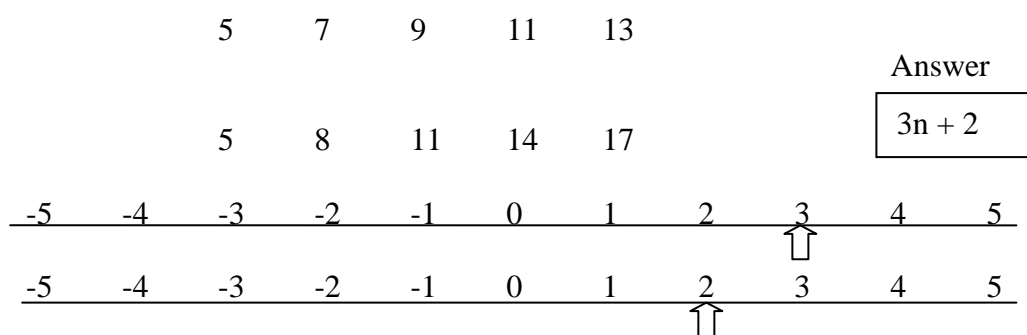

Pupils were told to copy down the sequences and use any method they wished to find the expression. He showed them how to use the method of differences if they could not spot it by inspection. The first person to calculate the sequence would then take the pen and move the sliders to demonstrate that their expression gave the required sequence.

In a interview, the teacher said that he wanted them to be competitive, racing to be the first to finish and get the pen. He hoped that this would motivate them to work quickly.

When the pupils worked on the task during the “circus” phase of the lesson, they were competitive and motivated to be the one to enter the data at the IWB. They tried to work as fast as they could and some quickly realised that they could subvert the process and generate the solution without completing the calculation. Two boys realised early on that they could calculate the difference between two terms on the way to the board, set the first slider to the difference and then slide the second slider until the numbers matched, without ever calculating the expression for themselves.

These pupils had two goals: to be the pen holder and to construct the product as briefed – large numbers of sequences and expressions, confirmed as correct by the IWB. Unfortunately, this focus on product rather than learning had led to an improvisation that avoided some of the mathematics. The solution provided by the board was authoritative and classical in character, with some pupils doing little more than watching and copying and few, if any, thinking mathematically.

In this case, the features of ICT afforded a degree of improvisation, which was effective in meeting the pupils’ success criteria without meeting the teacher’s expectations of learning from the activity. Whilst this phenomenon is not a novel one, and may not be directly caused by ICT, it seems that there is greater potential for subversion because of the ease with which students can operate powerful tools. This mastery can also be harnessed in the cause of learning goals, of course.

For example, a mathematics class was taken to a computer room to use Autograph to explore reflections on individual PCs. Worksheets with polygons drawn on graph paper demanded the construction of a mirror line such as $y=x$, $y=2x$ or $y=-x$, followed by the construction of a reflected image. Pupils were then asked to work in small groups to check their answers by constructing the shapes in autograph and reflecting in their mirror line.

At this stage, interaction with the affordances of the ICT was largely under the control of the pupils and their discussions developed a more dialogic character as they sought to explain any discrepancies between their answers and those generated by Autograph.

During this phase, many pupils made errors in plotting points and /or selecting the correct mirror lines. This resulted in unexpected reflections being generated by the software. The errors exposed in the interaction with the technology often challenged pupils to reconsider their ideas through dialogue with their partners, experimentation within the

software and/or discussion with the teacher. This more dialogic tone was developed further in the lesson plenary.

Several pupils had also seized the opportunity to subvert the set task and to use the affordances of the software to create their own shapes and reflection patterns, often creating dynamic and attractive symmetrical patterns. Unlike the pupils described in the previous sequence, however, the intention of these pupils was not to get to the right answer, but to play, and in so doing, they improvised their own mathematical work. The affordances of the software constrained them towards patterns which were mathematical in character, many of which offered opportunities for further learning.

Although the pupils tried to hide this play from their teacher by switching screens when she was nearby, eventually she noticed this off task behaviour. Instead of admonishing the pupils, she decided to take advantage of this spontaneous performance and asked them to present some of their designs to the rest of the class. Discussion of the construction of the designs provided an opportunity for collective reflection about some of the key strategies being taught in the lesson. The improvisation of the subverters resulted in a loosening of control and a move to a more improvisatory format in which the pupils assumed a degree of 'functional anarchy' and offered a performance of their own ideas.

In this plenary, the teacher was orchestrating a range of voices in an emergent and spontaneous, mutually constructed conversation that linked mathematical ideas with the aesthetics of art and design. Perhaps most importantly, it was pleasurable and exposed the joy of mathematics. The pupils' spontaneous improvisations had led to a performance with some of the characteristics of effortless mastery (Neyland, 2004).

Conclusion

We have often found the analogy of orchestration to be helpful when analysing the teacher's role in manipulating the features of classroom settings to generate activity or performance leading to learning. We suggest here that this can range from a highly controlled and pre-planned 'classical' style of orchestration to a range of more improvisatory orchestrations, more characteristic of the jazz genre. In our research we have observed effective teaching that has incorporated a range of genres within one lesson.

We suggest that a purely classical view of orchestration fails to recognise the extent to which effective teaching and learning makes use of serendipity and improvisation – characteristics more often associated with jazz. IWCTs have affordances which may be used to establish conditions under which more jazz like performances are likely to occur, offering opportunities for more creative, improvised teaching and learning. The dynamic and contingent properties of ICT can facilitate the exploration of ideas and improvisation by both pupils and teachers within and beyond the set task. The use of IWCTs provides easier sharing of ideas with the whole class. Moreover, the dynamic properties of ICT allow demonstration of the thinking process and not just the finished product.

Mathematics lessons within the UK often emphasise the reproduction of standard procedures, leading to a classical orchestration with rigid and instrumental lesson objectives. We would like to encourage more jazz like performances involving spontaneous improvisation and the critical application of learning to novel contexts. It may be that until this emphasis is changed, pupils will be largely restricted to playing someone else's tunes.

References

- Alexander, R. (2004). *Towards dialogic teaching: Rethinking classroom talk*. York: Dialogos UK Ltd.
- Beauchamp, G. & Parkinson, J. (2005). 'Beyond the 'wow' factor: Developing interactivity with the interactive whiteboard'. *School Science Review*, 86(316), 97-103.
- Beauchamp, G. & Kennewell, S. (2008). The influence of ICT on the interactivity of teaching. *Education and Information Technologies*, 13, 305–315.
- Beauchamp, G., & Kennewell, S. (2010). Interactivity in the classroom and its impact on learning. *Computers & Education*, 54(3), 759-766.
- Bell, A. (1993) Some experiments in diagnostic teaching. *Educational Studies in Mathematics*, 24(1), 115-137.
- Gillen, J., Kleine Staarman, J., Littleton, K., Mercer, N. & Twiner, A. (2007). A 'learning revolution': investigating pedagogic practice around interactive whiteboards in British primary classrooms. *Learning, Media and Technology*, 32(3), 243–256.
- Hennessy, S., Deaney, R., Ruthven, K. & Winterbottom, M. (2007) Pedagogical strategies for using the interactive whiteboard to foster learner participation in school science. *Learning, Media and Technology*, 32(3), 283-301.
- Kamoche, K., Cunha, M., & Cunha, J. (2003). Towards a theory of organisational improvisation: Looking beyond the jazz metaphor. *Journal of Management Studies*. 40(8),2023-2051.
- Kennewell, S., Tanner, H., Jones, S., & Beauchamp, G. (2008). Analysing the use of interactive technology to implement interactive teaching. *Journal of Computer Assisted Learning*, 24(1), 61–73.
- Kennewell, S. et al. (2009a). Interactive teaching and ICT. *Welsh Journal of Education*, 14(2), 29-44.
- Kennewell, S. et al. (2009b). Final report to Becta concerning the use of video - stimulated reflective dialogue for professional development in ICT. Retrieved 1 March 2010 from http://partners.becta.org.uk/upload-dir/downloads/page_documents/research/video_stimulated_reflective_dialogue_final.pdf
- Kernfield, B. (1995). *What to listen for in jazz*. New Haven: Yale University Press.
- Lewin, C., Somekh, B. & Steadman, S. (2008). Embedding interactive whiteboards in teaching and learning: the process of change in pedagogic practice. *Education and Information Technologies*, 13, 291-303.
- Moss, G., Jewitt, C., Levañiç, R., Armstrong, V., Cardini, A. & Castle, F. (2007). *The interactive whiteboards, pedagogy and pupil performance evaluation: An evaluation of the Schools Whiteboard Expansion (SWE) Project: London Challenge*. DfES Research Report 816, London, DfES.
- Muller, D. A., Bewes, J. Sharma, M. D. & Reimann, P. (2008) Saying the wrong thing: Improving learning with multimedia by including misconceptions, *Journal of Computer Assisted Learning* 24, 144–155.
- Neyland, J. (2004). Effortless Mastery and the Jazz Metaphor. In I. Putt, R. Faragher, & M. McLean (Eds.), *Mathematics education for the third millennium: Towards 2010* (Proceedings of the 27th Annual Conference of the Mathematics Education Research Group of Australasia, pp. 390-397) Sydney: MERGA.
- Scholes, P.A. (1980). *The Oxford companion to music* London: Oxford University Press.
- Smith H., Higgins S., Wall K. & Miller J. (2005). Interactive whiteboards: Boon or bandwagon? A critical review of the literature. *Journal of Computer Assisted Learning* 21, 91–101.
- Smith, F., Hardman, F. & Higgins, S. (2006). The impact of interactive whiteboards on teacher-pupil interaction in the national literacy and numeracy strategies, *British Educational Research Journal*, 32(3), 443–457.
- Tanner H., Jones S., Kennewell S., & Beauchamp G. (2005). Interactive whiteboards and pedagogies of whole class teaching. In P. Clarkson, A. Downton, D. Gronn, M. Horne, A. McDonough, R Pierce, & A. Roche (Eds.), *Building connections: Research, Theory and Practice* (Proceedings of the 28th annual conference of the Mathematics Education Research Group of Australasia, Melbourne, pp.720-727). Sydney: MERGA.
- Tharp, R. & Gallimore, R. (1988). *Rousing minds to life: Teaching, learning and schooling in social context*. Cambridge: Cambridge University Press.

One on One Numeracy Intervention: A Pilot Project in Low SES Communities

Steve Thornton

Charles Darwin University
stephen.thornton@cdu.edu.au

Gina Galluzzo

Catholic Education Office, Archdiocese of
Canberra/Goulburn
gina.galluzzo@cg.catholic.edu.au

Mary Quinane

Catholic Education Office, Archdiocese of
Canberra/Goulburn
mary.quinane@cg.catholic.edu.au

Debbie Taylor

Catholic Education Office, Archdiocese of
Canberra/Goulburn
debbie.taylor@cg.catholic.edu.au

This paper reports on the structure and impact of a one on one numeracy intervention project conducted during 2009 with students in years 1, 4 and 8. The project was built on a Reading Recovery model, using research into how the brain learns mathematics and ideas of threshold concepts. Teachers were provided time to work individually with students at their point of need. The results suggested that the model was effective in both cognitive and affective terms, and that the learning gained through the project is beginning to result in whole school improvements in mathematics pedagogy.

This paper describes a numeracy intervention project conducted by the Catholic Archdiocese of Canberra/Goulburn as part of the Commonwealth Government Literacy and Numeracy Pilots in low SES schools. The pilot commenced in February 2009 and concludes in June 2010. It was conducted in ten schools in the region, from the South Coast and South Central NSW. It involved up to twelve students from each school in Years 1, 4 and/or 8. The paper describes the design of the project and provides some preliminary results of both teacher change and changes in affect and understanding among the students.

Literature review informing the project

The design of the project was influenced by several sources and previous studies. An initial decision was made to use a one on one intervention process, which has been shown to be effective in producing improved outcomes for struggling students (Phillips, Leonard, Horton, Wright, & Stafford, 2003). Several intervention models (Bryant, Bryant, Gersten, Scammacca, & Chavez, 2008; Dowker, 2001; Gervasoni, 2005; Wright, 2009) were examined. Most models structure intervention around a clearly developed and described framework. For example, Dowker (2001) identified eight components of early numeracy, while the *Math Recovery* project (Wright, 2009) used an instructional framework for early number organised into three strands, number words and numerals, counting and grouping, with thirty teaching topics.

However, for this project teachers were not provided with a set program, framework or developmental sequence that they were required to follow; rather they were asked to respond to students at their point of need. Since many of the teachers involved in the project had some experience of *Reading Recovery* (Clay, 1993) this was chosen as a way of structuring the intervention.

Other sources of research that informed the teachers' development of intervention strategies included research into how the brain learns mathematics (Sousa, 2008), discussions of mathematical concepts that could be termed threshold concepts (Meyer & Land, 2003) and existing frameworks for children's mathematical development such as the



Learning Framework in Number from Count Me In Too (NSW Department of Education and Training, 2000).

Brain based research stresses the need to build lessons around knowledge of how the brain best learns mathematics and brain activity during a period of time when new ideas are being learned. In particular the teachers in the project examined connections between oral, visual and symbolic representations of mathematics, using research about brain activity related to each representation. They also examined issues such as the structure of the mental number line and metalanguage. Based on their learning about mathematics and brain activity teachers chose to use activities such as a Think-Board (Gervasoni, 1999). This ensured that lessons included periods of active learning. They paid particular attention to the use of language by constructing a word wall.

Teachers also built on research into brain activity during a period of instruction (Sousa, 2008) to construct lessons that took advantage of periods of greatest and least activity. Each 30 minute lesson was planned to follow the structure:

- Short warm-up activity revising previously learnt ideas (5 minutes);
- Explicit teaching (10 minutes);
- Cognitive break (3 minutes);
- Related practice/ Consolidation of the key idea (10 minutes);
- Cognitive closure (3 minutes).

For each lesson teachers were asked to plan using a template based on a combination of ideas from Reading Recovery (Clay, 1993) and the concepts of brain based learning. The template asked teachers to plan each section of the lesson, document student responses during that phase of the lesson and summarise learning.

During professional development sessions considerable time was devoted to discussing the fundamental concepts of mathematics, such as place value, multiplicative thinking, and part-whole connections that have been shown to be both troublesome and essential for further understanding (Siemon, Izard, Breed, & Virgona, 2006). For the purposes of this project the idea of a threshold concept (Meyer & Land, 2003) was used to guide discussion and planning. While most of the research into threshold concepts has been based in tertiary education settings such as studying economics, physics or mathematics (Meyer & Land, 2005), it was felt that the characteristics of threshold concepts were particularly appropriate for deciding what might be essential for students struggling with mathematics in the early and middle years of schooling.

Threshold concepts are troublesome, integrative, irreversible and transformative (Meyer & Land, 2003). They are troublesome in that they are often difficult to grasp, sometimes counterintuitive and usually take considerable time to develop. They are integrative in that they make sense of previously disparate ideas. They are transformative in that once a threshold concept has been grasped the world “looks different”, and they are irreversible in that once one sees the world in that way one never reverts to more simplistic or primitive ways of seeing the world.

Place value provides an appropriate example of a threshold concept in early mathematics. To develop a robust understanding of place value students must see ten or one hundred as a group rather than a count, and must let go of a reliance on counting by ones. They need to be able to construct and deconstruct numbers as combinations of groups, a process that is troublesome for many students and even practising teachers (Ma, 1999). Indeed, the teachers in the project consistently reported that this was a concept that students did not understand well, even in Year 8. However, once one understands the place value structure of a number such as 137 it ceases to become a symbol on a page for a count

of objects and becomes instead a structure that can be visualised and decomposed flexibly, making sense of ideas and processes such as standard algorithms in arithmetic. This transforms the way students see number, and is irreversible in that given 137 objects students who have a strong understanding of place value will almost inevitably count them in groups of ten, which are then formed into groups of one hundred.

The threshold concepts identified and discussed by teachers were informed by and compared with existing frameworks describing children's development such as the *Learning Framework in Number* (LFIN) (Wright, 2002). The LFIN was particularly useful for interventions with Year 1 students, many of whom were identified as being at the perceptual stage of counting. Furthermore many of the Year 4 students had a poor grasp of strategies for single digit addition, and few had developed the capacity to count by equal groups necessary for multiplicative thinking.

The program

Initially schools identified as having a relatively high proportion of students from low SES backgrounds, including high numbers of indigenous students, and as having a high proportion of students achieving at/or below the benchmark shown in state numeracy testing, were approached to seek interest in being involved in the project. Ten schools were selected, being a mixture of primary schools having children in Years 1 and 4, central schools with children in Years 1, 4 and 8 and two high schools with Year 8 students. Each school was allocated resources based on enrolment, including a 0.4 salary component per identified Numeracy Intervention Project (NIP) teacher. While most schools were allocated one teacher, some with larger student enrolments were allocated two teachers. NIP teachers were selected by the school principal and were generally both experienced and capable. School principals were specifically asked to choose staff that might have influence over other staff at the school. In this way it was hoped that the project would have a flow-on effect by provoking pedagogic change across the school.

The teachers identified were provided with two days' initial professional development outlining the project, introducing some of the research discussed above and becoming familiar with an interview-based assessment instrument. In the case of children in Years 1 and 4 the *Schedule for Early Number Assessment* 1 or 2 (NSW Department of Education and Training, 2000) was used, while the *Nelson Numeracy Assessment Kit* (Giulieri, Davie, & Dale, 2004) was used for students in all years. Each teacher then identified students who might benefit from the intervention, using the results of interview assessments, school data and system-wide tests. Each teacher selected four students from Years 1, 4 or 8. In small primary schools this may have been two students in each of Years 1 and 4, while in larger primary schools with two NIP teachers one may have worked with four Year 1 students and the other with four Year 4 students. Similarly, in the high schools Year 8 students were selected, or in central schools a combination of students from different levels was selected. It is important to note that the students selected had not been identified as having special needs and were not receiving additional support from a paraprofessional. They were simply struggling with mathematics, although in many cases they also found other subject areas difficult. Years 1, 4 and 8 were chosen as these were not testing years for national testing, hence it was less likely that lessons would focus on answering typical test questions. It was also hoped that intervention in the year prior to national testing might lead to improvement in the following year's results. Of course, whether or not this was achieved remains to be seen.

At subsequent professional development days teachers were introduced to further research and developed a consistent lesson structure based on this research. Completing the planning and reflection template for each student each lesson proved time consuming and challenging, but forced teachers to pay close attention to the needs and learning of each student in the project.

One on one intervention was then conducted with each of the four students for which one teacher was responsible over a thirteen-week period from mid term 1 to the end of term 2. Each student was given a thirty-minute targeted intervention lesson in a dedicated space on four days during the week. Teachers generally had a fifteen-minute break between students during which time they documented learning and planned for the following day. At the end of the thirteen-week intervention each student was then provided with ongoing in-class support from a teacher assistant who had been specifically trained in the strategies developed during the Numeracy Intervention Program. A second phase was then commenced, however this is not reported on in this paper.

Results

All students in Years 4 and 8 were asked to complete the *Progressive Achievement Tests in Mathematics* (PATmaths) (Australian Council for Educational Research, 2005). This was administered to all students in each year level, including those not involved in the project, both prior to the commencement of the project and later during the year following the intervention. The results are shown in Table 1.

	NIP students	Non-NIP students
n	65	267
% increasing score	75%	66%
Mean increase in score	4.32	2.28

Table 1: Comparison of student results in years 4 and 8 on PATmaths

These results show modest but encouraging differences in the results of students involved in the NIP project compared to those that were not involved, with 75% of NIP students increasing their score compared to 66% of non-NIP students. However in at least one school every student involved in the project improved in the post-intervention test. A student t-test was conducted to compare the mean increase in score for the two groups (NIP and non-NIP), resulting in a p-value of 0.007. This suggests that being involved in NIP produced an increase in percentile ranking greater than that which would have been achieved outside the project. Of course, some caution should be exercised as the NIP students commenced, in general, at a relatively low level and thus it may have been relatively easy to increase the number of questions correct in PATmaths. Furthermore there was considerable variability between schools, however the number of students involved in NIP at any one school was not sufficient to conduct statistical analyses.

For Year 1 students it was not appropriate to use instruments such as PATmaths. Rather teacher judgment, particularly that of the regular classroom teacher informed by SENA, was used to evaluate the program. Each classroom teacher was asked to complete a survey requesting their judgment of students' understanding of fundamental concepts. They were then asked to complete the same survey following the NIP intervention. In almost every case teachers reported that students' understanding of fundamental concepts had improved dramatically, particularly in concepts associated with number, which was the focus of the project. Unsurprisingly the improvement was not as marked in problem

solving, as this was not an explicit focus of the intervention. The results for Year 1 are

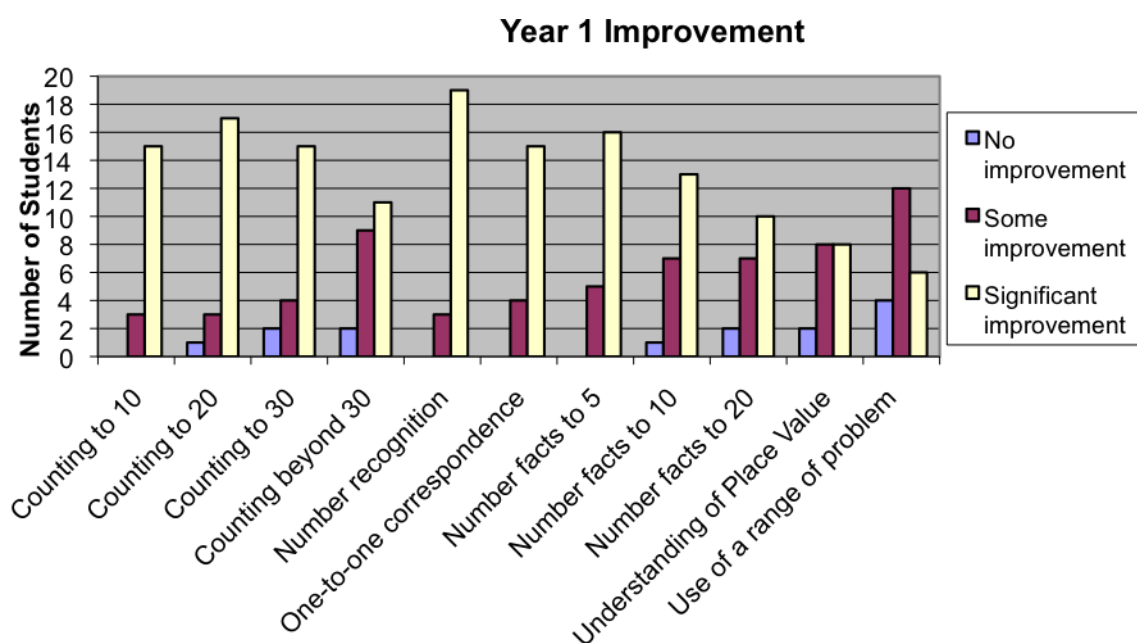

shown in Figure 1.

Figure 1: Improvement of Year 1 students in mathematical understanding as assessed by classroom teachers

Classroom teachers in Years 4 and 8 were also asked to evaluate students' understanding of key concepts. While space prevents publication of these results in this paper, teachers also reported significant improvement. This was more pronounced in Year 4 than in Year 8, which is perhaps unsurprising as flawed understandings are often firmly embedded by the end of primary school and very hard to shift.

Classroom teachers were also asked to complete a pre- and post-survey on students' attitude to mathematics, confidence and problem solving. The results for Year 4 students are shown in Figures 2 and 3.

These results suggest that perhaps the most significant outcome of the project was an improvement in students' self-esteem and confidence. Teachers reported that some students were initially reluctant to be involved in the project for fear of being stigmatised as stupid. However, these feelings quickly disappeared, and students became excited and enthusiastic about attending NIP lessons. In one case a parent reported to the teacher that prior to the NIP project it had been hard to get her child to school, but that since NIP the child had become enthusiastic and could not wait to go to school. The increased confidence and enthusiasm developed through NIP appears to have had a flow-on effect to other areas of schooling.

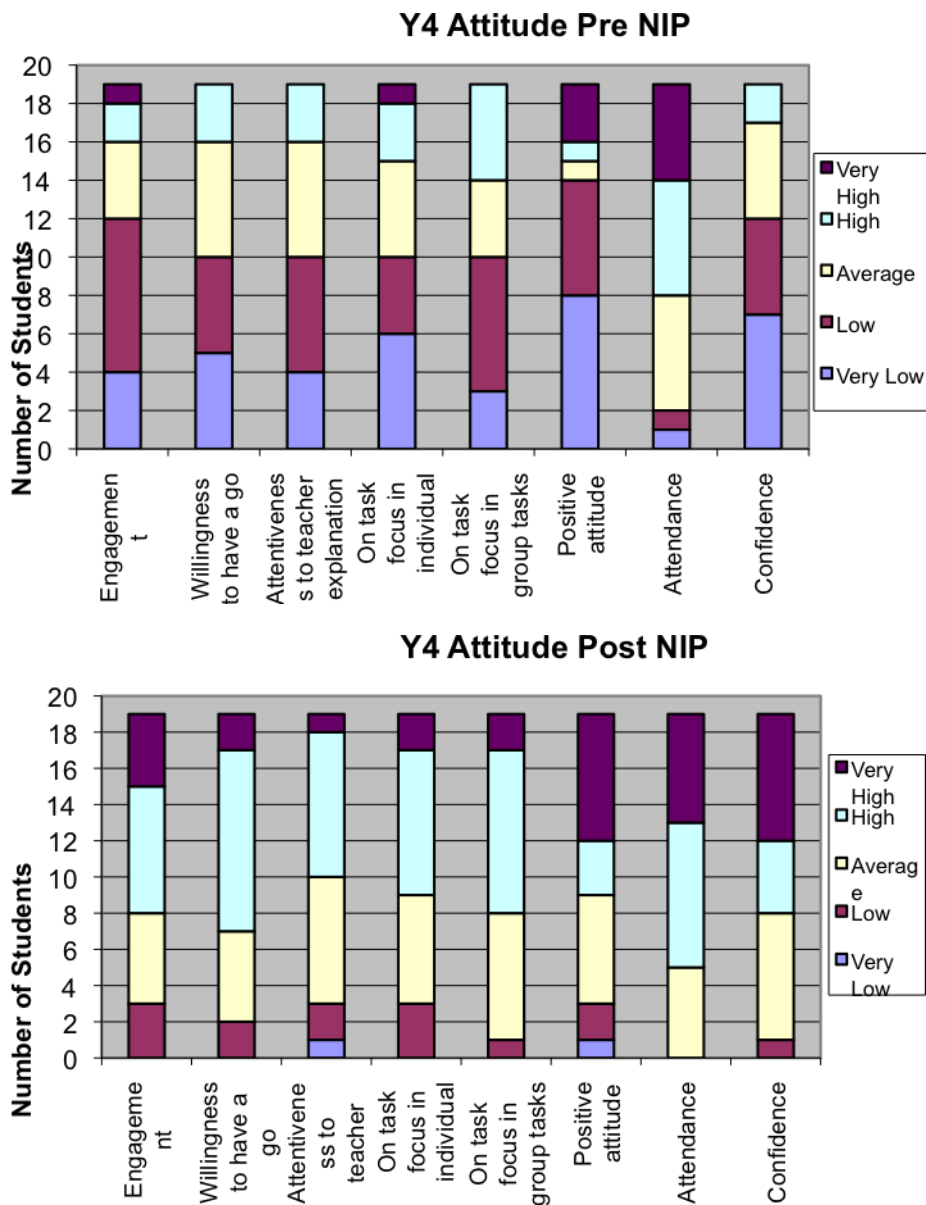

Figure 3: Year 4 students' attitudes to learning following NIP intervention as perceived by classroom teachers

What is particularly significant about these survey results is that they were the opinions of the classroom teacher, not the NIP teacher. In some cases classroom teachers were sceptical of a withdrawal program, as it could be seen to reflect on their own capacity to teach struggling students. A further implication of the withdrawal model was that students missed regular instruction for a total two hours per week. However, the results of the survey indicate that the classroom teachers, almost without exception, recognised the value of NIP both in affective and cognitive terms.

I feel special and privileged (Year 8 student).

I added up well because I am smart!! (Year 1 student)

I learnt to use my head instead of my fingers (Year 4 student)

I have a different child now. Since NIP she is happy to go to school and so much more confident (Year 4 Parent)

School change

A key aspect of the design of the project was a whole school commitment, particularly from the school leadership team. In many cases timetables needed to be rearranged and special rooms found. It was hoped that the project might have a flow-on effect in improving mathematics pedagogy throughout the school. In most schools there has, to varying degrees, been some evidence of whole-school change. This has been particularly the case in schools where the NIP teacher was also a school leader such as the Deputy Principal. As in any such project the degree to which whole school change has eventuated relied on factors such as stability of staff, expertise of teachers and administrative support.

The most obvious change has been the way that lessons have been structured using ideas from brain activity during lessons. In some schools all teachers have been given a copy of *How The Brain Learns Mathematics* (Sousa, 2008) and have discussed the ideas in the book as a staff professional development activity. Parent information sessions have also been held. At these schools teachers have reported significantly enhanced student interest in mathematics and more productive use of lesson time.

This is the most effective numeracy development program I have ever seen (Secondary Principal)

NIP has been the best professional learning I have experienced (Primary Assistant Principal and Learning Support Teacher)

I think about ways to teach numeracy better all the time, even when I'm gardening (Year 1 NIP Teacher)

Conclusion

The NIP project has added to the weight of evidence supporting the efficacy of one on one intervention as a strategy for enhancing both affect and cognitive aspects of mathematics learning. The design of the project, building on ideas of threshold concepts and research into how the brain learns mathematics, enabled teachers to think deeply about their practice and plan interventions using a coherent framework. While it could be argued that any one on one intervention is likely to enhance outcomes for targeted students, the lesson structure used in NIP produced modest cognitive effects but strikingly positive affective results as reported by classroom teachers.

However, one on one intervention is an expensive model. The logistics of conducting the project would not have been possible without external funding accompanied by a significant investment of time from staff at the Catholic Education Office. Whether or not such a model is sustainable within the ten pilot schools or transferrable to other schools is therefore open to question. Nevertheless it is hoped that the flow-on effects of teacher learning will reduce the imperative for expensive intervention models in the pilot schools and that the teachers involved in the project may be able to share their knowledge in the wider community.

Acknowledgments: This project was supported by a grant from the Commonwealth Department of Education, Employment and Workplace relations as part of the Literacy and Numeracy Pilots in low SES schools program. The authors acknowledge the hard work and professionalism of the teachers involved in the project.

References

Australian Council for Educational Research (2005). *Progressive Achievement Tests in Mathematics*. Camberwell, Vic.: Australian Council for Educational Research.

- Bryant, D., Bryant, B., Gersten, R., Scammacca, N., & Chavez, M. (2008). Mathematics intervention for first-and second-grade students with mathematics difficulties: The effects of tier 2 intervention delivered as booster lessons. *Remedial and Special Education, 29*(1), 20-32.
- Clay, M. M. (1993). *Reading Recovery: A guidebook for teachers in training*. Portsmouth, NH: Heinemann.
- Dowker, A. (2001). Numeracy recovery: A pilot scheme for early intervention with young children with numeracy difficulties. *Support for Learning, 16*(1), 6-10.
- Gervasoni, A. (1999). Using visual images to support young children's number learning. *Australian Primary Mathematics Classroom, 4*(2), 23-27.
- Gervasoni, A. (2005). *The diverse learning needs of young children who were selected for an intervention program*. Paper presented at the 29th Conference of the International Group for the Psychology of Mathematics Education, Melbourne.
- Giulieri, A., Davie, L., & Dale, J. (2004). *Nelson numeracy assessment kit: First to seventh year of school*. Southbank, Vic.: Thomson Learning Australia.
- Ma, L. (1999). *Knowing and teaching elementary mathematics: Teachers' understanding of fundamental mathematics in China and the United States*. Mahwah, NJ: Lawrence Erlbaum.
- Meyer, J., & Land, R. (2003). Threshold concepts and troublesome knowledge (1): linkages to ways of thinking and practising. In C. Rust (Ed.), *Improving Student Learning: Improving student learning theory and practice - Ten Years On*. Oxford: Oxford Centre for Staff and Learning Development.
- Meyer, J., & Land, R. (2005). Threshold concepts and troublesome knowledge (2): Epistemological considerations and a conceptual framework for teaching and learning. *Higher Education, 49*(3), 373-388.
- NSW Department of Education and Training (2000). *Count Me In Too Professional Development Package*. Sydney: NSW Department of Education and Training.
- Phillips, V. J., Leonard, W. H., Horton, R. M., Wright, R. J., & Stafford, A. K. (2003). Can Math Recovery save children before they fail? *Teaching Children Mathematics, 10*(2), 107-111.
- Siemon, D., Izard, J., Breed, M., & Virgona, J. (2006). *The derivation of a learning assessment framework for multiplicative thinking*. Paper presented at the 30th Conference of the International Group for the Psychology of Mathematics Education – Mathematics in the Centre. Prague.
- Sousa, D. (2008). *How the Brain Learns Mathematics*. Thousand Oaks CA: Corwin Press.
- Wright, R. J. (2002). Assessing Young Children's Arithmetical Strategies and Knowledge: Providing Learning Opportunities for Teachers. *Australian Journal of Early Childhood, 27*(3), 31-37.
- Wright, R. J. (2009). An overview of mathematics recovery. In A. Dowker (Ed.), *Mathematics difficulties: Psychology, neuroscience and intervention*. San Diego, CA: Elsevier.

Now I'm teaching the children: Changing from Assessment of Learning to Assessment *for* Learning in Fiji.

Kaye Treacy

Cardno Emerging Markets

kaye.treacy@gmail.com

Sarita Harish

Fiji University

saritahrsh@yahoo.com

Poniparte Tiko

Fiji Department of Education

lowane.tiko@govnet.gov.fj

Prabha Nairn

Fiji Department of Education

prabha.nair@govnet.gov.fj

A Numeracy Strategy was trialled in 30 at-risk schools in Fiji. A Training Needs Analysis and a review of the Fiji Islands Literacy and Numeracy Assessment helped decide on the focus of the trial. Teachers were introduced to Classroom Based Assessment and child centred pedagogy, which they used over a four-week period. Students showed considerable improvement in their mathematics knowledge and attitudes. Teachers' knowledge and confidence in using classroom based assessment to improve students' numeracy also improved.

The Fiji Education Sector Program was funded by the Government of Australia and managed by Cardno Emerging Markets, in association with the Department of Education and Training, Western Australia and Curtin University of Technology. The goal of the program was to assist the Fiji Ministry of Education to deliver quality education services to children especially in disadvantaged and remote communities. The program began in 2003, finished in 2009 and included supporting Fiji's Ministry of Education to develop the Fiji Islands Literacy and Numeracy Assessment (FILNA) and a National Curriculum Framework. As a result of these two developments the Ministry decided that they needed to develop a Literacy and Numeracy Strategy to improve teaching and learning in rural, remote and disadvantaged schools around Fiji.

Background

Hawley and Valli (cited by Ingvarson, 2005) summarised research into models of professional development that foster improvement in student learning. They created a list of nine principles for the design of effective professional learning. This included suggestions that professional development should:

- Focus on what students are to learn and how to address the different problems students may have.
- Be based on analyses of the differences between (a) actual student performance and (b) goals and standards for student learning.
- Involve teachers in the identification of what students need to learn and in the development of the learning experiences in which they will be involved.

The Australian National Numeracy Review (Commonwealth of Australia, 2008) noted that "assessment is central to the teaching and learning process ... current research shows clearly that ... high quality classroom-based assessment ... is an integral part of the teaching and learning cycle". This view is supported by Groves, Mousley and Forgasz (2006),

By teachers becoming involved in researching pupils' mathematical understandings, teachers' own understandings of how children think mathematically and learn mathematics are enhanced, enabling them to develop teaching approaches and strategies to effectively help children to develop numeracy skills and understandings. (p.)

The Australian National Numeracy Review showed that many Australian numeracy strategies, (such as Count Me In and the Early Numeracy Research Project) have included



classroom-based assessment in their professional development. The New Zealand Numeracy Strategy (Ministry of Education, 2006) also included classroom-based assessment as an integral part of their professional development, and supporting documents.

First Steps in Mathematics Professional Development (WADET, 2004) included many Diagnostic Assessment Tasks as a central focus of discussion. Teachers were asked to initially analyse work samples provided. Later they analysed their own students' work samples and determined what mathematics students knew and what they had yet to learn. Teachers were supported to write a series of lessons to accommodate the needs of their students.

The Fiji National Curriculum Framework (Ministry of Education, 2008) acknowledged the importance of assessment and suggested a change in focus from assessment *of* learning to assessment *for* learning. Fiji's National Policy for Curriculum Assessment and Reporting (Ministry of Education, 2008) stated:

There is a need for a more balanced approach to assessment with a related emphasis on school based assessment of students. Such assessment provides more immediate feedback to students and can provide information to teachers as they teach. They can then better design learning programs that will lead to improvements in students' learning. (p.)

Prior to this, Fiji had an emphasis on external exams at Years Four, Six and Eight, and unit tests at the end of each term. School-based or classroom-based assessment was not common.

Beginning the Trial

The terms of reference for the Numeracy Strategy included a Training Needs Analysis, the development of Curriculum Resource Materials, a series of workshops and an in-school trial period.

Establishing the Focus and Direction of the Strategy

FILNA data was analysed and a Training Needs Analysis survey and workshop were conducted to ascertain the current status of mathematics teaching in primary schools and to establish the focus and direction of the strategy. The survey was developed, trialled with teachers, modified and then used in the workshop with a group of invited professionals, including District Education Officers, head teachers (principals), teachers and maths lecturers from Teacher Training Institutions. The survey included sections on Numeracy, Planning, Assessment, Pedagogy and Teacher Beliefs.

The results of the survey and the workshop discussions suggested that primary teachers needed support to:

- change from teacher centred to child-centred pedagogy; and
- use Classroom Based Assessment to plan activity based lessons to accommodate the needs of their students.

These connected ideas were represented by the diagram in Figure 1, which became a central focus of the Numeracy Strategy.

An analysis of the FILNA test items showed that students were experiencing difficulty in all areas of mathematics, number, measurement, space, and statistics. As there were many more items on number than in the other content areas, this suggested the focus of the strategy should begin with number. Forty percent of the number items at the Year Four level were

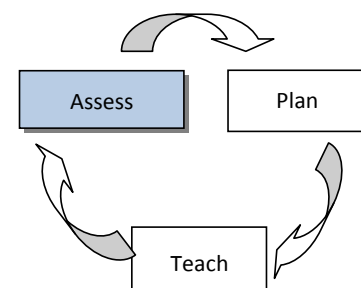

Figure 1. Diagram developed from Training Needs Analysis

assessing students understanding of the numeration system, which suggested that the Numeracy Strategy should start with this section of the curriculum.

Developing Numeracy Curriculum Support Materials

Curriculum Support Materials were written for Classes One to Four focusing on the Numeration System. The books included sections on:

- Classroom Based Assessment tasks to help teachers to find out what their students knew and what they needed to learn.
- proformas to assist teachers to record the information from the assessment tasks.
- the mathematics that students needed to learn, including common misconceptions.
- activities that could be used to teach students the mathematics

The materials were developed using action research methodology, beginning with the development of the Classroom Based Assessment Tasks. These were trialled by Curriculum Officers in a range of primary schools and the information used to modify and develop the tasks further. On the basis of the information gained from the student work samples, the mathematics sections and activities were written for each class.

The mathematics in each of the books was broken up into the following sections: subitising, counting, partitioning, number sequences (including forwards and backward sequences, comparing numbers, reading and writing numbers), and place value.

Methodology

Class Four and Six FILNA data from 2008 were used to select thirty at risk primary schools in which to trial the Strategy. To do this, the schools data were ranked using the average for both Class Four and Class Six. The schools with the poorest average in each of the four geographic divisions were selected. Some of the poorest performing schools were on the eastern islands, and with limited time and high travel costs, it was not possible to include these schools in the trial. Most chosen schools were from rural and remote regions, with the remaining being at-risk urban schools. A teacher and head teacher from each school were invited to participate in the trial and to attend two, three-day workshops. District Office staff were also invited.

Data were gathered from a number of different sources throughout the trial including: teacher and head teacher surveys at the beginning and end of the trial; evaluation rating scales after each workshop; interviews with teachers, head teachers, parents and students; and observation of lessons, samples of students' work, and teachers' planning and recording documents. Teachers were also asked to share their stories in Workshop Two. The stories were monitored using checklists.

Training Teachers and Head Teachers

Two, three day workshops were held in five different locations around Fiji for teachers and head teachers from the 30 schools. The locations were Suva, Nausori, Tavua, Labasa, and Namalata Bay. The workshops were focused on using the Curriculum Support materials to help teachers use information from the Classroom Based Assessment tasks to plan to meet the learning needs of their students and to improve teachers' content/pedagogy knowledge. The workshops included:

- How to use Classroom Based Assessment tasks to identify the needs of students.
- Work samples that exemplified typical difficulties students experience.

- Supporting teachers to write plans to meet the needs of all students.
- Pedagogy to support students learning.
- The layers within the mathematics of the Numeration System.

Teachers were introduced to the new content through examples of students' work from the Classroom Based Assessment tasks, for example see Figure 2. These samples showed typical difficulties and misconceptions held by students. They were used to highlight the critical mathematics concepts that teachers needed to focus on to improve students' mathematics. Teachers were supported to use the Curriculum Support Material to write plans to accommodate the needs of students.

Name MARETA

a) 17, 18, 19, 20, 21, 22.

b) 66, 67, 68, 69, 06, 61.

c) 88, 89, 90, 81, 82, 83, 84.

Figure 2. Class 3, forwards counting by ones.

In- School Trial

At the end of Workshop One, teachers and head teachers were asked to assess, plan and then teach in their own class for a period of four weeks. Participants choose assessment tasks appropriate for their class and completed a contract naming these tasks. They assessed their students at the beginning of the trial period and then again at the end of the period, using a modified version of the same task. Teachers and head teachers were asked to record the information on the proformas provided within the Curriculum Support materials, and to bring examples of students' work and their planning documents to the second workshop.

During the second workshop the Numeracy Team worked through the data with participants using proformas. Participants were supported to define each of the categories: No Improvement, Minimal Improvement, Some Improvement or Considerable Improvement. The teachers and head teachers recorded the number of students within each category. The criteria for each varied according to the nature of the assessment task. For example, counting forwards and backwards in class three:

- No Improvement – no change from the beginning to the end of trial
- Minimal improvement - not able to count forwards by tens up to 100 at the beginning of the trial, could count forwards by tens up to 100 by the end.
- Some improvement - not able to count forwards or backwards by tens up to 100 at the beginning, can count forwards and backwards by tens past 100 at the end.
- Considerable improvement - not able to count forwards or backwards by tens up to 100 at the beginning, can count forwards and backwards by 10s beyond 200.

Students who had everything correct at the beginning and end of the trial were included in the No Improvement category.

Results and Discussion

Using Classroom Based Assessment.

The survey at the beginning of the trial asked teachers to list all the types of assessment they

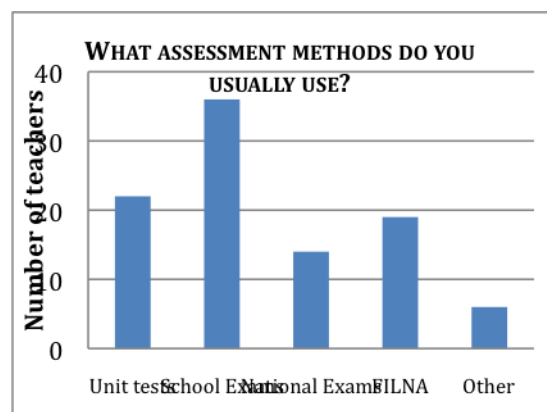

Figure 3. Assessment used before the trial (N = 64).

currently used. Figure 3 shows that before the trial, teachers were far more familiar with school exams and unit tests than other forms of assessment. (Note, teachers could choose more than one category)

The survey at the end of the trial period (Table 1) included the following questions: a) How confident are you in interpreting Classroom Based Assessment tasks? b) During the trial, how often did you consider students' existing knowledge and understanding in planning maths lessons?

	<i>Not Confident</i>	<i>Some Confidence</i>	<i>Confident</i>	<i>Very Confident</i>
<i>How confident are you in interpreting Classroom Based Assessment tasks?</i>	0%	3%	56%	41%
	<i>Never</i>	<i>Sometimes</i>	<i>Often</i>	<i>Very Often</i>
<i>During the trial, how often did you consider students' existing knowledge and understanding in planning maths lessons?</i>	2%	16%	53%	29%

Table 1

Use of Classroom Based Assessment from the End of the Trial (N = 64 teachers/head teachers)

The 2% who did not use assessment to plan lessons, were participants who were not in classrooms, e.g., non-teaching head teachers. The evidence above suggests that the majority of teachers were confident in using and interpreting the assessment tasks and they used the information to help them to work out the learning needs of their students.

Evidence from the interviews showed that teachers had assumed students would be able to do things like read and write numbers into the thousands. The teachers were shocked when they found that students could not do this. For example, a Class Seven Head Teacher applied the Class Four assessment tasks and found that some of his students could not read and write two digit numbers while others could not read or write three or four digit numbers. To address this, this teacher grouped his students according to their needs and modified the learning activities for each group. For example, the students constructed number charts and played dice games on them, which focussed on the numbers that they needed to learn. Some teachers reported that they found some of their most able students had the same difficulties as their less able students.

Teachers' knowledge.

The survey at the end of Workshop Two included many questions about teachers' knowledge and confidence (Table 2). The survey included the open-ended question: *One thing I learned in this workshop was.* Comments included:

- To first assess children before we do other activities not only for Numeracy but other areas, then plan and teach and go with the cycle again. I've learnt a considerable amount of solutions for the children's problems.
- The order in which we have to teach our children. The basics which have to be taught to the children before moving up to upper classes and the activities.
- The workshop had lots of information which we overlooked during our teaching of maths. We had been blaming students, not knowing we were at a fault.

	<i>Very little</i>	<i>Minimal</i>	<i>Some</i>	<i>Considerable</i>
<i>How much has your understanding of Numeracy changed as a result of the trial?</i>	0%	0%	11%	89%
<i>How confident are you with the mathematics of the Numeration System?</i>	0%	2%	78%	20%

Table 2

Teachers' Knowledge and Confidence at the End of the Trial (N = 64 teachers/head teachers)

During the interviews, teachers commented that the classroom-based assessment helped them to identify the learning needs of their students. They said that this helped them to plan effective lessons. For example one teacher said, "I'm no longer teaching the syllabus, now I'm teaching the children."

From the interviews it was found some teachers planned at the beginning of the trial, while others planned more regularly, every two weeks, every week, and some every day. While most said that they found it easy to write a plan, some said that they initially had difficulty in getting started. Those who initially had difficulty also said that they found the process easier each time they prepared a plan. They found the plan helpful and followed it in their teaching.

The evidence above suggests that teachers gained confidence in using and interpreting Classroom Based Assessment tasks with 97% of survey responses saying they were confident or very confident. The majority used this information to plan lessons for their students, with only 2% of respondents saying that they did not use this information to plan. This is a noteworthy change from the pre-trial survey, which showed that very few teachers used classroom based assessment to help them plan what they should teach.

Improved Student Learning.

The student data for each class group were amalgamated across all of the Classroom Based Assessment tasks according to how much improvement the students had demonstrated from the beginning of the trial to the end. The results are shown in Figure 4.

At the end of Workshop Two, teachers provided a copy of their written planning documents. Teachers' written reflections often showed the effectiveness of the activities. For example, one teacher wrote:

The first activity that was done with the class was 'Bundle Up'. After the activity, it was observed that the children were using the words 'bundle up' with their friends of other class and teaching them on the importance of counting in bundles (of 10, 100). During this activity a full class participation was seen throughout the lesson, something that is not usually seen in normal maths lessons.

After discussing the activity the students understood the purpose of bundles in counting. They were able to count a given number very quickly and effectively using the bundles. They also came to realise that 10 bundles of 10 makes 100. Shinal was heard explaining to Hamlesh that 'this is why we say $10 \times 10 = 100$ '. (Labasa teacher)

The first quote above indicated a positive change in students' attitudes, while the second indicated an improvement in students' understanding of place value.

The survey at the end of the trial (Table 4) included the following questions about students' attitude and engagement in lessons: a) Did students engage in mathematics activities/conversations outside of mathematics lessons? b) Did you notice any difference in student attendance during the trial?

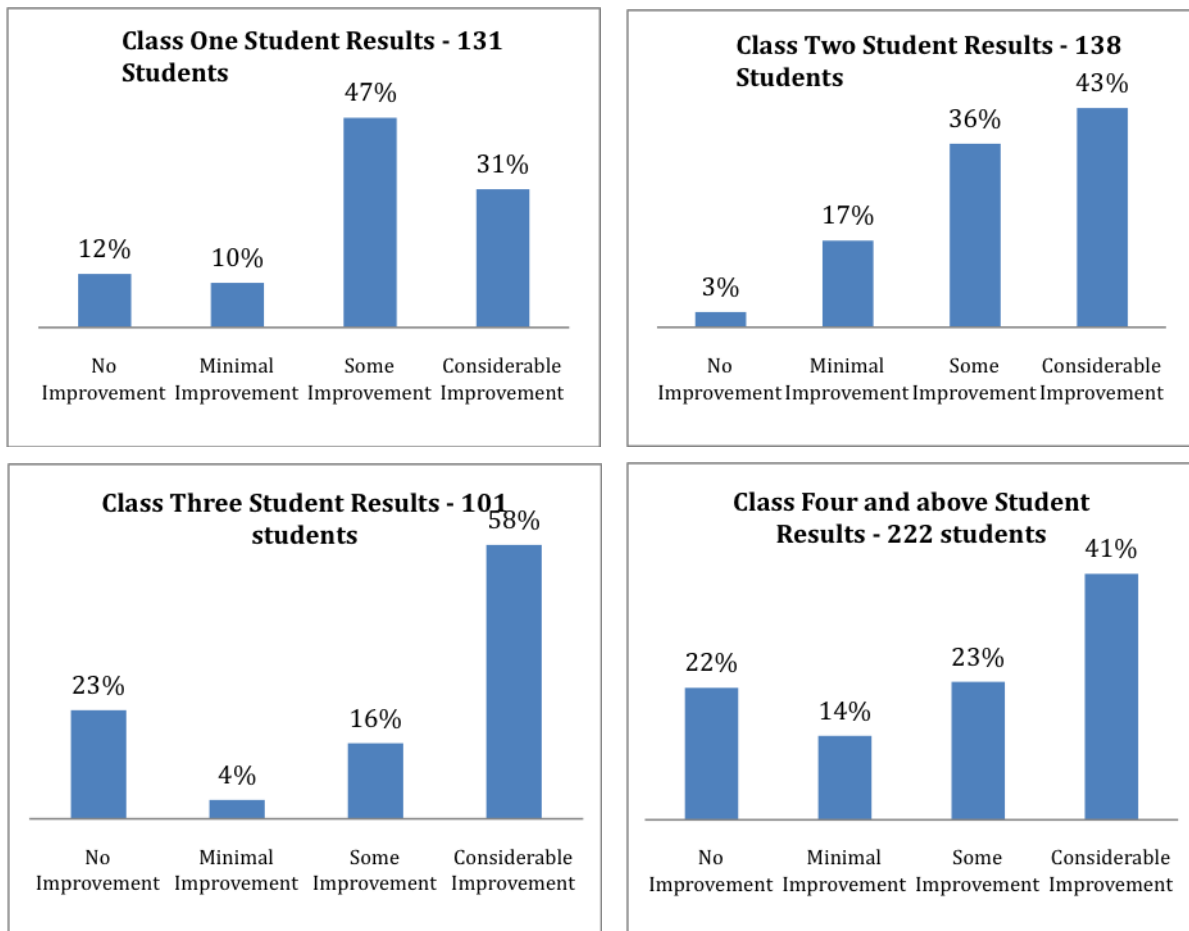

Figure 4 Student data from classes one to four

The evidence suggested that the four-week trial period produced an improvement in students' mathematics knowledge and an improvement in students' attitudes. 97% of participants noticed that students applied their new knowledge outside of the classroom mathematics lessons, indicating a significant improvement in students' knowledge and understanding. 91% indicated a positive change in student attendance during the trial period, with students attending school in the week prior to the term break, which was not usual.

	Yes	No
Did students engage in mathematics activities/conversations outside of mathematics lessons? Comments included:	97%	3%
<p>Since games and activities were very enjoyable they don't want to stop doing maths they want it for the whole day. So they carry this through during their spare time.</p> <p>The concepts of counting were related to other areas they engaged themselves with especially during gardening and doing afternoon duties.</p>		
Did you notice any difference in student attendance during the trial?	91%	9%
<p>Comments included:</p> <p>I noticed a great difference in my students' attendance – full attendance, right through the last day of term. They were looking forward to take part in activities during maths lessons.</p>		

Table 4
Students' Attitude and Engagement During Trial Period (N=64)

The evidence from class observations, interviews and written reflections suggested that teachers and head teachers found their student engagement, improvement in understanding and attitude inspiring. They said that this would encourage them to continue to use the processes and strategies in their classroom mathematics lessons after the trial. For example, one teacher said:

The enthusiasm and the happy faces I noticed in the children were quite overwhelming. It touched my heart when I realized that this is what a lesson should look and feel like instead of talk and chalk method we are used to. I have heard the term child centred education 30 years ago at training college. This is the first time I have come across a subject that has been designed and prepared to suit it.

Conclusion

The Fiji Numeracy Strategy pilot introduced teachers to Classroom Based Assessment, and child centred pedagogy. Teachers found the Curriculum Support Materials written and used during the trial period very helpful. However, time only allowed for materials to be written for Classes One to Four and this will need to be extended at some time in the future.

Teachers found using Classroom Based Assessment really helped them to plan for their students' learning needs. They also found that moving from teacher centred to child centred pedagogy resulted in students becoming more engaged in mathematics lessons. This shift in pedagogy enthused the teachers as they were able identify the mathematics their students needed to learn and to plan child centred lessons to accommodate them. As one teacher commented, "*I'm no longer teaching the syllabus, now I'm teaching the children.*"

As a result of the improved student outcomes demonstrated by this trial, the Fiji Ministry of Education has decided to implement the Strategy across Fiji.

Acknowledgements

Thanks to: the Fiji Ministry of Education, the Government of Australia, Cardno Emerging Markets, Department of Education and Training, Western Australia, and Curtin University of Technology, and the teachers and students who participated in the trial.

References

- Commonwealth of Australia, (2008). *National numeracy review report*. Retrieved 14th March 2010 from http://www.coag.gov.au/reports/docs/national_numeracy_review.pdf
- Groves, S., Mousley, J., & Forgasz, H. (2006). *Primary numeracy: A mapping, review and analysis of Australian research in numeracy learning at the primary school level*. Canberra: Department of Education, Science and Training.
- Ingvarson, L. (2005). *Getting it Right Symposium: (Paper 2) getting professional development right*. Paper presented at ACER Research Conference, Retrieved 14th March 2010 from http://research.acer.edu.au/professional_dev/4
- Ministry of Education, Fiji. (2008). *National curriculum framework*. Suva: Ministry Publishing.
- Ministry of Education, Fiji. (2008). *National policy for curriculum assessment and reporting*. Suva: Ministry Publishing.
- Ministry of Education, New Zealand. (2006). *Book 2 Diagnostic interview: Numeracy professional development project*. Wellington, New Zealand: Ministry of Education.
- Western Australian Department of Education. (2007). *First Steps in Mathematics: Number facilitator notes*. Perth: STEPS PD.

Student Centred Approaches: Teachers' Learning and Practice

Colleen Vale
Victoria University
<colleen.vale@vu.edu.au>
Anne Davies
Victoria University
<anne.davies@vu.edu.au>

Mary Weaven
Victoria University
<mary.weaven@vu.edu.au>
Neil Hooley
Victoria University
<neil.hooley@vu.edu.au>

Student centred approaches to teaching and learning in mathematics is one of the reforms currently being advocated and implemented to improve mathematics outcomes for students from low SES backgrounds. The models, meanings and practices of student centred approaches explored in this paper reveal that a constructivist model of student centred teaching and learning is being promoted and implemented with some success. The ways in which teachers and leaders are being supported through network and school based professional learning are described.

A multi-faceted network approach to improving literacy and numeracy outcomes of students in low socio-economic status (SES) school communities is the context for the current study. It was developed and is being implemented in Victoria and is jointly funded by the Australian and Victorian Governments (DEEWR, 2008; DEECD, 2009). The Victorian Pilot combines the five areas of reform identified in the Australian Government's initiative: (1) leadership and whole school change; (2) lifting teacher capacity; (3) effective use of student data; (4) student centred approaches and interventions; and (5) engaging parents and community (DEEWR, 2008; DEECD, 2009). These reforms are being implemented in Victoria through networks of schools that work together to take joint responsibility and to learn and share effective practices. The networks and schools are supported by a network leader, teacher coaches, and regional numeracy and literacy leaders.

The particular focus of this paper is student centred approaches, the ways in which it is being defined and implemented by regional and school leaders and teachers, the practices of teachers, and their perceptions of its impact on student learning.

Background

Student centred approaches (SCA) to teaching and learning are informed by both constructivist and socio-cultural theories of learning. From both theoretical perspectives, the student is the centre, or focus, of all learning and teaching decisions. However the different theoretical perspectives as well as perspectives from different disciplines and education policy documents mean that this concept may be confusing for teachers. Most alternate terms used in the literature privilege socio-cultural theory, for example, personalised learning, independent learning, autonomous learning, and authentic learning. In this sense SCA "gives students greater autonomy and control over choice of subject matter, learning methods and pace of study" (Gibbs, 1992, cited by Sparrow, Sparrow and Swan, 2000). Black (2007) provided a framework for SCA encompassing a range of elements. These elements include student control over their own learning as well as teacher flexibility and responsiveness to students' lives, needs, knowledge and interests:



A student-centred approach to teaching and learning:

- Is based on a challenging curriculum connected to students' lives
- Caters for individual differences in interest, achievement and learning styles
- Develops students' ability to take control over their own learning
- Uses authentic tasks that require complex thought and allow time for exploration
- Emphasises building meaning and understanding rather than completing tasks
- Involves cooperation, communication and negotiation
- Connects learning to the community. (Black, 2007, p. 1)

Black (2007) cited three models of SCA: (1) Inquiry and problem based learning where students have control over their learning and there are high levels of co-operation among learners; (2) Authentic curriculum, for example, Queensland's New Basics Curriculum (DET Queensland, 2004) where learning is connected to students' interests and needs using rich and authentic tasks; and (3) Constructivism where teachers tailor their instruction to students' learning needs.

A search of the mathematics education research literature for SCA yields few studies yet the term is frequently used to describe effective teacher practice in mathematics. From the learning perspective, Cobb (1999) argued that mathematical learning "should be viewed as both a process of active individual construction and a process of enculturation into the mathematical practices of wider society" (p.136). Studies focused on improving mathematics teaching and learning often adopt a constructivist perspective of SCA. For example, the Early Numeracy Research Project (DEECD, 2007) and Scaffolding Numeracy in the Middle Years (Siemon, Izard, Breed & Virgona, 2006) each provided findings to show that effective teaching occurs when the student is the centre of all decisions about teaching and learning. Each of these projects provided guidelines to teachers on knowing students' strengths and weaknesses and using effective assessment tools (designed by these projects) to identify students' learning needs. They provided evidence of the effectiveness of targeted teaching and differentiating learning according to student learning needs based on growth in achievement. These and other studies indicated that SCA involves grouping students based on need, selecting models, representations and tools for working with mathematical ideas, making connections between and sequencing key ideas, strategies, tasks and representations, using open-ended tasks, using scaffolding prompts to aid mathematical thinking and learning, and providing choice of activities or tasks to students. Black argued that SCA is not yet well defined or understood by classroom teachers:

For student centred learning to flourish in more schools in disadvantaged communities, it needs to be better understood as a rigorous practice. Work is needed to develop sharper definitions of what student-centred learning constitutes, collate the evidence of its positive impact on student outcomes and disseminate workable models and supportive tools to schools. (Black, 2007, p. 37)

In this paper we describe the way in which teachers in low SES school communities have taken up the challenge of improving student outcomes by building their knowledge and developing practice that may be described as student-centred.

The Study

The forty-three (43) government schools in this study belong to two networks of primary and secondary schools in regional Victoria making up about one half of the schools participating in the Victorian Pilot. The schools ranged in size from small rural schools of 14 students to moderately sized secondary schools of up to 542 students in

regional centres. These two networks of schools were selected by the DEECD for participation in the Victorian Pilot because of the low SES of the school communities in this network and the general underperformance of these networks overall and of individual schools when compared with other networks in Victoria. Some schools in these networks also have high proportions of Koori students or students who are new arrivals in Australia, refugees or meet the criteria for learners of English as a second language (ESL).

The study used a mixed methods design incorporating quantitative assessment of student mathematics outcomes and collaborative practitioner research methods (Davies, Cherednichenko, Kruger & O'Rourke, 2001) involving principals, assistant principals, numeracy leaders, numeracy coaches, regional network leaders and other regional project staff. The collaborative practitioner research involved the collection of personal accounts by email and round tables. We sought responses from between one and six teachers in each school (depending on the school size). We asked three questions of the participants:

- Can you please provide an account of what you have been doing to improve numeracy outcomes for school/network?
- Why did you adopt this action, approach or strategy?
- What observations have you made about the success or otherwise of your approach?

We received 69 responses, from 18 schools, about half of which were responses about numeracy (the others were responses to the same questions about literacy). We then conducted a series of round tables where participants shared their personal accounts and analysed them. In this process teachers firstly analysed their accounts to generate their personal theories. Then the participants collaborated in groups to construct concept maps of reform and effective practices using their personal accounts and theories.

Concurrently measures of student outcomes were made using student assessment data collected at six monthly intervals during the study, which is on-going, and reported elsewhere (Vale, Davies, Hooley, Weaven, Davidson & Swann, 2010).

The findings reported in this paper arise from the analysis of participants' personal accounts concerning mathematics teaching and learning. We have used Goos' (2006) application of Valsiner's (1997) zone theory to analyse and structure the reporting of findings. We start by providing the context in which teachers began to develop SCA (zone the promoted action) and the structures, processes and resources provided to support teacher change (zone of free movement).

Promoted Action, Structures and Resources

The regional office of the schools in these two networks had established a professional learning program for school leaders as well as strategies for improving student outcomes in numeracy prior to the implementation of the Pilot. These policies documented instructional leadership practices in numeracy (and literacy) and effective teaching and learning practices for mathematics. The practices promoted in instructional leadership programs include planning learning based on students' knowledge, differentiating curriculum, using inclusive curriculum and connecting knowledge. For example:

Effective classrooms are organised around the pre-existing understandings of students. Connected concepts are taught in depth, and students are supported in monitoring their own learning. (DEECD, 2007, Module 2)

Effective units of work explicitly link content (knowledge and skill), learning activities, intended outcomes and assessment criteria. (DEECD, 2007, Module 8)

These promoted practices align with a constructivist theory of learning and also advocate that students take some control of their learning.

The numeracy strategy emphasises the teaching of “differentiated lessons that focus on deep, connected numeracy understanding” (DEECD, 2008, p. 5). The professional learning activities delivered in network meetings for principals, numeracy leaders and teachers is based on the Zone of Proximal Development (Vygotsky, 1978) and focuses on three main ideas:

- Where is the student at?
- What is the next point for their learning?
- Teach in depth

The programs are designed to enable teachers to identify a students’ pre-existing knowledge in order to plan teaching for each student’s learning needs, to be explicit, to use collaboration in classroom settings to consolidate children’s learning, and to aim for independent thinking.

Schools and teachers in the Pilot have been assisted to develop and improve their teaching practice through concurrent professional learning programs and leadership roles and structures within schools. Professional learning programs are delivered to School leaders, numeracy leaders or teachers through network meetings and numeracy leaders facilitate professional learning through teams of teachers grouped into professional learning teams (PLT) in their schools. Numeracy leaders are classroom teachers who also have responsibility for leading improvement of practice and outcomes in their school or sub-school. Numeracy coaches are expert teachers of mathematics who have received additional training about coaching and in effective mathematics pedagogy. Principals assign their regional numeracy coach(es) to work individually with teachers to improve their practice. Numeracy coaches are also assisting numeracy leaders to facilitate PLTs.

The personal accounts of numeracy coaches and leaders provide evidence of the practices that are being promoted and the structures and leadership approaches to support teachers. The following personal account explains that the leadership and network structures that bring together coaches, leaders and professional learning have been important for gaining commitment from teachers at different year levels in their schools:

We are starting to realise the value of using data to inform our planning and teaching. The model of having a link between the Maths Coach and the rest of the staff through a team of Maths leaders who are given extra training that can be tailored to the needs of their target area of the school and shared with their colleagues is an effective model that will gain strength over time as teachers who are feeling inundated are starting to see it as support rather than an imposition. (Numeracy Leader, Primary school)

PLT meetings and network meetings have enabled teachers and leaders to share their practice of SCA and discuss their students’ learning:

PLT meetings, which were not running regularly or with much of a focus are becoming value adding experiences for many of the teachers with the student at the centre of the conversation. This has not been an easy task and continues to need focused work and much support, but the three schools [school names deleted] have begun the journey. Activities like looking at student data to determine the teaching needs of a student or sharing students’ pieces of work are beginning to happen. Collegial sharing is happening between these three schools as a result of both the literacy and numeracy leaders being able to meet twice a term and continues to happen even though our formal group meetings have finished. (Numeracy Coach)

This account also illustrates that the process of change begins by discussing and analysing student work and achievement. In many of the schools particular assessment

tasks have been identified and used to enable teachers to find the student's level of understanding or fluency in order to plan for their further learning:

An assessment schedule was developed to include a number of assessment types such as Hume Fluency Assessment, On Demand tests etc. PD was then conducted on Assessment As, For and Of, with teachers discussing and/or displaying samples of each type and what these might look like across different levels. At present an assessment chart is being constructed with hyperlinks to samples as a reminder of what can be done. (Numeracy coach)

The following two accounts show how numeracy leaders have assisted colleagues to use the information gathered about their students and to reflect on their teaching to plan effective lessons. Each includes reference to identifying groups of students with similar learning needs and planning differentiated lessons or tasks:

In my role as Numeracy leader I have assisted staff to identify their groups, a common thread of need and plan differentiated lessons. I regularly undertake Numeracy walks to see what is occurring in classrooms and to gauge the levels of support required...We ran sessions on Differentiated lessons and spent some planning sessions, collectively planning a differentiated lesson to match an area of need. (Numeracy leader, Primary school)

I have spent Term 3 working in two classes, a grade 3 and a grade 2 to raise the levels of learning and the delivery the program. I have done this by analysing assessments with them, assisting in the formulation of similar need groups, co-constructing lesson sequences, differentiating tasks, locating activities and materials to meet needs, and providing feedback about my observations of the student's progress. Through the use of video I have been able to lead the teachers to evaluate the quality of their instruction and the physical organisation of their classes. (Numeracy Leader, PS)

Teacher Accounts of Student Centred Approaches

When we began to analyse the personal accounts of teachers, leaders and coaches we noticed that the actual term 'student centred' did not appear to have wide currency in any of the data collected. Teachers, numeracy leaders, school leaders and coaches more commonly used terms such as 'differentiated teaching', 'independent learning', 'personalised learning' and catering for 'individual students'.

Teachers who provided personal accounts believe that assessment for learning in the form of pre-testing and ongoing assessment are essential for plotting students' developmental pathways and planning sequential and differentiated lessons. They are aiming to design programs that match each student's zone of proximal development. While some teachers have been using data for a long time, they say that attending recent professional development activities has allowed them to make a connection between looking more deeply at assessment procedures, recording the data, analysing the data and using it to identify students' strengths and weaknesses. One teacher argued that a cycle of learning is essential – "assessment, analysis, learning program, assessment".

I have completed the Numeracy Fluency Assessment with each child and updated it throughout the year. This has given me an excellent basis for all of my numeracy program as I am conversant with the competencies of each child. I operate on a whole-small-whole method and have 4 numeracy groups. Hands-on activities with the expectation of accurate recording works well for me. Once again, planning as a whole team of Middle school teachers is fantastic. (Primary teacher)

We have conducted one-on-one interviewed for Year 7 & 8 students who have been identified at below the expected VELs level. These interviews identified points of needs for those students and we have then taught the students activities to progress these pupils. (Secondary teacher)

This year our school has undertaken a whole school approach to teaching Mathematics. To achieve this all teachers have participated in individual testing of all children – Prep-2 using the Mathematics Online Interview and 3-6 using Hume Fluency Assessment. The data from this testing

then was to be used to plan for individual needs and explicitly teach the skills and strategies at each child point of need.... The structure of a lesson was analysed and each section then modelled and practised during class lessons, and later discussed during unit meetings. Fluency tasks, differentiated lessons and reflection on the daily focus became an important part of our Mathematics teaching. (Numeracy Coach, Primary school)

Many personal accounts, such as the one above, include a reference to using some form of differentiated teaching linked to their use of assessment data including targeted teaching, use of grouping strategies and differentiated tasks:

By working with individuals or small groups you can assist students who are having difficulty with different maths concepts and make a difference. (Secondary Numeracy Leader)

I designed a grid to match the NFA [Number Fluency Assessment] which I encouraged staff to use. This gave a quick overview of a class, so teachers could quickly see what skills were required by whom. Grouping students for instruction was also easy to see. I have used this grid every week to select my groups and my areas of focus. (Numeracy leader, Primary school)

When you teach P-2 and 3-6 with just a few kids in each grade it presents enormous challenges. Team teaching to conceptual need overcomes this challenge as does the inherent flexibility offered by a program like Mathletics. (Principal, rural school)

The teachers in this study have commented positively on the use of targeted and differentiated teaching for their students' learning:

Providing lesson that are aimed specifically at the gaps in students abilities and learning have made great improvements to most students learning. (Yr 3 teacher)

The students are progressing well, they enjoy Maths sessions and are keen to articulate their learning and very confident to verify aspects they do not understand. (Primary teacher)

I have noticed that my students are more engaged as they are working at a level that suits them and they also have a more positive attitude towards mathematics as they are experiencing success. My higher achieving students have thoroughly enjoyed the challenges I have put to them and my lower students have been able to grasp concepts that would otherwise have gone over their heads. (Yr 1-2 teacher)

Others described improvements in their teaching practice or that of their colleagues:

The assistance I have received, in particular having the opportunity to work closely with a numeracy coach, has completely changed and improved my approach to teaching maths by:

- Showing me how to take apart and identify appropriate teaching sequences for each maths topic we cover
- Allowing me to practise and refine the structure of each lesson. I have always been aware of the suggested structure (whole, small, whole), but having a coach in the room allowed me to look at each aspect of the lesson in detail, see relevant demonstrations in context, and identify my own strengths and weaknesses
- Introducing to me specific assessment tools and being shown how to use the data from these for planning

My maths lessons now flow in a relevant sequence, I am confident with the content of my lessons, I know that each student is working at a level that they need to, and each of my lessons flows ... (Primary teacher)

The numeracy approach that I have taken this year has been quite successful, particularly once I was taken into the numeracy coaching program. I have found this to be particularly effective. My numeracy lessons are much more sequential, and differentiated targeting individual students needs much better. (Yr 3 teacher)

...I have observed the children being better organised, working in a quieter and more focused way and explaining their thinking more articulately. Both teachers are teaching in a more focused way, instructing with more clarity, demonstrating stronger modelling that includes their thinking

strategies and using their observations of one lesson to help plan the next. (Numeracy leader, Primary School)

Teachers' observations of improved learning are corroborated by analysis of assessment data which found greater than expected growth for primary students in a six-month period (Vale, et al., 2010). However this was not the case for secondary students.

Conclusion

Individual personal accounts from teachers and numeracy leaders attest to their acceptance and commitment to SCA that focus on developing fluency and understanding for improving student numeracy learning. Principals, numeracy leaders and coaches reported that professional learning teams were using, or developing skills in using, assessment tools and data to plan their teaching, and that they were promoting a range of differentiation tools, tasks, materials and resources to enact differentiated teaching.

The personal accounts of teachers about their practice and the personal accounts of coaches, leaders and Principals who reported on the practice of their colleagues provided evidence that teachers have begun to implement differentiated lessons and personalise numeracy learning. There were diverse understandings and practices in differentiated teaching and learning including:

- Using data to group students in ways that were either flexible or inflexible;
- Using flexible arrangements to personalise numeracy learning;
- Using tasks and materials appropriate to the student's stage of development; and
- Using fluency tasks for individual children in the classroom.

Individual personal accounts of teachers who have been coached and numeracy coaches and numeracy leaders also provided evidence of improvements in primary teachers' knowledge and capacity to take informed action in the classroom, that is, plan lessons that are based on students' "point of need," and support development of "deep, connected understanding". These changes in practice include:

- Planning lessons that focus on key concepts;
- Using explicit language to model concepts and explain thinking and reasoning;
- Planning lessons using the whole-small-whole structure more effectively;
- Using new insights into developmental pathways for mathematics learning to plan a sequence of lessons that flow and connect mathematical concepts and thinking; and
- Spending sufficient time on key concepts to sustain future learning.

While these teaching practices are not elements of SCA, this study shows that they are pre-conditions, related to the zone of proximal development, for teachers being able to implement SCA for mathematics learning.

In this study regional leaders and teachers have adopted Black's (2007) third model of student centred approaches to teaching and learning where teachers' tailor their instruction to meet the needs of their students. There were fewer accounts received from secondary mathematics teachers and, according to the numeracy coaches, developing similar practices in secondary classrooms is their challenge for 2010. Perhaps a broader view of SCA is also required to engage secondary students; an interpretation that makes connections with their lives, uses authentic tasks and develops their ability to take control of their own learning.

Acknowledgements

The study reported in this paper is part of larger on-going evaluation of the *Literacy and Numeracy Pilots in Low SES School Communities* that is jointly funded by the

Australian and Victorian Governments. We sincerely thank the teachers, Principals, coaches and education staff of the DEECD Region in this study who gave generously of their time, and Cathy Beesey, Jenny Schenk and Jane Stewart from the Office of Government Schools, DEECD, who provided direction and advice on the evaluation.

References

- Black, R. (2007). *Crossing the Divide*. The Education Foundation. (ERIC Document No. ED501899)
- Cobb, P. (1999). Where is the mind? In P. Murphy (Ed.), *Learners, learning, and assessment*. London: Paul Chapman Publishers.
- Davies, A., Cherednichenko, B., Kruger, T. & O'Rourke, M. (2001). Collaborative practices: From description to theory. *Proceedings of the 2001 annual conference of the Australian Association for Research in Education, Fremantle*.
- Department of Education and Early Childhood Development (DEECD), Victoria. (2007). *Common Curriculum for School Leaders. Hume Region*. Retrieved 12th September, 2009 from: http://www.hume.vic.edu.au/index.php?file=hume_region
- Department of Education and Early Childhood Development (DEECD), Victoria. (2007) *Early Numeracy Research Project (ENRP)*. Retrieved 12th February, 2010 from: <http://www.education.vic.gov.au/studentlearning/teachingresources/maths/enrp>
- Department of Education and Early Childhood Development (DEECD), Victoria. (2008). *Numeracy Strategy, Hume Region 2008-2009. Hume Region*. Retrieved 12th September, 2009 from: http://www.katungaps.vic.edu.au/files/numeracy_strategy.pdf
- Department of Education and Early Childhood Development (DEECD), Victoria (2009). *Literacy and Numeracy Pilots in Low SES Communities, Progress Report, July 2009*. Melbourne: DEECD.
- Department of Education, Employment and Workplace Relations (DEEWR). (2008). *Literacy and Numeracy Pilot Initiatives*. Retrieved 12th December, 2009 from <http://pilots.educationau.edu.au/>
- Department of Education and Training, Queensland. (2004). *New Basics Project*. Retrieved 9th March, 2010 from <http://education.qld.gov.au/corporate/newbasics/>
- Goos, M. (2006). Creating learning spaces. In P. Grootenboer, R. Zevenbergen & M. Chinnapan (Eds). *Identities, Cultures and Learning Spaces* (Proceedings of 29th Annual Conference of the Mathematics Education Research Group of Australasia, pp. 3 -14). Adelaide: MERGA.
- Siemon, D., Izard, J., Breed, M., & Virgona, J. (2006). Scaffolding Numeracy in the Middle Years (SNMY). Retrieved 12th February, 2010 from <http://www.education.vic.gov.au/studentlearning/teachingresources/maths/snmy/default.htm>
- Sparrow, L., Sparrow, H. & Swan, P. (2000). Student centred learning: Is it possible? In *Flexible Futures in Tertiary Teaching*, Teaching and Learning Forum, Curtin University. Retrieved 9th March, 2010, from <http://lsn.curtin.edu.au/tlf/tlf2000/sparrow.html>
- Vale, C., Davies, A., Hooley, N., Weaven, M., Davidson, K. & Swann, R. (2010). *Process Evaluation of Literacy and Numeracy Pilots in Low SES School Communities 2009-2010: An Interim Report*. Unpublished, Department of Education and Early Childhood Development, Victoria, February, 2010.
- Vygotsky, L. S. (1978). *Mind in society*. Cambridge, MA: Harvard University Press.

Documenting the Learning of Teacher Communities Across Changes in their Membership

Jana Visnovska
The University of Queensland
<j.visnovska@uq.edu.au>

Teacher mobility is often viewed as a limitation of longitudinal analyses of teacher learning in communities, in which membership changes. I introduce an analytical tool developed to address the continuation of the learning of such communities across changes in membership. In the case analysis, I examine whether changes in membership should be framed as induction of new members into a single community that evolves across the years, or instead as the emergence of a new community each time the membership changes.

Teacher mobility is typically construed as a challenge to building local instructional capacity and to sustainability of school- and district-based instructional improvement efforts. Yet, it is one of givens of school reality. It is therefore vital that the lenses that we develop for guiding research and design of instructional improvement in mathematics take this aspect of school reality into account. Among the most important of such lenses are our conceptualisations of teacher learning and how it can be supported over time.

Research on teachers' learning has been dominated by a cognitive paradigm that focuses squarely on teachers' knowledge and beliefs (cf. Ball, 2000; Borko, 2004). This conceptualisation of teacher learning suggests that fundamental change in teaching practice – and therefore in students' learning – might be initiated by changes in knowledge of individual teachers (Clark & Peterson, 1986; Fennema & Franke, 1992). For longitudinal interventionist studies conducted with groups of mathematics teachers within this paradigm, teacher mobility presents a challenge. This is because changes in teacher group membership produce disruptions in studied phenomena.

Efforts to support teachers' development of sophisticated instructional practices have brought to the fore the social contexts of teachers' work and, in particular, the opportunities for learning that these contexts afford. Ways of theorising teachers' learning that draw on situated theories of activity have become prominent in research on teacher professional development. The theoretical underpinnings of this perspective on teacher learning are derived primarily from the work of Rogoff, Lave, and Wenger (Lave, 1991; Lave & Wenger, 1991; Rogoff, 1997; Wenger, 1998). This orientation conceptualises learning as a process that is inherently related to the social and cultural contexts in which it occurs and attempts "to break down a distinction ... between the individual reasoner and the world reasoned about" (Cobb, 2001, p. 14126). Focus is on

the changes that occur in people's reasoning as they move from relatively peripheral participation to increasingly substantial participation in the practices of particular communities. In their overview of this type of research, Lave and Wenger (1991) clarify that the cultural tools used by community members are viewed as carrying a substantial portion of a practice's intellectual heritage. As Lave and Wenger note, this implies that novices' opportunities for learning depend crucially on their access to these tools as they are used by the community's old-timers. (Cobb, 2001, p. 14122)

By equating learning with increasingly substantial participation, this conceptualisation takes changes in community membership into account. In their influential work, Stein, Silver, and Smith (1998) appropriated the construct of legitimate peripheral participation to



understanding ways in which newcomers learned as they participated in increasingly central ways in activities of the school-based community of mathematics teachers.

In the professional development study that provides the case for this paper, the changes in membership in the professional development group reflected teacher mobility in the district and were at times substantial.³⁰ Yet the theoretical and methodological framing of the study made it possible to both guide the professional development design and analyse the learning of this group in terms of an emergence and subsequent development of a single professional teaching community. As we reported elsewhere, this learning across 5-year period was substantial (Dean, 2005; Visnovska, 2009). This observation affirms that ambitious goals for teacher professional learning in longitudinal school- or district-based collaborations can be viable in districts with relatively high teacher mobility.

To illustrate why teacher mobility does not become a conceptual limitation in studies conducted within situated paradigm, I first discuss the background and the theoretical framing of the study and then introduce the analytical tool for understanding learning of a community across changes in membership. I conclude by discussing the kinds of insights into teachers' learning that the analysis of continuation of a community makes available and its' contribution to robustness of the interpretive framework for analysing the learning of professional teaching communities.

Background of the Design Study

I draw on a professional development design study (Brown, 1992; Cobb, Confrey, diSessa, Lehrer, & Schauble, 2003) that we³¹ conducted with the group of middle-school mathematics teachers in a diverse urban school district with a high-stakes accountability program. We began working in the district to provide teacher development in statistical data analysis at the invitation of the district's mathematics coordinator. We conducted a two-day summer institute and three one-day work-sessions during the first year of the study, a three-day summer institute and six one-day sessions during each of the subsequent four years, and a concluding three-day summer institute. The broad study question concerned the process of supporting teachers' development of instructional practices centred in students' reasoning (Cobb & McClain, 2001). The membership of the group was stable for the first 2 years but changed during the last 3 years as teachers moved into administrative positions or left the district and new teachers were inducted into the group.

Methodological Background

In developing the analytical tool that is the focus of this paper I adopted a community of practice lens elaborated by Dean and colleagues (Cobb, McClain, Lamberg, & Dean, 2003; Dean, 2005). For these authors, the term professional teaching community is not synonymous to a "group of mathematics teachers who collaborate with each other in some way". Specifying the distinction between a group and a community is important given that not every group composed of mathematics teachers would provide them with the climate, the need, and the resources for a deep, systematic engagement in issues relevant to their

³⁰ Nine teachers participated during the first 2 years. Three of them left the group and 6 new teachers joined the 6 continuing members at the beginning of year 3. At the beginning of years 4 and 5, four and two leaving teachers were replaced by the same number of new recruits respectively.

³¹ Presented study was a part of a larger research project. The research team included the author, Paul Cobb, Kay McClain, Chrystal Dean, Teruni Lamberg, Qing Zhao, Melissa Gresalfi, Lori Tyler, and Jose Cortina.

profession. Some groups, nevertheless, have been documented to develop such resources (Carpenter et al., 2004). Based on review of the literature (e.g., Gamoran et al., 2003; Wenger, 1998), Dean and colleagues articulated the salient characteristics of a professional teaching community of mathematics teachers: a shared purpose or enterprise, a shared repertoire of ways of reasoning with tools and artifacts, and norms of mutual engagement.

In order to trace the emergence of the community and how it was supported, Dean analysed the development of four interrelated types of norms of mutual engagement that became established in the group: norms for (a) general participation, (b) pedagogical reasoning, (c) mathematical reasoning, and (d) institutional reasoning. These norms were documented empirically by discerning patterns or regularities in the ongoing interactions of the members of the group. A norm is therefore not an individualistic notion but is instead a joint or collective accomplishment of the group members (Voigt, 1995).

Dean (2005) analysed the emergence and subsequent learning of the community that provides the case for this paper during first 2 years of the study. She documented that that 19 months into the collaboration, the group had become a genuine professional teaching community. The shared purpose of the community centred on ensuring that students come to understand central mathematical ideas while simultaneously performing more than adequately on high stakes assessments of mathematics achievement. The norms of general participation that were key to the teachers' effective collaboration included building on others' contributions to discussions, asking questions, challenging others' assertions, as well as openly sharing problems experienced during instruction. These were in a strong contrast to the initial teachers' participation when challenges and conflicts were considered a violation of the participation structure and the teachers held their instruction private.

Dean's interpretive framework does not explicitly address changes in a group membership introduced by teacher mobility, because the group was stable over the years when the framework was developed. Even though the normative practices and the enterprise of a community are always generated and re-generated in the participation of its members, the term professional teaching community does not primarily refer to group membership. Rather, it refers to the collection of practices that are established as normative through teachers' participation in communal activities as the community pursues its purpose. The question that is central to establishing the continuation of a community across changes in its membership therefore concerns whether the normative practices of the group were re-generated after new members joined the group.

Analysis of Continuation of a Community

The data that I analysed consist of video-recordings of all professional development sessions in years 3-5 together with a set of field notes, copies of all the teachers' individual and collective work, and 9 classroom video-recordings of their statistics instruction that were produced for use in professional development sessions during years 3 and 4.

The analysis is guided by a framework that coordinates individual teachers' learning with the development of collective practices of the teacher community as they are situated in the institutional setting of a school district (Cobb, McClain et al., 2003). Building on interpretive framework for analysing the learning of professional teaching communities (Dean, 2005), I analysed the patterns and regularities in the ongoing interactions of the group members to establish normative practices of the group. The specific approach used to analyse data is an adaptation of Glaser and Strauss' (1967) constant comparative method, tailored for analysing longitudinal data sets that are generated during design experiments (Cobb & Whitenack, 1996). The tentative conjectures are continually tested

and revised while working through the data chronologically, resulting in a formulation of claims that span the entire data set but yet remain empirically grounded.

To understand whether the group of teachers continued to function as the community of practice after inclusion of the newcomers, and the process that supported their inclusion, I looked for evidence that would suggest (a) whether norms of general participation were explicitly negotiated with the newcomers, (b) whether old-timers³² participated in normative ways, thus modelling participation for the newcomers, (c) whether the newcomers participated in normative ways or breached the norms of the community, and (d) how what I identified as a breach of a norm was constituted in the group (i.e., whether it was constituted as a breach). It was my conjecture that if the group continued to function as a professional teaching community, the general norms of participation would be re-generated in the newcomers' interactions gradually, but in relatively short period of time. I looked for evidence of the newcomers voicing disagreement (rather than pseudo-agreement), actively making sense of discussions, and building on others' arguments in their contributions. Supporting deprivatisation of teachers' practices was a major challenge in the original group of 9 teachers in the first two years. I was therefore particularly interested in whether the newcomers made their practices available for group purposes, and, if so, how the old-timers and research team supported deprivatisation of the newcomers' practices.

Dean (2005) reported that the evolution of normative practices during the first two years differed at times with respect to the type of activity. For example, the teachers still interacted as a pseudo-community (e.g., never interrupted each other) when they were engaged in pedagogical activities (e.g., discussion of their students' work) during year 1. However, when they were engaged in statistics, they built on others' contributions and directed their comments to each other, not the researcher. I therefore conjectured that while the newcomers might have participated similarly to the old-timers in some professional development activities, their participation might have differed significantly in others. To identify activities in which the newcomers' participation was different from that of the old-timers, I first looked at the relative *frequency* of the newcomers' contributions to the group discussions. I generated exact participation counts for the group of the newcomers and the old-timers in those cases in which the newcomers' lack of participation was noticeable. Given that we designed the professional development activities with the intention of providing the newcomers with ways to actively participate and contribute from the very beginning, I conjectured that the relative frequency of newcomers' contributions should soon become proportionally similar to that of the old-timers.³³

It is important to clarify that while some newcomers and old-timers were talkative, others contributed less frequently but often indicated their intellectual presence throughout the debate. For this reason, comparing counts of individuals' contributions would be a poor indicator of the extent of participation in this type of analysis. I instead used sum of the utterance counts across the group of newcomers relative to that of the group of old-timers to indicate the extent to which the newcomers as a group (a) had access to the task at hand and the means to address it, and (b) were positioned as a resource during the whole group

³² Following Cobb (2001), I use the term *old-timers* to label the teachers who were not newcomers in the given year. This term does not indicate age or years in a teaching position of the member.

³³ I weighted the counts against the numbers of the newcomers and the old-timers who were *actually present* during an analysed activity. I report the counts for an activity as a ratio that signifies (number of old-timers' contributions per a participating old-timer : number of newcomers' contributions per a participating newcomer), for example (7.5 : 8.2).

discussions. Opportunities for the newcomers to make contributions and pose questions are critical to their participation becoming more central. This is because such opportunities facilitate newcomers' development of both community-specific competencies, and identities as valued members of the community (Stein et al., 1998). I used the relative participation counts as an indicator of the types of professional development activities in which the newcomers might not have had access to legitimate participation. I then further analysed these activities to understand the reasons for disparities in the newcomers' and old-timers' contributions and how the newcomers' participation could have been better supported.

To further understand differences in the newcomers' and the old-timers' participation, I identified episodes in which the newcomers' *ways of reasoning* about mathematical and pedagogical situations differed from those that were normative among the old-timers. In particular, I looked for situations in which the group members noticed differences in interpretations and engaged in negotiations of meaning. Such situations constitute a variation of the first type of evidence that a norm is being established, in which meanings that have previously been constituted as normative are challenged and must be re-negotiated in the whole group discussion.

I used this methodology to analyse continuity of the professional teaching community at the beginning of years three and four, when the ratios of newcomers to old-timers present were relatively high (6 : 6 and 4 : 8 respectively, when all teachers were present in the session). I conjectured that the lower proportion of newcomers in the group in year four might contribute to a more seamless re-constitution of the norms of the professional teaching community. To better understand the induction process, I looked for patterns that spanned these two years.

Case Analysis and Findings

Findings reported here are from year three analysis. Findings from years 4 and 5 corroborated the identified patterns (Visnovska, 2009). To understand the extent to which the norms for general participation and institutional reasoning were re-established after the newcomers joined the group, I first documented how the old-timers introduced the goals of the group and their valuations of these goals to the newcomers. The old-timers especially described and elaborated four themes: how the group (a) attempted to understand students' thinking, (b) attempted to use both curriculum and statistics instructional sequences used in professional development sessions as resources to plan instruction, and "redo" the textbook unit on statistics, (c) learned about Japanese lesson study and attempted to understand collaborative improvement of lessons over time, and (d) worked on issues related to institutional context, and especially on supporting principals' understanding of what high quality mathematics instruction involved.

The old-timers also shared their valuations of the collaborative nature of the group, its non-threatening culture, and highlighted the aspects that helped them to deprivatise, that is, open up their practices to others. This was crucial as the private nature of instruction was a major obstacle in the initial emergence of the professional teaching community (Dean, 2005). During the initial 3 sessions, each of the six old-timers indicated that they positively valued the sessions because they happened in an intellectually demanding and collegial environment of the professional teaching community. They communicated their views of instructional improvement as a collective responsibility of the group and shared their valuations of deprivatised collaboration as a means to understand and improve instruction. Most importantly, the old-timers also demonstrated the deprivatised nature of their

instructional practices by bringing their students' work and classroom video to sessions, and by talking openly about difficulties that they faced in their instruction.

From the beginning, the newcomers actively attempted to make sense during the discussions. Each of the 6 newcomers asked at least one question or contributed a comment in the whole group setting by the end of session one. For example, Erin, a newcomer, shared how the job of teaching mathematics in their district is perceived in ways that make it difficult for teachers to admit that they make mistakes and need to learn.

Erin: I think there is a fear, even in study groups, to admit that you don't know something, that you do not understand something. You are the *teacher*, so we are the *experts*, so we should know it. ... I think that's a big fear. And you are talking about the planning is so task oriented, we become task masters. ... We've got these things we got to cover (Year 3)

To understand the newcomers' opportunities for participation, I traced the relative frequency of their contributions to discussions in each professional development activity (e.g., solving a statistical task, analysing student work). From session one, it was typical that the newcomers frequently contributed to the group discussions. For example, during an activity, where the teachers solved a statistical task (session one), 47 contributions came from the 6 present old-timers, and 53 contributions came from the 6 newcomers (7.8 : 8.8). During the pedagogical reflections on this activity, the participation ratio was 8.7 : 5.8.

I identified only two cases of the newcomers' limited participation in professional development activities in year 3. The first occurred in session 2, when the group analysed classroom video of two old-timers co-teaching a statistics lesson (participation ratio 3.3 : 0.3). The second activity occurred in session 3, when the group continued to work on supporting principals' learning about high quality mathematics instruction that was initiated in year 2 (participation rate 15 : 5.2). I examined these cases to identify the specific demands of the activities and conjecture how the newcomers' learning could have been better supported. Overall, the general norms of participation were stabilised across all types of professional development activities by session four.

Lastly, I examined the newcomers' and the old-timers' nature of participation. I identified episodes in which the newcomers' ways of reasoning about mathematical and pedagogical situations differed from those that were normative among the old-timers. In terms of the teachers' mathematical reasoning, I identified no systematic differences between the two groups. In contrast, several exchanges evidenced that during the first two years, the professional teaching community developed a professional pedagogical discourse that was not immediately transparent to the newcomers to the group. In other words, the newcomers and the old-timers initially constructed different meanings while they sometimes used the same words (e.g., joint planning, re-teaching) to talk about specific pedagogical situations. I documented two episodes in which differences of this kind became evident in year three (both occurred in session 3). I discuss the first one here.

We asked the teachers to share what their opportunities were to talk to other teachers about mathematics instruction in their schools. A significant majority of the teachers maintained that it was not easy or at all possible for them to coordinate their planning time with other teachers. However, three newcomers stated that they regularly jointly planned their lessons. It transpired that there were two different views of joint planning in the group. For the newcomers, joint planning included situations where they split an instructional unit with a colleague and only had to prepare materials for a half of the lessons. Doing this was not time demanding, in contrary, it saved some preparation time and made the job of teaching more manageable. Three old-timers noted that joint planning encompassed discussing and analysing students' prior learning, "the actual presentation of

the lessons, the points we want to cover, could we have done this better” (Amy), and “sitting down and actually talking about what worked or may not work” (Marci). They maintained that such joint planning is both time consuming and intellectually demanding. Negotiations of meaning afforded by episodes of this kind, supported the newcomers’ increasingly central participation in the professional teaching community.

Discussion

The analysis provides insights that are relevant to both (a) documenting actual learning of the teacher group and to (b) making design modifications that might be beneficial for future efforts to support the learning of professional teaching communities. First, the findings make it reasonable to talk of the evolution of a single community where the changes in the group membership are conceptualised in terms of induction of new members, rather than in terms of an emergence of a new community at the beginning of every year. More importantly, this analysis justifies that subsequent shifts in the normative practices that occurred in different years of the collaboration should be interpreted as learning of the single professional teaching community.

Second, the analysis provides initial evidence of substantial communal learning. This was especially in the negotiations of meaning between the old-timers and the newcomers. These negotiations indicate that the old-timers’ pedagogical reasoning differed from the reasoning that most of their colleagues had developed while working in the district.

Third, this analysis reveals cases in which the newcomers’ participation was not sufficiently supported. For instance, in the initial activities in which the teachers analysed classroom videos in both year 3 and year 4, the newcomers in the group did not readily have a way in which to meaningfully contribute to the group discussions. This suggests an avenue for further improvement of the professional development design.

Last, the group benefited from initial professional development activities in which the resources on which old-timers’ and the newcomers’ could draw were balanced. Activities that did not draw heavily on the old-timers’ history of participation in the community provided more opportunities for the newcomers’ participation, and therefore also more opportunities for the newcomers to uphold and contest the general norms of participation.

Conclusions

In reporting analyses on longitudinal learning of a professional teaching community the reviewers tend to indicate that member changes in the teacher group should be discussed as one of the limitations of the study. I would like to suggest that analytical and methodological approaches in which teacher mobility has to be construed as a limitation address problems that do not exist in educational contexts, namely, how to support learning of teacher groups that are stable over extended periods of time. The analytical tool presented in this paper allows for gaining insights into learning of professional teaching communities in which membership changes. As a result, the framework for analysing learning of professional teaching communities over extended periods of time (Dean, 2005) remains meaningful in professional development settings where teacher mobility is a part of reality and induction of new members a desired (rather than limiting) phenomenon.

Acknowledgements

The preparation of this paper was supported in part by The University of Queensland under NSRSU grant No. 2009002594. The findings and opinions expressed here are those of the author and do not necessarily reflect the views of the funding agency.

References

- Ball, D. L. (2000). Bridging practices: Intertwining content and pedagogy in teaching and learning to teach. *Journal of Teacher Education*, 51, 241-247.
- Borko, H. (2004). Professional development and teacher learning: Mapping the terrain. *Educational Researcher*, 33(8), 3-15.
- Brown, A. L. (1992). Design experiments: Theoretical and methodological challenges in creating complex interventions in classroom settings. *Journal of the Learning Sciences*, 2, 141-178.
- Carpenter, T. P., Blanton, M. L., Cobb, P., Franke, M., Kaput, J. J., & McClain, K. (2004). Scaling up innovative practices in mathematics and science. Retrieved 2006, from <http://www.wcer.wisc.edu/NCISLA/publications/reports/NCISLAReport1.pdf>
- Clark, C. M., & Peterson, P. L. (1986). Teachers' thought processes. In M. C. Wittrock (Ed.), *Handbook of research on teaching* (pp. 255-296). New York: Macmillan.
- Cobb, P. (2001). Situated cognition: Origins. In N. Smelser & P. B. Baltes (Eds.), *International encyclopedia of the social and behavioral sciences* (Vol. 21, pp. 14126 – 14129). New York: Elsevier Science.
- Cobb, P., Confrey, J., diSessa, A. A., Lehrer, R., & Schauble, L. (2003). Design experiments in education research. *Educational Researcher*, 32(1), 9-13.
- Cobb, P., & McClain, K. (2001). An approach for supporting teachers' learning in social context. In F. L. Lin & T. Cooney (Eds.), *Making sense of mathematics teacher education* (pp. 207-232). Dordrecht, The Netherlands: Kluwer.
- Cobb, P., McClain, K., Lamberg, T., & Dean, C. (2003). Situating teachers' instructional practices in the institutional setting of the school and school district. *Educational Researcher*, 32(6), 13-24.
- Cobb, P., & Whitenack, J. (1996). A method for conducting longitudinal analyses of classroom videorecordings and transcript. *Educational Studies in Mathematics*, 30, 213-228.
- Dean, C. (2005). *An analysis of the emergence and concurrent learning of a professional teaching community*. Unpublished Dissertation, Vanderbilt University, Nashville, TN.
- Fennema, E., & Franke, M. (1992). Teacher's knowledge and its impact. In D. A. Grouws (Ed.), *Handbook on research on mathematics teaching and learning* (pp. 147-164). New York: Macmillan.
- Gamoran, A., Anderson, C. W., Quiroz, P. A., Secada, W. G., Williams, T., & Ashman, S. (2003). *Transforming teaching in math and science*. New York: Teachers College.
- Glaser, B. G., & Strauss, A. L. (1967). *The discovery of grounded theory: Strategies for qualitative research*. New York: Aldine.
- Lave, J. (1991). Situating learning in communities of practice. In L. B. Resnick, J. M. Levine & S. D. Teasley (Eds.), *Perspectives on socially shared cognition* (pp. 63-82). Washington, DC: American Psychological Association.
- Lave, J., & Wenger, E. (1991). *Situated learning: Legitimate peripheral participation*. New York: Cambridge University Press.
- Rogoff, B. (1997). Evaluating development in the process of participation: Theory, methods, and practice building on each other. In E. Amsel & A. Renninger (Eds.), *Change and development: Issues of theory, application, and method* (pp. 265-285). Hillsdale, NJ: Erlbaum.
- Stein, M. K., Silver, E. A., & Smith, M. S. (1998). Mathematics reform and teacher development: A community of practice perspective. In J. G. Greeno & S. V. Goldman (Eds.), *Thinking practices in mathematics and science learning* (pp. 17-52). Mahwah, NJ: Lawrence Erlbaum.
- Visnovska, J. (2009). *Supporting mathematics teachers' learning: Building on current instructional practices to achieve a professional development agenda*. Unpublished Dissertation, Vanderbilt University, Nashville, TN.
- Voigt, J. (1995). Thematic patterns of interaction and sociomathematical norms. In P. Cobb & H. Bauersfeld (Eds.), *Emergence of mathematical meaning: Interaction in classroom cultures* (pp. 163-201). Hillsdale, NJ: Erlbaum.
- Wenger, E. (1998). *Communities of practice*. Cambridge: Cambridge University.

The Researcher's Self in Research: Confronting Issues about Knowing and Understanding Others

Margaret Walshaw
Massey University
<m.a.walshaw@massey.ac.nz>

This paper engages general debates about the production of knowledge and, within that, more specific debates about the place of the researcher in the research process. There are two main objectives: one is a theoretical interest that involves examining the issue of subjectivity and how intersubjective negotiations take shape in research encounters. A second objective is to speculate from my own data what these understandings of the researcher's subjectivity tell us about the production of knowledge. It is also to understand the part that emotions and unconscious interference play in research.

This paper is about the researcher's self in the research process. It engages general debates about the production of knowledge and, within that, more specific debates about the place of one's subjectivity in research. The theme is not new of course. Putting the researcher into the research is considered a way to move beyond subscribing to a particularly modernist set of assumptions informing conceptions of what it means to know and what it means to know others. This is a set of assumptions to the effect that researchers are able to put themselves in another's (participant's) place and know his or her circumstances and interests in exactly the same way as she or he (participant) would know them. Disavowing those assumptions, some have chosen to write themselves into the research—to make their core researcher self visible and voiced.

Arguably, the new attention to the reflexive researcher makes the complex relation between researcher and researched a lot more transparent, but it signals a mere surface understanding about how subjectivity and intersubjective negotiations are actually produced during the research process. How can we explain the researcher's sense of self with regard to her complex and continually changing relation to her research participants? And, for that matter, how do desires and fantasies map into this sense of self? Questions such as these are about theory. They are also about methodological ways of proceeding with, and writing up research.

In this paper I am attempting to address these questions. In that attempt I have two main objectives. One is a theoretical interest that involves examining the issue of subjectivity and how intersubjective negotiations take shape in relation to data gathering and the construction of research stories. A second objective is to speculate what these understandings of the researcher's subjectivity tell us about the production of knowledge. Using data from my own research on girls in mathematics schooling, I place my 'self' under scrutiny. My purpose in doing this is to understand what it is that structures the research experience and the part that emotions and unconscious interference play in the performance of research.

Confronting Knowledge Production

Contemporary theorists now recognise the researcher's position of privilege in knowledge construction and have transformed it into "to a more self-conscious approach to authorship and audience" (Coffey, 2003, p. 321). Taking the lead from social science, scholars within mathematics education have suggested that it is not enough to recognise



the connection between the researcher and the questions, methods, and conclusions of any research, but that such a relationship should be avowed and should be made transparent (see Burton, 1995, 2003; Cabral & Baldino, 2004). In writing the reflective self and researcher voice into research texts, contemporary work has emphasised the negotiation, physicality, and crafting of personal relationships within the research encounter. As Coffey (2003) has noted, “the researcher-self has become a source of reflection and re-examination; to be written about, challenged and, in some instances celebrated” (p. 313).

In this line of thinking the tendency is to believe that the addition of a researcher layer to the narrative has the effect of countering the effects of power, privilege, and perspective in the research encounter. The understanding is that writing oneself into the research guards “against over-familiarity and the effects of context on the relationships that are formed in the field” (Coffey, 2003, p. 314). The important point to stress is that the researcher self in these accounts is most often expressed through a self who is a “fixed point of departure or arrival” (de Lauteris, 1984, p. 159). Thus, there is a certain level at which the researcher assumes a core true self.

A number of writers have raised theoretical and methodological issues to do with this concept of the self (e.g., Adkins, 2003; Brown & England, 2004, 2005; McLeod & Yates, 2006; Walkerdine, 1997; Walkerdine, Lucey, & Melody, 2003). Such writers take pains to emphasise that authoring one’s biography into the research account has the effect of romanticising the self. In their view there is no core self. They argue that the reflexive self is based on a foundational conception of the human subject, and hence much too cognitive in nature. Centring the self, they maintain, privileges and inscribes “a hierarchy of speaking positions” (Adkins, 2003, p. 332), with the effect that the core self tends to “move uncomfortably between the individual and the social or cultural without resolving, or satisfactorily exploring, the tensions inherent in this tussle” (Bibby, 2008, p. 39). In understanding this tussle, a number of factors become crucially important. The place of emotions is a case in point.

Understanding Subjectivity

Within recent scholarship, subjectivity is understood as historically and situationally produced in relation to a range of constantly changing processes. For scholars who draw upon this understanding (e.g., Keith & Pile, 1993; Pink, 2001), the notion of a ‘real’ identity or ‘true self’ is an illusion. Some have gone so far as arguing that the “self, like those of the research participants, is created as both fiction (in the Foucauldian sense) and fantasy” (Walkerdine et al., 2003, p. 180). It is an effect of the experience of interacting with social groups, cultures and institutions. Pink (2001) elaborates that the “self is never fully defined in any absolute way,...it is only in specific social interactions that the...identity of any individual comes in to being *in relation to* the negotiations that it undertakes with other individuals” (p. 21). As de Lauretis (1984) tells us, subjectivity:

is an ongoing construction...[T]hus it is produced not by external ideas, values or material causes, but by one’s personal, subjective engagement in the practices, discourses, and institutions that lend significance (value, meaning, affect) to the events of the world. (p. 159)

Explaining how this process operates for the researcher and researcher participants requires conceptualising how they live their subjectivity at the crossroads of a range of often competing discourses. In searching for a way of theorising this process, a number of scholars (e.g., Britzman, 1998; Ellsworth, 1997; Evans, 2000; Felman, 1987; Walkerdine, 1997; Walkerdine, Lucey, & Melody, 2003) have found that psychoanalytic theory, as

developed by theorists such as Lacan and Žižek, offers tools for understanding the self in relation to social, cultural and psychic processes.

Subjectivity, for Lacan, is not constituted by consciousness. Rather, conscious subjectivity is fraught and precarious. In the Lacanian assessment the researcher is one whose ontological status is constantly under threat precisely because consciousness is continually subverted by unconsciousness processes. In this view, subjectivity is not a simple given presumed essence that naturally unfolds, but, rather, is produced in an ongoing process and through a range of influences, practices, experiences and relations that include social, schooling and psychodynamic factors.

Methodologically, however, the Lacanian understanding of the self highlights the difficulty in producing a research account that tries to avoid problems concerning speaking for others, even when the researcher exercises reflexivity about her relation to the research participants. If, as Lacan suggests, the unconscious is the place where our sense of self is developed and the place where we find out the kinds of interpretations that we can make (Lacan, 1977a, 1977b), what does that mean for the subjectivity of the researcher and, for that matter, the truthfulness of her research report? Is it possible to tap into unconscious levels of awareness? How can we deal with these issues systematically?

Contextualising the Exploration

The discussion that follows provides a short analysis of an episode involving one student (Rachel) that arose in a project exploring the subjectivity of girls enrolled in a senior secondary school mathematics class (Walshaw, 1999). The girls in the project were students within a middle class co-educational grouping, all studying calculus for the first time. The student at the centre of this exploration was an accelerated student working with Year 12 students (16/17 years of age). Her class conversations were audiotaped, as were those of the teacher. I observed and took notes of the class for the duration of the calculus topic over a three week period. I also interviewed the student individually out of class time (see Walshaw, 2005). The dataset allowed me as researcher to capture the dynamic between gendered subjectivity and schooling, and to grasp a sense of the complexity surrounding gendered subjectivity in mathematics.

My objective in this paper is to capture my relationship with the data. In that attempt I have endeavoured to attend to her narrative of classroom experiences and affiliations, while paying attention to her constantly changing mathematical identity that moved forward, even as it folded back onto itself. The purpose is also to conduct research in a more interactive way, and to be accountable to a student's struggles to identify with mathematics. In doing that, I want to acknowledge Valero's (2004) argument that the practices of our research participants "intermesh with the practices of 'researchers' and the role of the researcher evidences their mutual constitutive character" (p. 50). In drawing attention to the epistemic implications of researching others, I considered my own emotional response to what I heard and saw. What fantasies and dreams do I conjure up about the work I do as researcher at this school with this student? How do I imagine the student in this research views me? In what ways do my feelings and reactions to her story influence my understanding of the data? Responding to those questions by highlighting the centrality of emotion in the research process will provide a counterpoint to current thinking about researcher reflexivity.

Working with Subjectivity

Understanding the Self-in-Conflict

Rachel is talking to me about what it is like to learn calculus for the first time in Mrs Southee's classroom. She had expressed an immediate, enthusiastic interest in participating in the research. Her liveliness contrasted with the 'sophistication' and 'poise' of the other girls in this class. She has an infectious laugh. "Giggly", is how Mrs Southee put it. Every mathematics lesson, she sat herself at the same desk in the middle bank of paired seating arrangements at the front of the classroom, alongside her friend Kate. As Year 10 students, the two of them were the only two 'extension' girls in this Year 12 class. I could not find myself completely in her giggly disposition, yet, as observer in this class, I could identify with being an 'exotic other' in her mathematics classroom. It is with regard to 'being different' in the mathematics classroom, in my role as observer, that I felt a powerful empathy with her story.

Rachel has just told me about her previous year's success with mathematics and how her achievements promoted her to this class. She explained:

I just seem to be good at doing exams. I've got a lot of friends—they know the stuff in class and I could sit there and it goes right over my head. But I get into an exam and I'm surprisingly clear-headed and a lot of people just get stressed out about it and I don't. It doesn't worry me because I think if I go in there and I don't know it then I don't know it. There's nothing I can do about it so there's no point in worrying. But I did, I worked quite hard last year. I spent ages going through the pink Mathematics Workbook and I was going over and over and over it. Trig [Trigonometry] was the worst bit. I couldn't do trig last year, and then like two days before the exam I was looking at it and it finally clicked. I spent about six hours just on trig that day and right at the end I just got it, and my parents were trying to make me go to bed and, no, I'm really understanding this. I'm not giving up now. I just did a lot of study. Always read and do examples. Working out answers, checking them and making sure, and if I don't get it I go back and try and figure it out and if I still don't get it I get my brother to have a look at it or I ask someone at school the next day.

As researcher listening to her story, I have an understanding of Rachel's mathematical 'experience' as fixed and immutable. She is able and she is motivated to learn. I have in Grosz's (1990) words, "branded" her, with "the marks of a particular social law and organization, and through a particular constellation of desires and pleasures" (p. 65). I wanted to hear about her good fortune, and her achievements. I had deliberately chosen her as my 'case' in order to question the assumptions typically held about girls in mathematics. I wanted to provide evidence that research founded on those assumptions, while it claimed to tell the truth about girls, in fact regulated them and overlooked other important aspects of subjectification, which cannot be contained within that discourse. An 'extension' student's story, I believed, would problematise normalised gender patterns in mathematics. Through her accomplishments she would reveal how it is possible to subvert the status quo and how to 'do gender in mathematics' differently.

As she began to tell me what mathematics is like for her this year, there was a sense that Rachel's self was a fabrication—changing moment by moment within the structures of the discursive situation in which she is located. I found it difficult to understand that the self that she was telling me about mathematics this year was the same self in the narrative a few moments previously.

...Mrs S, she tends to go right over my head and I don't tend to ask questions from her because last time I did that she tried to explain and it just went, well, I sort of understood half when I asked the question and by the time she'd finished I understood none of it! I don't know. But I don't have a very good relationship with her, because we've had a few arguments in the past. My auntie works in

the music block and she really likes Mrs S but, the guys, they know that I laugh really easily and they keep making me laugh in class and she just gets really frustrated with me because when I start laughing I can't stop and so she starts to get really angry at me. And apparently no one has ever heard her raise her voice before she met me. So it's a bit stressed there. I'm just trying very hard not to let the guys get to me now. Then I don't have to laugh.

Listening to her story I felt deeply dismayed. In my understanding, Rachel was a bright and capable student, caught up in practices and discourses that prevented her from succeeding in mathematics. I felt upset that she was the victim of surreptitious classroom practices that appeared to create a detrimental effect on her achievements and on her sense of self as a mathematical learner. I imagined in broaching the issue, she wanted me to know her pain; that she also wanted me to continue this line of conversation. But would pursuing this issue mean that I became caught up in situation that was beyond my powers or role to address? Who am I listening to her story? Who does she see me? I attempt to put my identity outside of myself into the image of myself. Yet I cannot determine that image. Feeling torn between a so-called 'impartial non-involved' researcher, on the one hand, and caring about her wellbeing in mathematics, on the other—I opted for further clarification as a way of dealing with an uncomfortable experience.

[MW: The boys who sit behind you?] Yea. Mostly, Blair and Richard, he's one of the bad ones as well.

[MW: The girls in the class don't stir you up?] No. Because the only one I really talk to is Kate. Blair—he just likes really to get me in trouble and he has done for the last three years and he'll just keep on doing it and there's nothing I can do so I just try not to sit in front of him. And hope that he doesn't sit in the row behind me ...

Rachel's story is full of contradictory mathematical experiences. It is told within the space that both of us share in interview and hence cannot escape the effects of her own desire to relate a coherent and compelling account that allows me, the listener, to attempt to understand. Thus at one level the story is a construction of a personal mathematical biography that develops, through a set of thematic clusters to do with success and peer and teacher-student conflict. And, at another level, the account registers disruptions and tensions that have the effect of undermining the coherent and cohesive story. In looking beyond the literal reading of what she said, her story evokes traces of other events and interpersonal relations that create a counter story to the one related to me at this moment in time. Together these two 'stories' open up important aspects of her subjectification as it relates to being a female mathematics student in this class.

Rachel sees herself as simultaneously able and struggling in mathematics. At another level, I see her as victimised. What needs to be emphasised here is that, as Lacan (1977b) and Žižek (1998) remind us, between the identifications she, and others, like me, have of her, there will always be a divide. There is always a trace of mis-recognition that arises from the difference between how one party perceives itself and how the other party perceives it. As a consequence, Lacan maintains, the very existence of the subject consists of closing the gap between images received within the Symbolic and Imaginary realms. Both Rachel and I, during the course of the interview, worked independently at closing the gap. As Žižek (1989) has put it: The subject "put(s) his identity outside himself, so to speak, into the image of his double" (p. 104).

Conclusion

Research is a 'performance'. It has a lot more to do with fictions and fantasies than we might suspect. In working towards a theoretical understanding of the researcher's self,

issues of emotion and unconscious interference have come under scrutiny for the part they play in the subjectivity of the researcher, the researched and in the space they both share. It has been argued that the performance of self as researcher is about a discursive positioning that is constantly changing, in relation to the discourses and practices researchers find themselves within, and in relation to their intersubjective relations with the researched. 'Intersubjective relations' are not meant to convey simply those relations operating at the conscious and accessible level of awareness. They are intended to include the emotions and unconscious processes. In my formulation of researcher self, fictions and fantasies play a central part.

If it is axiomatic that non-rational connections get caught up in the research account, then where does this leave current accounts of reflexivity or the authorial self? I would suggest that accounts that write the researcher into the process or that practice reflexively speaking for others, promise more than they can deliver. An alternative that significantly enhances the practice of reflexivity and the practice of writing oneself into the research is to begin with tools taken from psychoanalysis and to acknowledge the intrusion of the self in every aspect of our research endeavours. In describing an episode taken from a specific research encounter, I have provided a first steps approach at what this understanding might mean for methodology—how we might begin to confront, rather than slide over, the delicate issue of emotion within the research process. The approach offers a way to understand processes within the research encounter that give form to difficult, contradictory or conflicting experiences from the past, the present and even those anticipated in the future.

Subjectivity is the cornerstone of the research encounter. Centralising subjectivity in the research process means just that. It means that the researcher can never hope to be detached. Talking about researcher bias is not a particularly fruitful exercise; neither is the practice of asserting one's own subjectivity through a narrative layer. Writing oneself into the research has the effect of masking the way in which one's subjectivity and one's voice is produced (Adkins, 2003; Skeggs, 2003). The reality is that the subjectivity of the researcher is always implicated in the complex research encounter precisely because the researcher self is always performed in and for others. Methodologically, the researcher can never truly know what she is seeking and why, because "the fictions of subject positions are not linked by rational connections, but by fantasies, by defences which prevent one position from spilling into another" (Walkerline, Lucey, & Melody, 2003, p. 180). Our research accounts need to acknowledge that research is more than the elements of trust, doubt, humility, and power. It is about fictions and fantasies and the complicity and fragility of these in relation to others.

References

- Adkins, L. (2003). Reflexivity and the politics of qualitative research. In T. May (Ed.), *Qualitative research in action* (pp. 332-348). London: SAGE.
- Bibby, T. (2008). The experience of learning in classrooms: Moving beyond Vygotsky. In T. Brown (Ed.), *The psychology of mathematics education: A psychoanalytic displacement* (pp. 37-60). Rotterdam: Sense Publishers.
- Britzman, D. (1998). *Lost subjects, contested objects: Toward a psychoanalytic inquiry of learning*. New York: State University of New York Press.
- Brown, T., & England, J. (2004). Revisiting emancipatory teacher research: A psychoanalytic perspective. *British Journal of Sociology of Education*, 25(1), 67-79.
- Brown, T., & England, J. (2005). Identity, narrative and practitioner research: A Lacanian perspective. *Discourse: Studies in the cultural politics of education*, 26(4), 443-458.

- Burton, L. (1995). Moving towards a feminist epistemology of mathematics. *Educational Studies in Mathematics*, 28, 275-291.
- Burton, L. (2003). Methodology and methods in mathematics education research: Where is 'the why'? In S. Goodchild & L. English (Eds.), *Researching mathematics classrooms: A critical examination of methodology* (pp. 1-10) (Westport, CT, Praeger).
- Cabral, T., & Baldino, R. (2004). Formal inclusion and real diversity through mathematics in a new public university. *Proceedings of the 28th annual conference of the International Group for the Psychology of Mathematics Education* (Vol. 2, pp. 175-182). Bergen: PME.
- Coffey, A. (2003). Ethnography and self: Reflections and representations. In T. May (Ed.), *Qualitative research in action* (pp. 313-331). London: SAGE.
- de Lauretis, T. (1984). *Alice doesn't: Feminism, semiotics, cinema*. London: Routledge.
- Ellsworth, E. (1997). *Teaching positions*. New York: Teachers College Press.
- Evans, J. (2000). *Adults' mathematical thinking and emotions: A study of numerate practices*. London: Routledge Falmer.
- Felman, S. (1987). *Jacques Lacan and the adventure into insight: Psychoanalysis in contemporary culture*. Cambridge, MA: Harvard University Press.
- Grosz, E. (1990). *Jacques Lacan: A feminist introduction*. London: Routledge.
- Keith, M., & Pile, S. (1993). *Place and the politics of identity*. London: Routledge.
- Lacan, J. (1977a). *Ecrits: A selection*. London: Tavistock.
- Lacan, J. (1977b). *The four fundamental concepts of psycho-analysis*. London: The Hogarth Press.
- McLeod, J., & Yates, L. (2006). *Making modern lives: Subjectivity, schooling, and social change*. New York: State University of New York Press.
- Pink, S. (2001). *Doing visual ethnography*. London: Sage.
- Pitt, A. (1998). Qualifying resistance: Some comments in methodological dilemmas. *Qualitative Studies in Education*, 11(4), 535-553.
- Skeggs, B. (2003). Techniques for telling the reflexive self. In T. May (Ed.), *Qualitative research in action* (pp. 349-374). London: SAGE.
- Valero, P. (2004). Postmodernism as an attitude of critique to dominant mathematics education research. In M. Walshaw (Ed.), *Mathematics education within the postmodern* (pp. 35-54). Greenwich, CT: Information Age.
- Walkerdine, V. (1997). Redefining the subject in situated cognition theory. In D. Kirshner, & J. A. Whitson (Eds.), *Situated cognition: Social, semiotic, and psychological perspectives* (pp. 57-70). Mahwah, NJ: Lawrence Erlbaum Associates.
- Walkerdine, V., Lucey, H., & Melody, J. (2003). Subjectivity and qualitative method. In T. May (Ed.), *Qualitative research in action* (pp. 179-196). London: SAGE.
- Walshaw, M. (1999). *Paradox, Partiality and Promise: A politics for girls in school mathematics*. Unpublished doctoral dissertation, Massey University, New Zealand.
- Walshaw, M. (2005). Getting political and unravelling layers of gendered mathematical identifications. *Cambridge Journal of Education, Special Issue, Provocations to/in Mathematics Education*, 35(1), 19-34.
- Žižek, S. (1989). *The sublime object of ideology*. London: Verso.
- Žižek, S. (Ed.) (1998). *Cogito and the unconscious*. Durham: Duke University Press.

Indigenous Children's Ability to Pattern as They Enter Kindergarten/Pre-prep Settings: An Exploratory Study

Elizabeth Warren

Australian Catholic University
<Elizabeth.Warren@acu.edu.au>

Jodie Miller

Australian Catholic University
<Jodie.Miller@acu.edu.au>

The gap between young Indigenous and non-Indigenous children's capability within mathematics is widely acknowledged. This gap is conjectured to exist at all levels of schooling, including pre-school, and widens as children mature. Most of these findings are based on research relating to children's understanding of number and space. Little is known about what knowledge Indigenous students bring to early years settings with regard to patterning, an area that is widely acknowledged as fundamental to the development of concepts, process and knowledge of mathematics. One on one interviews were conducted with 35 Indigenous children (average age 4 years and 4 months) as they entered kindergarten. The results indicate that these children do enter these settings with some intuitive understanding of repeating pattern, and that this knowledge is at odds with the hypothesised learning trajectory (Samara & Clements, 2009) for repeating patterns.

With regard to young Indigenous children, research indicates that little is known about their numeracy capabilities as they enter kindergarten/Pre-prep settings. The results of a large Australian study, Project Good Start, indicated that children from low SES backgrounds perform at a lower level than middle class students on school entry (Thomson, Rowe, Underwood, & Peck, 2005). This study also evidenced the wide gap between the numeracy achievement of non-Indigenous students and Indigenous students as they entered pre-school settings. It is acknowledged in the study that when considering this finding it must be remembered there were only 48 Indigenous children in a sample of 1615 children, and these children were scattered across a range of sites. These findings were also based on the use of 'I Can do Maths Level A' (Doig & de Lemos, 2000), a test developed for 4 to 8 year olds and focussing on the content areas of number, space and measurement. There were no questions relating to ascertaining young children's ability to pattern.

Patterning and the recognition of pattern is fundamental to the development of concepts, process and knowledge of mathematics (Cooper & Warren, 2008; Mulligan & Mitchelmore, 2009; Papic, 2007). The power of mathematics lies in the relations and transformations which give rise to patterns and generalisations. Abstracting patterns is the basis of structural knowledge, the goal of mathematics learning in the research literature (Jonassen, Beissner & Yacci, 1993; Sfard, 1991). It is important to begin the exploration of patterns within the early years setting as it gives children a firmer understanding of number concepts. Papic (2007) also found that students who engaged in patterning activities in pre-school settings performed better in mathematics in the later years.

Patterning activities that children commonly experience in the early years involve repeating patterns and growing patterns. Repeating patterns are patterns that have a discernable unit that repeats over and over again. Children explore simple repeating using shapes, colours, movement, feel and sound. Typically young children are asked to copy and continue these patterns, identify the repeating part, and find missing elements; a focus on single variational thinking where the variation occurs within the pattern itself. The thinking that is engendered in these activities tends to focus on the patterns themselves with little consideration given to their structure or the mathematics that is embedded in the pattern (Liljedahl, 2004). The iteration of an identical unit (either numeric or concrete)



occurs in other areas of mathematics, multiplicative thinking and measuring. Multiplication requires the repetition of the same numerical unit (repeated addition) and measurement initially entails the iteration of the same nonstandard unit and later the same standard unit. Thus exploring repeating patterns can be seen as the precursor to the development of key understandings that are important to the development of mathematical thinking.

An ontology of children’s learning that is currently dominating the early years literature is the learning trajectory. From this perspective, learning consists of a series of “natural” developmental progressions identified in empirically-based models of children’s thinking and learning (Clements, 2007). In conjunction with viewing learning as a progression through development hierarchical levels, the learning trajectory sees teaching as the implementation of “a set of instructional tasks designed to engender these mental processes” (Clements & Samara, 2004, p. 83). From this perspective, the act of teaching is secondary to the act of learning. The resultant curriculum consists of diagnostics tests, learning hierarchies and purposely-selected instructional tasks. Fundamental to this perspective is (a) the existence of a large repertoire of empirically-based research evidencing the development of particular concepts, such as number, number sense, and counting, and (b) conducting extensive field tests trialling various instructional.

The theoretical perspective that underpins the learning trajectory is the notion of hierarchic interactionism (Sarama & Clements, 2009). This theory consists of three main tenets, namely, developmental progressions, domain specific progression, and hierarchic development. In summary these are: ‘Most knowledge is acquired along developmental levels of thinking’ (Sarama & Clements, 2009, p. 20). These developmental progressions seem to be more auspicious within particular mathematical domains or topics. Within this framework, while levels of thinking are often believed to be coherent characterised by increased sophistication, the learning process is more often gradual and incremental. While the movement between levels can often range from slow to rapid, it is believed that a critical mass at one level must be constructed before movement to the subsequent level effectively occurs. The hypothesised learning trajectory for patterning in the early years is:

Table 1
Hypothesised Learning Trajectory for Repeating Patterns

Age	Developmental progressions	Action with objects
3	Pattern recogniser	Has the capacity to recognise patterns, can operate on perceptual input and note regularities.
4	Pattern fixer – fills in the missing elements in an ababab pattern Pattern duplicator AB – duplicates an ababab pattern Pattern extender AB – extends an ababab pattern Pattern duplicator – duplicates patterns without the need for model support	Finds the missing element by continuing to produce the verbal sequence stored in the phonetic ‘buffer’ (or, visually through, the visuospatial sketch pad). Can copy the pattern as long as the perceptual support is available for checking the duplication. Can extend the pattern and has less need for constant perceptual support when doing so. Duplicates longer patterns and patterns with more complex core units.

This hypothesised trajectory was based on previous research findings and pilot studies in four classrooms (Samara & Clements, 2009). While the literature acknowledges the learning trajectory’s limitations in terms of the types of patterning experiences it presents,

little is known about its applicability to children from culturally diverse backgrounds such as young Indigenous children.

This research project, undertaken by three researchers in a Brisbane Indigenous kindergarten (Warren, deVries, & Thomas, 2009), looked at the mathematical experiences of kindergarten/Pre-prep children (average age 4 years and 4 months). The sample comprised two teachers and their 35 Indigenous children. The overarching objective was to develop culturally appropriate best practice/research grounded teacher and parent materials to support the transition of Indigenous children from home to school with regard to their numeracy learning. Thus the focus of this paper is to explore the intuitive understanding of repeating patterns that young Indigenous children bring to the kindergarten/Pre-prep setting.

Method

Participants







The children participating in this study came from two purposely selected Indigenous kindergarten settings in Metropolitan Brisbane. Both settings catered for young Indigenous children, and were recognised as settings where the teachers were willing to engage in professional dialogue with regard to student learning. The children came from a range of different ethnicities with the most predominant being Indigenous Australian (76.1%). The remaining children were predominantly Vietnamese. This paper reports on the Indigenous children at the kindergartens (n=35). Thus sample comprised 35 children, 18 male and 17 female, with an average age of 4 years and 4 months. One centre had two Pre-prep classes while the other had one. Prior to the administration of the test, the participants had not been exposed to exploring any types of patterns in these kindergarten settings. In Queensland, in the year prior to Pre-prep, students are either at home or in day care, or experiencing a mixture of both. While we cannot categorically proclaim that they had never experienced any type of patterning activities before the administration of the pre test, we can conjecture that it is highly unlikely.

Data Gathering Techniques and Procedures

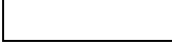
All children participated in a one on one interview conducted by the researchers. The interview was designed by the researchers and focused on the concept of repeating patterns. The aim of the interview was to identify the preconceived knowledge about repeating patterns that children brought to the kindergarten/Pre-prep setting. The interview consisted of three tasks. Each pattern focused on ascertaining young children's ability to copy, continue, complete and create repeating patterns. The first Task asked the student to copy, continue and complete an ababababa pattern, and Task 2 they were asked to copy, continue and complete an aabbaabbaabb pattern. In Task 3 they were given coloured paddle pop sticks and asked to create their own repeating pattern. Each part of each task was accompanied by a card with a picture of the pattern on it. Children were also supplied with the appropriate concrete materials needed for them to successfully complete the tasks. For example, for part 1 of Task 1 the children were instructed to copy the pattern using concrete lighthouses and ladybugs, and to place their pattern in the rectangle drawn below the picture of the pattern. Table 2 presents the cards used for each task together with the questions asked.

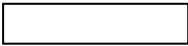
Table 2

Cards Used for Each Task Together with the Interview Questions

Task	Cards	Interview questions
Task 1 – part 1		Copy the pattern. Using your shapes, make the same pattern in the box.
Task 1 –part 2		Continue the pattern along the line. (Gesture along the line)
Task 1 – part 3		Complete the pattern. What is missing?
Task 2 – part 1		Copy the pattern. Using your shapes, make the same pattern in the box.
Task 2 – part 2		Continue the pattern along the line. (Gesture along the line)
Task 2 – part 3		Complete the pattern. What is missing?
Task 3		Using the paddle pop sticks create your own repeating pattern.

The interview was approximately 15 minutes in length. The terms copy, continue, complete, create were not explained to the children as it was necessary to identify if they understood the language used for describing patterns as well as ascertaining their ability to complete the tasks. Data was recorded on an answer sheet by the interviewer. Children’s responses were marked as either correct or incorrect. Task 1 Part 2 and Task 2 Part 2 were allocated a possible score of 2, 1 for continuing the pattern in either direction or 2 for continuing the pattern in both directions. All other tasks were allocated a score of 1. Children used a variety of different strategies as they completed the tasks. The following sections describe these strategies.

Copying the pattern. Children used three different strategies when copying the pattern. One group placed each shape on top of the pictures on the card and then pulled down each shape one by one so that they were in the box (Cover and move). Another group first copied all the shapes that were the same and then copied the remaining shapes (Copy part part). The third group copied the shapes in order from left to right (Copy left to right). Figure 1 illustrates each strategy.

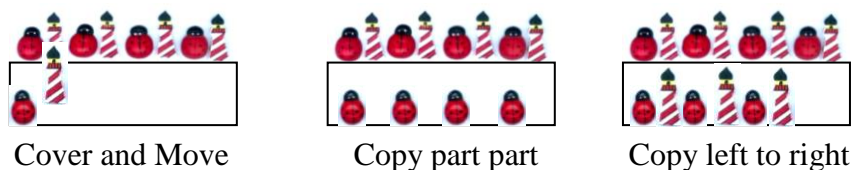

Figure 1. Copying strategies.

Continuing the pattern. When continuing the pattern, there were three different strategies that the student used to complete this task. The children either continued the pattern to the right only, continued the pattern to the left only or continued the pattern both ways. When continuing to the left, some children placed down a shape to the far left and then built up the pattern to the existing pattern.

All of these strategies were recorded and coded. The data was entered into SPSS for analyses.

Results

All 35 children completed the patterning interview. The maximum score for the patterning interview was nine. The mean score was 2.66 with a standard deviation of 1.8. The highest score from the children was 8 with the lowest being 0. Table 3 presents the percentage of children who successfully answered each task, together with the number of children in brackets. It should be noted that for the continuing patterns parts of the tests children were considered correct if they continued the pattern in either direction or both directions.

Table 3
Frequency and Percentage of Children who Successfully Completed Each Task

Task		Percentage Correct
Task 1	Part 1: Copy ababab	26 (74.3%)
	Part 2: Continue ababab	8 (14.3%)
	Part 3: Complete	15 (42.9%)
Task 2:	Part 1: Copy aabbaabb	26 (74.3%)
	Part 2: Continue aabbaabb	4 (11.4%)
	Part 3: Complete	4 (11.4%)
Task 3	Create	6 (17.1%)

For Task 3, creating a repeating pattern using coloured paddle pop sticks, all 6 children created abababab patterns using two different strategies. The first relied on colour to differentiate the elements of the pattern, for example, blue red blue red blue red. The second utilised orientation of the sticks to differentiate the elements, for example, using the same coloured paddle pop sticks but placing one element on the vertical and placing the other element on the oblique.

Students were then categorised according to the strategy they used to copy the pattern. Table 4 summarises the frequency and percentage of students who were allocated to each category and their success at copying the pattern

Table 4
Frequency and Percentage of Students who used Different Copy Strategies and who Successfully Copied the Pattern (n=35)

Pattern	Strategy	Used the strategy	Successfully copied pattern
ababababab	Cover and move	3 (8.6%)	2 (5.7%)
	Copy part part	11 (31.4%)	4 (11.4%)
	Copy left to right	21 (60.0%)	20 (60.0%)
aabbaabbaabb	Copy and move	5 (14.3%)	5 (13.0%)
	Copy part part	17 (48.6%)	8 (14.2%)
	Copy left to right	13 (37.1%)	13 (37.1%)

As indicated in the above table children who used the copy part part strategy were less successful at copying the pattern than children who used the other two strategies. The next section discusses how students who used different strategy when copying the pattern performed on the different parts of each task. After copying the pattern, children were asked to continue the same pattern, and then complete the pattern (see Table 2). Table 5 presents the results of this section of the data analysis.

Table 5
Frequency of Successful Responses for the Continue and Complete Parts of the Tasks

Strategy	abababab Pattern		Strategy	aabbaabbaabb Pattern	
	Continue	Complete		Continue	Complete
Copy & move (3)	1	0	Copy & move (5)	0	0
Copy part part (11)	1	2	Copy part part (17)	1	1
Copy left to right (21)	5	13	Copy left to right (13)	2	3

The results indicate that children who used the strategy of copying from left to right were more successful at both continuing the pattern and completing the pattern. In addition, the 6 children who successfully created a pattern (see Table 2), 4 of these used the strategy copy left to right when copying the patterns.

In summary, children found it easier to copy patterns than they did to continue and complete patterns. They also found it easier to complete an ababab pattern than they did to continue the pattern. Duplicating a more complex pattern (aabbaabbaabb) proved less difficult than continuing and completing a less complex pattern. Finally, children who use the strategy of copying a pattern from left to right were more successful than other children on all parts of the test, including their ability to create their own repeating pattern.

Discussion and Conclusions

This paper begins to document the thinking about repeating patterns that these young Indigenous children brought to the kindergarten/Pre-prep setting. It also provides further insights into the conjectured learning trajectory (Clements, 2007). Three main conclusions are drawn from the data.

First, as can be seen from the results (see Table 1) most of the children had already begun their ‘patterning journey’ as they entered kindergarten. The results also indicated that the exact order presented for the learning trajectory is somewhat at odds with what these Indigenous students could do. For example, many Indigenous children found duplicating a pattern easier than ‘fixing’ the pattern. They also found duplicating a more complex pattern easier than ‘fixing’ and ‘extending’ easier patterns. Does this mean that the learning trajectory for patterning is different for Indigenous children or should we as researchers be more flexible in the ‘hierarchical steps’ that we propose children pass through as they begin to learn new concepts?

The literature presents a second perspective with regard to the ontology of student learning: the learning-teaching trajectory (e.g., Van den Heuvel-Panhuizen, 2008). While both perspectives have many commonalities, the main differences lie in their emphasis on the act of teaching in the learning process, and the prescriptiveness of the resultant curriculum. In contrast to the learning trajectory, the learning-teaching trajectory has three interwoven meanings, each of equal importance. These are: a learning trajectory that gives an overview of the learning process of students; a teaching trajectory that describes how teaching can most effectively link up with and stimulate the learning process; and finally, a

subject matter outline, indicating which core elements of the mathematical curriculum should be taught (Van den Heuvel-Panhuizen, 2008). It provides a “mental education map” which can help teachers make didactical decisions as they interact with students’ learning and instructional tasks. It allows for a degree of flexibility in the learning sequence, and acknowledges that quality teaching a key dimension of effective learning. This ontology may provide a theoretical perspective that better aligns with our project.

Second, the findings indicate that how a child copies a pattern provides insights into their ability to see the structure of the pattern as a whole, rather than seeing the pattern consisting of two parts, the lighthouses and the ladybirds. The most successful copying strategy, copying the elements in succession from left to right was also accompanied by a verbal or nonverbal ‘chant’, ladybird lighthouse ladybird lighthouse ladybird lighthouse, reading the grain of the pattern (Warren, 2005). We are suggesting that these actions in unison assisted children to continue the pattern. They were beginning to ‘see’ the structure of the pattern. But seeing structure entails more than this, as many of these children had difficulties continuing the pattern to the left. Continuing to the left required them to start with a lighthouse instead of a ladybird. A common mistake that many children made was to double up on the ladybirds as they continued the pattern to the left, a strategy we termed as mirroring the pattern. We hypothesise that ‘seeing structure’ of repeating patterns requires the identification of two components, identifying the rhythm of the pattern, and breaking this rhythm into the repeating component (Warren, 2005).

Third, young Indigenous students do enter kindergarten/Pre-prep with some understanding of patterning. In fact our past research with prep aged children indicates that there is no significant difference between Indigenous children’s ability to pattern as compared with non-Indigenous children (Warren & deVries, 2009). The results of this pilot study with three groups of children, namely, Indigenous students (n = 14, average age = 4 years 11 months), Other Culture students (n = 11, average age = 4 years 11 months) and Caucasian students (n = 23, average age = 5 years) also indicated that the main significant difference between these three groups of students as they began school was their understanding of number, and not patterning nor mathematical language, and with appropriate teaching actions it was possible to close this gap. It must be remembered that statements such as ‘low-SES children show less proficient mathematical performance than do their middle-SES peers, particularly when meta-cognition is required, but do not lack basic concepts and skills’ (Ginsburg, Lee & Boyd, 2008, p5.) are based on the tests results after these students have participated in school for some years. Ginsburg, Lee and Boyd (2008) point out that these low SES children are also exposed to a pervasive risk factor as they proceed through school, namely, low school quality. Many teachers in these schools fail to provide opportunities for mathematical learning (Ginsburg, Lee & Boyd, 2008).

This paper begins to share some of our results from our project in two Indigenous kindergarten settings. Due to the space limitations we decided not to share (a) the types of activities that were introduced into the settings (b) the teacher actions that began to build young Indigenous children’s capability to pattern, nor (c) the progress that they children made in their understanding. Briefly, the children’s ability to pattern significantly improved over the year and the early childhood teachers understanding of the how they construct themselves as educators engaged in both a play-based pedagogy and mathematics as a curriculum discipline also changed (Thomas, Warren, & deVries, 2010).

References

- Clements, D. (2007). Curriculum research: Towards a framework for research based curriculum. *Journal for Research in Mathematics Education*, 30, 35-70.
- Clements, D. & Samara, J. (2004). Learning trajectories in mathematics education. *Mathematical Thinking and Learning*, 6, 81-89.
- Cooper, T. J., & Warren, E. (2008). The effect of different representations on Year 3 to 5 students' ability to generalise. *Zentralblatt für Didaktik der Mathematik*, 40(1), 23-38.
- Doig, B., & de Lemos, M. (2000). *I can do maths*. Melbourne: ACER Press.
- Ginsburg, H., Lee, J., & Boyd, J. (2008). Mathematics Education for young children: What it is and how it to promote it. *Social Policy Report*, 12(1), 3-23.
- Jonassen, D. H., Beissner, K., & Yacci, M. (1993). Structural knowledge: Techniques for representing, conveying, and acquiring structural knowledge. Hillsdale, NJ: Lawrence Erlbaum Associates, Inc.
- Liljedahl, P. (2004). Repeating pattern or number pattern: The distinction is blurred. *Focus on Learning Problems in Mathematics*, 26(3), 24-42.
- Mulligan, J.T. & Mitchelmore, M.C. (2009). Awareness of pattern and structure in early mathematical development. *Mathematics Education Research Journal*, 21(2), 33-49.
- Papic, M (2007). Promoting repeating patterns with young children - More than just alternating colours. *Australian Primary Mathematics Classroom*, 12(3), 8-13.
- Sarama, J., & Clements, D.H. (2009). *Early childhood mathematics education research: learning trajectories for young children*. London: Routledge.
- Sfard, A. (1991). On the dual nature of mathematical conceptions: Reflections on processes and objects as different sides of the same coin. *Educational Studies in Mathematics*, 22, 1-36.
- Thomas, L., Warren, E., & deVries, E. (2010). *Teaching mathematics and play based learning in an Indigenous early childhood setting: Early childhood teachers' perspectives*. Playing with Mathematics: Play in Early Childhood as a Context for Mathematical Learning. Symposium presented at the 33rd Conference of the Mathematics Education Research Group of Australasia.
- Thomson, S., Rowe, K., Underwood, C., & Peck, R. (2005). *Numeracy in the early years*. Project Good Start. Camberwell, Victoria, Australian: Australian Council for Educational Research.
- Van den Heuvel-Panhuizen, Marja (Retrieved, 7th May 2008). *Realistic Mathematics Education as work in progress*. <http://www.fi.uu.nl/publicaties/literatuur/4966.pdf>. Retrieved May 7, 2008.
- Warren E., (2005). Patterns supporting the development of early algebraic thinking. In P. Clarkson, A. Downton, D. Gronn, M. Horne, A. McDonough, R. Pierce, & A. Roche (Eds.), *Building Connections: Research, Theory and Practice*. (Proceedings of the 28th Conference of Mathematics Education Research Group of Australasia, 2, pp. 759-766). Sydney: MERGA.
- Warren, E., & deVries, E. (2009). Young Australian Indigenous students' engagement with numeracy: Actions that assist to bridge the gap. *Australian Journal of Education*, 53(2). 159-175.
- Warren, E., deVries, E., & Thomas, L. (2009). *Early numeracy in Pre-prep settings: Final report*. ACU

Student Change Associated with Professional Learning in Mathematics

Jane Watson

University of Tasmania
<jane.watson@utas.edu.au>

Kim Beswick

University of Tasmania
<kim.beswick@utas.edu.au>

Natalie Brown

University of Tasmania
<natalie.brown@utas.edu.au>

Rosemary Callingham

University of Tasmania
<rosemary.callingham@utas.edu.au>

Suzie Wright

University of Tasmania
<suzie.wright@utas.edu.au>

This paper reports partial outcomes from a three-year project that provided professional learning opportunities in mathematics for middle school teachers in rural schools in Tasmania. The educational environment for the study was one of significant system transition. Student change is reported here and was measured with survey instruments reflecting the basic elements of numeracy considered essential to students' development of critical quantitative thinking and preparation for study of further mathematics. Student improvement was significant across grades in the project.

Hiebert and Grouws (2007) take the phrase “opportunity to learn” as the foundation for their suggestions for effective teaching likely to influence student learning. While acknowledging the influence of the curriculum and subject matter, they go on to explore specific connections related to teaching for skill efficiency and for conceptual understanding. In terms of teaching for skill efficiency they identify the following teacher-centered features: “teaching that facilitates skill efficiency is rapidly paced, includes teacher modelling with many teacher-directed product-type questions, and displays a smooth transition from demonstration to substantial amounts of error free practice” (p. 382). In relation to teaching for conceptual understanding, which they define as the process of creating “mental connections among mathematical facts, procedures and ideas” (p. 382), Hiebert and Grouws suggest two key features. The first is that teachers and students attend explicitly to concepts, in a public way. The second is that students struggle to make sense of important mathematics that is within reach containing key ideas that are comprehensible but not yet fully formed. These key features for skill efficiency and conceptual understanding, together with implications for teacher professional learning, are reflected in the teaching and learning goals of the project reported in this paper.

Sowder (2007), in her extensive review of the mathematical education and development of teachers advocated goals of ongoing professional learning reflecting Shulman's (1987) types of teacher knowledge. Specifically, her summary of elements of successful professional development includes the importance of the following components:

determining the purpose of a ... program, the role of teachers in deciding on foci, ... the need to have support from other constituencies ... to undertake changes in instruction, ... collaborative problem solving, ... continuity over time, ... modelling the type of instruction expected, and ... assessment that provides teachers with feedback ... (p. 171)

The work of Hawley and Valli (1999) reflected that of Sowder (2007), but with added emphases on teachers having initial and continuing input to the professional learning



program and the opportunity to work collaboratively on problem solving. These elements further informed the project reported here.

This paper reports on one aspect of a three-year professional learning program for teachers, supported with funding and in-kind contributions from the state government and Catholic school systems. Implementation of the program “Mathematics in an Australian Reform-Based Learning Environment” (MARBLE), in 2005, coincided with the introduction of the Essential Learnings Framework (Department of Education, Tasmania (DoET), 2002, 2003). In 2006 however, amid controversy over the implementation of the Essential Learnings, a new curriculum, “The Tasmanian Curriculum”, was announced to “make it [curriculum] easier to understand, and more manageable for teachers and principals” (DoET, 2007, para 1).

Using a measurement instrument developed based on the seven types of teacher knowledge of Shulman (1987) as formalised by Watson (2001), teachers were surveyed at the beginning and end of the program, and students in their classes were surveyed in each of the three years. The focus of this paper is on the change in student performance as a result of the teachers’ professional learning program and therefore specific features of the teacher profiles and interview and students’ beliefs and attitudes are not discussed here.

Methodology

Sample

The teachers in this study were working in nine schools that were chosen by the two participating education systems. The schools were in two rural clusters in different geographical regions of the state, divided five and four. Eight were government schools and one was a Catholic school. Initially there were 42 teachers in the project teaching Grades 5 to 8. In the second year of the project there was a total of 47 teacher participants, of whom only 23 had participated in the previous year. In the final year of the project, there were 54 teacher participants, of whom 20 were new to the project. On completion only 19 teachers had participated throughout the 3 years. The numbers of students in the project surveyed each year are shown in Table 1. Students completed a two-part survey, Part B of which is discussed in this paper. Students were surveyed either once, twice or three times depending on the grade they were in at the beginning of the project.

Table 1

Student Sample Sizes for Part B of the Student Survey (numbers in parenthesis indicate students surveyed two or three times)

PART B	2005	2006	2007
Grade 4	23 (5 ^a) (15 ^b)	17 (13 ^a)	20
Grade 5	186 (39 ^a) (116 ^b)	180 (142 ^a) (14 ^b)	212 (13 ^a)
Grade 6	222 (70 ^a) (99 ^b)	187 (59 ^a) (115 ^b)	227 (145 ^a) (14 ^b)
Grade 7	181 (56 ^a) (53 ^b)	196 (91 ^a) (90 ^b)	203 (46 ^a) (116 ^b)
Grade 8	130	143 (70 ^a) (53 ^b)	162 (52 ^a) (90 ^b)
Grade 9	3		110 (45 ^a) (53 ^b)

^a Students surveyed twice. ^b Students surveyed three times.

Instruments

Part B of the survey was written to reflect five foundation concepts of middle school mathematics identified in the literature: Number Sense, Proportional Reasoning, Measurement, Uncertainty, and Relationships. Of the 38 distinct items in the first year survey, there was overlap in terms of items reflecting these concepts. The items, and rubrics, had various sources including Watson and Callingham (2003), Callingham and Griffin (2000) and the Department of Education, Community and Cultural Development (1997). Student outcomes for one of the problems based on fractional parts of a nebulous whole were discussed in Watson, Beswick, and Brown (2006). The second student survey contained 34 distinct items in Part B, 8 items in common with the initial survey, again across the five foundation concepts. Student outcome levels from the initial surveys and the nature of the intervention with teachers as a part of the professional learning program in 2006 influenced the nature of items in the second survey. Again, items were scored using rubrics as for the initial survey. The third student survey contained 40 distinct items designed to measure mathematical performance, covering the range of mathematical concepts covered earlier. All items were taken from one or other of the preceding two surveys with seven being common to both. They were scored using the same rubrics as in the preceding two years. An example of one of the common items relating to proportional reasoning and the rubric used to assess it are presented in Table 2.

Table 2

Example of a Proportional Reasoning Item and the Rubric for Scoring

A table can seat six people: two (2) on each side and one (1) on each end.



When tables are put together, more people can be seated (as shown here).

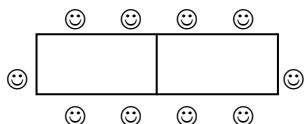

Write a rule for the number of people (p) that can be seated at a certain number of tables (t).

Code	Global Category	Example
3	Correct rule	$4(p)$ per (t) then add 2 on the ends Four for each table then add 2 If there were 6 tables, times it by 4 then add 2 For 10 table, $10 \times 4 + 2$
2	Partial explanation of the rule	When you join tables together you can only have 2 at the ends all the time.
1	Inappropriate explanation of the rule	People can be seated 6 to a table.
0	No explanation	

Professional Learning

The MARBLE professional learning project was devised in the context of Tasmania's Essential Learnings (DoET, 2003) to assist teachers in providing middle school students with the mathematical foundation necessary for the quantitative literacy needs of today's

society (Steen, 2001), as well as for the further study of mathematics and contribution to innovation in Australia (Committee for the Review of Teaching and Teacher Education, 2003). The underlying model is shown in Figure 1.

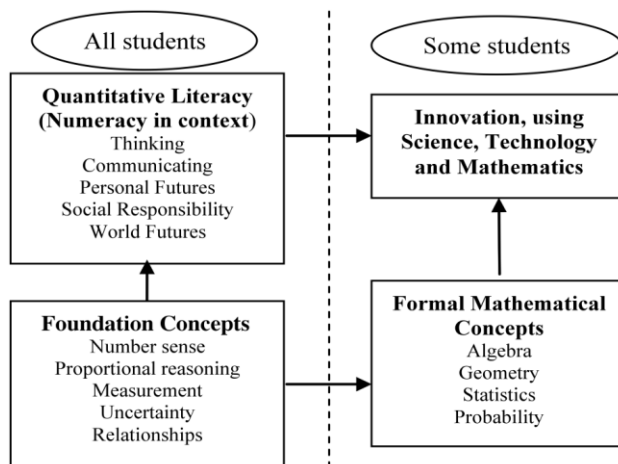

Figure 1. MARBLE framework for mathematical learning.

The features of successful professional development identified by Sowder (2007) were incorporated in the project: the education systems and schools were very supportive, teachers were consulted about their needs on several occasions over the three years, there was the continuity over three years, the leaders attempted to model the teaching strategies advocated, and opportunities were provided for collaborative problem solving. All schools had several teachers involved in the project and there was the expectation that they would work

collaboratively in their schools as well as when they were at project learning sessions. In addition, Key Curriculum Press provided its middle school statistical software, *TinkerPlots* (Konold & Miller, 2005), to all schools in the project.

Professional learning was delivered in two ways. Whole of cluster sessions were combined with case studies, where each school was assigned a researcher to be involved in a project of its own choice (e.g., Beswick, 2009; Brown, Rothwell, & Taylor, 2007). Ongoing feedback was sought from participating teachers: at the ends of the sessions, in meetings with school-based coordinators, through surveys of teachers leaving the project and by way of interviews with 19 teachers at the conclusion of the project.

By the end of the project, a total of 24 whole of cluster professional learning sessions had been provided, 3 in the first year, 11 in the second, and 10 in the final year of the project. Whole of cluster sessions were largely replicated in each cluster, however different needs expressed by the teachers in each cluster resulted in some modifications to content and format.

Data Analysis

A performance measure of numeracy ability was obtained from Part B of the student survey. As stated previously, there were 38 distinct items in Part B of the 2005 survey, 34 in 2006 and 40 in 2007. Seven items were common to the three surveys. Using the same measurement techniques as reported in Watson, Beswick, Brown, and Callingham (2007), data from the mathematics tasks were analysed using the Rasch Partial Credit Model (Masters, 1982). The seven link items common to all three surveys provided an anchor set that established the difficulties of the items at each test administration relevant to each other (Griffin & Callingham, 2006). Estimates of person ability were identified for each student in 2005, 2006 and 2007, anchored to the same set of link item difficulties. In so doing, genuine comparisons could be made and these ability measures were used as a basis for subsequent analyses. The performance of students in each grade was summarised for each year of the project and these measures provided a comparison of performance by grade. Furthermore, summary information from students who completed all three tests provided a measure of growth across time.

Results and Discussion

Student change in numeracy ability was analysed in two ways. First, the mean ability by grade was obtained for each year of the study for the full cohort of students. This analysis provided within grade measures, and was useful in identifying how the performance of the student participants differed over time. The information is shown in Figure 2. The first aspect is that students in the later years of the project are of considerably higher measured ability. Of those students who participated in 2005, only just over half also participated in 2006, and in 2007, 58% of students had participated in either one or both of the previous years. This suggests that although the overall number of students remained high, each year there was a large inflow of students into the project and so the change in ability at different grades could in part be due to the changed cohort.

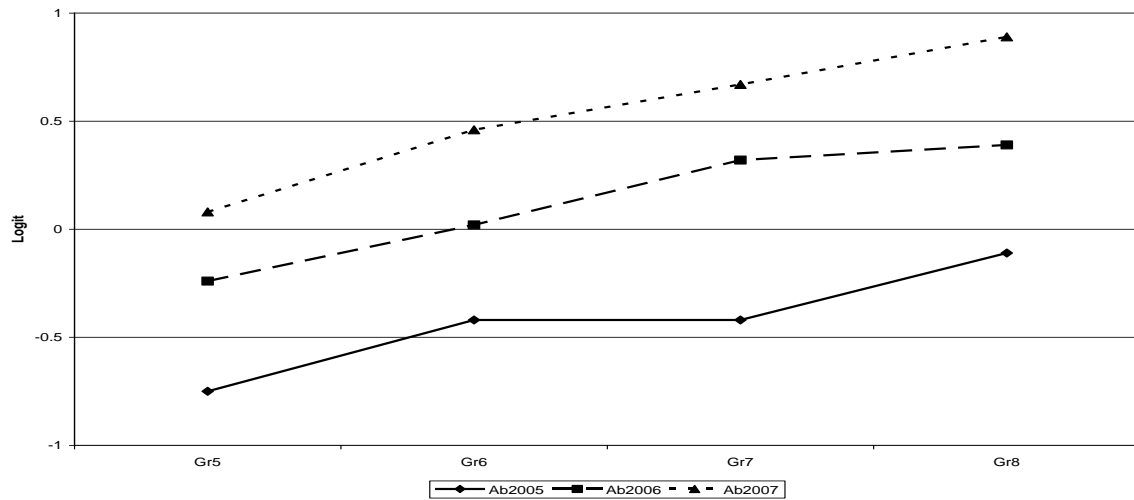

Figure 2. Student performance by grade across time.

The graph in Figure 2 shows a “learning trajectory” based on measured ability in different grades. In 2005, the classic transition effect (Anderman & Midgley, 1997) is clearly seen between Grades 6 and 7. This effect appears to have disappeared in the 2006 and 2007 data. Because of the change in the cohort care must be taken when interpreting this finding, however, it does suggest that the project helped to reduce this effect.

The results of a second set of analyses based on matched data only across all 3 years of the study are shown in Table 3. For each grade cohort the mean ability score increased from 2005 to 2006 and from 2006 to 2007. Large effect sizes and very strong statistical significance values are evident in all cohorts with the exception of the Grade 6 2006 to Grade 7 2007 cohort. This suggests that very positive change in student performance in the mathematical thinking section of the surveys occurred from 2005 to 2007.

Figure 3 shows the growth over time of these students as they moved from grade to grade, and includes 259 students across Grades 5 to 9. The legend shows the start grade in 2005. Again there are a number of features worthy of note. The slopes of the lines are very similar, indicating that, in general, the rate of growth for these students was similar regardless of the grade in which they started the project. The growth for the students who started the project in Grade 7 in 2005 to 2006 (Grade 8) is very similar to the growth of students from lower grades. There is, however, almost no growth from 2006 (Grade 8) to 2007 (Grade 9). Grade 9 was not a target grade for the study, and the teachers of this grade did not participate in the professional learning program. It is possible that the lack of

growth among this group is associated with a changed teaching as the students moved into the higher grade, but without additional data this idea has to remain as a conjecture.

Table 3
Performance by Grade across Time – Part B items

Outcome Measure (Grade, Year)	Initial Ability (logits)			Final Ability (logits)			t	p value	Effect Size
	mean	n	SD	mean	n	SD			
G5 2005 – G6 2006	-0.80	116	0.94	0.43	90	0.68	10.55	0.000	1.48
G6 2006 – G7 2007	0.43	90	0.68	0.52	53	1.38	0.53	0.594	0.09
G6 2005 – G7 2006	-0.28	90	0.70	0.45	53	1.05	4.98	0.000	0.86
G7 2006 – G8 2007	0.45	53	1.05	1.02	90	0.84	3.57	0.000	0.61
G7 2005 – G8 2006	-0.28	53	0.87	0.43	90	0.68	5.43	0.000	0.93
G8 2006 – G9 2007	0.43	90	0.68	0.74	116	0.92	2.68	0.008	0.37

Figure 3. Student ability measures, growth over time (matched students only) shown by start grade in 2005 (error bars omitted for clarity).

Among the professional learning experiences of the researchers and teachers (as reported formally in teacher interviews on completion of the project, and informally throughout the life of the project), a few sessions stand out as examples that may have been instrumental in influencing the outcomes for students. These include sessions on measurement, proportional reasoning, mathematical inquiry, pattern and algebra, and fractions, some of which have been reported elsewhere (Watson, 2008; Watson & Wright, 2008; Brown, Watson, & Wright [in press]; Watson, Skalicky, Fitzallen, & Wright, 2009). Teachers particularly appreciated that the professional learning sessions incorporated practical ideas, example test items and sequencing of activities. Teachers also noted that the researchers' emphasis on student understanding was particularly beneficial with many commenting that following the professional learning intervention they subsequently checked for student understanding prior to moving onto other or more complex areas of mathematical study. Watson et al. (2006) describe the change in the teacher's reported level of knowledge of their students and their own ability to intervene when issues of misunderstanding occur.

Another important aspect of the professional learning program that may have affected student learning was the process of involving teachers in the analysis of student survey responses and the consideration of the implications for classroom teaching. Feedback from teachers was that they had never previously undertaken this type of activity and that they developed meaningful intuitions by so doing. This process may have been particularly influential in the final year of the project where significantly improved outcomes were reported, as teachers and researchers had the results of the previous two years to work with and professional learning was focused specifically on areas of weakness as indicated in the 2005 and 2006 survey results.

In terms of the students themselves, teachers commented that by the end of the project their students were more able to explain their mathematical thinking, their confidence in their own ability had increased, and they were asking more questions than ever before. Of equal, if not greater, importance is that teachers reported that their students now enjoyed mathematics more than they did previously.

Conclusion

The MARBLE project was underpinned by the principles accepted in the literature as appropriate foundations for teacher professional learning with the potential to effect improved student numeracy learning outcomes (e.g., Hiebert & Grouws, 2007; Sowder, 2007), and improved outcomes did occur for students over the three years of the project. A comparison of these outcomes with those reported in Watson et al. (2007), which focused on performance during the first two years of the project, shows distinct improvement in the students' mathematical thinking. Although disappointing outcomes were seen across cohorts of students in the same grades, with the exception of Grade 7, in the first two years, by the end of the project statistically significant improvement was seen in most cohorts (the exception being the Grade 6 students in 2006 moving to Grade 7 in 2007, in which the improvement was in a positive direction but not at a significant level). The continued and vastly improved growth over time of matched students is also encouraging and lends support to the authors' belief in the positive influence of the teacher professional learning on student learning. The project represents a step towards the improving the evaluation of professional learning programs to include measures of the outcomes that matter most: students' mathematical understandings.

Acknowledgements

This project was funded by Australian Research Council grant LP0560543 with industry partners the Department of Education Tasmania and the Catholic Education Office (Hobart).

References

- Anderman, E. M., & Midgley, C. (1997). Changes in achievement goal orientations, perceived academic competence, and grades across the transition to middle-level schools. *Contemporary Educational Psychology*, 22(3), 269-298.
- Beswick, K. (2009). Representing proportional relationships algebraically. In C. Hurst, M. Kemp, B. Kissane, L. Sparrow & T. Spencer (Eds.), *Mathematics: It's Mine* (Proceedings of the 22nd biennial conference of the Australian Association of Mathematics Teachers, pp. 53-64). Adelaide: AAMT, Inc.
- Brown, N., Rothwell, P., & Taylor, S. (2007). Collaborative development of a Framework for Numeracy: A case study. In K. Milton & H. Reeves (Eds.), *Mathematics: Essential for learning, essential for life* (Proceedings of the 21st biennial conference of the Australian Association of Mathematics Teachers. Inc., pp. 60-67). Adelaide: AAMT, Inc.
- Brown, N., Watson, J., & Wright, S. (in press). My favourite ratio inquiry. *Australian Mathematics Teacher*.
- Callingham, R., & Griffin, P. (2000). Towards a framework for numeracy assessment. In J. Bana & A. Chapman (Eds.), *Mathematics Education beyond 2000* (Proceedings of the 23rd Annual Conference of the Mathematics Education Research Group of Australasia, pp. 134-141). Sydney: MERGA.
- Committee for the Review of Teaching and Teacher Education. (2003). *Australia's Teachers: Australia's Future – Advancing Innovation, Science, Technology, and Mathematics*. Canberra: Commonwealth of Australia.
- Department of Education, Community and Cultural Development (1997). *Year 9 numeracy and assessment monitoring program*. Hobart: Office for Educational Review and Assessment Research Centre, University of Melbourne.
- Department of Education, Tasmania. (2002). *Essential learnings framework 1*. Hobart: Author.
- Department of Education, Tasmania. (2003). *Essential learnings framework 2*. Hobart: Author.
- Department of Education, Tasmania (2007). *Tasmanian Curriculum Framework Parents Update*. Retrieved 26 March from http://www.education.tas.gov.au/dept/about/minister_for_education/curriculumupdateparents2
- Griffin, P. & Callingham, R. (2006). A twenty-year study of mathematics achievement. *Journal for Research in Mathematics Education*, 37 (3), 167-186.

- Hawley, W.D., & Valli, L. (1999). The essentials of effective professional development: A new consensus. In L. Darling-Hammond & G. Sykes (Eds.), *Teaching as the learning profession: Handbook of policy and practice* (pp. 127-150). San Francisco: Jossey-Bass.
- Hiebert, J.S., & Grouws, D.A. (2007). The effects of classroom mathematics teaching on students' learning. In F. K. Lester Jr. (Ed), *Second handbook of research on mathematics teaching and learning* (pp. 371-404). Reston, VA: National Council of Teachers of Mathematics.
- Konold, C. & Miller, C.D. (2005). *TinkerPlots: Dynamic data exploration* [computer software]. Emeryville, CA: Key Curriculum Press.
- Masters, G.N. (1982). A Rasch model for partial credit scoring. *Psychometrika*, 47, 149-174.
- Shulman, L. S. (1987). Knowledge and teaching: Foundations of the new reform. *Harvard Educational Review*, 57, 1-22.
- Sowder, J.T. (2007). The mathematical education and development of teachers. In F. K. Lester Jr. (Ed.), *Second handbook of research on mathematics teaching and learning* (pp. 157-223). Reston, VA: National Council of Teachers of Mathematics.
- Steen, L.A. (Ed.). (2001). *Mathematics and democracy: The case for quantitative literacy*. Washington, DC: Woodrow Wilson National Fellowship Foundation.
- Watson, J.M. (2001). Profiling teachers' competence and confidence to teach particular mathematics topics: The case of chance and data. *Journal of Mathematics Teacher Education*, 4, 305-337.
- Watson, J.M. (2008). Exploring beginning inference with novice grade 7 students. *Statistics Education Research Journal*, 7(2), 59-82.
- Watson, J., Beswick, K., & Brown, N. (2006). Teachers' knowledge of their students as learners and how to intervene. In P. Grootenboer, R. Zevenbergen, & M. Chinnappan (Eds.), *Identities, cultures and learning spaces* (Proceedings of the 29th annual conference of the Mathematics Education Research Group of Australasia, Canberra, pp. 551-558). Adelaide, SA: MERGA.
- Watson, J., Beswick, K., Brown, N., & Callingham, R. (2007). Student change associated with teachers' professional learning. In J. Watson & K. Beswick (Eds.), *Mathematics: Essential research, essential practice* (Proceedings of the 30th Annual Conference of the Mathematics Education Research Group of Australasia, Hobart, pp. 785-794). Sydney: MERGA.
- Watson, J.M., & Callingham, R.A. (2003). Statistical literacy: A complex hierarchical construct. *Statistics Education Research Journal*, 2(2), 3-46.
- Watson, J., Skalicky, J., Fitzallen, N., & Wright, S. (2009). Licorice production and manufacturing: All-sorts of practical applications of statistics. *Australian Primary Mathematics Classroom*, 14(3), 4-13.
- Watson, J., & Wright, S. (2008). Building informal inference with *TinkerPlots* in a measurement context. *The Australian Mathematics Teacher*, 64(4), 31-40.

Biased Sampling and PCK: The Case of the Marijuana Problem

Jane M. Watson

University of Tasmania
<Jane.Watson@utas.edu.au>

Erica L. Nathan

University of Tasmania
<elnathan@utas.edu.au>

As part of an interview protocol investigating teachers' pedagogical content knowledge (PCK) in statistics, 40 teachers were presented with a newspaper article reporting a phone-in survey about the legalisation of marijuana. The article and a question about the reliability of the sample had earlier been used in student surveys, and three student answers to the question were also presented to the teachers. Teachers' PCK was assessed based on responses to questions about the big ideas in the task, potential student appropriate and inappropriate answers, and how teachers would intervene in relation to the three student answers. The wide range of responses provided evidence for the potential of the task in a cross-curricular secondary classroom.

As statistics has assumed a higher profile within the mathematics curriculum, interest has increased in teachers' knowledge for teaching the subject matter to their students. Growing out of the general work on knowledge for teaching by Shulman (1987), Watson (2001) developed a protocol to measure the various aspects defined by Shulman, including content knowledge, pedagogical content knowledge (PCK) and knowledge of students as learners. Ball and colleagues (e.g., Ball, Thames, & Phelps, 2008; Hill, Schilling, & Ball, 2004) focussed on a collection of traits they labelled "mathematical knowledge for teaching" and Groth (2007) adapted this model for teaching statistics. Based on a survey protocol derived from Watson (2001), Watson, Callingham, and Donne (2008) used Rasch (1980) analysis, extended to a partial credit format (Masters, 1982), to obtain a measure of teacher ability in relation to PCK. For that study the focus of PCK was on teachers' content knowledge, its reflection in knowledge of their students' content knowledge, and their PCK in using student answers to devise teaching intervention.

Following the research of Watson et al. (2008) based on teacher surveys, it was decided to interview the same cohort of teachers with the aim of extending the detail and richness of teachers' PCK. This was done with an interview protocol that included general questions on teaching statistics at the beginning and end, with three sections in the middle based on items from student surveys. After the statement of the problems as presented to students, teachers were asked to say what they thought were the 'big ideas' behind the problem and to provide appropriate and inappropriate answers that they might expect from their students. They were then shown two or three responses from students and asked how they would intervene to assist the students to improve their understanding. Detailed analysis of the first task (Watson, Callingham, & Nathan, 2009), based on a pictograph item, refined the construct of PCK to suggest four components. The first two, "*Recognises Big Ideas*" and "*Anticipates Student Answers*" reflected directly the questions asked of the teachers in order to display their own content knowledge and knowledge of students as learners. The third, "*Employs Content-specific Strategies*" encompassed appreciating the nature of the student's answer, beginning at that point, and suggesting appropriate strategies with respect to the answer that demonstrate opportunity to move the student forward. Examples of teacher behaviour included encouraging questions to clarify and explain student answers, constructing sequences of questions based on personal understanding, offering alternative data sets or scenarios, or formalising a discussion. The fourth component, *Constructs Shift to General*, referred to an appreciation of the many



statistical ideas related to the initial task and the ability to explore and expand these with the class based on opportunities provided by student answers. It included linking the student answer to these other related statistical ideas and introducing an awareness of language. Specifically related to the pictograph context, examples focussed on revealing the difference between the pictograph as a statistical model and as a vehicle representing real data, exploring the concept of “majority,” exposing the limitations of the data collection, and experimenting with alternative representations.

The four components were then used as a basis for analysing the third task in the interview protocol (Watson & Nathan, in press), a two-way table problem with data on smoking and lung disease (Batanero, Estepa, Godino, & Green, 1996). For that analysis a detailed hierarchical rubric was devised for each component of the framework for PCK. The outcomes suggested that distinguishing between “*Employs Content-specific Strategies*” and *Constructs Shift to General* is a useful way of differentiating teacher performance, in that teachers displayed much more ability to handle the content-specific strategies than the generalities. The components and rubrics were then applied to the second task in the interview protocol based on a newspaper article about a survey on legalising marijuana, which is the focus of this paper.

The research questions for this study hence are the following. (1) Given the different context based on sampling rather than a pictograph representation or more a mathematical two-way table, does the framework of four components of PCK provide a comprehensive way of describing teachers’ ability to use the task in their classrooms? (2) If so, what is learned about teachers’ understanding of the teaching of sampling?

Methodology

Sample. Forty teachers from three Australian states were interviewed: 14 from each of two states, and 12 from the third. They were involved in a professional learning project in statistics for the middle school (Callingham & Watson, 2008). Teachers taught in Grades 5 to 12, had teaching experience ranging from 2 to 25 years, and had a wide-range of previous tertiary study in mathematics and statistics.

Task. The portion of the interview protocol analysed for this paper is shown in Figure 1. The original article appeared in *The Mercury* newspaper in Hobart, Tasmania (“Decriminalise,” 1992) and the item for students was used across several research studies (Watson & Moritz, 2000a, 2000b; Watson & Callingham, 2003), including the one in which the interviewed teachers participated. The student answers presented to the teachers were from students involved in the same project as the teachers.

Analysis. The rubric in Table 1 for the first PCK component, *Recognises Big Ideas*, applied mainly to question Q2M, and the rubric for the second PCK component, *Anticipates Student Answers*, applied mainly to Q3M. Occasionally information from Q4M was assessed if it addressed these two features. The rubric for the third PCK component, *Employs Content-specific Strategies*, was based on Questions Q5M, Q6M, and Q7M combined, while the rubric for the fourth component, *Constructs Shift to General*, was assessed across all questions in Figure 1. The responses were coded independently by the authors using the rubric in Table 1 and discrepancies negotiated until agreement was reached.

Decriminalise drug use: poll

SOME 96 percent of callers to youth radio station Triple J have said marijuana use should be decriminalised in Australia. The phone-in listener poll, which closed yesterday, showed 9924 – out of the 10,000-plus callers – favoured decriminalisation, the station said. Only 389 believed possession of the drug should remain a criminal offence. Many callers stressed they did not smoke marijuana but still believed in decriminalising its use, a Triple J statement said.

Is the sample reported here a reliable way of finding out public support for the decriminalisation of marijuana? Why or why not?

- Q2M. What are the big statistical ideas in this problem? (Probe: What answer would you give?)
 Q3M. Please can you give an example of an appropriate response and an inappropriate response that your students might give? (Probe: Can you explain why it is appropriate/inappropriate?)
 Q4M. What opportunities would this problem provide for you teaching? (Probe: Where would you place it in your lesson sequence? Or in your school's curriculum sequence?)
 Q5M. **Show student response: Yes, because 10,000 people is enough to get an accurate average of the view of the public.** A student gave this answer. How would you move this student's understanding forward? (Probe: What would be the next step in learning?)
 Q6M. **Show student response: No, because it is not everyone in Australia voting.** (Same as Q5M)
 Q7M. **Show student response: No, because some people could be lying.** (Same as Q5M)

Figure 1. Interview protocol extracts for Marijuana problem.

Table 1
Rubric for Responses to Marijuana Interview

Code	Description
Component 1: <i>Recognises Big Ideas</i>	
0	Responses confused and/or incorrect
1	Response implied and/or understanding revealed beyond initial question
2	Immediate grasp of idea, language specific
Component 2: <i>Anticipates Student Answers</i>	
0	Response irrelevant
1	Appropriate or inappropriate but not both, or unclear
2	Distinguishes both appropriate and inappropriate
3	Demonstrates understanding of students' reasoning
Component 3: <i>Employs Content-specific Strategies</i>	
0	Response absent or indicates misleading content
1	Content knowledge of sampling requisite to initiate a discussion
2	Demonstrates questions or knowledge that might <i>structure</i> a discussion about sampling
3	Extends discussion by illustrating/ referencing beyond the marijuana survey
Component 4: <i>Constructs Shift to General</i>	
0	No shift to general evident
1	Considers elements of sampling design in general terms, e.g., size changeable with purpose; profiling of sample population; census vs sampling; accounting for invalid responses; social sensitivity
2	Extrapolates from survey to consider one or more statistical concepts, e.g., random, representation, average
3	Relates survey construction to wider context of argument and/or introduces an awareness of language, e.g., lying, "public"

Results

Research Question 1

Table 2 contains a summary of the codes for the PCK components described in Table 1 for the 40 teachers interviewed.

Table 2
Number of Teachers Receiving each Code for each PCK Component (n=40)

PCK Component	Code			
	0	1	2	3
1 <i>Recognises Big Ideas</i>	1	11	28	—
2 <i>Anticipates Student Answers</i>	0	8	28	4
3 <i>Employs Content-specific Strategies</i>	1	17	16	6
4 <i>Constructs Shift to General</i>	12	18	7	3

Examples of teachers' responses at the various levels for the four components of PCK exemplify the hierarchical nature of the rubric. For the first component, *Recognises "Big Ideas,"* teachers generally (70%) displayed an immediate grasp of why the researchers had set the task in relation to the type of sampling involved, e.g., "The biggest thing is about looking at the randomness of, how do we get the random sample and it's not a good example of that at all." One teacher, however, appeared to miss the point responding, "...we would probably take the numbers... So taking the numbers that stand out which is 10,000, 9,924 and 389 and working out, from different perspectives, what those numbers actually mean." A few others struggled initially but eventually suggested reasonable ideas behind the task, e.g., "Well it is sampling, conducted a poll and they have collected data."

For the *Anticipates Student Answers* component, no teachers gave totally irrelevant responses, but a notable few (20%) gave responses that were difficult to distinguish between being appropriate or inappropriate and the teachers were not explicit: "I think a lot of them would probably believe it and that's concerning me... Or they would just look at it and say that most people favoured decriminalisation of marijuana."

Most teachers (70%) could distinguish between appropriate and inappropriate response, e.g.

...well it is a very limited sample that they have taken the question from. So therefore its reliability is not reliable because it is not a full population sample – not a full age population sample – only listeners, Triple J audience which may be just a particular sort of lifestyle audience.... Or then they would just generalise and sort of say well therefore everybody says the marijuana should be decriminalised because 96% said such. So they are making a big generalisation from that particular response which would be a totally inappropriate thing.

Only 10%, however, displayed a clear understanding of student reasoning, e.g.

I reckon a lot of the students would probably say that using JJJ as your only source for the survey would show something doesn't represent the population. Whether they go any further and get into more detail, they probably wouldn't. I think 96% would trigger a lot of them to just react from that. So a lot of them do go straight for a percent cause they like the idea of percents... They skim it, so they won't read it, stop, and actually try and understand what's been written. I think most of them would just look for big things that they can base some comment from... A lot would see that and make a personal comment about it rather than a statistical. So, they would, wouldn't actually say

anything about statistics or about the survey, they'd say, you know, that people support it or not. And then they put their own personal opinion in.

When perusing Table 2, it is clear that teachers found it easier to suggest content-specific strategies in response to student answers presented than to construct a shift to more general concepts. However, where only one teacher failed to suggest a strategy for PCK Component 3, 30% failed to show a capacity to shift to general for PCK Component 4. Considering first the responses for Component 3, *Employs Content-specific Strategies*, responses at Code 1 displayed the content knowledge to initiate a discussion based on the article, but did not go further. The range of suggestions for example included the following for the three student responses.

Q5M (10,000 enough): But is that a reasonable snapshot of the entire population or is it a specific demographic? Q6M (not everyone): I'd say fair enough but under what circumstances are you going to be able to have the funding to get everyone to vote? Q7M (lying): Well you're going to take that chance no matter what survey and technique you do.

At Code 2, the increased ability to structure is shown from several perspectives and illustrated in the following detail.

Q5M (10,000 enough): ...they have some sense of size being a contributing factor to sampling but also you would have to then obviously go through the whole point of the biased nature of who those 10,000 people are and where they come from ... that they don't represent the public as a whole. Q6M (not enough): ...You'd have to talk about the fact that, is it realistic to sample everyone when you want to find out something and so therefore sampling is valid and important but in the right format. Q7M (lying): ...why would they ring up and lie? So that might be an interesting insight into ... what they think is happening there ... you'd have to get a sense of where the kid's coming from I think before you could respond to that.

An ability to extend the discussion beyond the marijuana survey (Code 3) was demonstrated by several teachers, including the following.

Q5M (10,000 enough): ...How can you talk about the whole sampling process? So for instance, ok, this is a phone-in listener poll. What about people with really valid thoughts that couldn't phone in for whatever reason? Ok, now so it's all about randomness here. And once again we're talking about a youth radio station, well, how well does that represent the population of people? Like I said, great that you've mentioned it's a large sample size, but you're missing the fact that it's random, or not random in a sense. Q6M (not enough): Hearing that straight up, I'd say, listen that's a great point, you're right, everyone in Australia hasn't voted, so do we really know? But could everyone in Australia vote? I mean, how viable is it that we could actually get every single person in Australia to register some sort of a vote. We have to do some sort of sampling don't we? And the key is how we go about that sampling process. That's how I would address that answer there. So they've got a point but they just need a bit of elaboration. Q7M (lying): Once again, that's a great answer. How do we know? How do we know whether some people are lying? We don't. ... You like to take their word for it. Some people could be lying. But then again, how would I address that? I don't know whether it's relevant but you'd probably go into, in this case, why is that they would want to lie? ... I mean, it's a sensitive issue. Yeah, I'd find it hard to probably justify lying ... but I would probably look at the actual question. I mean, it doesn't seem personal ... It's not like you're doing a face to face interview, so you're not getting a change in body structure or anything like that where you can tell that this is, oh does this person smoke marijuana themselves, or something. It's a phone in, so the scope for lying here would probably be minimal. You'd think that if people had a genuine idea they'd probably would register a vote and would probably be the truth simply because it's a phone in poll.

With respect to the fourth component *Constructs Shift to General*, the Code 1 responses suggested a range of more general extensions related to the survey described in the article, including the following.

Oh – so it is really – opening the issue of question, census and sampling, sort of makes ... some of them realise just how much bigger this country really is. And I would say it is not supposed to be a census because that's the word I would use for everybody, this is supposed to be a sample, which is a small part of [it] and that's – it's usually reported as a sample rather than saying – suggesting the whole population.

Code 2 responses included consideration of some of the statistical concepts involved.

What is an average and what are you basically saying by an accurate average? ... we might go through how they got averages and work out can we get enough to get an accurate average view, of the view of the public? Can we get an average view for this particular question? Yeah, so probably draw attention to that first. 10,000 is enough ... and some people would say that's a high sample, so, but again 10,000 people of what particular age group or particular demographic? If you took 10,000 children, would they say that computer use should be restricted, I'd try and draw attention to those particular social issues of kids. And work statistically on working out what is an average. What does the average of the view mean? ... Again it relates back to what you regard as a random sample.

Finally three teachers related the survey and its construction and application to wider public issues, such as the following from one of the three.

And then I would probably pose some questions in other contexts, so you know, if we were trying to figure out what the public response was to say, you guys wanting a new skate park to be built on our island, which is a big issue at the moment. How would we go about that? What problems might there be, how could that, you know, be similar here. What would happen if they come up with things like, well we just ask all the kids in the school. I said, is that the public? Why should we, why should we ask anybody else? Why should we get a general public opinion? Well, you know, they're the ratepayers, they pay the Council rates and the Council spends the money. So there's all those social sorts of ideas that can be discussed in there as well as bringing the idea of well how do you get a representative sample? What is a representative sample? How many would you have to ask and all of that stuff ... Ok, so then we have to discuss the difference between a sample in the census and that has formed a reasonably large part of my teaching. And we've done that, particularly with, to move this thinking on, that idea that you don't get quality information if you don't hold a census; and we've used information from the census online, where we've taken samples and usually what I do is I take a large sample and then I divide it up into smaller samples from that large sample and give them to different groups in the class to analyse and we might go as small as say a sample of 10. ... And in terms of what do we do if someone's deliberately lying, there's not a lot we can do. They have to accept that ... We have to take that consideration into account when we are relying on the results from our analysis of the data

Research Question 2

Having given examples of teachers' levels of ability on the four components of PCK, what is learned more generally about teachers' understanding of teaching about sampling? Based on the responses, the opportunities suggested by teachers are categorised into several groupings. More than half of the teachers suggested a wide range of other examples of surveys for their students to consider, which either displayed similar bias or gave students the opportunity to devise non-biased sampling. Examples included Australian Idol, Morgan polls, surveys in supermarkets, school-based surveys, and Census@School.

The specific language and concepts suggested for discussion included census and survey, population and sample, the "public," being representative, bias, and random. One teacher specifically mentioned the literacy of mathematics in relation to this task and another teacher noted the importance of asking students multiple questions to "get behind students' meaning" in reference to their use of language. Several teachers, however, mentioned the literacy requirement for some students in reading and interpreting the text

and the difficulties it would pose. One teacher felt the problem was more appropriate for literacy than mathematics and another suggested it be linked to health.

The student response about lying elicited a broad range of suggestions for classroom discussion. Some teachers just explicitly stated the equivalent of “it doesn’t matter” as it would be a small percentage of a large sample and no data are completely fool proof. Reasons not to worry included the anonymity of calls, there being no repercussions for answers, and the apparent yes/no type of question. Reasons the people might lie or bias the survey included peer pressure, people wanting a particular voice or lobby group to be heard, and realisation of the possibility to phone in more than once. A couple of teachers suggested asking who might be lying; the callers or the radio station. At another level, one teacher suggested asking how one could check on lying. Others suggested devising different survey questions or conducting interviews where body language could be observed. One teacher suggested asking a student for evidence of lying and how it might be obtained. Finally two teachers referred to their students’ experiences with Census@School data sets and the erroneous data sometimes obtained as laying a foundation for students appreciating the fallibility of data for various reasons.

Issues of motives behind conducting the survey were raised by some teachers and others suggested students write some other questions for the survey, either biased or unbiased. Another teacher suggested students consider what kinds of questions people would respond to. On the pragmatic side one teacher noted that one had to be listening to the station at the appropriate time, whereas another noted that only those with credit on their mobile phones could phone. In relation to the student response about everyone not answering, most teachers just noted the impossibility of collecting census data, with some noting sampling practicalities and others cost. A few teachers of younger students (e.g., Grades 5 or 6) felt the problem was too complex, either in terms of the context or the statistical understanding for their students.

Discussion

The framework of four components of PCK did provide the researchers with a comprehensive way of describing teachers’ ability to explore the problem of sampling in their classrooms. Coding of four non-hierarchical components encouraged a dissection of the teaching process with the objective of understanding the working constituents of statistical PCK. The fact that 28 out of 40 teachers scored at Code 2 for the first (*Recognises Big Ideas*) and second (*Anticipates Student Answers*) components of the rubric confirmed teacher confidence in the content knowledge of statistical sampling. Almost half the teachers were able to identify the potential of student responses and structure a discussion concerning aspects of the sampling problem which suggests that this knowledge was “active” teaching knowledge, and that there was a capacity to meet, lead and shape student understanding. However, teachers seemed less able to situate the problem of sampling within the wider world of statistics, to link it to associated concepts, and to appreciate its limitations, as well as strengths, as an analytical tool. This is evident from the coding results of the fourth (*Shift to General*) component. Almost half were able to establish the complexity of sampling design. However, the idea of sampling itself as part of a wider statistical construct was pursued by very few. The indication that most teachers have difficulty in this task of conceptual extension has repercussions for professional development.

Although the teacher responses did not score strongly across all four components, there was a considerable range of responses within the confines of the specific sampling

problem. This is perhaps best demonstrated in the discussion points prompted by Q7M (lying). What might have seemed like a straightforward student answer with a narrow opportunity to build upon actually sparked a surprising array of teacher responses. It seems likely that this abundance of responses was in large part a by product of the teachers' sound performance for the first and second component of the PCK Statistics framework. Q7M has been selected for particular attention, but the range of responses to all three student answers highlighted the appropriateness and importance of statistics being taught across the curriculum.

Acknowledgements.

The research was funded by Australian Research Council grant no. LP0669106. Thanks to Julie Donne and Elena Zema, who conducted some teacher interviews.

References

- Ball, D. L., Thames, M. H., & Phelps, G. (2008). Content knowledge for teaching: What makes it special? *Journal of Teacher Education*, 59, 389-407.
- Batanero, C., Estepa, A., Godino, J. D., & Green, D. R. (1996). Intuitive strategies and preconceptions about association in contingency tables. *Journal for Research in Mathematics Education*, 27, 151-169.
- Callingham, R., & Watson J. M. (2008). Overcoming research design issues using Rasch measurement: The StatSmart project. In P. Jeffery (Ed.), *Proceedings of the AARE annual conference, Fremantle, December, 2007*. Available at <http://www.aare.edu.au/07pap/cal07042.pdf>
- Groth, R. E. (2007). Reflections on a research-inspired lesson about the fairness of dice. *Mathematics Teaching in the Middle School* 13(4), 237-243.
- Hill, H. C., Schilling, S. G. & Ball, D. L. (2004). Developing measures of teachers' mathematics for teaching. *Elementary School Journal*, 105, 11-30.
- Masters, G. N. (1982). A Rasch model for partial credit scoring. *Psychometrika*, 47, 149-174.
- Rasch, G. (1980). *Probabilistic models for some intelligence and attainment tests*. Chicago: University of Chicago Press (original work published 1960).
- Shulman, L. S. (1987). Knowledge and teaching: Foundations of the new reform. *Harvard Educational Review*, 57, 1-22.
- Watson, J. M. (2001). Profiling teachers' competence and confidence to teach particular mathematics topics: The case of chance and data. *Journal of Mathematics Teacher Education*, 4, 305-337.
- Watson, J. M., & Callingham, R. A. (2003). Statistical literacy: A complex hierarchical construct. *Statistics Education Research Journal*, 2(2), 3-46.
- Watson, J., Callingham, R., & Donne, J. (2008). Establishing PCK for teaching statistics. In C. Batanero, G. Burrill, C. Reading, & A. Rossman (Eds.), *Joint ICME/IASE Study: Teaching Statistics in School Mathematics. Challenges for Teaching and Teacher Education*. (Proceedings of the ICMI Study 18 and the 2008 IASE Round Table Conference, Monterrey, Mexico, July, 2008). Available at http://www.ugr.es/~icmi/iase_study/
- Watson, J., Callingham, R., & Nathan, E. (2009). Probing Teachers' Pedagogical Content Knowledge in Statistics: "How will Tom get to school tomorrow?" In R. Hunter, B. Bicknell, & T. Burgess (Eds.), *Crossing divides* (Proceedings of the 32nd annual conference of the Mathematics Education Research Group of Australasia, Wellington, NZ, Vol. 2, pp. 563-570), Palmerston North, NZ: MERGA.
- Watson, J. M., & Moritz, J. B. (2000a). Developing concepts of sampling. *Journal for Research in Mathematics Education*, 31, 44-70.
- Watson, J. M., & Moritz, J. B. (2000b). Development of understanding of sampling for statistical literacy. *Journal of Mathematical Behavior*, 19, 109-136.
- Watson, J., & Nathan, E. (in press). *Assessing the interpretation of two-way tables as part of statistical literacy*. Refereed paper to be presented at the 8th International Conference on the Teaching of Statistics, Ljubljana, Slovenia, July, 2010.

Counting On in the Middle Years.

Allan Leslie White
University of Western Sydney
al.white@uws.edu.au

The 2009 *Counting On* program has evolved from a series that began in 1999 and which continued to expand and change until the current manifestation. The program has always had a twin learning focus upon both students and teachers. Thus it seeks to improve student mathematical outcomes while building capacity within the teachers by improving their professional situated mathematical knowledge which is the knowledge teachers need to effectively teach the early mathematical concepts to their students in a classroom context. *Counting On* 2009 was evaluated and this paper will use the findings of the evaluation report (White, 2010 in press) to examine whether the program was successful in changing student learning outcomes.

The 2009 *Counting On* program has evolved from a series of *Counting On* programs that continued to expand and change into the current manifestation. The program has always had a twin learning focus upon both students and teachers. Thus it seeks to improve student mathematical outcomes while building capacity within the teachers by improving their professional situated mathematical knowledge which is the knowledge teachers need to effectively teach the early mathematical concepts to their students in a classroom context.

This evolutionary process that started in 1999 saw the inclusion of a greater range of students (from Year 7 to Years 4 - 9), the inclusion of the feeder primary schools, and also a change in content and process. Until 2007 many of the basics of the diagnostic assessment had tended to remain essentially the same. Thus students were individually interviewed and videotaped for further analysis of their responses and this was a very time intensive process. In 2007 the program underwent significant modification that included a simplified assessment instrument and sorting process, where the interview was reserved for only the targeted students. There was also the introduction of Newman's Error Analysis; a revised *Counting On* CD to disseminate information and resources; the formation of School clusters; the use of a facilitator's conference; and a facilitated professional development model. The program began with and has continued to operate using a team approach and more recently school clusters have become Learning Communities and the globally successful Lesson Study model has been promoted as a structured way for Learning Communities and for members of a school team to work together. There was also a *Counting On* website.

The *Counting On* program sought to address the concerns of the numeracy and literacy outcomes of school students detailed in the *State Numeracy Plan 2006 - 2008* (NSWDET, 2005a) and the *State Literacy Plan 2006-2008* (NSWDET, 2005b) as well as the concerns listed under the six priority areas of the *Office of Schools Plan 2009-11* (NSWDET, 2008), by building capacity among teachers while improving the student understanding of early mathematical concepts and procedures.

Theoretical Basis.

There has been considerable research completed since 1990 in children's early mathematical understanding. For instance, research into mental computation has revealed a rich and complex range of mental strategies that children develop for multi-digit addition



and subtraction tasks. Thus a sample of the available strategies for answering $47+18$ could include: jump ($47+18: 47+10 \rightarrow 57+3 \rightarrow 60+5 \rightarrow 65$), split ($47+18: 40+10 = 50, 7+8 = 15, 50+15 = 65$), and compensation ($47+18: 47+20 \rightarrow 67-2 \rightarrow 65$), where the use of these or other mental strategies involves a broad knowledge of number relationships. This complex maze of relationships within early mathematical learning has resulted in a number of early numeracy programs all containing frameworks such as the Victorian Early Numeracy Research Project (ENRP), the New Zealand Numeracy Development Project (NDP) and the New South Wales Count Me In Too (CMIT) program. What these numeracy learning frameworks have in common is a strong link between research, pedagogy, teacher professional learning and a strong focus upon the learning of the student.

The research base for the program is closely related to the Counting On Numeracy Framework (Thomas, 1999) which was an extension of work by Cobb and Wheatley (1988), Beishuizen (1993), Jones, Thornton, Putt, Hill, Mogill, Rich and van Zoest (1996) and relates to the Count Me In Too Learning Framework in Number (LFIN) (Wright, 1998; Wright, Martland, & Stafford, 2000).

This research base was further supported by an increasing number of Counting On evaluation studies. Mulligan (1999) evaluated a pilot study involving 9 schools, after which the Counting On program began in 2000 with 40 schools, more than 600 students, 120 school teachers and 40 district mathematics consultants. Further evaluation reports on the Counting On program were conducted in 2000, 2002, 2003 and 2007 (Perry & Howard, 2000, 2002a, 2003; White 2008, 2009).

The inclusion of Newman's Error Analysis (NEA, Newman, 1977; 1983) in the 2007 program aimed to assist teachers when confronted with students who experienced difficulties with mathematical word problems. Rather than give students more drill and practice, NEA provided a framework for considering the reasons for the difficulties and a process that assisted teachers to determine where misunderstandings occurred and where to target effective teaching strategies to overcome them. Moreover, it provided excellent professional learning for teachers and made a nice link between literacy and numeracy.

Newman (1977, 1983) maintained that when a person attempted to answer a standard, written, mathematics word problem then that person had to be able to pass over a number of successive hurdles: Reading (or Decoding), Comprehension, Transformation, Process Skills, and Encoding. Along the way, it was always possible to make a careless error and there were some who gave incorrect answers because they were not motivated to answer to their level of ability. While there are many other theoretical approaches available to teachers, NEA offers one of the easiest to use and adapt and has proven popular among teachers for both the ease of the diagnostic features and also because it is easily used as classroom pedagogical and problem solving strategies.

This brief and far from comprehensive overview has sought to portray the 2009 Counting On program as an initiative that arose from an initial successful trial program that has continued to adapt and evolve each year to meet the changing challenges, concerns and demands of the students, teachers and system. There were changes incorporated into the 2009 program but it is beyond the scope of this paper to present the evaluation of the whole program and this paper will report only on the success of the 2009 program in overall terms of student mathematical learning outcomes.

Methodology

The 2009 program was implemented in 88 schools across the state. The schools were divided into 21 Learning Communities and each community was assisted by a Regional

Mathematics Consultant. In each school there was a teacher with the title of School Program Facilitator who formed a team of teachers to implement the program. In each school, the facilitator coordinated the process whereby each teacher administered a whole class assessment test covering place value, addition, subtraction, multiplication, division tasks and word problems. The assessment test was closely linked to the learning framework. These data were used by the teacher to identify the student target group. Target students scored few or no correct answers. The target group was then interviewed. Using a pre-test post-test procedure, on two occasions, teachers were asked to conduct a target group assessment process with a minimum of 5 students per class and facilitators were asked to record the student data on an excel spreadsheet supplied to them. The spreadsheet recorded the initial level on the LFIN and NEA items for the targeted students before the 2009 Counting On program was implemented and again following 10 weeks of targeted 2009 Counting On activities. These results were compiled and are reported in the next section.

Results

A total of 69 schools (78%) submitted data during September, consisting of 52 primary schools, 15 secondary schools and 2 special schools. There were 945 students included on the spreadsheet with 618 primary students (65.4%) and 327 secondary students (34.6%).

Table 1
Target Student Numbers in Each School Year

School Year	Frequency	Percentage Frequency
4	19	2.0%
5	330	34.9%
6	269	28.5%
7	207	21.9%
8	110	11.6%
9	10	1.1%
Total	945	100.0%

Place Value

In Table 2 below the initial and final LFIN levels of the 945 students are displayed for place value and a comparison of levels indicates an increase in the overall results from initial to final. There were 17% of students initially identified at the lowest level and that was reduced to 3% by the end of the program.

Table 2
The Initial and Final Place Value Levels

PV Levels	Initial Frequency	Percentage Frequency	Final Frequency	Percentage Frequency
0	162	17.14%	30	3.17%
1	352	37.25%	189	20.00%
2	335	35.45%	457	48.36%

3	68	7.20%	173	18.31%
4	21	2.22%	66	6.98%
5	7	0.74%	30	3.17%
Total	945	100.00%	945	100.00%

Table 3 shows the degree of student differences in levels between the initial and final levels for place value. It shows that the majority of students have improved by 1 or more levels (58.1%), with a sizeable group improving two levels (13.0%). A small number of students improved by 3 and 4 levels, and a small number declined by 1 or 2 levels.

Table 3
The Difference in Place Value Levels

Difference	Frequency	Percentage Frequency
- 2	2	0.2%
- 1	12	1.3%
0	382	40.4%
1	409	43.3%
2	123	13.0%
3	16	1.7%
4	1	0.1%
Total	945	100%

The descriptive statistics record an increase in the mean from 1.42 for the initial level (SD = 0.977) to 2.15 for the final level (SD = 1.026). Using a paired sample T-Test, the results indicate that the improvement in the student place value learning outcome levels at the start and finish of the 10 week 2009 Counting On program was statistically significant.

Multiplication and Division

Table 4 displays the initial and final LFIN levels for multiplication / division for the 945 students and also indicates an increase in the overall levels. It shows an overall improvement in the levels and where initially there were nearly 15% of students identified at the highest level, this increased to 35% by the completion of the program. When the differences in levels are further examined in Table 5 they show that the majority of students have improved by 1 or more levels (57.6%), with a sizeable group improving two levels (13.8%). A small number of students improved by 3 and 4 levels, and a small number declined by 1, 2 or more levels.

The descriptive statistics record an increase in the mean from 2.93 for the initial level (SD = 1.323) to 3.77 for the final level (SD = 1.186). Using a paired sample T-Test, the results indicate that the improvement in the student multiplication / division learning outcome levels at the start and finish of the 10 week 2009 Counting On program was statistically significant.

Table 4
The Initial and Final Multiplication/Division Levels

PV Levels	Initial Level Frequency	Percentage Frequency	Final Level Frequency	Percentage Frequency
-----------	----------------------------	-------------------------	--------------------------	-------------------------

1	175	18.52%	42	4.44%
2	198	20.95%	124	13.12%
3	228	24.13%	175	18.52%
4	206	21.80%	274	28.99%
5	138	14.60%	330	34.92%
Total	945	100.00%	945	100.00%

Table 5
The Difference in Multiplication/Division Levels

Difference	Frequency	Percentage Frequency
- 3	2	0.2%
- 2	3	0.3%
- 1	26	2.8%
0	370	39.2%
1	341	36.1%
2	130	13.8%
3	63	6.7%
4	10	1.1%
Total	945	100.00%

Mathematical Word Problems - Newman's Error Analysis

While there were two questions used involving Newman's Error Analysis in the assessment instrument' only the NEA result for the 'Natalie paddling the Murray River' item in both the initial and final assessments were recorded for each student. The NEA scale from 1 to 5 was used with a category 6 added to represent those who could complete the word problem successfully.

Table 6
The Initial and Final Newman's Error Analysis Levels

NEA Levels	Initial Level Frequency	Percentage Frequency	Final Level Frequency	Percentage Frequency
1	142	15.03%	63	6.67%
2	352	37.25%	202	21.38%
3	279	29.52%	291	30.79%
4	115	12.17%	228	24.13%
5	29	3.07%	78	8.25%
6	28	2.96%	83	8.78%
Total	945	15.03%	945	100.00%

Table 6 displays the initial and final NEA levels and indicates an improvement in the overall levels from the initial to the final student assessments. When explored further, Table 7 shows that the majority of students have improved by 1 or more levels (53.8%), with a sizeable group improving two levels (15.6%). Initially there were 67% of students

identified as experiencing difficulties with the two NEA levels of Comprehension and Transformation and this was reduced to 52% by the end of the program. A small number of students improved by 3 and 4 levels, and a small number declined by 1, 2 or more levels.

Table 7
The Difference in Newman's Error Analysis Levels

Difference	Frequency	Percentage Frequency
- 4	2	0.2%
- 3	2	0.2%
- 2	6	0.6%
- 1	45	4.8%
0	382	40.4%
1	317	33.5%
2	147	15.6%
3	32	3.4%
4	12	1.3%
Total	945	100.00%

The descriptive statistics record an increase in the mean from 2.60 for the initial level (SD = 1.151) to 3.32 for the final level (SD = 1.319). Using a paired sample T-Test, the results indicate that the improvement in the student outcomes for mathematical word problem levels at the start and finish of the 10 week 2009 Counting On program was statistically significant. There is a difficulty here in that these statistics rely on the assumption of the NEA levels being either a ratio or interval scale which is questionable regarding the equality of the distances between any two of the levels.

Discussion

The 2009 Counting On program had a positive impact upon students' early mathematics learning through its twin learning focus upon both students and teachers. There is a growing body of evidence claiming that teacher quality is one of the most important school factors influencing student achievement, ahead of class size and school size (Darling-Hammond, 2003; Cuttance, 2001). It is proposed but not proven that the student learning outcomes improved partly because teachers, through the support and resources of the program, had the opportunity to think, plan and reflect on their teaching, which produced a wider range of classroom strategies and a greater use of concrete materials.

The full effects of improved teacher professional learning are often delayed and reveal themselves later as the teacher completes the process of integrating the new learning into current practice. So while it may be impossible to measure the full effects at this time, it is possible to gather some indicators. The data collected indicated that a statistically significant improvement existed in student learning outcomes in all three specific areas measured. It is argued that repetition of the test would not influence the results as the students received no feedback on the initial test and there was at least a ten week gap between assessments. The use of a testing procedure raises the issue of whether a correct answer equates to understanding and that tests do not necessarily reflect their level of understanding of mathematical concepts and relationships (Ellerton & Olson, 2005).

Research has indicated a 35% mismatch with students who gave correct answers with little or no understanding and others who gave incorrect answers but possessed some understanding. While these findings cast doubt on the use of large scale testing programs as a means of making comparisons or being used as basis for the allocation of resources, it is less of an issue for this program as the groups of targeted students are small for each school and teachers make use of instruments LFIN and NEA which are designed to assist teachers in diagnosing the level of student understanding.

In a short program such as this, the results are quite remarkable. For some students, it is unrealistic to expect they will register an immediate improvement as they have been struggling for some time with their mathematical and literacy levels and have developed judgements of their own ability. To improve one level on either the LFIN or the NEA scale in such a small time frame is quite remarkable and points to educational significance. There is an expectation that these gains will continue as the students build upon their success and a longitudinal study of these students would be of interest but is beyond the scope of this paper.

There are alternative reasons for a lack of student progress or in some cases a regression in the levels. Some students have become fixated on inefficient correct procedures while others have 'fossilised' misconceptions (Vaiyatvutjamai & Clements, 2004). Also, the 2007 evaluation report explored reasons for the negative regression and listed factors such as the use of different assessors, poor initial teacher understanding of the LFIN and NEA, misdiagnosis, student resistance to assessment, and teacher confusion with the different levels for LFIN and NEA. It appeared that the errors originated from the same small number of facilitators and suggested inexperience and lack of understanding with the instruments.

This paper concludes that the 2009 *Counting On* program was successful in assisting the learning outcomes of middle years students who struggled with their early mathematics knowledge. The author wishes to acknowledge the support of the New South Wales Department of Education and Training, particularly Peter Gould, Chris Francis and Ray MacArthur of the Curriculum Support Directorate. The opinions expressed in this paper are those of the author and do not necessarily reflect those of the Department.

References

- Beishuizen, M. (1993). Mental strategies and materials or models for addition and subtraction up to 100 in Dutch second grades. *Journal for Research in Mathematics Education*, 24(4), 294-323.
- Cobb, P. & Wheatley, G. (1988). Children's initial understandings of ten. *Focus on Learning Problems in Mathematics*, 10(3), 1-28.
- Cuttance, P. (2001). The impact of teaching on student learning. In K. Kennedy (Ed.), *Beyond the rhetoric: building a teaching profession to support quality teaching* (pp. 35-55). Canberra: ACE.
- Darling-Hammond, L. (2003). *The effects of initial teacher education on teacher quality*. Paper presented at the Australian Council for Educational Research (ACER) Research Conference. Melbourne.
- Ellerton, N. F. & Olson, J. (2005). The assessment dilemma: Correct answers with no understanding and incorrect answers with some understanding. In H. S. Dhindsa, I. J. Kyeleve, O. Chukwu, & J. S. H. Q. Perera (Eds.), *Future directions in science, mathematics and technical education*, (Proceedings of the Tenth International Conference, pp. 226-235). Brunei: University Brunei Darussalam
- Jones, G. A., Thornton, C. A., Putt, I. J., Hill, K. M., Mogill, T. A., Rich, B. S., & van Zoest, L. R. (1996). Multidigit number sense: A framework for instruction and assessment. *Journal for Research in Mathematics Education*, 27(3), 310-336.
- Mulligan, J. (1999). *Evaluation of the pilot Counting On Year 7 numeracy project*. Sydney: NSW Department of Education and Training.
- Newman, M. A. (1977). An analysis of sixth-grade pupils' errors on written mathematical tasks. *Victorian Institute for Educational Research Bulletin*, 39, 31-43.

- Newman, M. A. (1983). *Strategies for diagnosis and remediation*. Sydney: Harcourt, Brace Jovanovich.
- New South Wales Department of Education and Training (NSWDET) (2005). *State Numeracy Plan 2006 – 2008*. Sydney: Author.
- New South Wales Department of Education and Training (NSWDET) (2005b). *State Literacy Plan 2006-2008*. Sydney: NSWDET Curriculum Directorate.
- New South Wales Department of Education and Training (NSWDET) (2008). *Office of Schools Plan 2009-11*. Sydney: NSWDET.
- Perry, B. & Howard, P. (2000). *Evaluation of the impact of the Counting On program: Final Report*. Sydney: NSW Department of Education and Training.
- Perry, B. & Howard, P. (2002a). *Evaluation of the impact of the Counting On program during 2001: Final Report*. Sydney: NSW Department of Education and Training.
- Perry, B. & Howard, P. (2003). *Evaluation of the impact of the Counting On program 2002: Final Report*. Sydney: NSW Department of Education and Training.
- Thomas, N. (1999). Levels of conceptual development in place value. *The pilot Counting On numeracy project*. Sydney: NSW Department of Education and Training.
- Vaiyatvutjamai, P., & Clements, M. A. (2004). Analysing errors made by middle-school students on six linear inequations tasks. In I. P. A. Cheong, H. S. Dhindsa, I. J. Kyeleve, & O. Chukwu (Eds.), *Globalisation trends in Science, Mathematics and technical Education 2004*, (Proceedings of the Ninth International Conference of the Department of Science and Mathematics Education, Universiti Brunei Darussalam, pp. 173-182). Brunei: University Brunei Darussalam.
- White, A. L. (2008). *Counting On: Evaluation of the impact of Counting On 2007 program*. Sydney: Curriculum K-12 Directorate, Department of Education and Training.
- White, A. L. (2009) *Counting On 2008 Final Report*. Sydney: Curriculum K-12 Directorate, Department of Education and Training.
- White, A. L. (in press). *Counting On In The Middle Years 2009: Program Evaluation Report*. Sydney: Curriculum K-12 Directorate, Department of Education and Training.
- Wright, R. J. (1998). An overview of a research-based framework for assessing and teaching early number. In C. Kanes, M. Goos, & E. Warren (Eds.), *Teaching mathematics in new times* (Proceedings of the 21st annual conference of the Mathematics Education Research of Australasia, Gold Coast, pp. 701- 708). Sydney: MERGA.
- Wright, R. J., Martland, J. R., & Stafford, A. (2000). *Early numeracy: Assessment for teaching an intervention*. London: Sage / Paul Chapman Publications.

Modelling the Cooling of Coffee: Insights From a Preliminary Study in Indonesia

Wanty Widjaja
Sanata Dharma University
<wanty_widjaja@yahoo.com >

This paper discusses an attempt to examine pre-service teachers' mathematical modelling skills. A modelling project investigating relationships between temperature and time in the process of cooling of coffee was chosen. The analysis was based on group written reports of the cooling of coffee project and observation of classroom discussion. Findings showed that pre-service teachers were able to model the process of cooling of coffee as a decreasing exponential function. Difficulties with interpretation of the constant rate of cooling and re-interpretation of mathematical model were identified.

Mathematical modelling has gained an increased attention in mathematics education community. Almost two decades ago, Blum (1993) reported that modelling was not yet part of the core mathematics teaching component in most countries. Since then, the situation has been improved. Burkhardt (2006) reported that many countries including Germany, the Netherlands, the United States, and Australia, have taken in a significant portion of mathematical modelling in their mathematics curriculum. Publications on mathematical modelling in various journals (see e.g., Barbosa, 2006; Blum, 2002; Blum, Galbraith, Henn, & Niss, 2007; English & Watters, 2006) have documented the global trends of incorporating more modelling in school mathematics.

The growing interest towards modelling is strongly supported by the Organisation for Economic Cooperation and Development's (OECD) Programme for International Student Assessment (PISA), a major international assessment study which promotes mathematical and scientific literacy. PISA (OECD, 2003) contends that mathematical literacy is "the overarching literacy" (de Lange, 2006, 15) that comprises quantitative literacy, numeracy, and spatial literacy. The OECD definition of mathematical literacy depicts a broader spectrum of what constitutes mathematics as it goes beyond school mathematics curriculum:

Mathematical literacy is an individual's capacity to identify and understand the role that mathematics plays in the world, to make a well-founded judgment, and to engage in mathematics in ways that meet the needs of that individual's current and future life as a constructive, concerned and reflective citizen. (OECD, 2003, p.72)

The close relation between mathematical literacy and mathematical modelling is well documented. Recently, Stacey (2009) noted that mathematical modelling plays the most important part of mathematical literacy. This is consistent with an earlier report by Kaiser and Willander (2005) stating that innovative mathematical modelling projects with realistic contexts resulted in a greater comprehension of mathematical concepts. Furthermore, they proposed the inclusion of modelling and applications in learning mathematics starting as early as primary school level.

Despite the growing interest in mathematical modelling at school level, fewer studies at teacher education level have been documented. Concerns about this trend were voiced by Burkhardt (2006) and Doerr (2007). Both highlighted the importance of preparing pre-service teachers with skills of 'doing mathematics' which requires broader teaching strategies. A profound change of view about what constitute mathematics, the role of



teachers and students is necessary to support modelling in practice. Hence, teacher education plays a crucial role in training future teachers to acquire modelling skills and its pedagogy.

A reform movement to improve mathematics teaching in Indonesia, called PMRI (Ekholm, 2009; Sembiring, Hoogland, & Dolk, 2010), has been put in practice for a decade. Inspired by Freudenthal's notion of 'mathematics as a human activity' (Freudenthal, 1983, 1991), PMRI puts emphasis on mathematics as a meaningful activity that enables learners to grasp real-world phenomena. Consequently, mathematical modelling is an integral element of learning mathematics. Recent studies in PMRI classrooms (Dolk, Widjaja, Zonneveld, & Fauzan, 2010; Widjaja, Fauzan, & Dolk, 2009) suggest the need to support teachers (both pre- and in-service) with skills of 'doing mathematics' and 'modelling mathematics'. This provides a strong impetus to integrate mathematical modelling as part of a course for mathematics pre-service teachers in Indonesia. This paper will discuss preliminary findings from a modelling project to investigate relationships between temperature and time in the cooling of coffee experiment with samples of Indonesian pre-service teachers.

Method

Setting and Participants

This study was situated in a private teacher training institute in Yogyakarta, Indonesia. A modelling project called "The cooling of coffee" (Keng-Cheng, 2009) was translated into Indonesian and assigned to 20 pre-service teachers (see Figure 1). This study aimed to provide pre-service teachers with experience in mathematical modelling. Pre-service teachers' knowledge and difficulties displayed in completing this project will be examined. The design of project also intended to engage pre-service teachers in a productive classroom discourse based on explanations and justifications of their mathematical models. Having a different pedagogical approach was expected to enable pre-service in carrying out modelling project in the future professional life.

Cooling of Coffee Project
How does a cup of hot coffee cool with time? Is it possible to model the cooling of coffee?

1. List factors or variables in the problem.
2. Collect data to help construct a model. Record your data.
3. What is a suitable model? (Look for an existing model to develop one).
4. What is your method of solution?
5. Carry out your solution method and interpret the solution.
6. Examine assumptions and suggest ways to refine the model

Figure 1. The Cooling of Coffee Project (Keng-Cheng, 2009, 36-37).

The cooling of coffee project was chosen because the starting point of this problem was considered 'experientially real' for pre-service teachers. The whole project took four weeks to complete. Pre-service teachers worked in small groups of four people to carry out this project in the first two weeks. The following two weeks were devoted to poster presentations and whole class discussion. Representatives of each group explained their strategies and answered questions from other groups during the poster presentation.

Framework for Analysis

In analysing group written work and posters, a framework of didactical mathematical modelling process by Kaiser and Blum (in Kaiser & Schwartz, 2006, p.197) will be employed. This paper will examine mathematical knowledge that pre-service teachers display and the difficulties they face in completing the project. Pre-service teachers' knowledge and difficulties will be discussed with respect to the two main didactical modelling processes in Figure 2, i.e., mathematisation and reinterpretation of mathematical solutions to the real-life situations.

Figure 2. Didactical modelling process (in Kaiser & Schwartz, 2006, p. 197).

Results and Discussion

In this section, data from written project reports of five groups in completing the Cooling of Coffee project will be analysed. The first four steps of the project (see Figure 1) i.e., identification of factors, data collection, mathematical model formulation, and solving the mathematical model will be considered as the mathematisation process. The process of interpreting solutions, examining assumptions, and refining the model will be considered as the re-interpretation or validation process.

Mathematisation from the Cooling of Coffee Data to the Exponential Decay Function

A list of factors affecting the cooling process by various groups was identified. The factors reflected the real life considerations that pre-service teachers brought prior to the experiment. These factors were then tested during the experiment in cooling the coffee. All groups except Group B identified the room temperature as one of the factors affecting the cooling process. Types of cups (a plastic cup, a ceramic cup, a glass cup, etc.), and size of cups (based on the diameter or height of the cups) were also identified by all groups. Table 1 presents factors that influence the cooling process as identified by different groups and the corresponding ways of collecting data.

A variation in combining different factors was observed, suggesting different assumptions about factors that control the cooling process. For instance, Group C collected data on cooling of coffee using the same cups of different sizes. This group also examined whether types of cups (plastic, glass, and aluminium) have different cooling rates. Group D and Group E went further to explore different mixes of substances they put in their coffee. These groups collected data for coffee without sugar or with sugar using different types of cups (plastic, glass, ceramic). The factors identified by different groups were based on assumptions of daily life experiences. However, it was unclear how the combination of different factors translated to the mathematical model. Figure 3 provides illustrations of some of the data collection process to construct the mathematical model.

Table 1

Factors Affecting Cooling Processes and Data Collection Methods

Group	Factors in the cooling of coffee	Ways of collecting data
-------	----------------------------------	-------------------------

A	<ul style="list-style-type: none"> - room temperature - types of cups (plastic or glass) - size of cups. 	Collect data every minute until the coffee reaches around 40° Celsius.
B	<ul style="list-style-type: none"> - types of cups (plastic or ceramic) - size of cups 	Collect data every minute until the temperature of coffee reaches around 35-39° Celsius. The data collected twice to find the average of temperature collected of 2 experiments.
C	<ul style="list-style-type: none"> - types of cups (plastic or glass) - size of cups - room temperature 	Collect data every 3 minutes until the coffee reaches around 30° Celsius (room temperature).
D	<ul style="list-style-type: none"> - types of cups (plastic, aluminium, glass, ceramic) - size of cups - room temperature - initial temperature 	Collect data every 5 minutes until the temperature of coffee reaches around 26-30° Celsius (room temperature).
E	<ul style="list-style-type: none"> - types of cups (plastic, ceramic, glass, etc.) - size of cups - ingredients (coffee only; coffee and sugar; coffee, sugar and milk) - room temperature 	Collect data every 5 minutes until the temperature reaches around 30° Celsius (room temperature).

In general two ‘benchmarks’ were observed in ways of collecting data, namely temperature and time for cooling a cup of boiling coffee. Four groups considered temperature as a criterion for cooling of coffee. As seen in Table 1, three groups (C, D, and E) used room temperature (i.e., 30° Celsius) as a benchmark temperature for cooling off coffee whereas Group A selected 40° Celsius as the ‘cool’ temperature for coffee. It was unclear whether 40° Celsius was the actual room temperature when Group A collected their data. In contrast, Group B used a length of time (i.e., 60 minutes) to derive a mathematical model and to determine the rates of cooling under different circumstances. This choice led ultimately to different temperatures of coffee for different types of cups. Interestingly, in comparing different rates of cooling for different cups, Group B calculated differences between the initial temperature and the temperature after 60 minutes of the cooling process began.





Figure 3. Data collection processes in Cooling of Coffee project

All five groups were able to relate the mathematical model of cooling of a cup of hot coffee to an exponential decay function. They derived their mathematical model first by plotting their data into a Microsoft *Excel* spreadsheet. By observing the plots of the data, all groups noticed that a decreasing exponential function was the best mathematical model to fit this set of data. Hence, all groups found a model of exponential decay that could explain the cooling of coffee process. Samples of group posters and the interaction during poster presentation are presented in Figure 4.



Figure 4. Samples of group poster and interaction in The Cooling of Coffee project.

Explanations in deriving mathematical models showed difficulties in understanding and interpreting the rate of cooling. In this case, the rate of cooling was represented by the value of k in general function of $T(t) = A.e^{-k.t}$. Of the five groups, only three groups provided reasonable explanations for deriving the mathematical model and interpreting the value of k . Two groups (Group D and Group E) utilized the trend line tool to approximate the exponential functions that best represented their data. However, in deriving the value of k , these groups started with the general function $y=A.e^{-k.t}$ and calculated an average of initial temperature for different types of cups and an average of temperature at a particular time. This approach contradicted earlier efforts to find different mathematical models in different experiments. Calculating averages for various cups under different circumstances indicated lack of meaningful interpretation of k . In contrast, the other three groups worked out the mathematical model by relating the temperature changes over time to the ‘rate of change’ notion. Group A, and B expressed this as $\frac{\Delta y}{\Delta t} = \frac{y_{t+\Delta t} - y_t}{\Delta t} = k.y$. However

they did not take into account the decreased temperature in their equation, expressing $\lim_{\Delta t \rightarrow 0} \frac{\Delta y}{\Delta t} = \frac{dy}{dt} = k \cdot y$ or $\frac{dy}{dt} = k \cdot y$ instead of $\frac{dy}{dt} = -k \cdot y$. Using integration, the function of $y(t) = y_0 \cdot e^{k \cdot t}$ was obtained. The negative value of k was determined later after working with the data. Similarly group C also did not express decreased temperature change over time in the mathematical model. This group was the only group that showed not only knowledge about the rate of change notion but also knowledge of physics by referring to Newton's Law of Cooling. Using this law, the rate of change of the temperature of an object is directly proportional to the difference between the object's temperature and the room temperature. Hence this group represented the change of temperature over time as $dT/dt = k(T - 30)$ which led to the mathematical function $T_{(t)} = (T_0 - 30)e^{k \cdot t} + 30$. In this function, k represents the rate of cooling process, T_0 represents the temperature of boiling coffee, t represents the time and $T_{(t)}$ represents the temperature of coffee after the cooling process going on for t .

Re-interpreting the Exponential Decay Function Back to the Data

In examining their assumptions, all groups reviewed the role of factors, which were identified at the beginning of the project. By observing the graphs of experiments carried out in 26° Celsius and 29° Celsius at the same time, a conclusion about the impact of room temperature was drawn. It was noted that when room temperature is higher, the coffee takes a longer time to cool. The influence of types of cups (plastic, glass, ceramic) in the cooling process of was also recorded. It was found that a cup of coffee made of glass took longer time to cool of compared to the same cup made of plastic. Size of cups also affected the rate of cooling. A cup with larger base area took shorter time to cool as compared to a cup with a smaller base area for the same height. Group D and Group E experimented with different mix of substances. Group D found no difference in trends of cooling of coffee using four different cups with or without sugar. They concluded that a cup of coffee made of aluminium cools the fastest in both conditions. However, this conclusion should be considered cautiously. It turned out that in carrying out the experiment, containing sugar was not the only different factors in the experiment. The Group also used different types of cups with varying sizes so it was difficult to pinpoint which factors were the 'control variables'.

A reasonable interpretation for the value of k was articulated by Group B. This group observed that the value of k was a constant. Note that Group B formulated the mathematical model as $T_{(t)} = (T_0 - 30)e^{k \cdot t} + 30$, hence they found negative value for k . Furthermore "as k gets smaller, the coffee cools faster", indicates a sensible interpretation of k as the constant rate of cooling. In addition, Group B noticed that the temperature of coffee was close to the room temperature at the end of the cooling process. The fact that only one out of five groups was able to articulate a sensible interpretation of k suggested that re-interpretation of a mathematical model is a challenging part of the modelling process.

Similarly, refining the mathematical model was found to be difficult for the students in this study. Ideas for refinement were limited to general limitations of the current mathematical model related to technical aspects of data collection. Lack of accuracy in reading the temperature and calculation error caused by rounding were offered as explanations for discrepancies of temperature based on mathematical model and the real data. All groups only proposed increasing the number of experiments to refine their mathematical model.

Concluding Remarks

This study sought to enhance pre-service teachers' modelling skills in a project to investigate the cooling of coffee. Analysis of written reports of the project indicated that pre-service teachers in this study were able to obtain a decay exponential function as a model for the cooling of coffee. Relevant factors affecting the process of cooling including room temperature, types and size of cups were identified. However, pre-service teachers did not attend to the complexities of combining different factors (e.g., sizes of cups, types of cups) in mathematical models.

Evidence in this study showed that re-interpreting and linking variables in the mathematical model back to the real-world data was problematic. Difficulties with interpreting the meaning of the constant rate of cooling (k) and incorporating room temperature into the mathematical equation were observed. Sound mathematical knowledge of calculus and functions is essential to support rich mathematical discussion in modelling cooling of coffee. Findings from this preliminary study indicated that a modelling project is a rich learning tool for pre-service teachers to 'do mathematics' and to 'see mathematics' in daily life.

References

- Barbosa, J. C. (2006). Mathematical modelling in classroom: A socio-critical and discursive perspective *Zentralblatt für Didaktik der Mathematik*, 38(3), 293-301.
- Blum, W. (1993). Mathematical modelling in mathematics education and instruction In T. Breiteig, I. Huntley & G. Daiser-Messmer (Eds.), *Teaching and Learning Mathematics in Context* (pp. 3-14). Chichester: Ellis Horwood Limited.
- Blum, W. (2002). Applications and modelling in mathematics education: Discussion document. *Educational Studies in Mathematics*, 51(1/2), 149-171.
- Blum, W., Galbraith, P. L., Henn, H.-W., & Niss, M. (2007). *Modelling and applications in mathematics education*. New York Springer
- Burkhardt, H. (2006). Modelling in mathematics classrooms: Reflections on past development and the future. *Zentralblatt für Didaktik der Mathematik*, 38(2), 178-195.
- de Lange, J. (2006). Mathematical literacy for living from OECD-PISA perspective *Tsukuba Journal of Educational Study in Mathematics*, 25(13-35).
- Dolk, M., Widjaja, W., Zonneveld, E., & Fauzan, A. (2010). Examining teacher's role in relation to their beliefs and expectations about students' thinking in design research In R. K. Sembiring, K. Hoogland & M. Dolk (Eds.), *A decade of PMRI in Indonesia* (pp. 175-187). Bandung, Utrecht: APS International.
- Ekholm, M., & van den Hoven, G. H. . (2009). *PMRI - Majulah!* Naarden: Zet&Print.
- English, L., & Watters, J. (2006). Mathematical modelling in the early school years *Mathematics Education Research Journal*, 16(3), 59-80.
- Freudenthal, H. (1983). *Didactical phenomenology of mathematical structures*. Dordrecht: D. Reidel Publishing Company.
- Freudenthal, H. (1991). *Revisiting mathematics education, China lectures*. Dordrecht: Kluwer Academic Publishers.
- Kaiser, G., & Schwartz, B. (2006). Mathematical modelling as a bridge between school and university. *Zentralblatt für Didaktik der Mathematik*, 38(2), 196-208.
- Kaiser, G., & Willander, T. (2005). Development of mathematical literacy: Results of an empirical study. *Teaching Mathematics and Its Applications*, 24(2-3), 48-60.
- Keng-Cheng, A. (2009). *Mathematical modelling in the secondary and junior college classroom*. Singapore: Prentice Hall.
- Organisation for Economic Cooperation and Development. (2003). *The PISA 2003 assessment framework – mathematics, reading, science and problem solving knowledge and skills*. Paris: OECD.
- Sembiring, R. K., Hoogland, K., & Dolk, M. (2010). *A decade of PMRI in Indonesia*. Utrecht: Ten Brink.

- Stacey, K. (2009). Mathematical and scientific literacy around the world. In U. H. Cheah, Wahyudi, R. B. Devadson, K. H. Ng, W. Preechaporn & J. C. Aligaen (Eds.), *Proceedings of the 3rd International Conference on Science and Mathematics*. (pp. 1-7). Penang: SEAMEO RECSAM.
- Widjaja, W., Fauzan, A., & Dolk, M. (2009). The role of contexts and teachers' questioning to enhance students' thinking. In U.H. Cheah, Wahyudi, R.B. Devadson, K.H. Ng, W. Preechaporn & J. C. Aligaen (Eds.), *Proceedings of the 3rd International Conference on Science and Mathematics*. (pp. 466-474). Penang: SEAMEO RECSAM.

Abstracting by Constructing and Revising a ‘Partially Correct Construct’: A Case Study

Gaye Williams

Deakin University

<gaye.williams@deakin.edu.au>

This study draws on data from a broader video-stimulated interview study of the role of optimism in collaborative problem solving. It examines the activity of a Grade 5 student, Tom, whose initial constructing activity resulted in a ‘Partially Correct Construct’. Insistent questioning from another group member pressuring for clarification led to Tom developing a ‘more correct construct’ with further potential for revision. This paper raises questions about influences that can stimulate or inhibit construct refinement.

As early as the nineteen-seventies, researchers had begun to focus on the development of deep mathematical understanding (Krutetskii, 1976 in Williams, 2007a), and the need for teaching more than just rules and procedures to enable this to occur (Skemp, 1976). It was soon recognised that working with unfamiliar challenging problems and discussing ideas with other students (Wood & Yackel, 1990) supported the development of these deep understandings. This study examines how a student working with an unfamiliar challenging problem in a classroom in which student-student interactions were encouraged refined their understandings over time, and the influences that supported this change.

Theoretical Framework

The ‘abstracting’ of new knowledge can occur when a student or group of students interact to explore a mathematical complexity that was not evident to them at the commencement of a problem solving task, and they spontaneously decide to explore it (Williams, 2007a, 2007b). Abstracting involves student/s creatively ‘building-with (B)’ (Dreyfus, Hershkowitz, & Schwarz, 2001) previously known ideas after ‘recognizing (R)’ their relevance. Through synthesis they illuminate something mathematically profound. This is a process of ‘constructing (C)’ new knowledge. During the process of abstracting new knowledge, which includes processes R, B and C, students ‘consolidate’ (Co) their understandings. This involves recognising this knowledge in other contexts, and using it more flexibly. Abstracting in context (Schwarz, Dreyfus, & Hershkowitz, 2009) includes the following activities:

‘Reorganisation within mathematics, ... finding shortcuts and discovering connections between concepts and strategies (pp. 17)

‘Explanations underwent a transformation that appeared to support ... reaching a mathematically valuable understanding’ (pp. 16).

Prior constructs ... are ... reorganised ... [and] ideally, ... also integrated and interwoven (pp. 17).

Key: ‘...’ text omitted without change meaning; ‘[Text]’ Elaboration of researcher.

In other words, students during the process of abstracting can assemble mathematics they recognize (R) as useful for a given purpose, find new ways to combine this mathematics (novel B), consolidate (Co) their new understandings during the process of using them for further exploration, and integrate mathematical ideas they develop to gain mathematical insights (‘constructing’, C) (e.g., Williams, 2007a; 2007b).



The Engaged to Learn pedagogical approach (Williams, 2007b) used in this study is expected to provide opportunities for students to develop deep understanding. It is based on students working together on ‘conceptual tasks’ (Lampert, 2001) at small group and whole class level. Study of students’ learning through this approach has shown it does elicit frequent creative activity during the development of new conceptual understandings (see for example, Barnes, 2000). The strength of the Engaged to Learn Model lies in the accessibility of the tasks through a variety of mathematical pathways, and the enabling of group autonomy to control the difficulty of the mathematics they choose to explore; within a teacher-set focus. Different groups tend to approach the task in a variety of ways.

The process of abstracting has been found to begin with the formation of an amorphous entity that gradually gains internal and external structure during mathematical exploration (Hershkowitz, Schwarz, & Dreyfus, 2001; Williams, 2007a). The construction of ‘Partially Correct Constructs’ (PaCCs) as part of the abstracting process has recently been a focus of attention. These PaCCs are students’ ‘knowledge construct[s] that only partially matches a mathematical knowledge element that underlies the learning context’ (Ron, Dreyfus, & Hershkowitz, 2009, p. 1). PaCCs may develop through students not recognizing boundary conditions within which the new construct is relevant. This study extends that focus by examining how a PaCC changed over time, and what influenced the change to a ‘more correct construct’?

Research Design

This section includes the task, the context in which it was implemented, and the data collection instruments and why they were appropriate to this study.

The Fours Task

Use four of the digit 4, and any number of the following

$$+ \quad + \quad - \quad - \quad \times \quad \div \quad / \quad () \quad \sqrt{\quad} \quad 2 \quad .$$

to make each of the whole numbers from 1-20.

Then look for ways to find them all as fast as you can. Explain.

This was the third task in a sequence of three tasks undertaken across the school year in an upper elementary school classroom in Melbourne. The task was undertaken in one eighty-minute session. The researcher implemented the tasks and team taught with the teacher. Both intended to ask questions to help students to clarify their ideas, and extend their thinking, but not to direct, affirm, or query the pathways students took, nor provide mathematical input during student work with the task. This was for the purpose of enabling student autonomy. It is not always easy to achieve as this study shows.

What makes this task complex, and likely to lead to the creative development of new mathematical ideas, is that groups are asked to do more than find answers. They are asked to think about, and report on, thought processes they used as they tried to find integers, and to develop systems to find multiple answers. They were also encouraged to develop ‘big ideas’ to help find integers fast. Students undertook the task individually for the first three minutes, and then shared their ideas with other group members as a start to group work on the task. Table 1 shows the cyclic nature of the lesson structure [Column 2] within the Engaged to Learn approach. Intervals are described in Column 3. The majority of the time was spent on group reporting [Column 1]. After Alf’s report [Interval 5], Tom’s ideas

began to develop [Column 3, Interval 5]. He refined them when Gabrielle persistently required further explanation and specific examples [Column 3, Intervals 7].

Table 1

Activity During Fours Task, Time on Each Activity, and Change in Tom's Understandings

Time	Interval No. / Title	Interval Description
9 Mins	1. Task Introduction	Find all the whole numbers from 1-20 using a restricted number of the digit four and given operations.
3 Mins	2. Individual Work	Students worked silently for three minutes starting task.
8 Mins	3. First Group Brain-storming	Shared ideas, found more numbers, thought about processes used, looked for fast ways
4 Mins	4. First Priming of Reporter	Group decided what to share. Reporter communicated this to group who refined the report.
30 Mins	5. First Group Reports to Class	Reports (1-2 Mins) included: something causing difficulty, specific examples, and / or strategies used. Alf's report provided cognitive artifact for Tom.
3 Mins	6. Refocusing Groups	The Researcher-Teacher (RT) refocused groups on thought processes, elegance, ways to generate numbers, and identifying big ideas to develop strategies.
5 Mins	7. Second Group Brainstorming	T spent some time directing Tom's group. Gabrielle then pressured Tom for explanations/ specific examples.
4.5 Mins	8. Second Priming of Reporter	Tom, as reporter communicated his intended report to his group, consolidated his understandings, and progressed towards a 'more correct construct'.
16.5 Mins	9. Second Reports	Tom reported explicitly about changed in understanding

The composition of Tom's group was decided upon by the RT who had opportunity to analyse video of students working in groups on the previous two tasks. Groups contained 3-4 students with similar paces of thinking, and a student who was likely to be able to keep their group on task and encourage all students to participate (Gabrielle in Tom's group). Tom was interviewed after the Fours Task.

Classroom video and video stimulated post-lesson student interviews were employed to study the process of creative development of new knowledge. Four video cameras were used to capture the six groups and the reporting sessions. There were audio leads from each group. The videos were mixed as 'two ups' so Tom could simultaneously see the activity in his group, and the reports at the board. Tom controlled the drag function on the video to select the intervals in the lesson that he wanted to view and discuss. This video stimulus assisted Tom to reconstruct his thinking in class, what influenced this thinking, and how he was feeling during these intervals. Tom's expressed feelings of high positive affect were used to help identify a situation in which he gained new insight (Barnes, 2000). These two data sources together provided a chronology of changes to Tom's conceptual understanding, and progressive influences upon it.

Results and Analysis

In Interval 3 (see Table 1), Tom built with his previous knowledge as he used trial and error (B) to find an integer '... eight, four plus four minus four plus four ...' (16:05), and then consolidated his recall of the plus 4 minus 4 sequence by using it again several times

(B, Co) in similar contexts ‘... Four times four, plus four minus four, is 16!! Got it!’ (19:18), ‘Four times four plus four minus four’ (19:55), and ‘Four times four is sixteen, minus four is twelve. Plus four is sixteen. I made sixteen!’ (20:23). Tom gave no indication that he was aware he was using a similar structure in each of these expressions. He made the same integer twice (16) and seemed equally surprised each time. He recognised (R) traces of B in another context when Helen used the same type of structure with the +4 and -4 in the opposite order ‘That's just what I did in a different order’ (29:35). Even with this consolidation, unlike some other students working on this task (e.g., see Williams, 2007b), he did not appear to recognise $-4+4$ and $+4-4$ as a mathematical object ‘zero’ nor that the two operations on the same digit cancelled each other out.

Tables 1 and 2 include the visual image of the process of construction, and social influences upon it developed by Dreyfus, Hershkowitz, and Schwarz (2001). It includes the time, and transcript line number in the lesson [Column 1], the ‘observable cognitive elements’ of the process of abstracting for Tom (R, B, C, Co) that Tom was undertaking at that time [Column 2], and social influences on this process [Column 3]. It also includes a summary of transcript excerpts [Table 2, Column 4] or the transcript excerpts [Table 3]. Table 2 shows activity during the first reporting session and second group work session [Interval 5, Interval 7, Table 1] that was relevant to Tom’s exploratory activity. The transcript for Table 2 is presented below:

238. [36:22] Zeb [To class] ... four plus four is eight ... four divided by four is one ... plus them together because there is a plus between four plus four and four divided by four.
279. [46:29] Alf [To class] ... seventeen ... we did four times four to get sixteen but we needed one more ... we had two extra fours ... then we did four times four plus ... four over four ... so it would be like saying four times four plus one ...
283. [47:41] Alf [To class] Umm, well four over four is one whole, so that is just like saying one, and four times four plus one you get seventeen.
341. [1:01:03] Tom [to group] ... we need ... a strategy to figure out every single one ... it could be ... like what Alf and Ken's group did because four over four... one could come in handy for everything that is a not multiple of four- so ... from sixteen you need one to get to seventeen ... umm- something minus four over four to get to fifteen.
344. [1:01:09] Teacher (T) [to Tom] ... maybe do you want to give an example, do you think that would be better?
345. [1:01:42] Tom [to T] Maybe.
346. [1:01:53] T Sounds good to me- you might just want to give an example- sometimes examples really help yeah?
347. [1:01:58] Tom: so I think you could go- I don't know if you could count that as one [Alf's one]- to make that into a minus of that - so to get to sixteen, you go four times four umm. Err, oh yeah! Then you could go minus four over four, and yeah that is fifteen.
348. [1:02:35] T So that was one part of your argument. What was the second part of it?
- 348a. Tom [Looks unsure]
350. [1:03:04] T So- which ones [multiples]? Is this four over four going to work for?
351. [1:03:09] Tom Oh, I don't think it does. Because it is either one more or one less than.
352. [1:03:16] T: [Helen yawns] Okay, I'm just getting the impression from your three partners that body language anyhow- that they are not fully following you. So you might have to try some examples.

Table 2

Tom's Social and Cognitive Activity Associated with New Ideas He Started to Develop

Line/Time	C	B	R	Co	Tom	A	Z	T	Description of Transcript
L238 36:22									Zeb reports to class using four on four as one in specific case
L279 46:49	■	■							Alf reports to class identifying four over four as a mathematical object (one) added to sixteen
L283 47:41				√					Alf reinforces what he has just said
L341 1:01:03	■	■	P						Tom extends Alf's idea to using plus or minus one as a stem following a multiple of four
L344 1:01:48									Teacher (T) suggests Tom give an example
L345 1:01:52									Tom's response suggests this is not what he wanted to do
L346 1:01:53									T affirms Tom's direction and again suggests example
L347 1:01:58				√					Tom explains his ideas the same way again without further examples
L348 1:02:35									T asks for the second part of Tom's argument which he has not elaborated yet
L348a									Tom looks unsure
L350 1:03:04									T: "So, which ones? Is this four over four going to work for?"
L351 1:03:09			■						Tom: "Oh, I don't think it does. Because it is either one more or one less than"
L352 1:03:16									T draws attention to the lack of engagement of other group members and again requests examples.

Key: R: Recognizing, B: Building-with, C: Constructing, Co; Consolidating; P, Partially correct recognising
 A: Agreement, Q: Query, El: Elaboration, Ex: Explanation, C: Control, At; Attention

Tom did not recognize the relevance of Zab's report [Table 2, Transcript Line 238] but Tom recognized the usefulness of 4/4 in Alf's report. Tom excitedly gestured by twirling his hand around in the air during the interview as he explained:

... when he [Alf] said four over four and it is the same as one just that sentence just flung me like quickly in my mind: ahhh I could use that.

Why did Tom recognize the relevance of Alf's report and not Zab's? Was it because Alf was considered to be outstanding at mathematics by the class and the teacher? Or was it because Zab reported B where Alf reported as a 'big idea' or newly constructed object: that 4/4 could be used as one [Table 2, Transcript Lines 279, 283]. Or was it some combination of these possibilities? Tom began to develop a system for finding multiple integers by using Alf's new entity [Table 2, Transcript Line 351]. His insight: he could use plus or minus 4/4 after a 'stem' made using the other two digit 4s. This was the correct part of his Partially Correct Construct. He thought the stem would be any multiple of four between 1 and 20. This was the part that was not yet correct. Tom knew the plus or minus 4/4 would give the integer on either side of the stem made with the other two fours, but not that it was not possible to make all multiples of four between 1 and 20 using the + 4 - 4 sequence he had consolidated during the first group work session (described earlier). His initial thinking that he would be able to do so became apparent in his interview:

I tried that one [making 12] just at the last minute as I was walking up [to report] ... you would have to do four plus four plus four to equal 12 and then you can't do four plus four because that has two fours in it so that is five fours which is three fours which gives 5 fours in all

Tom had begun to realise that it was not necessarily easy to make multiples of four using two of the digit four but had not yet realised 12 and some other integers could be made in other ways using two of the digit four (without the + 4 – 4 sequence).

Thus, there is potential for Tom to extend his construct in relation to possible stems. At present, the boundaries for what is possible using his 'more correct construct' are too narrow. Tom knew the plus or minus 4/4 would give the integer on either side of the stem made with the other two fours, but not that it was not possible to make all multiples of four between 1 and 20 using the + 4 – 4 sequence he had consolidated during the first group work session (described earlier). His initial thinking that he would be able to do so became apparent in his interview:

I tried that one [making 12] just at the last minute as I was walking up [to report] ... you would have to do four plus four plus four to equal 12 and then you can't do four plus four because that has two fours in it so that is five fours which is three fours which gives 5 fours in all

Tom had begun to realise that it was not necessarily easy to make multiples of four using two of the digit four but had not yet realised 12 and some other integers could be made in other ways using two of the digit four (without the + 4 – 4 sequence).

At Line 344 in Table 2, Tom's constructing process was interrupted before he had time to think further about whether all multiples of 4 could be built (B) as stems. Table 2 shows the absence of further constructing by Tom [see Table 2, Column 2] as he responded to the teacher questions that controlled what he thought about. This is also represented by the absence of arrows pointing back to Tom's previous responses as part of what influenced his later responses. Once the teacher observed and commented on the disinterested body language of the other group members [Table 2, Transcript Line 352], the teacher encouraged the students to interact by requesting Gabrielle prove Tom's theory [Table 3, Transcript Line 355]. With the teacher having validated Tom's idea, and the rest of the group now paying attention, Tom reiterated his theory several times in different ways without justifying why he considered multiples of four could be made as the stem each time [Fig. 2. Transcript Lines 353, 357, 364].

Table 3 shows the social elements of the interaction changed significantly once the teacher left and Gabrielle began to pressure insistently (or query, Q) for explanation of why Tom considered multiple of four could be made: 'How? How? How?' [Table 3, Transcript Line 360]. The arrows point back from Tom's responses to Gabrielle's queries and to Tom's own previous responses showing Tom was progressively building on his previous thinking. Column 2 shows where Tom's thinking involved R B and C thus representing the new constructs developing. When Tom kept elaborating (El) on the correct part of his construct (**B**, **Co**), rather than explain why he considered he could make multiple of four in the stem (**C**, idea not yet fully developed), Gabrielle focused her queries more directly on the aspect of Tom's ideas she did not understand: 'Use the four and four' [Line 363]. Gabrielle wanted to know why Tom thought he could make all multiples of four using two of the digit four. When Tom continued focusing on the plus or minus 4/4, Gabrielle pressed for specific examples of how each number could be made [Line 365]. It was this insistent 'querying' to get further explanation that led to Tom finally realising he could not make 12 in the way he had expected he would be able to (see quote above).

Table 3

Gabrielle's Intense Query: Tom Elaborates, Further Explains, Realises and Corrects Ideas

Line/Time	Cognitive Elements				Social Elements			Excerpts of transcript associated with Tom's progress from partially incorrect to more correct construct
	C	B	R	Co	Tom	Gabrielle	T	
Line 352 1:03:16								T: [Helen yawns] Okay, I'm just getting the impression from your three partners that body language anyhow, that they are not fully following you. So you might have to try some examples.
Line 353. 01:03:27	P							Tom: [Group listen, Helen fiddles] So for four you can get 3 and 5- using four over four- and for eight you can get 6 and 7- for 12 you can get 13 and 11- for 16 you can get 15 and 17- and for 20- you can get 19
Line 355 1:03:50						EI		T: Yeah- come on Gabrielle- so get started- he has got a pretty good theory- and now you'll have to prove it.
Line 357 1:03:58			P					Tom: [7 secs] [Recording numbers] And then there are all of these ones- Four- Eight- Twelve- Sixteen- Twenty. [Looks up at group] Guys?
Line 358 1:04:29						EI		Gabrielle: [No response from group. Gabrielle and Tom stare at each other.] (...) go over it and tell
Line 360 1:04:33						EI	Q	Gabrielle: [Takes pencil from Tom, shifts sheet to middle of table, and taps pencil on page as speaks] <i>How? How? How?</i> [group lean in towards page as she speaks]
Line 363. 1:04:40							Q	Gabrielle: [Tapped finger on page requesting more about how the stem works] Use the four and four.
Line 364 1:04:41			P	√			Q	Tom: Using four over four- that means one ... four quarters is one ... or a whole- so that means that using a whole- you can either go minus four over four- which means one- so minus one- or plus one- so we did that- and these are all multiples of four- 18, 12, 8, 4. And then using minus four over four- or plus four over four- you can get these numbers- 17, 15, 13, 11, 7, 6, 5, 4, 3
Line 365 1:05:21						EI		Gabrielle: [Takes pencil and paper] Hang on- so if ... somebody asked you to make- to give answers to every single number- ones that you could possibly get with using a whole
Line 375 1:07:25				√ P			Q	Tom: [practising during priming reporter time] Er, okay. Alf and Ken said- that using four over four- as they said was one- so using minus that- which would be the same minus one- and also plus one- you can get anything which is in a range of one number of multiples of four. So if it was 12- the numbers are like 11 and 13. And using four over four you can get okay, umm
Line 377 378 390 1:08:20								Tom: [writing on Gabrielle's table in priming time] So an example would be four times four minus four over four- which would be fifteen- so four times four is sixteen, and minus- that is just like saying minus one- so that is fifteen. But, if you use- if you are going to do like twelve- you won't be able to do it- because four plus four- plus four is one of the only ways to get to twelve ... so the only one you can do it for is sixteen ... oh unless you do the eight- so four plus four- yeah, so for eight- so four plus four is eight- minus four over four

Key: As for Table 2

Discussion and Conclusions

After developing a PaCC by starting to see an elegant ‘short cut’ that used the structure of the expressions he made to make more than one integer, Tom’s ‘[e]xplanations underwent a transformation that appeared to support ... reaching a mathematically valuable understanding’ (pp. 16, see previously). Gabrielle’s persistence in getting Tom to explain the part she was not understanding (the incorrect part of the PaCC) led to Tom revising his construct to one which was no longer incorrect but did not yet show recognition of the potential for other stems. Tom had boundaries for the use of his construct that were narrower than what was possible. There were some other multiples of four he could build, and there could be other possibilities that were not multiples of four.

An interesting question that remains is the role played by the teacher intervention. Did the teacher legitimise what Tom was doing to the extent that the rest of his group were prepared to listen to him? Or did the teacher’s intervention (that eliminated autonomous thinking) interrupt Tom’s constructing and delay him gaining his group’s attention? Did the teachers comment to Gabrielle [Table 3, Line 355] lead to her insistent questioning of Tom? Or would this have occurred anyway? Previous interactions of Gabrielle’s in other groups would suggest this type of questioning was part of her usual interactions. Further case studies are needed to learn more about PaCCs and whether they change over time to become more correct constructs, and what influences these changes. The present study shows such changes can occur, and aspects of the Engaged to Learn approach can facilitate such change: the group interactions helped to highlight what was not yet justified, and the reporting process contributed cognitive artefacts and helped to crystallise understandings.

Acknowledgements

Research funded by the Australian Research Council Grant DP0986955 and hosted by the International Centre for Classroom Research at the University of Melbourne.

References

- Barnes, M. (2000). "Magical Moments" in Mathematics: insights into the process of coming to know. *For the Learning of Mathematics*, 20(1), 33-43.
- Dreyfus, T., Hershkowitz, R., & Schwarz, B. (2001). The construction of abstract knowledge in interaction. In M. van den Heuvel-Panhuizen (Ed.), *Proceedings of the 25th conference of the International Group for the Psychology of Mathematics Education* (Vol. 2, pp. 377-384). Utrecht, The Netherlands: PME.
- Lampert, M. (2001). *Teaching problems and the problems of teaching*. New Haven, CT: Yale University
- Ron, G., Dreyfus, T., & Hershkowitz, R. (2009). On students’ sensitivity to context boundaries. In Tzekaki, M., Kaldrimidou, M., & Sakonidis, H. (Eds.). *Proceedings of 33rd conference of the International Group for the Psychology of Mathematics*, (Vol. 5, pp. 1-8). Thessaloniki, Greece: PME.
- Schwarz, B., Dreyfus, T., & Hershkowitz, R. (2009). The nested epistemic actions model for abstraction in context. In B. Schwarz, T. Dreyfus, & R. Hershkowitz (Eds.). *Transformation of knowledge through classroom interaction*. (pp. 11-41). New York: Routledge.
- Skemp, R. (1976). Relational understanding and instrumental understanding. *Mathematics Teaching*, 77, 20-26.
- Williams, G. (2007a). Abstracting in the context of spontaneous learning. In M. Mitchelmore & P. White (Eds.). Abstraction, Special Edition, *Mathematics Education Research Journal*, 19(2), 69-88.
- Williams, G. (2007b). Classroom teaching experiment: Eliciting creative mathematical thinking. In J. Woo, H. Lew, K. Park, & D. Seo (Eds.). *Proceedings of the 31st conference of the International Group for the Psychology of Mathematics Education* (Vol. 4, pp. 257-364). Seoul, Korea: PME.
- Wood, T., & Yackel, E. (1990). The development of collaborative dialogue within small group interactions. In L. Steffe & T. Wood (Eds.), *Transforming children's mathematics education: International perspectives* (pp. 244-252). Hillsdale, NJ: Lawrence Erlbaum.

Pre-service Teachers Constructing Positive Mathematical Identities: Positing a Grounded Theory Approach

Sue Wilson
Australian Catholic University
sue.wilson@acu.edu.au

Mathematics anxiety in pre-service primary teachers is an important issue in teacher education. This leads to the question of how pre-service primary teachers with mathematics anxiety perceive their mathematical identities. The paper explores the potential to develop a research-based model to identify the process whereby pre-service primary teachers with mathematics anxiety could develop more positive identities as learners and potential teachers of mathematics. It indicates emerging themes from previous research using subsequent preliminary data analysis and argues that a grounded theory approach to building a theoretical model for this process would make a valuable contribution to teacher education.

If the artist does not perfect a new vision in his process of doing, he acts mechanically and repeats some old model fixed like a blueprint in his mind.

John Dewey

Mathematics anxiety in pre-service primary teachers has been identified as an important issue, with significant impact on teacher preparation. Although extensive research has been done to identify the causes of mathematics anxiety in pre-service teachers, more research in addressing this issue would add to the repertoire of strategies available to teacher educators. Reviews of the literature underpinning the concepts of mathematics anxiety and bibliotherapy have been published in previous research papers, (Wilson & Thornton, 2006; Wilson, 2007, 2009). There is evidence that the repercussions are broader than effects on learning mathematics. Research using 156 pre-service teachers found significant negative relationships between mathematics anxiety and mathematics teacher efficacy (Gresham, 2008). In addition, Utley, Bryant and Moseley (2005) found that mathematics and science efficacy in pre-service teachers are directly related.

In considering ways to progress research on the challenge of primary teacher preparation of students with mathematics anxiety, the researcher proposes a new initiative. The following overarching questions emerge from previous findings: What are the factors that could lead primary pre-service teachers with mathematics anxiety to develop a more positive identity as a learner and teacher of mathematics? What research-based framework can be developed to describe the process by which pre-service teachers with mathematics anxiety achieve a more positive identity? The goal of the proposed research is to develop a replicable research-based explanatory framework that will identify practices in an initial teacher preparation program that positively influence this identity development. This theoretical model will inform the repertoire of strategies for teacher preparation and contribute substantially to teacher education programs.

Grounded theory (Glaser & Strauss, 1967) is “a general methodology for developing theory that is grounded in data systematically gathered and analysed” (Strauss & Corbin, 1994, p. 273). It is a research method that allows for theory to be generated through comparisons among data sources. It presupposes that the issue may be illuminated by the accounts of people in the area of enquiry. It allows a theoretical model of the process to be developed, and extended as patterns are extracted from empirical observations of data.



Grounded theory requires repetition of the method, sampling and coding participants' experiences until no further concepts emerge. There are differences in approaches to grounded theory. Lehmann (2001, p. 9) has suggested that the Straussian approach is more useful for studies of individuals.

This paper revisits the analysis of previous research, using a grounded theory perspective, and proposes the next stage of the research should focus on the development of a theoretical framework. It provides background to the proposed research including the grounded theory process of building a framework and a perspective on the data progress so far. Finally the paper provides a provisional framework that will underpin the next phase of the research.

Previous Research

Research at two metropolitan universities found that using readings with an explicit focus on school students' learning difficulties in mathematics provided a powerful additional element in addressing some of the well-documented anxiety felt by many pre-service primary teachers.

In the initial research project, data was collected through critical incident methodology and written reflections, followed by focus group discussions, and analysed using qualitative methodologies. The research team did not start with a preconceived set of ideas, but identified emerging themes, and sought relationships between them. They identified existing related research and formed propositions relating the research to the process of bibliotherapy (Wilson & Thornton, 2006).

Two further research projects (Wilson, 2007, 2009) involved students at a second university, and practising primary teachers. Written reflections were completed and voluntarily shared with focus groups. The critical incidents and reflections were analysed for evidence of the stages of bibliotherapy. The analysis focused on the extent to which the bibliotherapy process was taken up by pre-service and in-service teachers in this context. Students responding to critical incident methodology identified an interaction or demeaning encounter (often with a teacher) where they were identified or defined by another as persons who couldn't learn mathematics, or started to think of themselves as such. Reading and reflecting about children's difficulties provided a stimulus for pre-service teachers to reflect more effectively on their beliefs about mathematics learning and teaching. Bibliotherapy is able to address Ambrose's (2004) criteria for mechanisms which have potential for changing beliefs, as it can provide emotion-packed experiences, encourage teachers to become immersed in a reflective community, and connect beliefs and emotions.

Fullan has identified three primary elements fundamental to substantive change in educational institutions. They are new materials, new teaching approaches and alteration of beliefs. (Fullan, 2001). This study is not considering whole-institution or systematic educational changes, but focuses on positive change in students in order to empower them. Pre-service teachers' pedagogical orientations, perceived value of mathematics, and self-efficacy beliefs are relevant to this study. Underlying beliefs and assumptions about mathematics learning and teaching professional knowledge and practice are important, especially if there is a mismatch of pedagogical assumptions and theories.

Themes identified through the analysis of data sources through the phases of bibliotherapy, strongly suggest the importance of insight as a major factor. Difficulties from school were reinterpreted as: "The teacher hadn't explained in the class in a way that I understood, or was relevant to me" (Christine). Realising this insight was a valuable part

of the process, these pre-service teachers questioned not only the views that they had developed of themselves as learners of mathematics, but also the image that they had previously held of themselves as prospective teachers of mathematics. Practicing teachers also reflected on their experiences. Cathy remembered her frustration in Year 7 struggling with a lack of understanding, and she “lost all confidence and went slowly downhill from there”. Teachers also developed insights about their learning, “I am sure the connections were there, but I couldn’t see them in the textbook” (Becky), and the impacts on their teaching, “I incorporate the methods by which I was taught, by doing the exact opposite” (Doris).

The analysis completed in these preliminary research projects corresponds to descriptive coding in grounded theory research. Further research is needed to confirm whether insight emerges as a major theme and analyse the connections that link the emergent themes. A visual representation of the framework will then be developed.

Theoretical Framework

The researcher has explored a range of potentially relevant literature. Through the review of the literature, potential elements that could inform the development of the framework have emerged. Several important areas that impact on a consideration of the development of teacher identity are underlying beliefs and assumptions, both about mathematics learning, and about teaching professional knowledge and practice.

The question that prompted the review of the literature on pre-service teacher beliefs about mathematics was: How do pre-service teacher beliefs about the nature of mathematics and mathematics teaching and learning guide, and later impact on, their approaches to teaching in the classroom? Studies have found that primary teachers teach mathematics in a way that is consistent with their pedagogical beliefs about mathematics and this can conflict with their beliefs about how children learn. Teachers’ beliefs about their own ability are significant factors in their approaches to teaching mathematics or even their willingness to teach upper primary classes (Wilson, 2007).

In the previous research many students identified an interaction where they experienced a loss of confidence and started to think of themselves as persons who couldn’t learn mathematics. This can be interpreted as a change in their identity, as they were no longer what they thought they were. When students are marginalised and do not identify themselves as confident learners of mathematics, they are unlikely to map mathematics into their future identities in a positive way (Boaler, 1997). This is not only a cognitive experience, but also an emotional one. For potential teachers of mathematics this emotional impact becomes doubly significant, potentially affecting not only their current study but also their future teaching of mathematics and hence the attitudes of their future students. Previous research indicated that developing insight (part of the bibliotherapy process) and reinterpreting these past experiences, leads to the development of a more positive projective identity (Wilson & Thornton, 2006).

Teacher Identity

The way individuals perceive themselves is integral to their continued learning of mathematics and to their teaching. As Grootenboer, Smith and Lowrie (2006) have indicated, identity is a term that used by researchers from a range of perspectives. There are a variety of lenses for looking at identity. These include personal (individual), social (shaped by society) and symbolic. All are useful lenses to consider as potentially informing

further research. Identity can be examined within and externally, and considered the “negotiated nature of the self” (Kashima, Foddy & Plastow, 2002). Gee (2001) listed four ways to view identity:

- Nature-identity (developed from natural forces)
- Institution-identity (authorised by an institution)
- Discourse-identity (recognised in dialogue with other individuals)
- Affinity-identity (shared practice with a group)

These are not separate but interact. “Identity is a unifying and connective concept that brings together elements such as life histories, affective qualities and cognitive dimensions.” (Grootenboer & Zevenbergen, 2008, p. 243).

For the purposes of this paper and the preliminary investigations of how previous research might be extended, identity will be viewed as “how individuals know and name themselves ... , and how an individual is recognised and looked upon by others” (Grootenboer et al., 2006, p. 612). Students construct a professional identity that is consistent with their perception of their personal capabilities. Their views of themselves as learners of mathematics impact on the identities they construct. Mahlios (2002) examined three domains of teacher identity – self-image, program conceptualisation, issues in work context – and showed that teacher educators need to be aware what images pre-service teachers bring with them and explicitly address them. Pre-service teachers’ identity includes their self-perception as learners of mathematics as well as looking ahead to “future selves” (Franken, 2002).

Actions carry meanings and generate further meanings. “Actions are embedded in interactions – past, present and imagined future.” (Corbin & Strauss, 2008, p. 6). In the discipline of mathematics education, this accords with Grootenboer and Zevenbergen’s, (2008, p. 248) contention that “it is essential that teachers of mathematics (at all levels) have well-developed personal mathematical identities”. Walshaw, (2004, p. 557), argues that “teacher education must engage the identities of pre-service students”, and describes the journey of a pre-service secondary teacher, Helen, who “through a process of formation and transformation, finally at the end of the year, understood who she might become” (p. 563).

According to Barton, (2009, p. 7) “a key factor in transforming ... mathematical knowledge into effective teaching lies in a teacher’s attitudes and orientations towards mathematics, the way they hold their mathematics”. He proposes the concept of “holding” mathematics as one that embeds a person’s vision, philosophy, role for mathematics and orientation.

Discussion

The focus of the present paper is on the developing framework rather than a detailed discussion of the findings as these have been reported in previous research papers (Wilson & Thornton, 2006; Wilson, 2007, 2009). This paper aims to tease out the scope for future research directions. The planned research design seeks a way of operationalising the research question. Specifically the research will focus on the critical question:

What is the process by which first year students with mathematics anxiety attain a more positive identity as a learner and teacher of mathematics?

This question is timely because mathematics anxiety and its impact on pre-service teachers and the students that they ultimately teach has been a problem but its impact is even more critical in the current technological age. It is of contemporary social and theoretical concern and is relevant to society because of the extended impact on children.

In addition it is relevant to the scholarly literature because of the potential to develop theory that is currently missing from mathematics education. This will also relate to the national debate about falling numbers of students in science.

Subsequent preliminary data analysis, of previous responses of students (Wilson, 2007), has led the researcher to postulate insight as a central theme in the process. Bibliotherapy is an iterative process that can offer pre-service teachers the opportunity to remove obstructive feelings and to reframe the way they see themselves as learners and teachers of mathematics. Further research focusing on an exploration and careful integration of emerging factors will enable the identification of a system of relationships between some of the major themes shaping this positive identity formation. Dynamically related aspects that comprise the model will emerge from the data. This will allow the interaction of important themes with barriers and enablers to be identified. Thus, factors hindering the process may be identified and subsequently addressed.

Extensive further data collected will make it possible to move past the standard analysis of change in identity as a response. It will seek to verify the interpretation of the descriptive coding completed retrospectively from the early research projects and incorporate a detailed analysis following the collection of more complex data. This can then be reduced in complexity by further coding, producing a model to explain how and why these changes occur, and how students perceive and negotiate tensions in their reflections. The aim is to validate and extend the preliminary findings. The framework, grounded in the experience of the students, will focus on understanding the process from the point of view of those who lived it.

The research will explore previous indications of the importance that insight plays in the development of a projective identity as a teacher of mathematics. It will examine how these students see themselves as teachers of mathematics, and how this perception develops during the bibliotherapy process. The aim is to produce a framework for the process that has coherence and continuity that flows into the mathematical units in the degree program. Constant comparisons and questioning the data from the start of the research will produce a theory tested and expanded by subsequent studies. The literature relating to these emerging themes, guided by the main concerns of the participants will be read as a source of more data.

In grounded research methodology, the researcher's assumptions and knowledge form part of the data and are compared with the data from the participants. Thus, the framework development includes a consideration of the author's philosophy and belief system. It is important to document the researcher's reflections and for them to be considered as data, capturing the experiences of the researcher. This is a way to ensure rigour as the researcher's reflections are not separated from the research process. Greater credibility is developed if the researcher interprets her own experience rather than implying that this could be detached and creates an audit trail of her own reasoning, and analysis of issues. The impact of the research on the researcher and a consideration of the influence of the researcher on the research are worthwhile contributions, and the researcher's experiences can be examined. (Glaze, 2002)

Quoting Mihalko (1978, p. 36), Wood (1988) wrote that it is logical that elementary school teachers "cannot be expected to generate enthusiasm and excitement for a subject for which they have fear or anxiety. If the cycle of mathophobia is to be broken, it must be broken in the teacher education institution" (p. 11). It is for these reasons that pre-service teacher education has become a crucial site for further research.

Educational Importance of the Study

Grounded theory aims to understand the action in a substantive area from the point of view of the participants involved, and examines how the behaviour of the participants resolves their main concern, giving texture and significance to their reflections. Future research will focus on elaborating and tuning this preliminary framework.

This project sits within debates and agendas that have long-term implications. The presence of well-prepared teachers in schools who are comfortable with teaching mathematics is a key factor in engaging students and enhancing their learning. Education courses carried out in teacher education institutions to prepare primary pre-service teachers to teach mathematics has a strong focus on providing the updated resources and teaching methods that Fullan identified as part of educational change. This research is related to his third aspect of change, that of changing students' beliefs. This is potentially one of the factors that contributes to the development of insight, and hence the establishment of a more robust teacher identity. Negotiating this issue has the potential to transform learning and teaching beyond that of the pre-service teacher to the future students. Promoting positive change for future teachers strengthens their engagement in the learning process. Empowering pre-service teachers contributes to social justice in that it can make a difference, not only for them, but also for their future students and hence impact on social change.

Practically speaking, the study is useful because it provides insight into strategies that can positively inform teacher preparation. Bibliotherapy can be a powerful tool for teacher educators to facilitate meta-affective change in pre-service by encouraging them to reflect on their own school experiences and reconstruct their assessment of their capacity to learn and understand mathematics, and hence re-examine their identity as teachers of mathematics. Ultimately the framework will inform teacher educators and assist in improving student learning outcomes in pre-service teacher education. It is in the teacher education sphere that identities and their associated insights are negotiated and eventually reified.

References

- Ambrose, R. (2004). Initiating change in prospective elementary school teachers' orientations to mathematics teaching by building on beliefs. *Journal of Mathematics Teacher Education*, 7, 91-119.
- Barton, B. (2009). Being mathematical, holding mathematics: Further steps in mathematical knowledge for teaching. In R. Hunter, B. Bicknell, & T. Burgess (Eds.), *Crossing Divides*. (Proceedings of the 32nd Annual Conference of the Mathematics Education Research Group of Australasia, Vol 1, pp. 4-9). Palmerston North, NZ: MERGA.
- Boaler, J. (1997). When even the winners are losers: Evaluating the experiences of 'top set' students. *Journal of Curriculum Studies* 29(2), 165-182.
- Corbin, J. & Strauss, A. (2008). *Basics of qualitative research: Techniques and procedures for developing grounded theory*. (3rd ed.). Thousand Oaks, CA: Sage Publications.
- Franken, R. (2002). *Human Motivation*. (5th ed.). Sydney: Wadsworth.
- Fullan, M. (2001). *The new meaning of educational change*. New York: Teachers College Press.
- Gee, J. (2001). Identity as an analytic lens for research in education. *Review of Research in Education*, 25, 99-125.
- Glaser, B. & Strauss, A. (1967). *The discovery of grounded theory*. Chicago: Aldine.
- Glaze, J. (2002). Ph.D. study and the use of a reflective diary: A dialogue with self. *Reflective Practice*, 3(2) 153 – 166.
- Gresham, G. (2008). Mathematics anxiety and mathematics teacher efficacy in elementary pre-service teachers. *Teaching Education* 19(3), 171-184.

- Grootenboer, P., Smith, T. & Lowrie, T. (2006). Researching identity in mathematics education: The lay of the land. In P. Grootenboer, R. Zevenbergen & M. Chinnappan (Eds.), *Identities, Cultures and Learning Spaces*. (Proceedings of the 29th Annual Conference of the Mathematics Education Research Group of Australasia, Canberra, Vol. 2, pp. 612-615). Adelaide: MERGA.
- Grootenboer, P. & Zevenbergen, R. (2008). Identity as a lens to understand learning mathematics: Developing a model. In M. Goos, R. Brown & K. Makar (Eds.), Proceedings of the 31st Annual Conference of the Mathematics Education Research Group of Australasia, Vol. 1, pp. 243-249). Brisbane: MERGA.
- Kashima, Y., Foddy, M. & Plastow, M. (2002). *Self and identity: Personal, social and symbolic*. Lawrence Erlbaum Associates.
- Lehmann, H.P. (2001). *A grounded theory of international information systems*. Unpublished Ph.D. Thesis. University of Auckland.
- Mahlios, M. (2002). Teacher role formation. *Action in Teacher Education*. 24, 9-21.
- Strauss, A. & Corbin, J. (1994). Grounded theory methodology: An overview. In N.K. Denzin & Y.S. Lincoln (Eds) *Handbook of qualitative research* (pp. 273-285) Newbury Park, CA: Sage.
- Utley, J., Bryant, R., & Moseley, C. (2005). Relationship between science and mathematics teaching efficacy of preservice elementary teachers. *School science and Mathematics* 105(2), 82-87.
- Walshaw, M. (2004). Becoming knowledgeable in practice: The constitution of secondary teaching identity. In I. Putt, R. Faragher & M. McLean (Eds.), *Mathematics education for the third millennium: Towards 2010*. (Proceedings of the 27th annual conference of the Mathematics Education Research Group of Australasia, Townsville, pp. 557-563). Sydney: MERGA.
- Wilson, S. (2007) My struggle with maths may not have been a lonely one: Bibliotherapy in a teacher education number theory unit. In J. Watson & K. Beswick (Eds.) *Mathematics: Essential research, essential practice*. (Proceedings of the 30th annual conference of the Mathematics Education Research Group of Australasia, Hobart (pp. 815-823). Adelaide: MERGA.
- Wilson, S. (2009) "Better you than me": Mathematics anxiety and bibliotherapy in primary teacher professional learning. In R. Hunter, B. Bicknell, & T. Burgess (Eds.), *Crossing Divides*: (Proceedings of the 32nd Annual Conference of the Mathematics Education Research Group of Australasia, pp. 603-610). Palmerston North, NZ: MERGA.
- Wilson, S. & Thornton, S. (2006). To heal and enthuse: Developmental bibliotherapy and pre-service primary teachers' reflections on learning and teaching mathematics. In P. Grootenboer, R. Zevenbergen & M. Chinnappan (Eds.), *Identities, Cultures and Learning Spaces*: (Proceedings of the 29th annual conference of the Mathematics Education Research Group of Australasia, Canberra, pp. 36-44). Adelaide: MERGA.
- Wood, E. (1988). Math anxiety and elementary teachers: What does research tell us? *For the Learning of Mathematics*, 86, 8-13.

“I always feel more confident when I know where things are going”: How do Pre-service Teachers Engage with Mathematics Curriculum Documentation?

Sue Wilson

University of Canterbury
<sue.wilson@canterbury.ac.nz>

Jane McChesney

University of Canterbury
<jane.mcchesney@canterbury.ac.nz>

The paper reports some findings about how pre-service students engage with the mathematics and statistics section of the *New Zealand Curriculum* (2007), when writing a yearly long-term plan in this curriculum area. This authentic task for pre-service students provided opportunities to seek out information about relevant curriculum knowledge including reviewing and revising mathematical content. This paper is part of a larger study, which focuses on the needs and concerns of final year primary pre-service teachers as they anticipate teaching mathematics in their first year of teaching.

Pre-service teachers develop knowledge for teaching during their teaching practice experiences and professional education coursework. They come into contact with a range of professional materials that include official documentation such as curriculum documents, teacher guides and centralised ministry websites. We can reasonably assume that pre-service teachers engage with this documentation in different ways to experienced teachers. Where experienced teachers have the benefit of wisdom of practice (Shulman, 2004), pre-service teachers are in the process of developing their curriculum knowledge for teaching. This includes understanding curriculum content, selecting and working with related curriculum resources and making decisions about how to enact curriculum content for planning and teaching.

This paper is drawn from a study in progress that investigates experiences of final year primary pre-service teachers as they complete their initial teacher education (ITE) programme and look ahead to their first year of teaching. We discuss one aspect: how these pre-service teachers approach curricular materials and what they are seeking from these materials in the process of generating their own pedagogical document of a long-term plan of intended maths learning. In addition, this study is set in a time of transition in official curriculum documentation from a specific mathematics curriculum with information for teachers (Ministry of Education, 1992) to one that combines all learning areas in one document (Ministry of Education, 2007).

What are Some Issues for Pre-service Teachers?

Teachers gain their knowledge for teaching from a variety of sources, one of which is educational materials and structures (Shulman, 1986). For pre-service teachers, a major source is within the coursework of their professional education programmes (Grossman, 1990). The content of their professional education courses presents to pre-service teachers, either explicitly or implicitly, a set of materials and other resources that are valued and have status. This is part of the ‘privileged repertoire’ (Ensor, 2001 citing Bernstein (1996)) that is “the set of symbolic and material resources that teacher educators (and teachers) select and configure in order to shape their classroom practice” (p. 299). These resources are privileged because they have been selected as representing ‘best practice’ for teaching and included in a professional education course. In addition, pre-service teachers are set



tasks that are “approximations of practice” that bring the practice of classroom teachers into course work (Grossman, Compton, Ingra, Ronfeldt, Shahan, & Williamson, 2009). These tasks may be simplified, have more generous timelines and provide lower stakes than in the ‘real world’ of the first year of teaching.

Although these activities are not entirely authentic in terms of their audience or execution, they can provide opportunities for students to experiment with new skills, roles, and ways of thinking with more support and feedback than actual practice in the field allows. (Grossman et al., 2009, p. 2077)

Approximations of practice include simulations of aspects of teaching such as teacher-student discussions, or diagnostic and other formative assessment. It can also apply to the planning and preparation of teaching documents such as lesson plans, unit plans and plans for a yearly programme. Pre-service teachers generate their own professional plans, by drawing on known information and seeking out further resources, and synthesising into a document that is valued in both the professional education course and the context of the school.

The Roles of Curriculum Materials in ITE

Both Shulman (2004) and Grossman (1990) identify curriculum knowledge as being crucial knowledge for pre-service teachers. Shulman (1986) describes curriculum as:

The full range of programmes designed for the teaching of particular subjects and topics at a given level, the variety of instructional materials available in relation to those programmes, and the set of characteristics that serve as both the indication and contraindication for the use of particular curriculum or programme materials in particular circumstances. (p.10)

Teachers need to know the content of the curriculum subject, and have knowledge and understanding of how this curriculum content is developed for teaching.

The curriculum and its associated materials are the *material medica* of pedagogy, the pharmacopeia from which the teacher draws those tools of teaching that present or exemplify particular content and remediate or evaluate the adequacy of student accomplishments.” (p.10)

At the time of this study, *The New Zealand Curriculum* (Ministry of Education, 2007) had been introduced for use in New Zealand schools. Where previously there was a separate mathematics curriculum document, mathematics and statistics is now included as one of nine Learning Areas, and the organisation and content of the mathematics achievement objectives have been changed. Barker (2008) noted that these changes highlight the debate about *what* and *how* much prescription should or could be included in a curriculum. He questions whether the revision of the content of the achievement objectives will enhance teachers’ understanding of the objectives and their interconnections that might form a broader picture of knowledge. The achievement objectives serve to set out “core knowledge considered suitable and desirable – by the designers – for all students to learn” (McGee, 2008, p. 65). Although never explained, and only for the Learning Area of mathematics and statistics, the new curriculum includes a graphical representation, a Venn Diagram, that illustrates the proportion contributed by each of the three strands, Number and Algebra, Geometry and Measurement, and Statistics. The size of each circle changes across the achievement levels to indicate changing emphasis. When certain curriculum materials are included in ITE course work, such as curriculum documents, or ministry resources such as from the NZ Numeracy Project, then these become “privileged because it places in the foreground a particular selection of pedagogical resources” (Ensor, 2001, p. 300).

A challenge for pre-service teachers is to transform their knowledge of the curriculum for classroom teaching (Fennema & Franke, 1992). Pre-service teachers present an interesting group of novice teachers because unlike experienced teachers and beginning teachers they have limited opportunities and experiences to do this:

Experienced teachers may possess rich repertoires of metaphors, experiments, activities or explanations that are particularly effective for teaching a particular topic, while beginning teachers are still in the process of developing a repertoire of instructional strategies and representations (Grossman, 1990, p. 9).

While there is some research that looks at how classroom teachers engage with mathematics curricular materials, including the use of curriculum packages and textbooks (Stein, Remillard, & Smith, 2007), this study is particularly interested in how pre-service teachers develop this knowledge. Grossman and Thompson (2008) focussed on beginning teachers and recognised they spend considerable amounts of time searching out and developing resource material for inclusion in their teaching repertoire. Beginning teachers rely on curriculum documentation and a variety of resources to provide clarification of curriculum content, mathematical content and directions for teaching. Consequently, this study focussed on how they gathered, identified, collated and synthesised curricular information for enactment in the classroom, whether on professional practice or in anticipation of their first year.

Research Design

The context for the research was an optional third year mathematics education course, taught over a five-week period, and prior to the final professional practice of the degree. The mathematics education course focussed on issues related to developing and implementing mathematics programmes in the primary classroom. The course was an optional course, meaning the course members had selected it from a number of curriculum-based courses. These pre-service teachers were yet to complete their final compulsory mathematics education course of the degree.

There were nineteen pre-service teachers in the course. During the first course session the study was described and volunteers for participation were requested. Twelve pre-service teachers indicated their willingness to participate and they were provided with detailed information about both the study and how any risks would be minimised, before giving their consent. The main ethical issue for participants was ensuring that their participation in the study did not affect their course assessments. To address this risk, assessment requirements were completed at the end of the course and after the data collection process was complete, thereby separating course assessments from research activity. Participants were also able to request that a lecturer who was external to the research process, assess their assignment work in accordance with accepted institutional practice. This also addressed another ethical tension, that of the first author having dual roles as both the course lecturer and the researcher.

Two main data collection methods were used; a written questionnaire and audio-taped focus group interviews. The questionnaire was completed midway through the course and contained three open-ended questions to elicit information about issues that participants faced as they engaged with the curriculum to design a long-term plan in mathematics. A questionnaire was selected because it was an efficient method for collecting data in a short time frame and it allowed each participant to respond privately and individually. It also enabled data to be gathered that could inform questions in future focus group interviews (Davidson & Tolich, 1998).

Two focus group interviews were completed midway through the course and two focus group interviews were carried out at the end of the course. Both sets of two interviews were audio-taped and included open-ended questions about the long-term planning process. Focus-group interviews were selected because the interactive nature of an interview allowed for the responses and views of participants to emerge in a collective setting (Cohen, Manion & Morrison, 2000). This study is concerned with identifying perspectives of pre-service teachers and interviewing as a method, placed the participants at the centre of the data gathering process. This enabled their ideas to dominate the discussion as opposed to those of the researcher. While their 'voice' was dominant, the interview situation also allowed the researcher to probe participants for further information when necessary.

A stimulated recall approach was adopted (Anthony, 1994), where participants referred to their completed but unmarked long-term plans during the interview. The plans acted as a prompt and support document for interview discussions. The plans were not yet assessed in order to ensure that this assessment component was separate from the research process. In addition to these methods, a researcher journal maintained a record of relevant field notes from course sessions and informal conversations throughout the time of the study. The data were analysed using a grounded theory approach, which allows for theory to emerge from data (Cohen et al., 2000). A process of thematic analysis was used to identify key data from both the questionnaire and interviews, which were then combined to generate several categories, one of which related to the participants' use of curriculum documentation. While pre-service teachers were expected to use the curriculum to complete their plans, the nature of their responses relating to the use of the curriculum was an unexpected finding of this study.

Responses to Curriculum Documents

All pre-service teachers wanted and expected the new curriculum to provide them with sufficient detail to support the long-term planning process, but found that it did not contain the information they needed. Comments were related to the specificity of the achievement objectives in the new curriculum and most participants found the achievement objectives lacking in detail. The following comments are illustrative:

"I found the achievement objectives to be very broad" (Int. 1).

"It gives us too much freedom. I don't like having tonnes of freedom. Within reason, I like to be told what to teach" (Int. 2).

In their position as beginning teachers, they wanted the achievement objectives in the curriculum to provide sufficient detail to inform their planning and teaching. In the absence of this detail they sought information from other resources. A common resource used to clarify the achievement objectives was the 'old' mathematics curriculum document (Ministry of Education, 1992), particularly the 'old' achievement objectives:

"I read the old achievement objectives because I found the new ones, well I didn't really understand some of them, whereas the old ones were sort of kind of easier" (Int. 1).

"Now it's quite brief, like I read the achievement objectives and I had to refer to the old ones because I didn't quite understand it" (Int. 2).

The 'old' curriculum was used because it was familiar to the pre-service teachers, the achievement objectives were specific and it contained Suggested Learning Experiences for

each strand and level. ‘Old’ information was aligned with ‘new’ information to develop understanding for planning and teaching.

In addition to seeking clarification of *what* to teach, the pre-service teachers looked to the achievement objective for cues about *how* to teach the content. They scrutinised the words in the achievement objectives to look for messages to guide their decisions about teaching approaches that could be adopted to teach curriculum content. One participant explained his process for this, describing how he used the verbs in the achievement objectives as indicators of possible teaching approaches.

“Um to be honest, I found it pretty useful like, for example, when you are saying, you’re describing, investigating ... that’s pretty much the key idea. Then you like say, design a lesson from there” (Int. 1).

Another agreed, saying:

“I just found it useful to know exactly what I needed to teach the children” (Int. 2).

Overwhelmingly the pre-service teachers wanted direction from the curriculum to guide their teaching.

Associated with the structure of the long-term plan was the task of clarifying the scope of different units of work and then sequencing these for a whole year. The following comment was typical:

“In the new curriculum you see things written down there and all chunked into three strands – and then you actually have to take it from those three strands into twenty different units that you teach throughout the year” (Int. 2).

Identifying the different unit combinations was a time consuming process. In the first instance they looked to the Venn diagrams for guidance about how to spread the units across the year. This information was not specific which resulted in the pre-service teachers guessing the intended meanings of the diagrams. They all inferred that the diagrams placed an importance on the Number and Algebra strand and consequently they selected to prioritise this strand in their plans.

Units of work were put together by splitting and joining the achievement objectives. When making decisions about the length of each unit, they took into account the number of achievement objectives and estimated how long these would take to teach. One pre-service teacher said:

“Well, I read the AOs, and then decided how long I thought it would take a class of like, level 2 to achieve that. And that’s how long I based, like; I did it for a week or two weeks” (Int. 2).

Several participants used the units of work on the nzmaths website to guide their decisions. These units were valued and therefore viewed as exemplars for teaching because they contained clustered achievement objectives, key mathematics ideas, learning intentions and suggested lesson sequences. At the time of this study, the pre-service teachers were frustrated because the units did not align with the 2007 curriculum document. Despite this, the units were still seen as a much needed extension of the curriculum content.

Curriculum Documents as Prompts for Exploring Mathematical Content

The process of interpreting the achievement objectives prompted all of the pre-service teachers to delve into aspects of uncertainty, particularly about mathematical content. Mathematical terminology used in the achievement objectives caused concern for some pre-service teachers. In the absence of a mathematical glossary in the new curriculum, they referred to the glossary in the old document and other mathematical dictionaries to help

them define unknown mathematical terms. One pre-service teacher did this for defining the difference between polygons and polyhedrons. She also searched in teaching resources to define this content. Teaching resources were an influential source of learning and had a dual purpose i.e. to provide a selection of teaching activities and as a tutorial for developing mathematical content knowledge. One pre-service teacher explained:

“The resources helped me to see what they’ve got to do...if it’s in the book then they’ve got to learn it” (Int. 3).

Another explained that if she looked at a resource and did not understand the mathematics, or how to use the resource in the classroom, then she would not use it. If she could ‘do the maths’ then she would teach it:

“Well, if you know something you’re more likely to teach it” (Int. 3).

A consequence of not knowing content might be that this teacher would choose to omit that area of mathematics from her programme.

The content tutorials section on the nzmaths website was another useful resource for developing mathematical content knowledge. This section provided an opportunity for pre-service teachers to develop mathematical knowledge in their own time. One pre-service teacher valued the video segments:

“They showed you how to use the number equipment – it made such a difference. Actually seeing it being taught would give you a lot of confidence. Because we’re not seeing everything that is being taught, it’s so much harder to know where to start” (Int. 3).

These segments were valued because they were readily accessible and provided independent learning opportunities to extend learning from course work and professional practice experiences, and in some cases provided new learning experiences. This enabled pre-service teachers to gain mathematical content knowledge in areas they needed, prior to teaching. They expressed a sense of relief that the tutorials would be available as a support resource in their first year of teaching. The pre-service teachers acknowledged the importance of mathematical content knowledge as professional knowledge needed for teaching. This knowledge was not only needed for understanding the curriculum, but also for engaging in professional conversations about planning and teaching with other teachers. One participant said:

“It helps to understand the terminology, so that we can discuss this content with experienced teachers” (Int. 1).

She regarded mathematical content knowledge as essential knowledge for effective mathematics teaching.

Discussion and Summary

The task of constructing a long-term plan for teaching mathematics provided an opportunity for the pre-service teachers to engage with a range of curriculum documentation. They had to look beyond *The New Zealand Curriculum* (Ministry of Education, 2007) because as pre-service teachers they did not have sufficient knowledge or experience to interpret and develop the curriculum for planning over an extended period of time. To gain this knowledge they preferred and trusted resources that were written by the Ministry of Education as these were viewed as having status and value. In addition, they expected that these resources would align with the new curriculum content. They used the resources to define what to teach and to inform decisions about possible teaching approaches. In the absence of additional supplementary resources to support the

curriculum, pre-service teachers relied on external resources for planning, teaching and the development of mathematical content knowledge.

Participants recognised curriculum knowledge as essential knowledge for teaching, and there was a sense of urgency to understand the curriculum information before they completed their pre-service professional education. The long-term planning assignment provided them with an opportunity to engage with the curriculum. They were looking for cues and signals from the curriculum that they might recognise as important resources for their work as well as actively seeking any missing aspects. They saw the long-term plan as an ‘authentic’ task of classroom teachers, and they were therefore seeking information that was also authentic (Grossman et al, 2009). The following comment expresses this sentiment:

“It is a real task that teachers would do – the long-term plan is important because we’re actually going to do it - it is actually something I would do if I was a teacher” (Int. 3).

Curriculum documentation was considered by the pre-service teachers as part of a privileged repertoire for this particular task (Ensor, 2001). When they recognised information that they could ‘re-source’ for their long-term plan, many participants went further in their efforts to clarify and extend their pedagogical knowledge as well as their mathematical knowledge. Where they could not find what they were looking for, they sought out further sources of information which included ‘old’ curriculum documentation, resource material, electronic resources, peers and lecturers.

The long-term plan itself was an important support for their developing professional knowledge because they saw that it provided planning support for their first year of teaching. By crafting this valued teaching document, they felt focussed and organised and it served as a mechanism that might keep them on a planned teaching path for the year. Completing the task before their first year, helped them feel prepared and confident to replicate the planning process:

“I always feel more confident when I know where things are going – it’s just random then I sort of feel lost, and it doesn’t give me direction” (Int. 2).

Pre-service teachers are in a unique position; they are on the cusp of leaving their ITE programme and beginning their first year of teaching. The pre-service teachers in this study viewed both curriculum and content knowledge as being important knowledge for teaching. The long-term plan provided a valuable experience for them to develop both areas of knowledge. In addition, engagement in an approximation of a task at this stage in their teacher education programme was valuable because it prompted the pre-service teachers to begin to transition into the role of the ‘real’ teacher. This study has highlighted significant findings about the development of both curriculum and content knowledge from the perspective of pre-service teachers. It also raises challenges for curriculum developers, ITE lecturers, and mentors in schools. Future research could investigate how ITE programmes assist pre-service teachers to develop knowledge of both curriculum and mathematical content, how pre-service teachers transform this knowledge from the ITE setting to the school setting, and how they develop this knowledge in their first year of teaching. Pre-service teachers are different to experienced teachers, the first year of teaching is an extension to their ITE programme, and therefore consideration also needs to be given to the content and process of professional development opportunities during their first year of teaching.

References

- Anthony, G. (1994). Learning strategies in the mathematics classroom: What can we learn from stimulated recall interviews. *New Zealand Journal of Educational Studies*, 29(2), 127-140.
- Barker, M. (2008). The New Zealand curriculum and pre-service teacher education: Public document, private perceptions. *Curriculum Matters*, 4, 7-19.
- Cohen, L., Manion, L., & Morrison, K. (2000). *Research methods in education* (5th ed). London: Routledge Falmer.
- Davidson, C., & Tolich, M. (Eds.) (1999). *Social science research in New Zealand-many paths to understanding*. Auckland: Pearson Education.
- Ensor, P. (2001). From preservice mathematics teacher education to beginning teacher: A study in recontextualising. *Journal for Research in Mathematics Education*, 32(3), 296- 320.
- Fennema, E., & Franke, M. L. (1992). Teachers' knowledge and its impact. In D. A. Grouws (Ed.), *The handbook of research on mathematics teaching and learning* (pp. 147-164). New York: Macmillan.
- Grossman, P. (1990). *The making of a teacher: Teacher knowledge and teacher education*. New York: Teachers College Press.
- Grossman, P., Compton, C., Igra, D., Ronfeldt, M., Shahan, E., & Williamson, P. W. (2009). Teaching practice: A cross-professional perspective. *Teachers College Record*, 111(9), 2055-2100.
- Grossman, P. & Thompson, C. (2008). Learning from curriculum materials: Scaffolds for new teachers? *Teaching and Teacher Education*, 24(4), 2014-2026.
- McGee, C. (2008). Understanding curriculum. In C. McGee & D. Fraser (Eds.), *The professional practice of teaching* (pp. 65-79). Auckland: Cengage Learning.
- Ministry of Education (1992). *Mathematics in the New Zealand Curriculum*. Wellington: Learning Media.
- Ministry of Education (2007). *The New Zealand Curriculum*. Wellington: Learning Media.
- Shulman, L. (1986). Those who understand: Knowledge growth in teaching. *Educational Researcher*, 15(2), 4-14.
- Stein, M. K., Remillard, J., & Smith, M. S. (2007). How curriculum influences student learning. In F. K. Lester Jr (Ed.), *Second handbook of research on mathematics teaching and learning* (pp. 319-368). Charlotte, NC: Information Age Publishing.

Beyond the Curriculum: The Mathematical Beliefs of Pre-service Primary Teachers in Hong Kong

Wing Yee Lo

University of Sydney

<wing.yee.lo@uni.sydney.edu.au>

Judy Anderson

University of Sydney

<judy.anderson@sydney.edu.au>

This study investigated pre-service primary teachers' knowledge and beliefs about mathematics, the curriculum in Hong Kong, and teaching practices. Pre-service teachers from all four years of the program who were majoring in mathematics teaching completed a questionnaire. A sample participated in an interview and provided lesson plans for analysis. This paper reports the data obtained from the beliefs section of the questionnaire. The preliminary results indicated that the mathematical beliefs of the pre-service teachers generally supported the innovative approaches recommended in the revised curriculum. Nevertheless, for some there was a contradiction between their beliefs about the role of mathematics teachers and mathematics learning in classrooms.

The curriculum model developed for the *Trends in International Mathematics and Science Study* (TIMSS) distinguished between the intended curriculum, the implemented curriculum and the attained curriculum (Mullis, Martin, Ruddock, O'Sullivan, Arora & Erberber, 2005). According to this curriculum model, the teacher is one of the key factors influencing the implemented curriculum. This is largely because teachers' curriculum decision-making and teaching approaches are influenced by their belief systems and personal theories about the nature of knowledge (Leder, Pehkonen & Törner, 2002; Pajares, 1992). As teachers' thought processes and instructional behaviours are related to their existing knowledge and personal beliefs, their understanding of mathematics and how it should be taught affects the quality of teaching in classrooms (Clark & Peterson, 1986).

To ensure the successful implementation of an innovative curriculum, pre-service teacher education and in-service professional development for teachers need to focus on the beliefs of participants as well as developing their knowledge and understanding of the new approaches (Anderson, White & Sullivan, 2005). Despite pre-service teachers having less immediate influence on the implemented curriculum, their pre-existing beliefs, usually formed from experiences as learners of mathematics, have the potential to impact on their teaching practices when they become qualified teachers (Raymond, 1997). When a new curriculum or an innovative teaching approach is advocated, it is crucial that pre-service education programs address teacher education students' beliefs to facilitate the changes of curriculum reform (Swars, Smith, Smith & Hart, 2009).

In 2000, the revised mathematics curriculum in Hong Kong (Curriculum Development Council [CDC], 2000) advocated higher-order thinking skills and real-life applications with a greater focus on student-centred approaches to the teaching and learning of mathematics. However, most students in the pre-service teacher education program in this study had experienced a more traditional, whole-class approach with the teacher as expert and students acting as passive recipients. It seems these experiences need to be challenged since the 'apprenticeship of observation' tends to lead to pre-service teachers learning to teach as they were taught (Lortie, 1975). In Hong Kong there have been a series of collaborative research projects conducted to enhance mathematics education in primary schools since the curriculum reform (Education Bureau, 2007) with many of the local studies investigating teaching strategies. Few have focused on the beliefs of pre-service



teachers. The overall aim of this study was to investigate pre-service teachers' mathematical beliefs in the context of primary mathematics curriculum in Hong Kong.

Primary Mathematics Curriculum in Hong Kong

Since 2002, there has been considerable change in the Hong Kong primary curriculum. Quality learning and teaching as well as competencies for lifelong learning are now emphasised with knowledge organised into eight Key Learning Areas. In addition, Generic Skills, Values, and Attitudes form three interconnected components in the curriculum framework of education reform. The revised primary mathematics curriculum has five learning dimensions – number, shape and space, measures, data handling, and algebra (CDC, 2000). To cater for individual differences, topics in each learning dimension are divided into two levels – basic and enrichment. The purpose of generating enrichment topics is to “broaden pupils’ view and arouse their interest” (CDC, 2000, p. 6). As enrichment topics are optional and not included in examinations, teachers’ selection of enrichment topics depends on the needs and abilities of the students and the time available.

In the Curriculum Guide, teachers are advised to adopt a wider range of teaching and assessment approaches. The guide states:

As a foundation for further study, more opportunities should be provided for pupils to observe, analyze, understand and judge events/information, and to develop their elementary thinking abilities ... Pupils should learn pleasurable through various learning activities and develop their imagination, creativity and thinking skills (CDC, 2000, p. 49).

Application of information technology such as calculators, computers and multimedia equipment is recommended and for assessment, evaluation of students’ thinking processes is as important as assessing students’ mastery of knowledge and skills (CDC, 2000). Apart from formal assessment including tests and examinations, project work such as statistical surveys, making models, and presentations in class are all recommended as possible informal assessment activities. Compared to the previous primary mathematics curriculum, this represents a significant shift in recommended teaching strategies and assessment methods in primary mathematics education. Educational change is always a challenge, particularly when it necessitates new views about teaching and learning (Fullan, 1993). A necessary component of curriculum innovation requires a comprehensive and effective teacher preparation course to address the changes and challenge pre-service teachers’ mathematical beliefs.

Pre-service Teachers’ Mathematical Beliefs

For the purpose of this paper, ‘pre-service teachers’ mathematical beliefs’ refers to those belief systems held by pre-service teachers about mathematics teaching and learning. Given the range of definitions of beliefs among specialists in mathematics education (Furinghetti & Pehkonen, 2002), this study has adopted Schoenfeld’s (1992) definition since it encompasses both cognitive and affective components: “an individual’s understandings and feelings that shape the ways that the individual conceptualizes and engages in mathematical behaviour” (p. 358).

In reviewing earlier research on initial teacher preparation in mathematics education, Raymond (1997) noted that past school experiences, early family experiences and the teacher education program have greatest influence on developing pre-service teachers’ mathematical beliefs. Uusimaki and Nason (2004) conducted semi-structured interviews with eighteen pre-service primary mathematics teachers in Australia to reveal the origins of

their negative beliefs and mathematics anxiety. It was found that 12 out of the 18 pre-service teachers experienced negative mathematics learning in their primary schools. Their negative experiences included feeling stressful in mathematics tests and feeling anxious during practicum when they had to teach mathematics lessons.

Pre-existing beliefs about teaching and learning mathematics can be resistant to change (Pajares, 1992) with Kagan (1992) claiming pre-service teachers tend to leave pre-service programs holding much the same beliefs with some having even stronger negative biases towards mathematics. More recent studies (e.g., MacNab & Payne, 2003; Scott, 2005) suggested graduating pre-service teachers usually have more favourable beliefs than beginning pre-service teachers. MacNab and Payne (2003) studied Scottish pre-service primary teachers' beliefs, attitudes and practices in mathematics teaching and concluded the final year pre-service teachers had more confidence in teaching but they were less positive about mathematics itself. Scott (2005) examined 163 commencing and 186 graduating pre-service teachers' beliefs about teaching and learning primary mathematics in Australia. The data indicated that the graduating pre-service teachers were much more capable of teaching numeracy by means of building on their students' experiences.

Investigations of teachers' beliefs about mathematics frequently reveal a range from more traditional beliefs to more contemporary beliefs with many teachers holding a mixed set of beliefs (Anderson, White & Sullivan, 2005). At one end of a continuum of beliefs, teachers tend to view mathematics as a fixed body of knowledge, with teachers as experts and students memorising rules and procedures. At the other extreme, teachers may view mathematics as socially constructed with teachers and students working together to explore mathematical ideas, negotiating meanings, and creating ways to represent their thinking. These more contemporary beliefs are likely to support the implementation of curriculum reform as described in the revised Hong Kong curriculum. As noted by Szydlik, Szydlik and Benson (2003), many pre-service primary teachers have beliefs which are narrow, formal and rigid hence the focus in many studies is to change pre-service teachers' beliefs.

Methodology

The study reported here did not aim to explore the changes of primary pre-service teachers' beliefs but to investigate the types of beliefs held by these student teachers in the Hong Kong context and to consider the possible differences in mathematical beliefs across the stages of a pre-service program. Unlike many Western countries, these pre-service teachers were all majoring in primary mathematics teaching so that when they graduated, they would have responsibility for teaching mathematics to several different primary classes. The research methods used for the study comprised questionnaires, interviews and lesson plan analysis. For investigating the mathematical beliefs of pre-service teachers, two instruments including a self-report questionnaire and a semi-structured interview schedule were utilised. Of the 152 respondents to the questionnaire, 19 were selected for the interviews. This paper reports some background data about the students as well as the data obtained from the beliefs section of the questionnaire.

There were three sets of questions in the questionnaire that aimed to investigate pre-service primary teachers' mathematics curriculum knowledge, mathematical beliefs as well as their mathematical content knowledge and pedagogical content knowledge. In the beliefs section, a set of four-point Likert scale questions was designed to explore pre-service teachers' mathematical beliefs. Eighteen of the Likert scale items had been used to reveal in-service and pre-service teachers' mathematical beliefs in previous international research (Perry, Vistro-Yu, Howard, Wong & Fong, 2002; Perry, Way & Southwell,

2005). Seven more items were added to specifically address the Hong Kong context. These 25-item statements were grouped as: beliefs about mathematics, beliefs about mathematics teachers, beliefs about mathematics learning, beliefs about mathematics teaching, and beliefs about the social context in relation to primary mathematics education.

In each of the groups of beliefs, some statements represented more traditional beliefs while others represent more contemporary beliefs. Some of the more traditional belief statements included ‘mathematics is computation’, ‘the role of the mathematics teacher is to transmit knowledge and to verify that learners have received this knowledge’ and ‘right answers are much more important in mathematics than the ways in which you get them’. More contemporary belief statements included ‘mathematics is the dynamic searching for order and pattern in the learner’s environment’ and ‘mathematics teachers should negotiate social norms with the students in order to develop a cooperative learning environment in which students construct their knowledge’.

All pre-service teachers from one teacher education institution who had enrolled in a four-year Bachelor of Education (Honours) (Primary) Program and had selected mathematics as their major were invited to participate in the study at the end of the academic year. The population of the study was approximately 210. As there were 152 questionnaires returned (63 responses from Year 1, 41 responses from Year 2, 19 responses from Year 3 and 29 responses from Year 4), the response rate was over 65%.

Preliminary Results and Analysis

Among the 152 respondents, there were 112 female and 39 male students while one did not provide a response for the gender item. A total of 132 of the participants had completed their six-year primary education in Hong Kong and their graduation years ranged from 1992 to 2001. It is typical of Hong Kong tertiary education intakes to have mainly local students. As the revised primary mathematics curriculum was not implemented until 2002, all participants would have experienced the previous traditional mathematics curriculum.

The reasons given for the student teachers choosing mathematics as their major in their teacher education training were varied. Over 88% of the respondents gave at least one positive reason for choosing to study mathematics with 84% of them indicating they were ‘interested’ in mathematics. Only 15% of the respondents chose mathematics education because they were ‘good’ at it, and 24% of them made their choice because they ‘loved’ mathematics (see Table 1 – note that some respondents chose more than one category).

Table 1

Reasons for choosing mathematics as a major in the teacher education training

	“I am good at mathematics.”	“I am interested in mathematics.”	“I love mathematics.”	Other reasons
Year 1, <i>n</i> = 63	14	55	21	9
Year 2, <i>n</i> = 41	6	31	6	9
Year 3, <i>n</i> = 19	0	16	3	2
Year 4, <i>n</i> = 29	3	26	7	3

In order to compare the results between the pre-service teachers from different study stages, the respondents were divided into three groups: Year 1; Year 2; Years 3 and 4 (see Table 2). The results obtained from Years 3 and 4 were combined because it is during these years that the students do practicum in schools so all of the students from these year

groups had completed at least one practicum experience. To gauge overall positive and negative views, the responses to the categories “agree” and “strongly agree” have been combined in Table 2. Similarly for the disagree categories. These responses were used to construct a picture of the pre-service teachers’ mathematical beliefs at each of the three study stages.

Table 2
Frequencies of responses in 25-item beliefs statements at different study stages

	Item number	Strongly agree or Agree (%)			Strongly disagree or Disagree (%)		
		Group 1	Group 2	Group 3	Group 1	Group 2	Group 3
		<i>Year 1</i> <i>n = 63</i>	<i>Year 2</i> <i>n = 41</i>	<i>Year 3 & 4</i> <i>n = 48</i>	<i>Year 1</i> <i>n = 63</i>	<i>Year 2</i> <i>n = 41</i>	<i>Year 3 & 4</i> <i>n = 48</i>
Mathematics	1*	66	76	69	33	22	31
	2	85	93	96	14	5	4
	3	95	96	98	5	5	0
	4	89	98	100	12	2	0
Mathematics Teachers	5	83	83	96	14	17	4
	6*	92	78	67	8	22	33
	7	73	78	65	27	22	35
	8	79	68	69	21	31	31
	9	83	93	85	18	7	15
	10	49	44	35	51	53	65
	11*	30	26	27	70	73	69
Mathematics Learning	12	95	100	98	5	0	2
	13	89	93	98	11	7	2
	14	64	82	69	35	15	31
	15*	43	41	38	57	56	60
	16	94	96	98	5	5	2
	17	97	100	98	4	0	2
	18*	63	58	60	36	42	25
	19	76	56	67	24	43	33
Mathematics Teaching	20*	45	41	40	55	56	60
	21*	21	7	8	79	93	92
	22	63	83	85	35	17	15
Social Context	23*	27	12	6	73	88	92
	24*	38	27	13	61	70	88
	25	87	92	100	11	7	0

*Items represent more traditional beliefs.

Belief characteristics of Year 1 pre-service teachers

Although the beginning pre-service teachers had not been into schools for their practicum, their mathematical beliefs were generally considered to reflect more contemporary views. For instance for their beliefs about the discipline of mathematics and mathematics learning, over 90% of the Year 1 pre-service teachers agreed or strongly agreed with the following contemporary belief statements:

- Item 3 - Mathematics is an interesting subject (95%);
- Item 12 - Mathematics learning is enhanced by challenge within a supportive environment (95%);
- Item 16 - Periods of uncertainty, conflict, confusion, surprise are a significant part of the mathematics learning process (94%);
- Item 17 - Mathematics learning is enhanced by activities that build upon and respect students' experiences (97%).

However, the Year 1 pre-service teachers also agreed with some of the more traditional belief statements. For example, nearly two thirds of the Year 1 respondents agreed or strongly agreed with Items 1 and 18:

- Item 1 - Mathematics is computation (66%);
- Item 18 - Being able to memorise facts is critical in mathematics learning (63%).

Another notable result was that beginning pre-service teachers' beliefs about the role of mathematics teachers were also more traditional. A high proportion of the respondents agreed or strongly agreed with:

- Item 6 - The role of the mathematics teacher is to transmit mathematical knowledge and to verify that learners have received this knowledge (92%).

This statement does not support the innovative approaches advocated from the revised curriculum since it suggests a more teacher-centred approach. It could be implied that the Year 1 pre-service teachers' responses represented a mixed set of beliefs with agreement with some contemporary beliefs combined with agreement with more traditional beliefs.

Belief characteristics of Year 2 pre-service teachers

For the Year 2 pre-service teachers, the data indicated that a high proportion held contemporary beliefs about mathematics, mathematics teachers, mathematics teaching, and mathematics learning and also had favourable beliefs about the social context of teaching mathematics in primary schools. Over 90% of the respondents agreed or strongly agreed with the following contemporary belief statements:

- Item 2 - Mathematics is the dynamic searching for order and pattern in the learner's environment (93%);
- Item 3 - Mathematics is an interesting subject (96%);
- Item 4 - Mathematics is a beautiful, creative and useful human endeavour that is both a way of knowing and a way of thinking (98%);
- Item 9 - Good mathematics teachers should love mathematics (93%);
- Item 12 - Mathematics learning is enhanced by challenge within a supportive environment (100%);
- Item 13 - Mathematics knowledge is the result of the learner interpreting and organising the information gained from experiences (93%);
- Item 16 - Periods of uncertainty, conflict, confusion, surprise are a significant part of the mathematics learning process (96%);

- Item 17 - Mathematics learning is enhanced by activities which build upon and respect students' experiences (100%);
- Item 25 - The idea of specialist mathematics teacher is promoting primary education (92%).

Also, over 90% disagreed or strongly disagreed with the following statement representing a more traditional belief:

- Item 21 - Right answers are much more important in mathematics than the ways in which you get them (92%).

Even though the results indicated that Year 2 pre-service teachers generally supported more contemporary mathematical beliefs, it is interesting to note that 76% of them still deemed mathematics to be focused on computation; a view that largely contradicts the approach recommended in the Hong Kong curriculum with a focus on problem-solving and higher-order thinking skills.

Belief characteristics of Year 3 and Year 4 pre-service teachers

Similar to the results in Year 2, the Years 3 and 4 pre-service teachers generally supported the more contemporary mathematical beliefs. One difference from the results in Year 1 and Year 2 is that a large proportion of the Year 3 and Year 4 prospective teachers had favourable beliefs about the social context in relation to primary mathematics education. Ninety-two percent of the respondents disagreed or strongly disagreed with the statement suggesting English and Chinese languages were more important than mathematics in primary education while 88% of them disagreed or strongly disagreed that "learning language was more useful than learning mathematics for a primary student". In addition, all of the respondents from Years 3 and 4 fully supported the idea of specialist mathematics teachers in primary education. Clearly the pre-service teachers had strong beliefs about professionalising primary mathematics education in Hong Kong.

Conclusion

The data presented in Table 2 reveal a promising tendency towards support for more contemporary mathematical beliefs among the pre-service teachers in this program. Although, these pre-service teachers experienced a more traditional curriculum in primary and secondary mathematics classes, they have all chosen to major in mathematics teaching in their primary pre-service education. The responses to particular beliefs about mathematics (Items 2, 3 and 4), beliefs about mathematics teachers (Items 5 and 9) as well as beliefs about mathematics learning (Items 12, 13, 16 and 17) suggest the pre-service teachers from all of the study stages positively support the approaches recommended in the 2000 revised primary mathematics curriculum in Hong Kong. However, some traditional mathematical beliefs such as beliefs about mathematics (Item 1), beliefs about mathematics teachers (Item 6) as well as beliefs about mathematics learning (Item 18) are still supported. Interestingly, for one traditional belief statement, a decreasing number of respondents across the study stages supported the statement 'right answers are much more important in mathematics than the ways in which you get them'.

The beliefs survey gave a general picture of the beliefs characteristics among pre-service primary teachers in Hong Kong. In short, the data reveal the evolving nature of contemporary beliefs throughout the teacher education program. The reasons for these differences are unclear but these will be further explored during analysis of additional questionnaire items and during interviews. In addition, to verify the accuracy of the data collected from the survey and explore the contextual factors impacting on the mathematical

beliefs of the respondents, the data obtained from the interviews and lesson plan analysis will be considered in the further qualitative analysis.

References

- Anderson, J., White, P., & Sullivan, P. (2005). Using a schematic model to represent influences on, and relationships between, teachers' problem-solving beliefs and practices. *Mathematics Education Research Journal*, 17(2), 9-38
- Curriculum Development Council [CDC]. (2000). *Mathematics curriculum guide (P1 – P6)*. Hong Kong: Education Department.
- Clark, C. M., & Peterson, P. L. (1986). Teachers' thought processes. In M. C. Wittrock (Ed.), *Handbook of research on teaching* (pp. 255-296). New York: Macmillan Publishing Co.
- Education Bureau (2007). *Mathematics education – Collaborative research and development ("Seed") project*. Retrieved July 1, 2007 from <http://www.edb.gov.hk/index.aspx?nodeID=3301&langno=1>
- Fullan, M. (1993) *Changing forces: Probing the depths of educational reform*. London, UK: Falmer Press.
- Furinghetti, F. & Pehkonen, E. (2002). Rethinking characterizations of beliefs. In G. C. Leder, E. Pehkonen & G. Törner (Eds.), *Beliefs: A hidden variable in mathematics education?* (pp. 39-57). Dordrecht, The Netherlands: Kluwer.
- Kagan, D. M. (1992). Implications of research on teacher belief. *Educational Psychologist*, 27(1), 65-90.
- Leder, G. C., Pehkonen, E. & Törner, G. (Eds.). (2002). *Beliefs: A hidden variable in mathematics education?* Dordrecht, The Netherlands: Kluwer.
- Lortie, D. C. (1975). *School teacher*. Chicago: University of Chicago Press.
- MacNab, D. S. & Payne, F. (2003). Beliefs, attitudes and practices in mathematics teaching: Perceptions of Scottish primary school student teachers. *Journal of Education for Teaching*, 29(1), 55-68.
- Mullis, I. V. S., Martin, M. O., Ruddock, G. J., O'Sullivan, C. Y., Arora, A. & Erberber, E. (2005). *TIMSS 2007 assessment frameworks*. Chestnut Hill, MA: Boston College.
- Pajares, M. F. (1992). Teachers' beliefs and educational research: Cleaning up a messy construct. *Review of Educational Research*, 62(3), 307-332.
- Perry, B., Vistro-Yu, C., Howard, P., Wong, N-Y. & Fong, H. K. (2002). Beliefs of primary teachers about mathematics and its teaching and learning: Views of Singapore, Philippines, mainland China, Hong Kong, Taiwan and Australia. In B. Barton, K. Irwin, M. Pfannkuch & M. Thomas (Eds.), *Mathematics education in the South Pacific* (Proceedings of the 25th Annual Conference of the Mathematics Education Researcher Group of Australasia, pp. 551-558). Sydney: MERGA.
- Perry, B., Way, J. & Southwell, B. (2005). Mathematical beliefs and achievement of pre-service primary teachers. In P. Clarkson, A. Downton, D. Gronn, M. Horne, A. McDonough, R. Pierce & A. Roche (Eds.), *Building connections: Research, theory and practice* (Proceedings of the 28th annual conference of the Mathematics Education Research Group of Australasia, pp. 625-632). Sydney: MERGA.
- Raymond, A. (1997). Inconsistency between a beginning elementary school teacher's mathematics beliefs and teaching practice. *Journal for Research in Mathematics Education*, 28(5), 550-576.
- Schoenfeld, A. H. (1992). Learning to think mathematically: Problem solving, metacognition, and sense making in mathematics. In D.A. Grouws (Ed.), *Handbook of research on mathematics learning and teaching*. (pp. 334-370). New York: Macmillan.
- Scott, A. L. (2005). Pre-service teachers' experiences and the influences on their intentions for teaching primary school mathematics. *Mathematics Education Research Journal*, 17(3), 62-90.
- Swars, S. L., Smith, S. Z., Smith, M. E., & Hart, L. C. (2009). A longitudinal study of effects of a developmental teacher preparation program on elementary prospective teachers' mathematical beliefs. *Journal of Mathematics Teacher Education*, 12(1), 47-66.
- Szydlik, J. E., Szydlik, S. D., & Benson, S. R. (2003). Exploring changes in pre-service elementary teachers' mathematical beliefs. *Journal of Mathematics Teacher Education*, 6, 253-279.
- Uusimäki, L. & Nason, R. (2004). Causes underlying pre-service teachers' negative beliefs and anxieties about mathematics. In M. J. Høines & A. B. Fuglestad (Eds.), *Proceedings of the 28th Conference of the International Group for the Psychology of Mathematics Education*, (Vol. 4., pp. 369-376). Bergen: Bergen University College.

Algebraic Thinking: A Problem Solving Approach

Will Windsor
Griffith University
<w.windsor@griffith.edu.au>

Algebraic thinking is a crucial and fundamental element of mathematical thinking and reasoning. It initially involves recognising patterns and general mathematical relationships among numbers, objects and geometric shapes. This paper will highlight how the ability to think algebraically might support a deeper and more useful knowledge, not only of algebra, but the thinking required to successfully use mathematics. The paper will highlight how a deeper analysis of mathematical problems can instigate student discourse, providing meaningful experiences that can developing algebraic thinking.

Recent calls for reform in mathematics education in Australia have focused on the need to promote and facilitate improved teaching and learning of mathematics (Council of Australian Governments, 2008; National Curriculum Board, 2008). A key element of this reform agenda is the introduction of a national mathematics curriculum. The strand Number and Algebra will be an integral part of the new curriculum with the middle and upper primary years emphasising an algebraic perspective of number rather than the formal algebra familiar to most people. In contrast, secondary school students will undertake the study of formal algebra having been introduced to algebraic concepts and ideas at the primary school level.

The algebraic perspective I attempt to illustrate is a perspective that values, enriches and improves the thinking required to understand algebraic concepts. Consequently, in this discussion we will adopt the term ‘algebraic thinking’ rather than an algebraic perspective of number, as it takes into account the variety of activities students can engage in across all mathematics strands, not simply number. Algebraic thinking is founded on numeracy and computational proficiency, the reasoning of geometry and skills associated with measurement- concepts introduced and taught in the primary and middle school (Kaput, 2008). Importantly, it extends the thinking required to solve problems beyond methods tied to concrete situations. In time, this thinking supports students ability to problem solve using abstractions and to operate on mathematical entities logically and independently from the material world.

The approach that I propose involves identifying and using mathematical problems that promote and advance a generalised perspective of mathematical problem solving. An ability to consider problems from this perspective can allow individuals to acquire adaptable ways of thinking, to express the generalisations they have arrived at and leads into a meaningful use of algebraic symbolism (Carraher, Brizuela, & Schliemann, 2003). The potential value for using problem solving contexts is that it may broaden and develop students’ mathematical thinking and provide them with an impetus for understanding a greater collection of problems of increasing complexity and mathematical abstraction (Kaput, 2008; Kaput, Blanton, & Moreno, 2008; Schliemann, Carraher, & Brizuela, 2007; Lins, Rojano, Bell, & Sutherland, 2001). As will become apparent, algebraic thinking promotes a particular way of interpreting mathematics. It extends the mathematical thinking of students by encouraging them to interact and engage with the generalities and relationships inherent in mathematics. Lins et al (2001, p. 3) contend that “no matter how suggestively algebraic a problem seems to be, it is not until the solver actually engages in its solution that the nature of the thinking comes to life.”



Problem Solving and Algebraic Thinking

Using mathematical problems has been advocated as a crucial and motivating component of learning and understanding mathematics. Schoenfeld (1992) notes that, when solving mathematical problems, students develop a deeper understanding of mathematics because it helps them to conceptualise the mathematics being learnt. Stanic and Kilpatrick's (1989) review of problem solving indicates that historically, mathematical problem solving has been instrumental in achieving a variety of goals within the mathematics curriculum. Furthermore, productive problem solving experiences that move children beyond the routine acquisition of isolated techniques are fundamental in developing higher order mathematical thinking and reasoning (Booker & Bond, 2009; Polya, 1973). In my view, many of the fundamental ideas on which mathematics is built can make sense to children if those concepts are viewed in meaningful and challenging contexts.

In the book *How to Solve It* (1973) Polya is explicit in characterising the heuristics of effective problem solving. Essentially, he attempts to understand how people think and the strategies they might use when solving problems. Polya (1973) contends that to solve any problem, the characteristics and properties of the problem should be analysed. Once the problem is understood then a plan is devised and strategies are implemented and finally, opportunities to reflect upon the solution are required. Though Polya emphasises the heuristics of problem solving, he also acknowledges the idea of mathematical connectedness and generality, key components of algebraic thinking. He suggests that by actively engaging with problems students can develop the ability to understand the generalities associated with problem solving:

In solving a problem of one or the other kind, we have to rely on our experience with similar problems and we often ask the questions: Have we seen this problem in a slightly different form? Do we know a related problem? (Polya, 1973, p. 151)

This brief overview of Polya's work serves to emphasise that the generalities, relationships and interconnectedness that underpins mathematics can be carried through to developing algebraic thinking. Furthermore, being aware of and having the capacity to consider, ascertain and communicate the generalities of a particular problem may invariably enhance an understanding of formal algebra. As Krutetskii (1976, pp. 334-335) observed "one must be able to see a similar situation (where to apply it), and one must master the generalised type of a solution, the generalised scheme of a proof or of an argument (what to apply)." This perspective appreciates that algebraic thinking and problem solving are inextricably linked by common skills and mathematical understandings.

In shifting the emphasis of problem solving, from simply finding a specific answer to also including a focus on algebraic thinking, I conjecture that it may provide a powerful way to teach and learn algebraic ideas. Many of the problems found in elementary arithmetic and geometry have the capacity to support a way of thinking that connects a range of mathematical content and processes (Booker, Bond, Sparrow, & Swan, 2010; Bednarz & Janvier, 1996). Extending mathematical problems solving to include the developing algebraic thinking, educators can facilitate more divergent and adaptive ways of thinking mathematically. Opportunities arise to engage and extend students' mathematical experiences that go beyond routine arithmetical solutions. As Silver, Ghouseini, Gosen, Charalambous, and Strawhun (2005, p. 288) observed, when discussing the advantages of facilitating a variety of different solutions:

An aphorism of unknown origins captures the essence of this idea: “You can learn more from solving one problem in many different ways than you can from solving many different problems, each in only one way”.

Developing Algebraic Thinking Using Problem Solving

Teaching algebraic thinking using a problem solving approach can be established amid the learning experiences that already exist in most classrooms. It is apparent that this approach evolves and builds upon a child’s ability to consider, see and think about the mathematical concepts within a problem. Lee’s (2001) analysis of algebraic thinking highlights some of the underlying strategies which characterise this type of mathematical reasoning. She observes that when children analyse problems from an algebraic thinking perspective they may consider:

- Reasoning about patterns (in graphs, number patterns, shapes, etc) stressing and ignoring, detecting sameness and difference, repletion and order.
- Generalising or thinking in terms of the general, seeing the general in the particular;
- Mentally handling the as-yet-unknown, inverting and reversing operations;
- Thinking about mathematical relations rather than mathematical objects.

It is apparent that the development of algebraic thinking arises from generalising mathematical thought. Researchers such as Bednarz, Kieran, and Lee (1996) extend this idea and state “the process of generalisation as an approach to algebra appears ultimately related to that of justification”. Thus, a classroom environment that values and promotes collaborative learning situations, student discourse and the opportunities to communicate mathematical ideas and conjectures can better facilitate algebraic thinking. The resounding importance of teachers to facilitate algebraic thinking through meaningful discourse can be observed in the research of Carpenter, Franke, and Levi (2003), Carraher, Schliemann, and Brizuela (2003) and van Amerom (2002). Each of these research teams encouraged student discourse so as to promote deeper mathematical reasoning and expedite algebraic thinking.

In focusing on developing algebraic thinking, current thinking suggests students will progress through three stages of development. At first, many students will describe generalities and relationships in natural language, this can lead into abbreviating those ideas by using diagrams and mathematical symbols and finally, these ideas can be summarised using mathematical expressions and equations, tables of values and graphs (NCTM, 2000; Mason, Graham, & Johnston-Wilder, 2005). The history of mathematics would also suggest that to understand and solve problems of an algebraic nature, individuals operate and constantly manoeuvre their thinking between the before-mentioned three stages often referred to as rhetorical, syncopated or symbolic stages (Harper, 1987; Katz & Barton, 2007). Clement, Lochhead, and Monk (1981) describe that most mathematicians think this way; rarely do they consider their thoughts in a purely symbolic realm. Instead, describing their ideas as being like pictures — with tables, graphs and symbols used to interpret those ‘pictures’. However, the thinking required to understand these thoughts is algebraic because there is a focus on the general rather than the specific.

The work of scholars such as Lannin, Barker, and Townsend (2006) and Booker and Bond (2009) serve to reinforce the importance of students interacting with the problem, their teachers and other students at a variety of different levels. Lannin, Barker, and Townsend describe how social factors, cognitive factors and task factors simultaneously influence the way students address problems and how this influences their reasoning. Booker and Bond (2009) document the effectiveness of working collaboratively and the

value of encouraging multiple perspectives. As they both document, developing algebraic thinking can be achieved when students are encouraged to use a variety of strategies and are supported to communicate their ideas, reflect upon solutions and have opportunities to speculate about the concepts and ideas they have constructed.

Algebraic Thinking within a Classroom Context

This section will illustrate and highlight how the transition from the rhetorical to the synocopated stage of generalised thought can be promoted. The following three problems were completed by a Year Six class. The tasks involved finding a pattern and possibly explaining a method for summing an arithmetic series. The students worked in seven groups of four and were able to use a calculator, pencil and paper or counters to come with a solution or explanation.

Problem A - Chiming Clock

An old chime clock strikes one chime at 1 o'clock, two chimes at 2 o'clock, three chimes at 3 o'clock and so on. How many chimes will it strike in a 12-hour cycle?

Problem B - Counting Coins

Your New Year's resolution is to save enough money to buy a new bike. You decide to put \$1 away on the first day of the year, \$2 on the second day, \$3 on the third day, \$4 on the fourth day and so on. How much money will you have after 30 days?

Problem C - A King's Ransom

A King told his knights that if they could slay the dragon they would be richly rewarded. He informed them that he would place on a chess board one gold coin on the first square, two gold coins on the second square, three gold coins on the third square, four gold coins on the fourth square and so on. How many gold coins will the knights have if they slay the dragon? There are 64 squares on a chess board.

At first many children simply added successive numbers. However, many had difficulty in explaining or justifying their solutions in generalised terms. Using their calculators or pencil and paper many children could achieve the correct solution for Problem A by simply adding the numbers in the correct sequence. As the children attempted to understand and solve the other two problems it became obvious that this method was inefficient and cumbersome. This point can be illustrated by the fact that when the groups proceeded to the second question five of the seven groups each had a different answer even though their solution strategies were very similar. Through the ensuing discussion there came the realisation that Problems B and C were similar to Problem A but there must be a more efficient way to solve the Counting Coins and A Kings Ransom problems. One child explained this to her group as follows:

Ashley: There has to be a better way (and takes the calculator). It takes us too long to do the other two problems. There's 'gotta' be a pattern. It's like what Mr H showed us the other day with Pascal's Triangle.

At this point, the children were encouraged to use counters or a diagram to explore the first problem again. (See Figure 2). One of the groups who used a table commented that it reminded them of their rainbow facts.

Peter: *This is like the rainbow facts we did in grade one.*
 James: (Laughing) *They all add to 13.*
 Teacher: *All of them?*
 James: *Yeah see. 1 and 12, 2 and 11, 3 and 10.* (Runs his fingers over the connecting lines)
See they all add up to 13.
 Peter: *You add them?*
 Teacher: *Is there a better way than simply adding 13 each time?*
 Peter: (Starts tapping his pencil beside each 13).
 James: (Looking at the teacher). *Is it the same as multiplication?*
 Peter: (Picks up his calculator and enters 13×6) *Seventy-eight. It's the same as our answer.*

Figure 2. Chiming Clock solution similar to the “Peter and James” case.

As the lesson continued, three groups used counters to illustrate the Chiming Clock problem. (See Figure 3.) Each group represented a chime as a counter, with one counter representing 1 o'clock; two counters 2 o'clock and so on. The teacher moved to a group as a member from another group also watched the following episode.

Teacher: (Moves the single counter in the first row to the last row.
 Then moves the next two counters to the second last row).
 Annie: (Moves the next three counters into third last row, then the next four counters and so on). *There's six rows of 13 so 78 chimes. So all you do is add the numbers and multiply by the number* (pauses) *of pairs.*
 Teacher: *Does it work for the other problems?*

Figure 3. Using counters to interpret the Chiming Clock problem.

Annie and her group were then observed experimenting with other sequences. Importantly, the teacher let Annie and her group continue their exploration. Her group spent the remaining 25 minutes making different arithmetical sequences and comparing their solutions with a calculator. (See Figure 4.) As her teacher was walking past to attend to another group Annie commented, “And all you need to do is the same for all of the problems?” Her teacher acknowledged this statement with an approving nod.

Figure 4. An example of Annie's thinking using the counters.

I infer from Annie's explanation and her group's use of the counters that the multiplicative structures of the problem were more apparent to groups who decided to use the materials. Using the counters suggested to the children an arrays model for multiplication that was more easily understood by this class. In the next phase of the lesson, her group discussed the Counting Coins and A Kings Ransom problems. Consequently they were also able to explain their solution algebraically and in general terms at a rhetorical level, moving into the syncopated phase. The group inferred that for

the Counting Coins problem and A Kings Ransom problem that the same ideas existed in each of the problems respectively. (See Figure 5).

- Teacher: *How did you find a solution so quickly? Come up to the front and show us.*
 (points to an overhead projector and hands Paul a pen).
 Paul: *Well, we knew the numbers added to 31 and divided 30 by two. So it was 31 multiplied by 15 which is \$465* (He writes the number sentences on the overhead projector).
 Teacher: *Can you do it with the other problems?*
 Paul: *They're all the same. You can solve them the same way.*

Handwritten work from a student's notebook:

$1+64=65$
 $2+63=65$
 $3+62=65$
 etc
 There are 32 combinations, all equaling 65, so 32×65 will equal how many gold coins

$1+64=65$
 $2+63=65$
 \downarrow
 32
 2164

$\begin{array}{r} 65 \\ \times 32 \\ \hline 130 \\ 1950 \\ \hline 2080 \end{array}$ gold coins

Figure 5. An excerpt from a student's work book.

The lesson concluded with the teacher asking “What would happen if we wanted to sum successive even numbers or successive odd numbers? What would happen if we started at a number other than one or there was not an even number of values?” The ability for the class to use the generalisations they had developed during the lesson created opportunities to shift their thinking from a purely answer focused perspective of mathematics. The sample episodes show an increasing sophistication in the way students worked through the problems. In the course of the lessons, the students explained and justified their responses to each other and were more productive in their capacity to develop generalisations about the problems.

Discussion and Conclusion

Developing algebraic thinking using a problem solving approach may build upon and extend the teaching practices used within many classrooms. However, it may compel some teachers to see problem solving from a different perspective. At a minimum it entails seeing problem solving as an opportunity to enrich and transform students' thinking rather than the ‘ferreting out’ of an answer. One of the distinctive characteristics of this approach is that it requires teachers to adapt and change the problems, yet maintain the mathematical generalisations present within the problems. Through appropriate discourse teachers can encourage students to think algebraically rather than influencing them to use a particular strategy or procedure. It is through discussion during the solving process that ideas relating to algebraic thinking and an algebraic perspective of mathematics can be developed. Encouraging students to reflect on their thinking and share their experiences can assist in students developing different ways of thinking about problems. As Silver et al (2005, p. 13) observes:

The presentation of multiple solutions and the consideration of connections between and among different approaches to a problem could be seen as opportunities to advance the mathematical agenda.

A central challenge in addressing reforms in algebra can be addressed at many levels. As Thomas quietly commented at the end of his class discussion, “This is like that algebra stuff they will teach us at high school. It’s not really different to what we do at the moment.” If the themes I have identified for developing algebraic thinking address only students’ perceptions of algebra in a positive manner than the merits of advocating a problem solving approach should warrant further investigation. Moreover, the benefit for developing students’ algebraic thinking beyond the mechanics and procedures often associated with algebra can possibly offer students a more complex and meaningful conceptualisation of algebra. Using a problem solving approach to develop algebraic thinking and providing an algebraic perspective of mathematics may enhance the long-term learning trajectory of the majority of students.

References

- Bednarz, N. & Janvier, B. (1996). Emergence and development of algebra as a problem solving tool: Continuities and discontinuities with arithmetic. In N. Bednarz, C. Kieran & L. Lee (Eds.) *Approaches to algebra: Perspectives for research and teaching* (pp. 115-136). Dordrecht, NL: Kluwer Academic Publishers.
- Booker, G., Bond, D., Sparrow, L. & Swan, P. (2010). *Teaching primary mathematics (4th ed.)*. Sydney, NSW: Pearson Education Australia.
- Booker, G. & Bond D. (2009). *Problem-solving in mathematics*. Perth, WA: RIC Publications.
- Carpenter, T. P., Loef Franke, M. & Levi, L. (2003). *Thinking mathematically: Integrating arithmetic and algebra in elementary*. Portsmouth, NH: Heinemann.
- Carraher, D. W., Schliemann, A. D. & Brizuela, B. M. (2003). *Bringing out the algebraic character of arithmetic: From children’s ideas to classroom practice* [Electronic version]. Mahwah, NJ: Lawrence Erlbaum Associates. Retrieved 5 May 2009, from <http://www.earlyalgebra.terc.edu/publications.htm>
- Clement, J. Lochhead, J. & Monk, G. S. (1981). Translation difficulties in learning mathematics. *American Mathematical Monthly*, 88, 286-290.
- Harper, E. (1987). Ghosts of Diophantus. *Educational Studies in Mathematics* 18, 75-90.
- Human Capital Working Group, Council of Australian Governments (2008). *National numeracy review report: May 2008* [Electronic version] Retrieved 8 November 2008 from www.coag.gov.au/reports/docs/national_numeracy_review.pdf
- Kaput, J. J. (2008). What is algebra? What is algebraic reasoning? In J. J. Kaput, D. W. Carraher & M. L. Blanton (Eds.), *Algebra in the early grades* (pp. 235–272). New York: Lawrence Erlbaum Associates.
- Lannin, J., Barker, D. & Townsend, B. (2006). Algebraic generalisation strategies: Factors influencing student strategy selection. *Mathematics Education Research Journal*, 18(3), 3-28.
- Lee, L. (2001). Early algebra – But which algebra? In H. Chick, K. Stacey, J. Vincent & J Vincent (Eds.), *The future of the teaching and learning of algebra* (Proceedings of the 12th ICMI Study Conference, pp. 392 – 399). Melbourne, Australia: University of Melbourne.
- Lins, R., Rojano, T., Bell, A. & Sutherland, R. (2001). Approaches to algebra. In R. Sutherland, T. Rojano, A. Bell & R. Lins (Eds.), *Perspectives on school algebra* (pp. 1-11). Dordrecht, NL: Kluwer Academic Publishers.
- Kaput, J. J. (2008). What is algebra? What is algebraic reasoning? In J. J. Kaput, D. W. Carraher & M. L. Blanton (Eds.), *Algebra in the early grades* (pp. 235-272). New York: Lawrence Erlbaum Associates.
- Kaput, J. J., Blanton, M. J. & Moreno, L. (2008). Algebra from a symbolization point of view. In J. J. Kaput, D. W. Carraher & M. L. Blanton (Eds.), *Algebra in the early grades* (pp. 19-55). New York: Lawrence Erlbaum Associates.
- Katz, V. and B. Barton (2007). Stages in the history of algebra with implications for teaching. *Educational Studies in Mathematics* 66 (2), pp.185-201.
- Krutetski, V. A. (1976). *The psychology of mathematical abilities in schoolchildren* (J. Teller, Trans) Chicago, IL: University of Chicago Press.

- Mason, J., Graham, A. & Johnston-Wilder, S. (2005). *Developing thinking in algebra*. London, UK: Paul Chapman Publishing.
- National Council of Teachers of Mathematics. (2000). *Principles and standards for school mathematics*. Reston, VA: NCTM.
- National Curriculum Board. (2008). *National mathematics curriculum: Framing paper*. Retrieved 8 December 2008, from www.ncb.org.au
- Polya, G. (1973). *How to solve it: A new aspect of mathematical method 2nd edition*. Princeton, NJ: Princeton University Press.
- Schliemann, A. D., Carraher, D. W. & Brizuela, B. M. (2007). *Bringing out the algebraic character of arithmetic: From children's ideas to the classroom*. Mahwah, N. J.: Lawrence Erlbaum.
- Schoenfeld, A. H. (1992). Learning to think mathematically: Problem solving, metacognition, and sense-making in mathematics. In D. Grouws (Ed.), *Handbook for Research on Mathematics Teaching and Learning* (pp. 334-370). New York: MacMillan.
- Silver, E. A., Ghouseini, H., Gosen, D., Charalambous, C. & Strawhun, B.T.F. (2005). Moving from rhetoric to praxis: Issues faced by teachers in having students consider multiple solutions for problems in the mathematics classroom. *Journal for Mathematical Behavior*, 24, 287-301.
- Stanic, G. & Kilpatrick, J. (1989). Historical perspectives on problem solving in the mathematics curriculum. In R. Charles & E. Silver (Eds.) *The teaching and assessing of mathematical problem solving* (pp. 1-22). Reston, VA: National Council of the Teachers of Mathematics.
- van Amerom, B. A. (2002). *Re-invention of early algebra: Developmental research on the transition from arithmetic to algebra*. Unpublished doctoral thesis, Netherlands: University of Utrecht.

Equivalent Fractions: Developing a Pathway of Students' Acquisition of Knowledge and Understanding

Monica Wong
University of Sydney
monica.wong@optusnet.com.au

Learning pathways capture the development of competence in a mathematical domain. They have been developed from empirical studies in the areas of mental computation and emergent numeracy concepts. These pathways afford teachers the opportunity to identify students' current levels of understanding, antecedent understandings and the steps that are likely to result in students achieving a more sophisticated level of understanding. A pathway of the skills and knowledge that students acquire in developing conceptual understanding of fraction equivalence was developed through the assessment of 649 students from Grades 3 to 6 attending six primary schools. The assessment, analysis of data and hypothesised pathway for area models are described in this paper.

Many students are unable to construct or identify equivalent fractions (Bana, Farrell, & McIntosh, 1997; Pearn, 2003; Siemon, Virgona, & Corneille, 2001). Ni (2001) laments that understanding of fraction equivalence is often reduced to “mastery of the rule ‘multiply or divide the numerator and denominator of a fraction by the same number’” (p. 413), with many students resorting to the application of a memorised rule or inventing their own.

To advance students' learning with understanding, teachers must gain insight into the paths students follow in developing understanding of fraction equivalence. Learning pathways are one method of capturing students' development of competence in a subject-matter domain. They are considered an evidence-based model of learning which depicts students “as starting out with little or no knowledge in the domain and through instruction gradually building a larger and larger knowledge base” (National Research Council [NRC], 2001b, p. 182). Such developmental models can be used to identify students' current levels of understanding, antecedent understandings, and the steps that are likely to result in students achieving a more sophisticated level of understanding (NRC, 2001b).

This paper describes a section of a larger three-phase study. The first phase comprised the development of a pencil and paper instrument, the *Assessment of Fraction Understanding (AFU)*, which was used to measure students' conceptual understanding of fraction equivalence (Wong, 2009). During Phase Two, *AFU version 1* was administered to 297 students. After analysis of the results, the instrument was reviewed and revised, resulting in the creation of *AFU version 2*, which was administered to another 349 students during Phase Three. The process of developing a pathway to capture one potential route to understanding fraction equivalence using area models, which incorporates the quantitative components of Phases Two and Three, is discussed in this paper.

Theoretical Perspective

Learning Pathways

Learning pathways have been developed from empirical studies in many areas of mathematics. Some studies such as Siemon et al. (2001) examined numeracy with particular focus on assessing students' knowledge of “key, underpinning mathematical ideas and their capacity to apply and communication this knowledge in context” (p. 6).



This was achieved by assessing students using a pencil and paper test incorporating open-ended written questions. The use of Rasch analysis enabled the development of an eight-level numeracy pathway, which included “rich descriptions of distinct developmental levels” (Siemon et al., 2001, p. 29).

Students’ mental computational competence in the area of fractions, decimals and percentages was assessed by Callingham and Watson (2004). Like Siemon et al. (2001), Callingham and Watson used a pencil and paper assessment and employed Rasch analysis to develop their *Levels of Mental Computational Competence*. Questions/items of comparable difficulty and cognitive demand were grouped together to describe possible levels of competence. Students with the lowest level of competence could answer only the easiest items, while only more competent students were able to complete the most difficult tasks.

Learning pathways have also been developed to support emergent numeracy learning (Mulligan, Looever, & Busatto, 2006). However, an evidence-based pathway for understanding fraction equivalence is missing. The development of such a pathway will enable the identification of students’ knowledge of fraction equivalence and their misconceptions, thus providing a platform on which teachers can base their lessons to improve students’ understanding.

Equivalent Fraction Domain

A review of fraction literature (e.g., Cathcart, Pothier, Vance, & Bezuk, 2006; Lamon, 2005; NRC, 2001a) reveals that knowledge and understanding of fraction equivalence encompasses more than the procedure of multiplying or dividing the numerator and denominator of a fraction by the same number. Students with conceptual understanding of fraction equivalence have an integrated knowledge and are able to display and articulate the following five attributes.

1. A fraction represents a quantity being measured in relation to a referent unit.
2. A fraction quantity can be represented using manipulatives or pictorially by partitioning area, collection or number-line models.
3. Equivalent fractions can be constructed from manipulatives or pictorial representations by repartitioning or chunking.
4. Equivalent fractions can be constructed using symbolic notation.
5. A fraction quantity is a member of an equivalence class in which all fraction numerals represent the same quantity.

Students can represent this mathematical knowledge in various ways, using representations which comprise some of, or all five interrelated elements of spoken language, written language, manipulatives, pictures and real world situations (Lesh, Landau, & Hamilton, 1983). Examples of the different representational elements for the fraction one-quarter are depicted in Figure 1. Students who possess conceptual understanding know when and how these representations can be used for different purposes. They are able to co-ordinate links or map from one representation to another (e.g., pictorial to symbolic) and within representations (e.g., area to number-line diagrams).



Figure 1. Examples of representational elements for the fraction one-quarter.

Assessing Students' Conceptual Understanding of Fraction Equivalence

For teachers to verify when learning has occurred, students must be provided with opportunities to demonstrate what they have learnt. Hence, the *Assessment of Fraction Understanding* (AFU), a pencil and paper assessment incorporating tasks, which addressed the five fundamental aspects of conceptual understanding, was developed (Wong, 2009). It was used to assess students' conceptual understanding of fraction equivalence, using pictures and written language. These data enabled the exploration of the following research question: "What learning pathway do students travel on their journey to development of conceptual understanding of fraction equivalence incorporating area models?" In formulating a model of students' development of knowledge and understanding of fraction equivalence, the National Research Council offers important advice:

There is no single way in which knowledge is represented by competent performers, and there is no single path to competence. But some paths are travelled more than others. When large samples of learners are studied, a few predominant patterns tend to emerge. (NRC, 2001b, p. 182)

Stacey and Steinle (2006) suggest that pathways reflect teaching practices, while Moseley (2005) advises that students' exposure to fraction perspectives is influenced by the curriculum. Irrespective of these concerns, it is identification of a pathway that the majority of students travel towards conceptual understanding of fraction equivalence that is the focus of this paper.

The Study

Participants, Data Collection and Instruments

Data collection was conducted across Phase Two and Phase Three as depicted in Figure 2. Six hundred and forty-six students in Grades 3 to 6 attending six co-educational urban primary schools (three Catholic and three government) participated in the study. During Phase Two, all students were administered the *Assessment of Fraction Understanding version 1* (AFUv1), which comprised 31 constructed-response questions, some with multiple parts, which resulted in 47 items for Rasch analysis (Wong, 2009). All instruments were reviewed by mathematics educators, instrument designers and other researchers during development.

The results of Phase Two data analysis informed the construction of *Assessment of Fraction Understanding version 2* (AFUv2), as shown in Figure 2. Unreliable items from *AFUv1*, those identified with layout inconsistencies, issues with wording and clarity of instruction, were removed or reworded and more items added to create *AFUv2*. *Form A* comprised 25 questions or 32 items, while *Form B* comprised 27 questions or 35 items. Twenty-five items were common across *Form A* and *Form B*, of which 16 were retained from *AFUv1*. Each instrument is detailed in Wong (2009). During Phase Three, students were administered either *Form A* or *Form B* depending on their grade level, as shown in Figure 2. All assessments were administered following standardised protocols. Participants were asked to work independently and were allowed 45 minutes to complete the assessment.

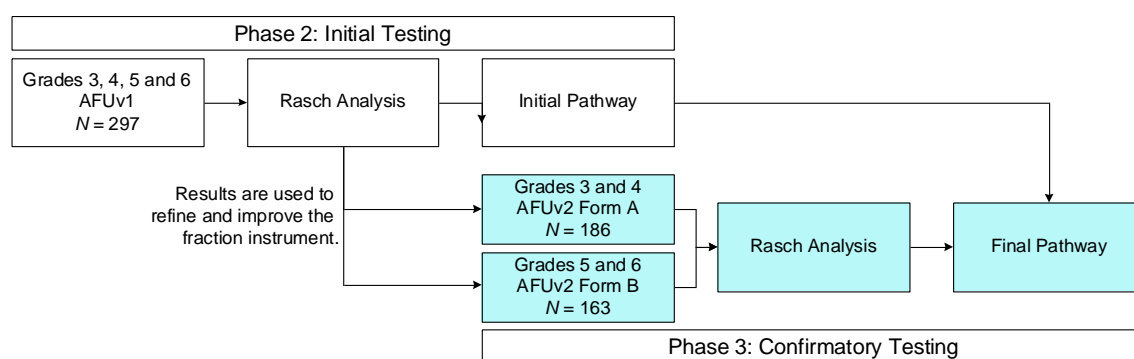

Figure 2. The quantitative data collection and analysis employed in phases two and three of the study.

Rasch Analysis

One key feature of Rasch analysis is that students and the questions or items they attempt can be placed on a common scale (Wright & Stone, 1979). Students from a range of grades can be assessed without the need for all students to be administered all items, as instruments can be designed with common items to allow comparison of students across grades (Wright & Stone, 1979). A set of common items was included across *AFUv1* and *AFUv2* Forms A and B.

Using RUMM2020, the difficulty of each item in the *AFU* was estimated, along with person location or students' conceptual understanding of fraction equivalence on a common logit (log-odds) interval scale. Firstly, the data collected from initial instrument testing were analysed and an initial pathway of understanding was developed. This was followed by a revision of the equivalent fraction instrument, *AFUv2*. Another 349 students were assessed using the *AFUv2* during confirmatory testing. The pathway of understanding was verified and updated with the results of the Rasch analysis from confirmatory testing. A discussion of the final pathway follows.

Results and Discussion

The person-item map produced by RUMM2020 indicates that a person whose person location or trait level matches the difficulty of an item (same horizontal location), has a 50% probability of success on that item. However, Bond and Fox (2007) suggest that an 80% probability of success on an item represents mastery level learning, hence the measure of students' knowledge and understanding in the domain. Therefore, the RUMM2020 person-item map was adjusted by shifting each person's location by 1.4 logits downwards. Thus students and items at the same level represent an 80% chance of success

by the student on that item. For example, the students circled in Figure 3, possess an 80% chance of success for item 4, 5, 7 Form A and 7(b). Items (e.g., 14, 15 and 25) above their level are more difficult, whilst items (e.g., 1, 2 and 3) below are easier.

From the person-item map of Figure 3, a hierarchy of student attainment and conceptual understanding of fraction equivalence tasks was derived. Items within the person-item map were arranged by fraction model – area, collection, number-line or symbolic notation. Four possible levels of understanding were distinguished, as shown by the horizontal lines. These boundaries were determined by grouping items of similar difficulty and features (e.g., fraction size – less than one, unity or greater than one). The lower bound for level 1 was positioned below item 4 Form A (see Table 1 for item description) as rudimentary understanding of fractions incorporates the identification of area representations for one-half (Callingham & Watson, 2004). Below this level, students were unlikely, to consistently answer, even the easiest item correctly.

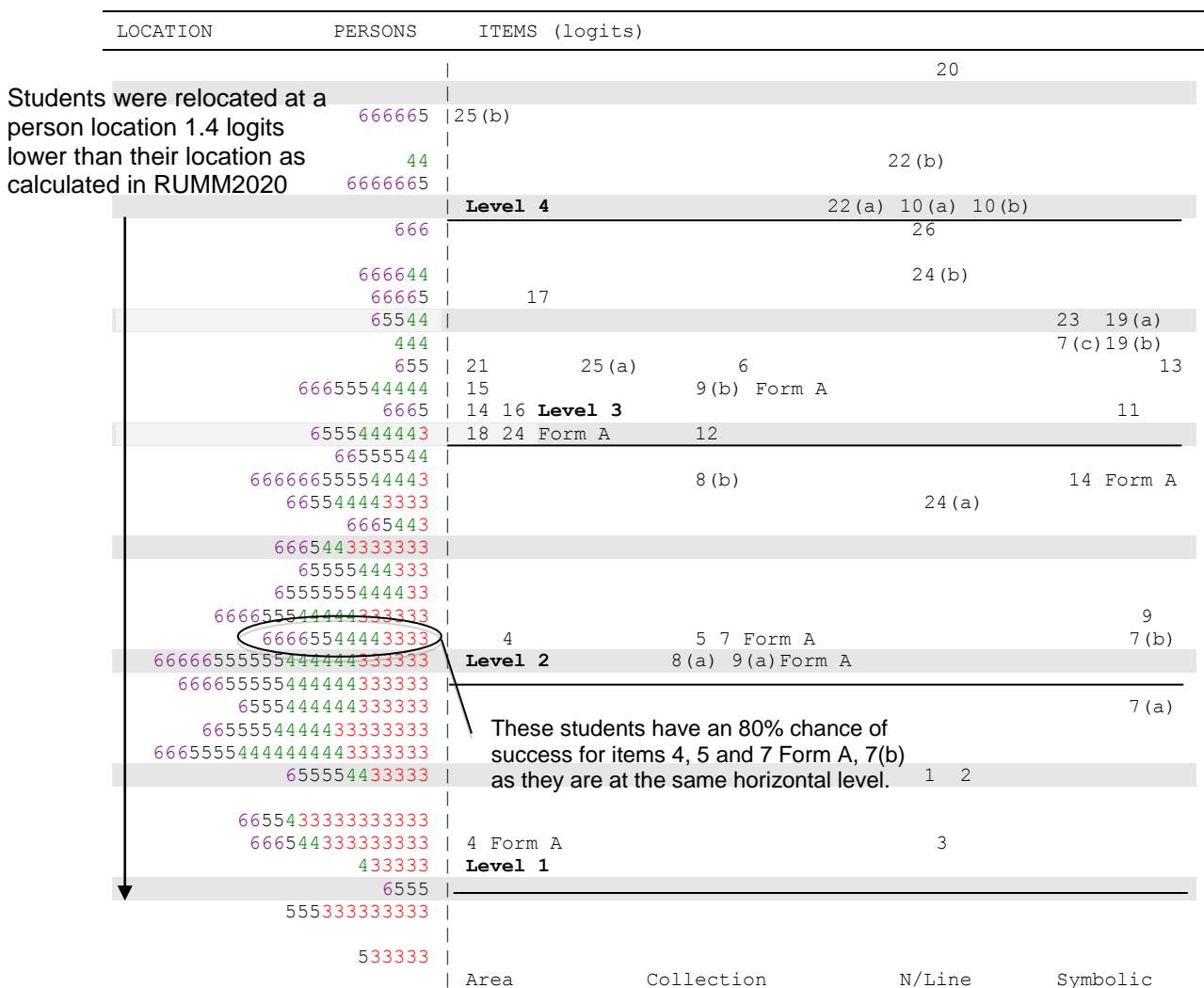

Each 3, 4, 5 or 6 represents one person in his/her respective grade.



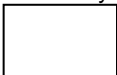
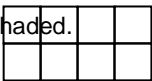

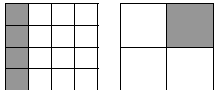

Figure 3. Excerpt of person-item map for AFUv2 showing mastery levels of understanding.

The pathway of understanding exhibited by students participating in this study is described in Table 1. A description of the skills and sample items from the assessment are

included. Although the area pathway is only described in the following section, other pathways exist for number line and collection models (Wong, 2009). While the pathway is presented as a linear progression, students can reside across multiple levels within a pathway.

Table 1

Levels of Understanding of Fraction Equivalence using Area Models

Skill	Example Items
Level 1 (raw score 2 - 8)	
Recognise the quantity half, represented in a simple area model.	4 (Form A). Circle the shapes that have been divided in half. 
Level 2 (raw score 9 - 21)	
Recognise a fraction quantity represented in a simple area model.	4. What fraction has been shaded grey?  Alternative:
Level 3 (raw score 22 - 30)	
Represent a fraction quantity by partitioning an area model.	18. As accurately as possible, shade $\frac{2}{8}$ of the rectangle. 
Represent a fraction quantity using an equivalent representation.	14. In the rectangle, shade enough small squares so that $\frac{3}{4}$ of the rectangle is shaded. 
	15. Shade in $\frac{2}{2}$ of the shape below. 
Recognise the fraction quantity represented.	24 (Form A). Has the same fraction of each large square been shaded? 
	Explain how you know?
Level 4 (raw score 31 - 40)	
Recognise the fraction quantity represented.	25.  This rectangle represents one whole. (a) What do the following represent altogether? (b) Can you think of name for the fraction shaded?

Teachers can monitor and measure students' knowledge and understanding of fraction equivalence by administering either AFUv2 Form A or Form B, without the need to examine students' responses to individual items. Each level of mathematical understanding is described in terms of a raw score, which is calculated by summing the number of correct responses from the assessment. Using a student's raw score, the student can be located within a level of conceptual understanding of fraction equivalence. If the raw score falls at, or near, the boundary between levels, the student may be able to complete some of the tasks above their descriptor level, but not consistently. Students possess approximately an 80% probability of being able to perform the skills identified at their particular level.

The first level pertains to recognising representations of the fraction one-half. Hart (1981) reported children “appear to recognise equivalents of a half and to deal with them in a different way to other fractions” (p. 76). It does not necessitate students to link the notion of half to one of two equal pieces with Hayward and Fraser (2003) confirming that students with limited understanding refer to any part of a whole, irrespective of size as “half” or “quarter”.

Students achieved understanding corresponding to Level 2, when they were able to identify a fraction represented by a simple representation (see Item 4, Table 1). A “double counting” process can be used to determine the fraction shaded, whereby, the shaded component represents the numerator and the total number of equi-sized parts represents the denominator. Students located below Level 2 on the person-item map of Figure 3, achieved a raw score of eight or less. These students lacked the knowledge that a fraction represents a relationship between a part, measured in relation to a whole, as they exhibited whole number counting by responding with the answer ‘three’ to Item 4.

Students achieved understanding consistent with Level 3, when they were able to partition an area model accurately. The majority of students partitioned the rectangle in Question 18 (see Table 1) into 8 equi-sized parts, shading two of them. The most prevalent errors incorporated partitions of unequal size. In some instances, students partitioned from one side, resulting in too few or too many partitions. For students with limited knowledge and understanding, inaccurate drawings thwarted their attempts at generating consistent and correct answers, similar to the findings of Hayward and Fraser (2003). Only 7% of students exhibited and applied their knowledge of fraction equivalence by converted $\frac{2}{8}$ to its equivalent $\frac{1}{4}$, and shaded one-quarter of the entire shape. These students possessed stable knowledge as they also completed Items 14 and 15 (as shown in Table 1) correctly.

Students located within Level 3 were also able to repartition a fraction quantity, using alternate equi-sized parts to derive a different fraction name (Lamon, 2005). These students were able to successfully shade $\frac{3}{4}$ of a shape divided into eight parts (see Item 14, Table 1). In contrast, students below this band exhibited limited understanding by shading only three small squares. A similar response was observed for the fraction $\frac{2}{2}$, where students shaded two parts. Thus, representing fractions using equivalent representations requires greater understanding and an increase in cognitive demand (Callingham & Watson, 2004), compared to items incorporating simple representations.

At the highest level of understanding, students were required to identify the fraction $1\frac{3}{4}$ and name an equivalent fraction (see Item 25, Table 1). Although the unit or whole was explicitly defined, students demonstrated unstable knowledge by combined both units to create a new composite unit (Vance, 1992), thus providing the response $\frac{7}{8}$. Few students were able to find an equivalent fraction for their response to Part (a). Hence, a quantity greater than one was more difficult for students to represent or recognise than those less than one.

Conclusion

The pathway identified from the study reflects one pattern of the development of conceptual understanding of fraction equivalence using area models, and captures the expectations of the *Mathematics K-6 Syllabus* (Board of Studies NSW, 2002). This pathway represents the knowledge gathered from Grade 3 to 6 students, attending six primary schools from two educational sectors. This diversity should reduce some of the

effects of teaching practices and fraction perspectives promoted by individual schools and teachers. The pathway of understanding fraction equivalence should provide a valuable tool for teachers. Knowledge that students have mastered, and knowledge required to achieve a more sophisticated level of understanding, can be identified for any student who completes the *Assessment of Fraction Understanding version 2*. Therefore, implementation of the assessment and pathway in the classroom by teachers is the next step in verifying their accuracy and usefulness, which has been planned for future investigation.

References

- Bana, J., Farrell, B., & McIntosh, A. (1997). Student error patterns in fraction and decimal concepts. In F. Biddulph & K. Carr (Eds.), *People in Mathematics Education* (Proceedings of the 20th annual conference of the Mathematics Research Group of Australasia, pp. 81-87). Rotorua, New Zealand: MERGA.
- Board of Studies NSW. (2002). *Mathematics K-6 Syllabus*. Sydney, Australia: Author.
- Bond, T. G., & Fox, C. M. (2007). *Applying the Rasch model: Fundamental measurement in the human sciences* (2nd ed.). Mahwah, NJ: Erlbaum.
- Cathcart, W., Pothier, Y., Vance, J., & Bezuk, N. (2006). *Learning mathematics in elementary and middle schools: A learner-centred approach* (4th ed.). Upper Saddle River, NJ: Pearson Prentice Hall.
- Callingham, R., & Watson, J. (2004). A developmental scale of mental computation with part-whole numbers. *Mathematics Education Research Journal*, 16, 69-86.
- Hart, K. (1981). Fractions. In K. Hart (Ed.), *Children's understanding of mathematics: 11-16* (pp. 66-81). London: John Murray.
- Hayward, B., & Fraser, C. (2003). Scaffolding concepts for the primary school learner with reference to the teaching of common fractions: Bruner's forgotten model of learning. In D. L. Fisher & T. A. Marsh (Eds.), *Proceedings of the 3rd international conference on Science, Mathematics and Technology Education* (pp. 633-648). Grahamstown, South Africa: SMTE.
- Lamon, S. J. (2005). *Teaching fractions and ratios for understanding* (2nd ed.). Mahwah, NJ: Lawrence Erlbaum.
- Lesh, R. A., Landau, M., & Hamilton, E. (1983). Conceptual models and applied mathematical problem-solving research. In R. A. Lesh & M. Landau (Eds.), *Acquisition of mathematics concepts and processes* (pp. 263-341). New York: Academic Press, Inc.
- Moseley, B. (2005). Students' early mathematical representation knowledge: The effects of emphasizing single or multiple perspectives of the rational number domain in problem solving. *Educational Studies in Mathematics*, 60, 37-69.
- Mulligan, J., Looever, J., & Busatto, S. (2006). The development of a numeracy achievement scale to assess progress from kindergarten through to year 6. *ACSPRI Social Science Methodology Conference 2006*. Retrieved 7 September 2007, from <http://www.acspri.org.au/conference2006/proceedings/>.
- National Research Council. (2001a). *Adding it up: Helping children learn mathematics*. Washington: National Academy Press.
- National Research Council. (2001b). *Knowing what students know: The science and design of educational assessment*. Washington: National Academy Press.
- Ni, Y. (2001). Semantic domains of rational numbers and the acquisition of fraction equivalence. *Contemporary Educational Psychology*, 26, 400-417.
- Pearn, C. (2003). Fractions: Using the measurement model to develop understanding. In M. Goos & T. Spencer (Eds.), *Making Waves* (Proceedings of the 19th Biennial Conference of the Australian Association of Mathematics Teachers, Brisbane, pp. 404-410). Adelaide: AAMT.
- Siemon, D., Virgona, J., & Corneille, K. (2001). *The middle years numeracy research project: 5 – 9, Final Report*. Bundoora, VIC.: RMIT University.
- Stacey, K., & Steinle, V. (2006). A case of the inapplicability of the Rasch model: Mapping conceptual learning. *Mathematics Education Research Journal*, 18, 77-92.
- Vance, J. H. (1992). Understanding equivalence: A number by any other name. *School Science and Mathematics*, 92, 263-266.
- Wong, M. (2009). *Assessing students' knowledge and conceptual understanding of fraction equivalence*. Unpublished doctoral thesis, University of Sydney, NSW, Australia.
- Wright, B. D., & Stone, M. H. (1979). *Best test design*. Chicago: MESA Press.

Mathematics Attitudes and Achievement of Junior College Students in Singapore

Lim Siew Yee
Hwa Chong Institution
<tohsy@hci.edu.sg>

Studies that investigated students' attitudes toward mathematics and its relationships with achievement are scarce in Singapore. To address this issue, the mathematics attitudes and achievement of 984 junior college students were measured. Results indicated that students had positive attitudes toward mathematics but lacked intrinsic motivation to do mathematics. Students were extrinsically motivated to study mathematics, but the relationship between extrinsic motivation and achievement was weak. However, there was a significant positive correlation between intrinsic motivation and achievement. This is contrary to the beliefs of many educators and parents in Singapore who believe in extrinsic rewards and punishments to encourage better achievement. This study suggests that Singapore educators and parents should focus more on how to motivate students intrinsically.

Positive attitudes toward mathematics is a key intended outcome of mathematics learning in Singapore (Ministry of Education, 2008). However, the few studies that investigated Singapore students' attitudes toward mathematics could not produce conclusive results (Ang, 2009). Moreover, many of these studies did not measure motivation even though it is a key dimension of attitudes (Tapia, 1996). In addition, even though the relationships between attitudes and achievement in mathematics have been widely studied (Ma & Kishor, 1997), such studies are scarce in Singapore (Fan et al., 2005).

This study investigated Singapore students' attitudes toward mathematics, as a multi-dimensional construct with motivation as a key dimension, and investigated the relationships between attitudes toward mathematics and achievement in mathematics. The results of this study can potentially highlight to educators the domains of attitudes that students are weak at, and help educators decide the domains of attitudes to focus on in their interactions with students.

Literature Review

Attitudes toward Mathematics

Attitudes are defined as positive or negative emotional dispositions (Aiken, 2000; McLeod, 1992). However, the exact definition of attitudes toward mathematics varies (Akinsola & Olowojaiye, 2008). Zan and Martino (2007) suggest that the definition of attitudes is dependent on the problems that the researcher is dealing with, and is linked to the choice of the measuring instruments, which are discussed in the Methodology section.

Motivation in Mathematics

Motivation is a key domain of attitudes which is often insufficiently addressed in studies on attitudes toward mathematics. According to self-determination theory (Deci & Ryan, 1985), motivation can be categorised into three broad categories, namely amotivation, extrinsic motivation and intrinsic motivation. These three categories of motivation exist on a continuum according to the level of self-determination underlying the



motives behind behaviours. Figure 1 illustrates this continuum which is adapted from Deci and Ryan (2000).

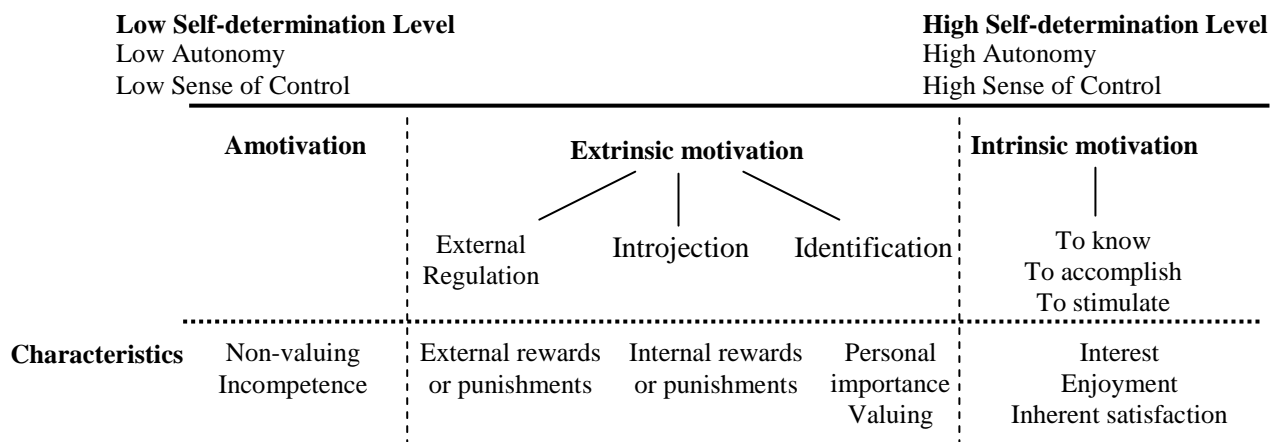

Figure 8. Self-Determination Continuum.

Amotivation lies on the extreme left of the self-determination continuum and occurs when individuals feel that an activity has no value, do not feel competent to complete a task, or do not expect any desirable outcome from the activity (Ryan & Deci, 2000).

Extrinsic motivation refers to the desire to engage in an activity because it leads to an unrelated outcome (Deci, 1972; Spaulding, 1992). On the self-determination continuum, extrinsic motivation is further categorised, from lower to higher level of self-determination, into external regulation, introjection and identification (Vallerand et al., 1992). External regulation is caused by externally imposed rewards or punishments (Vallerand et al., 1992). Introjection takes place when individuals internalise the reasons for their behaviours and impose their own rewards or constraints (Hayamizu, 1997). Finally, identification occurs when an individual identifies with the reason for behaving in a particular manner. The behaviour is valued by the individual and occurs because the individual chooses to do so. Identification differs from intrinsic motivation because pleasure or satisfaction may not be derived in the process of completing the task (Hayamizu, 1997).

Intrinsic motivation lies on the extreme right of the continuum, which is characterised by high autonomy and sense of control (Deci & Ryan, 2000). It refers to an inner desire to accomplish a task, and pleasure is derived in the process (Berlyne, 1965; Deci, 1975). Vallerand et al. (1992) further categorise intrinsic motivation into intrinsic motivation to know, to accomplish things, and to experience stimulation.

Singapore Students' Attitudes Toward Mathematics

There are very few quantitative studies that investigated students' attitudes toward mathematics in Singapore. Lim-Teo, Ahuja and Lee (2000) provide one such study on 388

students from seven junior colleges in Singapore. This reported that about half of the participants have negative attitudes toward the learning of calculus. Specifically, 70% of the participants found calculus difficult and almost 50% did not enjoy learning calculus.

Similar results on secondary school students in Singapore were reported by Fan et al. (2005). Data collected from 1215 students in eight secondary schools indicated that only 49% of the participants liked to spend time on mathematics. This suggested that almost half of the participants were not intrinsically motivated in mathematics (Gottfried, 1985).

The above results must be interpreted with care. Some aspects of Lim-Teo, Ahuja and Lee (2000)'s experimental design, such as how the participants were chosen, was not documented in detail. In Fan et al. (2005)'s study, threats to external validity were decreased by using a stratified random sampling method to select both above average and below average schools in terms of mathematics ability. However, selection bias might still exist as participants from the chosen schools were not randomly selected.

Methodology

This paper presents the findings of a pilot study that forms part of a larger study on Singapore junior college students' attitudes and achievement in mathematics. Data from 1044 students from a top junior college in Singapore was collected for this pilot study. After omitting data with missing or multiple entries, 984 sets of completed data were used.

Students' achievement in mathematics was measured using a three-hour paper that was equivalent to the GCE 'A' level 9740 H2 mathematics examination in terms of content and difficulty level. Five teachers, each with at least five years of teaching experience assessed the content validity of the paper.

Popular attitudes scales with established psychometric properties were used to measure attitudes toward mathematics. The Attitudes Toward Mathematics Inventory (ATMI) (Tapia & Marsh, 2004) consists of 40 items that measured four factors, namely enjoyment, general motivation, self-confidence and value. Validity and reliability have been established for high school (Tapia & Marsh, 2004) and college students (Tapia & Marsh, 2002). As the ATMI does not measure anxiety, which is an important domain of attitudes toward mathematics (Hyde, Fennema, Ryan, Frost, & Hopp, 1990), the mathematics anxiety subscale in the Fennema-Sherman Mathematics Attitudes Scales (FSMAS) which consists of 12 items, was added to the list of statements that was used for this study.

In addition, the ATMI measures only motivation in general. There is a need for another instrument that measures motivation as a multi-dimensional construct such as the Academic Motivation Scale (AMS) (Vallerand et al., 1992). The AMS is made up of seven subscales that assess amotivation, extrinsic motivation (external regulation, introjection and identification) and intrinsic motivation (to know, to accomplish, and to stimulate). This is in line with the definitions used in this study. Reliability and validity for the AMS have been established for college students (Vallerand et al., 1992). However, the AMS is not constructed to measure motivation for particular subjects and needs to be adapted for mathematics learning before it can be used in this study. The original AMS asks the question "Why do you go to college?" This question was changed to "Why do you study mathematics?" Statements were also adapted. For instance, the statement "Because I experience pleasure and satisfaction while learning new things" is changed to "Because I experience pleasure and satisfaction while learning new things in mathematics".

An exploratory factor analysis performed on the modified AMS showed that the factor structure of the original AMS was retained. However there were cross loadings on the intrinsic motivation to know, to accomplish, and to stimulate. This result was expected as

these three factors are not differentiated on the self-determination continuum in Figure 1. Hence, these three factors were collapsed to form a single factor.

Before the administration of the ATMI, the FSMAS Anxiety subscale and the modified AMS, participants were assured that the results of the pen-and-paper survey would not affect their school grades in any way, and they could choose to remain anonymous or opt out of the study at any point in time.

Results and Discussion

Table 1 shows the means and standard deviations of the various domains of attitudes. All the instruments used in this study use a five-point Likert Scale that ranges from strongly disagree (one point) to strongly agree (five points).

Results from ATMI

This study showed that in general, the participants had positive attitudes toward mathematics. They enjoyed mathematics ($M = 3.30$, $SD = 0.77$), were confident about their ability to do mathematics ($M = 3.34$, $SD = 0.79$) and saw the value of mathematics ($M = 3.49$, $SD = 0.70$). These results are different from the results reported by Lim-Teo, Ahuja and Lee (2000) due to a number of possible reasons. First, Lim-Teo, Ahuja and Lee's study was on the learning of calculus which may be more challenging than other topics in the junior college mathematics syllabus. Second, the participants of this study come from a top junior college, while the participants from Lim-Teo, Ahuja and Lee's study come from seven different colleges. Third, Lim-Teo, Ahuja and Lee used a self-constructed attitudes test that had not been sufficiently tested for validity and reliability. Finally, this study reported on means and standard deviations, while Lim-Teo, Ahuja and Lee presented their findings using percentages of participants who agree or strongly agree to the statements in the attitudes test. To obtain more conclusive results, data will be collected from five other junior colleges once the author receives permission from the Ministry of Education, Singapore.

Results from FSMAS and the Modified AMS

The participants scored a mean of less than three points in the following domains of attitudes measured using FSMAS and the modified AMS: (1) anxiety ($M = 2.80$, $SD = 0.74$), (2) amotivation ($M = 1.97$, $SD = 0.92$), (3) introjection ($M = 2.82$, $SD = 0.89$), and (4) intrinsic motivation ($M = 2.82$, $SD = 0.90$). The first two results are expected as the participants come from a top junior college and studies have shown that mathematics anxiety and amotivation correlate negatively with achievement (Betz, 1978; Karsenti & Thibert, 1995). Table 2 shows that these negative correlations are supported in this study ($r = -0.53$ and $r = -0.42$ respectively).

On the other hand, the participants were generally motivated by external rewards and punishments (external regulation: $M = 3.03$, $SD = 0.95$) and could identify with the reasons for studying mathematics (identification: $M = 3.31$, $SD = 0.90$). These results are supported by Spaulding (1992) who reported that educators tend to rely on external rewards and punishments to motivate students and neglect the importance of intrinsic motivation.

Gender Differences in Mathematics Attitudes and Achievement

Table 3 shows the results of a *t* test performed to compare males' and females' achievement and attitudes toward mathematics. The test failed to show a statistically reliable difference between males' and females' achievement in mathematics ($t(982) = 1.419, p > 0.1$) but showed that males were more confident about their ability to do mathematics than females ($t(982) = 1.419, p < 0.05$). These results are supported by Caplan and Caplan (2005) who did a meta-analysis and found that most studies showed no gender difference in mathematics ability, but males tend to feel more confident about their own mathematics ability than females. There is also a statistically reliable gender difference in mathematics anxiety ($t(982) = 3.59, p < 0.001$), and this is supported by Pajares and Kranzler (1995) who found that females tend to feel more anxious about mathematics than males.

Correlations between Attitudes and Achievement

Table 2 shows that achievement correlated positively with all the domains of attitudes, except for anxiety ($r = -0.53$), amotivation ($r = -0.42$) and external regulation ($r = -0.05$). Among the various domains of attitudes, self-confidence correlated most positively with achievement ($r = 0.60$). These results are supported by other studies (Leung, 2002; Samuelsson & Granstrom, 2007). Specifically, studies have shown that achievement is positively related to self-confidence (Fennema & Sherman, 1977; Leung, 2002), value (Aiken, 1974; Fennema & Sherman, 1977, 1978) and enjoyment (Aiken, 1974). Moreover, results from the Trends in International Mathematics and Science Study suggest that self-confidence and value are positively related to mathematics achievement in Singapore (Martin & Mullis, 2007).

This study also shows that the relationship between achievement and extrinsic motivation was almost non-existent and this is in line with the findings of Ryan (1982) who highlighted that there is no clear relationship between extrinsic motivation and achievement. This is contrary to the beliefs of many educators and parents in Singapore who believe in extrinsic rewards and punishments to encourage better achievement (Sharpe, 2002).

On the contrary, there was a positive correlation between achievement and intrinsic motivation ($r = 0.36$). This result is supported by studies in various countries (Gottfried, Fleming, & Gottfried, 1994; O'Dwyer, 2005; Shen, 2002; Uguroglu & Walberg, 1979). As the participants of this study were not intrinsically motivated to study mathematics ($M = 2.82, SD = 0.90$), there may be a need for educators and parents in Singapore to focus more on motivating students intrinsically.

Conclusion

This study sought to investigate Singapore students' attitudes toward mathematics and the relationship between attitudes and achievement in mathematics. Results show that students had positive attitudes toward mathematics, but more can be done to motivate students intrinsically. Deci (1975) suggests that student's intrinsic motivation can be enhanced by creating opportunities for students to have control over their learning environments and increasing students' perceived competence in completing tasks.

In addition, the relationship between extrinsic motivation and achievement was almost non-existent. This implies that extrinsic rewards and punishments may not be useful in improving students' achievement in mathematics. While self-confidence is found to be

positively correlated with achievement, it may not necessarily imply a cause-and-effect relationship. A cyclical relationship may exist between achievement and self-confidence where good achievement leads to high self-confidence, which in turn leads to greater achievement. The converse may also be true and further studies are required to establish these relationships. In addition, further studies will be conducted in other junior colleges in Singapore to generalise results as the sample for this pilot study comes from only one junior college.

Table 1
Means and Standard Deviations of Domains of Attitudes

		Enjoyment	General Motivation	Self-confidence	Value	Anxiety	Amotivation	External Regulation	Introjection	Identification	Intrinsic Motivation
	(Instrument)	(ATMI)	(ATMI)	(ATMI)	(ATMI)	(FSMAS)	(AMS)	(AMS)	(AMS)	(AMS)	(AMS)
Female (N = 500)	Mean	3.29	2.93	3.27	3.46	2.88	1.91	2.92	2.82	3.27	2.76
	SD	0.76	0.88	0.78	0.63	0.73	0.89	0.93	0.87	0.87	0.87
Male (N = 484)	Mean	3.30	3.15	3.40	3.52	2.71	2.02	3.16	2.83	3.36	2.88
	SD	0.79	0.87	0.79	0.77	0.74	0.95	0.95	0.92	0.91	0.94
Total (N = 984)	Mean	3.30	3.04	3.34	3.49	2.80	1.97	3.03	2.82	3.31	2.82
	SD	0.77	0.88	0.79	0.70	0.74	0.92	0.95	0.89	0.90	0.90

Table 2
Correlations between Domains of Attitudes and Achievement

Variables	1	2	3	4	5	6	7	8	9	10	11
1. Achievement	–										
2. Anxiety	-0.53*	–									
3. Enjoyment	0.48*	-0.73*	–								
4. General Motivation	0.47*	-0.73*	0.87*	–							
5. Self-confidence	0.60*	-0.92*	0.76*	0.76*	–						
6. Value	0.31*	-0.49*	0.68*	0.69*	0.51*	–					
7. Amotivation	-0.42*	0.55*	-0.63*	-0.62*	-0.61*	-0.56*	–				
8. External Regulation	-0.05	0.03	0.02	0.10*	-0.01	0.27*	0.02	–			
9. Introjection	0.09*	-0.18*	0.32*	0.29*	0.22*	0.35*	-0.11*	0.46*	–		
10. Identification	0.16*	-0.28*	0.38*	0.43*	0.31*	0.67*	-0.32*	0.55*	0.39*	–	
11. Intrinsic Motivation	0.36*	-0.57*	0.80*	0.76*	0.60*	0.64*	-0.50*	0.46*	0.50*	0.16*	–

Note. N = 984, *p < 0.01.

Table 3
Gender Differences in Mathematics Attitudes and Achievement

	Achievement	Enjoyment	General Motivation	Self-confidence	Value	Anxiety	Amotivation	External Regulation	Introjection	Identification	Intrinsic Motivation
t	-1.419	0.20	3.90	2.60	1.29	-3.59	1.84	3.99	0.22	1.60	2.03
p	0.156	0.84	0.00	0.01	0.20	0.00	0.07	0.00	0.83	0.11	0.04

Note. Degree of freedom = 982, $\alpha = 0.05$.



References

- Aiken, L. R. (1974). Two scales of attitude toward mathematics. *Journal for Research in Mathematics Education*, 5(2), 67-71.
- Aiken, L. R. (2000). *Psychological Testing and Assessment* (10th ed.). Boston, MA: Allyn and Bacon.
- Akinsola, M. K., & Olowojaiye, F. B. (2008). Teacher instructional methods and student attitudes towards mathematics. *International Electronic Journal of Mathematics Education*, 3(1), 60-73.
- Ang, L. C. (2009). *The Development and Preliminary Validation of an instrument to Measure Year 9 Singaporen Special Stream Students' Attitudes to Mathematics*. The University of Western Australia, Perth.
- Berlyne, D. E. (1965). Curiosity and education. In J. D. Krumboltz (Ed.), *Learning and the Educational Process*. Chicago, IL: Rand McNally.
- Betz, N. (1978). Prevalence, distribution and correlates of math anxiety of college students. *Journal of Counseling Psychology*, 24, 551-558.
- Caplan, J. B., & Caplan, P. J. (2005). The perseverative search for sex differences in mathematics ability. In A. C. Gallagher & J. C. Kaufman (Eds.), *Gender Differences in Mathematics* (pp. 25-47). New York, NY: Cambridge University Press.
- Deci, E. L. (1972). Intrinsic motivation, extrinsic reinforcement, and inequity. *Journal of Personality and Social Psychology*, 22, 113-120.
- Deci, E. L. (1975). *Intrinsic Motivation*. New York, NY: Plenum.
- Deci, E. L., & Ryan, R. M. (1985). *Intrinsic motivation and self-determination in human behavior*. New York, NY: Plenum Press.
- Deci, E. L., & Ryan, R. M. (2000). The "what" and "why" of goal pursuits: Human needs and the self-determination of behaviour. *Psychological Inquiry*, 11, 227-268.
- Fan, L., Quek, K. S., Zhu, Y., Yeo, S. M., Pereira-Mendoza, L., & Lee, P. Y. (2005). *Assessing Singapore students' attitudes toward mathematics and mathematics learning: Findings from a survey of lower secondary students*. Paper presented at the Third East Asia Regional Conference on Mathematics Education, Shanghai, China.
- Fennema, E., & Sherman, J. A. (1977). Sex-related differences in mathematics achievement, spatial visualization and affective factors. *American Educational Research Journal*, 14, 51-71.
- Fennema, E., & Sherman, J. A. (1978). Sex-related differences in mathematics achievement and related factors: A further study. *Journal for Research in Mathematics Education*, 9, 189-203.
- Gottfried, A. E. (1985). Academic intrinsic motivation in elementary and junior high school students. *Journal of Educational Psychology*, 77(6), 631-645.
- Gottfried, A. E., Fleming, J. S., & Gottfried, A. W. (1994). Role of parental motivational practices in children's academic intrinsic motivation and achievement. *Journal of Educational Psychology*, 86, 104 - 113.
- Hayamizu, T. (1997). Between intrinsic and extrinsic motivation: Examination of reasons for academic study based on the theory of internalization. *Japanese Psychological Research*, 39(2), 98-108.
- Hyde, J. S., Fennema, E., Ryan, M., Frost, L. A., & Hopp, C. (1990). Gender comparisons of mathematics attitudes and affect: a meta-analysis. *Psychology of Women Quarterly*, 14(3), 299-324.
- Karsenti, T. P., & Thibert, G. (1995). *What Type of Motivation is Truly Related to School Achievement? A Look at 1428 High-School Students*. Paper presented at the Annual Meeting of the American Educational Research Association.
- Leung, F. K. S. (2002). Behind the high achievement of East Asian students. *Educational Research and Evaluation: An International Journal on Theory and Practice*, 8(1), 87-108.
- Lim-Teo, S. K., Ahuja, O. P., & Lee, P. Y. (2000). Attitude of junior college and tertiary students to calculus. *PRIMUS*, 10(2), 123-142.
- Ma, X., & Kishor, N. (1997). Assessing the relationship between attitude toward mathematics and achievement in mathematics: A meta-analysis. *Journal for Research in Mathematics Education*, 28, 26-47.
- Martin, M. O., & Mullis, I. V. S. (2007). *TIMSS 2007: Asian Students are Top Performers in Math and Science According to Largest-Ever Global Assessment of Student Achievement Released Today by Boston College Researchers*. Boston, MA: Boston College.
- McLeod, D. B. (1992). Research on affect in mathematics education: A reconceptualization. In D. Grouws (Ed.), *Handbook of research on mathematics teaching and learning* (pp. 575-596). New York, NY: Macmillan.



- Ministry of Education. (2008). *A guide to teaching and learning of A-level mathematics 2010*. Singapore: Ministry of Education, Curriculum Planning and Development Division.
- O'Dwyer, L. M. (2005). Examining the variability of mathematics performance and its correlate using data from TIMSS '95 and TIMSS '99. *Educational Research and Evaluation, 11*, 155-177.
- Pajares, F., & Kranzler, J. (1995). Self-efficacy beliefs and general mental ability in mathematical problem solving. *Contemporary Educational Psychology, 20*(4), 426-443.
- Ryan, R. M. (1982). Control and information in the intrapersonal sphere: An extension of cognitive evaluation theory. *Journal of Personality and Social Psychology, 43*, 450-461.
- Ryan, R. M., & Deci, E. L. (2000). Self-determination theory and the facilitation of intrinsic motivation, social development, and well-being. *American Psychologist, 55*, 68-78.
- Samuelsson, J., & Granstrom, K. (2007). Important prerequisite for students' mathematical achievement. *Journal of Theory and Practice in Education, 3*(2), 150-170.
- Sharpe, P. (2002). School days in Singapore: Young children's experiences and opportunities during a typical school day. *Childhood Education, 79*(1), 9-14.
- Shen, C. (2002). Revisiting the relationship between students' achievement and their self-perceptions: A cross-national analysis based on TIMSS 1999 data. *Assessment in Education, 9*, 161-184.
- Spaulding, C. L. (1992). *Motivation in the Classroom*. New York, NY: McGraw-Hill.
- Tapia, M. (1996). *The Attitudes Toward Mathematics Instrument*. Paper presented at the annual meeting of the Mid-south Educational Research Association, Tuscaloosa, AL (ERIC Reproduction Service No. ED 404165).
- Tapia, M., & Marsh, G. E., II. (2002). *Confirmatory factor analysis of the Attitudes Toward Mathematics Inventory*. Paper presented at the Annual Meeting of the Mid-South Educational Research Association, Chattanooga, TN. (ERIC Document Reproduction Service No. ED 471 301).
- Tapia, M., & Marsh, G. E., II. (2004). An instrument to measure mathematics attitudes. *Academic Exchange Quarterly, 8*(2), 16-21.
- Uguroglu, M. E., & Walberg, H. J. (1979). Motivation and achievement: A quantitative synthesis. *American Educational Research Journal, 16*(4), 375-389.
- Vallerand, R. J., Pelletier, L. G., Blais, M. R., Briere, N. M., Senecal, C., & Vallieres, E. F. (1992). The Academic Motivation Scale: A measure of intrinsic, extrinsic, and amotivation in education. *Educational and Psychological Measurement, 52*, 1003-1017.

Three Primary School Students' Cognition about 3D Rotation in a Virtual Reality Learning Environment

Andy Yeh

Queensland University of Technology

<a.yeh@qut.edu.au>

This paper reports on three primary school students' explorations of 3D rotation in a virtual reality learning environment (VRLE) named VRMath. When asked to investigate if you would face the same direction when you turn right 45 degrees first then roll up 45 degrees, or when you roll up 45 degrees first then turn right 45 degrees, the students found that the different order of the two turns ended up with different directions in the VRLE. This was contrary to the students' prior predictions based on using pen, paper and body movements. The findings of this study showed the difficulty young children have in perceiving and understanding the non-commutative nature of 3D rotation and the power of the computational VRLE in giving students experiences that they rarely have in real life with 3D manipulations and 3D mental movements.

Many existing ICT tools such as Logo and Geometer's Sketchpad utilise 2D computer graphics for geometric visualisation and thus have limited applications for the learning of 3D geometry concepts and processes, especially by primary school students. To address this issue, Yeh (2004) developed a Virtual Reality Learning Environment (VRLE) named VRMath that employs virtual reality (VR) 3D computer graphics to facilitate the learning of 3D geometry concepts and processes. This paper reports on the development of three primary school students' conceptions of 3D rotation within the VRLE.

Background

Explorations within 3D space are concerned with not only the investigation of 3D shapes but also the investigation of moving, positioning, orientating, constructing and building of objects within 3D space. One important element of these explorations is the study of rotations within 3D space (Baturu & Cooper, 1993; Queensland Studies Authority, 2004).

However, 3D rotation activities that can be performed in a real environment with concrete objects are limited by the physical condition of the materials and environment, and also by problems with accuracy when performing 3D rotations with concrete objects. A simple question "Will you face the same direction when you turn right 45 degrees first then roll up 45 degrees, or you roll up 45 degrees first then turn right 45 degrees?" puzzles most students and even adults. Intuitively, most people answer that the two 3D rotations end up with the same direction. Unfortunately, this is wrong because 3D rotations are not commutative in nature.

To gain an understanding of the non-commutative nature of 3D rotation in traditional mathematics classroom activities, one generally must have some prior knowledge of the Cartesian 3D coordinate system, trigonometry, and vector and/or matrix notation for 3D translation, scaling, and rotation. These enable accurate operation of 3D rotation and rigorous proof of the nature of 3D rotations. However, this knowledge is far too complex for most primary school children to comprehend. Therefore, if the investigation of 3D rotations is to be integrated into primary school mathematical programs, then new activities which enable young students without knowledge of the Cartesian 3D coordinate



system, trigonometry, and vector and/or matrix notation to meaningfully experience 3D rotation need to be designed. VRMath, the computational VRLE being presented in this paper, has been designed to provide young students with first- and third-person experiences (Pasqualotti & Freitas, 2002) within 3D space that cannot be provided by explorations with concrete objects in the real world. It is hypothesised that these first- and third-person experiences within the 3D virtual environment provided by VRMath will enable primary school children to develop new ways of experiencing and thinking about 3D rotations.

The VRLE (VRMath)

Informed by the fallibilist philosophy of mathematics (Ernest, 1994), semiotics (Cunningham, 1992; Lemke, 2001), constructivist and constructionist learning theories (Harel, Papert, & Massachusetts Institute of Technology(1991). Epistemology & Learning Research Group., 1991; Kafai, 2006; Kafai & Resnick, 1996), a VRLE named VRMath has been developed by Yeh (2004). VRMath comprises three main interfaces, a virtual reality (VR) interface, a programming interface, and a hypermedia and forum interface (see Figure 1).

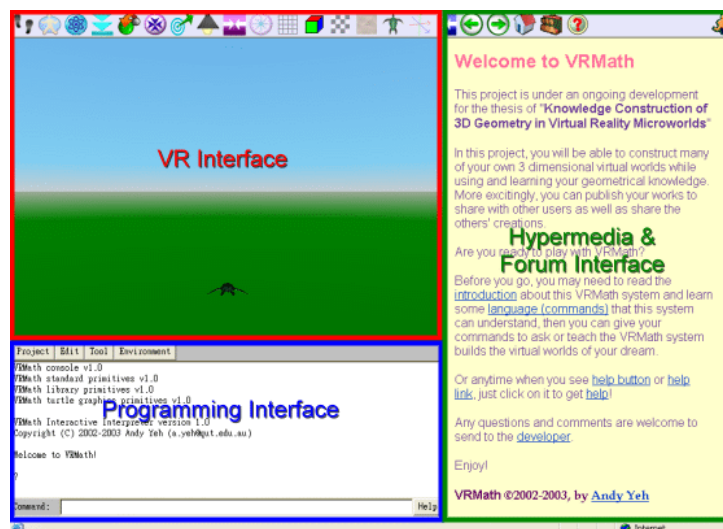

Figure 1. VRMath

VR interface: This is the interactive 3D computer graphics that allows real time visualisation of a 3D virtual space. Users can use mouse and/or keyboard to navigate within the 3D virtual space and view the geometrical objects within the 3D virtual space from different and continuous viewpoints. This kind of 3D navigation is a first-person experience (Pasqualotti & Freitas, 2002) in which the users constantly feel that they are moving. The VR interface also provides the visualisation of the manipulations (e.g., changing location and orientation) of geometrical objects created through the use of programming interface. The manipulation of objects is a third-person experience (Pasqualotti & Freitas, 2002) in which users stay stationarily and the objects are moving. Moving oneself or objects represents two distinguishable human spatial abilities termed spatial orientation and spatial visualisation (McGee, 1979), which can be mapped to first- and third-person imagery respectively. This interface thus enables the cultivation of both spatial orientation and visualisation abilities (Yeh & Nason, 2004a). Amorim, Trumbore, and Chogyen (2000) suggested that giving opportunities to switch between first- and third-person imagery might be of great benefit for the virtual traveller to anticipate new vantage

points and appropriate actions. Therefore, VRMath also implements an Avatar View function in which users can view from the turtle's (see programming interface) viewpoint. In Avatar View mode, the navigation within VR space can only be controlled by the programming commands such as FORWARD, BACK or turning commands. Thus, when manipulating the turtle through programming interface, the Avatar View enables users to switch between first- and third-person experiences. Moreover, when in Avatar View mode and the turtle's orientation is manipulated by a mathematical program through programming interface, users can also perceive what has been termed by Elliott and Bruckman (2002) as "mathematical movement" (e.g., the movement of sine wave in parametric equations).

Programming interface: This interface implements a Logo style language with an extended set of 3D related commands. Because of the nature of the VR interface, many geometric concepts in the VRLE environment differ from the traditional 2D Logo environment. For example, VRMath has a 3D turtle in VR space. VRMath uses metre and centimetre as the distance unit while traditional Logo uses pixels on the screen. To enable 3D rotation and movement, VRMath implements another four rotational or turning commands: ROLLUP (RU), ROLLDOWN (RD), TILTLEFT (TL), TILTRIGHT (TR) in addition to the traditional LEFT (LT) and RIGHT (RT). VRMath also has many built-in 3D shape commands such as CUBE, SPHERE, CYLINDER and CONE for easy creation of 3D models in the VR space. Figure 2 presents visual images of the effect of the 3D turning commands.

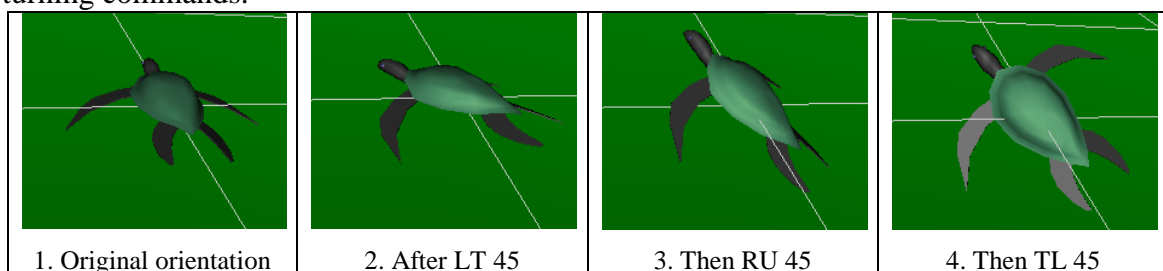

Figure 2. 3D Rotation in VRMath

Hypermedia and forum interface: This is the frame on the right side of VRMath containing hypermedia documentations and an online discussion forum. This is designed to provide non-linear and rich information and a channel for users to express and communicate ideas. With proper scaffoldings, this interface can be a pertinent vehicle for collaborative learning (Yeh & Nason, 2004b).

Method

There were three participants involved in this research study, Rosco, Bonbon, and Grae (their pseudonyms), who were aged 9 or 10 years old. They came from an inner city primary schools in eastern Australia. The three students were introduced to VRMath through 6 hours of instruction which covered the six rotational or turning commands and 3D navigation within the VR space. The question posed to them was: "Will you face the same direction when you turn right 45 degrees first then roll up 45 degrees, or when you roll up 45 degrees first then turn right 45 degrees?"

The students were videotaped as they experimented with the VRMath environment as they attempted to solve the problem. They spent about one hour each on the problem. The author, the researcher, sat with the students during this time, asking questions to draw out the reasons for any interesting activity. Field notes also were made by the researcher.

The videotapes were transcribed and the students' posts on the VRMath forum were also collected. The transcriptions and the posts were analysed to provide rich descriptions of the thinking of each student, which in turn was analysed for evidence that the students' experiences on the VRMath environment were assisting them to understand about 3D rotation.

Results

The initial thinking of all participants was that the two 3D rotations (RU 45 RT 45 and RT 45 RU 45) would end up in same direction regardless of the performance sequence. This thinking was challenged when the students interacted with VRMath. The processes by which students changed their conceptual understanding of 3D rotation will be presented in turn.

Rosco's experiment: Avatar View

When Rosco was asked to justify his thoughts about the 3D rotation problem, he immediately came up with the idea of using the "Avatar View" in VRMath. Avatar View is a function by which the user temporarily becomes the turtle and views actions within the 3D virtual space from the turtle's perspective. In this mode, the 3D navigation by mouse and keyboard in VR space are disabled to prevent changing the viewpoint by mouse dragging. The programming commands become the only way to manipulate the turtle's position and orientation as well as to change the viewpoint. Bonbon suggested that Rosco switched on the Compass in VR space in order to see the degrees. Rosco thus began his experiment as illustrated in Figure 3.

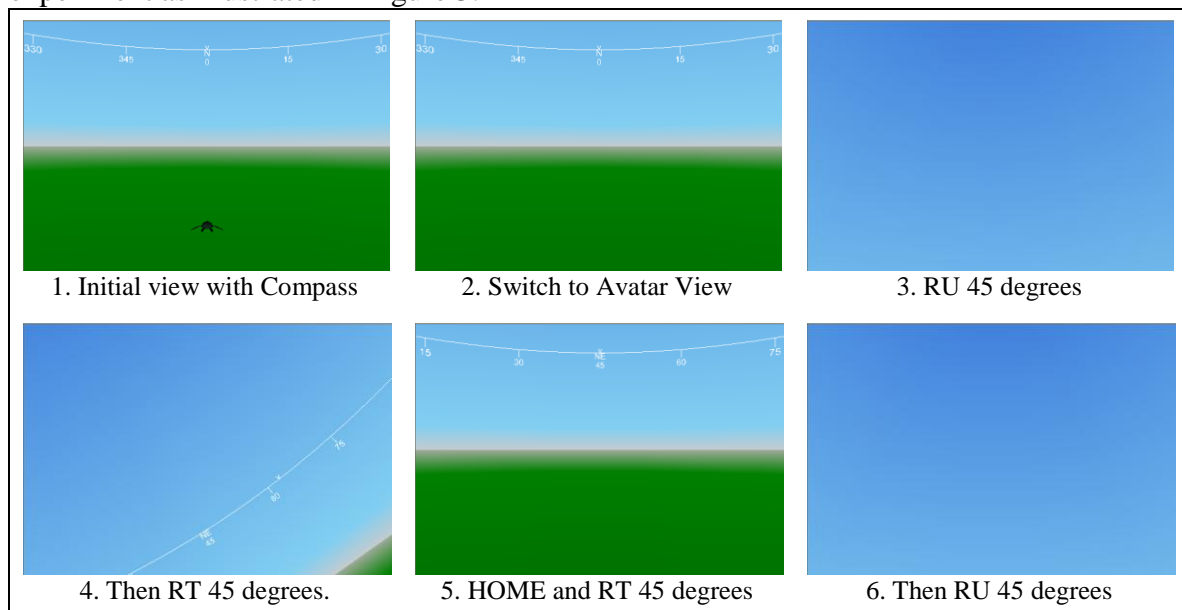

Figure 3. Avatar View experiment about 3D rotation

To his surprise, Rosco found that the views of Picture 4 (RU 45 RT 45) and Picture 6 (RT 45 RU 45) in Figure 3, which he originally thought to be the same, looked different. Because of the different part of the sky he (or the turtle) saw, he then started to think that different order of two 3D rotations may end up with different directions. He also contributed his idea of using Avatar View in the forum in the following posting titled "How to determine if":

*How to determine if ru 45 lt 45
and lt 45 ru 45*

have da same veiwpoint

1. go to avatar view
2. copy this text ru 45 lt 45
3. copy this text lt 45 ru 45
4. SEE FOR YOURSELF



Hi peoples im rosco!!! 😊👋 hello

Bonbon's exploration: Look at the turtle

Bonbon used her hands to simulate the two 3D rotations, and was pretty sure that the two 3D rotations were the same. She did a straight forward experiment by watching the turtle turns, but she decided to try on RU and LT (left) instead of RU and RT (right). The processes of her experiment are illustrated in Figure 4.

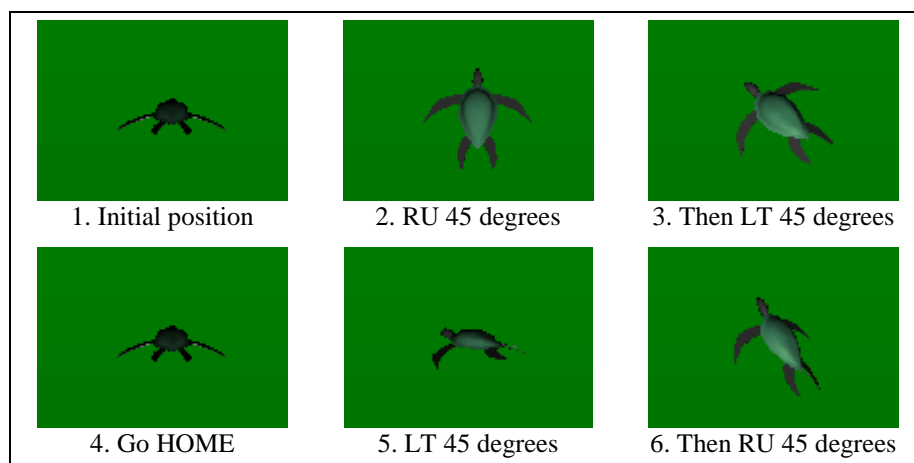

Figure 4. Turtle experiment about 3D rotation

Bonbon carefully compared the two views of Picture 3 (RU 45 LT 45) and 6 (LT 45 RU 45) in Figure 4 and noticed that they were different. However, before she made a conclusion, she also tried tilting rotations (TL and TR) with RU and smaller degrees, and together with Rosco's Avatar View experiment, she convinced herself that the two 3D rotations ended up with different results.

Grae's experiment: Create 3D objects

After seeing Rosco's and Bonbon's experiment, Grae could not think of any idea to show the difference between the two 3D rotations. The researcher encouraged him to try to create a 3D object after each 3D rotation. Grae then decided to create a sphere after each 3D rotation. He used commands "RU 45 RT 45 BALL" to create the first sphere, and then "HOME RT 45 RU 45 BALL" for the second sphere. The processes are illustrated as in Figure 5.

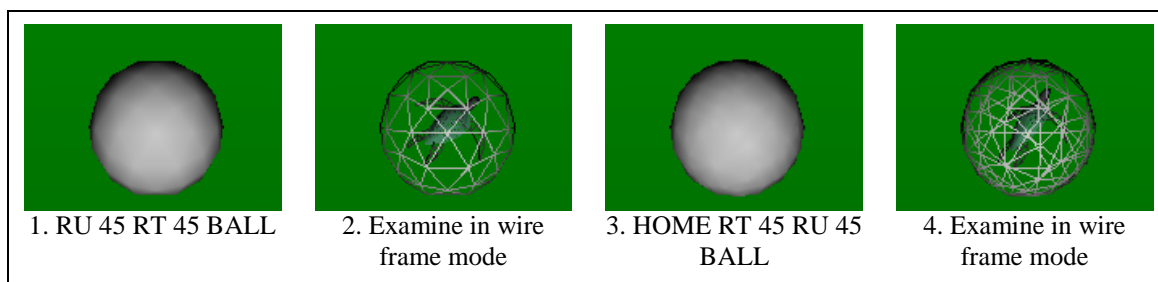

Figure 5. Create 3D Objects experiment about 3D rotation (1)

Grae originally thought that the two spheres should be somewhat overlapped but located at different place. However, he was confused when he navigated to see the two balls from different viewpoints; they seemed to be one ball. The researcher then suggested him to try on CUBE instead of BALL and with different colours. Figure 6 shows the processes of creating cubes after each rotation.

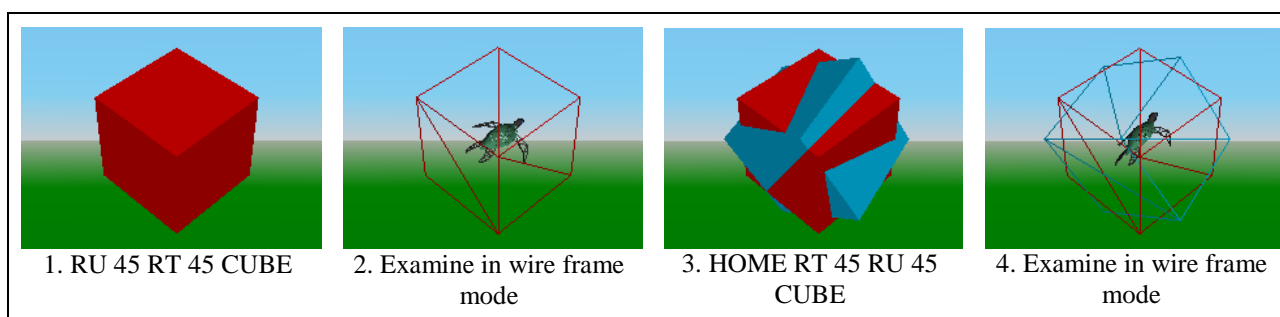

Figure 6. Create 3D Objects experiment about 3D rotation (2)

Grae was then satisfied with this result, and with the help of this researcher, Grae posted a message titled “two turns must take turns” in the forum:

Hi,
 if you lt 45 ru 45, or if you ru 45 lt 45 Will these be the same?
 you can check the answer by doing:
 1. home ru 45 lt 45 cube so you have a cube...
 2. you pick another color from the material editor.
 3. home lt 45 ru 45 cube
 so you have another cube but this time the turtle go lt 45 first then ru 45
 do you think that the two cubes are in the same place???

--
 grae 🤔🤔🤔🤔🤔🤔

Discussion and Conclusion

From “the two 3D rotations are the same” at the beginning to “the sequence of performing 3D rotations does matter” at the end, the three young participants experienced a conceptual shift after their interactions with VRMath.

The non-commutative nature of 3D rotation may be easily understood by one who can perform trigonometry in 3D coordinate system, but it would be very difficult for most people if they can only use their body movements, senses or feelings, mental reasoning, and other concrete objects. It is evident that although students live in a 3D space, they have limitations on manipulating or thinking three dimensionally.

The VR interface of VRMath which enabled the students to switch between first- and third-person experiences facilitated dynamic visualisations of the 3D rotations. Rosco, for example, utilised the Avatar View to simulate the body movement, which was a typical example of using a computer to address a limitation with real world experiences within 3D space. In the Avatar View, Rosco temporarily became the turtle and viewed the rotations from the turtle's perspective. At the same time, he also manipulated the turtle's orientation by using 3D rotation commands. This operation of switching from third-person experience (watching the turtle turning) to first-person experience (turning himself) allowed Rosco to see different portion of the sky, and as a result, to realise the non-commutative nature of 3D rotations and thus correctly solve the 3D rotation problem posed by the researcher. Rosco's experiences confirmed the benefit of switching between first- and third- person imagery (Amorim et al., 2000).

Bonbon and Grae used the Logo-like programming language to manipulate the turtle and build 3D objects in VR space to solve this 3D rotation problem. Bonbon's experiment demonstrated again that the computational environment VRMath easily and accurately showed the two 3D rotations were different, which was in contrast to the use of her hands to simulate the 3D rotation. Grae's experiment of creating objects was another approach to successfully solve this 3D rotation problem. Nevertheless, he also found that creating a sphere after each set of 3D rotation would not show any difference of the two 3D rotations because as long as the turtle doesn't move, the centre for spheres remains the same.

One important misconception about 3D rotation found in this study was thinking that a turning could be eliminated by its opposite turning performed later in a series of 3D rotations. For example, in the four rotations RU 45 RT 45 RD 45 LT 45, students with this misconception believe that RU can be eliminated by RD and RT by LT. However, as VRMath showed, a rotation of another dimension in between the two opposite turns means that the two rotations of the same dimension still cannot eliminate each other.

To conclude, VRMath with its computational power provided the young children with new ways of thinking about and doing 3D geometry. The small number of cases reported in this study makes conclusions from this study tentative. Further studies, which are currently in progress, will provide further support for the educational efficacy of VRMath. However, this study does provide initial indications that VRMath, with its VR visualisation interface, fully implemented and extended Logo-like 3D programming language (e.g., mathematical functions and recursive procedures), and online forum for collaborative learning, could be a most powerful environment for young children to experience 3D mathematical modelling, simulation and problem solving.

Acknowledgements: The author would like to thank Professor Tom Cooper and Adjunct Professor Rod Nason for their valuable comments and input to this paper.

References

- Amorim, M.-A., Trumbore, B., & Chogyen, P. L. (2000). Cognitive repositioning inside a desktop VE: The constraints introduced by first- versus third-person imagery and mental representation richness. *Presence: Teleoperators and Virtual Environments*, 9(2), 165-186.
- Baturo, A. R., & Cooper, T. J. (1993). Four perspectives for teaching spatial concepts and processes in the primary school. In A. R. Baturo & L. Harris (Eds.), *New directions in geometry education -- Conference Proceedings of The Third Annual Conference on Mathematics Teaching and Learning* (pp. 1-6). Brisbane, Australia: Queensland University of Technology.
- Cunningham, D. J. (1992). Beyond educational psychology: Steps toward an educational semiotic. *Educational Psychology Review*, 4(2), 165-194.

- Elliott, J., & Bruckman, A. (2002, June). *Design of a 3D interactive math learning environment*. Paper presented at the DIS 2002 (ACM conference on Designing Interactive Systems), London, UK.
- Ernest, P. (1994). *Constructing mathematical knowledge: Epistemology and mathematical education*. London Washington, D.C: Falmer Press.
- Harel, I., Papert, S., & Massachusetts Institute of Technology. Epistemology & Learning Research Group. (Eds.). (1991). *Constructionism: Research reports and essays, 1985-1990*. Norwood, N.J.: Ablex Pub. Corp.
- Kafai, Y. B. (2006). Constructionism. In R. K. Sawyer (Ed.), *The Cambridge handbook of the learning sciences* (pp. 35-46). Cambridge New York: Cambridge University Press.
- Kafai, Y. B., & Resnick, M. (Eds.). (1996). *Constructionism in practice: Designing, thinking, and learning in a digital world*. Mahwah, NJ: Lawrence Erlbaum Associates.
- Lemke, J. L. (2001). *Mathematics in the middle: Measure, picture, gesture, sign, and word*. Retrieved June 20, 2001, from <http://academic.brooklyn.cuny.edu/education/jlemke/papers/myrdene.htm>
- McGee, M. G. (1979). Human spatial abilities: Psychometric studies and environmental, genetic, hormonal, and neurological influences. *Psychological Bulletin*, 86(5), 889-918.
- Pasqualotti, A., & Freitas, C. M. D. S. (2002). MAT3D: A virtual reality modeling language environment for the teaching and learning of mathematics. *CyberPsychology & Behavior*, 5(5), 409-422.
- Queensland Studies Authority. (2004). *Years 1 to 10 mathematics syllabus*. Retrieved July 30, 2004, from <http://www.qsa.qld.edu.au/yrs1to10/kla/mathematics/docs/syllabus/preprint.pdf>
- Yeh, A. (2004, April). *VRMath: Knowledge construction of 3D geometry in virtual reality microworlds*. Paper presented at the Doctoral Consortium, CHI2004, Vienna, Austria.
- Yeh, A., & Nason, R. (2004a, June). *Knowledge building of 3D geometry concepts and processes within a virtual reality learning environment*. Paper presented at the World Conference on Educational Multimedia, Hypermedia & Telecommunications, Lugano, Switzerland.
- Yeh, A., & Nason, R. (2004b, June). *VRMath: A 3D microworld for learning 3D geometry*. Paper presented at the World Conference on Educational Multimedia, Hypermedia & Telecommunications, Lugano, Switzerland.

Socio-economic Background, Senior Secondary Mathematics, and Post-secondary Pathways.

Eng Yeoh

Victorian Curriculum and Assessment Authority
<yeoh.eng.t@edumail.vic.gov.au>

David Leigh-Lancaster

Victorian Curriculum and Assessment Authority
<leigh-lancaster.david.d@edumail.vic.gov.au>

The relationship between socio-economic background and completion of senior secondary mathematics study leading to various post-schooling pathways has been an area of keen interest to researchers, school systems and policy makers for some time. This paper briefly considers some aspects of this relationship using recent Victorian data relating to the index of relative socio-economic disadvantage (IRSD), enrolments and study scores for Victorian senior secondary mathematics students and *On Track* destination data.

Background

A distinctive feature of senior secondary mathematics curricula in countries around the world and also in Australia is the common use of a hierarchy of three to four distinctive mathematics subjects typically characterised in terms of a combination of: depth, breadth and directness of application to practical problem solving in real life; the level and scope of complexity and demand in ‘pure’ and ‘applied’ mathematical concepts, skills and processes; expectations for mental, by hand and technology assisted approaches to working mathematically and pathways to post-secondary study, training or work (see, for example, Tout & Motteram, 2006). The development of a ‘national’ or Australian curriculum from school entrance to the end of secondary school is now well underway in the first four subjects of English, Mathematics, Science and History, with drafts scheduled to be available for consultation throughout 2010.

The Australian Curriculum and Assessment Authority (ACARA) mathematics framing paper *The Shape of the Australian Curriculum: Mathematics* (National Curriculum Board, 2009) referred to four types of senior secondary mathematics courses that can be characterised as everyday mathematics vocational (Course A), general mathematics including data analysis, business and discrete mathematics leading to further training, employment or tertiary study that does not require a calculus background (Course B), a mainstream calculus based mathematics leading to tertiary study in sciences, economics, medicine and the like (Course C) and an advanced pure and applied calculus based mathematics leading to study that requires a substantial mathematical background such as engineering and actuarial work (Course D). It also noted the current imbalance in access to these types of courses with respect to socio-economic background. Curriculum benchmarking research typically carried out by state and territory curriculum and assessment authorities, board and councils as part of normal review processes (see also, for example, Masters & Matters, 2007) indicated a high level of commonality in the nature and purpose of different versions of such courses around the Australian states and territories.

In Victoria the corresponding courses are the Victorian Certificate of Applied Learning (VCAL) Senior Numeracy and the Victorian Certificate of Education (VCE) Unit 3 and 4 studies Further Mathematics, Mathematical Methods/Mathematical/Methods (CAS) and Specialist Mathematics. For 2006–2009 Mathematical Methods/Mathematical and Methods (CAS) were alternative and equivalent parallel implementations of the same type of course with different assumed enabling technology – an approved graphics calculator or



CAS. Mathematical and Methods (CAS) replaced Mathematical Methods from 2010 (inclusive). In the rest of this paper only these three VCE studies are considered and are referred to as 'Further', 'Methods' and 'Specialist' mathematics subjects respectively. At the Unit 3 and 4 level in 2009 around 48 000 students were enrolled in one of the VCE English group of studies (English, English as a Second Language, English language or Literature), hereafter similarly referred to as just 'English' (study of English is a compulsory requirement of the VCE).

In 2009, around 28 000 students were enrolled in Further; around 16 - 17 000 students were enrolled in Methods, and just under 5 000 students were enrolled in Specialist. Almost all of the Specialist students were concurrently enrolled in Methods (Specialist assumes previous completion of, or concurrent enrolment in, Methods), while around 3 500 students were concurrently enrolled in Further and Methods and around 300 students were concurrently enrolled in all three subjects. Over the last decade or so there has been a definite trend of increasing overall enrolments in Unit 3 and 4 level mathematics subjects - this has been through a significant increase in Further enrolments, with steady Methods enrolments and a decrease in Specialist enrolments. The number of students enrolling in two mathematics, Further and Methods or Methods and Specialist has also increased over this period.

This paper looks briefly at the socio-economic backgrounds of students undertaking Further Maths, Methods and/or Specialist subjects and links these to study scores and destinations of students who satisfactorily completed units 3 and 4 of these subjects six months after completing their senior secondary programs, and makes some preliminary observations and comments. Socio-economic background of students in this paper is used to examine how aspects of the profile of students undertaking mathematics subjects compare with those of VCE student population in general. It is not the intention to use this data to explore explanatory factors for student performance or likely destinations.

Key research has been done in the area in Australia, in particular with respect to Victorian and Queensland contexts, but also international contexts by Teese and colleagues (see, for example, Teese & Polesel, 2003; Teese, Lamb & Duru-Bellat, 2007). It has also been a key consideration of recent government inquiries such as the *National Numeracy Review Report* for the Human capital working group of the Council of Australian Governments (Council of Australian Governments, 2008). Some of the data presented here have only become recently available, and consideration of related matters could be enhanced by inclusion of NAPLAN data (the first available would be Year 9 data from 2008) along with VCE enrolment, study score and *On Track* destination data.

Data: Indices, Study Scores and Destinations

Data used in the first part of the study include student enrolments in Units 3 and 4 English, Further, Methods and Specialist in a given year between 2006 and 2009. Students enrolled in English are used as a proxy for the VCE population base and the socio-economic backgrounds of English students are used as a benchmark for VCE students. This is because English is a requirement both for award of the VCE and for an ATAR (formerly ENTER) score to be compiled. Thus, in Figure 1 the distribution for English would be a constant 10%. The Index of Relative Socio-Economic Disadvantage (IRSD) for areas published by the Australian Bureau of Statistics (ABS) is used as a proxy measure of student socio-economic status (SES). This index is derived from a wide range of population census data relating to measures of relative disadvantage in economic and social resources of people and households within the area, such as low income, low education, high unemployment and unskilled occupations.

Student residential postcodes are matched to the IRSD postal area codes. An ABS Postal Areas is an approximation of the Australia Post Postcode with the same four digit code. For a given year, about one per cent of student postcodes cannot be matched to the ABS postal area codes, mainly due to use of post office box postcodes by students.

The *On Track* results are used to look at the destinations and pathways of respondents who satisfactorily completed their Maths subject(s) in their final year of senior secondary programs. *On Track* is an annual survey conducted by the Victorian Department of Education and Early Childhood Development (DEECD) to gather information on the destinations of students six months after they completed senior secondary school. The survey is conducted in May each year. The *On Track* data included in this analysis are for those respondents who satisfactorily completed maths subject(s) in their final year of schooling and attained Year 12 or equivalent certificate in 2006, 2007 and 2008. For students who completed Year 12 or equivalent in 2009 and gave consent to participate in the *On Track*, destination data will not be available until mid 2010. This paper will only consider data for the 2008 VCE Unit 3 and 4 student cohort, that is, those students who undertook mathematics subject(s) in 2008 and had their pathways/destinations surveyed mid 2009.

The Further Cohort

Further is undertaken by students from a wide range of socio-economic backgrounds. In a given year, about 12% of students enrolled in Further are also enrolled in Methods. The proportion of students from each SES group (in deciles) is fairly evenly distributed from the *most* disadvantaged (lowest = 1st decile) to the *least* disadvantaged (highest = 10th decile) backgrounds as shown in Figure 1. Relative to English, there are slightly more students from the most disadvantaged backgrounds and moderately disadvantaged backgrounds, and fewer students from the least disadvantaged backgrounds enrolled in Further. This pattern has been consistently observed 2006 to 2009. The overall profile of socio-economic backgrounds of students studying Further is very similar to that of English students, and thus all VCE students.

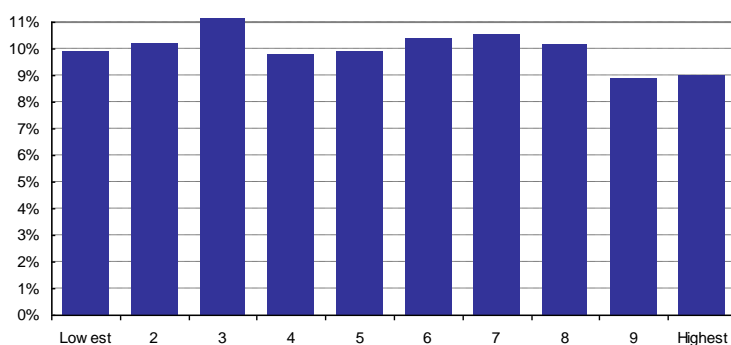

Figure 1: Students enrolled in Further in 2008 by SES

The overall distribution of study scores (which combines examination and school-based assessment components) for a VCE subject is modelled by a truncated normal distribution on a scale of 0 – 50 with a mean of 30 and a standard deviation of 7. When the corresponding distributions of study scores for Further students are considered by quartile as shown in Figure 2 the lowest and lower-mid socio-economic SES quartiles are fairly

similar, and students from the highest SES quartile (least disadvantaged) seem to achieve slightly higher results than students from the lowest SES quartile (most disadvantaged).

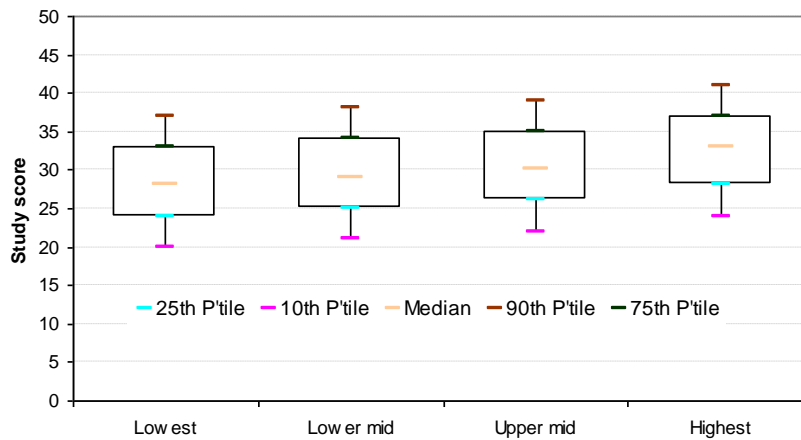

Figure 2: Further Maths, Distribution of study scores by SES quartile, 2008

Figure 3 shows the corresponding cumulative distribution of study scores for the lowest and highest SES quartiles.

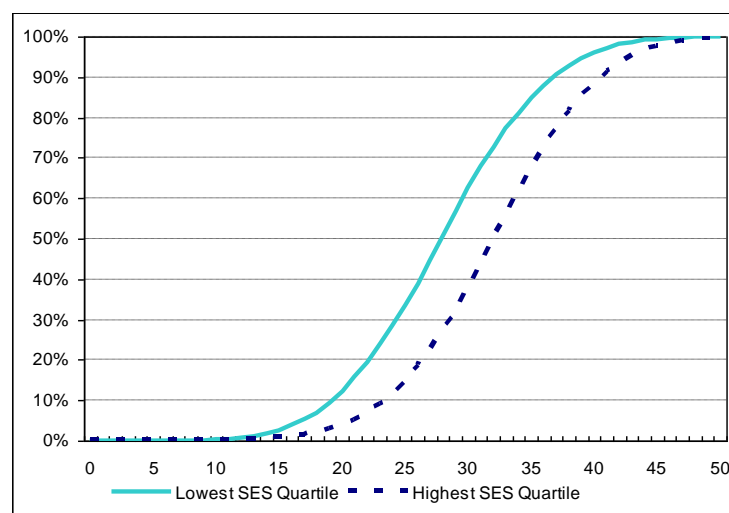

Figure 3: Cumulative distribution of 2008 study scores for lowest and highest SES quartiles

The Methods cohort

The Methods cohort of around 17 000 students effectively subsumes the Specialist cohort, where a bit less than one in three Methods students is also a Specialist student. These two studies also attract students from a wide range of socio-economic backgrounds; however, it is evident that there are a higher proportion of students from less disadvantaged backgrounds (= 8, 9 or 10th deciles) doing these studies compared to students from more disadvantaged backgrounds as shown in Figure 4. Thus, there are fewer students from low and low to mid SES backgrounds (although less pronounced for the lowest SES background) and more students from mid-high and high SES backgrounds in this cohort.

This profile, which may be likened to a flat ‘J curve’ has also been consistently observed from 2006 to 2009, and is distinctive to those for English and Further.

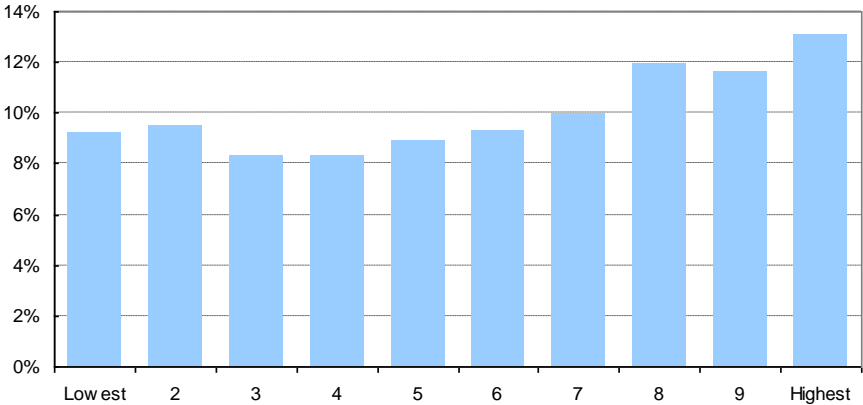

Figure 4: Students enrolled in Methods and possibly Specialist but not Further in 2008 by SES

When the corresponding distributions of study scores for Methods students are considered by quartile as shown in Figure 5 the lowest and lower-mid socio-economic SES quartiles are again fairly similar to those for Further, and again students from the highest SES quartile (least disadvantaged) seem to achieve higher results than students from the lowest SES quartile (most disadvantaged).

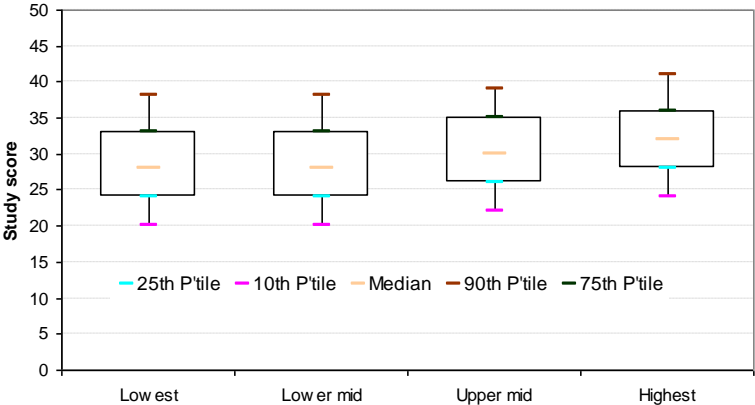

Figure 5: Students doing Methods (no Further): distribution of study scores in 2008 by SES quartiles

Figure 6 shows the corresponding cumulative distribution of study scores for the lowest and highest SES quartiles.

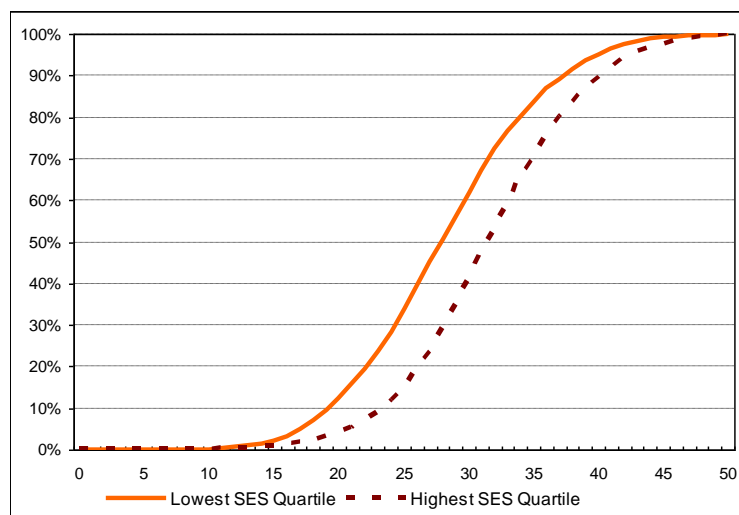

Figure 6: Cumulative distribution of 2008 study scores for lowest and highest SES quartiles

Pathways and Destinations

Table 1 shown pathways of young people who satisfactorily completed VCE Mathematics subject(s) in their final year of schooling, and were surveyed in 2009 in terms of various ‘destinations’ such as university, TAFE and so on. *On Track* 2009 surveyed the students who completed Year 12 or equivalent in 2008.

Table 1: *Post-school destinations for students completing various combinations of Unit 3 and 4 mathematics studies in 2008*

	Further only	Further and Methods	Methods and Specialist	All <i>On Track</i> respondents
University	38.7%	72.9%	72.7%	45.6%
VET Certificate IV and above	17.4%	9.0%	6.5%	14.3%
VET entry-level (Certificates I–III)	4.2%	2.7%	1.2%	3.8%
Apprentice/Trainee	8.7%	2.2%	2.7%	8.0%
Employed	13.9%	2.7%	2.9%	21.4%
Looking for work	3.5%	1.1%	0.7%	3.8%
Deferred	13.4%	9.4%	12.2%	12.1%
Total	100%	100%	100%	100%

The data show that respondents who satisfactorily completed only Further were much less likely to continue with education and training at University than respondents who successfully completed two mathematics studies, and slightly less likely to do so than all respondents. However, they were also much more likely to continue their further education and training in VET Certificate IV and above studies, via apprentice/trainee arrangements or is in employment than those respondents who successfully completed two mathematics studies. While a similar proportion of respondents who successfully completed Further and Methods and Methods and Specialist continued to university, a higher proportion of Further and Methods respondents undertook VET Certificate IV and above studies than Methods and Specialist respondents. Similar observations can be made with respect to *On Track* data from earlier years.

Concluding Remarks

The question as to whether a credentialing end of schooling certificate and/or various studies within that certificate are sufficiently robust with respect to ensuring broadly accessible and equitable opportunities for learning; suitably recognising demonstration of achievement of learning; and providing genuine opportunity for construction of meaningful and flexible pathways from entry to the senior secondary years and subsequent post-schooling destinations; is a perennial one. Recent discourse on this matter, in particular from national perspectives on the education agenda has brought such matters into increasingly sharp focus through the notion of educational entitlement for all, as expressed most recently in the Melbourne Declaration which is being used as the basis for the development of an Australian Curriculum. Various views on these matters have been argued over the years and systems have moved to progressively develop more detailed data collection to inform related debates. This paper briefly draws together some of the data aspects that are relevant to informing these debates in Victoria, and notes the opportunities for further refinement and development when data from the compulsory years of schooling can also be brought into consideration, and the possibility of an emerging national perspective.

References

- Council of Australian Governments. (2008). *National numeracy review report*. ACT: Commonwealth of Australia.
- Matters, G. & Masters, G. N. (2007). *Year 12 curriculum content and achievement standards*. Melbourne: ACER.
- National Curriculum Board. (2009). *The Shape of the Australian curriculum: Mathematics*. Melbourne: Commonwealth of Australia.
- Teese, R. (2007). *Quality and equity of schooling in Scotland*. Paris: OECD.
- Teese, R., Lamb, S., & Duru-Bellat, M. (Eds.). (2007). *International studies in educational inequality, theory and policy: Inequality: Educational theory and public policy* (Vol. 3). Netherlands: Springer.
- Teese, R. V., & Polesel, J. (2003). *Undemocratic schooling: Equity and quality in mass secondary education in Australia*. Carlton, Vic: Melbourne University Publishing.
- Tout, D. & Motteram, G. (2006). *Foundation numeracy in context*. Melbourne: ACER.

Two Decades of Mathematics Education Reform in New Zealand: What Impact on the Attitudes of Teacher Education Students?

Jenny Young-Loveridge
The University of Waikato
<jenny.yl@waikato.ac.nz>

This paper explores the impact of almost two decades of mathematics education reform in New Zealand on the attitudes of pre-service teacher education students training to be primary teachers. More students were positive towards mathematics and fewer were negative compared to Biddulph (1999). In the present study, more students were positive about the prospect about teaching mathematics than about mathematics. Only 47% of the students were positive about both mathematics and the teaching of mathematics. However, students' reasons for their ratings revealed that a negative attitude towards mathematics sometimes resulted in enthusiasm about helping children to have better experiences than they themselves had had at school. Some students with positive attitudes towards mathematics worried about the responsibility of providing high quality teaching experiences in mathematics for children. The study showed that this issue is complex and attitudes towards teaching mathematics may be different from attitudes towards mathematics.

Mathematics education reform in New Zealand began with the introduction of a new mathematics curriculum document in the early nineties (Ministry of Education, 1992; Young-Loveridge & Peters, 2005). Continuity and progression in mathematics learning were emphasised and learning goals specified via stated achievement objectives. There was a strong focus on diagnostic and formative assessment as part of the teaching and learning process. Also stressed was “the need for mathematics to be taught and learned within the context of problems which are meaningful to students and which lead to understanding of the way mathematics is applied in the world beyond school” (Ministry of Education, 1992, p. 5). To support the emphasis on problem solving, a *mathematical processes* strand was included alongside those of number, measurement, geometry, algebra, and statistics. Mathematical processes skills included problem solving, reasoning, and communicating mathematical ideas. Mathematics education was seen as contributing to the development of a broad range of skills, including numeracy skills, problem-solving and decision-making skills, communication skills, social and co-operative skills, and information skills.

The new millennium saw the introduction of the government's Literacy and Numeracy Strategy (Ministry of Education, 2001), aimed at raising expectations for progress and achievement, building the professional capability of teachers, and strengthening links with families and communities. A definition of what it means to be numerate was “to have the ability and inclination to use mathematics effectively in our lives - at home, at work and in the community” – reflecting a strong link between mathematics and numeracy (Ministry of Education, 2001). The Numeracy Development Projects (NDP), has been a major initiative in mathematics education, beginning in 2001 and involving professional development with teachers at the primary (Years 1-6), intermediate (Years 7-8), and early secondary (Years 9-10) levels teaching in the medium of English, as well as those providing instruction in te reo Maori (Bobis, Clarke, Clarke, Thomas, Wright, Young-Loveridge et al., 2005; Christensen, 2003; Trinick, 2009; Young-Loveridge, 2008).

Just over two years ago, a revised curriculum was published (Ministry of Education, 2007). It took as its starting point, a vision of students as “lifelong learners who are



confident and creative, connected, and actively involved” (p. 4). Included are statements about the principles on which curriculum decision-making is to be based, values to be encouraged, modelled and explored, and key competencies considered to be critical in sustaining learning and effective participation in society. Recently the *Mathematics Standards for Years 1-8* were published for implementation in schools this year (Ministry of Education, 2009). There are likely to be far-reaching effects from these most recent developments, but it is too soon to tell.

Researchers have had a longstanding interest in the affective domain in mathematics, including beliefs, values, attitudes, and emotions (Leder & Grootenboer, 2005; Grootenboer, Lomas, & Ingram, 2008). According to Burns (1998), negative attitudes towards mathematics in the US have limited the numbers of people who can “think, reason, and solve problems” and this so-called “phobia” can have adverse consequences on people’s life choices and career options. A decade later, Boaler (2008) picked up a similar theme in her recent book, arguing that the future of the American economy rests on the quality of the mathematics teaching students receive in schools.

In 1999, Biddulph reported that a significant proportion (more than half) of primary teacher education students in New Zealand had deeply negative feelings and attitudes towards mathematics and lacked understanding of relatively simple mathematics. The relationship between mathematics anxiety and mathematics understanding in pre-service teachers was investigated more recently by Canadian researchers Rayner, Pitsolantis, and Osana (2009), who found a negative correlation between mathematics anxiety scores and measures of conceptual ($r = -0.49$) and procedural (-0.48) knowledge of fractions.

With so much effort put into reforming mathematics education over the past couple of decades, an obvious question arises about the impact of this effort on students’ attitudes and feelings about mathematics. With at least a generation of children having gone through the compulsory school system and entered tertiary education, the fruits of mathematics education reform should by now be evident in both mathematics achievement and attitudes towards mathematics. This study set out to investigate the extent to which this is the case.

Method

Participants

The participants in this study were 125 students nearing the end of their three-year Bachelor of Teaching degree for primary teaching. Only students who had consented to data on their attitudes and solution strategies for mathematics tasks were included in this study. The participants constituted 73 percent of the potential sample of 170 students who were invited to participate (Note: 27 students did not hand in a consent form, 15 consented only to their attitude responses being included, and 3 consented only to the inclusion of their responses on mathematics tasks). Only students who gave consent for both parts have been included in the analysis presented here.

Procedure

As part of a course on assessment, students were given a written mathematics test consisting of a range of question types, including written explanations about solution strategies, drawing diagrams to show solution processes, and multiple-choice items. The test was accompanied by three attitude questions using a five-point Likert scale. These included: attitude towards mathematics/numeracy, attitude towards teaching

mathematics/numeracy, and preparedness to teach mathematics/numeracy (see Appendix). After marking their response on the Likert scale, students were asked to give reasons for each rating. Responses at either end of the scale were aggregated to create a cluster of positive and negative responses for each of the questions, with the neutral category used for those who chose the mid-point on the scale. Students were also given a consent form to sign, if they were happy for their responses being used as part of a research project. Students were assured that the test did not count towards their grades.

Results

Attitude Ratings

Table 1 presents the numbers and percentages of students whose responses fell in each of the categories on the three attitude questions. It is interesting to note in Table 1 that more students were positive about teaching mathematics than were positive about mathematics themselves. Analysis was done of students' responses as a function of both attitude towards mathematics and attitude towards teaching mathematics (see Table 2). While the largest category of students (56 out of 120) were positive towards their own mathematics as well as teaching mathematics, a number of students gave responses which differed on these questions. Of the students who were neutral (n=20) or negative (n=20) about the prospect of teaching mathematics, they were relatively equally distributed across the three categories of liking mathematics personally. Of the students who were positive about the prospect of teaching mathematics (n=80), more than two thirds (70%) were positive about their own personal mathematics. However, one quarter of them were neutral about their own mathematics, and 5 percent claimed to dislike mathematics themselves.

Table 1: Numbers and percentages of students whose responses fell in each of the categories on the three attitude questions. (Note: Percentages are rounded to whole numbers)

Question	N	%
Attitude towards Maths		
Positive	69	57
Neutral	33	27
Negative	20	16
<i>Total students</i>	<i>122</i>	<i>100</i>
Attitude towards Teaching Maths		
Positive	80	67
Neutral	20	17
Negative	20	17
<i>Total students</i>	<i>120</i>	<i>100</i>
Preparedness to Teach Maths		
Positive	58	48
Neutral	48	40
Negative	14	12
<i>Total students</i>	<i>120</i>	<i>100</i>

Not all of the students who liked mathematics felt positive about the prospect of teaching mathematics. Approximately 18 percent of students who were positive about their

own mathematics were either neutral or negative about teaching mathematics. Of the 32 students who were neutral towards mathematics themselves (n=32), 63 percent were positive about teaching mathematics. Twenty students were negative towards mathematics themselves, but 20 percent of these were positive about teaching mathematics, with the remainder equally divided between neutral and negative responses about the prospect of teaching mathematics.

Table 2: Numbers and percentages of students' responses as a function of attitude towards mathematics and attitude towards teaching mathematics

Attitude towards Maths	Attitude towards Teaching Maths						Total	
	Positive		Neutral		Negative			
Positive	56	70%	5	25%	7	35%	68	57%
Neutral	20	25%	7	35%	5	25%	32	27%
Negative	4	5%	8	40%	8	40%	20	17%
<i>Total students</i>	<i>80</i>	<i>100%</i>	<i>20</i>	<i>100%</i>	<i>20</i>	<i>100%</i>	<i>120</i>	<i>100%</i>

Reasons for Attitude Ratings

The responses of students who showed a mixed pattern of ratings and those who were not positive towards either mathematics or teaching mathematics were subjected to a content analysis to identify common themes.

Positive towards mathematics but not positive towards teaching mathematics

Students in this category tended to have been reasonably successful at mathematics when they were at school, but felt overwhelmed by the responsibility of teaching mathematics to children. For example:

[I like maths] because I was quite good at it at school. I'm just nervous that I'm worried about not moving the kids along far enough. Additionally I am worried about how to extend the lower end (S80).

[I like maths because] I enjoy being challenged. [I'm apprehensive about teaching maths because I] feel I need more knowledge about maths (S152).

[I love maths], however [I] feel completely unprepared to teach numeracy with any great confidence. [I'm apprehensive about teaching maths because] very little covered in [the program] so far. A new concept which is tricky to grasp all strategies and concepts without instruction (S27).

[I love maths.] I can't explain it. I love thinking, working through problems. [I'm apprehensive about teaching maths because] I feel I have not had enough training in this area (S50).

Not positive towards mathematics but positive towards teaching mathematics

Students in this category tended to identify with the needs of their students and wanted to prevent the negative attitude towards mathematics that they had developed. For example:

[I hate maths because] I hate being put on the spot and expected to perform well without any kind of warning. [I'm positive about teaching maths because] I want to help my future class enjoy maths and not be scared of it like I have been. Maths can be enjoyable and should not be about scary test situations. Children should not have that pressure (S55).

[I dislike maths because of] bad high school experiences and all around not a mathematically sound person. Know I can do [teaching maths] because have done. If I can learn the maths I can teach it (S102).

[Dislike maths] because it is hard. [I'm positive about teaching maths] because students need to learn it (S168).

[Dislike maths because of] experiences at school. [I'm positive about teaching maths because] I want to make maths a more enjoyable experience for students today compared to what I had (S89).

I was not good at maths at school, but as I am learning how to teach maths I am beginning to understand it and enjoy it. I feel I will learn to "love" it as I continue. The way maths are taught in schools today compared to when I did it at school is far better – more enjoyable. [I feel very positive about teaching maths because] I can see how this way is setting the students up for success in maths (S15).

Some strategies are confusing and I find numbers daunting [but I feel very positive about teaching maths because] I love seeing the way the children learn and use their own understandings and learning (S143)

Not positive towards mathematics or teaching mathematics

Students in this category gave a range of reasons for their negative ratings. Some students commented that their apprehensiveness was limited to teaching the upper primary years only. Others appeared to empathise with their students in not wanting to be taught by a teacher without a strong understanding of mathematics.

[I don't maths. It] was always my weakest subject at school, and [I] was punished for it. [I am apprehensive about teaching maths because I] don't want students to feel how I felt about maths (S149).

[I don't like maths] On the whole I feel I could cope with basic maths but feel completely confused with terminology regarding where children are re stages and how to assess that. [I am very apprehensive about teaching maths because] I do not understand what Part/whole, Advanced Proportional Part-whole etc means and do not feel the maths taught in [program] covered this for me (S33).

[I hate maths because I have] no confidence. Didn't like maths at school. Teacher was very strict and mean. [I'm apprehensive about teaching maths] because I haven't got enough experience yet to teach it confidently (S12).

[I dislike maths because] I have always found maths difficult as I have begun to gain strategies that I wished I had been taught years ago. I still however need to draw most things and can not do it in my head. [I'm very apprehensive about teaching maths] This is due to my own understandings more for the older aged students. I am happy to teach years up to 5 confidently (S20).

[I dislike maths because I'm] extremely confused surrounding mathematics. [I] lack understanding in strategies and numbers themselves. [I'm] keen to learn more but must always do mathematics lessons myself first in order to explain more clearly to others. [I'm apprehensive about teaching maths and] wary of how my understanding may affect others; ie, basic knowledge. [I'm] unclear of various wording in different strategy types (S169).

Performance on Selected Tasks

Because the time to complete the mathematics tasks and attitude ratings was limited, not all students had time to finish all parts. Hence, only students who attempted a particular task are included in the analysis for each task. It is difficult to know whether missing data was the result of insufficient time or inability to complete the task, and it is possible that the results may be distorted in the positive direction as a consequence. A summary of responses to selected fractional number tasks is included below.

Q3. Almost two thirds (62%) of the 108 students who attempted Question 3 were successful on the task shown below. Acceptable answers included $\frac{1}{2}$ or $\frac{9}{18}$. A common misconception was to simply add the numerators and denominators.

Complete the following equation:

$$\frac{7}{18} + \frac{1}{9} = \frac{\boxed{}}{\boxed{}}$$

Q4. Ninety percent (113 out of 125) of the students were successful on the task below.

This number line shows where the **number** $\frac{1}{3}$ is.

Put a cross (x) where you think the **number 1** would be on the number line.

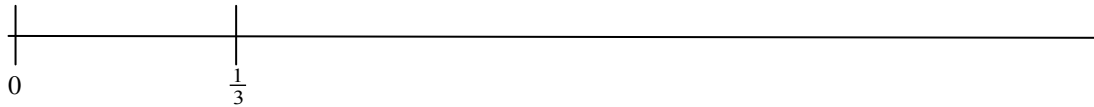

Q8. Just over half (58%) of the 108 students who responded to the ordering fractions task below were able to place them correctly in sequence. The improper fractions presented a particular challenge to some students, who confused the magnitude of eighths and tenths.

Place these fractions in order from **smallest to largest**.

$$\frac{1}{2} \quad \frac{1}{4} \quad \frac{7}{8} \quad \frac{12}{10} \quad \frac{3}{5} \quad \frac{10}{8} \quad \frac{1}{10} \quad \frac{3}{4}$$

Q14. One third (33%) of the 99 students who responded to the following question were correct. Many students appeared to confuse their knowledge of whole number processes such as “multiplication makes bigger” and “division makes smaller” with that for decimals.

Which is the largest number?

- A. $29 + 0.8$ B. 29×0.8 C. $29 \div 0.8$ D. $29 - 0.8$

Q17. Three-quarters (74%) of the 90 students who responded to a question below about the equivalence of multiplication by 0.5 to division by 2 were correct.

0.5 x 840 is the same as:

- A. $840 \div 2$ B. 5×840 C. 5×8400 D. $840 \div 5$ E. 0.50×84

Q19. Just over half (57%) of the 86 students who responded to a question about equivalent ratios were correct.

If 6 packets of chips cost the same amount as 4 ice creams, how many packets of chips would cost the same as 10 ice creams?

- A. 8 B. 12 C. 14 D. 15 E. 16

Discussion

The results from this study indicate that students were more positive towards mathematics in the recent past than they were when Biddulph (1999) conducted his study. More than half (57%) of the students were positive about mathematics, and only 16 percent were negative, compared with 22% to 28% positive and 54% to 64% negative in Biddulph’s study. When asked about their attitude towards the prospect of teaching mathematics, slightly more students (67%) were positive and only 17% were negative. It is difficult to know just how much the improvement in attitudes towards mathematics is related to mathematics education reforms.

Although there appears to have been an improvement in pre-service teachers' attitudes towards mathematics over the past decade, the content of some students' comments is of considerable concern. Unlike some institutions, students are not required to meet a standard of mathematics knowledge and understanding before being allowed to graduate. Students are encouraged to choose from several option papers, rather than being guided into papers that might strengthen areas in which they are not as strong.

The numbers of students who were unable to successfully complete particular fractional number tasks presented to them was disappointing. Some students claimed that they were severely disadvantaged by not being given prior warning about the written assessment tasks. However, if students had been warned, some not have attended the class. Moreover, advanced warning of the test may have caused more distress to certain students with a tendency to worry about their performance in the period leading up to the test, even though it did not contribute to final grades.

An important question that needs to be asked is about the extent to which the consent process required for ethical approval of the study distorted the pattern of findings. It is clear that the responses of those students who did not consent to being included in the research (~30 out of 45) did tend to be more negative or neutral than those who of students who gave consent. It is unfortunate that some of those students for whom support may be most needed did not cooperate with efforts to gain a better understanding of their situation. It is also possible that students' performance on the mathematics tasks was effectively inflated by including only those responses where a task had been attempted. Consequently, care needs to be taken in interpreting these findings.

The findings show the complex nature of pre-service students' attitudes towards mathematics and the prospect of teaching mathematics, and the importance of making a distinction between these.

Acknowledgements

Thanks are extended to the New Zealand Ministry of Education and the University of Waikato School of Education Research Committee for funding parts of this research.

References

- Biddulph, F. (1999). The legacy of schooling: Student teachers' initial mathematical feelings and competence. *Mathematics Teacher Education and Development*, 1, 64-71.
- Boaler, J. (2008). *What's math got to do with it? Helping children learn to love their least favourite subject – and why it's important for America*. New York, NY: Viking.
- Bobis, J., Clarke, B., Clarke, D., Thomas, G., Wright, R., Young-Loveridge, J., & Gould, P. (2005). Supporting teachers in the development of young children's mathematical thinking: Three large-scale cases. *Mathematics Education Research Journal*, 16 (3), 27-57.
- Burns, M. (1998). *Math: Facing an American phobia*. Sausalito, CA: Math Solutions Publications.
- Christensen, I. (2003). *An evaluation of Te Poutama Tau*. Wellington: Ministry of Education.
- Grootenboer, P., Lomas, G. & Ingram, N. (2008). The affective domain and mathematics education. In H. Forgasz, A. Barkatsas, A. Bishop, B. Clarke, S. Keast et al (eds.), *Research in mathematics education in Australasia 2004-2007* (pp. 255-269). Rotterdam, The Netherlands: Sense Publishers.
- Leder, G. & Grootenboer, P. (2005). Editorial. *Mathematics Education Research Journal*, 17 (2), 1-8.
- Ministry of Education (1992). *Mathematics in the New Zealand curriculum*. Wellington, NZ: Author.
- Ministry of Education (2001). *Curriculum update 45: The numeracy story*. Wellington, NZ: Author.
- Ministry of Education (2007). *The New Zealand curriculum*. Wellington, NZ: Author.
- Ministry of Education (2008). *Book 1: The number framework: Revised edition 2007*. Wellington, NZ: Author.
- Ministry of Education (2009). *The New Zealand curriculum mathematics standards for years 1-8*. Wellington, NZ: Author.

- Rayner, V., Pitsolantis, N. & Osana, H. (2009). Mathematics anxiety in pre-service teachers: Its relationship to their conceptual and procedural knowledge of fractions. *Mathematics Education Research Journal*, 21 (3), 60-85.
- Skemp, R. (2006). Relational understanding and instrumental understanding. *Mathematics Teaching in the Middle School*, 12, 88-95.
- Trinick, T. (2009). Longitudinal patterns of performance: Te Poutama Tau. In *Findings from the New Zealand Numeracy Development Projects 2008* (pp. 27-38). Wellington, NZ: Ministry of Education.
- Young-Loveridge, J. (2008). Development of children's mathematics thinking in early school years. In O. N. Saracho & B. Spodek (Eds.), *Contemporary perspectives on mathematics in early childhood education* (pp. 133-156). Charlotte, NC: Information Age Publishing.
- Young-Loveridge, J. & Peters, S. (2005). Mathematics teaching and learning in the early years in Aotearoa/New Zealand. *Australian Journal of Early Childhood*, 30 (4), 19-24.

Appendix

Questions used to assess students' attitudes towards mathematics/numeracy

Attitude towards Mathematics/Numeracy

Circle the number corresponding to how much you enjoy maths. Explain why you feel this way in the space below.

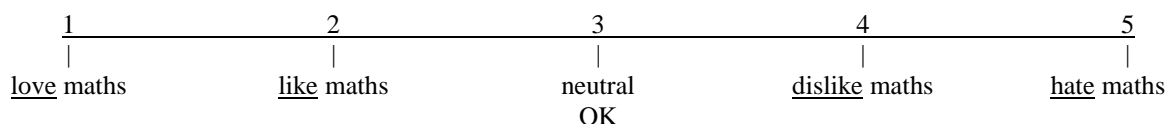

Attitude towards Teaching Mathematics/Numeracy

Circle the number corresponding to how much you are looking forward to teaching maths/numeracy in the future. Explain why you feel this way in the space below.

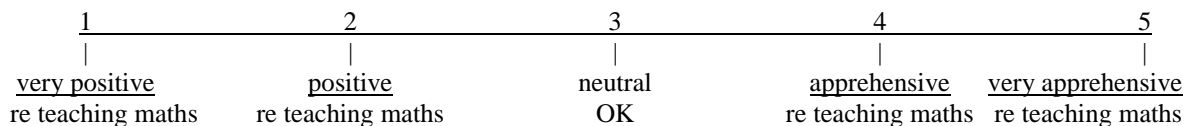

Preparedness to Teach Mathematics/Numeracy

How well prepared do you think you are to teach mathematics/numeracy next year? Comments?

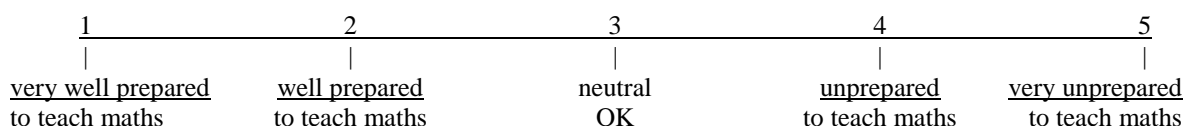

Symposia



Playing with Mathematics: Play in Early Childhood as a Context for Mathematical Learning.

Janette Bobis (Chair)
Sydney University
<janette.bobis@sydney.edu.au>

Eva deVries
Australian Catholic University
<Eva.deVries@acu.edu.au>

Sue Dockett
Charles Sturt University
<sdockett@csu.edu.au>

Kate Highfield (Discussant)
Macquarie University
<kate.highfield@mq.edu.au>

Robert P. Hunting
La Trobe University
<r.hunting@latrobe.edu.au>

Shiree Lee
The University of Auckland
<shiree.lee@auckland.ac.nz>

Bob Perry
Charles Sturt University
<bperry@csu.edu.au>

Louise Thomas
Australian Catholic University
<Louise.Thomas@acu.edu.au>

Elizabeth Warren
Australian Catholic University
<elizabeth.warren@acu.edu.au>

Play is an essential part of young children's lives. This symposium highlights the integral role of play in young children's mathematics learning and examines the teacher's role in facilitating and extending this. Papers examine key tenets of play, contributing to theoretical understandings and presenting data on teacher's perceptions of play and young children's actions in play. Examination of teacher perceptions and young children's experiences of mathematical play identifies potential for development of mathematical concepts beyond embryonic mathematics inherent in play.

Paper 1: Sue Dockett and Bob Perry; Charles Sturt University. *What makes mathematics play?*

Paper 2: Louise Thomas, Elizabeth Warren and Eva deVries; Australian Catholic University. *Teaching mathematics and play based learning in an Indigenous early childhood setting: Early childhood teachers' perspectives.*

Paper 3: Shiree Lee; The University of Auckland. *Mathematical outdoor play: Toddler's experiences.*

Paper 4: Robert P. Hunting; La Trobe University. *Little people, big play, and big mathematical ideas.*

What Makes Mathematics Play?

Sue Dockett
Charles Sturt University
<sdockett@csu.edu.au>

Bob Perry
Charles Sturt University
<bperry@csu.edu.au>

This paper considers examples of situations in mathematics learning that are often described as play-based and critiques these in light of conceptualisations of play focusing on children's processes and dispositions. The potential of play in mathematics learning is investigated and the question asked as to whether it matters if children make mathematics play. The role of early childhood educators in using play to build on children's existing mathematical understandings is explored.

Play has long been regarded as a critical element of early childhood curriculum and pedagogy. In addition to being recognised as a vehicle for learning, play is described as a context in which children can demonstrate their own learning and help scaffold the learning of others (Wood, 2008). Despite this, educators often struggle to explain what it is about play that promotes learning and ways in which they can actively facilitate both play and learning (Ranz-Smith, 2007). While this situation applies generally, van Oers (1996) notes that the potential of play to facilitate children's mathematical thinking depends largely on educators' ability to "seize on the teaching opportunities in an adequate way" (p. 71). We argue in this paper that this ability requires: mathematical knowledge; understanding the nature of children's play, particularly the characteristics of play that promote mathematical learning and thinking; and awareness of the role of adults in promoting both play and mathematical understanding. We start this discussion by focusing on the following situations described by educators as involving play and mathematics, asking — *Does this experience involve play?* and then — *Why does it matter?*

Interest Centres

Teachers of the four-year-old group have set up several interest centres around the room as part of their maths program. These include puzzles, boxes of beads and threading patterns, drawing materials, several sets of picture dominoes and Playdough. Children are assigned to an activity and after ten minutes, teachers make a signal and direct them to the next activity.

A Shell from Home

A group of three-year-olds is having a conversation with an adult. One of the children has brought a large shell from home and the children and adult are discussing its features, including shape and colour, where it may have come from, and how it was found. Both the adult and the children have many questions, as well as many possible answers.

Trampoline

A group of children waits patiently for a turn as one girl jumps on the trampoline. She explains that she will finish her turn when she gets to 50. She counts aloud, 33, 34, 25, 26...

Matching Game

An educator invites three children to sit with her and play a matching game. The educator explains the rules of the game, noting how children locate matching sets of animals. Each child takes their turn and each gathers several sets of cards.

Blocks

One child has seated herself on the floor in the middle of a pile of blocks. There is no room for anyone else in the space. Over a period of forty-five minutes, she proceeds to build up a series of towers, and then knock them down.

Do these Experiences Involve Play?

The answer to this question largely depends on the definition of play adopted. There are many definitions of play, reflecting different theoretical perspectives of learning and development. Drawing on some of the elements of traditional theories of play, recent conceptualisations have adopted critical approaches to assumptions about the universality of play, categorisations of play, the automatic connection between play and learning, and the role of adults in supporting play (Wood, 2007). Current research, while not totally rejecting some of the basic tenets of earlier, traditional approaches to play, focuses on the processes and dispositions of play, the generation of complex and varied forms of play, and recognition of the social and cultural contexts of play (Wood, 2008).

In keeping with the focus on play as a process and disposition, researchers concur that play cannot be defined by its subject matter: “play is a particular *attitude or approach* to materials, behaviours, and ideas and *not* the materials or activities or ideas themselves; play is a special mode of thinking and doing” (McLane, 2003, p. 11). In this sense, the process of play is characterised by a non-literal ‘what if’ approach to thinking, where multiple end points or outcomes are possible. In other words, play generates situations where there is no one ‘right’ answer. McLane (2003, p. 11) described this as conferring “a sense of possibility, as well as ownership, control and competence on the player”. Essential characteristics of play then, include the exercise of choice, non-literal approaches, multiple possible outcomes and acknowledgement of the competence of players. These characteristics apply to the processes of play, regardless of the content. In addition, thinking of play as a disposition, or habit of mind (Carr, 2001), helps to link it with other dispositions that are valued in education, including mathematics education, such as creativity, curiosity, problem posing and problem solving (Ginsburg, 2006; NAEYC/NCTM, 2002).

Some of the situations outlined earlier in this paper reflect a context where the children have ownership and control in the initiation, direction and outcome for the activity. For example, the child immersed in block play creates both a physical as well as a conceptual space in which to play and determines the direction and outcomes for the play. By keeping others out, she exerts competence and control. The girl on the trampoline exerts similar qualities. The children talking about the shell also control the experience. It is the one child’s choice to bring the shell to the preschool and all participants – including the children, guide the discussion. In the other situations, control of the experience is much more vested in the teacher who has determined what experiences are on offer, the materials to be used, the ways in which the activity is to be conducted and the desired outcomes for each experience. Each of these experiences can make a valuable contribution to learning and teaching – they are just not play.

Why Does It Matter?

If a wide range of experiences can support children's learning of mathematics, why does it matter that some of these experiences be deemed to be play and others not? In answering this question we draw on some of the commonalities between play and mathematics. We argue that fluency in the processes underpinning play can, with the skilled guidance of educators, promote a range of mathematical knowledge and understanding.

Children's play can be very complex. Sometimes play develops and evolves over several days, weeks or even longer. There will often be negotiations about roles, rules, materials and scripts. The actual context of the play can also be complex – such as when children play with abstract ideas and possibilities. Mathematics is present in much of children's spontaneous play (Seo & Ginsburg, 2004). Educators who are alert to this, and who themselves feel competent and comfortable playing with mathematics can provoke deep understanding. These educators are also likely to display, and model to the children, the dispositions of playfulness, curiosity, critical and creative thinking (Carr, 2001).

Play is often an inherently social activity. Vygotsky (1967) argued that even solitary play replicates social and cultural contexts, particularly in the rules and roles adopted by players. When play involves others – be they adults or children – opportunities for scaffolding (Bruner, 1986) occur as children interact with more knowledgeable and experienced others. The social interactions within play facilitate joint meaning making, as children test out, explain and enact their perspectives and understandings, at the same time as they encounter those of others. Social interaction in play provides support for the challenges children often construct in play, creating opportunities for innovation, risk taking and problem solving. Such interactions also underpin mathematical thinking.

Play has been described as a context in which children can integrate experiences and understandings, draw on their past experiences, make connections across experiences, represent these in different ways, explore possibilities and create meaning (Bennett, Wood, & Rogers, 1997). If mathematics is as much about understanding connections, processes and possibilities as it is about knowing facts, then play and mathematics have much in common (NAEYC/NCTM, 2002; Perry & Dockett, 2008).

Young children's play often involves mathematical concepts, ideas and explorations (Perry & Dockett, 2008; Seo & Ginsburg, 2004). Ginsburg (2006) described a range of mathematical experiences and concepts embedded in early childhood environments: children's free play; play about mathematics; and children's play with the ideas and approaches that have been introduced by educators. Educators who facilitate children's play and who are aware of the nature and complexity of that play are well positioned to build on children's existing knowledge and understandings – another tenet of early childhood curriculum and pedagogy. It has been noted that “play does not guarantee mathematical development, but it offers rich possibilities. Significant benefits are more likely when teachers follow up by engaging children in reflecting on and representing the mathematical ideas that have emerged in their play” (NAEYC/NCTM, 2002, p. 6). Similar support for play is derived from the AAMT/ECA (2006) position statement in early mathematics, which exhorts educators to: promote play with mathematics as one means of engaging children's natural curiosity; recognise mathematics as a social activity; and promote mathematics that has relevance to children's everyday lives.

Conclusion

In a context of increasing accountability and rising academic expectations, the educational value of play has been questioned (Dockett, Perry, Campbell, Hard, Kearney, & Taffe, 2007; Wood, 2008). When educators evidence a sound knowledge of mathematics, a pedagogical repertoire that includes play, and awareness of the connections between these, there is great potential for early childhood experiences that extend young children's mathematical understandings and dispositions. There is much to be gained from making mathematics play.

References

- AAMT/ECA. (2006) Position paper on early mathematics. From <http://www.aamt.edu.au/Documentation/Statements/Position-Paper-on-Early-Childhood-Mathematics>
- Bennett, N., Wood, L., & Rogers, S. (1997) *Teaching through play: Teachers' thinking and classroom practice*, Buckingham, UK: Open University Press.
- Bruner, J. (1986). *Actual minds: Possible worlds*. Cambridge, MA: Harvard University Press.
- Carr, M. (2001). *Assessment in early childhood: Learning stories*. London: Paul Chapman.
- Dockett, S., Perry, B., Campbell, H., Hard, L., Kearney, E., & Taffe, R. (2007). *Reconceptualising Reception: Continuity of learning*. From http://www.earlyyears.sa.edu.au/files/links/final_lit_review.pdf
- Ginsburg, H. P. (2006). Mathematical play and playful mathematics: A guide for early education. In R. M. Golinkoff, K Hirsh-Pasek, & D. Singer (Eds.), *Play=learning* (pp. 145-165). New York: Oxford University Press.
- McLane, J. B. (2003). "Does not." "Does too." *Thinking about play in the early childhood classroom*. Erikson Institute Occasional Paper Number 4.
- NAEYC/NCTM. (2002). *Position statement: Early childhood mathematics: Promoting good beginnings*. From <http://www.naeyc.org/about/position/psmath.asp>
- Perry, B., & Dockett, S. (2008). Young children's access to powerful mathematical ideas. In L. D. English (Ed.). *Handbook of international research in mathematics education* (2nd ed) (pp. 75-108). New York: Routledge.
- Ranz-Smith, D. J. (2007). Teacher perception of play: In leaving no child behind are teachers leaving childhood behind? *Early Education and Development*, 18, 2: 271-303.
- Seo, K-H., & Ginsburg, H.P. (2004). What is developmentally appropriate in early childhood mathematics education? Lessons from new research. In D. H. Clements, J. Sarama, & A-M. DiBiase (Eds.), *Engaging young children in mathematics: Standards for early childhood mathematics education* (pp. 91-104). Hillsdale, NJ: Erlbaum.
- Van Oers, B. (1996). Are you sure? Stimulating mathematical thinking during young children's play. *European Early Childhood Education Research Journal*, 4(1), 71-87.
- Vygotsky, L. (1967). Play and its role in the mental development of the child. *Soviet Psychology*, 5(3), 6-18.
- Wood, E. (2007). New directions in play: Consensus or collision? *Education 3-13*, 35 (4), 309-320.
- Wood, E. (2008) Conceptualising a pedagogy of play: International perspectives from theory, policy and practice, in D. Kurschner (Ed.) *From children to red hatters: Diverse images and issues of play*, Play and Culture Studies, 8, 166-190.

Teaching Mathematics and Play-based Learning in an Indigenous Early Childhood Setting: Early Childhood Teachers' Perspectives.

Eva deVries
Australian Catholic University
<Eva.deVries@acu.edu.au>

Louise Thomas
Australian Catholic University
<Louise.Thomas@acu.edu.au>

Elizabeth Warren
Australian Catholic University
<elizabeth.warren@acu.edu.au>

In recent years there has been a surge in attention concerning early childhood settings and mathematics learning. The literature provides several reasons for this. In brief these are (a) a recognition that children enter school with a great deal of intuitive knowledge about mathematics and that this knowledge can serve as a base for developing formal mathematics in a school setting, young children do not need to be made ready to learn mathematics (Carpenter, 1996), (b) there is a relationship between early mathematical knowledge and later achievement (Aubrey, Dahl & Godfrey, 2006), (c) the main determinants of later achievement is quality early mathematical experiences (Young-Loveridge, Peters & Carr, 1997), and (d) young children are capable of engaging in mathematically challenging concepts (Balfanz, Ginsburg & Greenes, 2003). Yet many early childhood teachers are reluctant to embrace an active role in the teaching of mathematical concepts (Grieshaber, 2008a) and continue to perceive teaching and play-based pedagogies as incompatible (Ryan & Goffin, 2008). More specifically, early childhood practitioners are often fearful of mathematics and see a mathematics curriculum as having the potential to restrict children's choices and thus "inhibit their ability to be self regulatory and autonomous" (Macmillan, 2009, p. 110).

A suggestion presented in this paper is that the core business of young children is *playing* and the core business of teachers (including early childhood teachers) is *teaching*. To give consideration to these statements we first need to ask: What does teaching look like? *and* Would one know 'teaching' if one saw it in an early childhood setting? The work that early childhood teachers do with young children is referred to by an array of terms and it is rare to find that the term 'teaching' is used to describe this work. Children learn through play and a dominant theory in early childhood education suggests that they need adult guidance to assist them to reach their full learning potential (Balfanz, Ginsburg & Greenes, 2003; Vygotsky, 1962). This paper argues that play is a pedagogical tool that can enable learning and this learning can be maximised with appropriate, timely and effective adult input.

The research project reported here (Warren, deVries, & Thomas, 2009), looked at the mathematical experiences of pre-prep children in a Brisbane Indigenous kindergarten (average age 3 years and 6 months). The sample comprised two teachers and twenty-eight children. Given that Tayler, Thorpe and Bridgstock (as cited in Fleer & Rabin, 2007) report that, as compared with other cohorts of early years children, Indigenous children gain even less from attending play-based programs, this project endeavoured to investigate ways in which pre-prep children, engaged in play-based programs, could be supported in their mathematical learning. The overarching objective was to develop culturally appropriate best practice/research grounded teacher and parent materials to support the transition of Indigenous children from home to school with regard to their numeracy learning.

The focus of this paper is to examine the teachers' perspectives on play in early childhood education and their reflections as they incorporated mathematical experiences

into their play-based program. Of particular interest, in the reporting of this aspect of the project was ways in which the teachers spoke of what they did when engaging with young children in a mathematical context.

Method

The research methodology involved initial interviews with the two early childhood teachers that took the form of focused conversations. These interviews were followed by professional development sessions based on numeracy for young children and the supported implementation of various numeracy based experiences into the pre-prep program. The model used for the professional learning was the Transformative Teaching in Early Years Mathematics [*The TTEYM Model* (Warren, 2009)], a model underpinned by the theories of Vygotsky which state “children’s [and teachers’] development is best guided by people who are experienced in using these tools (i.e., language, mathematical systems, and technologies)” (Hill, Stremmel & Fu, 2005, p. 15).

After several weeks when the teachers and children had engaged with these experiences as part of the pre-prep program, video data was collected of children and teachers at work (and play) in the classroom. The teachers then individually viewed these videoed sessions with the researcher. Audio recordings were taken of each teacher as they viewed and discussed their own facilitation of these numeracy experiences as recorded on the video. The transcriptions of these recordings were analysed to identify ways in which teachers spoke about children’s engagement with mathematical concepts and their use of a play-based pedagogy.

Results

Interview 1: – In their initial interview (prior to TTEYM) the teachers spoke of play as an important element of learning processes and something over which children have control:

Play to me is an important part of learning. ... Most importantly they (the children) have control over their play. ... I allow the children to help plan their play. [Interview 1 (b)]

Play was seen as part of learning. This implied that there was something more to learning than just ‘play’. Children were identified as active participants with control over their play.

However, this was not all that these teachers spoke of when identifying play as a feature of their curriculum and pedagogy. Of significance for these teachers was their role in the children’s play:

To listen (...) to help them achieve (...) to extend and enhance their play... [Interview 1 (b)] (...) as the teacher you try and investigate what they’re doing first (...) and then you guide that conversation and do not do the play for them [Interview 1 (a)]. You guide that play (...) and once they get that concept and are able to communicate it, well their play will be better [Interview 1 (a)]

Interview 2: - Following the professional learning (TTEYM) and the introduction of mathematics experiences into the classroom, the teachers spent time viewing their own practice (videoed by the researcher). The following points reflect how the teachers spoke of the interplay between their role as *supporters* of play and *teachers* of mathematics.

The mathematical experiences presented in TTEYM were seen as interesting enough to entice the children and capture their interest. This enabled the teachers to operate within

their pedagogical philosophy that play is a key component of children's learning and that the children should direct it:

they are confident and they want to have a go, they want to play all the games before they know they can because they have prior knowledge about number which you build up as a teacher. And then when they go on to the next level like pre-prep before they go to formal schooling that they can build upon that knowledge again, again and again. [Interview 2 (a): 259]

There was also support for the teaching of skills as a means of enhancing children's confidence in themselves as learners and teachers.

And once the child gets very good at it and understands all the concepts of learning it, they (the child) will begin to teach (i.e. they will play the game with other children) it. Because they know they have become very good at it [Interview 2 (a): 271]. When some of the more ... confident ones came along, and start the game themselves, they sort of encourage some of the not so confident ones to come over. [Interview 2 (b): 125-127]

The teachers were able to identify that these children were beginning to transfer their mathematical knowledge across tasks, something they had not previously evidenced.

... I find that because we did the fly game and then I put out the fishing game another time, that they were more interested in the fishing game also, but in a different way because when they did the fly game (and then) went over to the fishing game, then they were taking the fishes off the line and lining them all up. So you know, normally they would sort of just catch the fish and put it in the bucket and that's it they wouldn't do anything more with it [Interview 2 (b): 23]

The teachers could also identify which children were able to incorporate the knowledge and skills experienced through the direct teaching element of the introduction of the games into their play:

...it (the introduction of activities) sort of helps them in their other play to extend it a bit more ... in what they want to get out of it - not what we want them to get out of it [Interview 2(b):31-35].

One teacher also indicated how the project had changed the ways in which she engages in teaching practices:

..if they don't pick it up first time around .. I ask them a different way, then they pick it up that way. ... they are really thinking about ... what we are saying, what they need to listen to, It's good ... it's made me as a teacher more aware of ... how I speak to the children. [Interview 2 (b):106-118]

The shift in teachers' talk between Interview 1 and Interview 2 raises for consideration the positioning of both children and teachers as either active or passive participants in the dance between *teaching* mathematics and *play based learning*. Specifically one teacher was able to articulate the different focus for children and teachers as active participants in learning contexts that draw on play as a tool to enable active engagement in learning.

...it has made me think a lot more..., what to plan for the children ..., for them also to help me plan If they suggest something then I try to work it out, ... they can get this out of that activity ... what can I throw in to help them, with their numbers, extend it a little bit more I've added something else in there to extend ... to ... try ... their numbers and recognise their numbers and language ... Not overwhelm them, but..., try to help them get the best out of the activity, that they enjoy and stay at it longer [Interview 2 (b):213-223]

The children were focused on play and the teacher's role was to focus on how and when she could 'step-in' and engage in teaching. In this way the teacher was able to talk of her responsibility to influence children's learning and her belief in children's autonomy in planning their play. It was evident in the shift in the teachers' talk that they had added to their focus on children as active participants in play (and therefore learning) to include a view of themselves also as active participants in children's play (and therefore learning).

Analysis of the teachers' talk enables the holding together of play and learning as teachers actively engage in appropriate processes of teaching.

The literature informing this analysis raises for deliberation the question – Is there a silencing of the term 'teaching' in play based contexts and to what extent are early childhood teachers complicit in this silencing? Teaching as a missing term in early childhood contexts has been recently addressed (Grieshaber, 2008b). When early childhood teachers speak of 'sustained shared thinking', 'the teachable moment' 'facilitation of learning', 'guided participation' 'scaffolding', 'co-constructing' are these responses to an early childhood discourse that excludes use of the term teaching or is it a way of disguising their talk of teaching – given that teaching is a discourse not generally considered acceptable in an early childhood context (McArdle & McWilliam, 2001).

The results of this project begin to evidence that at the commencement of TTEYM the teachers perceived play based learning and teaching to be at odds. That is, that play is child directed and a teacher's role is to extend and enhance the play in a passive manner. Two key components of TTEYM appeared to challenge these perceptions. These were (a) the types of mathematical activities presented in the professional development session (engaging and hands on), and (b) the maths expert's active implementation of these activities with 'real children' in a play-based context.

Ryan and Goffin (2008) called for a shift in research targets in the area of early childhood education that allows for a greater focus on teachers' perspectives and thinking about their work with young children. This paper calls for further work by both researchers and practitioners in the fields of early childhood education and mathematics with a focus on how early childhood teachers construct themselves as teachers engaged in both a play-based pedagogy and mathematics as a curriculum discipline.

References

- Aubrey, C., Dahl, S., & Godfrey, R. (2006). Early mathematics development and later achievement: Further evidence. *Mathematics Education Research Journal* 18(1), 21-46.
- Balfanz, R., Ginsburg, H., & Greenes, C. (2003). The big maths for little kids early childhood mathematics program. *Teaching Children Mathematics*, 264-268.
- Carpenter, T. P. (1996). Cognitively guided instruction: A knowledge base for reform in primary Mathematics Instruction. *Elementary School Journal*, 97 (1), 3-20.
- Fleer, M., & Raban B. (2007). Constructing cultural-historical tools for supporting young children's concept formation in early literacy and numeracy. *Early Years*, 27(2), 103-118.
- Grieshaber, S. (2008a). Marginalization, making meaning, and mazes. In G. Genishi, & A. L. Goodwin (Eds.). *Diversities in early childhood education: Rethinking and doing*. New York: Routledge.
- Grieshaber, S. (2008b). Interrupting stereotypes: Teaching and the education of young children. *Early Education and Development*. 19 (3), 505-518.
- Hill, L., Stremmel, A., & Fu, V. (2005). *Teaching as inquiry: Rethinking curriculum in early childhood education*. Boston: Pearson.
- Macmillan, A. (2009). *Numeracy in early childhood: Shared contexts for teaching and learning*. South Melbourne: Oxford University Press.
- McArdle, F., & McWilliam, E. (2005). From balance to blasphemy: shifting metaphors for researching early childhood education. *International Journal of Qualitative Studies in Education*, 18(3), 323-336.
- Ryan, S. & Goffin, S. (2008). Missing in action: Teaching in early care and education. *Early Education and Development*, 19 (3), 385-395.
- Vygotsky, L. (1962). *Thought and language* (E. Hanfmann & G. Vakar, Trans.). Cambridge, MA: Massachusetts Institute of Technology. (Original work published in 1934).
- Warren, E. (2009). Early childhood teachers' professional learning in early algebraic thinking a model that supports new knowledge and pedagogy. *Mathematics Teacher Education and Development*, 10, 30-45.
- Young-Loveridge, J., Peters, S., & Carr, M. (1997). Enhancing the mathematics of four year-olds. An overview of the EMI-4S Study. *Journal for Australian Research in Early Childhood Education*, 2, 82-93.
- Waren, E., deVries, E., & Thomas, L. (2009). *Early numeracy in pre-prep settings: Final report*. ACU

Mathematical Outdoor Play: Toddler's Experiences

Shiree Lee

The University of Auckland

<shiree.lee@auckland.ac.nz>

Mathematics is a subject area that is generally understood and accepted as an important part of academic learning and therefore has an important part to play in the formal education of our children. However, in New Zealand there is no such formal requirement in early childhood education and therefore mathematics is an area often overlooked by early childhood teachers and parents. This paper reports a summary of the findings of a case study where observations of toddler's outdoor play episodes showed evidence of mathematical knowledge and skill in unstructured play activity.

Within NZ early childhood settings it is generally accepted that the very highest quality learning and teaching occurs through play. However the term 'play' can have a wide variety of definitions. Within this study the incidents of toddlers exploring and engaging in what has been termed 'mathematical play' were situated within a child-centred and integrated curriculum. The toddlers directed their own experiences within the outdoor area and engaged in a wide variety of play activity that has the potential to be analysed from a variety of perspectives. Learning within early childhood, and the experiences that can constitute learning, occur in the socio-cultural, holistic environment of a learning community (Rogoff, 1998; Burton, 2002), the play curriculum.

Another key tenet of mathematical play that was evident within this study is the notion of enjoyment. For children to be involved in play it must be fun. "We can influence young children's keenness to learn mathematics by making the tasks we do of interest to them ... by showing that we really think maths is important and fun", (Clemson & Clemson, 1994, p. 19).

The notion of an integrated curriculum in early childhood, underpinned by socio-cultural theory, includes all actions, interactions, experiences and routines that children are involved in - that is, all subject domain areas as well as routines such as meals and hygiene practices. This curriculum, and therefore the environment of the setting, was facilitated, supervised and set up by the teachers, but the children were free to explore the environment in an unstructured manner, and to add additional resources from the indoors as they wished.

Mathematical Play

Each of the following mathematical categories arose from the analysis of the observations of children's play. These are presented in order of frequency of occurrence and give examples related to that particular category. The mathematical process of problem solving has not been specifically reported in this paper but is inherent within each of the other categories.

Space

Space (and spatial concepts) arose as the most common area of mathematical understanding that the toddlers displayed in this study. This is in direct contrast to previous research describing young children's apparent lack of skill as being due to the inability to make abstractions, apply logic or understand representation (Piaget, 1952). For example,

Sarah aged two years, two months [2:2] was able to figure out how to ride a bike and wear a circular skirt at the same time without it getting caught in the wheel. This showed that she was able to apply logic to the situation in order to move within the space. She may have been thinking ‘if I lift the skirt it will not be in the way anymore, so therefore I need to hold the skirt up as I ride’. Sarah’s previous experience of manipulating objects and herself in space enabled her to solve her problem. In other words, she was applying logic to her situation.

Toddlers’ knowledge of ways to manipulate objects to create space was evident when Lyle [1:10] and Ricky [2:7] moved large cardboard cartons around another child in order to fit themselves into them. The children’s experience with both the movement of the boxes and their bodies enabled them to complete their self-chosen task successfully. These incidents show the children’s understanding of underlying concepts of space, and that in order to create space, move within space, and manipulate space, they must think and act logically, abstractly, and at times draw from previous experience.

If toddlers did not possess skills of abstraction, logic or representation they would be unable to explore space in the ways observed in this study. They would not have the ability to solve problems, move objects in a logical way or negotiate with others.

Number

Number is the most commonly discussed, debated and reported upon mathematics within the readily available literature. However, no examples could be sourced that discussed or described the foundational concepts of number being developed in children younger than three years of age. Yet this was the second most common category of mathematics observed within the toddler’s play experiences.

Number skills, including counting sequences both forward and backward, using number to name and classify objects, counting as timing and quantification, were all evident in the toddlers’ outdoor play experiences. This skill in number concepts occurred at a much younger age than has previously been recognised. For example; Fraser [2:10] counted out loud (rote counting) from one to six; Trent, [2:0] stated that he was holding two sand scoops; and Anne, [2:7] counted from one to ten in both forwards and backwards sequences.

Measurement

The third most common category of mathematics evident within the children’s play involved toddlers exploring measurement concepts. However, some of the toddlers’ ‘measures’ were not accurate but naïve (Wellman & Gelman, 1992). With children in the toddler stage this is to be expected and the refining of these skills will continue to occur with further experiences. Interestingly, measurement is the category that showed evidence of mathematical exploration by the youngest child in the findings. Ryder, [1:3], was observed exploring volume by placing handfuls of sand onto his feet. The change of measuring tool from his hand to a sand scoop showed an understanding that the tool increased the volume of sand moved. This showed his developing knowledge of a way to move more sand and, by implication, to measure more efficiently.

Pattern

Recent mathematics education research has been focused upon the development and knowledge of patterning, which has been found to influence children’s reasoning and the

ability to generalise patterns (e.g. Mulligan, Mitchelmore & Prescott, 2006; English, 2004). However, this research was conducted with four to six year old children and was focused upon graphical representation (picture patterns) rather than play behaviour.

Toddlers were observed repeating the refrain of a popular television tune, expressing knowledge that mealtime was approaching, and repeating of behaviours in play episodes. Similar to the previous categories of mathematical play, toddlers' prior experiences of these patterning concepts had laid the foundations for their knowledge and skill, and showed their conceptual knowledge of the routines and patterns of the day.

Shape

Knowledge of the geometrical properties and names of shapes is a common feature of academic programmes and this is evident in the available research concerning children four years of age and older (e.g. Geist, 2001; Pound, 2006; Willis, 2001). Shape concepts, as well as most mathematical ideas, are not commonly described within the literature as appropriate for infants or toddlers.

In this study, only four observations were relevant to the category of shape, and only one included a toddler applying a name to a shape verbally. However, three other observations showed evidence of the toddlers' understanding of similarity between shapes (even when unable to name them). Awareness of shape can be clearly seen in the incident with Gene [2:8] in the sandpit where he was carefully creating 'sandcastles' with a castle-shaped bucket. Each time the 'castle' was not perfect he placed the bucket back over it in an attempt to 'correct' the shape. When the 'castle' did turn out correct, he smiled and then demolished it. He understood the shape he wanted and was persisting in his effort to achieve it.

Classification

In order to apply abstraction of concepts, logical solutions to problems, and gain understanding of how objects, people and places can be grouped, skills in classification must be gained (Geist, 2001; Babbington, 2003). In this study toddlers classified a range of objects for their own purposes. For example, Bree [2:5] had clear understanding of which napkins were hers and became quite distressed when she had to wear a different type.

Conclusion and the Way Forward.

This paper reports on a larger study that provided convincing evidence that toddlers engage in outdoor play experiences that contain mathematics and highlights toddlers as competent and confident learners of mathematics. While maintaining a play-based and integrated curriculum, the mathematical knowledge of children, particularly toddlers, requires more explicit attention from teachers.

Purposeful teaching and learning in mathematics is enabled when teachers provide resources and environments that encourage exploration in the outdoors. They must also hold adequate subject content knowledge and ideally an interest in mathematical ideas. Finally, we must all strive to ensure that mathematical learning is meaningful and enjoyable for children. The curriculum needs to retain a sense of playfulness and fun to ensure that children develop positive dispositions for learning through their play experiences.

References

- Babbington, S. (2003). *The magic of mathematics*. Paper presented at the 8th Early Childhood Convention. Palmerston North, September 4-8.
- Burton, L. (1994). *Children learning mathematics: Patterns and relationships*. Hemel Hempstead: Simon and Schuster Education.
- English, L. D. (2004). Mathematical and analogical reasoning in early childhood. In L. D. English, (Ed.), *Mathematical and Analogical Reasoning of Young Learners* (pp. 1-22). Mahwah, New Jersey: Lawrence Erlbaum Associates.
- Geist, E. (2001). Children are born mathematicians: Promoting the construction of early mathematical concepts in children under five. *Young Children*, 56(4), 12-19
- Mulligan, J. T., Mitchelmore, M. C., & Prescott, A. (2006). Integrating concepts and processes in early mathematics: The Australian Pattern and Structure Mathematics Awareness Project (PASMAT). In J. Novotná, H. Moraová, M. Krátká & N. Stehlíková (Eds.), *Proceedings of the 30th annual conference of the International Group for the Psychology of Mathematics Education* (Vol. 4, pp. 209-216). Prague: Program Committee.
- Piaget, J. (1952). *The child's conception of number*. New York: Norton. (Original work published 1941).
- Pound, L. (2006). *Supporting mathematical development in the early years* (2nd ed.). Berkshire, United Kingdom: Open University Press.
- Rogoff, B. (1998). Cognition as a collaborative process. In W. Damon (Ed.), *Handbook of child psychology* (5th ed., vol. Two: Cognition, perception and language), pp. 679-744. New York: John Wiley and Sons.
- Wellman, H. M., & Gelman, S. (1992). Cognitive development: Foundational theories of core domains. *Annual Review of Psychology*, 43, 337-375
- Willis, S., (2001). *Becoming Numerate: Who's at risk and why?* Paper presented at Early Years Numeracy Conference, 31 May 2001, Melbourne, Vic: Monash University.

Little People, Big Play, and Big Mathematical Ideas

Robert P. Hunting
La Trobe University
<r.hunting@latrobe.edu.au>

The term *big play* is proposed to draw attention to the need for teachers and carers to become aware of embryonic mathematics inherent in activities of young children. Candidates for big ideas of early years mathematics are outlined, following brief discussion of what the expression *big mathematical idea* might mean.

Young children's play has many facets: free or self-directed (Smith, 1994), structured or teacher-directed (Bruner, 1986; Vygotsky, 1978), symbolic (Edo, 2009; Van Oers, 1994), constructive (Smilansky, 1968), and imaginative (Fein, 1981), to name a few (Keizer, 1983). Play may incorporate the invention and extension of action schema, and it may incorporate rehearsal and practise of those schema (Piaget, 1962). It is well accepted that play has an important role in early years mathematics learning (Griffith, 1994; Perry & Dockett, 2007). So the challenge for harnessing play for advancing young children's mathematical thinking raises questions such as: What kinds of mathematical thinking are young children capable of? What mathematics should young children be learning? Is some mathematics more appropriate or desirable than other mathematics? Can young children learn mathematics through their play experiences? If so, how can carers and teachers nurture and establish mathematical thinking through children's play?

Children's play, from the perspective of the mathematics educator, may not be uniformly efficacious for mathematical development, even though Piaget (1962) believed that "everything during the first few months of life, except feeding and emotions like fear and anger, is play" (p. 90). So it is suggested that *big* mathematical ideas potentially accessible to preschoolers be identified, so that carers and teachers might be alert to possible play contexts in which these ideas might become manifest, albeit in embryonic form. Once understood, appropriate interventions or activities may be planned so as to assist development of children's mathematical thinking. Hence the term 'big' play. It is first necessary to briefly discuss what the expression *big mathematical idea* could mean.

Differing Views on What Makes a Mathematical Idea 'Big'

There is no consensus at the levels of policy, curriculum development, or tertiary mathematics education as to what the *big ideas* of school mathematics might be (Hunting & Davis, 2010). To simplify, allow me to identify two poles or extreme positions representing this matter – what might be called the *soft* big idea and the *hard* big idea. The soft big idea is essentially to accept the status quo of school mathematics curriculum as we have experienced it for the past 100 years or so, and identify major curriculum topics that warrant attention. Examples might be: fractions, place value, long division, ratio and proportion, and so on. We call this meaning soft because of acceptance of the general belief that the selection and sequencing of school mathematics topics is the way we have always done it, based primarily on a logical analysis of elementary mathematics from an adult point of view, in the face of demonstrable overall failure to achieve success in teaching these. The hard big idea is to first ask what conceptual tools professional mathematicians have found to be fundamental and potent in the history of mathematics, and in their own mathematical education. Once established, attempt to develop ways and

means to establish preparatory foundations at school level, mindful that children’s mathematics and mathematical thinking is not the same as that of the adult (NAEYC & NCTM, 2002). Examples of hard big ideas include variability and randomness in chance processes, the notion of unit system, scale and similarity, boundary and limit, function, equivalence, infinity, recursion, and so on. The intersection between soft and hard big ideas is by no means the null set.

Other definitions of bigness might include those topics, or concepts or ideas in school mathematics that cause the most misunderstanding – those highly robust misconceptions. Or those topics, concepts or ideas that stimulate the greatest interest, or have the most interconnectedness across major strands, or capacity to unify specific conceptual clusters of ideas, or represent transition points at which major conceptual reorganisations or accommodations (Piaget, 1974) are necessary in order for deeper understanding to occur.

Candidates for Big Ideas of Early Childhood Mathematics

Table 1 provides a provisional list of candidates for big ideas in early childhood mathematics, together with brief comments.

Table 1
Candidates for Big Ideas of Early Years Mathematics

Candidate	Comment
The pigeonhole principle ³⁴	Dirichlet first formalised this principle (Elstrodt, 2007). One-to-one correspondence is at its root, and rational counting depends on it.
Negation	Some actions can be undone, neutralised or annulled, leading to reversibility (operations) (Piaget, 1954).
Class inclusion	Seriation, order, and asymmetric relationships including nested number relationships (Inhelder & Piaget, 1964)
Symmetry	Mirror images through paper folding (Schuler, 2001)
Partitioning into equal subsets; halving first	Sharing items using systematic dealing procedure (Davis & Hunting, 1990; Davis & Pitkethly, 1990).
Ratios	Two for me, one for you
Composition and decomposition of continuous and discontinuous material	Part-whole relationships (Bjorklund, 2008). Comparisons between set and subset foreshadow subtraction. Supersets may also be created through addition (Hunting, 2003).
Congruence	An exact copy, based on analyses of similarities and differences of item attributes: Game of Snap.
Similarity, scale, and proportion	Enlargement and contraction: Using an overhead projector or Smartboard.
Randomness	Events that cannot be predicted; effects without causes
Variability	Some days are warmer than others; some children are taller than others.
Approximation	Find some items about as long as your shoe

³⁴ If you have fewer pigeon-holes than pigeons and you put every pigeon in a pigeon-hole, then there must result at least one pigeon-hole with more than one pigeon.

Algorithm	Repetition of action sequences, such as climbing up and over a low 2-step ladder, over and over.
Conservation of quantity and number	Investigations of classic Piagetian tasks (see Piaget & Szeminska, 1960)
Infinity	Possibility of endless subdivision of a line segment (see Piaget & Inhelder, 1956; Fischbein, Tirosh, & Hess, 1979)
The counting complex	Subitising, counting-all, counting-on, skip counting (Fuson, 1988; Gelman & Gallistel, 1978; Sophian, 1987; Steffe et al., 1983)
Combinatorial thinking	If Mary has 2 different shirts and 3 different skirts, how many different outfits could she make (English, 2006)?
Trial and Error	Solving spatial puzzles and jigsaws.
Visualising	Mental re-presentation of spatial patterns, action sequences.
Imagining	Anticipation of event outcomes based on prior experiences.
Representing	Recording events graphically, tallying.
Naming	Development of a mathematics lexicon.

What Then is Big Play?

Big play is a child's self-motivated and self-directed activity that – alone or with other children – features embryonic mathematical thinking, which, in the estimation of the astute teacher or carer, may present an opportunity for conversation, discussion, a question, or just observation and recording for later investigation (Perry & Dockett, 2007). As Van Oers (1996) observed,

I draw the cautious conclusion, that play activity can be a teaching/learning situation for the enhancement of mathematical thinking in children, provided that the teacher is able to seize on the teaching opportunities in an adequate way. To what extent this approach also leads to lasting learning results in all pupils is an issue for further study (p. 71).

Final Comment

The view of some, that young children's natural propensity to play and mathematics learning are irreconcilable, is surely invalid. Young children, as do carers, live in a world of relationships. Mathematics is the science of relationships, so is inherent in play. Our challenge is to identify those play occasions where overt intervention may stimulate and extend children's mathematical thinking and problem solving skills, and to consider the nature of such interventions.

References

- Björklund, C. (2008). Toddlers' opportunities to learn mathematics. *International Journal of Early Childhood*, 40(1), 81-95.
- Bruner, J. (1986). *Actual minds: Possible worlds*. Cambridge, MA: Harvard University Press.
- Davis, G., & Hunting, R. P. (1990). Spontaneous partitioning: Pre-schoolers and discrete items. *Educational Studies in Mathematics*, 21, 367-374.
- Davis, G. E., & Pitkethly, A. (1990). Cognitive aspects of sharing. *Journal for Research in Mathematics Education*, 21(2), 145-153.

- Edo, M., Planas, N., & Badillo, E. (2009). Mathematical learning in a context of play. *European Early Childhood Education Research Journal*, 17(3), 325-341 (retrieved 31-1-2010 from <http://dx.doi.org/10.1080/13502930903101537>).
- Elstrodt, J. (2007). The Life and Work of Gustav Lejeune Dirichlet (1805–1859). *Clay Mathematics Proceedings*, 7 (retrieved 31-1-2010 from www.uni-math.gwdg.de/tschinkel/gauss-dirichlet/elstrodt-new.pdf).
- English, L. (2005). Combinatorics and the development of children's combinatorial reasoning. In G. A. Jones (Ed.), *Exploring probability in school: Challenges for teaching and learning* (pp. 121-141). New York: Springer.
- Fein, G. G. (1981). Pretend play in childhood: An integrative review. *Child Development*, 52, 1095-1118.
- Fischbein, E., Tirosh, D., & Hess, P. (1979). The intuition of infinity. *Educational Studies in Mathematics*, 10(1), 3-40.
- Fuson, K. C. (1988). *Children's counting and concepts of number*. New York: Springer-Verlag.
- Gelman, R., & Gallistel, C.R. (1978). *The child's understanding of number*. Cambridge: Harvard University Press.
- Griffith, R. (1994). Mathematics and play. In J. R. Moyles (Ed.), *The excellence of play* (pp. 143-157). Buckingham: Open University Press.
- Hunting, R. P. (2003). Part-whole number knowledge in preschool children. *Journal of Mathematical Behavior*, 22, 217-235.
- Hunting, R. P., & Davis, G. (2010). *What are the big ideas of school mathematics?* In preparation.
- Inhelder, B., & Piaget, J. (1964). *The early growth of logic in the child: Classification and seriation*. New York: Humanities Press.
- Keizer, B. A. (1983). *The role of play and direct instruction in problem solving in 3 to 5 year olds*. Masters thesis, Simon Fraser University (retrieved 4-2-2010 from <http://ir.lib.sfu.ca/bitstream/1892/7807/1/b16673219.pdf>).
- National Association for the Education of Young Children (NAEYC) and the National Council for Teachers of Mathematics (NCTM). (2002). *Early childhood mathematics: Promoting good beginnings: A joint position statement*. Reston, VA, and Washington, D.C.: Authors.
- Perry, B., & Dockett, S. (2007). *Play and mathematics*. Adelaide: Australian Association of Mathematics Teachers (retrieved 1-2-2010 from <http://www.aamt.edu.au/Documentation/Statements/Early-Childhood-Mathematics-support-paper-Play>).
- Piaget, J. (1954). *The construction of reality in the child*. New York: Basic Books.
- Piaget, J. (1962). *Play, dreams and imitation in childhood* (trans. C. Gattegno & F. M. Hodgson). London: Routledge & Kegan Paul.
- Piaget, J. (1974). *Understanding causality*. New York: W. W. Norton.
- Piaget, J., & Inhelder, B. (1956). *The child's conception of space* (trans. F. J. Langdon & J. L. Lunzer). London: Routledge and Kegan Paul.
- Piaget, J., & Szeminska, A. (1960). *The child's conception of geometry* (trans. E. A. Lunzer). New York: Basic Books.
- Schuler, J. (2001). Symmetry and young children. *Montessori Life*, 13(2), 42-48.
- Smilansky, S. (1968). *The effects of socio-dramatic play on disadvantaged preschool children*. New York: Wiley.
- Smith, P. K. (1994). Play and the uses of play. In J. R. Moyles (Ed.), *The excellence of play* (pp. 15-26). Buckingham: Open University Press.
- Sophian, C. (1987). Early developments in children's use of counting to solve quantitative problems. *Cognition and Instruction*, 4, 61-90.
- Steffe, L. P., von Glasersfeld, E., Richards, J., & Cobb, P. (1983). *Children's counting types: Theory, philosophy, and application*. New York: Praeger Scientific.
- Van Oers, B. (1994). Semiotic activity of young children in play: The construction and use of schematic representations. *European Early Childhood Education Research Journal*, 21, 19–33.
- Van Oers, B. (1996). Are you sure? Stimulating mathematical thinking during young children's play. *European Early Childhood Education Research Journal*, 41, 71–87.
- Vygotsky, L. S. (1978). *Mind in society*. Cambridge, MA: Harvard University Press.

Maths in the Kimberley Project: Evaluating the Pedagogical Model

Robyn Jorgensen (Zevenbergen)
*Nyangatjatjara Aboriginal Corporation and
Griffith University*
rjorgensen@nyangatjatjaracollege.org.au
r.jorgensen@griffith.edu.au

Peter Sullivan
Monash University
Peter.Sullivan@Education.monash.edu.au

Peter Grootenboer
Griffith University
p.grootenboer@griffith.edu.au

Richard Niesche
Griffith University
r.niesche@griffith.edu.au

The Mathematics in the Kimberley Project is a three-year research and development project that focuses on mathematical pedagogy in remote Aboriginal community schools. The research team has regularly reported on the project at MERGA conferences, and in this symposium we evaluate the pedagogical model that underpins the project. After two years of the project, the data indicate that some aspects of the pedagogical model have been successful, but other aspects have not been particularly fruitful and still require greater thought, research and development.

Paper 1: Richard Niesche, Peter Grootenboer, Robyn Jorgensen (Griffith University) and Peter Sullivan (Monash University). *The Maths in the Kimberley Project: An Overview*.

Paper 2: Peter Grootenboer (Griffith University). *Effective Features of the Maths in the Kimberley Inclusive Pedagogy Model*.

Paper 3: Robyn Jorgensen (Nyangatjatjara Aboriginal Corporation and Griffith University). *Group work, Language and Interaction: Challenges of Implementation in Aboriginal contexts*.

This project is funded by the Australian Research Council through its Linkage Grants Scheme. The Industry Partner is Association of Independent Schools of Western Australia.

The Maths in the Kimberley Project: An Overview

Richard Niesche
Griffith University
r.niesche@griffith.edu.au

Peter Grootenboer
Griffith University
p.grootenboer@griffith.edu.au

Robyn Jorgensen (Zevenbergen)
*Nyangatjatjara Aboriginal Corporation and
Griffith University*
rjorgensen@nyangatjatjaracollege.org.au
r.jorgensen@griffith.edu.au

Peter Sullivan
Monash University
Peter.Sullivan@Education.monash.edu.au

The poor mathematical achievement of remote Indigenous students continues to be a significant educational issue. The Maths in the Kimberley project seeks to implement an innovative pedagogical reform in six remote Indigenous schools to explore reforms that may lead to improved outcomes for Indigenous students in mathematics. This paper reports on the data collection phase of the project and identifies key areas of success and others of concern.

The Maths in the Kimberley project is now in its final year of implementation. This symposium paper reports on the data collected so far and provides a brief overview of the data analysis in the two following papers. The aim of the project is to trial an innovative pedagogical model in mathematics education in six remote Indigenous communities in the Kimberley region of Western Australia. The classroom teacher has been identified as the critical factor in addressing educational reforms (Boaler & Staples, 2008; Hayes, Mills, Christie & Lingard, 2006) so this project has its focus on the teaching practices in the remote schools as the basis for reforming the teaching of mathematics. The pedagogical models used are based on the work of Boaler (Boaler, 2008; Boaler & Staples, 2008), Burton (2004) and the Productive Pedagogies model developed in Queensland (Lingard et al., 2001). These models and the approach used in the Maths in the Kimberley project have been detailed elsewhere so will not be discussed here (for example, see Jorgensen, Grootenboer, Niesche, & Lerman, 2010; Jorgensen, Sullivan, Grootenboer & Niesche, 2009; Zevenbergen & Niesche, 2008).

Data Collection

Members of the research team have visited the Kimberley region regularly to provide support and professional development sessions, and to collect data. However, the great distance of the research site from the researchers meant that much of the support and data collection was also undertaken remotely. A mixed method approach was employed, but the small sample size limited the scope for quantitative analysis. Five modes of data collection were employed: (1) a questionnaire; (2) video-tapes of classroom lessons; (3) interviews with teachers and principals; (4) field notes; and (5) student testing and interviews.

The focus of this paper is the results from the lesson video tapes scored against the inclusive pedagogy model. The following papers in this symposium use the same data and also qualitative data to further discuss elements that have and have not been working from the model.

Results

The following table shows the mean scores from the classroom lesson observations.

Table 1:
Video data mean scores

Inclusive Pedagogy Dimension	2008 (n=16)	2009 (n=16)	Change 2008-2009
Higher order thinking	2.6	3.4	+0.8
Depth of knowledge	2.4	3.5	+1.1
Depth of understanding	2.3	3.4	+1.1
Substantive conversation	1.9	2.5	+0.6
Problematic knowledge	1.4	3.0	+1.6
Metalanguage	2.3	3.0	+0.7
Knowledge integration	1.3	1.6	+0.3
Background knowledge	2.3	2.9	+0.6
Problem based curriculum	2.1	3.6	+1.5
Connectedness other maths	1.4	1.3	-0.1
Connectedness other curriculum areas	1.1	1.1	0.0
Connectedness beyond school	1.4	2.8	+1.4
Student direction	1.3	1.4	+0.1
Social support	3.0	3.2	+0.2
Academic engagement	3.0	3.6	+0.6
Explicit criteria	2.7	3.1	+0.4
Student self-regulation	3.6	3.5	-0.1
Inclusivity	1.0	1.6	+0.6
Narrative	1.3	2.8	+1.5
Active citizenship	1.1	1.3	+0.2
Assessment for learning	1.9	2.8	+0.9
Multiple pathways	2.0	2.5	+0.5
Multiple entry points	1.6	1.8	+0.2
Quality interactions	2.6	2.5	-0.1
Roles defined	1.7	1.8	+0.1
Group work	2.5	2.5	0.0
Teacher as facilitator	2.4	3.0	+0.6
Use of home language	1.0	1.0	0.0
Multi-representational	2.1	2.6	+0.5
OVERALL	1.9	2.5	+0.6

These comprised of videotapes sent in by teachers and some tapes made by members of the research team while visiting schools. Lessons are scored from 1-5 based on the inclusive pedagogy model. To illustrate the scoring, a score of 1 means the pedagogical aspect was

not evident in the lesson and a 5 mean the pedagogy was a central and significant part of the lesson (for more detail see Zevenbergen, Niesche, Grootenboer, & Boaler, 2008).

To further investigate the video data, the pedagogical dimensions were categorised in two ways based on their overall mean score and how much their mean scores improved over the two years. Dimensions with a mean score greater than 2.8 were noted as relatively high, and those with a mean score less than 1.8 were noted as relatively low. A score above 2.8 indicates that the pedagogical dimension was fairly regularly a significant part of the lesson, and a score below 1.8 means the dimensions was rarely observed and/or not a significant feature of the teaching. If the mean score for a pedagogical dimension increased by 0.9 or more over the two years, then it was categorised as 'improving', and if it increased by less than 0.2 then it was noted as 'not improving' (see Table 1). The results of this data analysis are shown in Figure 1 below:

Summary

The data represented in Table 1 and the analysis in Figure 1 indicate that there are aspects of the model that have been readily adopted by the teachers as well as some elements that have not been taken up. The research team were pleased to see that the intellectual quality dimensions scored highly and also improved over time. However, of significant concern are the group work and use of home language elements that scored low on the scale as well as not improving. One of the aspects that has been emphasised by the research team was the notion of group work. As is discussed in the following symposium paper, this element has particular contextual and cultural issues that may need further examination. The use of home language in the classroom also warrants further exploration as a number of teachers have remarked that the students are already using their home language in the class. The inclusive pedagogy model used in this project involves the students reporting back to the class their findings and this is done in Standard Australian English. The teachers have been encouraged to explicitly allow the students to discuss the mathematical reasoning in their home language but this has met with resistance from some teachers. While elements of this model have proved successful in other contexts, there are clearly spaces for re-examination of the model in this remote Indigenous context.

References

- Boaler, J. (2008). Promoting 'relational equity' and high mathematics achievement through an innovative mixed ability approach. *British Educational Research Journal*, 34(2), 167-194.
- Boaler, J. & Staples, M. (2008). Creating mathematical futures through an equitable teaching approach: The case of Railside school. *Teachers College Record*, 110(3), 608-645.
- Burton, L. (2004). *Mathematicians as enquirers*. Dordrecht: Springer.
- Hayes, D., Mills, M., Christie, P., & Lingard, B. (2006). *Teachers and schooling making a difference: Productive pedagogies, assessment and performance*. Crows Nest, NSW: Allen & Unwin.
- Lingard, R., Ladwig, J., Mills, M., Bahr, M., Chant, D., Warry, M., et al. (2001). *The Queensland school reform longitudinal study*. Brisbane: Education Queensland.
- Jorgensen, R., Grootenboer, P., Niesche, R. & Lerman, S. (2010, In Press). Challenges for teacher education: The mismatch between beliefs and practices in remote Indigenous contexts. *Asia Pacific Journal of Teacher Education*.
- Zevenbergen, R. & Niesche, R. (2008). *Reforming mathematics classrooms: A case of remote Indigenous education*. Working Paper No. 2, Griffith Institute for Educational Research, Griffith University.

- Zevenbergen, R., Niesche, R., Grootenboer, P., & Boaler, J. (2008). *Creating equitable practice in diverse classrooms: Developing a tool to evaluate pedagogy*. In M. Goos, R. Brown & K. Makar (Eds) *Navigating currents and charting directions*, (Proceedings of the 31st Annual Conference of the Mathematics Education Group of Australasia.) Brisbane: MERGA.
- Jorgensen, R., Sullivan, P., Grootenboer, P. & Niesche, R. (2009). Reforming mathematical pedagogy in remote Indigenous contexts, Symposium. In R. Hunter, B. Bicknell, & T. Burgess (Eds.), *Crossing divides* (Proceedings of the 32nd annual conference of the Mathematics Education Research Group of Australasia, Wellington, NZ, Vol. 2, pp. 692-707). Palmerston North, NZ: MERGA.

Effective Features of the Maths in the Kimberley Inclusive Pedagogy Model

Peter Grootenboer
Griffith University
<p.grootenboer@griffith.edu.au>

The Maths in the Kimberley (MitK) project has been progressing for two years and so it was timely to evaluate the Inclusive Pedagogy model that underpinned the study. The data presented in the first paper in this symposium indicated that some aspects of the model worked well. Primarily the areas of improvement were related to the intellectual quality of the lessons. These pedagogical dimensions are outlined and discussed here by drawing on the broader data set of the project.

Sullivan and Niesche presented an analysis of the lesson-video data earlier in this symposium, and the results indicated that some of the pedagogical dimensions of the Inclusive Pedagogy model worked well. These were aspects of the new approach to mathematics that were readily adopted by the teachers and seemed to be effective with the learners in the participating schools. In general, these aspects related to the intellectual quality of the lessons and features of the learning environment.

In this paper I will outline and discuss the aspects of the model that improved over the first two years of the project. These are generally in the upper right-hand section of Figure 1 (Niesche, Grootenboer, Jorgensen & Sullivan, this symposium).

Intellectual Quality

The analysis of the video-taped lessons indicated that pedagogical aspects related to the intellectual quality of the classes (e.g., *higher order thinking, problem-based curriculum*) were scored relatively highly. Furthermore, the mean scores for these dimensions increased as the project progressed. This indicated that in the lesson reviewed the pedagogy was characterised by intellectual quality and high expectations, and, these qualities were more evident and in increasing depth as the project progressed. Apart from the lesson video data, these features have also been observed by the research team in the course of their visits to the classrooms during the first two years of the study. At the start of the project the mathematics lessons were largely characterised by rote learning and regular ‘drill and practice’. However, towards the end of 2009 (the second year of the project), the teachers employed more tasks that are rich and relatively complex.

For example, in the first year of the project one of the teachers video-taped one of his mathematics lesson and sent it into the research team for analysis. The lesson he sent in involved a hangman-type game where the students were trying to guess the teacher’s “secret number”. This lesson was entirely teacher-centred and it predominately involved a sequence of low-order questions that required very little mathematics. However, towards the end of the second year of the project, the same teacher submitted another video-taped lesson that involved a relatively open-ended task that required the students to think mathematically about a practical local situation.

This change in the teachers’ mathematical pedagogy has been significant and often difficult. It appears that they are developing a perspective that sees the students as capable of learning complex mathematics with appropriate scaffolding. In the project there has been an emphasis on scaffolding the teachers and providing rich mathematical tasks that

have high intellectual quality in the professional development part of the project. This has led to a shift in the teachers' views of their learners from deficit, low level thinking to a perspective that sees their students as capable and confident. Early in the project a number of the participating teachers commented on the "students' deficiencies" that "stop them from learning maths", whereas, in later conversations and interviews they made more comments like:

... there is no reason why they [their students] couldn't do things like that. Every other school can do it and other kids can do it. Sometimes I have thought that there is too much of a feeling or reliance on the fact that there's these great cultural differences that make things difficult. I am sort of a strong believer that these things that whilst there are these differences, there's no reason why they can't do these things.

It has been an important and positive outcome for the MitK project that the teachers seem to view the students in their classrooms as competent and capable learners of mathematics. Hayes, Mills, Christie and Lingard (2006) confirmed the critical importance of high academic expectations for all learners so educational outcomes are good and equitable can be achieved. To this end, the improvement in the intellectual quality of the video-taped lessons has been an endorsement of the 'inclusive pedagogy' model. This has been particularly pleasing because mathematics is the subject where the content can often be reduced to the memorisation of basic facts and algorithmic efficiency.

Significant Mathematical Content

A major issue facing the project team is the relatively weak mathematical identities (personal knowledge, skills and attitudes) of many of the participating teachers. Most of the participants involved with the project are primary teachers, and in the schools where there is a secondary class, the teachers (who teach all subjects) are not mathematics specialists.

For me I've always just struggled with mathematics. So I always find it a tough gig myself. I guess there have been some PDs that we've done ... and it was only this time that I am starting to understand it.

Therefore, it is fair to say that the teachers as a group have fairly limited mathematical knowledge and understanding, and generally it would not be their favourite subject. Of course, this is not peculiar to remote Aboriginal schools. An important aim of this project has been to enhance the quality and depth of the mathematical content in the teachers' mathematics lessons. The data from the video-taped lessons, and the other sources, show that there have been distinct improvements in the mathematical integrity of the lessons being presented in the classrooms of these remote Aboriginal community schools. To illustrate, the video-taped lesson data (see Niesche, et al., this symposium) revealed an increase in the quantity and quality of pedagogy that had *connections beyond the school* (mean score of 1.4 in 2008, mean score of 2.8 in 2009), *depth of knowledge* (2.4 to 3.5), and *depth of understanding* (2.3 to 3.4).

In the project the teachers have been encouraged to use rich mathematical tasks that have strong academic quality and that facilitate deep mathematical learning (Grootenboer, 2009). For this to occur, the lessons needed to have opportunities for students to engage in the activities and practices of mathematicians such as hypothesising, making conjectures, rationalising, and justifying ideas and findings (Burton, 2004).

To illustrate, late in the second year of the project a lesson with a Year 2/3 class was observed where the focus was on number patterns – in particular multiples of 5. After an

introduction using a 1-100 number board and open questions about “any patterns they could see”, the teacher went on and posed the question, “how many fingers are in our school today?”. The students were placed in groups and together they developed at least one strategy to solve the problem. After briefly sharing and discussing their strategies, they then visited the other classes to gather their data. On their return, they worked in their groups using “any equipment they needed” to work out their solution and then prepare a presentation for the class. Throughout the lesson the teacher rarely gave direct answers, but she often asked questions that encouraged the students to think mathematically and more deeply about their work.

In the example above, the teacher facilitated forms of mathematical thinking that involved more than memorisation and recall. By employing such an approach, Boaler and Staples (2008) found in their *Railside* study, that students “regarded mathematical success much more broadly” (p. 629), and they performed well in the standard assessments. At this stage there is evidence (somewhat anecdotal) that the students are showing similar gains, and despite many confounding factors, there is an expectation that the results of their external testing (e.g., NAPLAN) will reveal markedly better results.

As the teachers developed the substantive mathematical content of their pedagogy, there was also a more focussed consideration of the broader mathematical identities of the students. In their lessons the participating teachers more regularly tried to consider and address the students’ mathematical attitudes and beliefs, and their emotional responses to the subject. This was evident in many overt and subtle ways in the lessons video-taped and observed. One teacher tried to provide a pertinent and connected context for the students by employing the idea of a ‘story shell’:

The story shell, that’s my...yeah relating the mathematics to life through the story shell so that we can provide a context, I really put a lot of effort, that’s one of my main focuses, and it’s really worked cause I enjoy telling stories. And that’s something that I’ve put a greater focus on. I used to do it every now and then, whereas now I try and do it each and every maths lesson, each thing they’re attempting has got some sort of context that the students can relate to.

Assessment for Learning

Another pedagogical aspect that appeared to improve throughout the project was the teachers’ use of *assessment for learning*. Again, this is evident in the data from the analysis of the video lessons where the mean score rose from 1.9 in the first year to 2.8 in the second year (see Niesche, et al., this symposium). This indicated that the teachers have moved from relying primarily on low level assessment techniques to introducing some assessing of higher order mathematical thinking. A number of the teachers have commented that thoughtful questions judiciously used throughout their mathematics lessons have been powerful in accessing their students’ knowledge, ideas and understandings. This enabled them to then pose further questions to facilitate the students’ mathematical learning and growth.

Recently, one-on-one diagnostic interviews have been undertaken with many of the students, so the teachers can prepare and teach their mathematics lessons more cognisant of their students’ capabilities. One of the new teachers (commenced in 2009) commented;

... doing the student interviews has been really useful. Useful for me to find out where the kids are actually at, because I felt like I’ve spent a term kind of going, ‘oh my God, what is going on here, where is everyone at, how do I cater for that?’ But with the individual interviews, you can systematically really find out, and then build on that.

Overall, there has been a notable increase in the use of assessment to understand what students do know and can do, rather than what they do not know and cannot do, and this has led to improved pedagogy.

The Learning Environment

It is worth noting that throughout the project the data have indicated that the teachers are generally providing a learning environment that is supportive and regularly characterised by quality interactions between the teacher and the students. However, this cannot be necessarily attributed to the interventions of the project because there have been no notable increases in the data related to these pedagogical features over the initial two years (e.g., the *social support* mean score went from 3.0 in 2008 to 3.2 in late 2009). Nevertheless, this also indicated that while the teachers have been able to improve intellectual quality of their lessons and increase the significant mathematical content, they have also been able to maintain a supportive learning environment.

Concluding Comments

The implementation of the Inclusive Pedagogy model in the remote Aboriginal schools of the Kimberley region was in many respects a major intervention. It required the teachers to reconceptualise their mathematical pedagogy while dealing with many professional and personal issues that arise for the generally young and inexperienced teachers in these schools. Furthermore, the model was developed from the findings of studies conducted in quite different contexts, and while it was based on sound practice and substantial research, there were no guarantees that it would be appropriate or effective in the context of very remote Aboriginal schools. The evaluation of the model after two years indicates that a number of the dimensions of the model are working well and are effective for these particular teachers and learners. Indeed, as the model is now being revised, these features relating to intellectual and academic quality will be reiterated and reinforced in order to facilitate increasingly improved educational outcomes for these disadvantaged learners.

References

- Boaler, J., & Staples, M. (2008). Creating mathematical futures through an equitable teaching approach: the case of Railside School. *Teachers College Record*, 110(3), 608-645.
- Burton, L. (2004). *Mathematicians as enquirers*: Dordrecht: Springer.
- Grootenboer, P. (2009). Rich mathematical tasks in the *Maths in the Kimberley* (MITK) Project. In R. Hunter, B. Bicknell, & T. Burgess (Eds.), *Crossing divides* (Proceedings of the 32nd annual conference of the Mathematics Education Research Group of Australasia, Wellington, NZ, Vol. 2, pp. 696-699). Palmerston North, NZ: MERGA.
- Hayes, D., Mills, M. Christie, P., & Lingard, B. (2006). *Teachers and schooling: Making a difference*. Crows Nest, NSW: Allen and Unwin.

Group work, Language and Interaction: Challenges of Implementation in Aboriginal contexts

Robyn Jorgensen (Zevenbergen)

Nyangatjatjara Aboriginal Corporation *Griffith University*
<rjorgensen@nyangatjatjaracollege.org.au> <r.jorgensen@griffith.edu.au>

While research suggests that the use of group work can enhance student learning, there are considerable challenges to implementing this practice in remote Aboriginal communities. When employed properly, group work requires students participate in deep dialogue and/or shared tasks that build collaborative interactions that help facilitate deeper mathematical understandings. However, we have found in the Maths in the Kimberley (MitK) project, that developing and implementing group work in this context is highly problematic. Practically, linguistically and culturally, teachers were confronted with considerable obstacles to implementation, and these issues are discussed in this paper.

The underperformance of Aboriginal Australians is a recognised problem in education. This concern arises from NAPLAN tests for all year levels that show alarmingly poor performances for remote Aboriginal students (MCEECDYA, 2009). This cohort of students is the most at risk group of students in the educational landscape. In the Maths in the Kimberley (MitK) project, the overarching aim was to implement reform pedagogies that would support the development of rich learning environments in mathematics teaching and learning. The express goal of the project was to enhance numeracy learning for the students in the communities. While, as has been discussed earlier in this symposium, there have been some successes with the project, there have been other aspects of the pedagogy where there have been no observable or significant changes in practice (see Table 1 in Niesche, Grootenboer, Jorgensen & Sullivan, this symposium). In this paper these pedagogical aspects are outlined, and I discuss some of the significant barriers to pedagogical reform in remote Aboriginal communities and raise ethical questions as to whether mainstream pedagogy can/should be implemented in Aboriginal communities where the cultural differences are great and may be very different from those of mainstream Australia.

Background

In the MitK project we have drawn on a particular corpus of pedagogical reform that has been proven to be very effective in other disadvantaged contexts. For example, the work of Boaler (2008) has shown how particular pedagogical practices – in her case, Complex Instruction (Cohen & Latan, 1997) – had enhanced the learning of some of the most challenging communities in California. We have drawn on this work, along with the work of Productive Pedagogies (Lingard, 2006) recognising that this is also being challenged and moved forward (Mills et al., 2009) to exemplify and create quality learning environments.

The research team developed a pedagogical model that included critical variables for enhancing educational outcomes, but not all of these have been simple or immediately successful in this context. The problematic embedding of these aspects of pedagogy have created a deep challenges for the research team – in terms of trying to embed the practices in the communities as well as ethical dilemmas for the research team. In this paper, I draw attention to the group learning aspect of the approach in the project. This draws on the

work of Boaler's complex instruction (Boaler, 2006) where group work was a strong feature, and the work of Cobb and colleagues (Yackel, Cobb, & Wood, 1991) where interactions in quality group work yielded strong mathematical learning. The assumption in these projects is that group work, when properly conducted, and where students engage in rich learning tasks, produces opportunities for rich and deep learning in mathematics. It would appear from Boaler's (2008) work that this approach also has significant other language and social learnings that are valuable for students from linguistically and culturally diverse backgrounds as they transition from their home culture into school/mainstream culture. As this research has produced significant learning for students, it has been adopted in the MitK Project.

In our project, we have sought to have teachers work with students in small groups where they can negotiate meaning in their home language (Kriol) on the premise that this will reduce cognitive load, enable deeper engagement from students both socially and cognitively, and will help them in the development of deep mathematical understandings. We also adopted Cohen and Latan's (1997) principle of reporting back on the guise that students could negotiate meaning in their home language but being proficient in English required fluency in that language but also in the social practices (in this case, reporting to peers in a full classroom context). For students whose lives are centred in remote communities but their long term career and social good requires that they are proficient in Standard Australian English, adopting practices such as reporting back helps to transition into mainstream English with its linguistic nuances of social interactions.

Dilemmas of Pedagogical Reform in Remote Aboriginal Contexts.

The research team have found that the most challenging aspects of the inclusive pedagogies relate to those areas where language is central – group work, high interactivity and reporting back. These elements have been problematic for teachers and stem mainly from differences in the culture of the students and the culture of school mathematics. The scores on these elements have remained constant in the project, suggesting no gain. We have sought the input from teachers to help us understand the difficulties around these pedagogies. Teachers have reported that the culture of the Kimberley communities is still strong and as such there are many cultural norms that are violated with the use of these pedagogies.

Group Work

Kimberley Aboriginal kinship relationships require that some students may not be able to speak or work with other students due to particular 'skin' groupings. These cultural norms are very strong. In classrooms, this means that grouping these students is not possible. Further, in those smaller communities, there are some classrooms where the numbers are so small that arranging groups where the students could be put into non-skin groups is not possible. In these small classrooms, it was also the case that the whole class may be from the one family and hence, reluctant to work with older/younger siblings. The dilemma for us is that group work has been shown to be a powerful tool to enhance learning yet in this context, the violation of cultural norms is so strong, that it may not be a useful tool for learning.

The reporting back process was also problematic due to the cultural norms around 'showing off'. In the Kimberley culture, teachers reported that showing off how much someone knew (or did not know) was a 'shame job'. The notion is 'shame' is very strong

in this region so asking students to publicly show their knowledge was not appropriate. For example, in some cases, a younger person may know something that an older student did not know. Teachers reported that this process was a 'shame job' for the older student so that younger students were reluctant to publicly put down the older student. The dilemma for the research team is that the concept of 'shame' is a very powerful one in Aboriginal cultures so there would need to be considerable renegotiation of classroom protocols if this pedagogy were to be developed more.

Related to both of these pedagogies is that of high interactivity. The teachers would pose questions to create high interactivity but the social norms of the Aboriginal students in a mainstream classroom limited this potential. The students were all very keen to answer the questions posed by the teachers but part of the role of young people in these communities is to please others. The game that was enacted during questions is that the students must guess what the teachers wanted. What appears to happen is that once a question is posed, if the teacher does not respond with a 'correct' then the students engage in a guessing game where all sorts of responses are offered. For example, in one lesson the teacher asked a question – "what happens when I add 5 and 3?" The students offered a wide range of responses – including "8" but when this (along with the other responses) were not indicated as being correct, they kept calling out numbers. This pattern of interaction was observed across all schools and all classrooms. Interviews with teachers confirmed that this was common practice in all schools. While teachers reported their frustration with the game, they were unable to change this dynamic despite concerted attempts to do so. Further interviews with Aboriginal adults indicated that this was a part of the culture where young people learn that it is always good to please elders by being compliant, and that, in this case, compliance would be engaging in the question/answer interaction. They suggested that for the students, they would see the questions are requiring a response and hence this would be the 'game' rather than replying with the mathematically correct answer.

These challenges to the inclusive pedagogy model need to be considered carefully in terms of both pedagogy and ethics. While there is a substantial literature that suggests that such practices may enhance learning, this study has been conducted in schools that are Western/modern in their approach. The contexts for remote Aboriginal communities are substantially different in terms of cultural norms.

Use of Home Language

In observing the groups working, or students seated as a whole group on the mats in front of teachers, it was clear that there was considerable use of Kriol, including instructions from the Aboriginal Education Workers (AEW). However, the interactions were either social or disciplinary (from the AEW) and were not related to the development of mathematical concepts. In discussing this with teachers (individually, in professional development forums and in focus groups), teachers raised concerns about not knowing what the students were talking about and whether they would remain on task. We have observed that there is a sense of loss of control among teachers if they wanted to encourage the use of home language. While originally, the research team felt that 'loss of control' was not a good reason for absolving the use of home language, as we have progressed further into the project, we have come to understand the complexities of working in remote communities and the quickness with which the tenor of a classroom can change. There is a volatility that is not common in mainstream settings. Hence, the teachers feel a stronger need to remain in control of lessons so that if there are community issues that flow over

into the classroom, the teachers are able to remain in control. For example, in communities there is often friction between family groups. If an incident occurs in community, then this can flow over into the classroom. Often taunting and teasing is evidence of this flow over. Where the possibility arises for students to engage in home language and this taunting may continue unbeknown to the teachers, there was a concern that the issue can escalate quickly into quite a large fight. As such, teachers felt a strong need to keep a tighter rein on interactions than they would if the communications could be understood by the teachers.

Summary

The research team now need to confront some of the original assumptions that were made at the commencement of the project around good mathematical pedagogy. We face the dilemma where research indicates that some practices have significant learning benefits but when such practices are placed in remote Aboriginal contexts, there are different challenges, circumstances, beliefs and social practices. For us, questions arise as to whether practices, such as group work, may be the domain of Western/modern education and are not culturally appropriate for these contexts. We have to consider whether the adoption of group work and other elements of the reform pedagogy are in violation of cultural norms and hence unacceptable in these contexts, or whether depriving the students of these experiences places them at further educational risk. Similarly, we must contend with issues around teacher professional learning because the turnover of teachers is very high (very few stay beyond 2 years). How then, is it possible to develop sustainable practices that require significant support when there is a continual change of teachers?

What we can conclude is that the changes needed to Indigenous education are profound and urgent. However, such changes must be considered in light of the needs and cultures of the people with whom we, as researchers and educators, work. These people are not only the teachers but also the communities. This requires further work in Indigenous education research.

References

- Boaler, J. (2006). Promoting respectful learning. *Educational Leadership*, 63(5), 74-78.
- Boaler, J. (2008). Promoting 'relational equity' and high mathematics achievement through an innovative mixed ability approach. *British Educational Research Journal*, 34(2), 167-194.
- Cohen, E., & Latan, R. (Eds.). (1997). *Working for equity in heterogeneous classrooms: Sociological theory in practice*. New York: Teachers College Press.
- Lingard, B., Mills, M., & Hayes, D. (2006). Enabling and aligning assessment for learning: Some research and policy lessons from Queensland. *International Studies in Sociology of Education*, 16(2), 83-103.
- MCEECDYA. (2009). *National report: Achievement in reading, writing, language conventions and numeracy 2009*. Canberra: Australian Government.
- Mills, M., Goos, M., Keddie, A., Honan, E., Pendergast, D., Gilbert, R., et al. (2009). Productive pedagogies: A redefined methodology for analysing quality teacher interaction. *The Australian Educational Researcher*, 36(3), 67-87.
- Yackel, E., Cobb, P., & Wood, T. (1991). Small group interactions as a source of learning opportunity in second grade mathematics. *Journal for Research in Mathematics Education*, 22, 390-408.

Problem Solving in the School Curriculum from a Design Perspective

Toh Tin Lam (Chair)

Nanyang Technological University

<tinlam.toh@nie.edu.sg>

Leong, Yew Hoong

Nanyang Technological University

<yewhoong.leong@nie.edu.sg>

Jaguthsing Dindyal

Nanyang Technological University

<jaguthsing.dindyal@nie.edu.sg>

Quek, Khiok Seng

Nanyang Technological University

<khiokseng.quek@nie.edu.sg>

In this symposium, we discuss some preliminary data collected from our problem solving project which uses a design experiment approach. Our approach to problem solving in the school curriculum is in tandem with what Schoenfeld (2007) claimed: “Crafting instruction that would make a wide range of problem-solving strategies accessible to students would be a very valuable contribution ... This is an engineering task rather than a conceptual one” (p. 541). In the first paper, we look at how two teachers on this project taught problem solving. As good problems are key to the successful implementation of our project, in the second paper, we focus on some of the problems that were used in the project and discuss the views of the participating students on these problems. The third paper shows how an initially selected problem led to a substitute problem to meet our design criteria.

Paper 1: Leong Yew Hoong; Toh Tin Lam; Quek Khiok Seng; Jaguthsing Dindyal; Tay Eng Guan; Lou Sieu Tee; Nanyang Technological University. *Enacting a problem solving curriculum.*

Paper 2: Jaguthsing Dindyal; Quek Khiok Seng; Leong Yew Hoong; Toh Tin Lam; Tay Eng Guan and Lou Sieu Tee; Nanyang Technological University. *Problems for a problem solving curriculum.*

Paper 3: Quek Khiok Seng; Toh Tin Lam; Jaguthsing Dindyal; Leong Yew Hoong and Tay Eng Guan and Lou Sieu Tee; Nanyang Technological University. *Resources for teaching problem solving: A problem to discuss.*

Enacting a Problem Solving Curriculum

Leong, Yew Hoong

Nanyang Technological University
<yewhoong.leong@nie.edu.sg>

Quek, Khiok Seng

Nanyang Technological University
<khiokseng.quek@nie.edu.sg>

Tay, Eng Guan

Nanyang Technological University
<engguan.tay@nie.edu.sg>

Toh, Tin Lam

Nanyang Technological University
<tinlam.toh@nie.edu.sg>

Jaguthsing Dindyal

Nanyang Technological University
<jaguthsing.dindyal@nie.edu.sg>

Lou Sieu Tee

Nanyang Technological University
<sieutee.lou@nie.edu.sg>

In preparing teachers to enact a problem solving curriculum, the first two phases of professional development involve teachers attending sessions about problem solving and observing the teaching of problem solving to students. In this paper, we focus on the third phase: these teachers carry out the problem solving curriculum in their classes. We discuss how two teachers apply problem solving processes in their instructional practices.

In the research reported in this paper, we focused on implementing problem solving in a way that is in line with the Singapore mathematics curriculum (Ministry of Education/University of Cambridge Local Examination Syndicate, 2007). We wanted to elevate the position of problem solving from that of ‘occasional visitor’ to that of ‘regular mainstay in usual mathematics classrooms’. This is, however, not a straightforward enterprise. One of the key challenges was to prepare teachers for this shift of emphasis in their teaching. In this paper, we examine how the teachers who had undergone the teacher development programme carried out the problem solving curriculum in their classes.

Background

The study reported here is part of a project known as M-ProSE – Mathematical Problem Solving for Everyone. The school we worked with is an independent Secondary school in Singapore. We have just completed three phases in the teacher preparation programme: (1) Sessions with teachers that were focused on teaching problem solving processes to teachers; (2) sessions with students (in an elective module) that were focused on demonstrating to teachers ways to introduce to students problem solving processes; and (3) observation of the teachers as they conduct the problem solving lessons, with a view to discuss changes for future implementations. Later phases will involve working alongside the teachers to infuse the problem solving approach across the broader curriculum.

In the first phase, one of the authors – hereafter known as the trainer – used problems as examples to help develop teachers’ problem solving habits within Pólya’s (1954) stages – Understanding the problem; Devise a plan; Carry out the plan; Check and Extend – while being aware of the influence of Schoenfeld’s (1985) components of problem solving, which include Resources, Heuristics, Control, and Beliefs. In the second phase, he taught twenty-one Year 9 students who signed up for the (elective) course over ten lessons, each lasting one hour. The essential contents of the student module – the problems solved and the processes highlighted – were similar to the teacher module, but the pace, tone, and issues raised for discussion were adjusted to suit the needs of the students. We held post-lesson meetings with the teachers to discuss the lessons at regular junctures to gather ideas

for improvement as well as clarify the instructional practices that were demonstrated. A more detailed report on the teacher preparation programme over the two phases is found in Leong, Toh, Quek, Dindyal, and Tay (2009).

In this paper, we focus on the third phase of the project where the teachers moved from the classroom where they *learn* about problem solving to the classroom where they *teach* problem solving. In Phase three, the school decided to offer the problem solving course as a compulsory module for the entire Year 8 cohort of the school, totalling 164 students. Three teachers were selected to teach the module. Due to the school’s staffing constraints, only two of the three teachers — Raymond and William — attended the professional development programme over the two phases. There were also time constraints; instead of a module comprising ten one-hour sessions that we proposed, the school decided to cut it down to an eight one-hour introductory lessons on problem solving.

Data and Analysis

As the aim of this study was to examine how the teachers who have undergone the two phases of teacher development actually carried out the teaching of problem solving, the main source of data was derived from the classroom activities of Raymond and William. Video recordings and transcripts of these teachers’ actions and instructions were used.

The focus of analysis is on how the teachers used each problem to help develop the students’ problem solving abilities along the lines of Pólya’s stages. For this paper, we have space only to report the analysis of how the teachers taught one particular problem — known by the team as the “sum of digits” problem:

Find the sum of all the digits of the numbers in the sequence 1, 2, 3, ..., 9999.

Teacher Raymond

Raymond used a large chunk of Lesson 1 and some parts of Lesson 2 to cover the sum of digits problem. After introducing the problem, Raymond asked the students to work on the problem in pairs for 20 minutes. During that time, he walked around from pair to pair to monitor their work and to prompt the students towards productive directions. What was conspicuous in his teacher-pair conversations was his reluctance to provide students with answers they were looking for; instead, he asked questions that directed students’ attention towards the process of problem solving. In particular, his prompts can be interpreted as an informal first introduction of Pólya’s stages and heuristics to the students. Table 1 shows a sample of the language he used and the associated Pólya’s processes that we interpret as implicitly intended.

Table 1:

Sample of Raymond’s Prompts when Interacting with Student Pairs

Raymond’s language	Pólya’s processes
“I suggest you read the question more carefully ...”	Understand the Problem
“What are you trying to do from this step here?”	Devise a Plan
“Maybe you want to draw something to help you visualise it better?”	Heuristics
“How can you be sure that your solution is correct?”	Look Back – check
“Do you think you can find the general form for this kind of question? Let’s say I don’t add 1 to 9999, I add 1 to 99999 ...”	Look Back – extend the problem

Raymond then used a whole-class instructional setting to formally introduce Pólya’s stages in relation to the problem as well as to the attempts of the students at solving the

problem that he observed. The presentation of a tight-linkage between Pólya’s stages, the problem, and the students’ Polya stages-like attempts is shown with some samples of Raymond’s talk in Table 2. Under “Carry out the Plan”, Raymond actually presented the solution by progressively enlarging the initial small problem: 1 to 9, 1 to 99, 1 to 999, then finally 1 to 9999. The entire segment of this part of the lesson lasted 41 minutes, with the bulk of the time spent in “Carry out the Plan” (26 minutes) and “Look Back” (9 minutes).

Table 2:

Raymond’s Formal Introduction of Pólya’s Processes in a Whole Class Setting

Pólya’s processes made explicit	Relating to the problem	Relating to students’ earlier attempts
“Let me first talk about the first step ... Understanding the Problem”.	“So you just sum up 1 to 9999 ...”	“I noticed some of you finished quite quickly ... [But] actually the question asks you to sum the digits of the numbers, not the numbers themselves.”
“The next thing I want to talk about is Devise a Plan”.	“I’ll work on a smaller problem. ... the simplest problem we can try to solve ... we first try sum the digit of 1 to 9 instead ...”	“I looked around. Some of you have devised some plans. One of the plan[s] I looked at is to identify a pattern.”
“OK so now we Carry out the Plan to work on the smaller problem.”	“This one should be 45. ... So the second smaller problem will be ... 1, 2 to all the way to 99.”	“... which is quite a number of you did. ... Some of you actually added wrongly but it’s OK. Don’t worry.”
“OK, however, do you want to stop here? ... We need to Look Back at our solutions. Let’s look at the fourth stage ...”	“OK, instead of just solving from 1 to 9999, we try to solve from 1 to whatever numbers of 9 ...”	“OK [student] June can see the pattern $45 \times 10 \times 10$ to the power of n minus 1 ...”

Raymond rounded up the discussion on the sum of digits problem by once again explicating Pólya’s four stages — this time with particular emphases that the stages need not be one-directional and that Stage 4 is something that students were not used to but was worth working on:

And sometimes when you carry out the problem you realise, “Hey, I’m not solving the problem, it doesn’t help.” So what you should do is, right, you will cycle back to understand the problem again, ok?

When the problem is solved already ... we have to look back the solution ... and try to look for a deeper understanding of this problem, alright? And hopefully, we can find a general solution, ok?

Teacher William

William used largely the same sequence of instruction as Raymond with the sum of digits problem. The difference in time allocation was most conspicuous in the first segment where William provided considerably less time for students to attack the problem on their own; instead, he allowed students to work on part of the problem *after* he set up the overall solution strategy. Table 3 shows the time allocation comparisons between Raymond and William across the lesson components. During the initial segment where students attempted to solve the problem, compared to Raymond (see Table 1), William’s language – perhaps due to the lack of time – appeared to be more narrowly focused on ‘Understanding the Problem’ and getting the answers.

Table 3

Instructional Components and Time Allocations between Raymond and William

	Raymond	William
Students attempt to solve the problem	20 min	6 min
Teacher explicates Pólya's stages up to Stage 3: 1-99	12 min	12 min
Students work on remainder of "Carry Out the Plan"	Not done	4 min
Teacher completes "Carry Out the Plan"	20 min	27 min
Teacher introduces Stage 4	9 min	Not done
Teacher reviews Pólya's stages	5 min	Not done
Total time	66 min	49 min

William then proceeded to explicate Pólya's stages up to "Carry out the Plan". Like Raymond, he started from the smaller problem of 1-9 and went on to 1-99. Having demonstrated the strategy, he instructed the students to try "1-999" on their own before completing Stage 3 as whole-class demonstration. However, unlike Raymond, he left out Stage 4 and the segment on the review of Pólya's stages (see Table 3).

Discussion

From the point of view of teacher development for teaching problem solving, we take encouragement from the data that both Raymond and William clearly built in the Pólya's stages into their classroom instruction. In fact, the strong similarity in their overall approaches may indicate they had prior discussions on how to proceed with the problem in class and hence implies some deliberate 'buy-in' into the problem solving processes.

A preliminary broad-grained analysis admittedly does not do justice to the complexity of their classroom practices. Nevertheless, the data as presented in Tables 1-3 suggests that Raymond and William applied Pólya's stages to classroom-use quite differently. In brief, Raymond seemed to want students to actively own the problem and to focus on their own problem solving processes before offering them Pólya's stages and heuristics as a way to help them get 'unstuck'. He also emphasised the importance of going beyond the given problem (Look Back). In contrast, William appeared to be cautious about letting students work independently on the problem initially, preferring instead to provide the first steps towards the solution and asking students to follow along the same vein. Also, he focused more on answer-getting and did not introduce Pólya's Stage 4.

Seen through the lens of their pedagogical inclinations, William appears to prefer a more conservative approach of 'teacher demonstrate, student follow'. Pólya's stages were employed merely as add-ons to his instructional tool-set to fit into his existing instructional approach. As for Raymond, we are perhaps seeing the beginnings of the problem-solving approach having transformative effect in his way of teaching mathematics. The next phase of the teacher development programme and research should thus zoom-in on the causes of William's reservations and Raymond's openness.

References

- Pólya, G. (1954). *How to solve it*. Princeton: Princeton University Press.
- Leong, Y. H., Toh, T. L., Quek, K. S., Dindyal, J., & Tay, E. G. (2009). Teacher preparation for a problem solving curriculum. In R. Hunter, B. Bicknell, & T. Burgess (Eds.), *Crossing divides: Proceedings of MERGA 32 (Vol. 2, pp. 691-694)*. Palmerston North, New Zealand: MERGA.
- Ministry of Education/University of Cambridge Local Examinations Syndicate. (2007). *Mathematics syllabus*. Singapore: Author.
- Schoenfeld, A. (1985). *Mathematical problem solving*. Orlando, FL: Academic Press.

Problems for a Problem Solving Curriculum

Jaguthsing Dindyal

Nanyang Technological University
<jaguthsing.dindyal@nie.edu.sg>

Leong, Yew Hoong

Nanyang Technological University
<yewhoong.leong@nie.edu.sg>

Tay, Eng Guan

Nanyang Technological University
<engguan.tay@nie.edu.sg>

Quek, Khiok Seng

Nanyang Technological University
<khiokseng.quek@nie.edu.sg>

Toh, Tin Lam

Nanyang Technological University
<tinlam.toh@nie.edu.sg>

Lou, Sieu Tee

Nanyang Technological University
<sieutee.lou@nie.edu.sg>

In this paper we highlight some of the problems that we used in our problem solving project. Particularly, we focus on the problems that students liked or disliked the most and look at some of their solutions to these problems.

The successful implementation of any problem solving curriculum hinges on the choice of *appropriate problems*. However, appropriate problems may have different connotations for different people. In the context of our problem solving project, we have used some problems on which we have collected some data from the students solving these problems. We hereby report, what the students perceived as the most important and least important problems and discuss some of their solutions to these problems. Due to space constraints only a few responses will be highlighted.

The nurturing of problem solving skills requires students to solve meaningful problems. Lester (1983) claimed that posing the cleverest problems is not productive if students are not interested or willing to attempt to solve them. The implication is that mathematical problems have to be chosen judiciously. It is clear that if the answer to a “problem” is apparent then it is no longer a “problem”. Hence, the defining feature of a problem situation is that there must be some blockage on the part of the potential problem solver (Kroll & Miller, 1993). What is a problem for one person may not necessarily be a problem for another person. Schoenfeld (1985) clearly pointed to the difficulty in describing what constitutes a problem, “...being a problem is not a property inherent in a mathematical task” (p. 74). A problem is constituted in a threefold interaction among person(s), task and situation (e.g., time and place).

What should be the criteria for choosing good problems? Problems selected for a course must satisfy five main criteria (Schoenfeld, 1994, cited in Arcavi, Kessel, Meira, & Smith, 1998, pp. 11-12):

- Without being trivial, problems should be accessible to a wide range of students on the basis of their prior knowledge, and should not require a lot of machinery and/or vocabulary.
- Problems must be solvable, or at least approachable, in more than one way. Alternative solution paths can illustrate the richness of the mathematics, and may reveal connections among different areas of mathematics.
- Problems should illustrate important mathematical ideas, either in terms of the content or the solution strategies.
- Problems should be constructible without tricks.

- Problems should serve as first steps towards mathematical explorations, they should be extensible and generalisable; namely, when solved, they can serve as springboards for further explorations and problem posing.

Conscious of the fact that the choice of problems was critical in our problem solving project, we were guided by the following principles: (1) the problems were interesting enough for most if not all of the students to attempt the problems; (2) the students had enough “resources” to solve the problem; (3) the content domain was important but subordinate to processes involved in solving it; and (4) the problems were *extensible* and *generalizable*. Our approach in this project is design experiment (see Brown, 1992; Wood & Berry, 2003) whereby we are trying out materials and refining them for use in schools. One of the expected outcomes is also a set of well-designed problems for future use in mainstream schools. We wish to triangulate the views of students and the teachers together with our own ideas on these problems for selecting the best problems. However, here we focus only on the students’ views.

The Problem Solving Project

The study involved 153 secondary 2 students (Year 8) in a secondary school in Singapore spread over 6 different classes. The classes were taught by three teachers, each of them teaching two of the classes. Eight one-hour lessons were used to implement a specific problem solving curriculum in which the students had to use a “practical worksheet” (see Toh, Quek, Leong, Dindyal, & Tay, 2009) devised by our research team. We hereby report the students’ views on 13 of the problems that were used during the course as well as a few of their responses. After the course, the students were asked to rank the top three problems that they found most interesting and also to identify one problem that they found least interesting or which they disliked.

Surprisingly for the team the students ranked Problem 3 as the most liked and also as the least disliked problem (see Figure 1). The initial worry for the team was the nature of the context described in the problem. However, the students’ comments suggest that they understood the situation and looked at it solely from a mathematical perspective. From the students’ comments (see Figure 1), we can see that they liked the fact that the problem was interesting, intriguing, challenging or fun to solve. They also made positive comments about the fact they were applying mathematics to solve a seemingly *real-life* problem. While, the students’ comments about Problem 11 (given as a precursor to another problem and heavily dependent on symbolism) was expected, it was a bit of a surprise that they rated Problem 1 as one of the least liked problems. The students’ comments about this problem that they disliked the most include: tedious solution, lengthy calculations, too many steps, they do not understand, or it is too complex, etc.

A good question to ask is whether a problem liked by the students is necessarily a good problem to be included in the curriculum and accordingly whether a problem disliked by the students is one that should be excluded. Another question for discussion is whether those who like a problem are necessarily able to solve the problem and whether a problem they dislike is one that they necessarily cannot solve. What should be some basic criteria for deciding whether to include or exclude particular problems from the problem solving curriculum? How do we triangulate our views with the views of the teachers and the students about the appropriateness of mathematical problems?

Most Liked Problems	Least Liked Problems
<p><i>Problem 2</i> You are given two jugs. Jug <i>A</i> holds 5 litres of water when full while jug <i>B</i> holds 3 litres of water when full. There are no markings on either jug and the cross-section of each jug is not uniform. Show how to measure out exactly 4 litres of water from a fountain.</p> <p><i>Problem 3</i> Two bullets are placed in two consecutive chambers of a 6-chamber pistol. The cylinder is then spun. Two persons play Russian roulette. The first person points the gun at his head and pulls the trigger. The shot is blank. Suppose you are the second person and it is now your turn to shoot. Should you pull the trigger or spin the cylinder another time before pulling the trigger?</p>	<p><i>Problem 1</i> Find the sum of all the digits of the numbers in the sequence 1, 2, 3, ..., 9999.</p> <p><i>Problem 11</i> The base 2 (binary) representation of a positive integer n is the sequence $a_k a_{k-1} a_{k-2} \dots a_1 a_0$, where $n = a_k 2^k + a_{k-1} 2^{k-1} + a_{k-2} 2^{k-2} + \dots + a_1 2^1 + a_0$, $a_k = 1$, and $a_i = 0$ or 1 for $i = 0, 1, \dots, k-1$. Write down the binary representations of the day today and of the day of the month in which you were born.</p> <p>[Problem 11 was given as a precursor to another problem]</p>
<p><i>Students' comments on Problem 2:</i> Fun and mind-boggling. It was interesting that I could solve the problem with algebra. Challenging and nice question! It can be used in everyday life to obtain a given amount of liquid without having the size of the jug available.</p> <p><i>Students' Comments on Problem 3:</i></p> <p>Very interesting, solution quite astonishing, fun to solve.</p> <p>It is interesting. Matter of life and death with probability.</p> <p>Problem 3 is the most interesting question I have encountered in the entire module as it involves probability and it is quite fun to solve as it is a life or death situation and involves loads of thinking together with listing out the possibilities. The problem is also spiced up with the element of a good plot for the question.</p> <p>Allows the entire class to discuss and argue about the possibility and chance of being shot.</p> <p>It shows the use of simple diagram heuristics to solve a complicated problem.</p>	<p><i>Students' Comments on Problem 1:</i></p> <p>It is very tedious.</p> <p>The solving of this problem is challenging and needs some time to think of a solution. The solution takes a long time to carry out.</p> <p>Too numerical and common. Too many steps needed.</p> <p>Takes a lot of counting and adding to see the pattern.</p> <p>The answer is very lengthy. Need too much steps.</p> <p><i>Students' comments on Problem 11:</i> I do not have the resources to accomplish the problem.</p> <p>Too boring/complicated</p> <p>I do not understand the question.</p> <p>I don't understand it at all.</p> <p>Too complex, difficult to understand.</p>

Figure 1. Most liked and least liked problems

Figure 2 below shows some students' solutions to these problems. More solutions to the problems would be highlighted in the symposium presentation.

A solution to Problem 3:

<p>Carry out the Plan</p> 	<p>Pull - 1 miss earlier</p> <p>P (die if pull)</p> <p>① die $\Rightarrow \frac{1}{4}$</p> <p>② live</p> <p>③ live</p> <p>④ live</p>	<p>Spin</p> <p>$\frac{2}{6}$</p> <p>$\frac{1}{3}$</p>	<p>Pull has a lower probability of getting shot.</p> <p>\therefore I should pull</p>
---	---	---	---

A solution to Problem 1:

Find the sum of all the digits of the numbers in the sequence 1, 2, 3, ..., 9999.

$(45 \times 10) + (45 \times 10) = 45 \times 20 \quad (1-99)$
 $(45 \times 700) + (45 \times 100) = 45 \times 800 \quad (1-999)$
 $(45 \times 3200) + (45 \times 1000) = 45 \times 4200 \quad (1-9999)$
 $= 180,000$

Figure 2. Students' solutions to most liked an least liked problems

Conclusion

The students' views on the problems used in the study provide a valuable source of information on the inclusion of certain types of problems or even for refining the problems. We wish students to be able to transfer what they learn during the problem solving process to other situations that they may meet within or outside mathematics. We also understand that we have to reconcile our own views with those of the students and the teachers in the project for making an informed choice of problems. We hope that the symposium will provide an opportunity for a fruitful discussion on this issue.

References

- Arcavi, A., Kessel, C., Meira, L., & Smith, J. (1998). Teaching mathematical problem solving: A microanalysis of an emergent classroom community. In A. Schoenfeld, E. Dubinsky, & J. Kaput (Eds.), *Research in Collegiate Mathematics Education III* (pp. 1-70). Providence, RI: American Mathematical Society.
- Brown, A.L. (1992). Design experiments: Theoretical and methodological challenges in creating complex interventions. *The Journal of the Learning Sciences*, 2, 137-178.
- Kroll, D. L., & Miller, T. (1993). Insights from research on mathematical problem solving in the middle grades. In D. T. Owens (Ed.), *Research ideas for the classroom: Middle grades mathematics* (pp. 58-77). New York: Macmillan Publishing Company.
- Lester, F. K. (1983). Trends and issues in mathematical problem-solving research. In R. Lesh & M. Landau (Eds.), *Acquisition of mathematics concepts and processes* (p. 229-261). Orlando, FL: Academic Press.
- Schoenfeld, A. (1985). *Mathematical problem solving*. Orlando, FL: Academic Press Inc.
- Toh, T. L., Quek, K. S., Leong, Y. H., Dindyal, J., & Tay, E. G. (2009). Assessment in a problem solving curriculum. In R. Hunter, B. Bicknell, & T. Burgess (Eds.), *Crossing divides: Proceedings of the 32nd Annual Conference of the Mathematics Education Group of Australasia* (pp. 686-690). Palmerston North, New Zealand: MERGA.
- Wood, T. & Berry, B. (2003). What does "design research" offer mathematics education? *Journal of Mathematics Teacher Education*, 6, 195-199.

Resources for Teaching Problem Solving: A Problem to Discuss

Quek, Khiok Seng

Nanyang Technological University
<khiokseng.quek@nie.edu.sg>

Jaguthsing Dindyal

Nanyang Technological University
<jaguthsing.dindyal@nie.edu.sg>

Tay, Eng Guan

Nanyang Technological University
<engguan.tay@nie.edu.sg>

Toh, Tin Lam

Nanyang Technological University
<tinlam.toh@nie.edu.sg>

Leong, Yew Hoong

Nanyang Technological University
<yewhoong.leong@nie.edu.sg>

Lou, Sieu Tee

Nanyang Technological University
<sieutee.lou@nie.edu.sg>

In supporting teachers to enact a problem solving curriculum, resources are needed. In this paper, we show in the context of a design experiment, how an initial problem that we thought would fulfil the above criteria was subsequently replaced. The substitute problem is described in some detail.

In supporting teachers to enact a problem solving curriculum, resources are needed. In particular, the choice of problems is critical (Silver, Ghouseini, Gosen, Charalambous, & Strawhun, 2005). In the second paper of this symposium, the basis for the choice of problems used in the Mathematics Problem Solving for Everyone (M-ProSE) project was presented: (1) the problems were interesting enough for most if not all of the students to attempt the problems; (2) the students had enough “resources” to solve the problem; (3) the content domain was important but subordinate to processes involved in solving it; and (4) the problems were *extensible* and *generalizable*. In this paper, we show, in the context of a design experiment (Middleton, Gorard, Taylor & Bannan-Ritland, 2006), how an initial problem that we thought would fulfil the above criteria was subsequently replaced.

The Initial Problem

Sum of Digits Problem

What is the sum of all the digits of the numbers in the sequence 1, 2, 3, ..., $10n - 1$?

This problem was initially chosen to be the exemplar in a resource book to be written for teachers implementing the problem solving module of the M-ProSE project. It had apparently the necessary richness for all four of Pólya’s stages and the use of heuristics:

The sum required here is NOT $1 + 2 + \dots + 10n - 1$. There is a need to pause and understand the problem, and not work out the sum of an Arithmetic Progression.

There is a need to really explore the problem by solving simpler problems and looking for patterns.

Suitable representations and diagrams can be very useful in carrying out a plan.

The problem can be ‘expanded’ in various ways, for eg. What is the sum of all the digits of the even numbers in the sequence 1, 2, 3, ..., $10n - 1$?

An elegant solution for the original problem can be obtained by considering all $10n$ n -digit sequences with each digit having a choice from 0, 1, 2, ..., 9. Then there are exactly $n10n$ digits. These digits are equally divided among 0, 1, 2, ..., 9. Thus, there are exactly $n10n \div 10 = n10n-1$ of each digit 0, 1, 2, ..., 9. Hence the sum = $n10n-1 \times (0 + 1 + 2 + \dots + 9) = 45 n10n-1$.



Unfortunately, we realised that the first solution needed mathematical induction. This clearly was not suitable for a Year 8 curriculum. We decided to modify the problem to:

What is the sum of all the digits of the numbers in the sequence 1, 2, 3, ..., 9999?

Sadly, the Year 8 classes who tried this problem ranked it very low. The students considered it too tedious and needed too many steps. One may overrule the objection that the problem needed too many steps because students do need to learn that *listing* often begins slowly but, done properly, a pattern is discovered and work proceeds very quickly after that. The practical worksheets for this problem showed that very few students could give a complete solution. Perhaps out of tiredness, most ended up with an unproved conjecture, not accepting that ‘pattern is not proof’.

In the context of our design experiment, the problem then did not satisfy points (1) and (2) mentioned above, i.e., student interest and availability of resources. In the next section, we shall describe the replacement, the Lockers Problem, by summarising the main ideas in our treatment of the problem in the resource book.

According to Mason and Johnston-Wilder (2006), it is important to note that there are some distinctions associated with mathematical tasks at various levels: (a) the task as imagined by the task author; (b) the task as intended by the teacher; (c) the task as specified by the teacher-author instructions; (d) the task as construed by the learners; and (e) the task as carried out by the learners. There are bound to be mismatches between what the assigner wishes to achieve and what actually is achieved during the solving process. Although the research team was careful to ascertain if the problem satisfied the four points of reference, it has not been tried out by the students yet.

The Substitute Problem

Lockers Problem

The new school has exactly 343 lockers numbered 1 to 343, and exactly 343 students. On the first day of school, the students meet outside the building and agree on the following plan. The first student will enter the school and open all the lockers. The second student will then enter the school and close every locker with an even number. The third student will then ‘reverse’ every third locker; i.e. if the locker is closed, he will open it, and if the locker is open, he will close it. The fourth student will reverse every fourth locker, and so on until all 343 students in turn have entered the building and reversed the relevant lockers. Which lockers will finally remain open?

Understand the Problem

The key parts of the problem to take time to understand would be: to ‘reverse’ a locker means to open it when it is closed and to close it when it is open; and, which lockers would a particular student act on?

Two useful *heuristics* to help understand the problem are to *act it out* and to *consider a simplified version*, can be used. Consider the problem when there are only 10 students. We list quickly the 10 lockers as 1, 2, ..., 10 on a piece of paper. Now we act out what the 10 students will do, making a backslash ‘/’ for open and a slash ‘\’ over the backslash to obtain a cross ‘×’ for close. After four students, we have:

1	2	3	4	5	6	7	8	9	10
/	×	×	×/	/	×/	/	×/	×	×

The problem (not the solution) looks clear now. If we want to, we could solve the simplified problem for 10 students. This may be our first plan.

[*Devise a Plan*] Our first plan is: we will *consider a simplified problem* for 10 students, and *look for patterns*.

[*Carry out the Plan*] Resource-wise, the problem solver must know multiples well. Continuing, we end with:

1	2	3	4	5	6	7	8	9	10
/	×	×	×/	×	××	×	××	×/	××

And thus we have a solution for our simplified problem as ‘Lockers 1, 4 and 9 will remain open at the end’. Thus, our conjecture after carrying out the first plan is:

The lockers that will remain open will be those whose number is a square, i.e. when there are 343 students, they are 1, 4, 9, 16, 25, 36, 49, ..., 324.

[*Check*] Returning to the original problem, we check our conjecture for the next square that we did not actually act out, i.e., 16. We note that we need only to look at the first 16 lockers (out of the original 343) since students numbered 17 and above will not touch the first 16 lockers, in general Student n will not touch lockers numbered less than n . The conjecture looks good with the following result:

1	2	3	4	5	6	7	8	9	10	11	12	13	14	15	16
/	×	×	×/	×	××	×	××	×/	××	×	×××	×	××	××	××/

[*Understand the Problem 2*] We ask a series of questions:

What feature(s) of a square causes the corresponding locker to end up open? (Note that this is still a conjecture.)

By *acting it out* slowly, why does a particular locker end up open (or closed)?

By looking closely at the *diagram* above, one eventually realises that if a locker is ‘touched’ an odd number of times, it will end up open; if it is ‘touched’ an even number of times, it will end up closed. Thus, we *restate the problem in another way*.

What type of number has its corresponding locker touched an odd number of times?

What feature(s) of a square causes the corresponding locker to be touched an odd number of times? (Note that this is still a conjecture.)

The series of questions involving the conjecture of squares, the lockers being touched an odd number of times, features of a square, distills to a more fundamental question which puts away the conjecture of squares for the moment.

What feature(s) of a number causes the corresponding locker to be touched?

Eventually, we reach the understanding that a locker is touched only by students whose numbers are factors of the number of the locker. Thus, the number of times a locker is touched is exactly the number of the factors of its corresponding number. *Restating the problem in another way* again:

What type of number has an odd number of factors?

The series of questions using heuristics, which twists, turns and focuses the original problem is crucial to better understand the problem before formulating a new plan of attack. The Lockers problem is very good for emphasising the importance of spending time to understand the problem.

[*Devise a Plan 2*] Plan 2 will now be to count the number of factors of some numbers and try to understand why a square has an odd number of factors while the others have even numbers. We will *look for a pattern*.

[Carry out the Plan 2] We will count the number of factors for 1 to 10 and then a few other random numbers when we spot a pattern.

Number	No. of factors	Number	No. of factors	Number	No. of factors
$1 = 1$	1	$5 = 1 \times 5$	2	$9 = 1 \times 9 = 3 \times 3$	3
$2 = 1 \times 2$	2	$6 = 1 \times 6 = 2 \times 3$	4	$10 = 1 \times 10 = 2 \times 5$	4
$3 = 1 \times 3$	2	$7 = 1 \times 7$	2	$16 = 1 \times 16 = 2 \times 8 = 4 \times 4$	5
$4 = 1 \times 4 = 2 \times 2$	3	$8 = 1 \times 8 = 2 \times 4$	4	$343 = 1 \times 343 = 7 \times 49$	4

It is now quite clear that only squares have an odd number of factors!

[Devise a Plan 3] We will now write out a ‘clean’ solution focusing on showing that only the squares have an odd number of factors. We will do this by showing that the factors come in pairs.

[Carry out the Plan 3] An ‘algebraic’ proof was written out in the resource book.

[Check and Expand 3] We can check the solution for the locker 25 by *acting out* the visitors to Locker 25.

We are done for this problem but not done with the problem-solving process. It is a key feature of the model that the solver should try to ‘expand’ the problem even though it is solved. By expanding, we mean one of the following:

- finding other solutions which are ‘better’ in the sense of elegance, succinctness, or with a wider applicability
- posing new problems
- *adapting* by changing certain features of it (e.g. change some numbers, change some conditions, consider the converse)
- *extending* to problems which have greater scope
- *generalizing* to problems which includes the given problem as a special example

An alternative solution, sketched out in the resource book, uses prime factorisation to prove that a natural number is a square if and only if it has an odd number of factors.

We show here one of five problems that were posed in the resource book.

Adaptation: The i -th student reverses every locker whose number is a factor of i .

Sketch of solution: The multiple-factor relationship in the original problem is now reversed. Thus, we are interested in the number of multiples of a number m . The locker with number m will remain open at the end if and only if $\frac{4^3}{m}$ is odd.

Discussion

This paper shows the change that is implemented when design features are examined in a design experiment context. The four criteria points for choosing problems are quite stringent. To what extent can any of the criteria be relaxed? Additionally, is the Lockers Problem amenable for teachers to scaffold students’ learning of problem solving?

References

- Mason, J., & Johnston-Wilder, S. (2006). *Designing and using mathematical tasks*. St Albans: Tarquin Publications.
- Middleton, J., Gorard, S., Taylor, C., & Bannan-Ritland, B. (2006). *The ‘compleat’ design experiment: From soup to nuts*. Department of Educational Studies Research Paper 2006/05 University of York.

Silver, E. A., Ghouseini, H., Gosen, D., Charalambous, C., & Strawhun, B. T. F. (2005). Moving from rhetoric to praxis: Issues faced by teachers in having students consider multiple solutions for problems in the mathematics classroom. *Journal for Mathematical Behavior*, 24, 287 – 301.

Roundtable Presentations



Targeted Learning: A Successful Approach

Linda Cheeseman
University of Auckland
<l.cheeseman@auckland.ac.nz>

Bina Kachwalla
University of Auckland
<b.kachwalla@auckland.ac.nz>

Marilyn Holmes
University of Otago
<marilyn.holmes@otago.ac.nz>

In 2007 “Targeted Learning Groups” were set up in Otago and Southland, New Zealand to support students with their development of knowledge about numbers and to help students become numerate flexible thinkers (Holmes & Tait-McCutcheon, 2009). Since then many schools in New Zealand have trialled the intervention and adapted, where appropriate, to suit the audience in their areas.

The purpose of this round table is to outline how the mathematical intervention has been implemented in some of the low socio-economic schools in Auckland, New Zealand. The discussion will focus on the impact of this intervention on student mathematical knowledge and problem solving skills.

Data collated from sample schools have indicated that if there is a delay in strategy learning, it is often due to a deficit in one or all of the four knowledge domains: numeral identification, number sequence, place value, and basic facts. In order to bridge the knowledge deficit this intervention provides teachers, parents and teacher aides with a structured and sequential framework of knowledge teaching.

The repetition of any learning enables students to master and retain new knowledge (Nuthall 2002) and the consistent nature of the intervention knowledge lessons provide a foundation for students to develop confidence to problem solve.

This round table forum will afford an opportunity for international colleagues to share their experiences of mathematical interventions that have effectively raised student achievement. The discussion will be open to support, critique and/or add to the existing intervention and to seek further research ideas.

References

- Holmes, M. & Tait-McCutcheon, S. (2009), Success for underachievers; How do they get it? In R. Hunter, B. Bicknell, & T. Burgess. (Eds.), *Crossing Divides: Proceedings of the 32nd annual conference of the Mathematics Education Research Group of Australasia* (5-9 July 2009)
- Nuthall, G. (2002), The cultural myths and the realities of teaching and learning. *New Zealand Annual Review of Education*.



Online Professional Development for Mathematics Teachers

Brooke Evans

Metropolitan State College of Denver
<bevans21@mscd.edu>

Patricia McKenna

Metropolitan State College of Denver
mckennap@mscd.edu

Don Gilmore

Metropolitan State College of Denver
<gilmored@mscd.edu>

James Loats

Metropolitan State College of Denver
<loatsj@mscd.edu>

Using collaborative problem solving to develop a “learning community” among mathematics teachers is an established approach to professional development within the field (Lachance & Confrey, 2003; Ryve, 2007). However, the question of whether an *online* environment adequately facilitates the development of a learning community among teacher-learners remains unanswered (Kim & Bonk, 2006). Any answer to that question will be partial and temporary for two reasons. First, teacher-educators can currently choose from an array of web-based conferencing software of variable quality and capabilities. Second, the rapid pace of innovation of educational technology creates both opportunities and challenges for teacher educators: what some technologies *constrain* today, other technologies *enable* tomorrow. Despite these conditions, this roundtable discussion will focus on how one online approach to professional development used by the faculty of Metropolitan State College of Denver (Metro) both promoted and impeded community building and collaborative problem-solving among a group of elementary mathematics teachers in rural Colorado and how other schools may be working through these issues. The growth of online mathematics education and the need for teachers in rural schools to obtain certification in mathematics suggest that mathematics teacher-educators can use Metro’s study and the discussions at this roundtable to structure and conduct online professional development courses in ways that conform to the principles of reform-based instruction.

References

- Kim, K., & Bonk, C. J. (2006). The future of online teaching and learning in higher education: The survey says ... [Electronic version]. *Educause Quarterly*, 29(4), 22-30.
- Lachance, A., & Confrey, J. (2003). Interconnecting content and community: A qualitative study of secondary mathematics teachers. *Journal of Mathematics Teacher Education*, 6(2), 107-137.
- Ryve, A. (2007). What is actually discussed in problem-solving courses for prospective teachers? *Journal of Mathematics Teacher Education*, 10(1), 43-61.



Teaching Mathematics for an Ethical Citizenry

Helen J Forgasz

Monash University

<helen.forgasz@education.monash.edu.au>

At a recent professional development session where I spoke, the principal, a former high school head of mathematics, welcomed participants and reflected on the importance of mathematics for children's futures. He spoke of the relevance of mathematics and its power to model reality. The following exemplar was proposed: "Imagine you are the general of three army divisions. The first is winning handsomely, the second is holding its ground, and the third is suffering huge losses. You have sufficient support troops for only one division. Where would you deploy them?" The answer, he said, was simple, and based on mathematical modeling, "To the winning division, naturally". He provided a second example: "Imagine you are charged with placing landmines for maximum effect. How would you arrange them?" Again, he claimed, mathematical modeling would enable this decision to be easily made.

I left the session disturbed and perplexed. Both examples used to epitomise the power of mathematics were in military contexts, and enabling deaths (collateral damage) was not considered problematic. The principal seemed insensitive to any conceivable wrong in what he had put forward.

Contemporary mathematics curricula urge teachers to ensure that students are exposed to "real world" mathematics. I have no argument with this. But, do teachers reflect on the implications of the contexts in which the examples are set? Do they consider if there are covert messages that reinforce stereotypes, or have moral, ethical, or political implications? At this round table, these issues and the research opportunities offered will be explored.

K-10 National Mathematics Curriculum Implementation: Implications for Research and Teacher Education

Merrilyn Goos

Queensland University

m.goos@uq.edu.au

Christelle Plummer

Catholic Education Office SA

christelle.plummer@ceo.adl.catholic.edu.au

Peter Sullivan

Monash University

peter.sullivan@education.monash.edu.au

Robyn Jorgensen

Griffith University

r.jorgensen@griffith.edu.au

Glenys Reid

Dept of Education & Training WA

glenys.reid@det.wa.edu.au

Gaye Williams

Deakin University

gaye.williams@deakin.edu.au

The session will start with a few minutes reflection from panel members about issues associated with the implementation of the K-10 National Curriculum. This will be followed by input of ideas from participants. Gaye Williams will highlight aspects of MERGA Feedback on the Draft K-10 National Curriculum as they become pertinent to the conversations arising. The purpose of the session is to raise awareness of issues associated with National Curriculum implementation, and invite contributions from participants about future directions for research and teacher education in the light of this.



Magnifying Misalignment of Student Data Across a Range of Assessment Tools to Inform Future Learning Goals.

Marie Hirst

Auckland University
<m.hirst@auckland.ac.nz>

Anuja Singh

Auckland University
<anuja.singh@auckland.ac.nz>

The round table discussion will begin by presenting the findings from a small study investigating possible misalignment of student data from three different assessment tools. It will also look at how any misalignments impact on making overall teacher judgements about student achievement. The three tools used in this case study were AsTTle (Assessment Tool for Teaching and Learning), GloSS (Global Strategy Stage Assessment) and IKAN (Knowledge Assessment for Numeracy) some of which are widely used across New Zealand schools.

With the introduction of National Standards in New Zealand, teachers will become more accountable when making overall teacher judgements (OTJ). An essential aspect of OTJ is that teachers effectively select, use and analyse different assessment tools such as those mentioned above. The small study focuses on helping teachers understand the misalignments within the assessment tools thus helping teachers to use data effectively in order to set clear learning goals.

In the Round Table we hope to stimulate discussion with Australian, New Zealand and other international colleagues about:

- How do other countries address misalignments of various assessment tools?
- Challenges when selecting appropriate assessment tools.
- Feedback and advice on how to extend this small case study further by formulating a research question.
- How to best utilise overall teacher judgement with a range of assessment tools?



Make it Count: An Evidence Base to support Numeracy, Mathematics and Indigenous Learners

Will Morony

*Australian Association of Mathematics
Teachers, Adelaide*
<wmorony@aamt.edu.au>

Caty Morris

*Australian Association of Mathematics
Teachers, Adelaide*
<cmorris@aamt.edu.au>

Make it count: Numeracy, mathematics and Indigenous learners is a national, four year project that is developing whole school, evidence based, sustainable practices to enhance Indigenous students' learning. Community engagement is key to the project's success and various communities of practice are being built to support the work of the project. Eight clusters of schools across Australia are working together to build their evidence base so teachers will know whether they are doing things better or not; so they have certainty around what they believe, and clarity about why things have worked (or not). Contributing to this is the emerging role of the clusters 'Critical Friends' – mathematics and/or Indigenous education academics – who are working in collaboration with the schools in their particular focus. Adding to the evidence base is the overall project evaluation which includes both quantitative and qualitative longitudinal data about change. The project staff is also identifying direct and indirect evidence. Our challenge is to provide an evidence base of 'stuff' that works. How do we marshal the different layers of this 'stuff' into the evidence base and, at the same time, evolve the various roles of those contributing? Do we need something more? The aim of this round table presentation is to open up discussions about participants' experiences and knowledge that can maximise the evidence base from a layered, school-based project like this and to inform the work of the project with new thinking, learning and knowledge.



Short Communications



Primary Students' Theories of Intelligence, Mathematics Self-Efficacy and Achievement: Analysis of the Initial Data

Linda Bonne
Victoria University of Wellington
<linda.bonne@vuw.ac.nz>

In preparation for the collection of baseline data for doctoral research, two assessment instruments – one for students, the other for teachers – were trialled in 2009. At the start of 2010, the final student questionnaire was completed by Year 3 to 6 students in seven schools to gauge their implicit theories of intelligence and their mathematics self-efficacy. Data from a separate assessment of the students' mathematics achievement were also collected ($n = 364$). The students' teachers ($n = 24$) completed a questionnaire to identify their theories of intelligence and self-efficacy for teaching mathematics. Initial findings will be presented.

Using Primary-School Learning Environments to Teach Maths at University

David Butler
The University of Adelaide
<david.butler@adelaide.edu.au>

University lecture rooms are often very stark, with the only wall decoration usually describing how mathematics is used in a variety of (to most students) obscure pursuits. Primary school classrooms on the other hand are often full of resources and activities chosen to reinforce fundamental concepts and skills that relate directly to what the students are learning. In the spirit of a primary school classroom, the presenter has used displays, resources and atmosphere in a University Maths Drop-In Centre to introduce and reinforce important concepts and skills. This presentation describes the success of this approach, and suggests directions for future research in this area.



Pre-service Primary Teachers' Ability to Communicate Mathematics Concepts Effectively

Chua Kwee Gek

National Institute of Education, Nanyang technological University, Singapore

<kweegek.chua@nie.edu.sg>

Process, one of the important components to attain the aim of the Singapore Mathematics curriculum, is often given less emphasis as its mastery seem less tangible in an assessment context. This paper describes a preliminary study to determine Singapore pre-service teachers' ability to articulate mathematics concepts succinctly. The findings show that they were not able to communicate their teaching ideas and concepts effectively. Effective mathematics communication skills using accurate mathematics language and various strategies were then integrated into their pedagogy module so as to equip them better with the necessary repertoire of knowledge and skills for effective mathematics teaching.

An Alternative Pathway to University Mathematics

Nicholas Crouch

University of Adelaide

<nick.crouch@adelaide.edu.au>

The University of Adelaide's Maths Learning Service offers a bridging course as an alternative pathway to university. This self-paced course is for some students a form of distance education. The course appears to be unique in Australia because of the self-paced nature, with students able to take as much or little time as they require, and the fact that students are not graded but rather only progress once a certain level of understanding is achieved. This communication will discuss the experience of teaching in this mode and the effectiveness of the individual feedback on learning.



Preparing a New Generation of High School Mathematics Teachers

Joanne E. Goodell
Cleveland State University
<j.goodell@csuohio.edu>

In 2005, the National Academy of Sciences and National Academy of Engineering together commissioned the report “Rising Above the Gathering Storm” (Committee on Prospering in the Global Economy of the 21st Century, 2007). The report recommended the UTeach teacher preparation program at the University of Texas at Austin as one that should be scaled up across the nation to address the declining population of high school mathematics teachers. Cleveland State University is now one of 20 universities replicating UTeach, and will accept first year students in August 2010. In this session, I will outline the major differences between this program and traditional programs, and discuss issues I have dealt with during the pre-implementation phase.

A Survey of Instructional Leaders in Primary Schools: Emerging Patterns in Numeracy Leadership

Joanna Higgins
Victoria University of Wellington
<joanna.higgins@vuw.ac.nz>

Linda Bonne
Victoria University of Wellington
<linda.bonne@vuw.ac.nz>

One component of an ongoing New Zealand study investigating instructional leadership in numeracy, an online survey, was completed by 44 primary school leaders – numeracy lead teachers, principals, deputy and assistant principals, and syndicate/team leaders. Patterns identified in an analysis of the responses showed that numeracy lead teachers often had a multiplicity of roles, and suggested that numeracy lead teachers who were also a member of the management team had greater influence than those who were not. Implications for the future leadership of numeracy will be discussed.



Calculator Technologies and Females' Mathematics Learning: A Pilot Study

Janelle Hill
Monash University
<Janelle.Hill@education.monash.edu.au>

The relationship between females' attitudes to calculator technology and their achievement and participation in higher-level secondary school mathematics was investigated in this small pilot study. The sample comprised nine females who had recently completed secondary schooling. Most believed that technologies such as graphics and Computer Algebra System calculators were obstacles to higher-level mathematics learning and did not enable them to gain a better understanding of mathematical concepts. Several indicated that mathematics was not particularly useful or relevant for them except as a vehicle to university entry. More research is needed to determine the representativeness and significance of these findings.

Values Operating in Effective Mathematics Lessons in Singapore: Reflections from Classroom Observations

Ho Siew Yin
National Institute of Education, Singapore
<siewyin.ho@nie.edu.sg>

This presentation reports on a study that investigated the professional and pedagogical beliefs of effective mathematics lessons that were co-valued by the teacher and students. This study contributed data to an international pilot study that investigated how different interpretations of effectiveness incorporate traditional, cultural or indigenous views of mathematics education. The conceptualisation of this study was stimulated by previous research findings which found that students' learning of mathematical ideas appeared to be regulated by the teachers' valuing of professional and pedagogical beliefs (Seah, 2007; Seah & Ho, 2009). Data from photos of "effective learning moments" taken by students during the lesson observations in one primary school will also be presented.

References

- Seah, W. T. (2007). Qualities co-valued in effective mathematics lessons in Australia: Preliminary findings. In J. H. Woo, H. C. Lew, K. S. Park & D. Y. Seo (Eds.), *Proceedings of the 31st conference of the International Group for the Psychology of Mathematics Education* (Vol. 4, pp. 161-168). Seoul, South Korea: International Group for the Psychology of Mathematics Education.
- Seah, W. T., & Ho, S. Y. (2009). Values operating in effective mathematics lessons in Australia and Singapore: Reflections of pre-service teachers. In M. Tzekaki, M. Kaldimidrou, & H. Sakonidis, (Eds.), *Proceedings of the Thirty-third Conference of the International Group for the Psychology of Mathematics Education*, (Vol. 5, p. 57-64). Thessaloniki, Greece: PME.



Lesson Study as Research and Professional Development for Practitioners

Jodie Hunter
University of Plymouth
<Jodie.hunter@plymouth.ac.uk>

Lesson study is a professional development process whereupon teachers collectively and systematically examine their own practice in order to improve their teaching (Fernandez & Yoshida, 2004; Stigler & Hiebert, 1999). The focus of this report is on how involvement in a lesson study cycle focused on primary mathematics lessons supported teachers to develop reflective practice. It will outline teacher perspectives of their experiences in the project and examine how their reflective skills and investigation into their classroom practices developed. Conclusions will be drawn of the factors which facilitate or inhibit lesson study as a process of professional development and research.

References

- Fernandez, C., & Yoshida, M. (2004). *Lesson study: A Japanese approach to improving mathematics teaching and learning*. Mahwah, NJ: Lawrence Erlbaum Associates
Stigler, J., & Hiebert, J. (1999). *The teaching gap*. New York: Free Press

The Effectiveness of a Dynamic Professional Development Model Using an Online Mathematics Learning System

Sharon London
Macquarie University
<sharon.london@students.mq.edu.au>

Michael Cavanagh
Macquarie University
<michael.cavanagh@mq.edu.au>

Joanne Mulligan
Macquarie University
<joanne.mulligan@mq.edu.au>

Matthew Bower
Macquarie University
<matt.bower@mq.edu.au>

This study will evaluate the effectiveness of an online professional development model using communication pathways developed for a web-based mathematics learning system. Upper primary teachers from Catholic and government schools in NSW and Victoria will engage in a four-stage online professional development program employing web-conferencing software (Adobe Connect). Professional development will focus on new pedagogies using technology, and promote collaborative reflection and analysis of teaching and learning. Data sources will include digital recordings of a representative sample of lessons, transcripts of PD sessions, data generated by the online mathematics learning system, online surveys completed by students and teachers, and online interviews with teachers.



Teaching and Learning in an Interactive Multimedia E-Learning Environment

Sharon London

Macquarie University

<sharon.london@students.mq.edu.au>

Mike Mitchelmore

Macquarie University

<mike.mitchelmore@mq.edu.au>

Michael Cavanagh

Macquarie University

<michael.cavanagh@mq.edu.au>

This project investigated how teachers used the HOTmaths learning system in laptop learning environments. It took place in 8 Year 9 classes at three Catholic secondary metropolitan NSW schools. Each school used laptops in a different configuration, and selected teachers in two schools were provided with extensive professional development. Data on the implementation were collected via classroom observations, interviews with teachers, and pre- and post-testing using the ACER *PATMaths* test. The results indicated significant improvements in student performance of the intervention groups as compared with the non-intervention groups.

Aboriginal Independent Community Schools Numeracy Strategy

Daniel Pinchas

AICS Support Unit, WA

<numeracy@westnet.com.au>

Renaë Small

AICS Support Unit, WA

<rsmall@ais.wa.edu.au>

Rebecca Youdale

AICS Support Unit, WA

<mathematics@westnet.com.au>

Shirley Riley

AICS Support Unit, WA

<sriley@ais.wa.edu.au>

Kaye Treacy

AICS Support Unit, WA

<ktreacy@ais.wa.edu.au>

The Aboriginal Independent Community Schools (AICS) Numeracy Strategy is a DEEWR funded action research project providing support to independent Indigenous community schools in Western Australia. Over the next two years, the Strategy will work towards making significant improvements in Indigenous students' understanding and skills in numeracy. The project uses a cycle of discovering what students know, focussing on the mathematics they need to learn and implementing effective pedagogy.

Consultants will make regular visits to the schools, working shoulder to shoulder with teachers, Aboriginal Education Workers, and principals. Professional development workshops will be run within schools and at conferences, with resources being developed to support the implementation of the Strategy. Progress will be monitored using standardised assessment and classroom based assessment tasks.



Elementary Students' Understanding of Variable: The Role of Problem Type and Representation

J. Matt Switzer
University of Missouri
<jmsrmf@mail.missouri.edu>

Research has found marked differences in student performance with various algebraic problems (e.g., word problems, word equations, equations) (Koedinger & Nathan, 2004). In addition, research has shown that students' understanding of variable is fragile (Booth, 1984; Carraher, Schielmann, & Brizuela, 2001; Stacey, 1989). Often, the teacher/researcher's introduction of literal symbols assumes that students make connections between their informal symbolisations and formal conventional symbolisations (Kaput, 2008). This cross-sectional research project explores the influence of problem type and variable representation for United States Grade 4 – 6 students as they transition from informal representations of variables to formal conventional representations.

References

- Booth, L. R. (1984). *Algebra: Children's strategies and errors*. Windsor, Berkshire: NFER-NELSON Publishing
- Carraher, D. W., Schielmann, A. D., & Brizuela, b. M. (2001). *Can young students operate on unknowns*. Paper presented at the Proceedings of the 25th Conference of the International Group for the Psychology of Mathematics Education.
- Kaput, J. J. (2008). Algebra from a symbolization point of view. In J. J. Kaput, D. Carraher & M. Blanton (Eds.), *Algebra in the early grades* (pp. 19-55). New York: Lawrence Erlbaum Associates.
- Koedinger, K. R., & Nathan, M. J. (2004). The real story behind story problems: Effects of representations on quantitative reasoning. *The Journal of the Learning Sciences*, 13(2), 129-164.
- Stacey, K. (1989). Finding and using patterns in linear generalising problems. *Educational Studies in Mathematics*, 20(2), 147-164.



Singaporean Senior Secondary Students' Ways of Using Graphics Calculators

Hazel Tan

Monash University

<Hazel.Tan@education.monash.edu.au>

This presentation provides some preliminary findings from a large scale survey of 964 Singaporean Senior Secondary mathematics students regarding the use of graphics calculators. Based on Geiger's (2005) framework of four metaphors for technology use – Master, Servant, Partner and Extension of Self – an instrument was developed (Tan, 2009). It was administered as part of a PhD study on students' learning preferences and their ways of learning and using graphics calculators. The findings are compared to those in the pilot study presented at MERGA 32 (Tan, 2009). The relationship between students' use of calculators and their mathematics self ratings are discussed.

References

- Geiger, V. (2005). Master, servant, partner and extension of self: A finer grained view of this taxonomy. In J. P. Clarkson, A. Downton, D. Gronn, M. Horne, A. McDonough, R. Pierce, & A. Roche (Eds.), *Building connections: Research, theory and practice. Proceedings of the 28th annual conference of the Mathematics Education Research Group of Australasia* (pp. 369-376). Melbourne: MERGA.
- Tan, H. (2009). Development of an instrument for ways of using graphics calculators: Preliminary findings. In R. Hunter, B. Bicknell, & T. Burgess (Eds.), *Crossing divides: Proceedings of the 32nd annual conference of the Mathematics Education Research Group of Australasia* (Vol. 2, pp. 531-538). Palmerston North, NZ: MERGA.

