

**INTERNATIONAL GROUP FOR THE
PSYCHOLOGY OF MATHEMATICS EDUCATION**



**13-18 July, 2003
Honolulu, HI**

**PROCEEDINGS OF THE 2003
JOINT MEETING OF PME AND PMENA
Volume 3**

**Editors
Neil A. Pateman
Barbara J. Dougherty
Joseph T. Zilliox**

**CRDG, College of Education,
University of Hawai'i**

Proceedings of the 27th Conference of the International Group for the Psychology of Mathematics Education held jointly with the 25th Conference of PME-NA

Volume 3

Editors

Neil A. Pateman

Barbara J. Dougherty

Joseph T. Zilliox

College of Education
University of Hawai‘i
1776 University Av.,
Honolulu, HI 96822

Fax: 1-808-956-9905

Website: www.hawaii.edu

The Proceedings are also available on CD-ROM

Copyright © left to the Authors
All rights reserved

ISSN 0771-100X

Design of the PME27 PME-NA Logo: Darrell Asato and Neil Pateman
Cover Design: Cissy Gray

Printed by the Center for Research and Development Group, University of Hawai‘i,
Honolulu, HI, USA

Table Of Contents

Volume 3

Research Reports	Page
<u>Grootenboer, Peter</u> <i>The Affective Views Of Primary School Children</i>	1
<u>Guzman, Jose, Nadine Bednarz, & Fernando Hitt</u> <i>Theoretical Model Of Analysis Of Rate Problems In Algebra</i>	9
<u>Hannula, Markku S.</u> <i>Locating Fractions On A Number Line</i>	17
<u>Hansson, Örjan & Barbro Grevholm</u> <i>Preservice Teachers' Conceptions About $Y=X+5$: Do They See A Function?</i>	25
<u>Haydar, Hanna</u> <i>Daring To Ask The Hard Questions: The Effect Of Clinical Interview Training Upon Teachers Classroom Questioning</i>	33
<u>Hazzan, Orit & Rina Zazkis</u> <i>Reducing Abstraction: The Case Of Elementary Mathematics</i>	39
<u>Hegedus, Stephen J. & James J. Kaput</u> <i>The Effect Of A Simcalc Connected Classroom On Students' Algebraic Thinking</i>	47
<u>Heirdsfield, Ann</u> <i>"Spontaneous" Mental Computation Strategies</i>	55
<u>Hewitt, Dave</u> <i>Notation Issues: Visual Effects And Ordering Operations</i>	63
<u>Hofmannová, Marie, Jarmila Novotná, & Zuzana Hadj-Mousova</u> <i>Attitudes Of Mathematics And Language Teachers Towards New Educational Trends</i>	71
<u>Horne, Marj.</u> <i>Gender Differences In The Early Years In Addition And Subtraction</i>	79
<u>Howe, Ann C. & Sarah B. Berenson</u> <i>High Achieving Girls In Mathematics: What's Wrong With Working Hard?</i>	87
<u>Hoyos, Veronica</u> <i>Mental Functioning Of Instruments In The Learning Of Geometrical Transformations</i>	95
<u>Hwang, Stephen & Jinfa Cai</u> <i>A Perspective For Examining The Link Between Problem Solving And Problem Posing</i>	103
<u>Irwin, Kathryn</u> <i>Multiplicative Strategies Of New Zealand Secondary School Authors</i>	111
<u>Ivey, Kathy M. C.</u> <i>Effective Vs. Efficient: Teaching Methods Of Solving Linear Equations</i>	117
<u>Jirotkova, Darina & Graham H. Littler</u> <i>Student's Concept Of Infinity In The Context Of A Simple Geometrical Construct</i>	125

<u>Khisty, Lena Licon</u> , Hector Morales, & Kathryn Chval	133
<i>Beyond Discourse: A Multimodal Perspective Of Learning Mathematics In A Multilingual Context</i>	
<u>Kieran, Carolyn</u> & Jose Guzman	141
<i>The Spontaneous Emergence Of Elementary Number-Theoretic Concepts And Techniques In Interaction With Computing Technology</i>	
<u>Koirala, Hari P.</u>	149
<i>Secondary School Mathematics Preservice Teachers' Probabilistic Reasoning In Individual And Pair Settings</i>	
<u>Kwon, Oh-Nam</u> , Kyoung Hee Cho, Kyung Hee Shin, & Jeong Sook Park	157
<i>Social Transformation Of Students' Conceptual Model: Analysis Of Students' Use Of Metaphor For Differential Equations</i>	
<u>Kynigos, Chronis</u> & Georgos Psycharis	165
<i>13 Year-Olds' Meanings Around Intrinsic Curves With A Medium For Symbolic Expression And Dynamic Manipulation</i>	
<u>Lamprianou, Iasonas</u> & Thekla Afantiti Lamprianou	173
<i>The Probabilistic Thinking Of Primary School Pupils In Cyprus: The Case Of Tree Diagrams</i>	
<u>Lavy, Ilana</u> & Atara Shriki	181
<i>Pre-Service Teachers' Transition From “Knowing That” To “Knowing Why” Via Computerized Project-Based-Learning</i>	
<u>Leder, Gilah C.</u> & David G. Pederson, Graham H. Pollard	189
<i>Mathematics Competitions, Gender, And Grade Level: Does Time Make A Difference</i>	
<u>Leung, Allen</u>	197
<i>Dynamic Geometry And The Theory Of Variation</i>	
<u>Lin, Pi-Jen</u>	205
<i>Enhancing Teachers' Understanding Of Students' Learning By Using Assessment Tasks</i>	
<u>Lopez-Real, Francis</u> & Nirmala Rao	213
<i>Early Mathematics Teaching: The Relationship Between Teachers' Beliefs And Classroom Practices</i>	
<u>Manouchehri, Azita</u>	221
Factors Motivating Reform: Learning From Teachers' Stories	
<u>Maracci, Mirko</u>	229
<i>Difficulties In Vector Space Theory: A Compared Analysis In Terms Of Conceptions And Tacit Models</i>	
<u>Falcade, Rossana</u> , Maria Alessandra Mariotti, & Colette Laborde	237
<i>Function And Graph In Dgs Environment</i>	
<u>Martin, Lyndon</u> & Jo Towers	245
<i>Collective Mathematical Understanding As An Improvisational Process</i>	
<u>McClain, Kay</u>	253
<i>Supporting Teacher Change: A Case From Statistics</i>	

<u>McDonough, Andrea</u> & Doug Clarke	261
<i>Describing The Practice Of Effective Teachers Of Mathematics In The Early Years</i>	
<u>McGraw, Rebecca</u> , Fran Arbaugh, Kathleen Lynch & Catherine A. Brown	269
<i>Mathematics Teacher Professional Development As The Development Of Communities Of Practice</i>	
<u>Meira, Luciano</u> & Monica Correia,	277
<i>The Emergence Of Mathematical Goals In A Recreational Practice</i>	
<u>Merenluoto, Kaarina</u>	285
<i>Abstracting The Density Of Numbers On The Number Line – A Quasi-Experimental Study</i>	
<u>Misailidou, Christina</u> & Julian Williams	293
<i>Measuring Children's Proportional Reasoning, The "Tendency" For An Additive Strategy And The Effect Of Models</i>	
<u>Misfeldt, Morten</u>	301
<i>Mathematicians' Writing</i>	
<u>Mohammad, Razia Fakir</u>	309
<i>A Co-Learning Partnership In Mathematics Lower Secondary Classroom In Pakistan: Theory Into Practice</i>	
<u>Monteiro, Cecilia</u>	317
<i>Prospective Elementary Teachers' Misunderstandings In Solving Ratio And Proportion Problems</i>	
<u>Moschkovich, Judit</u>	325
<i>What Counts As Mathematical Discourse?</i>	
<u>Mousley, Judith A.</u>	333
<i>Mathematical And Pedagogical Understanding As Situated Cognition</i>	
<u>Murray, Hanlie</u>	341
<i>The Relative Influence Of The Teacher In Third Grade Mathematics Classrooms</i>	
<u>Nachlieli, Talli</u> & Anna Sfar	349
<i>The Activity Of Defining</i>	
<u>Namukasa, Immaculate</u>	357
<i>Collective Learning Structures: Complexity Science Metaphors For Teaching</i>	
<u>Nardi, Elena</u> & Paola Iannone	365
<i>Mathematicians On Concept Image Construction: 'Single Landscape' Vs 'Your Own Tailor-Made Brain Version'</i>	
<u>Nicol, Cynthia</u> & Sandra Crespo,	373
<i>Learning In And From Practice: Pre-Service Teachers Investigate Their Mathematics Teaching</i>	

<u>Nilssen, Vivi</u>	381
<i>Mentoring Teaching Of Mathematics In Teacher Education</i>	
<u>Nisbet, Steven</u>	389
<i>Getting Organised: The Role Of Data Organisation In Students' Representation Of Numerical Data</i>	
<u>Oehrtman, Michael C. F.</u>	397
<i>Strong And Weak Metaphors For Limits</i>	
<u>Oh, Youngyoul</u>	405
<i>Applying Theory Of Planned Behavior Model On Studying Teachers' Change In Mathematics Instruction</i>	
<u>Okazaki, Masakazu</u>	413
<i>Characteristics Of 5th Graders' Logical Development Through Learning Division With Decimals</i>	
<u>Olive, John</u>	421
<i>Nathan's Strategies For Simplifying And Adding Fractions In Third Grade</i>	
<u>Olivero, Federica</u>	429
<i>Cabri As A Shared Workspace Within The Proving Process</i>	
<u>Panaoura, Areti & George Philippou,</u>	437
<i>The Construct Validity Of An Inventory For The Measurement Of Young Pupils' Metacognitive Abilities In Mathematics</i>	
<u>Pang, Jeong Suk</u>	445
<i>Student-Centered Teaching Practices In Korean Elementary Mathematics Classrooms</i>	
<u>Pehkonen, Erkki, Anu Nurmi, Markku Hannula, & Hanna Maijala,</u>	453
<i>On Pupils' Self-Confidence In Mathematics: Gender Comparisons</i>	
Author Index	461

THE AFFECTIVE VIEWS OF PRIMARY SCHOOL CHILDREN

Peter Grootenboer

University of Waikato

This paper documents a study concerned with examining the affective response to mathematics among 45 primary school students. The study sought to examine how the children's emerging beliefs, attitudes and feelings about mathematics impacted on their learning of the subject. A particular finding was that these beliefs, attitudes and feelings were shaped around a narrow conception of mathematics primarily restricted to number concepts and arithmetic.

INTRODUCTION

In 1992, McLeod commented that research into the affective dimension of mathematics education was limited and marginalized, but in recent years there has been a growing awareness of beliefs, values, attitudes and emotions as they relate to mathematics teaching and learning. Studies have been undertaken into the affective views of many particular groups including women (e.g., Buerk, 1985), pre-service and in-service teachers (e.g., Bishop, FitzSimons, Seah, & Clarkson, 2001; Grootenboer, 2002), school children (e.g., McDonough, 2002) and the general public (e.g., Lim, 1999). There seems to be a general consensus in the literature that affective factors have a significant influence with many writers reporting that their participants had debilitating views of mathematics. Indeed, it has been suggested that the beliefs, attitudes and feelings that individuals develop through their schooling considerably limit their ability to use or understand mathematics throughout their life (Schuck, 1997).

While the number of studies in this area has been growing, there appears to be only a few that address the affective views of primary children. The study reported in this paper was an initial investigation into the views and feelings that a group of children had about mathematics and learning mathematics. The children were placed in small groups and asked to talk and write about their thoughts on the nature and purpose of mathematics and how they saw themselves as learners of mathematics.

LITERATURE REVIEW

The relationship between affective factors and achievement in mathematics education has been debated and researched over the last 50 years (Aitken, 1970; Antonnen, 1969; Dutton, 1954; McDonough & Clarke, 1994; McDonough, 2002). Furthermore, there was a perception that students who liked mathematics would also be successful in learning it (Garden, 1997). While this may well be a sound proposition, it seems to underestimate the symbiotic and complex relationship between affect and achievement, as it seems at least feasible that for many students, they like mathematics because they are successful in learning it. Nevertheless, in reviewing the performance of New Zealand students in the Third International Mathematics and Science Study (TIMSS), Garden (1997) reported:

While a majority of students have positive attitudes to learning mathematics ... it appears that from a fairly young age there is an increasing proportion of students having lost interest in the subject, with a concomitant decline in their achievement. (p. 252)

Studies of children's beliefs about mathematics have reported that their views tend to be narrow focusing primarily on counting and number operations (Cotton, 1993; Frank, 1988; Garafolo, 1989). In their study of the beliefs of 1202 primary school children, McDonald & Kouba (1986) found that the students had a limited conception of mathematics that included little beyond numeracy and arithmetic. Moreover, other studies revealed that students seemed to perceive the mathematics they experienced at school as being characterized by the memorization of formulae and the completion of routine exercises (Garafolo, 1989; Schoenfeld, 1992). More recently, McDonough (2002) studied the beliefs primary school children held about mathematics and found that they were diverse, complex and at times idiosyncratic. She suggested that "beliefs may impact upon children's reactions to, or interpretations of, what is stated, performed or produced in a mathematics learning situation and may affect many aspects of their learning ..." (p. 455).

It seems clear from a number of studies that have explored the affective views of adults that many of their beliefs, attitudes and feelings about the subject developed as a school student (e.g., Carroll, 1998). Unfortunately, the general consensus seems to be that the affective views they developed were negative and debilitating, rendering many anxious about mathematics and active in avoiding it (McLeod, 1992). The two aspects of this negative perception of mathematics appear to be beliefs that mathematics is infallible and absolute, and feelings of fear, hatred and boredom about the subject (Mayers, 1994). Given these concerns it seemed appropriate to investigate the affective views of school children as the central focus of this study.

THE STUDY

The study was qualitative in nature and employed research methods that included both oral and written responses to a small range of relatively open questions and prompts. The participants were drawn from three Year five and six classrooms in a suburban New Zealand school. The school is situated in a middle-class suburb and it has received praise for its innovative approach to teaching and learning. Over the last two years the school has been involved in government sponsored initiatives that have sought to improve the numeracy levels of the students. In all, 45 children aged between nine and twelve were involved in the study.

Method

The study was designed to explore the students' personal experiences of mathematics and their perceptions of those experiences. In particular, it sought to understand some of the children's beliefs about mathematics, their attitude towards the subject and their associated feelings and emotions. Given these parameters, a phenomenological framework was appropriate as it encompassed a holistic, human perspective that gave precedence to perception, sense impressions, emotion and experience (Cohen, Manion & Morrison, 2000, Cresswell, 1998).

In order to collect the data the participants were organized into groups of about four or five where they were given the opportunity to both discuss and record their thoughts and ideas. Each child was given a copy of the open-ended questionnaire which they completed both during and after discussing their responses with one another. The student's classroom teacher monitored the group and kept the discussion open, on-task and flowing while reassuring the children that their honest and sincere responses were desired. The questionnaire consisted of three sections, the first focusing on their beliefs about the nature and substance of mathematics (e.g., What do you think maths is about?), the second on their experiences and views on learning mathematics (e.g., Describe your best maths lesson), and the third explored their feelings about the subject (e.g., How do you feel about maths?). While the participants' discussions were rich and insightful, it was not possible to record and therefore, only the data recorded by the participants on their questionnaire sheets was captured for the study.

Phenomenological techniques were utilized for data analysis which initially involved the researcher in reflectively considering and noting any preconceptions (Moustakas, 1994). The data was then read through several times so a general initial sense of the phenomena could be perceived. Coding was used to identify key themes across the data which were then used to try and describe the phenomenon as it was presented in the participants' descriptions. These descriptions are reported in the following section.

FINDINGS

Overall, the students were able to lucidly and succinctly write about their mathematical experiences and their associated feelings and perceptions of mathematics. All of the participants in the study had studied mathematics at school for at least five years and they seemed to draw on the fullness of their experiences in responding to the questions. Three key themes emerged from the data, the first being the nature of mathematics. The second was a significant dimension of the first theme relating to the prominence of times-tables, and the third was the student's feelings about mathematics and learning mathematics. These will now be outlined in turn. While I will endeavor to use the participants' own words to illustrate the themes (spelling and grammar corrected if necessary), for the sake of parsimony only a few lines of transcript will be used.

The Nature of Mathematics

Throughout all the participants responses the common perception was that mathematics is about numbers and arithmetic. In fact, very few of the students mentioned any other aspects of mathematics such as algebra, geometry, statistics or measurement. The following exemplify the participants' comments:

Andrew: Maths is about numbers and \div , \times , $+$, $-$.

Emily: I think maths is about doing sums and learning your numbers and how to use numbers. You need to learn your numbers because it is important to be good at them.

Furthermore, when commenting on what they thought was important in learning mathematics the participants again almost exclusively noted skills and concepts related to numeracy and arithmetic. They mentioned things like times-tables, division and long division specifically, counting, addition, subtraction, fractions and multiplication.

In addition to the common perceptions noted above, a small number (13%) of students indicated that mathematics was also about strategies and problem solving, as illustrated below:

Hannah: It [mathematics] is about problem solving and finding strategies to work out things.

Brienne: It is important to know different ways to solve problems.

Interestingly, the small group of students who identified this dimension of mathematics were all identified by their teachers as being the more able children in the class.

About one third of the participants wrote further comments about mathematics that didn't relate to the skills or concepts of mathematics, but rather to how they perceived the subject. In general, these students were not the high achievers in the class and their comments suggested that mathematics was difficult and hard-work:

Sharee: Maths is about thinking and learning, using your brain. It is a brainy subject and you have to think hard with your brain.

The common thread to these participants' comments was that mathematics is arduous and not easy, and success in mastering it required perseverance and "brain power" (Bradley). One student advised:

Kirsten: Maths is not as easy as it looks. You have to work hard and learn your times-tables and tidy numbers. Maths can be a bit confusing at times but you may as well learn it now or you'll have trouble later.

Kirsten's comment also highlights the significance the participants placed on times-tables.

Times-tables

The second theme that emerged was the prominence of times-tables in the participants' perceptions of mathematics. While this dimension was really a sub-set of the first theme discussed above, the striking status of times-tables in their annotations required separate comment. Nearly 70% of the student-participants thought that times-tables were the most important thing they had learned in mathematics, and almost all the others listed them as being very important. Some of the reasons the children gave are recorded below:

Jason: Times-tables [are the most important aspect], because if you can do times-tables you can do just about anything.

Caitlin: I think the most important thing is your times-tables. They help you with long division and other things.

Zhan: The brainy kids are good at [times]-tables.

Chris: Times-tables, because if you know your tables then you will get a good job.

The sense of the data was that it was important to have memorized your times-tables and be able to recite them quickly. It seemed as if the children who could do this were regarded as the best mathematics students and they were perceived as being "brainy". Times-tables also featured as a factor in the student's discussion about their feelings about mathematics.

Feelings about Mathematics and Learning Mathematics

In discussing their feelings about learning mathematics, times-tables emerged as a characteristic of unpleasant lessons for many of the students. Of the 42% of the students who mentioned times-tables here, they noted in particular writing out their tables, repetitively singing their tables and times-table tests. Other factors that seemed to contribute to unpleasant mathematical experiences were bookwork that was dull and repetitive, content that was perceived as too easy or too difficult, and public humiliation or embarrassment.

A common feeling associated with bookwork and learning content that was seen as too easy or repetitive was one of boredom, as illustrated below:

- Casey: The worst lessons were when we did lots of writing in our maths book for the whole time. That was a boring way to learn.
- Michael: I get bored when we learn something we already know and we get those revision worksheets.

Comments like Michael's tended to come from the students who were more successful in their mathematics learning, whereas a number of the less successful students expressed feelings of confusion and bewilderment about their experiences in trying to come to terms with difficult and unfamiliar material:

- Steven: My worst maths lesson was when I was 9 and I had to figure out six hard maths equations. I didn't get it and I couldn't do it and no one was allowed to help me because it was problem solving.

Another small group (9%) of children who had struggled in their school mathematics education recorded some sad memories of their mathematical experiences, and their comments recorded below speak for themselves:

- Nadine: My worst lessons are when people laugh at me when I get things wrong.
- Neal: When I couldn't do take-aways and the whole class laughed at me. Then I had to stay in all of interval while the others were outside playing and laughing at me.
- Rachel: I was stuck in a group with the good people and they knew all the answers and I didn't understand and couldn't keep up so I got really behind. I didn't understand the progress or the answers but then I had to report to the class. In front of everyone I cried.

Indeed, these quotations reflect the worst experiences of the participants, and while they are significant, the majority of the students expressed more positive feelings towards mathematics.

In responding to questions about how they felt about mathematics, most (over 90%) of the children expressed feelings that were not negative, with nearly 50 percent overtly positive, for example:

- Deborah: Maths is cool! I love it more than any of my other subjects.
- Samuel: I think [mathematics] is 'primo' and I can't think of anything bad about it.

Furthermore, all of the students felt that mathematics was important. Four main reasons were given for their responses: (1) you need it later in life in general (32%); (2) specifically, you need it for your future job (42%); (3) you need it at high school (10%); and (4) you use it all the time (13%). For example, some of their comments were:

- Liam: I think it is important to do maths because otherwise you won't get anywhere in life because you won't get a good job so I think everyone should know their maths.
- Alison: If you know your maths then you can work at a bank or a shop counting the money.
- Grace: Yes, because you need it at high school.
- Tim: You need to do maths because you use it all the time.
- Brady: Maths is important but I don't know why!

The underlying theme in their responses was that mathematics is important because it will be useful in the future.

DISCUSSION AND CONCLUDING COMMENTS

The findings presented in the previous section highlight a number of issues, but here the discussion will be limited to a few key ones. Firstly, the focus will be on the student's narrow and limited perception of mathematics including the privileged status of times-tables, followed by a brief discussion of their feelings about mathematics. Finally, possible implications for mathematics education are explored in the light of the study's findings.

It was clear that the children in the study associated mathematics primarily with number and arithmetic, which was consistent with other studies reported in the literature. In New Zealand the government has placed far greater emphasis on numeracy in the primary school curriculum through specially funded programs (e.g., The Early Numeracy Project) and legislation. While few would question the need for children to be numerate and arithmetically strong, it is also desirable that children have a well-rounded mathematics education including aspects such as geometry, measurement, algebra, statistics, problem solving and mathematical processes. Certainly the children in the study would have been taught these other dimensions of mathematics (as they are fundamental strands of the New Zealand mathematics curriculum), but clearly they were not overtly recognized in their conceptions of the subject. Interestingly, this narrow conception may indeed heighten the mathematics anxiety of some, as possibly the more enjoyable aspects (e.g., geometry) are not included in their definition of what mathematics is really about.

Allied to this was their perception of the ultimate value of times-tables in mathematics - a view that from anecdotal evidence would probably be shared by their parents and the community at large. For a number of the participants times-tables were the most fundamental aspect of mathematics, while also being the dimension they really disliked. It seems that generally times-tables are taught and learned in a rote fashion with the emphasis being on quick and accurate recall. This is a process that does not appear to be particularly mathematical, and yet the students who are able to memorize and quickly recall their tables are seen as the best and most competent mathematics students – “the

brainy ones"! Certainly one could probably make a good case for the inclusion of times-tables in a well-rounded mathematics curriculum, but it seems unlikely that they should be placed at the pinnacle of mathematical learning, so it would appear necessary for this prevailing view to be challenged amongst students, teachers, and the community at large.

One of the interesting things to emerge was that the students' views of mathematics seemed to be firmly grounded in their school experiences. If this is indeed the case generally, then it would seem important that teachers are well aware of the affective lessons their students are learning as they experience the mathematics curriculum in their classrooms. While the children in the present study seemed to generally enjoy mathematics, the literature and conventional wisdom seems to suggest that for many adults this is not the case (Carroll, 1998). It therefore, seems important that mathematics educators and teachers explore ways to build more positive perceptions of the subject so children, like the ones in this study, can maintain their optimistic disposition. This would need to include both a broader perspective of the nature of mathematics and positive attitudes and feelings towards its content and application.

References

- Aitken, L. R. (1970). Attitudes towards mathematics. *Review of Educational Research*, 40, 551-596.
- Antonnen, R. G. (1969). A longitudinal study in mathematics attitude. *Journal of Educational Research*, 62, 467-471.
- Bishop, A. J., FitzSimons, G. E., Seah, W. T., & Clarkson, P. C. (2001). Do teachers implement their intended values in mathematics classrooms? In M. v. d. Heuvel-Panhuizen (Ed.), *Proceedings of the 25th Conference of the International Group for the Psychology of Mathematics Education* (Vol. 2, pp. 169-176). Utrecht, The Netherlands: Freudenthal Institute.
- Buerk, D. (1985). The voices of women making meaning in mathematics. *Journal of Education*, 167(3), 59-70.
- Carroll, J. (1998, December). *Understanding professional development through the analysis of the mathematical life histories of primary school teachers*. Paper presented at the annual conference of the Australian Association for Research in Education, Adelaide.
- Cohen, L., Manion, L., & Morrison, K. (2000). *Research methods in education* (5th ed.). London: Routledge.
- Cotton, T. (1993). Children's impressions of mathematics. *Mathematics Teaching*, 143, 14-17.
- Creswell, J. (1998). *Qualitative inquiry and research design: Choosing among five traditions*. Thousand Oaks, CA: Sage.
- Dutton, W. H. (1954). Measuring attitudes towards arithmetic. *Elementary School Journal*, 55, 24-31.
- Frank, M. L. (1988). Problem solving and mathematical beliefs. *Arithmetic Teacher*, 35, 32-34.
- Garafolo, J. (1989). Beliefs, responses, and mathematics education: Observations from the back of the classroom. *School Science and Mathematics*, 89(6), 451-455.
- Garden, R. A. (1997). General issues arising from the data. In R. A. Garden (Ed.), *Mathematics and science performance in middle primary school: Results from New Zealand's participation*

in the third international mathematics and science study. Wellington, NZ: Research and International Section, Ministry of Education.

- Grootenboer, P. J. (2002). Affective development in mathematics: A case study of two preservice primary school teachers. In B. Barton, K. C. Irwin, M. Pfannkuch, & M. O. Thomas (Eds.), *Mathematics education in the south pacific* (Proceedings of the 25th annual conference of the Mathematics Education Research Group of Australasia, pp. 318-325). Auckland, NZ: MERGA.
- Lim, Chap Sam. (1999). *Public images of mathematics*. Unpublished doctoral thesis, University of Exeter, UK.
- Mayers, C. (1994). Mathematics and mathematics teaching: Changes in preservice student-teachers' beliefs and values. In G. Bell, B. Wright, N. Leeson., & J. Geake (Eds.), *Challenges in mathematics education: Constraints on construction* (Proceedings of the 17th annual conference of the Mathematics Education Research Group of Australasia, pp. 419-428). Lismore, NSW: MERGA.
- McDonald, J. L., & Kouba, V. L. (1986, September). *Kindergarten through sixth grade students' conceptions of the domain of mathematics*. Paper presented at the annual meeting of the North American Chapter of the International Group for the Psychology of Mathematics Education. East Lansing, Michigan.
- McDonough, A. (2002). Measurement and its relationship to mathematics: Complexity within young children's beliefs. In B. Barton, K. C. Irwin, M. Pfannkuch, & M. O. Thomas (Eds.), *Mathematics education in the south pacific* (Proceedings of the 25th annual conference of the Mathematics Education Research Group of Australasia, pp. 449-456). Auckland, NZ: MERGA.
- McDonough, A., & Clarke, D. (1994). Accessing student affect: Strategies and concerns. In G. Bell, B. Wright, N. Leeson., & J. Geake (Eds.), *Challenges in mathematics education: Constraints on construction* (Proceedings of the 17th annual conference of the Mathematics Education Research Group of Australasia, pp. 391-401). Lismore, NSW: MERGA.
- Moustakas, C. (1994). *Phenomenological research methods*. Thousand Oaks, CA: Sage.
- Schoenfeld, A. (1992) Learning to think mathematically: Problem solving, metacognition, and sense making in mathematics, In D. Grouws (Ed.), *Handbook of research on mathematics teaching and learning* (pp. 334-370). New York, NY: Macmillan.
- Schuck, S. (1997). The three selves of the prospective primary school teacher of mathematics: An Australian case study. In F. Biddulph & K. Carr (Eds.), *People in Mathematics Education* (Proceedings of the 20th annual conference of the Mathematics Education Research Group of Australasia, pp. 443-449), Rotorua, NZ: MERGA.

A THEORETICAL MODEL OF ANALYSIS OF RATE PROBLEMS IN ALGEBRA

José Guzmán

Cinvestav-IPN

jguzman@mail.cinvestav.mx

Nadine Bednarz

UQAM, descamps-

bednarz.nadine@uqam.ca

Fernando Hitt

Cinvestav-IPN

fhitt@mail.cinvestav.mx

During several years of experimentation, we accumulated a large collection of data on the analysis of problems generally encountered in algebra and on the reasoning developed by students at different levels when confronted with these problems. Analysis of this data led us to a new way of looking at differences among word problems, and to the development of a new theoretical approach to classify them with respect to their complexity and their structure. The aim of this paper is to extend this theoretical approach to the classification of algebra rate problems with respect to their complexity. An analysis of problems in textbooks from three different time periods allows us to circumscribe the respective fields of possibilities that students encountered with respect to rate problems.

INTRODUCTION

The failure of learning algebra and problem solving in secondary school is a problematic area that researchers know very well (Booth, 1984; Lohead & Mestre, 1988; Kaput & Sims-Knight, 1983; Clement, 1982; Bednarz & Janvier, 1992; Marchand & Bednarz, 1999, 2000). The search for new theoretical approaches to explain and improve the learning of algebra has produced new ways of looking at this problematic. For example, the rupture between the procedures used to solve arithmetic and algebraic word problems and the change of thinking involved in the passage from one to the other are a major point of consideration when formulating new strategies for teaching (Bednarz et al., 1992, 1996; Filloy & Rojano, 1989; Kieran & Chaloug, 1993; Lee & Wheeler, 1989; Chevallard, 1985, 1989; Puig & Cerdan, 1990). The same consideration of the mathematization process is needed within the algebraic domain (Lohead et al., 1988; Kaput et al., 1983; Clement, 1982; Sleeman, 1986). Those studies have provided new teaching approaches which take into account students' difficulties and their different modes of reasoning when facing an algebraic problem (Rojano, 1996; Sutherland & Rojano, 1993; Vergnaud, 1987; Rojano & Sutherland, 2001; Kieran et al., 1996; Landry, 1999; Bednarz, 2001). On the other hand, proposals for teaching strategies, if they are to provide an enlightened choice of problem situations for students, must provide a classification of different problem types and a better understanding of their complexity for students. Our past research enabled us to highlight different types of problems generally encountered in algebra and to analyze the complexity of those problems within a particular type (Bednarz et al., 1994). The investigation we present here is a natural extension of this previous research in that we are applying our theoretical model to a new class of problems: algebra rate problems (ARP).

THEORETICAL ANALYSIS OF ARP

Algebra rate problems have a major role in building algebraic thinking; more precisely in the context of problem solving, and in the articulation between unknown and variable in the learning of algebra. These problems related to proportional reasoning, refer to relationships between non-homogeneous magnitudes, through intermediary of rates. These types of problems, where the concept of rate is present is important in making a connection between mathematics and the “real world”, and mathematics and other sciences. For example, problems dealing with the concept of speed, debt, density, involve the mathematical concept of rate. How can we understand, from a theoretical perspective, students’ difficulties when solving those problems? And how can we be in a better position to help students in their construction of algebraic thinking with respect to rate problems?

In algebra, analysis of problems and their complexity has usually focussed on their symbolic treatment. Indeed, a focus on equations guides the selection of problems for different school levels. The selection and ordering of problems that students must tackle, is guided by this classical approach. For example, equations with one unknown like $ax + b = c$ in Grade 8 are followed in Grade 9 by equations like $ax + b = cx + d$, and then in Grade 10 by systems of equations with two unknowns. The results we obtained from research with secondary school students (Grade 7 to Grade 11) challenge that classical approach because many problems that can be modeled by the same equation can be associated with very different levels of complexity. And some problems in Grade 10 and Grade 11 can be solved more easily than those in the earlier grades, not because of the strategies developed by the students but because of the low complexity involved in the problem (Bednarz & Janvier, 1994; Marchand & Bednarz, 1999).

There is little research related to the complexity of rate problems in algebra. For example, Presmeg & Balderas (2002) worked with rate problems to get a better understanding of graduate students’ visualization rather than the complexity of word rate problems. Yerushalmy and Gilead (1999) developed a theoretical approach to classifying algebra rate problems and to exploring their complexity by looking at how algebra rate problems could be modeled in a functional approach. Their model is restricted to word problems describing constant-rate processes. This model seems to work well when dealing with continuous magnitudes but not when dealing with discrete ones. In their functional approach, they are interpreting data in a specific way that requires enhancing the proposed problem situation, and thus, modifying the original situation. As a consequence, their work does not provide an analysis of the real complexity of interpreting and mathematizing the problem from the student’s perspective.

In previous research, we built a model to classify algebraic word problems (AWP) (Bednarz & Janvier, 1994). The approach developed by our team was in connection with relational calculus (Vergnaud, 1982) which involves the representation and solving of those problems (nature of the relations among data, linking relations...) focussing on the cognitive complexity of the task given to students. Our theoretical approach at that time

was dealing with AWP in connection with problems of unequal sharing. The aim of this paper is to extend this theoretical approach to classify ARP using the same methodology.

METHODOLOGY

Our grid was developed through the analysis of rate problems found in algebraic sections in past and present textbooks at different school levels. This first phase continued with an experimental approach, as a pilot study, with students of Grade 10, where ARP are usually tackled.

In a second phase, a deep analysis of textbooks over three different periods of time (related to three curriculum changes) mapped out the field of applications of the kinds of rate problems that students are facing in the various approaches that are in use (a functional approach, at present, versus an approach stressing problem solving and equations). Because of space limitations, this paper will focus on the theoretical approach rather than the experimental results.

Complexity in the Resolution of ARP

Our theoretical framework classifies algebra rate problems with respect to their complexity, taking into account their structure (underlying relational calculus), the kind of rate (if familiar, different levels of abstraction of the rate involved in the problem, for example, speed, debt, density, unitary cost price, etc.), and the formulation of the rate (formulation in terms of a relation between two magnitudes, for example, he/she traveled 75 km in one hour, versus the formulation 75 km per hour). We will restrict the analysis presented here to the analysis in terms of relational calculus. Our analysis has identified eight main categories. Let us consider several examples of different categories we have found. In what follows, we are using a notation to illustrate different kinds of relational calculus involved in certain types of problems.

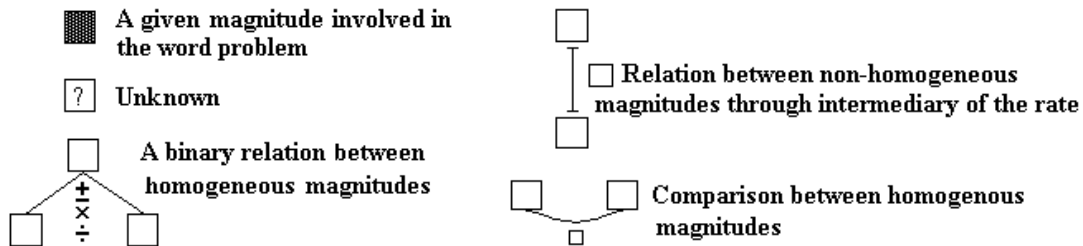

We would like to show the extent of the categories we found in our theoretical approach by presenting only a few examples; we are not being exhaustive.

EXAMPLES USING THE GRID OF ANALYSIS FOR ARP

A word problem, first category

In this category we have word problems where the symbolization process is direct. These kinds of problems, that we found in almost all textbook sections in connection with rate problems, are classified for some authors as problems that promote transition from the students' arithmetical thinking to algebraic thinking (in connection with equations like $ax + b = cx + d$). Usually, in this category, the rate is a familiar one for students (of course, in this category we could increase the difficulty by creating word problems

involving rates that are unfamiliar to students). In summary, these types of problems (see example below) are not complex for the students from a cognitive point of view.

Judy and Carolyn are planning to go to Europe. The two friends are saving some money for the project. Judy has at this moment 500 dollars at the bank and she expects to deposit 20 dollars every week. Carolyn has only 200 dollars but she wants to deposit 40 dollars every week. In how much time will they have the same amount of money?

In our approach, we search the content of the problem to find a relation between non-homogeneous magnitudes (i.e., 20 Dollars every week). From there, we construct our diagram. That is,

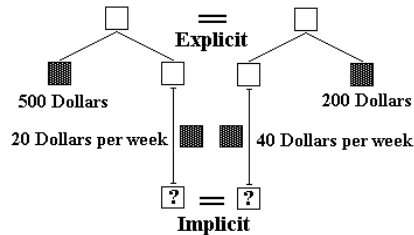

Example of category VI

In this category, the problems involve comparisons among homogeneous magnitudes. Depending on the type of relations, the complexity of the problems increases or diminishes. Let us give an example and at the same time compare our theoretical approach with that of Yerushalmy & Gilead (1999, pp. 187-188, see below).

<p>Round trip 1. A biker traveled from town 1 to town 2 at an average speed of 24 km/hour. Arriving at town 2, immediately turned back and traveled to town 1 at average speed of 18 km/hour. The whole trip took 7 hours. How long was the trip in each direction?</p>	
<p>Round Trip 2. A biker traveled from town 1 to 2 at average speed of 24 km/hour. Arriving at town 2, immediately turned back and traveled to town 1 at average speed of 18 km/hour. The return trip was 1 hour longer than going there. How long was the trip in each direction?</p>	

Their model is restricted to word problems describing constant-rate processes and the field of ARP is wider than that. For example, using the same schema we could find a large class of word problems referring to discrete versus continuous magnitudes and different rates. From our theoretical approach, we gain in extension. However, what is important is that we are keeping in our model the relations and organization of data at hand, which allows us to explicit the complexity of the relations involved and of their linking, to better see what is required by students' process of mathematization.

We agree with Yerushalmy & Gilead that a traditional solution of the problems "Round trip 1 and 2" suggests that they are similar, because the solution is related to a similar equation. Under their approach and ours, they are not. We classified them in the same

category but different subcategories (VIa and VIb). In one case (Round trip 1), we have a binary relation between homogenous magnitudes (t_1 and t_2 , see our diagrams below), in the other case, we have a comparison between the two homogeneous magnitudes.

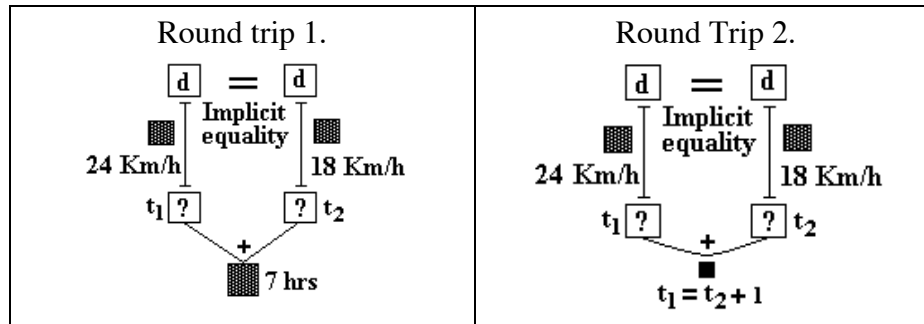

Example of category VII.

In this category, the problems involve relations among non-homogeneous magnitudes and comparisons among homogeneous magnitudes (rates). The rates are unknowns. These kinds of problems are very difficult for students.

<p>A biker augmenting his speed by 5 Km/h, gains 37 minutes and 30 seconds. If he diminishes his speed by 5 Km/h, he loses 50 minutes. What is his speed and how long is the trip?</p>	
--	--

In summary, we have eight main categories with subcategories. In what follows we are briefly presenting the main categories.

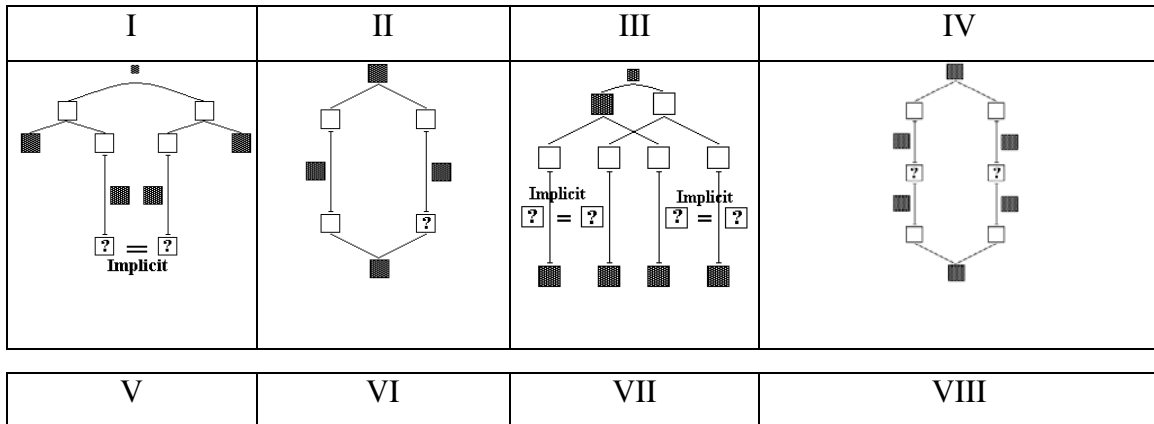

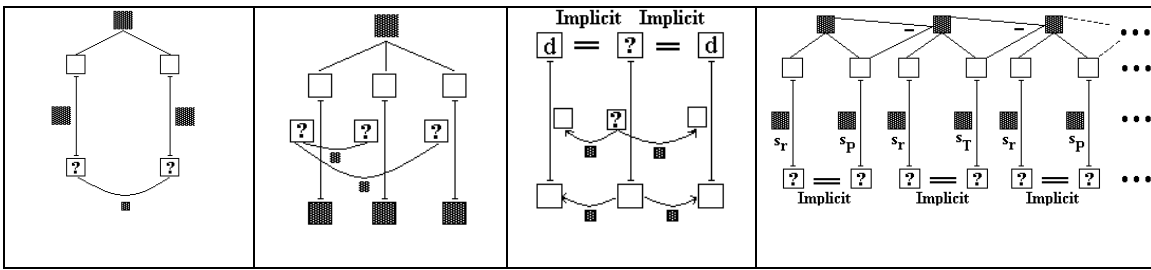

Analysis of the field of problems which students are faced with in ARP

A syllabus analysis shows that proportional reasoning is important for secondary students (Grade 7 and Grade 8); this is within a direct arithmetical approach where problems are dealing with non-homogenous magnitudes in connection with rate. Our analysis of problems shows however that authors of textbooks are not carefully taking into account the transition from arithmetic to algebra, a few rate problems being presented in the introduction of algebra (Marchand & Bednarz, 1999). These problems appear only in some textbooks in Grade 9 and frequently in Grade 10. The teaching process seems to create ruptures from one grade level to the next, because of the choice of problems presented to students. This leads us to the question: Must students confront this transition of thinking in connection with ARP on their own?

*The analysis of three different periods of time related to curriculum changes shows us that the field of problems the students must solve at the present time is relatively limited (see table below). The syllabuses we are considering in our analysis are the Quebec curriculum before 1980, between 1980 and 1993, and from 1994 to the present (they are marked in the table as *, **, ***). We classified the following textbooks according to the main categories in our grid.*

Textbook / Category	I	II	III	IV	V	VI	VII	VIII
Mathématiques d'aujourd'hui 2, (1979*)	1	5				11		1
BMS 4 (Module A), (1985**)	1	8	10	1		6		
Mathématiques Soleil, Sec. 4, (1986**)		13	10	4		8	2	
Mathophilie 436, (1997***)	5	4	17	3		2	1	
Scénarios 436, tome 2, (1997***)	4	2	1					

The selection, in connection with a functional approach in the Quebec curriculum (Grade 10), seems to be oriented towards relatively simple problems. Problems in categories VI to VIII are rare in the current curriculum textbooks we analyzed (see table and books marked with ***) and sometimes absent. In these books, the problems that are proposed to students do not permit a fluid evolution of the students' process of mathematization in relation to complex problems.

DISCUSSION

The theoretical approach presented above can be discussed in terms of intended use of the classification of ARP. We have developed a grid that can be used to predict the complexity of problems according to the structure of the relations involved. Our theoretical approach is a natural extension of the one used with AWP not involving proportional thinking.

We used the grid to analyze and compare textbooks with respect to the level of competence they are requiring of students. Using this grid, we found ruptures in the curriculum because it seems problems are classified in textbooks considering only the final equation or equations involved in solving the problem and not the type of homogeneous or non-homogeneous magnitudes and the type of relations between them. From our point of view, the curricular change to a functional approach has resulted in abandoning too soon the algebraic approach needed to build consistent algebraic thinking and in passing too quickly over the relationship between unknown and variable.

We believe that our theoretical approach can be considered as an example of organizing ARP with respect to their complexity. We conjecture that if teachers are confronted to such type of analysis of problems, they could get a better feel for the difficulties students can experience when solving ARP. The grid of analysis could provide instructors with a holistic approach because this technique takes into account the situated structure of the problem, shows the quantitative relationships involved and allows them to select and create problems in connection with the complexity of the algebraic tasks involved in students' algebraic processes.

References

- Bednarz, N., Radford, L., Janvier, B., & Lepage, A. (1992). Arithmetical and Algebraic Thinking in Problem Solving. In W. Geeslin, K. Graham (Eds). *Proceedings of the 16th International Conference for the Psychology of Mathematics Education*. Durham: NH, PME Program Committee, Vol 1, pp 65-72.
- Bednarz, N., & Janvier B. (1994). The emergence and development of algebra in a problem solving context: a problem analysis. In da Ponte J. P. & Matos J. F. (Eds) *Proceedings of the 18th International Conference of the Psychology of Mathematics Education*. Lisbon, Portugal. Vol. II, pp. 64-71.
- Bednarz, N., & Janvier B. (1996). The emergence and development of algebra as a problem solving tools: continuities and discontinuities with arithmetic. In N. Bednarz, C. Kieran, L. Lee (Eds) *Approaches to algebra: Perspectives for Research and Teaching*. Dordrecht, Kluwer Academic Publishers, pp. 115-136.
- Bednarz, N. (2001). A problem-solving Approach to Algebra: Accounting for the Reasonings and Notations developed by students. In H. Chick, K. Stacey, J. Vincent, J. Vincent (Eds) *Proceedings of the 12th ICMI Study Conference: The Future of the Teaching and Learning of Algebra*, vol 1, pp 69-78, The University of Melbourne.
- Booth, L. R. (1984). *Algebra: Children's strategies and errors*. Windsor, U.K., NFER-Nelson.
- Chevallard, Y. (1985). Le passage de l'arithmétique à l'algèbre dans l'enseignement des mathématiques au collège. *Petit x*, 5, 51-94.
- Clement, J. (1982). Algebra word problems solutions: thought processes underlying a common misconception. *Journal of Research in Mathematics Education*, 14, pp. 16-30.
- Fillooy, E., & Rojano, T. (1989). Solving Equations: The Transition from Arithmetic to Algebra. *For the Learning of Mathematics*, vol 9, no 2.
- Kaput, J., & Sims-Knight, J. (1983). Errors in translations to algebraic equations: roots and implications. *Focus on Learning Problems in Mathematics*, 5, pp. 63-78.

- Kieran, C., Boileau, A., & Garançon, M. (1996). Introducing algebra by means of a technology supported functional approach. In N. Bednarz, C. Kieran, L. Lee (Eds) *Approaches to algebra: Perspectives for Research and Teaching*. Dordrecht, Kluwer Academic Publishers, pp. 257-293.
- Kieran, C., & Chaloug, L. (1993). Prealgebra—The transition from arithmetic to algebra. In D. T. Owens (Ed.), *Research ideas for the classroom middle grades mathematics* (pp. 179-198). New York: McMillan.
- Landry, M. (1999). *Développement d'habiletés en résolution de problèmes en algèbre au secondaire*. Thèse de doctorat en éducation, UQAM.
- Lee, L., & Wheeler D. (1989). The arithmetic connection. *Educational Studies in Mathematics* 20, pp. 41-54.
- Lochead, J., & Mestre, J. (1988). *From words to algebra: mending misconceptions. The ideas of algebra, K-12*, NCTM Yearbook.
- Marchand, P., & Bednarz, N. (1999). L'enseignement de l'algèbre au secondaire: une analyse des problèmes présentés aux élèves. *Bulletin AMQ*, Vol. XXXIX, no. 4, pp. 183-195.
- Marchand, P., & Bednarz, N. (2000). Développement de l'algèbre dans un contexte de résolution de problèmes. *Bulletin AMQ*, Vol. XL, no. 4, pp. 15-24.
- Presmeg, N., & Balderas P. (2002). Graduate students' visualization in two rate of change problems. In F. Hitt (Ed.), *Representations and Mathematics Visualization* (pp. 47-61). Psychology of Mathematics Education North American Chapter and Cinvestav. Mexico.
- Puig, L., & Cerdan, F. (1990). Acerca del Caracter Aritmetico o Algebraico de los problemas verbales. In E. Filloy, T. Rojano (Eds). *Proceedings of the II Simposio Internacional sobre Investigacion en Educacion Matematica*, U. De Morelos, Cuernavaca, pp 35-48.
- Rojano, T. (1996). Developing Algebraic Aspects of problem solving within a Spreadsheet Environment. In Bednarz N., Kieran C., Lee L. (Eds) *Approaches to algebra: Perspectives for Research and Teaching*. Dordrecht, Kluwer Academic Publishers, pp. 137-146.
- Rojano, T., & Sutherland, R. (2001). Arithmetic World-Algebra World. In H. Chick, K. Stacey, J. Vincent, J. Vincent (Eds) *Proceedings of the 12 th ICMI Study Conference: The Future of the Teaching and Learning of Algebra*, vol 2, 515-522. The University of Melbourne.
- Sleeman, D. (1986). Introductory algebra: a case study of students misconceptions. *Journal of Mathematical Behavior*, 5, 25-52.
- Sutherland, R., & Rojano, T. (1993). A spreadsheet Approach to Solving Algebra Problems. *The Journal of Mathematical Behavior*, Vol 12, 4, pp 353-383.
- Vergnaud, G. (1982). A classification of cognitive tasks and operations of thought involved in addition and subtraction problems. In J. P. Carpenter, J. M. Moser and T. A. Romberg (Eds). *Addition and subtraction: a Cognitive Perspective*. Hillsdale, NJ: Lawrence Erlbaum, 39-59.
- Vergnaud, G. (1987). Introduction de l'algèbre auprès de débutants faibles. Problèmes épistémologiques et didactiques. In *Actes du colloque de Sèvres: Didactique et acquisition des connaissances scientifiques*, 259-288. Grenoble: La Pensée Sauvage.
- Yerushalmy, M. & Gilead, S. (1999). Structures of constant rate word problems: A functional approach analysis. *Educational Studies in Mathematics*, ol. 39, pp. 185-203.

LOCATING FRACTION ON A NUMBER LINE

Markku S. Hannula

University of Turku, Department of Teacher Education

Based on a survey of 3067 Finnish 5th and 7th graders and a task-based interview of 20 7th graders we examine student's understanding of fraction. Two tasks frame a specific fraction ($\frac{3}{4}$) in different contexts: as part of an eight-piece bar (area context) and as a location on a number line. The results suggest that students' understanding of fraction develops substantially from 5th to 7th grade. However, Part-to-Whole comparison is strongly dominating students' thinking, and students have difficulties in perceiving a fraction as a number on a number line even on 7th grade.

INTRODUCTION

Rational number is a difficult concept for students. One of the reasons is that rational numbers consist of several constructs, and one needs to gain an understanding of the confluence of these constructs. This idea was originally introduced by Kieren (1976, cited by Behr, Harel, Post & Lesh, 1992), and has since been developed by Behr, Lesh, Post & Silver (1983), who distinguish six separate subconstructs of rational number: a part-to-whole comparison, a decimal, a ratio, an indicated division (quotient), an operator, and a measure of continuous or discrete quantities. They consider the Part-to-Whole subconstruct to be "fundamental to all later interpretations" (p. 93). Toluk and Middleton (2001) regard division as another fundamental scheme that later becomes integrated into the rational number scheme. Based on a study of four case students they presented a schematic drawing of how students develop the connections between fractions and division. The highest developmental stage of their model is the confluence of Fraction-as-Division ($a/b = a \div b$, $\square a/b$) and Division-as-Fraction ($a \div b = a/b$, $\square a/b < 1$) into Division-as-Number ($a \div b = a/b$, $\square a/b$).

In mathematician's conception of (real)number, number line is an important element. (Merenluoto, 2001). If Part-to-Whole subconstruct is the fundament of the rational number construct, then ability to locate a fraction on a number-line could be regarded as an indication (although not a guarantee) of confluence of several subconstructs.

Novillis-Larson (1980, cited in Behr & al. 1983, p. 94) presented seventh-grade children with tasks involving the location of fractions on number lines. Novillis-Larson's findings suggest an apparent difficulty in perception of the unit of reference: when a number line of length of two units was involved, almost 25 % of the sample used the whole line as the unit. Behr & al. (1983) gave different representations of fractions for fourth graders, and their results show that number line is the most difficult one. For example, in case of the fraction $\frac{3}{4}$, the error rate with a rectangle divided in eight pieces was 21% and with a number line with similar visual cue, the error rate was 74%. When no visual cue was provided for the division, the error rate for rectangle was 1 % and for the number line 68%. For 3 years the students' text series had employed the number-line model for the whole-number interpretations of addition and subtraction. Considering that background, the results were surprisingly poor. Behr & al. (pp. 111-113) conclude that students "were

generally incapable of conceptualizing a fraction as a point on a line. This is probably due to the fact that the majority of their experiences had been with the Part-to-Whole interpretation of fraction in a continuous (area) context."

The aim of this study is to deepen and broaden some results concerning students' understanding of fractions. We will explore the development of Finnish students' understanding of fraction both as Part-to-Whole comparison, and as a number on a number line. In addition, we intend to look at gender differences. In the qualitative part of the study we shall take an in-depth view of students' (mis)conceptions. The results will be compared with results from the two studies cited above. With respect to perceiving fraction as a number, there is an important difference between English and Finnish languages. While the English word "fraction" has no linguistic cue for the number aspect of the concept, the Finnish word for fraction ('broken-number') includes also the word 'number'. Hence, it will be interesting to see if Finnish students would more easily perceive fraction as a number.

METHODS

This paper is part of the research project 'Understanding and self-confidence in mathematics'. The project is directed by professor Pehkonen and funded by the Academy of Finland (project #51019). It is a two-year study for grades 5-6 and 7-8. The study includes a quantitative survey for approximately 150 randomly selected Finnish mathematics classes out of which 10 classes were selected to a longitudinal part of the study. Additionally, 40 students participate also a qualitative study.

The research team Markku S. Hannula, Hanna Maijala, Erkki Pehkonen, and Riitta Soro designed the survey questionnaire. It consisted of five parts: student background, 19 mathematics tasks, success expectation for each task, solution confidence for each task, and a mathematical belief scale. The survey was mailed to schools and administered by teachers during a normal 45-minute lesson in the fall 2001. The mathematics tasks in the test were designed to measure understanding of number concept and it included items concerning fractions, decimals, negative numbers, and infinity. Task types included bar-representation of fractions, locating numbers on a number line, comparing sizes of numbers, and doing computations. In this study, we examine student responses to certain items on fractions. There are three levels of analyses to this task: a large survey (N = 3067), a more detailed analysis of different types of answers (N =97), and an analysis of task-based interviews with 20 students.

The bar task required the students to shade fractional proportions of a rectangle divided into eight pieces (an eight-piece bar). This topic is usually covered in Finland during third and fourth grade. We will look at student responses to the task in which the proportion was $\frac{3}{4}$ (Figure 1). The second task required the students to locate three numbers on a number line, where only zero and one were marked (Figure 2). We shall focus on how students located the number $\frac{3}{4}$ on the number line. In Finland the number line is in some schools introduced during second grade, while other schools may not introduce until with diagrams during fourth grade. Likewise, not all schools choose to use number line with fractions. However, in forthcoming new curriculum the students ought to learn fraction, decimal number and percentage and the connection between these - and also the number

line representation for all. There were yet another three items in the test that measured more computational skills with fractions: to compare $\frac{5}{8}$ to $\frac{5}{6}$, to compare $\frac{1}{5}$ to 0.2, and to calculate $3 \cdot \frac{1}{5}$

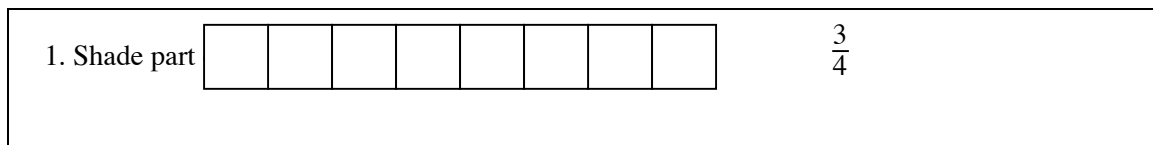

Figure 1. The bar task of the test.

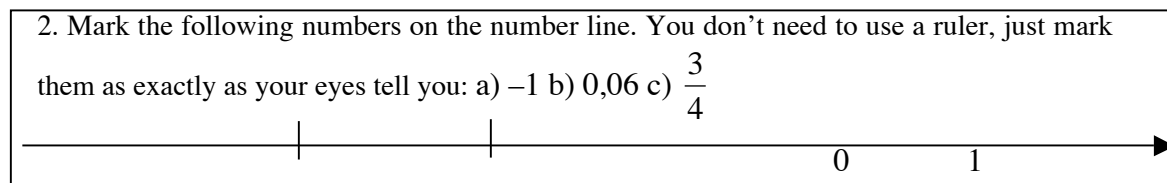

Figure 2. The number line task of the test.

From the full sample of 159 classes, five 7th grade classes were selected for a qualitative longitudinal study¹. We shall analyze the different types of incorrect answers to the 'fraction on a number line' -task given by these 97 7th grade students.

Based on student responses in the survey and teacher evaluations, four students from each of these classes were chosen to represent different student types. The qualitative study is still ongoing, but during the first year, three lessons of each class were observed and video-recorded. The focus students of each class were interviewed in groups in May 2002, more than six months after the test². The video-recorded interviews consisted of a semi-structured interview on mathematics-related beliefs and a clinical interview with students who were solving some mathematical tasks.

In one of the tasks the group had a number line on a paper (magnified from the one in the task), and they were asked to put numbers 3, -1, 0.06, $\frac{3}{4}$, 1.5, and $2\frac{1}{5}$ on the number line. The numbers were written on cards that were given one by one. The students were first asked to think where they would locate the number, and after they indicated that they had decided, they were asked to put their notes on the number line at the same time. They were also asked to explain how they solved the task.

RESULTS

Survey results

As a first, rough picture we can see that 70 percent of students answered correctly to the bar task (Table 1), while 60 percent gave no answer, or a robustly incorrect location for the fraction $\frac{3}{4}$ on the number line (Table 2). We see that in both tasks 7th graders perform notably better than 5th graders. The majority of the students seem to learn the bar task

¹ Another researcher of the team is doing similar study with five 5th grade classes.

² Two of the students were absent on the day of the interview. They were later interviewed individually.

during 5th or 6th grade. However, only half of the students learn to locate the fraction $\frac{3}{4}$ as a positive number smaller than one. Most likely, others do not perceive the fraction as a number at all. We see also a significant gender difference favoring boys in task 2 b ($p < 0.001$), and among 5th graders also in task 1c ($p < 0.01$) (using Mann-Whitney U-test).

	5th graders (N=1154)	7th graders (N=1903)	All (N=3067)
Girls (N=1522)	43 %	85 %	69 %
Boys (N=1525)	50 %	86 %	73 %
All (N=3067)	46 %	86 %	71 %

Table 1. Percentage of correct answers in shading $\frac{3}{4}$ of an eight-piece bar.

	5th graders (N=1154)	7th graders (N=1903)	All N=3067
Girls (N=1522)	15 %	41 %	31 %
Boys (N=1525)	25 %	58 %	46 %
All N=3067	20 %	50 %	38 %

Table 2: Percentage of answers locating $\frac{3}{4}$ within the interval 0-1.

There was a clear relation between the bar task and the number line task, mastering one being a requisite for being able to solve the other. If the student was unable to solve the bar task correctly, the likelihood of him/her solving the number line task correctly was only 8%. Moreover, of those who were able to solve the number line task, 93% had solved the other task correctly. Even the computational tasks were difficult for the 5th graders. The low success rates (23 - 43%) are easily explained by the fact that these topics had not been yet taught in most schools. Most 7th graders (83%) answered correctly that $\frac{5}{8} < \frac{5}{6}$ and 66 percent gave correct answers to the two other computational tasks. Especially interesting here is that 30% of those 7th graders, who knew (with high certainty) that $\frac{1}{5} = 0.2$ located $\frac{3}{4}$ outside the interval 0 - 1. Thus, it seems, that even if a student is able to transform a fraction into a decimal, s/he may be unable to perceive it as a number.

Error analyses

Analyzing the answers of the 97 students in the five chosen 7th grade classes we found out that the correct answer was most common one (49 %) in the number line task (Figure 3). Another 5% had located $\frac{3}{4}$ incorrectly but somewhere between zero and one. Furthermore, a quarter of students had located it between 2.5 and 3.5, and 1 % of the answers were between one and 2.5. One student had marked the fraction on the right side of 3.5, and 6% had not given any answer.

Interview data

One thing that became clear in the interviews of the 20 7th graders was that an improper fraction $2\frac{1}{5}$ was much easier to put on the number line than $\frac{3}{4}$, and no one made a mistake with that task. Furthermore, it was possible to identify two different ways to solve the number line task correctly, and five different misconceptions behind students' incorrect answers in the number line task.

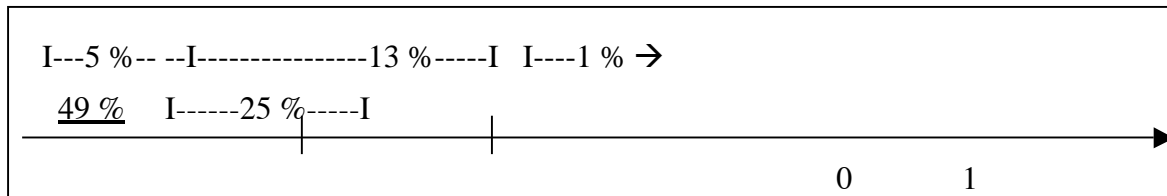

Figure 3. Amounts of seventh-grade students' locating $\frac{3}{4}$ within different intervals on a number line (N=97).

$\frac{3}{4} = 3.4$ The first kind of misconception is a simple wrong interpretation of the mathematical symbolism. The only clear example of that comes from the student S10 who had written 3.4 under the tick he had drawn on a number line. This was a systematic error by the student who also in the interview explained why he put the note on the right side of 3: "I thought that this is 3.4." Such interpretation of $\frac{3}{4}$ was appealing for another student S8 in the same interview group. He had originally located the note correctly after a long hesitation, but later moved it to where S10 had put his note, and explained that he was thinking it as "a decimal thing".

$\frac{3}{4}$ is Not Really a Number. A fundamental conceptual misunderstanding became evident in an interview with student S11. She could not perceive $\frac{3}{4}$ at all as a number on a number line. When asked to put the fraction on the number line, she could not do it.

S11: I don't know. (I don't have ---) {Lets the note fall from her hand. Pulls her arms into her lap.}³

I: If I required you to put it (on the number line, where would you put it?)

S11: I don't know

I: Is that a number?

S11: No.

I: What is it then?

S11: A number {laughs}. I dunno.

She could not locate $\frac{3}{4}$ anywhere. However, in the following tasks she was able to locate 1.5 and $2\frac{1}{5}$ correctly on the number line. Hence, I returned to the fraction $\frac{3}{4}$

³ Text in brackets represents the plausible words of unclear speech, non-verbal communication is written in curly brackets.

- I: Would you like to try that $\frac{3}{4}$ again.
- S11: Nope. Because it has no forenumber.
- I: What forenumber there (--)
- S11: That (two or one {points to 2 1(5 and 1.5} --)
- I: If we put zero as the forenumber? (Zero whole and _?)
- S11: {Takes $\frac{3}{4}$ in her hand} Umm. So then it would be somewhere {thinks, puts approximately to $\frac{3}{4}$ } (somewhere) {slides the note to right place} must be there, I don't know. Somewhere so, that it's before one.
- I: Is this {points to $\frac{3}{4}$ } (same as zero whole $\frac{3}{4}$?)
- S11: No
- I: What's the difference?
- S11: There's zero in there.

Hence, at the end part of the interview we can see, that in her understanding $\frac{3}{4}$ is not the same as 0 $\frac{3}{4}$. The latter has a unique location on a number line, while $\frac{3}{4}$ is something else.

Three out of four. The next error type interprets $\frac{3}{4}$ as "three out of four" which equals 3. In the test the student S2 had drawn a following figure as her answer in the test, which illustrates such line of reasoning (Figure 4). However, in the interview she put the note to the correct place and was able to give a clear explanation.

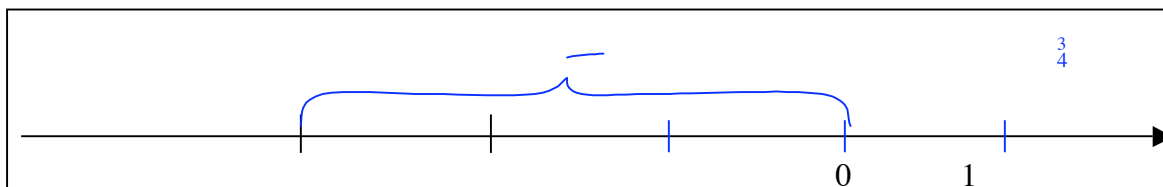

Figure 4. A drawing by S2 in the test.

$\frac{3}{4}$ of what? The next family of errors is based on an understanding of $\frac{3}{4}$ as three parts of a whole divided into four. However, these students incorrectly think of the drawn number line as the whole, or they think of the end segment of the number line from zero or one to the arrowhead. Student S1 stands out as a clear example of such thinking. He put his note to the number three on the number line and explained his thinking.

- S1: (I was thinking of) three fourths of the whole that number line.
- I: (-- Where from did you start counting the whole number line?)
- S1: {Points to the zero} (From there approximately --)

$\frac{3}{4}$ Of Which Unit? Yet another family of mistakes was based on an understanding of $\frac{3}{4}$ as three quarters of a unit, but of a wrong unit. Thus, the number could be put before one, two, three or four. In interview, the student S6 had a hard time deciding where to put $\frac{3}{4}$ on the number line, and her utterances reveal this problem of specifying the unit.

- Students S4 and S5 put their notes to right place, S6 becomes confused.
- S6: Heyy! {sounds desperate} {Begins to giggle confusedly}

- I: Tell now, where you would have< (Where was you thinking to put it.)
 S6: {Becomes serious} but how can it be a fourth, if it is there? {smile}
 I: Well, you tell how YOU thought it?
 S6: No, but. Sort of< I thought that, it is somewhere there after three, you know. Heheh (--)
 I: So you would have put it somewhere here? {points to number line on the right side of three}
 S6: Yes. But, how can it then be, like before one? Because if, you know, in principle it could be like tw< before two? Or something.

Flexible fraction concept. The student S3 had located the fraction correctly in the test, but written also a comment "(out of one (?))" next to her answer. Such comment is related to aforementioned misconception. In the interview she also located the note correctly, but when she was explaining her thinking, she accepted also the interpretation made by the student S1, that $\frac{3}{4}$ could be measured out of the whole number line (see an earlier transcript: " $\frac{3}{4}$ of what?").

- S3: Yeah, me too, (I chose out of one) three fourths. (So) one could have put it also here {points to number three} where it would have been out of four, or out of the number four three fourths

Taken together, this student showed flexibility in her conception of $\frac{3}{4}$. She chose to locate it to 0.75, but she realized that one could choose a different whole and end up with a different answer.

Correct answers. Most of the students who solved the task correctly halved the segment 0 - 1, and then halved the segment $\frac{1}{2}$ - 1 to find $\frac{3}{4}$. However, two students transformed the fraction into a decimal. They explained that they had thought of $\frac{3}{4}$ as 0.75, which they knew to be a little less than one.

CONCLUSIONS

With respect to learning fractions, there is considerable development from 5th to 7th grade. Robust gender differences were found when task was difficult for the age group. When a task had become routine (e.g. the bar task and computing $3 \cdot \frac{1}{5}$ for 7th graders), the gender differences diminished. Such pattern of gender differences can be understood in the light of a general conclusion made by Fennema and Hart (1994). According to them, gender differences in mathematics remain within the most difficult topics, although the differences in general seem to be getting smaller.

Although most 7th graders had learned to compute with fractions their conceptual understanding was weak. Similarly to previous studies, we found that Part-to-Whole-Comparison was the dominating scheme also for Finnish 7th graders. In case of simple fractions, many students could not locate it correctly on the number line. The main difficulty for students was to determine what was the 'whole' wherefrom to calculate the fraction. However, in case of improper fractions 7th graders had no such difficulty.

Comparing the findings of this survey with the results by Behr & al. (1983), we see that Finnish 5th graders perform drastically worse and 7th graders notably better than the 4th graders in that study. Furthermore, 7th graders in the study by Novillis-Larson (1980) performed considerably better than Finnish 7th graders in this study. However, we should remember that the number line that was used in this study was different than in the other ones, and the nature of visual cues seems to be important.

A hypothesis was made that because of a linguistic clue Finnish students might be inclined to perceive fraction as a number with a unique value. However, there was no clear evidence for it. One of the interviewed students simply refused to locate $\frac{3}{4}$ on number line and she was ambivalent on whether it really is a number or not. Several others could not locate the fraction $\frac{3}{4}$ within the right interval between zero and one.

Error rate with number line task was greater in this study than in the cited studies with English-speaking subjects. However, these differences may also be due to different curricula or differences in the test items.

Students' understanding of rational number concept develops considerably from 5th to 7th grade. However, half of the 7th graders are still unable to locate a simple fraction even roughly to a right place on a number line. Their problem seems mainly to be in sticking to a Part-to-Whole schema while being unable to identify the whole correctly.

References

- Behr, M.J., Harel, G., Post, T. & Lesh, R. 1992. Rational number, ratio, and proportion. In. D.A. Grows (ed.) *Handbook on Research on Mathematics Teaching and Learning*, 296-333. New York: Macmillan.
- Behr, M., Lesh, R., Post, T.R. & Silver, E.A. 1983. Rational number concepts. In R. Lesh & M. Landau (eds.) *Acquisition of Mathematical Concepts and Processes*, 91-126. New York: Academic Press
- Fennema, E. & Hart, L.E. 1994. Gender and the JRME. *Journal for Research in Mathematics Education* 24 (6), 6-11
- Kieren, T. 1976. On the mathematical, cognitive, and instructional foundations of rational numbers. In R. Lesh (ed.) *Number and measurement: Papers from a research workshop*, 101-144. Columbus, OH: ERIC/SMEAC
- Merenluoto, K. 2001. *Lukiolaisen reaaliluku. Lukualueen laajentaminen käsitteellisenä muutoksena matematiikassa.* [Students' real number. Enlargement of the number concept as a conceptual change in mathematics.] *Annales Universitatis Turkuensis C* 176.
- Novillis-Larson, C. 1980. Locating proper fractions. *School Science and Mathematics* 53 (5), 423-428
- Toluk, Z. & Middleton, J.A. 2001. The development of children's understanding of the quotient: A teaching experiment. In M. van den Heuvel-Panhuizen (ed.) *Proceedings of the 25th Conference of the International Group for the Psychology of Mathematics Education* (4), 265-272

PRESERVICE TEACHERS' CONCEPTIONS ABOUT Y=X+5: DO THEY SEE A FUNCTION?

Örjan Hansson and Barbro Grevholm

Kristianstad University/Luleå University of Technology, Sweden and Agder University,
Norway

We are studying two groups of preservice teachers' conceptions, progression and especially the concept of function in connection to $y=x+5$ when they are taking a course in algebra or one in calculus in their third and sixth term, respectively, in a teacher preparation program. There is a similar development in that they use to a higher degree a numerical interpretation before the course, which decreases after the course with a growth in linear and functional interpretation with the existence of two variables as a large and rather stable category. The group in their sixth term have a slightly more elaborated language and way of looking at $y=x+5$ than the group in the third term. For a majority of preservice teachers, in both groups, the concept of function is not evoked in connection to $y=x+5$.

INTRODUCTION

As parts of ongoing studies we have asked preservice teachers, in mathematics and science for school year 4-9, to answer the following question "We write $y=x+5$. What does that mean?" (Grevholm, 1998, 2002; Hansson, 2001). One reason to study $y=x+5$ is the fact that Blomhøj (1997) reported that final year students in compulsory school, age 15-16 years, have an unsatisfactory (see below) way of handling a question about how x is related to y in $y=x+5$. Another reason is that linear relations are common subjects that the preservice teachers are going to handle in different teaching-situations as inservice teachers. Linear relations are also often used in introductions of the function concept in later years of compulsory school.

The questions of the study are: What conceptions do preservice teachers have and what is their concept of function in connection to $y=x+5$? What progression can be seen between two groups in their third and subsequently their sixth term, in a teacher preparation program?

THEORETICAL FRAMEWORK

Hiebert and Carpenter (1992) present a framework for examining issues of learning and teaching with understanding. The framework is based on the assumption that individuals' knowledge is represented internally; that internal representations are structured and can be related or connected to one another to produce dynamic networks¹ of knowledge. They suggest that we think about these networks basically in terms of two metaphors, vertical hierarchy and web:

When networks are structured like hierarchies, some representations subsume other representations; representations fit as details underneath or within more general representations. Generalizations are examples of overarching or umbrella representations, whereas special cases are examples of details. ... a network can be structured like spider's

¹ The idea is supported by the fact that human memory, conceived as a network of entities, is a central and well founded theoretical construct in psychology and neuroscience (Anderson, 2000).

web. The junctures, or nodes, can be thought of as the pieces of represented information, and the threads between them as connections or relationships ...The webs may be very simple, resembling linear chains, or they may be extremely complex, with many connections emanating from each node. (Hiebert & Carpenter, 1992, p. 67)

The two metaphors can also be mixed, resulting in additional forms of networks.

The mathematics is understood if its mental representation is part of a network of representations. Understanding grows as the networks become larger and more organized “a mathematical idea, procedure, or fact is understood thoroughly if it is linked to existing networks with stronger or more numerous connections” (p. 67). Existing networks influence the relationship that is constructed thereby helping to shape the new networks that are formed.

Some parts of the network are so tightly structured that they are accessed and applied as a whole, as a single chunk: “accessing any part of the chunk means accessing the entire network” (p. 75). Other parts, called schemata, are relatively stable internal networks that serve as templates to interpret specific events; that is abstract representations to which specific situations are connected as special cases.

Ausubel (2000) presents a hierarchical cognitive structure with similarities to the network model of Hiebert and Carpenter. He presents his theory for learning in an institutionalized setting and talks about meaningful learning and rote learning, which has consequences for the students’ cognitive structures. To accomplish meaningful learning for students teachers have to activate relevant “anchoring” ideas in the learners’ cognitive structures and it is necessary to build upon the learners’ prior knowledge; this is what Hiebert and Carpenter call the bottom-up approach (p. 81). When meaningful learning is accomplished then:

...eventually they [emergence of new meanings in semantic² memory] become, sequentially and hierarchically, part of an organized system, related to other similar, topical organizations of ideas (knowledge) in cognitive structure. It is the eventual coalescence of many of these sub-systems that constitutes or gives rise to a subject-matter discipline or a field of knowledge.

Rote learning, on the other hand, obviously do not add to the substance or fabric of knowledge inasmuch as their relation to existing knowledge in cognitive structure is arbitrary, non-substantive, verbatim, peripheral, and generally of transient duration, utility, and significance. (Ausubel, 2000, p. x)

We consider what Ausubel calls meaningful learning to be similar to what Hiebert and Carpenter call learning with understanding where the dynamic network becomes larger and more organized with growing understanding; a similar phenomenon occurs in Ausubel’s model:

It is important to recognize that meaningful learning does not imply that new information forms a kind of simple bond with pre-existing elements of cognitive structure. On the contrary, only in rote learning does a simple arbitrary and nonsubstantive linkage occur with pre-existing cognitive structure. In meaningful learning the very process of acquiring information results in a modification of both the newly acquired information and of the

² Ausubel describes semantic memory as “Semantic memory is the ideational outcome of a meaningful (not rote) learning process as a result of which new meaning(s) emerge.” (p. x).

specifically relevant aspect of cognitive structure to a specific relevant concept or proposition. (Ausubel, 2000, p. 3)

Tall and Vinner (1981) introduced the notion of concept image as “the concept image consists of all the cognitive structure in the individual’s mind that is associated with a given concept”, p. 151. Different parts of the concept image are evoked in different contexts and they say “we shall call the portion of the concept image which is activated at a particular time the evoked concept image”, p. 152. In this paper, we see a concept image as a chunk of the knowledge structure described above and an evoked concept image as a portion of the concept image in the way of Tall and Vinner.

BLOMHØJ’S STUDY

Preservice teachers supervised by Blomhøj (1997) studied the concept of function in a group of 22 pupils that were in their final year of compulsory school (the 9th year). They asked the pupils to write their answers to the question “ $y = x + 5$, What can you say about x in relation to y ?” and followed up the answers with interviews. In his report Blomhøj distributes the answers in four categories: a) answers that say that x is 5 less than y , b) answers that interpret the equation without answering the question, c) answers that say that x is 5 more than y and finally d) answers that neither interpret the equation nor answer the question.

The distribution of answers was that a) got 6, b) got 4, c) got 7 and finally the category d) got 5 answers. So category c), which is a wrong answer, includes the most answers. Moreover, the answers from the pupils often contain contradictions and more than half of the students could not give an acceptable interpretation.

METHOD AND RESULTS

The preservice teachers at Kristianstad University are studying mathematics in their first, third and sixth term and are then taking courses of a total of 30 weeks full time study where approximately one third relates to educational studies in mathematics. We studied two separate groups of preservice teachers in their third and sixth term, respectively, of a four and a half-year teacher preparation program. The first one took place in the third term where Grevholm (1998, 2002) asked a group of 38 preservice teachers to answer a questionnaire that contained the question of interest before and after a five-week course in algebra and also interviewed some of the preservice teachers. The second took place in the sixth term where Hansson (2001) replicated the first study with a group of 19 preservice teachers in connection to a five-week course in calculus. Hansson also asked them to draw a map that represented their way of thinking about $y = x + 5$ after the course.

Grevholm created a categorization based on the preservice teachers written answers to the question “We write $y = x + 5$. What does that mean?” The categorization arose from the data that was gathered. The categories separate answers that:

- 1) describe how x and y are related numerically, here called category N
- 2) state that there are two variables, V
- 3) give a table of values for $y = x + 5$, T
- 4) describe the relation as a straight line, L
- 5) describe the relation as a function, F
- 6) give other specific descriptions, O

Table 1 gives the distribution of answers. Hansson used the same categories and table 2 gives the distribution³ of answers. The tables are based on the total number of categories that the preservice teachers' answers included.

Category	N	V	T	L	F	O
Before	19 (46%)	11 (27%)	2 (5%)	3 (7%)	4 (10%)	2 (5%)
After	12 (27%)	12 (27%)	2 (5%)	8 (18%)	9 (20%)	1 (2%)

Table 1. 28 preservice teachers answered the question before and after the course in algebra; where 36 answered the questionnaire before and 31 after the course. Table from Grevholm (1998).

Category	N	V	T	L	F	O
Before	12 (38%)	14 (44%)	0	4 (12%)	2 (6%)	0
After	8 (16%)	17 (34%)	0	13 (26%)	8 (16%)	4 (8%)

Table 2. 18 preservice teachers answered the question before and after the calculus course; where 17 answered the questionnaire both before and after the course.

In the following we give an illustration of how the categorization was assessed (Fn and nF belong to the first and second study respectively):

N) F1: $y = (\text{value of } x) + 5$, 8M: y is a number that is 5 units larger than the number x , F4: that y is the sum of 5 and the number you decide x to be.

V) F3: Two unknown, x and y are variables, 14M: y depends on x , M10: Different for different people. For me it means that one x -value represents one y -value.

T) F7: A table of values with x -values on one line " x 5 4 3 2" and y -values on the second line " y 0 1 2 3"⁴.

L) M6: $y = x + 5$ is a line that intersects the y -axis when $x = -5$ and intersects the x -axis when $y = 5$, 12F: it can also be a straight line, 4F: You can also see it as an equation for a straight line that uniquely determines what the line looks like.

F) M5: Function $y = \text{variable } x + \text{number } 5$, 3F: y is a function of x , 4F: y is a function of $x + 5$.

O) 16F: It is also an example of an equation..., F7: It is an algebraic expression, M11: An equation with two unknown numbers.

Eight preservice teachers were also interviewed and tape-recorded in the first study and seven interviewed, four tape-recorded, in the second study. The interviews reveal that the students have more to say than they express in the answers of the questionnaire. In the conversation they usually give interpretations of " $y = x + 5$ " covering more of the categories N-O than in the questionnaire.

The use of concept maps

³ The distribution of answers is adjusted compared to Hansson (2001) to become more uniform with the categorization of answers in Grevholm's studies. In Hansson (2001) the categories F and V were broader and narrower respectively. Functional thinking (Vollrath, 1986) like " y depends on x " was graded F and more specific statements like "... variables x , y ..." graded V.

⁴ In this case the preservice teacher puts x and y on the wrong values.

In the questionnaires students give only a few knowledge propositions to the question. Normally they give one and at most four propositions are given. In earlier research Grevholm (2000, in press) has shown that the use of concept maps is one way to get students to reveal more about their mental representations. It is intellectually more demanding to draw a concept map than to answer a question. In the concept maps students activate more concepts and more links between them than in a verbal written proposition. Inspired by this experience Hansson also decided to use concept maps in his study.

Map made by 5M. A concept map about $y=x+5$.

The preservice teachers in the second study had some experience of drawing mind maps and concept maps in pedagogy and biology, so drawing maps was familiar to them.

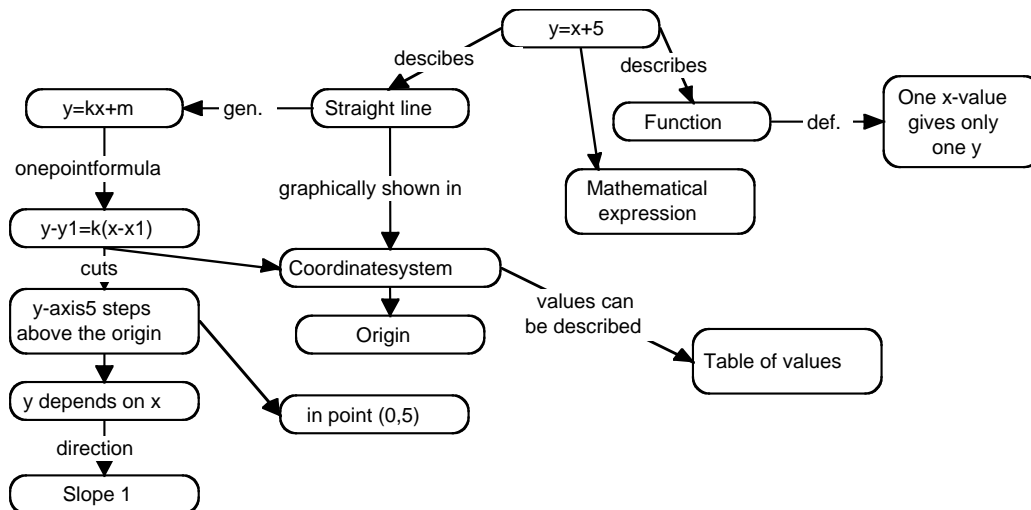

Hansson (2001) gave a lecture on how to use concept maps in mathematics education (in the way introduced by Novak and Gowin, 1984) and discussed how different maps can help visualization of knowledge and understanding and also be used as Ausubel's advance organizers⁵. At the end of the lecture, he asked the preservice teachers to draw a map about $y=x+5$ which they did for almost 30 minutes. One of the preservice teachers' maps, made by 5M, is shown above.

DISCUSSION

The two groups of preservice teachers we studied had a similar development of answers to the question before and after the courses they took in that there was a reduction in category N and growth in category L and F as shown in tables 1 and 2. Category V is large and quite stable in the algebra course; it is the largest category and rather stable in the calculus course. It is surprising that the preservice teachers in their sixth term before the calculus course came up with so many answers in category N; a category we judge as less advanced than the categories L and F. The ordering of categories N, V, T, L, F is a

⁵ An advance organizer is a pedagogic device that helps ... bridging the gap between what the learner already knows and what he needs to know if he is to learn new material most actively and expeditiously. (Ausubel, 2000, p. 11)

reflection of our view of order of more advanced levels of thinking; demanding more developed cognitive structures with the function concept having the most complex structure with connections to numerous sub concepts.

The answers in the second questionnaire were more detailed and covered more categories, and were more explicit in the group who took the calculus course. The authors could see a slightly more mature language in the answers of the second questionnaire and especially from the group who had advanced longer in the teacher preparation program, but a yet more elaborated language is desired to become successful as an inservice teacher. None of the groups used more advanced mathematics than from the curriculum of upper secondary level. The interviews indicate however that the understanding of the students is somewhat more developed than what seems to be the case in the written answers.

Examining data for individual students confirm that concepts develop slowly. More than every second student give answers in the same categories before and after the course. Other students just add an extra category. For those who keep the same categories it is notable that they after the course express themselves in a more advanced professional language for teachers. (The students were not aware of the categories that we use here. They were just asked to answer as honest and open as they could to show us their knowledge.)

There is a growth in the number of answers in category F when comparing the first and second questionnaire. But even so the majority of preservice teachers do not mention that $y=x+5$ is a function. Moreover, only one preservice teacher (M13) who took the algebra course gave $y=x+5$ any properties as a function. He wrote that it was a linear function and did so in the second questionnaire. There was also only one preservice teacher (4F) in the calculus course who, before the course, wrote that $y=x+5$ becomes a line. After the calculus course there were more answers mentioning that the function becomes a line (no one was referring to the line as a function graph); no other property was mentioned.

It is notable that so few preservice teachers write that $y=x+5$ is 'an equation' in the questionnaires. Only one preservice teacher mention it in the algebra course and four (in the second questionnaire) in the calculus course; in contrast to the concept maps where ten preservice teachers mention it. The concept of equation is one they have worked with for many years, much longer than the concept of function. It is also obvious that none of the groups is actively using the term linear. However, the concept of line is used in both groups and more frequently in connection to functions in the group studying in their sixth term.

When we look at the maps we see that they contain more information than the written answers. They are clearly more developed in the area of a straight line where they mention things like slope, intersection with the axis in a coordinate system and the equation of a straight line $y=kx+m$; which was also visible in the written answers.

Eight preservice teachers have function as a part of their map, but it has few links⁶ connected to it (as in the map that 5M drew). One exception is 17M who writes $f(x)=x+5$ and gives the derivative and primitive function. Moreover, links between function and straight line is not common and only one map (14M) mentions graph and makes links between function, graph and then straight line. Other properties of functions like for example monotonicity and continuity are not mentioned. The concept of equation is more explicit in the maps than in the written answers and some maps also have connections to applications and learning and teaching.

The fact that the group just took a course in calculus where the function concept makes a central part was in large not visible in the written answers or the maps they drew. It indicates that the function concept is less meaningful in the context of $y=x+5$. They seem to make connections with mathematical knowledge on a less advanced level than what they have worked with in their later courses in mathematics. A premature concept of function (Vollrath, 1986) is also visible in answer like “y depends on x” (14M) in category V. Even category F has answers with a less developed concept of function like “y is a function of $x+5$ ” (4F).

CONCLUSIONS

There was no indication that incorrect answers like those shown in the study by Blomhøj were frequent among the preservice teachers. There is a similar development in both groups of preservice teachers with tendencies of a numerical interpretation of $y=x+5$ before the course which lessens after the courses with a growth of linear and functional interpretation; with the existence of two variables as a large and rather stable category. The group of preservice teachers who had progressed further in the teacher preparation program had a slightly more developed language and flexible way of looking at $y=x+5$ where for example the concept of equation was more common. The maps gave valuable information about how the students look upon $y=x+5$ and connections between different parts of knowledge became more explicit. The function concept was not well developed in connection to $y=x+5$; if mentioned it did not have any properties except as a line in a few cases. Views upon the function concept, as an object with many properties, were hardly visible. This became apparent in the written answers but also clearly in the maps.

This study indicates that the preservice teachers’ concept of function is not a rich cognitive structure in the evoked concept image in the context of $y=x+5$. It could mean that they as inservice teachers give less attention (Chinnappan & Thomas, 1999; Even, 1993; Fennema & Loef, 1992; Vollrath, 1994) to the function concept in linear relations. The fact that teachers do not give enough explicit attention to the functional aspects of linear relations can be one explanation to the results from pupils in year nine in Blomhøj’s study. Niss (2001, p 43) concludes that “If it is something we want our pupils to know, understand or manage, we must make this part of an explicit and carefully designed teaching”. (Our translation). If we want students (pupils) to be able to interpret a

⁶ We assume the number of links is positively correlated to the concepts importance in relation to each other in the context of $y=x+5$.

given expression as a function this aspect must be part of the teaching that students are offered.

Acknowledgement: We thank Professor Barbara Jaworski for valuable comment on an earlier draft of this paper.

References

- Anderson, J. R. (2000). *Learning and memory: An integrated approach*. New York: Wiley.
- Ausubel, D. P. (2000). *The acquisition and retention of knowledge: A cognitive view*. Dordrecht: Kluwer Academic Publishers.
- Blomhøj, Morten (1997). Funktionsbegrebet og 9. klasse elevers begrebsforståelse. *Nomad* 5, nr 1, 7-31.
- Chinnappan, M. & Thomas, M. (1999). Conceptual modelling of functions by an experienced teacher. *Proceedings of the 22nd annual MERGA conference*, Adelaide, Australia.
- Even, R. (1993). Subject-matter knowledge and pedagogical content knowledge: prospective secondary teachers and the function concept. *Journal for research in mathematics education*, 24(2), 94-116.
- Fennema, E. & Loef. M. (1992). Teacher knowledge and its impact. In D. Grouws, (Ed.), *Handbook of research on the teaching and learning of mathematics*, New York: Macmillan, pp. 147-164.
- Grevholm, B. (1998). Teacher students' development of concepts in mathematics and mathematics education. In T. Breiteg & G. Brekke (ed), *Theory into practices in Mathematics Education. Proceedings of Norma 98*. Kristiansand: Høgskolen i Agder, p. 139-146.
- Grevholm, B. (2000). *Teacher education in transition. The case of Sweden*. Paper presented at WGA7 in The International Conference of mathematics Education 9 in Makuhari, Tokyo, Japan.
- Grevholm, B. (in press). *Research on student teachers' learning in mathematics and mathematics education*. Regular lecture at The International Conference of mathematics Education 9 i Makuhari, Tokyo, Japan. To appear in Proceedings of ICME9.
- Grevholm, B. (2002). Vi skriver $y=x+5$. Vad betyder det? *Svensk förening för matematikdidaktisk forskning Medlemsblad*, nr 5, 17-36.
- Hansson, Ö. (2001). *En studie i lärarstudenternas begreppsuppfattning: "Vi skriver $y=x+5$. Vad betyder det?" Projektrapport vid institutionen för matematik och naturvetenskap*. Kristianstad: Högskolan Kristianstad.
- Hiebert, J. & Carpenter T. P. (1992). Learning and teaching with understanding. In D. Grouws, (Ed.), *Handbook of research on the teaching and learning of mathematics*, New York: Macmillan, pp. 65-97.
- Niss, M. (2001). Den matematikdidaktiska forskningens karaktär och status. In B. Grevholm (Ed.) *Matematikdidaktik – ett nordiskt perspektiv*. Lund: Studentlitteratur, pp. 21-45.
- Novak, J. D., & D. B. Gowin. (1984). *Learning how to learn*. New York and Cambridge, UK: Cambridge University Press.
- Tall, D. & Vinner, S. (1981). Concept image and concept definition in mathematics with particular reference to limits and continuity. *Educational studies in mathematics* 12(2), 151-169.
- Vollrath, H. J. (1986). Search strategies as indicators of functional thinking. *Educational studies in mathematics* 17, 387-400.
- Vollrath, H. J. (1994). Reflections on mathematical concepts as starting point for didactical thinking. In R. Biehler, R. W. Scholtz, R. Strässer, B. Winkelmann (Eds.), *Didactics of Mathematics as a Scientific Discipline*, 61-72

DARING TO ASK THE HARD QUESTIONS: THE EFFECT OF CLINICAL INTERVIEW TRAINING UPON TEACHERS CLASSROOM QUESTIONING

Hanna Haydar

College of Staten Island- CUNY

This paper considers how teachers' questioning behaviors are observed to change after training in and using clinical interviews. Seven elementary mathematics teachers participated in trainings in clinical interviews. They were videotaped while introducing a new mathematics topic to their students prior to and after four months of the training. Their questions were identified, classified and codified according to their functions. Comparative results showed that teachers' use of questions that shape understanding or press for reflection increased in the post-training lesson.

INTRODUCTION

This study is a component of larger research that examined the relationship between elementary mathematics teachers' training in clinical interview and their instructional efficacy (Haydar, 2002). In particular the general research aimed to examine how would training teachers in clinical interview affect their sense of instructional efficacy, their questioning behaviors and their responses toward students' mistakes.

The focus of this report is to describe the changes in the function of questions that teachers used in their instructional discourse after training in clinical interviewing.

THEORETICAL FRAMEWORK

This study draws upon a solid conviction in the uniqueness and strength of the clinical interview, developed by Jean Piaget (1926), as an attempt to take full advantage of both testing and direct observation and, at the same time, to avoid their disadvantages. He presented the clinical interview as a research method that could portray the child's natural mental inclination and identify underlying thought processes. As noted by Clement (2000), the strength of the clinical interview over other data collection techniques includes

the ability to collect and analyze data on mental processes at the level of subject's authentic ideas and meanings, and to expose hidden structures and processes in the subject's thinking that could not be detected by less open-ended techniques" (p. 547).

A clinical interview, as defined by Hunting and Doig (1997), is a "dialogue or conversation between an adult interviewer and a subject. The dialogue centers around a problem or task chosen to give the subject every opportunity to display behavior from which to infer which mental processes are used in thinking about that task or solving that problem."

The investigator adopts the recent calls made by various mathematics educators, professional organizations and curriculum reformers (NCTM, 2000; Ginsburg et al., 1998) for the use of clinical interview by teachers in their classroom instruction, as a powerful and necessary mean to help them meet with the current reform expectations. This sounds especially valid when we consider the shift witnessed in mathematics

education towards a problem solving approach that emphasizes on conceptual understanding, problem solving, and children's constructions of mathematics.

Another theoretical stance for this study is the view of professional development of teachers as central for improving schools and instruction (Sykes & Darling Hammond, 1999). A professional development is thought effective when it observes the six principles suggested by Little (1993). In her model Professional development (1) offers meaningful intellectual, social, and emotional engagement with ideas, materials, and colleagues, both in and out of teaching, (2) takes explicit account of the contexts of teaching and the experience of teachers, (3) offers support for informed dissent, (4) places classroom practice in the larger contexts of school practice and the educational careers of children, (5) prepares teachers to employ the techniques and perspectives of inquiry and (6) ensures bureaucratic restraint and a balance between the interests of institutions.

In this model training is considered a balanced part of a larger configuration and professional developers are expected to immerse in the actual instructional settings where teachers work.

METHOD

Participants in the study were seven elementary school teachers, one male and six females who taught mathematics in Beirut and Baakleen, Lebanon, in a setting described as shifting from a traditional to a reform vision of learning and teaching. They taught in two schools that were complying with the implementation of the New Lebanese Curricula developed by the National Center for Educational Research and Development (NCERD) in 1997. The new Curricula sought to reach and parallel recent international changes and findings in education, schooling, and psychology.

More specifically, the mathematics curricula adopted an equity principle that eliminated elitism in learning mathematics and called for math-for-all instruction. They aimed to empower all students in mathematical reasoning and problem solving (Dagher, 1999). To meet this vision, a shift in teachers' professional development programs was urged in order to follow the paradigm shift occurring worldwide.

The seven teachers participated in a six day-long training sessions in clinical interviews developed by the investigator at an earlier stage of the broader study. Data for this study were collected in three stages: pre-training, training, and post-training. Each teacher was filmed twice, once as part of the pre-training exploration, the other during the post-training stage. While the actual topic to be taught was left to the teacher, the investigator requested that each teacher include an introduction of a new mathematical concept. This criterion aimed to guarantee a sufficient amount of teacher talk for comparative purposes since teachers might talk minimally in some other instructional situations such as students working on set of exercises or practicing certain algorithms.

Training

The training was designed according to paradigms for teacher development that emphasize "action-reflection"(Hunting & Doig,1997). It consisted of a six-day workshop

that took place over three different week-ends spread over a period that included other research activities (classroom observations, clinical interviews and focus groups). The training was well received and evaluated positively by all participants. They had all been unfamiliar with clinical interviews prior to training, and they practiced interviewing and could evaluate their experience during and after training. In their final evaluation logs, five teachers expressed their intention to implement interviewing in their teaching. At the administrative level, the academic principal of one school, who had attended most of the sessions, had very positive impressions. She informed the investigator that she had suggested at an administrative meeting that they consider training all teachers in clinical interviews; this was later confirmed in an e-mail received by the investigator.

Data

To analyze the questions that teachers used in their instruction, pre-and post-training videotaped lessons were used. The investigator watched the videos of the lessons, one tape at a time. For this study, a definition of a question was adapted from the *Glossary of Linguistic Terms* (Loos, 1999) where two senses of a question are given; (1) a question is an illocutionary act that has a directive illocutionary point of attempting to get the addressee to supply information (e.g., tell me your name) and (2) a question is a sentence type that has a form (labeled interrogative) typically used to express an illocutionary act with the directive illocutionary point mentioned above (e.g., what's your name?).

In the classroom context, a teacher's utterance in this study was considered a question whenever she attempted to obtain information from the student, or whenever she used the interrogative pro-form. The investigator believed that, as noted by Kubinsky (1980), questions must be identified by considering their potential answers. This suggests that questions cannot be identified or classified apart from their answers. Thus, the investigator decided to identify and classify questions simultaneously as one step. The study was also interested in examining questions according to function rather than type, dimension or style.

According to function, investigator would ask: "What did the teacher want this particular question to do?" This stance was favored because clinical interviewing was believed to result in a functional change toward more thinking and reflection in the classroom. Questions were categorized according to their general function, as suggested by Morgan and Saxton (1991). According to their model, questions could be classified into three broad categories: Category A, *Questions which elicit information*; Category B, *Questions which shape understanding*; and Category C, *Questions which press for reflection*. Within each category, a number of subcategories and particular functions are defined

After a question was identified, classified, and codified, the investigator arranged it on a question spreadsheet consisting of three columns: the first for the ordinal number of the question (Q1, Q2, Q3, etc.); the second for verbatim questions; and the third for the corresponding code. When finished with a whole video session, the investigator calculated the total number in each of the three categories, along with hypothetically critical codes and sequences of codes. He then derived percentages, which were used to compare the pre- and post-training results.

Hypothetical Expectations

At the category level, the investigator expected that a clinical interview attitude would result in an increase in the percentages of both B and C questions at the expense of the A questions. This was based on the nature of clinical interviewing as a means of shaping a student's understanding and targeting the student's reflections on the answers.

Some specific codes were also believed to increase because of learning and the use of clinical interviewing. These codes corresponded to questions that value students' informal knowledge of the material (A7); press for rethinking (B2a); demand inference and interpretation (B4); and promote expression of points of view (B5).

RESULTS

In all, 583 questions were identified within the pre- and post-training videos of the subjects' lessons: 287 from pre-training lessons and 295 from post-training. The comparison found that teachers' use of questions that shape understanding (B) or press for reflection (C) indeed increased in the post-training lesson. They used more questions like "what do you mean by?" , "Why did you do it this way?" or "Who can solve it using another strategy?"

Comparative data indicated that no real gain was accomplished in A7 (informal knowledge) questions. Four teachers never asked such questions either before or after; the other three used them in a very small percentage, compared to other functions of questions. All seven asked their students to rethink or clarify their thinking more often in post-training sessions (B2a questions). Four subjects who had never asked this type of question in their pre-training session used it in a range of 12.8% to 17.7% of the total number of questions during their second videotaped lesson. Percentages increased for the other three teachers as well. All but one teacher used more B4 (inference or interpretation) questions in their post-training sessions compared to their total questions. Interestingly, one teacher who had not used B4 questions in her pre-training had the highest percentage (23.7%) for post-training. As for B5 questions that focus on the meaning behind the actual content had increased slightly in the discourse of six out of the seven teachers.

Although not part of the study's initial agenda, the video transcripts permitted the investigator to report preliminary findings on the identification of a presumably effective, even ideal sequence of consecutive questions. For example, some specific sequences of consecutive questions also appeared related to clinical interview training. Recall of a fact question (A5) or a question supplying information (A6) could be followed by a rethink or interpretation question (B). The investigator examined this sequence and found that it became surprisingly more frequent in post-training sessions, compared with A5/A6 questions not followed by a B question.

CONCLUSION

The study found that teachers' use of questions that shape understanding or press for reflection increased in the post-training lesson. More specifically, questions that asked students to rethink or clarify their thinking, and questions that demanded inference and interpretation had increased the most. Slightly increased were questions that focused on

the meaning behind the actual questions. No change had been discovered in questions that asked students to reveal experience. The sequence of a question that asked to recall facts, followed directly by a question that shaped understanding, was repeated more frequently in the post-training.

With the major role that questions play in shaping classroom thinking environments, professional developers who want to help teachers improve their questioning behaviors may want to consider seriously clinical interview training as a tool to achieve this goal.

References:

- Clement, J. (2000). Analysis of clinical interviews: Foundations and model viability. In A. E. Kelly & R. Lesh (Eds.), *Handbook of research data design in mathematics and science education* (pp. 547-589). Mahwah, NJ: Lawrence Erlbaum.
- Dagher, A. (1999). Innovations in mathematics curriculum and requirements for teacher training. In F. Ayoub (Ed.), *The new curricula in Lebanon: Evaluative review* (pp. 221-254). Beirut: Lebanese Association for Educational Studies.
- Ginsburg, H. P., Jacobs, S. F., & Lopez, L. S. (1998). *The teacher's guide to flexible interviewing in the classroom: Learning what children know about math*. Needham Heights, MA: Allyn & Bacon.
- Haydar, H. N. (2002). *The effect of clinical assessment training on teachers' instructional efficacy* (Doctoral dissertation, Teachers College, Columbia University).
- Hunting, R. P., & Doig, B. A. (1997). Clinical assessment in mathematics: Learning the craft. *Focus on Learning Problems in Mathematics*, 19(3), 29-48
- Kubinski, T. (1980). *An outline of the logical theory of questions*. Berlin: Akademie-Verlag.
- Little, J. W. (1993). Teachers' professional development in a climate of educational reform. *Educational Evaluation and Policy Analysis*, 15(2), 129-51.
- Loos, E. E. (Ed.). (1999). *Glossary of linguistic terms*. www.sil.org/linguistics/GlossaryOfLinguisticTerms
- Morgan, N., & Saxton, J. (1991). *Teaching questioning and learning*. London and New York: Routledge.
- National Council of Teachers of Mathematics. (2000). *Principles and standards for school mathematics*. Reston, VA: NCTM.
- Piaget, J. (1926). *La representation du monde chez l'enfant*. Paris: F. Alcan.
- Sykes, G., & Darling-Hammond, L. (Eds.). (1999). *Teaching as the learning profession: Handbook of policy and practice*. San Francisco: Jossey-Bass.

REDUCING ABSTRACTION: THE CASE OF ELEMENTARY MATHEMATICS

Orit Hazzan, Technion – Israel Institute of Technology

Rina Zazkis, Simon Fraser University

There is a growing interest in the mathematics education community in the notion of abstraction and its significance in the learning of mathematics. "Reducing abstraction" is a theoretical framework that examines learners' behavior in terms of coping with abstraction level. This article extends the scope of applicability of this framework from advanced to elementary mathematics.

The notion of abstraction in mathematics and in mathematical learning has recently received a lot of attention within the mathematics education research community. The significance of this topic, as well as the magnitude of community interest was highlighted at the 2002 PME Research Forum #1. The purpose of this research forum was to discuss and critically compare three theories of abstraction, all aimed at providing a means for the description of the processes involved in the emergence of new mathematical mental structures. The forum was geared towards formulating an integrated theoretical framework that may serve to explain a vast collection of observations on mathematical thinking.

This article examines the notion of abstraction from the perspective of "reducing abstraction" – a mental activity of coping with abstraction. The theoretical framework of reducing abstraction (Hazzan, 1999) is usually associated with advanced mathematical thinking. Here we use it to describe and explain the mathematical thinking of preservice elementary school teachers on topics of elementary mathematics. Our contribution is twofold: (a) we provide a different perspective on the notion of abstraction in the learning of mathematics, and (b) we expand the scope of abstraction theories by focusing on elementary mathematics.

THEORIES OF ABSTRACTION IN MATHEMATICAL LEARNING

Abstraction is a complex concept that has many faces. As such, in a general context it has attracted the attention of many psychologists and educators (e.g., Beth and Piaget, 1966). In the more particular context of mathematics education research, abstraction has been discussed from a variety of viewpoints (cf. Tall, 1991; Noss and Hoyles, 1996; Frorer, Hazzan and Manes, 1997). There is no consensus with respect to a unique meaning for abstraction; however, there is an agreement that the notion of abstraction can be examined from different perspectives, that certain types of concepts are more abstract than others, and that the ability to abstract is an important skill for a meaningful engagement with mathematics.

The aforementioned research forum was assembled in an attempt to explore the variety of interpretations and the multi-faceted nature of abstraction. The theme of reducing abstraction builds on this variety, focusing on learner's mental activities. Similarly to other theories of abstraction, the theme of reducing abstraction, we believe, has “the potential to provide insight into one of the central aspects of learning mathematics and inform instructional practice.” (Dreyfus and Gray, 2002, p.113)

THE THEME OF REDUCING ABSTRACTION

The theme of reducing abstraction (Hazzan, 1999) was originally developed to explain students' conception of abstract algebra. Abstract algebra is the first undergraduate mathematical course in which students “must go beyond learning ‘imitative behavior patterns’ for mimicking the solution of a large number of variations on a small number of themes (problems).” (Dubinsky, Dautermann, Leron and Zazkis, 1994, p. 268). Indeed, it is in the abstract algebra course that students are asked, for the first time, to deal with concepts that are introduced abstractly. That is, concepts are defined and presented by their properties and by an examination of “what facts can be determined just from [the properties] alone.” (Dubinsky & Leron, 1994, p. 42). This new mathematical style of presentation leads students to adopt mental strategies which enable them to cope with the new approach as well as with a new kind of mathematical objects. The theme of reducing abstraction emerged from an attempt to explain students' ways of thinking about abstract algebra concepts. The following description is largely based on Hazzan (1999).

The theme of reducing abstraction is based on three different interpretations of *levels of abstraction* discussed in literature: (a) abstraction level as the quality of the relationships between the object of thought and the thinking person, (b) abstraction level as reflection of the process-object duality, and (c) abstraction level as the degree of complexity of the concept of thought. It is important to note that these interpretations of abstraction are neither mutually exclusive nor exhaustive. What follows is a brief description of each of the above three interpretations.

(a) The interpretation of *abstraction level as the quality of the relationships between the object of thought and the thinking person* stems from Wilensky's (1991) assertion that whether something is abstract or concrete (or on the continuum between those two poles) is not an inherent property of the thing, “but rather a *property of a person's relationship to an object*” (p. 198). In other words, for each concept and for each person we may observe a different level of abstraction that reflects previous experiential connection between the two. The closer a person is to an object and the more connections he/she has formed to it, the more concrete (and the less abstract) he/she feels about it. Since new knowledge is constructed based on existing knowledge, unknown (hence abstract) objects and structures are constructed based on existing mental structures. Based on this perspective, some students' mental processes can be attributed to their tendency to make an unfamiliar idea more familiar or, in other words, to make the abstract more concrete. This is consistent with Hershkowitz, Schwarz and Dreyfus (2001) perspective that emphasizes the learner's role in the abstraction processes. They claim that “abstraction depends on the personal history of the solver”. (p. 197). Specifically, based on Davidov's theory (1972/1990) they claim that “when a new structure is constructed, it already exists in a rudimentary form, and it develops through other structures that the learner has already constructed”. (p. 219). Accordingly, abstraction is defined as “an activity of vertically reorganizing previously constructed mathematics into a

new mathematical structure”. Vertical mathematization is “an activity in which mathematical elements are put together, structured, organized, developed etc. into other elements, often in more abstract or formal form than the originals.” (Hershkowitz, Parzysz and van Dermolen, 1996 in Hershkowitz et al., 2001, p. 203).

(b) The interpretation of *abstraction level as reflection of the process-object duality* is based on the process-object duality, suggested by several theories of concept development in mathematics education (Beth & Piaget, 1966; Dubinsky, 1991; Sfard, 1991, 1992; Thompson, 1985). Some of these theories, such as the APOS (action, process, object and scheme) theory, suggest a more elaborate hierarchy (cf. Dubinsky, 1991). However, for our current discussion it is sufficient to focus on the process-object duality. Theories that discuss this duality distinguish between a *process conception* and an *object conception* of mathematical notions, and, despite the differences, agree that when a mathematical concept is learned, its conception as a process precedes – and is less abstract than – its conception as an object (Sfard, 1991, p. 10). Thus, process conception of a mathematical concept can be interpreted as being on a lower (that is, reduced) level of abstraction than its conception as an object.

(c) The third interpretation of *abstraction level* examines abstraction *by the degree of complexity of the mathematical concept of thought*. For example, a set of elements is a more compound mathematical entity than any particular element in the set. It does not imply automatically, of course, that it should be more difficult to think in terms of compound objects. The working assumption here is that the more compound an entity is, the more abstract it is. In this respect, this interpretation of abstraction focuses on how students reduce abstraction level by replacing a set with one of its elements, thereby working with a less compound object. As it turns out, this is a handy tool when one is required to deal with compound objects that haven't yet been fully constructed in one's mind.

The theme of reducing abstraction has been used for explaining students' conception in different areas of advanced mathematics and in computing science. It was utilized to analyze learners' work in abstract algebra (Hazzan, 1999), differential equations (Raychaudhuri, 2001), data structures (Aharoni, 1999) and computability (Hazzan, in press). These analyses illustrate that a wide range of cognitive phenomena can be explained by one theoretical framework. Here we expand the applicability of the framework by examining reducing abstraction in the area of elementary mathematics.

REDUCING ABSTRACTION IN ELEMENTARY MATHEMATICS

Examples in this section are taken from the work of preservice elementary school teachers in the "Principles of Mathematics for Teachers" course at Simon Fraser University (Canada), which is a core course for certification at the elementary level. Our aim here is to describe teachers' tendencies through the lens of reducing abstraction, rather than to report frequency of occurrence.

(a) Relationships between the object of thought and the learner

This interpretation for abstraction is illustrated by the preservice teachers' tendencies to retreat to the familiar base 10 when asked to solve problems in terms of other bases.

Int: We're in base five now. Can you add 12 and 14 (read: one-two and one-four) in base 5?

Sue: 12 (read: one-two) in base five is what? 7, yea, 5,6,7 and 14 (one-four) would be 9. So together this is 16.

Int: Is this in base 5?

Sue: Oh - no. I have to put this back into base 5. So 10 is 5, and we go 11, 12 (read: one-one, one-two, etc), 13, 14, 20... So I see, 20 is 10, and 30 will be 15 so 16 is 31, three-one base 5.

Different bases are often used in courses for elementary school teachers to reinforce the common algorithms for multi-digit addition and subtraction and to create appreciation for the meaning of "carrying" and "borrowing", rather than to perform these operations automatically following learned rules. However, as the above excerpt illustrates, Sue successfully avoids addition in base 5 by converting back to base 10, performing the operation in base 10 and then calculating the result in base 5. Her solution can be interpreted as reducing abstraction from the unfamiliar base-5-addition to the familiar base-10-addition via conversion, which she achieved by counting and matching.

(b) Process-object duality

This interpretation for abstraction is illustrated by preservice teachers' working with the concept of divisibility.

Int: Consider the following number $3^3 \square 5^2 \square 7$. We'll talk about it a bit, so let's call it M. Is M divisible by 7, what do you think?

Mia: OK, I'll have to solve for M... [pause] Yes, it does.

Int: Would you please explain, what were you doing with your calculator?

Mia: I solved and this, this is 1575, and divided by 7 gives 225. Like it gives no decimal so 7 goes into it.

The tendency of students to calculate rather than attend to the structure of the number as represented in its prime decomposition has been discussed in Zazkis & Campbell (1996). It has been reported that even students who are able to conclude divisibility of M by 7 or 5 based on its structure, tend to calculation when prime non-factors (such as 11) or composite factors (such as 15 or 63) are in question. These students reduce the level of abstraction by considering the process of divisibility, that is, attaining the whole number result in division, rather than the object of divisibility, which indicates a property of whole numbers and is independent of the specific implementation of division.

(c) Degree of complexity of mathematical concepts

The following excerpt is taken from Zazkis & Campbell (1996).

Int: Do you think there is a number between 12358 and 12368 that is divisible by 7?

Nicole: I'll have to try them all, to divide them all, to make sure. Can I use my calculator?

Int: Yes, you may, but in a minute. Before you do the divisions, what is your guess?

Nicole: I really don't know. If it were 3 or 9, I could sum up the digits. But for 7 we didn't have anything like that. So I will have to divide them all.

Nicole exhibits a common tendency – she wishes to find a number divisible by 7 between the two given numbers in order to claim its existence. The task invites her to consider the interval of ten numbers; however, Nicole prefers to consider and check for divisibility of each number separately. In doing so she is considering a particular object, a number, rather than a more complex object, a set or interval of numbers. Therefore, the abstraction level is reduced: a property of a set of elements is being examined one by one, rather than a property of the set as a whole.

(d) Multifaceted examination from the perspective of reducing abstraction

As mentioned earlier, the classification of ways in which learner's reduce abstraction is neither exhaustive nor mutually exclusive. Consider for example the following problem:

A length of 3 cm on a scale model corresponds to a length of 10 meters in a park. A lake in the park has an area of 3600 square meters. What is the area of the lake in the model?

In her solution, Brenda assigned the dimensions 90×40 to the lake, converted each length separately and then calculated the area of lake in the model. Some of her classmates considered the lake to be a 36×100 rectangle or a 60×60 square. For most students, the random assignments of units and even the random restriction of the lake shape to either a square or a rectangle, still led students to a correct answer. However, no one could explain why the final calculation of the area was not influenced by the choice of shape and measurements.

The task in this example was geared at testing students' abilities to perform the conversion of square units. Regression to the units of length can be interpreted as reducing abstraction in several ways: In accordance with section (c), the assignment of units of lengths provides learners with a lesser degree of complexity. That is, it provides an opportunity to deal with one particular object rather than with *any* object of a given area. In accordance with section (a), the measures of lengths could have been perceived as more familiar, and therefore less abstract, than the measures of area. In accordance with section (b), the calculation of area can be interpreted as students' conception of area as a process, rather than as an object that assigns a measure to a shape.

Noss & Hoyles (1996) state that “[t]here is more than one kind of abstraction.” (p. 49). Consequently, as the above examples illustrate, there is more than one way to reduce the level of abstraction and more than one way to describe a learner's activity in terms of reducing abstraction level.

CONCLUSION

Schoenfeld (1998) proposed four major criteria for judging theories and models that embody them: descriptive power, explanatory power, predictive power and scope of applicability. The theory of reducing abstraction meets each of these standards. It provides a lens for describing, explaining and predicting students' encounters with a wide variety of topics and concepts. This article has extended the scope of its applicability from the content domains of advanced mathematics and computing science to elementary mathematics. We conclude by inviting the readers to examine their own observations of learners' mathematical encounters through a lens of reducing abstraction.

References

- Aharoni, D. (1999). *Undergraduate Students' Perception of Data Structures*, Ph.D. thesis, Technion – Israel Institute of Technology.
- Beth, E. W. and Piaget, J. (1966). *Mathematical Epistemology and Psychology*, D. Reidel Publishing Company.
- Davydov, V. V. (1990). *Soviet studies in mathematics education: Vol. 2. Types of generalization in instruction: Logical and psychological problems in the structuring of school curricula* (J. Kilpatrick, Ed., & J. Teller, Trans.). Reston, VA: National Council of Teachers of Mathematics. (Original work published in 1972).
- Dreyfus, T. and Gray, E. (2002). Research Forum 1 - Abstraction: Theories about the emergence of knowledge structures. In A.D. Cockburn and E. Nardi (Eds.). *Proceedings of the 26th Conference of International Group for the Psychology of Mathematics Education*, University of East Anglia, Vol. I, pp. 113-138.
- Dubinsky, E. (1991). Reflective abstraction in advanced mathematical thinking. In Tall, D. (ed.). *Advanced Mathematical Thinking*, Kluger Academic press, pp. 95-123.
- Dubinsky, E. and Leron, U. (1994). *Learning Abstract Algebra with Isetl*, Springer-Verlag.
- Dubinsky, E., Dautermann, J., Leron, U. and Zazkis, R. (1994). On learning fundamental concepts of group theory, *Educational Studies in Mathematics* **27**, pp. 267-305.
- Froer, P., Hazzan, O. and Manes, M. (1997). Revealing the faces of abstraction, *The International Journal of Computers for Mathematical Learning* **2**(3), pp. 217-228.
- Hazzan, O. (1999). Reducing abstraction level when learning abstract algebra concepts. *Educational Studies in Mathematics* **40**(1), pp. 71-90.
- Hazzan, O. (in press). Reducing abstraction when learning computability theory, *Journal of Computers in Mathematics and Science Teaching (JCMST)*.
- Hershkowitz, R., Schwarz, B. B. & Dreyfus, T. (2001) Abstraction in context: Epistemic actions. *Journal for Research in Mathematics Education* **32**, pp. 195-222.
- Hershkowitz, R., Parzysz, B. And van Dermolen, J. (1996). Space and shape. In A. J. Bishop, K. Clements, C. Keitel, J. Kilpatrick & C Laborde (eds.), *International Handbook of Mathematics Education*, Vol. I, pp. 161-204, Dordrecht, The Netherlands: Kluwer.
- Noss, R. and Hoyles, C. (1996). *Windows on Mathematical Meanings—Learning Cultures and Computers*, Kluwer Academic Publishers.
- Raychaudhuri, D. (2001). *The Tension and the Balance between One Mathematical Concept and Student Constructions of It: Solution to a Differential Equation*, Ph.D. thesis, Simon Fraser University, Vancouver, Canada.

- Schoenfeld, A. (1998). On theory and models: The case of teaching-in-context. In S. Berenson, K. Dawkins, M. Blanton, W. Coulombe, J. Kolb, K. Norwood and L. Stiff (Eds.), *Proceeding of the 20th Annual Meeting of the North American Chapter of the International Group for the Psychology of Mathematics Education*, (pp. 27-38). Raleigh, NC: North Carolina State University.
- Sfard, A. (1991). On the dual nature of mathematical conceptions: Reflections on processes and objects as different sides of the same coin. *Educational Studies in mathematics* **22**, pp. 1-36.
- Sfard, A. (1992). Operational origins of mathematical objects and the quandary of reification - The case of function. In Dubinsky, E. and Harel, G. (eds.). *The Concept of Function - Aspects of Epistemology and Pedagogy*, MAA Notes.
- Tall, D. (1991, ed.). *Advanced Mathematical Thinking*, Kluwer Academic press.
- Thompson, P. W. (1985). Experience, problem solving, and learning mathematics: Considerations in developing mathematics curricula. In E. A. Silver (ed.). *Teaching and Learning Mathematical Problem Solving: Multiple Research Perspective*, Hillsdale, NJ, pp. 189-236.
- Wilensky, U. (1991). Abstract meditations on the concrete and concrete implications for mathematical education. In I. Harel, and S. Papert (eds.), *Constructionism*, Ablex Publishing Corporation, Norwood, NJ, pp. 193-203.
- Zazkis, R. & Campbell, S. (1996). Divisibility and Multiplicative Structure of Natural Numbers: Preservice teachers' understanding. *Journal for Research in Mathematics Education*, *27*(5), 540-563.

Page Intentionally Left Blank

THE EFFECT OF A SIMCALC CONNECTED CLASSROOM ON STUDENTS' ALGEBRAIC THINKING

Stephen J. Hegedus
University of
Massachusetts Dartmouth

Jim Kaput
University of
Massachusetts
Dartmouth

We report the findings of an empirical analysis of the performance of a group of middle and high school students before and after an after-school algebra enrichment program using the SimCalc software incorporating classroom networks. The results highlight statistically significant gains in their learning and briefly outline contributing factors of the innovation that gave rise to such improvement.

CONTEXT

The long-term goal of the SimCalc project has been to democratize access to the Mathematics of Change and Variation (MCV) (Kaput, 1994) especially algebraic ideas underlying calculus (Kaput & Roschelle, 1998) using a combination of new representations, links to simulations and new curriculum materials for grades 6-13. The software enables students to interact with animated objects whose motion is controlled by visually editable piece-wise or algebraically defined position and velocity functions. One form of the software has been developed for the TI-83+ (Calculator MathWorlds) and the other is a cross-platform Java application (Java MathWorlds) which exploits higher screen resolution, with the ability to pass MathWorlds documents between the two platforms – see <http://www.simcalc.umassd.edu> for further details.

Present work has studied the integration of various kinds of connectivity with the SimCalc environment that enable new and intense forms of social interaction and learning possibilities. Recent studies (Kaput & Hegedus, 2002) reported the affordances of newly emerging connectivity technology that allows teachers to distribute and collect students' work across diverse platforms from hand-held devices, such as the TI-83+ graphing calculator, to desktop computers. Since this earlier work, we have expanded the design space of classroom connectivity to include the passing and sharing of students' individual constructions between computers using standard Internet protocols. The development of a dedicated Java MathWorlds (JMW) server has allowed students to send their individual work from within JMW to the teacher who can aggregate and then display their work on a single coordinate system.

Utilizing this new connectivity/aggregation ingredient, we developed a 5-week after-school algebra enrichment program for local middle and high school students in a standard school computer lab. This paper examines their mathematical performance gains.

THEORETICAL BACKGROUND

The capabilities of classroom connectivity has not merely enhanced the management of information flow in the classroom, but more powerfully, changed the nature of MCV learning activities. We have begun to document activity structures (Hegedus & Kaput, 2002) that give rise to mathematically deep and socially intense learning where students'

personal constructions become part of shared mathematical objects as their work visibly participates in those aggregated objects. The social structure of the classroom plays a direct role in the structuring of mathematical activities, and vice-versa in a dialectical fashion. Students, organized into groups, build functions that vary parametrically across the groups as well as within groups, yielding structured families of functions reflecting the directly experienced social structure of the classroom. This epistemologically elevates the organizational structure of the mathematical objects, from functions to families of functions. In doing this, students construct parts of a mathematical whole and so the focus of their attention is on the relations between their individual contribution and the whole. Thus, students' personal identities are intimately involved in their building and sharing of mathematical objects in the public space of the classroom. The main aim of this paper is to show that classroom connectivity not only offers new and exciting pedagogical opportunities for teachers but it can significantly improve students' performance in core algebra topics over a short period of time.

THE SET-UP OF OUR CONNECTED SIMCALC CLASSROOM

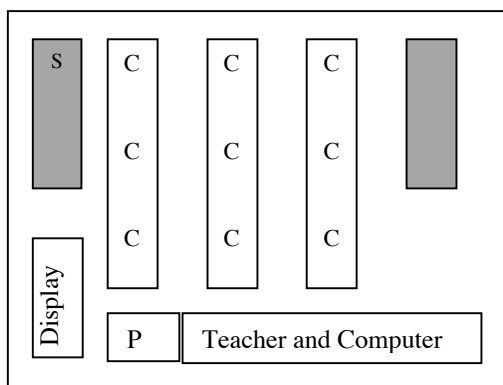

Figure 1. Classroom Set-up

During the course of our intervention, the class met after school in a dedicated computer lab. Figure 1 illustrates schematically the classroom set-up with a large amount of activity occurring around the whiteboard (Display) where the teacher computer was displayed. Two rows of computers (shaded) were used for other school purposes except for one computer (S) dedicated to running the SimCalc Server application. Four rows of computers (16 computers) were used, usually with 2 students to a computer (C). The classroom set-up was traditional in its layout with rows of computers, making

interaction and classroom discussion logistically difficult in contrast to networks of personal hand-helds. The focus of our attention here is on the students rather than the teacher – a novice SimCalc teacher who received regular direction from us.

Our key innovation was to incorporate a unique identifier for each student into the new connected classroom activities. Each student was assigned a 4-digit number, which resonated the physical group set-up of the classroom. The first two digits specified their group number (established by which row of computers they were in for example) and the last two digits specified their count-off number in their group. This 4-digit number served as a natural variant, which mapped to the parametric variation within the mathematical activities. For example, a now standard introductory task in our work requires each student to construct a motion by visually or algebraically editing position-time graph segments to make their screen object travel at 3 feet per second for 5 seconds but *starting at their group number*. When each student's work is aggregated, the teacher can display a naturally emerging family of functions (a set of parallel functions – see Figure 2) and begin to discuss the variation across the graphs in terms of the variation across the groups.

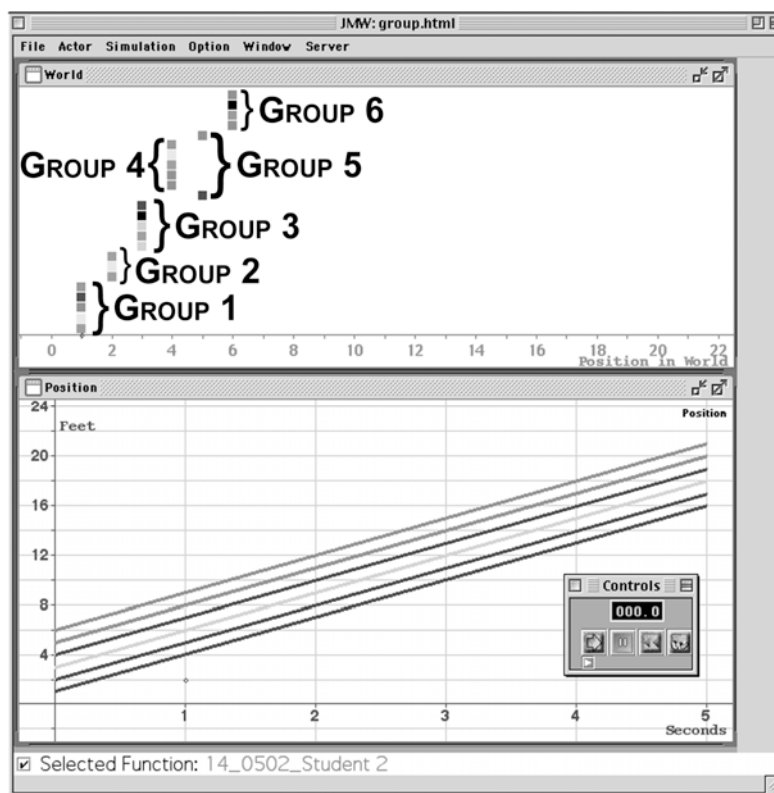

Figure 2. Class Aggregation in Java MathWorlds

Overlap occurs in the position-time graphs since each group contains several students, but each student is distinguished by a unique square dot in the upper half of the screen (“the World”). Clicking on a dot displays the student’s name in the lower left part of the window (this can be deselected to provide anonymity). Animating the group motion leads to all the dots moving synchronously in the world, but offset in side-by-side groups as in a parade. Based on projection of the teacher’s computer onto a classroom display, class discussion centers on who is where and why, and why the motion and graph configurations appear as they do. Students are also asked to produce a generic formula for the entire group, for this example, $Y=3X+B$ where B is the group number. An additional feature of the SimCalc software is a Matrix window, which displays all work retrieved from the students and allows the teacher to hide/show students’ graphs, dots and other representational features of the motion. In addition, and more importantly, the teacher can sort dots by group or count-off number, thus displaying groups of dots which naturally correspond to groups of students. Here, the students’ identities are projected into an organized aggregate structure, which resonates with the structure of the mathematics. In addition, the dynamic feature of the SimCalc environment enables a motion-representation of the generic formula and the role of the parameters M and B – via the parallel motion and offset starting positions. The parallelism of the linear functions is represented in the *parade-like motion* of the group!

In later activities, we systematically vary the role of *both* group and count-off number in increasingly more rich and complex tasks dealing with core algebra topics, such as slope

as rate, linearity, parametric variation and systems of equations. A more detailed account of our intervention triangulating our empirical work with our observational data can be found in Hegedus & Kaput (in review). Following our intervention fusing the SimCalc environment and classroom connectivity with these and many more related activities, we saw significant gains in student performance. We now report our testing methodology and empirical results.

PRE-POST TEST METHODOLOGY

In order to measure changes in students' understanding of the core algebra ideas attended to in our intervention, we administered a 20-item pre-post test comprised of 12 questions from the 10th grade 2001 state (Massachusetts) exams, 1 Advanced Placement Calculus item and 7 questions selected from a pool of items developed by the SimCalc Project and refined over several years. Fourteen of the questions were multiple choice and the remaining items were short answer or open-response. Some of the questions were not directly addressed in our intervention and served as face-validity items that assessed whether more general algebraic skills were developed during the intervention. Twenty-five students from our original group of 38 completed the course. The scores of 24 of these students were used in our statistical analysis, as one student did not complete the pre-test. Those students not completing the course were not statistically different (mean=0.430, variance=0.019, n=13) in their achievement on the pre-test from the final sample used for pre-post test comparison (mean=0.427, variance=0.019, n=24).

We adopted the rubric for the MCAS open-response item (4 points) and combined it with the other multiple-choice questions and SimCalc items (scored between 2 and 4 points) to total a test score of 31 points. The test items were comparable in difficulty and passed a test for internal consistency reliability ($\alpha=0.71$) for its use as a pre-post-test measure. The pre and post-tests were scored by two markers. A high interrater coefficient ($r = 0.80$) was obtained and a third marker was used in collaboration with the other two markers to obtain the final results.

DATA RESULTS AND ANALYSIS

We aimed to show that any change in student's performance was mainly caused by our intervention of the connected SimCalc classroom and not necessarily the social or academic demographics of the participants or other indirect variables. To this aim, we present our results, which separate out the performances of 2 different subgroups and the performance on individual items combining various statistical procedures and measures of gain. Our middle school students were higher achievers (as described in their mean scores). Our high school students were low achievers, with low proficiency levels (average 218) on recent 8th grade state examinations. The five-week teaching experiment had a positive effect on the mathematical behavior of both groups of students as presented in Table 1.

We used a paired Student's t-Test to measure the significance of the difference in the groups mean scores. A paired test was suitable given a high correlation coefficient between their pre/post-test scores (0.78) as well as the two groups being identical and the same test being used to measure the effect of the intervention.

Group	n	Pre Test		Post Test		Cohen's <i>d</i> effect	<i>Hake's Gain</i>	<i>p</i>
		Mean	SD	Mean	SD			
All	24	42.7%	0.141	65.9%	0.149	1.60	0.42	0.0001
7 th & 8 th	10	52.2%	0.092	76.8%	0.123	1.78	0.5	0.0001
9 th	14	37.7%	0.158	62.0%	0.136	1.91	0.36	0.0001

Table 1. Pre- and Post-Test Results

In addition, a parametric test was used given that the students were selected from a large population and had varying mathematical abilities. This was confirmed using a normality test¹. The results show a statistically significant increase ($p < 0.05$) in both the mean scores as a group, as well as by age group. Even though the group of grade 7 & 8 students ($n=10$) showed higher test averages than the grade 9 students ($n=14$) the latter group yielded a higher effect size of 1.91 standard deviations. In both groups, the effect size was extremely high. This illustrates that while the 5-week session had a very positive effect on both groups it appears that there was a more positive effect on the 9th grade students. Our concern was with the difference in both age groups both in background and prior knowledge. How much of this gain was due to prior knowledge? To attend to this question, we used Hake's gain statistic – an average normalized gain – which related mean gain relative to original performance, i.e. $\text{Gain} = \frac{\langle \text{Post} \rangle - \langle \text{Pre} \rangle}{1 - \langle \text{Pre} \rangle}$ where the angled brackets represent mean scores. Hake studied over 6000 diagnostic tests of physics undergraduates in reform- vs. traditional-based classrooms (Hake, 1998) observing higher gain scores (> 0.4) for reform-based classrooms. Hake's work and other studies indicate that this statistic is related to students' growth in a more cognitive sense (McGowen & Davis, 2001; Hake, 1998). Table 1 highlights how, while our group of 9th graders had a greater effect size, our group of 7th and 8th graders had a greater gain (0.5) relative to their performance on the pre-test. We calculated an individual Hake's gain statistic for each student for two purposes. First, we calculated how their increase in performance from pre to post test related to their prior knowledge by correlating their individual Hake's gain statistic with their pre-test scores. There was insignificant correlation for both the middle school students ($r=0.09$) and our high school group ($r=0.12$) highlighting that instruction was at the right level for students who have an average or little prior knowledge of the subject as judged by the pre-test score. This was an important find for us in establishing that gain in our non-standard classroom was mainly based on our intervention rather than student background given that we had a mixture of students of varying educational performance, of varying exposure to the core mathematical ideas we were attending to, as well as ages.

¹ To test whether the samples were from a Gaussian distribution we used the method of Kolmogorov and Smirnov.

Test Item	Type	Pre-Test		Post-Test		<i>p</i>
		Mea	SD	Mea	SD	
1	Direct linear extrapolation. Interpreting straightness qualitatively. Unit conversion	0.333	0.482	0.667	0.482	0.0195
2	Modeling. Reading graphs with zero starting	0.917	0.282	0.875	0.338	>0.999
3	Algebraic modeling of linear quantities with non-zero starting values	0.833	0.380	1	0	n/a
4	Concept of averaging. Unit conversion. End point analysis	0.333	0.482	0.417	0.504	0.547
5	Graphical interpretation. Comparing starting & ending point differences.	0.458	0.509	0.917	0.282	0.001
6	Co-linearity. Interpretation as slope	0.333	0.482	0.458	0.509	0.375
7	Linear extrapolation. Multiplicative reasoning	0.792	0.415	0.833	0.381	0.813
8	Attention to labels and scales. Unit conversion.	0.667	0.482	0.875	0.338	0.109
9	Reading graphs	0.750	0.442	0.875	0.338	0.313
10	Interpreting Pi as a coefficient	0.333	0.482	0.875	0.338	0.0002
11	Point-wise interpretation of graph to obtain two varying quantities. Graphical construction	0.583	0.504	0.625	0.495	0.820
12	Slope as rate. Interpretation of velocity (SC; OR4pt)	1.917	0.583	2.958	1.367	0.002
13	Slope as rate, Change of sign (slope) (AP)	0.542	0.509	0.583	0.504	0.813
14	Concept of rate. Multiplicative reasoning (SC, SA2pt)	0.750	0.676	1.792	0.588	<0.001
15	Slope as rate. Average. (SC, SA2pt)	0.125	0.338	0.208	0.509	0.491
16	Slope as rate attending to scales (SC)	0.333	0.482	0.833	0.381	0.0005
17	Concept of rate with divisors. Non-standard. (SC)	0.417	0.504	0.625	0.495	0.206
18	Algebraic expression of real-life varying quantities. Interpreting the y-intercept	0.750	0.847	2.042	1.233	<0.001
19	Determining slope from value. Concept of families of functions (parametric variation) (SC, OR4pt)	0.625	0.824	1.167	0.637	0.0012
20	Algebraic and geometric reasoning. Interpretation of real-life scenarios. Systems of equations.(MCAS,OR4pts)	1.458	1.141	1.792	1.103	0.148

Table 2. Item-by-item analysis

We also conducted an item-by-item analysis to assess which questions and corresponding content and skills contributed to the increase in performance for the group. Table 2 highlights the mean scores from pre- to post-test as well as content areas for each question, where “SA” denotes short answer and “OR”, open-response questions. The remainder are multiple-choice. All questions are from the 2001 State examination unless stated; SimCalc (SC), Advanced Placement (AP). We conducted a Wilcoxon matched-pairs test for multiple-choice items (binary response) and paired Student’s t-test for short answer and open response questions. We highlight 8 items of statistically significant gain ($p < 0.05$). One ceiling-effect item (3) could not be tested.

The highlighted items in Table 2 outline a genre of skills, which were mainly consonant with our original aims for the course. They involve interpretation of graphs, understanding of slope as rate, interpreting $Y=MX+B$ and how varying the parameters M and B vary graphical views, linearity, interpreting slope in real-life situations (e.g., (constant) velocity as slope of linear position-time graphs), and, most significantly, to generate and interpret *families* of linear functions from parametrically varying M and B . Curiously, we had not originally intended to concentrate on graphical interpretation, especially for non-motion based scenarios, and we believed our intervention had not concentrated on such a skill, yet the overall performance of the group on such tasks (items 1, 5, 10, 12) led us to believe that there was something implicit in our instruction and the connected classroom set-up that enabled students to continually reflect on the graphs they created (both algebraically and visually). We cannot include the whole test but a full version is available on-line at the SimCalc website², however we wish to present two of these questions which serve as face-validity items to strengthen our claim that a connected SimCalc classroom has a positive effect on students' learning. The students scored significantly higher on the post-test for item 5. Their pre-test performance was very similar to the mean scores for the high school (45.0%) the previous year as well as the State overall mean score (46.0%). This item required students to interpret and compare non-linear graphs of varying enrollment figures of three clubs over time. Here students must determine end-point differences and interpret the results as quantities.

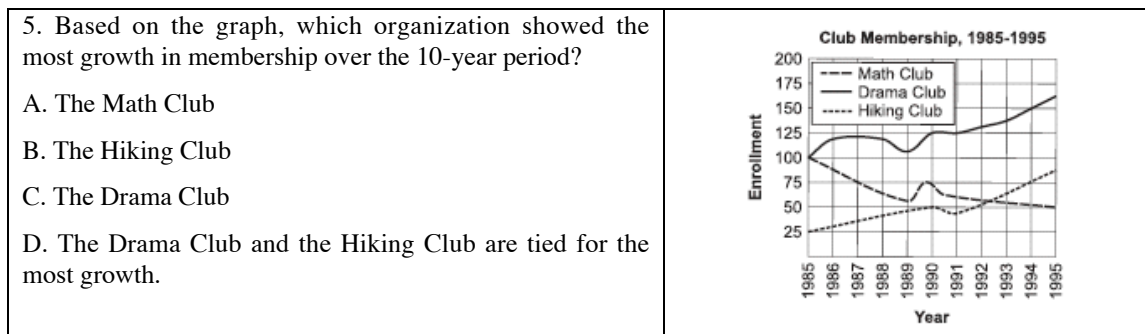

Figure 3. Item 5

The second face-validity item we wish to highlight is item 10, which shows the most significant increase given that on the pre-test the students performed the same as the high school (34%) and the state (33%), which was quite poor, and excelled on the post test (87.5%). Furthermore, the question required the students to interpret a non-standard algebraic relationship of two geometric quantities. Our intervention had predominantly used standard algebraic notation (i.e. $Y=MX+B$) or some incorporation of identifiers (e.g. count-off/group numbers) into the parameters M and/or B .

<p>10. The circumference, C, of a circle is found by using the formula $C = \pi d$, where d is the diameter. Which graph best shows the relationship between the diameter of a circle and its circumference?</p>
--

² <http://www.simcalc.umassd.edu/NewWebsite/pretest.html>

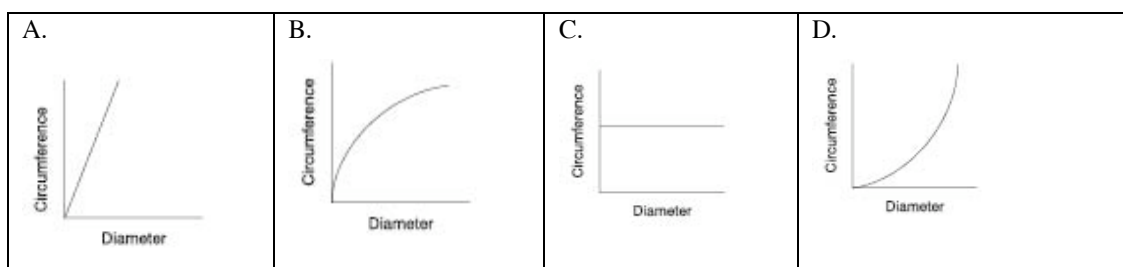

Figure 4. Item 10

CONCLUSION

It is our primary claim that in combining the dynamic SimCalc environment with classroom connectivity we can significantly improve students' performance on 10th grade MCAS algebra-related questions in a short period of time. Even though we had a non-standard mixture of students, our analysis has shown that all our students performed better relative to their prior knowledge, which in some cases was little or none, on questions involving core algebraic ideas. We believe that classrooms which integrate dynamic software environments with connectivity technology can dramatically enhance students' engagement with core mathematics beyond what we thought possible in the absence of such support. Further work is needed, both to explain such enhancement and to exploit it.

References

- Hake, R. R. (1998) Interactive-engagement vs traditional methods: A six-thousand-student survey of mechanics test data for introductory physics courses. *American Journal of Physics*, 66, 64-74.
- Hegedus, S. & Kaput, J. (2002). Exploring the phenomena of classroom connectivity. In D. Mewborn & L. Hatfield (Eds.), *The Proceedings of the 24th Annual Meeting of the North American Chapter of the International Group for the Psychology of Mathematics Education (Vol. 3)*. Columbus, OH: The ERIC Clearinghouse for Science, Mathematics, and Environmental Education.
- Hegedus, S. & Kaput, J. (in review). Improving algebraic thinking through a connected SimCalc classroom. Submitted to *Journal for Research in Mathematic Education*.
- Kaput, J. J. (1994). Democratizing access to Calculus: New routes using old routes. In A. Schoenfeld (Ed.). *Mathematical thinking and problem solving* (pp. 77-156). Hillsdale, NJ: Lawrence Erlbaum.
- Kaput, J. J. & Roschelle, J. (1998). The mathematics of change and variation from a millennial perspective: New content, new context. In C. Hoyles, C. Morgan, & G. Woodhouse (Eds.), *Rethinking the mathematics curriculum* (pp. 155–170). London: Springer-Verlag.
- Kaput, J. & Hegedus, S. (2002). Exploiting classroom connectivity by aggregating student constructions to create new learning opportunities. In A. D. Cockburn, & E. Nardi (Eds.) *Proceedings of the 26th Conference of the International Group for the Psychology of Mathematics Education*. Vol3, pp.177-184
- McGowen, M. and Davis, G. (2001). What mathematical knowledge do pre-service elementary teachers value and remember? In R. Speiser, C.A. Maher & C. N. Walter (Eds.) *Proceedings of the XXIII Annual Meeting of the North American Chapter of International Group for the Psychology of Mathematics Education, Vol. 2*, 875-884.

“SPONTANEOUS” MENTAL COMPUTATION STRATEGIES

Ann M. Heirdsfield

Centre for Mathematics and Science Education, QUT, Australia

The focus of this study was to investigate mental computation conceptual frameworks that Heirdsfield (2001c) formulated to explain the difference between proficient (accurate and flexible) mental computers and accurate (but not flexible) mental computers. A further aim was to explore the potential for students' developing efficient mental strategies.

INTRODUCTION

Mental computation is defined as “the process of carrying out arithmetic calculations without the aid of external devices” (Sowder, 1988, p. 182). Literature at national and international levels argues the importance of including mental computation in a mathematics curriculum that promotes number sense (e.g., Maclellan, 2001; McIntosh, 1998; Reys, Reys, Nohda, & Emori, 1995). International research (e.g., Blöte, Klein, & Beishuizen, 2000; Buzeika, 1999; Hedrén, 1999; Kamii & Dominick, 1998) has focussed on children formulating their own mental computation strategies in the belief that when children are encouraged to do so, they learn how numbers work, gain a richer experience in dealing with numbers, develop number sense, and develop confidence in their ability to make sense of number operations. A common thread to this research has been valuing students' strategies, promoting strategic flexibility, and encouraging student discussion. One difference between the European (in particular, Dutch and German work) and American and New Zealand work is that models (e.g., Empty Number Line) are used as representations for mental computation in European classrooms. These do not feature as much in the other classrooms (although Thornton, Jones, & Neal (1995) advocated the use of the hundreds chart for supporting mental computation). While these studies are supported by a constructivist approach, there is some support for a behaviorist approach to teaching mental computation (e.g., Morgan, 2000). Morgan suggested teaching mental computation strategies in a sequential fashion. However, the sequence does not take into consideration number combinations, merely strategies. That is, a sequence of strategies is introduced over the seven years of primary school, regardless of the numbers involved. Some of this sequencing is based on the sequential teaching of written algorithms; however, this sequence is not theoretically based. Although, Morgan (2000) does conclude, “The emphasis needs to remain on students exploring, discussing, and justifying their mental strategies, as well as their solutions.” Currently, in Queensland (Australia), whether children should be taught computational strategies or whether they should develop their own is being addressed while the new curriculum is being developed.

In Australia, the inclusion of mental computation in the curriculum is a recent phenomenon. In the Queensland context, there has been some research into mental computation, for example, a five-year longitudinal study identified children's mental computation strategies, and tracked changes in strategy use (e.g., Cooper, Heirdsfield, & Irons, 1996; Heirdsfield, Cooper, Mulligan, & Irons, 1999; Heirdsfield, 1999). Further research (Heirdsfield, 1996) identified some cognitive factors that were associated with proficient mental computation (flexible use of efficient strategies and accuracy) in Year 4 children (approximately 9 years old): proficient number facts (speedy recall and efficient number fact strategies) and proficient estimation. This study raised further questions about other factors that appeared to be associated with mental computation. Thus, the focus of a further study was the identification of cognitive, metacognitive, and affective factors that might be associated with mental computation (Heirdsfield, 1998, 2001a, 2001b, 2001c; Heirdsfield & Cooper, 2002). For the purposes of identifying flexibility, mental computation strategies were classified using a scheme (based on Beishuizen, 1993; Cooper, Heirdsfield, & Irons, 1996; Reys, Reys, Nohda, & Emori, 1995) that divided

strategies into the following categories: (1) *separation* (2) *aggregation* (3) *wholistic* and (4) *mental image of pen and paper algorithm* (see Table 1).

Strategy		Example	
<i>Separation</i>	<i>right to left (u-1010)</i>	28+35: 8+5=13, 20+30=50, 52-24: 12-4=8, 40-20=20, 28 (subtractive); 4+8=12, 20+20=40, 28 (additive)	63
	<i>left to right (1010)</i>	28+35: 20+30=50, 8+5=13, 52-24: 40-20=20, 12-4=8, 28 (subtractive); 20+20=40, 4+8=12, 28 (additive)	63
	<i>cumulative sum or difference</i>	28+35: 20+30=50, 50+8=58, 52-24: 50-20=30, 30+2=32, 32-4=28	58+5=63
<i>Aggregation</i>	<i>right to left (u-N10)</i>	28+35: 28+5=33, 52-24: 52-4=48, 48-20=28 (subtractive); 24+8=32, 32+20=52, 28 (additive)	33+30=63
	<i>left to right (N10)</i>	28+35: 28+30=58, 52-24: 52-20=32, 32-4=28 (subtractive); 24+20=44, 44+8=52, 28 (additive)	58+5=63
<i>Wholistic</i>	<i>compensation</i>	28+35: 30+35=65, 52-24: 52-30=22, 22+6=28 (subtractive); 24+26=50, 50+2=52, 26+2=28 (additive)	65-2=63
	<i>levelling</i>	28+35: 52-24: 58-30=28 (subtractive); 22+28=50, 28 (additive)	30+33=63
<i>Mental image of pen and paper algorithm</i>		Student reports using the method taught in class, placing numbers under each other, as on paper, and carrying out the operation, right to left.	

Table 1. Mental Strategies for Addition and Subtraction

Conceptual frameworks were developed to explain the differences in particular types of mental computers (Heirdsfield, 2001a, c). The findings of this study showed that Year 3 students who were proficient in mental computation (accurate and flexible) exhibited strategic flexibility, dependant on the number combinations of the problems. It was posited that an integrated understanding of mental strategies, number facts, numeration, and effect of operation on number supported strategic flexibility (and accuracy). Moreover, this cohort of students also exhibited some metacognitive strategies, possessed reasonable short-term memory and executive functioning, and held strong beliefs about their self developed strategies. Blöte, Klein, and Beishuizen (2000) also considered associated cognitive, metacognitive, and affective factors in their research into mental computation and conceptual understanding. Further, Maclellan (2001) posited that mental computation was situated in a richly connected web.

Where students exhibited less knowledge and fewer connections between knowledge, Heirdsfield (2001c) found that students compensated in different ways, depending on their beliefs and what knowledge they possessed. For instance, students who had sufficient knowledge to support the ability to compute mentally (although not necessarily efficiently) generally held strong beliefs about teacher taught strategies, and used these strategies to successfully obtain answers to mental computations. These students were identified as being inflexible, that is, they employed a single strategy, *mental image of pen and paper algorithm*.

It has been argued elsewhere (Brown & Palincsar, 1989) that an aspect of a study of “knowing” should address Vygotsky’s zone of proximal development (ZPD) (Vygotsky, 1978). Vygotsky claimed that a child’s level of development cannot be understood unless both the child’s actual developmental level (determined by independent activity) and potential developmental level (determined by guidance provided to the child) were established. The zone of proximal development is the “distance between the actual developmental level . . . and the level of potential development” (Vygotsky, 1978, p. 86). Children at the same actual level of development may have different zones of proximal development. Van der Heijden (1994) used a Vygotskian approach to investigate mental addition and subtraction of primary school children. Vygotsky’s ZPD was considered an important aspect of qualitative assessment of children’s mental addition and subtraction proficiency, defined by speed, accuracy and efficient strategy use. Pre-determined scaffolding questions were presented to children who

did not employ what was considered efficient mental procedures. Results indicated that students possessed a considerable potential for efficient strategies, they generally agreed that the efficient strategy was easier.

In Heirdsfield's study (2001c), it was found that most students possessed the potential to use efficient strategies, as evidenced by their ability to access alternative strategies (although not always through to successful completion). This concurred with the findings of Van der Heijden (1994), but the finding of students in Heirdsfield's study preferring their first strategy (not always the more efficient strategy they accessed) was in contrast to that of Van der Heijden.

Another factor in mental computation research and teaching is how to assess mental computation. Some researchers and teachers accept that mental computation is important in the curriculum, but fail to see it in the bigger sense – as a means to develop number sense by actively engaging in the construction of efficient and economical strategies, which make use of number understanding. If the goal of involving students in mental computation is to improve their reasoning and thinking, then traditional tests cannot assess students' understanding, merely whether they can calculate in their heads. It has been shown that there are students who possess little number sense, yet they are "successful" (in terms of arriving at the correct answer) on mental computation tests (e.g., Heirdsfield, 1996, 2001b, c; Heirdsfield & Cooper, 2002; McIntosh & Dole, 2000). These tests often take the form of directing students to solve problems mentally and write down the answer or say the answer without explaining their strategies. Unfortunately, some teachers in Australia have mistaken the term, *mental computation* for an out dated term used in the sixties (and before), *mental arithmetic* (Morgan, 1999). Lessons in mental arithmetic were "characterised by a series of short, low-level unrelated questions to which answers are quickly calculated, recorded, and marked." (Morgan 2000). Thus, the emphasis in mental arithmetic was testing, rather than teaching/learning.

The focus of the study reported here was to further investigate the conceptual frameworks that Heirdsfield (2001c) developed for accurate mental computation, both flexible and inflexible (cognitive, metacognitive and affective factors) in Years 3 and 4 students (8, 9, and 10 year olds), and to further explore the potential of students' developing more efficient mental strategies.

METHOD

The research project was essentially *qualitative* in nature, with a focus on developing case studies (Denzin & Lincoln, 2000). One-on-one structured and semi-structured clinical interviews were used to explore flexibility, identify associated factors, and probe the potential for students to develop efficient mental strategies.

Participants

The participants were eight Year 3 students (8 and 9 year olds) and eight Year 4 students (9 and 10 year olds) who attended a Brisbane school that served a middle socioeconomic area. The students were selected from a cohort of forty-one Year 3 students (4 classes) and thirty-three Year 4 students (3 classes) (selected by teachers as being reasonably proficient in mathematics), on the basis of accuracy in structured selection mental computation interviews. They were able to complete successfully at least 80% of the addition tasks in the selection interview (subtraction examples were generally less successfully solved than addition examples). In Year 4, four flexible students and four inflexible students were selected for further indepth interviews; while in Year 3, six flexible students and two inflexible students were selected for indepth interviews (only 2 inflexible and accurate students could be identified in Year 3 – all other flexible students were flexible).

Instruments

The instruments were adapted from previously developed instruments (Heirdsfield, 2001c), and then modified and extended for the two year levels (previously the instruments addressed Year 3 only). The instruments

consisted of: *a structured selection interview* - one-, two-, and three-digit addition and subtraction mental computation items, presented in picture form, while the question is verbally presented to the student (e.g., “What is the total cost of the two computer games?” - \$68 and \$31); *a series of semi-structured indepth interviews to investigate factors associated with mental computation* – focusing on strategies for mental addition and subtraction (different from but similar to the selection items), number facts, numeration, effect of operation on number, computational estimation, metacognition, affects, and classroom context. While many of the tasks for Year 3 were repeated for Year 4 students, some were made more appropriate for Year 4 students by increasing the complexity of the numbers involved (e.g., 107-15 for Year 3 was replaced by 127-35 for Year 4).

Procedure

The students were withdrawn, individually, from class to a quiet room in the school for all interviews. The indepth interviews consisted of three sessions of videotaped interviews: (i) a number facts test and mental computation interview; (ii) computational estimation interview and numeration interview; and (iii) effect of operation on number interview. Within each set of indepth interviews, further questions to probe for evidence of metacognition and affects were posed. Of particular interest here, are the questions that were asked during the indepth mental computation interviews. Following Van der Heijden (1994), predetermined scaffolding questions were presented to students who did not employ what was considered an efficient mental strategy (or where a more efficient strategy might be used). These were: (1) Can you think of another way of solving the problem? (2) What is (e.g., 99) close to? (3) Can you work with this number? (4) What can you do now? If the student accessed a more efficient strategy (whether resulting in a correct answer or not), he/she was then asked which strategy was preferred and why.

Analysis

For the purposes of identifying flexibility in mental computation, mental computation strategies were identified using a previously developed categorisation scheme (see Table 1). Mental computation responses were analysed for strategy choice, flexibility, and accuracy. Evidence of each student’s number sense (understanding of the effects of operation on number, numeration, computational estimation, and number facts) was also sought. Analysis of the interviews investigating these individual factors was undertaken, with the intention of exploring connections with mental computation. Students’ responses were also analysed for metacognition and affects (although this was not investigated in depth). Each student’s results for aspects of number sense, metacognition, and affects were summarised.

The findings of the present study were compared with the frameworks developed by Heirdsfield (2001a, c) for accurate mental computers. Individual student’s knowledge structures, metacognition and affects were analysed to explain the effect on both selection and implementation of mental strategies.

Whether individual students could access more efficient mental computation strategies was noted. Success or otherwise was analysed in relation to individual student’s knowledge and understanding within the conceptual frameworks for mental computation.

FINDINGS

Mental computation strategies

Although all students in the present study were reasonably accurate mental computers, not all these students employed what could be considered efficient mental strategies. Students who were considered flexible employed a variety of mental computation strategies, including *separation – left to right, right to left, cumulative sum/difference; aggregation; wholistic*. *Aggregation* was used rarely (5 students used the strategy, only 1 student

used the strategy more than once). Students did not necessarily solve very similar examples using the same strategy at different times, for instance, one student used the following strategies:

Selection interview	Indepth interview
148+99: 147+100=247	246+199: 200+200=400, 46+100=146, 446-1=445
165-99: 100-99=1, 1+65=66	234-99: 234-100=134, 134+1=135

Those who employed *wholistic* spontaneously stated that they often used the strategy in class to solve written algorithms, although they had not been taught to use it, and that the teachers probably did not know they were using it. Overall, the students improved their performance from the selection interview to the indepth interview, both in accuracy and in flexibility (this is discussed below).

Number fact knowledge

Year 3 students tended to be slower than Year 4 students, although just as accurate. Most number facts were solved using *derived facts strategies*. In both groups of students, more subtraction examples (than addition examples) were solved using a count strategy. This was more prevalent with Year 3 students than with Year 4 students. Students who were fast and accurate, and solved number facts by *recall* or *derived facts strategies* tended to be more proficient mental computers (accurate and used a variety of efficient mental strategies). Students who were slow and used count strategies to solve number facts tended to be the students who employed *mental image of pen and paper algorithm* to solve the mental computation tasks.

Numeration

All students required MAB material to regroup/rename 2-, 3-, and/or 4-digit numbers (e.g., “tell me about 209 in as many ways as you can”). Many students renamed numbers as if using a numeral expander (e.g., $1634 = 16 \times 100 + 3 \times 10 + 4 \times 1$). When it was suggested that MAB might be helpful, one student (inflexible mental computer) regrouped to make 15 hundreds, 13 tens and 4 ones, but she had to count the number of hundreds and the number of tens, as she was simply manipulating material, rather than understanding what she was doing. In conversation with the teachers, one teacher questioned the reason to be able to regroup in such a fashion. From that conversation, it was inferred that students were not encouraged to think of numbers in more than one way (in this school), resulting in inflexibility in numeration.

Effect of operation on number

The effect of operation on number, particularly the effect of changing the minuend, was not well understood by any student, particularly the students who used *mental image of pen and paper algorithm*. However, many students were able to use the concept in the mental computation indepth interviews, for instance, to solve 234-99 and 53-29 using *wholistic*.

Computational estimation

Overall, computational estimation was poorly understood, particularly by students who used *mental image of pen and paper algorithm* to solve the mental computation tasks. Many students simply guessed answers or employed a rounding strategy whether it was appropriate or not. However, there was evidence of the more proficient mental computers checking their working and solutions in the mental computation tasks, for instance, “No, that can’t be right. It’s too big.”

Metacognition, affects, and classroom context

Although this study did not have a strong focus on metacognition, there was evidence of metacognitive strategies being used by the proficient mental computers to make sense of their calculations. In contrast, the inflexible students were not concerned that some of their answers were unreasonable. All students said that they valued

mathematics and they thought it was important to calculate in their heads. Further, they all believed that they were capable of solving the examples.

What were of interest though were the insights into the classroom through the students' eyes. One Year 4 student stated that "mentals are done in class, like $31+12$. But we don't discuss the strategies." Another student stated that he "used to do sums in my head in class lessons [presumably mental arithmetic], but the teacher stopped me because he/she realised that I was too good"! Finally, another student who preferred to use *mental image of pen and paper algorithm* throughout, said that $300-298$ could not be solved, as she had difficulty with the regrouping (not realising that she could have counted!).

Potential for accessing efficient mental strategies and factors that supported this

All students were scaffolded at least once in the indepth mental computation interviews, but levels of scaffolding differed for individual students, from question 1 (see procedure above) – "Can you think of another way of solving the problem?" to question 4 – "What can you do now?" As a result of scaffolding, all students accessed *wholistic* for such examples as $56+39$, $246+100$, $63-29$, and $234-99$, but with varying degrees of success. Failure was generally a result of a lack of understanding of the effect of operation on number, and these students were generally those who employed *mental image of pen and paper algorithm*. However, in many instances, students who were unsuccessful attempting to solve these more complex examples in the selection interview or even in the indepth mental computation interview were successful when they used *wholistic*. In particular, a Year 4 student who employed the "buggy algorithm" of "take smaller from bigger" in the selection interview for $265-99$, "spontaneously" employed *wholistic* successfully for $234-99$, possibly as a result of being prompted to find a more efficient strategy to solve $80-49$. Another Year 4 student who employed *mental image of pen and paper algorithm* in the selection interview, with limited scaffolding ("What is close to?"), solved $56+39$ ($55+40$) and $246+199$ ($245+200$) (*wholistic leveling*). Other students, who accessed *wholistic* with scaffolding, stated that they started to use this method, as it "is easier". Many students started to use *wholistic* as the first strategy choice for solving examples that could easily be solved using the strategy. In general, the employment of *wholistic* resulted in improved accuracy. Further, most students stated that they found this method easier than their previous strategies.

CONCLUSION AND DISCUSSION

In general, the results of this study confirmed the conceptual frameworks for the accurate mental computers (Heirdsfield, 2001c); however, numeration understanding and understanding of the effect of operation on number were not robust. It can be said, though, that the flexible students exhibited better understanding of these two factors than the inflexible students. Further, flexible students employed more efficient number facts strategies than the inflexible students. They employed metacognitive strategies, while the inflexible students did not. Thus, the flexible students had more integrated and extensive conceptual structures to support flexible mental computation (c.f., Blöte, Klein, & Beishuizen, 2000). However, most students (flexible and inflexible) were able to successfully access more efficient mental strategies with prompting and/or scaffolding, and all but one student agreed that the accessed strategies were "easier" (concurring with Van der Heijden, 1994).

No student in the present study had been taught mental computation strategies, nor had they been taught to calculate using a number line, empty number line or 99/100 chart. The only representation they had access to was MAB. However, students successfully employed efficient mental computation strategies (with and without scaffolding), probably unknown to the teachers. Therefore, it is posited that students do not need to be taught these strategies, merely encouraged to develop and use efficient strategies (c.f., Morgan, 2000).

It is also interesting to note that most of the Year 3 accurate mental computers were flexible, while only half the accurate Year 4 students were flexible. In other words, accuracy at Year 3 level was a result of self-developed

strategies – they could solve the examples without the taught strategies (c.f., Heirdsfield, 2001c); while accuracy at Year 4 level resulted from both the taught strategies and self-developed strategies. This begs the question, why are students taught computational procedures if they can already successfully and efficiently use their own strategies?

The findings of this study add further support to students' developing their own mental computation strategies by valuing students' strategies, promoting strategic flexibility, and encouraging student discussion. Further, 'Focus is needed, both in classroom and in research, on the teacher's role in promoting pupil's thinking at a metacognitive level to gain efficiency with understanding' (Beishuizen, 1998).

References:

- Beishuizen, M. (1993). Mental strategies and materials or models for addition and subtraction up to 100 in Dutch second grades. *Journal for Research in Mathematics Education*, 24(4), 294-323.
- Beishuizen, M. (1998). Which mental strategies in the early number curriculum? A comparison of British and Dutch views. *British Education Research Journal*, 24(5), 519-539.
- Blöte, A. W., Klein, A. S., & Beishuizen, M. (2000). Mental computation and conceptual understanding. *Learning and Instruction*, 10, 221-247.
- Brown, A. L., & Palincsar, A. S. (1989). Guided, cooperative learning and individual knowledge acquisition. In L. B. Resnick (Ed.), *Knowing, learning and instruction. Essays in honor of Robert Glaser* (pp. 393-451). Hillsdale, NJ: Erlbaum.
- Buzeika, A. (1999). Invented algorithms: Teachers face the challenge. In J. M. Truran & K. M. Truran (Eds.), *Making the difference* (pp. 128-134). Sydney: MERGA.
- Cooper, T. J., Heirdsfield, A. M., & Irons, C. J. (1996). Children's mental strategies for addition and subtraction word problems. In J. Mulligan & M. Mitchelmore (Eds.), *Children's number learning* (pp. 147-162). Adelaide, Australia: AAMT.
- Denzin, N. K., & Lincoln, Y. S. (2000). *Handbook of qualitative research, 2nd edition*. California: Sage Publications.
- Hedré, R. (1999). The teaching of traditional standard algorithms for the four arithmetic operations versus the use of pupils' own methods. In I. Schwank (Ed.), *European research in mathematics education 1* (pp. 233-244). [<http://www.fim.uni-osnabrueck.de/ebooks/erne/cerme1-proceedings/cerme1-proceedings.html>]
- Heirdsfield, A. M. (1996). *Mental computation, computational estimation, and number fact knowledge for addition and subtraction in year 4 children*. Unpublished Master's thesis, QUT, Australia.
- Heirdsfield, A. M. (1998). Flexible/inflexible: Clare and Mandy's story. In C. Kanes, M. Goos, & E. Warren. (Eds.), *Teaching mathematics in new times* (pp. 241-249). Gold Coast, Australia: MERGA.
- Heirdsfield, A. M. (1999). Mental addition and subtraction strategies: Two case studies. In J. M. Truran & K. M. Truran (Eds.), *Making the difference* (pp. 253-260). Adelaide: MERGA.
- Heirdsfield, A. M. (2001a). Integration, compensation and memory in mental addition and subtraction. In M. van den Heuvel-Panhuizen (Ed.), *Proceedings of the 25th Conference of the International Group for the Psychology of Mathematics Education* (Vol 3, pp. 129-136). The Netherlands: Drukkerij Wilco.
- Heirdsfield, A. M. (2001b). Integration and compensation in accurate mental computation. In J. Bobis, B. Perry, & M. Mitchelmore (Eds.), *Numeracy and beyond* (Vol 2, pp. 273-280). Sydney: MERGA.
- Heirdsfield, A. M. (2001c). *Mental computation: The identification of associated cognitive, metacognitive and affective factors*. Unpublished doctoral thesis, QUT, Brisbane.
- Heirdsfield, A., & Cooper, T. J. (2002). Flexibility and inflexibility in accurate mental computation: Two case studies. *Journal of Mathematical Behavior*, 21, 57-74.
- Heirdsfield, A. M., Cooper, T. J., Mulligan, J., & Irons, C. J. (1999). Children's mental multiplication and division strategies. In O. Zaslavsky (Ed.), *Proceedings of the 23rd Conference of the International Group for the Psychology of Mathematics Education*. (Vol. 3, pp. 89-96). Israel: Technion.

- Kamii, C., & Dominick, A. (1998). The harmful effects of algorithms in grades 1-4. In L. J. Morrow & M. J. Kenney (Eds.), *The teaching and learning of algorithms in school mathematics, 1998 yearbook* (pp. 130-140). Reston, VA: NCTM.
- MacLellan, E. (2001). Mental calculation: Its place in the development of numeracy. *Westminster Studies in Education*, 24(2), 145-154.
- McIntosh, A. (1998). Teaching mental algorithms constructively. In L. J. Morrow & M. J. Kenney (Eds.), *The teaching and learning of algorithms in school mathematics, 1998 yearbook* (pp. 44-48). Reston, VA: NCTM.
- McIntosh, A., & Dole, S. (2000). Mental computation, number sense and general mathematics ability: Are they linked? In J. Bana & A. Chapman (Eds.), *Mathematics education beyond 2000* (pp. 401-408). Perth: MERGA.
- Morgan, G. R. (2000). Methods of calculation in primary school mathematics - adjusting the balance. *Teaching Mathematics*, 25(2), 5-10.
- Reys, R. E., Reys, B. J., Nohda, N., & Emoni, H. (1995). Mental computation performance and strategy use of Japanese students in grades 2, 4, 6, and 8. *Journal for Research in Mathematics Education*, 26(4), 304-326.
- Sowder, J. (1988). Mental computation and number comparisons: Their roles in the development of number sense and computational estimation. In J. Hiebert & M. Behr (Eds.), *Number concepts and operations in the middle grades* (pp. 182-197). Hillsdale, NJ: Lawrence Erlbaum Associates.
- Thomton, C. A., Jones, G. A., & Neal, J. L. (1995). The 100s chart: A stepping stone to mental mathematics. *Teaching Children Mathematics*, April, 480-483.
- Van der Heijden, M. K. (1994). A Vygotskian approach on mental addition and subtraction up to hundred; Handy arithmetic for primary school children. In J. Van Luit (Ed.), *Research on learning and instruction of mathematics in kindergarten and primary school* (pp. 108-124). The Netherlands: Graviant Publishing Company.
- Vygotsky, L. S. (1978). *Mind in society – The development of higher psychological processes*. Cambridge, MA: Harvard University Press.

NOTATION ISSUES: VISUAL EFFECTS AND ORDERING OPERATIONS

Dave Hewitt

University of Birmingham

Abstract: This paper reports on part of a wider study on the teaching and learning of the conventions of formal algebraic notation. Through the analysis of paper tasks given to teachers I argue that not only does the inherent mathematical structure have an effect on the way in which an equation is manipulated but also the visual impact of notation itself. Students' interpretation of arithmetic equations written in words and then structurally similar equations written in formal notation raise issues about when students perceive order which is not strictly left-to-right and the possible significant role the equals sign has in this.

Hughes (1990, p132) gave an example of a six year old, Andrew, who used bricks to work on the problem ' $13 \square 5 =$ '. Andrew made three piles of bricks containing one, three and five bricks and then proceeded to add up the bricks to make his answer of nine. When confronted with notation, all anyone can do is try to relate that notation to existing knowledge or awareness and this boy did just that. There is nothing within the notation itself which would tell this child he was wrong. Notation is arbitrary (Hewitt, 1999) in the sense that it is a social convention of arrangements of symbols where there is no necessity for the notation having had to be the way it has turned out. Decisions were made a long time ago and certain decisions have been accepted within the community of mathematicians. According to Walkerdine (1990, p2) *Saussure is credited with recognizing the importance of the fact that the relationship between the signifier and the signified is arbitrary; that is to say, conventional rather than necessary.* Meaning has to be brought to the notation. Goodson-Espy (1998) talked of often coming across issues about student interpretation of notation when trying to explain student learning of algebra. Elsewhere (Hewitt, 2001) I have argued that some of the difficulties within algebra might be due to difficulties with notation per se rather than mathematical notions themselves. The fact that Andrew ended doing an addition of $1 + 3 + 5$ when confronted with ' $13 \square 5 =$ ' does not tell us anything about whether he can subtract five from 13. With regard to the mathematics, we only learn that he can add up those numbers successfully. Any difficulty he might have had could just be about interpreting the notation, rather than the mathematics of carrying out such subtractions.

Students can create their own notations for arithmetic operations from an early age (Hughes, 1990; Steffe and Olive, 1996). Attaching a label or symbol to a concept is a natural activity with which young children engage. The act of symbolising is not so much the issue, as Sáenz-Ludlow and Walgamuth (1998, p153) pointed out *the inverse process of interpreting symbols to unfold mathematical concepts challenges all learners.* It is this inverse process of interpreting someone else's notational conventions which often causes difficulty. Sfard and Linchevski (1994) pointed out that algebraic thinking appears before notation – both historically and with learning. For the creators of notation, they already have an algebraic awareness which they are choosing to notate. Which notation they choose is a matter of preference, not a matter of right or wrong. However, for inheritors

of someone else's notation, all they are given is a collection of symbols and they are left with the much harder task of searching through their own knowledge and awareness to find something with which they can relate to the notation. For learners this is not a matter of preference as it is often judged by others as right or wrong. For a learner the formal notation can be a barrier to engagement in mathematical problems and can obfuscate otherwise accessible mathematics.

Deacon (1997) pointed out that learning any language is not as simple as a one-to-one correspondence between signifier and signified. He talked of moving from associations between symbols and objects, to relationships between symbols. This is certainly significant with formal notation as there are not only associations between a symbol such as '2' with the mathematical notion of two, or '+' with addition, etc, but also a symbol has varying significance dependent upon its position in relation with other symbols. For example, the meaning of '2' in '24', '42' and '4²' changes due to its position in relation to the '4'. As Mercer (2000, p67) pointed out *words gather meaning from 'the company they keep'*. Kirshner (1989b) argued that many students develop meaning for ordering of operations in an expression such as $3 + 2x$ through the visual impact of the position of symbols rather than through analysing the associated mathematical content of operations. For example, the '2' and the 'x' are closer together than the '3' is to the '2'. He proposed *that attaining and expressing algebraic skill is principally a linguistic rather than an intellectual exercise* (Kirshner, 1989a, p38). Perhaps a greater awareness is required of the pedagogic job to be done to help students develop linguistic skills of reading and writing algebraic notation as well as working on the algebraic notions that end up being expressed in formal notation.

THE STUDY

This paper reports on part of an ongoing study into how some students are interpreting and using formal algebraic notation before they have had many lessons on the topic of algebra within their secondary schooling. A wider aspect of the study, not reported here, involves observation of students working with recently developed software which is aimed at helping them to create and work with formal notation. Additionally, I am interested in how teachers themselves work with notation when solving some algebraic tasks and their opinions about working with students on formal algebraic notation. I used a questionnaire for teachers which included asking them to solve specially chosen linear equations and to answer various questions on notational matters. I also asked students to complete two written tasks. The first involved a series of arithmetic equations written in word form. Students were asked to state whether they felt the statement was mathematically correct and then asked to write the statement out (whether correct or not) as a formal mathematical equation. This was completed before the second task was given out, which involved a series of arithmetic equations, this time written in formal notation. The task was for the students to put a tick or a cross next to each one depending upon whether they felt the equation was correct or not. Each word statement in the first task sheet was mathematically equivalent in form to a statement written in formal notation on the second task sheet. The numbers involved in these equations were deliberately kept small in an attempt to reduce arithmetical difficulties.

The analysis of data was carried out in two ways. First, the design of some of the statements in the tasks and questions on the questionnaires were such as to test pre-study conjectures about some effects notation can have on the way notation is interpreted and worked with. Second, I used a mixture of collecting quantitative information and also coding some of the students' formal notation versions of the word statements. As per Grounded Theory (Glaser & Strauss, 1967) the coding was not determined in advance. However, the development of classifications was based more upon a Discipline of Noticing (Mason, 2002) framework where I used my initial awareness of related issues in order to notice similarities and differences and thus begin classification. This in turn sharpened my sensitivities and helped me to notice other features which led to further classification and re-forming of previous classifications. This is a cycle of using awareness to notice, which in turn sharpens sensitivities to related issues, which in turn informs my awareness to help further noticing, etc.

The focus of this paper is on the way notation is interpreted, created and used by teachers and students in the study. To this end I will focus on preliminary results from 40 teachers and from one particular class of Year 7 (11-12 year old) students.

RELATIONSHIP BETWEEN MATHEMATICS AND NOTATION

Notation not only can have an effect on the interpretation of a formal algebraic statement, but it can also have an effect on the way in which someone works with, and manipulates, algebraic statements. I asked teachers to solve some equations, two of which were:

$$\frac{13}{2kx} = 47 \quad \text{and} \quad 13 \square (2 + k + x) = 47$$

The first involves multiplication and division, the second involves addition and subtraction. As multiplication is to division what addition is to subtraction, there is an certain isomorphism between these two statements in a structural sense. Although they have similar structure, there is a significant difference in the visual impact of the two equations. I looked at the first line of the teachers working as they solved each of these equations for x . Just over a quarter of the teachers moved the x in the first equation on its own without moving the k or the 2, such as $\frac{13}{2k} = 47x$. When solving the second equation, the x was never moved on its own until later lines of working when the bracket was no longer present. I argue that although the mathematical structures are equivalent, there is a significant difference in the visual structures and that it is the visual structure which affects how someone is likely to manipulate the equation as well as the mathematical structure. In the first equation although x is adjoined to k there is still 'free space' for it to take a journey to the right-hand-side of the equation. On the other hand, the second equation has x held within brackets which visually holds and keeps the x together with the k and 2. It is not until the bracket disappears (usually through either distributing the subtraction across the whole bracket, or by taking the whole of the bracket across to the other side) that the x is 'visually free' to be manipulated on its own. Thus the notation affects the way in which the equation is manipulated.

THE EQUALS SIGN

The imbalance of the '=' sign is well known (for example, Boulton-Lewis et al, 2000). Through the practice of teachers and textbooks of presenting 'the answer' on the right-hand-side of an equation, the '=' sign has become to take on a meaning different to that of indicating that two sides are equivalent. Electronic calculators have reinforced this situation due to the temporal order in which buttons are pressed and the fact that an 'answer' is produced following the pressing of the '=' sign. This is one reason which can account for students feeling that equations with the right-hand-side involving an operation are somehow unfinished (Lack of Closure - Collis, 1975) whereas they can accept an operation on the left-hand-side. This is supported by the fact that on average over 20% of students transposed the word statements where a single number was on the left of *equals*, into notation statements with the single number on the right of the '=' sign. This is not something that just students do. There were two linear equations teachers were asked to solve for x where it is perhaps 'natural' for the x to finish up on its own on the right-hand-side of the equation, for example $\frac{13}{2kx} = 47$. However, in 49 out of 80 cases the teachers changed the sides of the equation in their working so that the x ended up on its own on the left-hand-side (i.e. $x = \frac{13}{94k}$ rather than $\frac{13}{94k} = x$). This appears to support the conjecture that having what is perceived to be 'the answer' on the right-hand-side (in this case the answer to the question *what does x equal?*) is something which stays with teachers as well as students. This helps fuel a self-perpetuating cycle with teachers offering examples with the 'answer' on the right-hand-side of the equals sign and so students abstract from such examples that there is a rule that *equals* is always followed by the 'answer'. Some of these students then becomes teachers and the cycle continues.

ORDER WITHIN STATEMENTS

Students were presented with arithmetical equations written in words. Generally students ordered the operations as they read them - left to right. For example, out of 29 school students, 20 read the statement *Two plus one times three equals nine* as correct and 24 said the statement *Four times two add three equals twenty* was wrong (see Table 1). The final statement of 17 presented to students was *Three plus two times four equals eleven* and I expected there to be a clear majority of students who felt that this statement was wrong, which would support the left-to-right ordering of the operations. However, the results showed that students were divided between whether they felt this was correct or not: 15 said correct; 14 said wrong. So what might account for the difference between this statement and the two earlier ones? Why did so many students think that this statement was correct? One possibility was that if the word statement was literally translated into a symbol statement without any brackets involved, it would be $3 + 2 \square 4 = 11$ and with the convention that multiplication is carried out before addition, then this would make it a statement not ordered left-to-right and the statement would be correct. However, the same would have been true with the first statement and by far the majority of students placed a left-to-right ordering on the operations.

Word statement and notation statement	Left-to-right ordering	Non left-to-right ordering	Unsure
<i>Two plus one times three equals nine</i> $1 + 3 \square 2 = 8$	20 14 (correct)	8 16 (wrong)	1 0
<i>Four times two add three equals twenty</i> $2 \square 3 + 4 = 14$	24 26 (wrong)	5 4 (correct)	0 0
<i>Three plus two times four equals eleven</i> $4 + 2 \square 3 = 10$	14 11 (wrong)	15 19 (correct)	0 0

Key: 't' conventional answer (if word statements were written in symbols without brackets).

Table 1: Different readings of three word statements and structurally equivalent notation statements

I could see little difference in the structure of the two statements which makes this last one stand out as being more ambiguous than the first. So I looked at the statements which appeared prior to this final one. There were four statements each of the form:

NUMBER operation NUMBER *equals* NUMBER operation NUMBER

In fact these were the only occurrences of statements where there was not a single number on one or the other side of the word *equals*. In such situations, the word *equals* can break up the flow of left to right by creating a new beginning after the word *equals*. These questions were invariably answered with success and so the students were able to read the statements as having a break in the flow and a new beginning part way through. This is exactly what is required in order to interpret *three plus two times four equals eleven* as correct, by having a new beginning with *two times four*, rather than carrying out the initial *three plus two*. Thus I conjecture that a number of students had become practised at making such a mental break in statements and could see a way of creating a break in the final statement to make that statement correct.

In the sheet of statements written in formal notation, each statement was structurally equivalent to the statements on the word sheet. Table 1 also shows the statements which appeared on the notation sheet underneath their equivalent word statements. There are several possible interpretations of the figures for these notation statements. One interpretation is that since the sheet with statements written in formal notation was completed immediately after the word statement sheet, any awareness of the possibility of breaking the flow from left-to-right might be carried into these statements, hence the increased number of students opting for a non left-to-right ordering. Another interpretation is that students were more aware of conventions of order when reading formal notation than when reading a word statement, and so generally more students agreed with the conventionally correct interpretation. Either way, it is still the case that more students decided upon a non left-to-right ordering in the last statement. Again, the four statements before this last one on the notation task sheet were of the format $a \oplus b = c \quad d$ (where \oplus and d stand for some operation) which students almost

universally answered correctly and which ‘enforced’ a break in a strict left-to-right ordering.

SUMMARY

Learning to use formal notation involves not only developing meaning for symbols but also developing meaning for the positioning of those symbols in relation to other symbols. The symbols within an algebraic equation and their relative positions produces a visual impact which affects the way those equations are manipulated when re-arranging the equation. In particular, brackets have a visual effect of holding symbols together and these are unlikely to be separated until other manipulations have first been carried out effectively to make the brackets disappear.

Equations where operations are carried out on both sides of the equals sign provide a source of examples whereby a natural left-to-right reading is broken up by the equals sign and a new beginning is established. Early data gained raises the issue of whether students experiencing such enforced breaks might carry over that experience to consider such breaks and new beginnings in equations where the convention is not a strict left-to-right ordering of the operations involved. An additional pedagogic benefit of students meeting equations with operations on both sides of the equals sign is that such examples can help to prevent the otherwise self-perpetuating practice of both students and teachers always following *equals* with an ‘answer’.

References:

- Boulton-Lewis, G. M., Cooper, T. J., Atweh, H., Pillay, H. & Wilss, L. (2000), ‘Readiness for algebra’, in T. Nakahara & M. Koyama (eds), *Proceedings of the 24th Conference of the International Group for the Psychology of Mathematics Education* Volume 2, pp89-96, Hiroshima University, Japan.
- Collis, K. F. (1975), *The development of formal reasoning*, Report of a Social science research Council sponsored project (HR 2434/1), Newcastle, NSW, Australia: University of Newcastle.
- Deacon, T. W. (1997), *The Symbolic Species: the co-evolution of language and the brain*, New York: W.W. Norton & Company.
- Glaser, B. G. & Strauss, A. L. (1967), *The discovery of grounded theory: strategies for qualitative research*, Chicago: Aldine.
- Goodson-Espy, T. (1998), ‘The Roles of Reification and Reflective Abstraction in the Development of Abstract Thought: Transitions from Arithmetic to Algebra’, in *Educational Studies in Mathematics* 36, pp219-245.
- Hewitt, D. (1999), ‘Arbitrary and Necessary: Part 1 a Way of Viewing the Mathematics Curriculum’, in *For the Learning of Mathematics* 19(3), pp2-9.
- Hewitt, D. (2001), ‘On learning to adopt formal algebraic notation’, in Chick, Helen; Stacey, Kaye; Vincent, Jill & Vincent, John (eds), *Proceedings of the 12th Study Conference of the International Commission on Mathematical Instruction: The Future of the Teaching and Learning of Algebra*, Volume 1, pp305-312, The University of Melbourne, Australia.
- Hughes, M. (1990), *Children and Number. Difficulties in Learning Mathematics*, Oxford: Basil Blackwell.

- Kieran, C. (1996), 'The changing face of school algebra', in Claudi Alsina, Jose Ma Alvarez, Bernard Hodgson, Colette Laborde & Perez, Antonio (eds) *Eighth International Congress on Mathematics Education Selected Lectures*, Seville, Spain: S.A.E.M. 'THALES', pp271-286.
- Kirshner, D. (1989a), 'Abstract impressionist algebra', in C. A. Maher, G. Goldin & R. B. Davis (eds), *Proceedings of the Eleventh Annual Meeting, North America Chapter of the International Group for the Psychology of Mathematics Education* Volume 1, New Brunswick, New Jersey.
- Kirshner, D. (1989b), 'The visual syntax of algebra' in *Journal for Research in Mathematics Education* 20(3), 274-287.
- Mercer, N. (2000), *Words and Minds*, London: Routledge.
- Sáenz-Ludlow, A. & Walgamuth, C. (1998), 'Third graders' interpretations of equality and the equal symbol', in *Educational Studies in Mathematics* 35, 153-187.
- Sfard, A. & Linchevski, L. (1994), 'The gains and pitfalls of reification - the case of algebra', in *Educational Studies in Mathematics* 26, 191-228.
- Steffe, L.P. & Olive, J. (1996), 'Symbolizing as a constructive activity in a computer microworld', *Journal of Educational Computing Research* 14(2), 113-138.
- Walkerdine, V. (1990), *The Mastery of Reason: cognitive development and the production of rationality*, London: Routledge.

Page Intentionally Left Blank

ATTITUDES OF MATHEMATICS AND LANGUAGE TEACHERS TOWARDS NEW EDUCATIONAL TRENDS¹

Marie Hofmannová, Jarmila Novotná, Zuzana Hadj-Mousoová

Charles University, Prague

The paper brings the results of research into affective barriers lying at the base of negative attitudes of mathematics and language teachers towards new educational trends, i.e. the teaching of mathematics in the English language in monolingual Czech secondary school classrooms. To find blocks to the use of new approaches the method of unfinished sentences was used. The results helped to improve the curricula of the joint degree teacher training courses at Charles University in Prague, Faculty of Education.

INTRODUCTION

All over the world the past decades are associated with two very important changes: the establishment of global networks of communication and the globalisation of all social, political, economic and ecological processes. In the Czech Republic, the 1990s in education can be characterised by a transition process partly due to European socio-economic integration, partly coming out of inner needs of the country. The new trends drawing from both European and overseas traditions proceeded from demonopolisation to qualitative diversification of educational opportunities.

Simultaneously, in 1996 the Organisation for Economic Co-operation and Development (OECD) prepared the “Reviews of National Policies for Education” which stated the difficulties of reforms as well as recommendations for new educational policies and structures.

In our long-term research concrete difficulties related to the diversity of new educational programs were identified. Some of them will be presented in this paper. They refer to one of the new trends introduced, i.e. the teaching of mathematics in the English language in monolingual Czech secondary school classrooms.

THEORETICAL FRAMEWORK AND RELATED RESEARCH

This field of study is approached from several perspectives of research: mathematical education (the processes of knowledge and skill acquisition), linguistics (the theory of Interlanguage, and bilingualism), and psychology (the teacher’s attitudes towards students, their expectations, and the social climate of the classroom), in a broader socio-cultural framework.

Learning mathematics as a discursive activity is described by (Forman, 1996). Bilingual students learning mathematics are the interest of several research studies. (Moschkovich, 2002) holds that classroom dynamics is constituted from two basic components: the process of constructing mathematical knowledge and the process of communication. She

¹ The research was supported by the projects GA_R 406/02/0809 Language Forms and Their Impact on the Cognitive Processes Development and by the Research Project MSM 114100004 Cultivation of mathematical thinking and education in European culture.

examines where language and mathematics learning intersect, and analyses the shift of focus from language development to mathematical content.

In (Gorgorió & Planas, 2002), a wide range of failure manifestations, e.g. cognitive and emotional blockages, are identified for the learning experiences of students with limited English proficiency.

Unlike teachers, students themselves do not perceive new trends in education as a problem, conversely they are flexible and open to new methods and approaches. After the very first lesson of mathematics taught in English a 15-year old Czech student wrote:

The instruction in a foreign language will definitely make me use the language in practice. It does not have to be just mathematics but also other subjects. One experimental lesson showed me that this is something new and useful. I am sure I would like more lessons like this.

The teachers' attitudes towards changes in education have always been more reserved. Reasons for that can be found in (Rogers, 1996). On p. 207, it is stated that adults have already invested emotional capital in acquiring knowledge and skills. "*They will expend much more in defending the integrity of this knowledge, so new learning changes will sometimes be strenuously resisted.*" This blockage arises from three causes two of which are emotional investment in knowledge, and existing prejudices. The third cause of blockages arises in those who are habit-bound, i.e. traditional patterns of thinking or ways of doing things.

It is possible to conclude by the following hypothesis: If the students are to succeed in a challenging way of learning and use the action model of simultaneous construction of mathematical knowledge and language skills, it is the teachers who will first have to change their attitudes towards new educational approaches, i.e. to avoid the transmission model of teaching and adopt cooperative and communicative teaching strategies that support creative learning (Kubínová & Novotná, 2000).

BACKGROUND

Over the past years of our classroom based research in teaching mathematics through the medium of the English language to Czech secondary school students, we identified the following:

The first observation concerns the people: both teachers and students have a limited English proficiency. Some aspects of this are dealt with in (Novotná, Moraová, Hofmannová, 2003).

The second area of research dealt with learning process. This can be characterized by several dissonances or discontinuities and accompanied by a number of myths. It is due to the shift from a *silent mathematics classroom* to a *communicative mathematics classroom*, from *receptive skills* to *productive verbal skills*. Learning mathematics is described as participation in mathematical discourse practices (Gee, 1999).

Examples of language discontinuities:

- Code-switching occurs in the students' language move from L1 (mother tongue) to L2 (foreign language) and means a break in communication. Therefore it is seen as a

negative phenomenon. To us code-switching is a natural feature, and an interim stage of foreign language development.

- The discontinuity between social talk and academic talk was described by many authors. Vygotsky (1986) speaks about the development from the language of spontaneous concepts to the language of scientific concepts. Cummins (1980) uses the terms BILC (basic interpersonal language competence) and CALP (cognitive academic language proficiency).
- Everyday register differs from mathematical register. In this sense, (Gorgorió & Planas, 2002) state that the students' move from exploratory talk and discourse-specific talk would require further research.
- The nature of the Czech language differs from the nature of the English language in a way that Czech operates with single meanings of words whereas English words have often multiple meanings. Multiple meanings perspective is studied in (Moschkovich, 2002) comparing English and Spanish.
- The shift in the definition of bilingualism constitutes further dissonance. As to the level of competence, bilingualism is now understood in a much broader way than before. It does not mean the complete balance between the two languages but a partial, functional use of the language is fully accepted.

OUR RESEARCH

The present research findings reflect the area of teacher training. We believe that without deep changes in teachers' beliefs and attitudes major changes in student learning cannot occur. This corresponds with (Rogers, 1996): *“The introduction of learning changes into the area of attitudes is perhaps the most difficult task that faces the teacher educator.”*

METHODOLOGY

For the investigation of teachers' attitudes we decided to compare two groups of adults. Group A consisted of 30 teacher trainees involved in an optional course of Content and Language Integrated Learning (Mathematics in English) at Charles University in Prague, Faculty of Education. Group B was formed by 37 fully qualified practising teachers from secondary schools, participants of an in-service teacher training course.

To find blocks to the use of new approaches we used the method of unfinished sentences. They enable the respondents to express their ideas freely. To analyse the results a qualitative approach was used. For this type of analysis a lower number of respondents is sufficient. The responses were analysed only with regard to affective barriers, their causes and ways of help. During the qualitative processing of the results categories of answers were created according to the concrete nature of the gained material.

The questionnaire was not pre-announced. It was administered in Czech. It consisted of the following unfinished sentences:

I fear that

It is best if

To study at my age

When I study

I cannot learn something because
My friends say about me
I think that the others
The greatest difficulties for me are
Sometimes I cannot
I would be happy if
I am angry
It is difficult to study when
I am glad
To study
When the teacher studies
I wish I
I am looking forward to
It is high time I
When I am free
I enjoy

Based on the categorisation of results during the qualitative analysis we created the following **scheme of categories** based on (Rogers, 1996):

Inner barriers

1. fear of failing
2. fear of not meeting the requirements
3. fear of uncertain success

Causes of inner barriers: changes caused by aging, negative self-concept, too high self-requirements and too positive perception of the others, fatigue

Outer barriers

4. lack of time
5. personal and family problems

Causes of outer barriers: inability of time management, lack of calm

Consequences of affective barriers are: problems with concentration, attention, memory, lack of motivation and the need of avoidance, escape.

Examples²

² Unfinished sentences are in Italics.

Barriers

1. *I fear that I will fail the exam.* (Group A)

I fear that I am not such a good teacher as I would like to be. (Group B)

2. *I fear that I will not finish the study.* (Group A)

I fear that I will not meet the deadlines when submitting my course work. (Group B)

3. *I fear that I will disappoint the others by failing.* (Group A)

It is difficult to study when I think that I will not manage. (Group B)

4. *The greatest difficulties for me are when I learn under pressure and do not have enough time.* (Group A)

I am angry when I cannot do all the things that I have planned. (Group B)

5. *I wish I could live somebody else's life as I am tired of my own.* (Group A)

It is difficult to study when my children disturb me with their problems. (Group B)

Causes

- *To study at my age is a bit of a problem because my peers lead a completely different style of life.*
- *I cannot learn something because I do not have logical reasoning.*
- *Sometimes I cannot overcome the feeling that I do not do everything 100 percent.*
- *I think that the others are cleverer than me.*
- *When I study I keep falling asleep.*
- *When I am free – I am not free because I have to study.*
- *It is difficult to study when I hear voices or music.*

Consequences

- *Sometimes I cannot switch off and concentrate on my duties.*
- *When I study I am very absent-minded.*
- *The greatest difficulties for me are to learn things by heart.*
- *When I study I want to know that it makes sense, then I am more motivated.*
- *I wish the exams were over.*
- *I wish I could relax on the beach.*

COMPARING AND CONTRASTING RESULTS OF GROUP A AND GROUP B

In group A (undergraduate teacher trainees) all categories of affective barriers are present. In Group B (postgraduate teacher trainees) the fear of failure and the fear of not meeting the requirements dominate. The uncertainty of success is not as strong. On the other hand the fear to be ridiculed is very strong.

Also the aging process is perceived stronger by group B whereas the undergraduate students think that this problem does not concern them. Negative self-concept is a strong feature in both groups. Group A students express doubts concerning their abilities whereas Group B mention doubts about other properties necessary for successful studying.

A relatively frequent response was fatigue. The interpretation however differs: Group A students speak about laziness as if they were not allowed to be tired at their age.

The lack of time is perceived strongly by both groups. They differ in the nature: Group A is overburdened by study requirements, Group B by out of school duties. It looks as though undergraduate students are often not capable of good time management.

It is interesting to compare extra-curricular activities in both groups. Frequent complaints of the younger ones are that they cannot live the same way as their peers. Older teachers complain more of personal family or health problems. Moreover they fear of unemployment.

From the consequences of affective barriers to learning we selected the difficulty to concentrate. Group A expresses inability to concentrate due to the nature of the subject or the method (intrinsic motivation). Group B state problems with attention span caused by external factors.

The need to escape is expressed on several levels. Partly it reflects the present situation when the students feel the need to complete the duties of the semester. At the same time they express the desire to have free time, holiday. This is present in both groups' responses. The contrast appears in the place of escape. Group B are family oriented. Group A students are not happy about the status of the student and they wish for "normal" non-study life.

Group A state a number of responses expressing the need for sense in learning and learning by new non-traditional methods. This is missing in Group B. It can be explained by the fact that for older respondents teaching has become a habit, a routine. They are used to working in a traditional way.

CONCLUSIONS

It seems that adults find it difficult to change because they invested emotional capital in acquiring their knowledge and teaching skills and that is why they defend the integrity of this knowledge more strongly. Emotional investments lie at the base of negative attitudes of practising teachers towards new educational trends.

Returning back to the teacher training course for the new teacher qualification to teach mathematics through the English language to Czech students, it was necessary to discover and identify the reasons why older teachers are reluctant to changes. This enabled us to include new incentives in the course curricula to work with teachers' motivation and attitudes. Barriers can thus turn into resources (Moschkovich, 2002).

References

Cummins. J. (1980): The entry and exit fallacy in bilingual education. *NABE: Journal for the Association for Bilingual Education*. 4(3), 25-60.

- Froman, E. (1996): Learning mathematics as participation in classroom practice: Implications of sociocultural theory for educational reform. In: *Theories of mathematical learning*. Eds. L. Steffe, P. Neshet, P. Cobb, G. Goldin & B. Greer. Mahwah, NJ, Lawrence Erlbaum Associates, Inc.: 115-130.
- Gee, J. (1999): *An introduction to Discourse analysis: Theory and method*. New York: Routledge.
- Gorgorió, N. – Planas, N. (2002). Teaching Mathematics in Multilingual Classrooms. *Educational Studies in Mathematics* **47**: 7-33.
- Hadj-Mousová, Z. – Hofmannová, M. – Novotná, J. (in print). V_uka v cizím jazyce. Afektivní zábrany v u_ení. *Pedagogika*. (Teaching through a foreign language. Affective barriers in learning.)
- Hofmannová, M. – Novotná, J. (2003). Attitudes Towards Teaching Mathematics in English in the Czech Republic. In: *3rd Mediterranean Conference on Mathematical Education*. Eds. A. Gagatsis and S. Papastavridis. Athens, Hellenic Mathematical Society, Cyprus Mathematical Society: 371-375.
- Kubínová, M. – Mareš, J. – Novotná, J. (2000): Changing Teaching Methods in School Mathematics, An Analysis of Some Episodes from Classes. In: *Proceedings PME 24*, Volume 3. Ed. T. Nakahara, M. Koyama. Hiroshima University: 3-183 – 3-190.
- Moschkovich, J. (2002). A Situated and Sociocultural Perspective on Bilingual Mathematics Learners. *Mathematical Thinking and Learning* **4(2&3)**: 189-212.
- Rogers, A. (1996): *Teaching Adults. Blocks to Learning*. Open University Press.
- Vygotsky, L.S. (1986): *Thought and Language*. Cambridge, MA: The MIT Press.

Page Intentionally Left Blank

GENDER DIFFERENCES IN THE EARLY YEARS IN ADDITION AND SUBTRACTION

Marj Horne

Australian Catholic University

Recent large scale international studies have indicated that while a gender differential in mathematics performance still exists at secondary school level there are few differences in the primary school years. However there is some indication that differences exist in the use of mental strategies rather than in correctness of responses. In this paper some findings from a large scale longitudinal study of children in grades 0-3 are presented. The results appear to confirm that in Grades 2 and 3 a gender difference exists in the strategies children use to answer addition and subtraction problems.

BACKGROUND

In the last few decades of the last century there was considerable interest in gender differences in achievement, participation and attitude. The emphasis has changed though to recognise the more complex interactions between gender and socio-cultural variables (Leder, Forgasz & Vale, 2000). However in the last few years the amount of research in this area has diminished. Perhaps this is partly due to the complexity of the issue and a belief that the differences have diminished. There have been some changes. In mathematics in the last year of secondary school in Victoria, the girls' results are now not significantly different to those of the boys. In some mathematics subjects on average girls are moving ahead, though this hides the fact that the proportion of girls choosing the more difficult mathematics is low (Leder et al., 2000). The girls are also still under represented in the top group. The nature of the assessment can affect performance with the girls doing better on the more extended written problem solving tasks and the boys still having the edge in the examinations (Leder, Brew & Rowley, 1999). Attitudes towards mathematics as a male domain have also changed. For example "students now consider boys more likely than girls to give up when they find a problem too challenging, to find mathematics difficult and to need additional help" (Leder, 2001, p. 50).

The Third International Mathematics and Science Study (TIMSS) provided an opportunity to look at gender differences at both primary school and high school level. Overall there were differences in performance still clearly favouring the boys in the upper secondary school but at middle primary school (age 9) in most countries there were no significant gender differences in performance (Mullis, Martin, Fierros, Goldberg & Stemler, 2000). In Australia and New Zealand there were no statistically significant differences found for gender at either middle primary school (age 9) or junior secondary school (age 13) (Lokan, Ford & Greenwood, 1996, 1997). In the PISA study of 15 year olds in all but 3 of the 33 countries the boys outperformed the girls in mathematical literacy but the difference was not significant in 14 of those countries including Australia (Lokan, Greenwood & Cresswell, 2001). Performance differences thus show more with the older children. On the large scale testing performance measures the effect of gender is low for the younger children.

While advances have been made, it is clear that there is still not gender equity. At middle primary school, while there appears to be little difference in performance, a closer look shows differences in mental strategies which may contribute to the performance and participation data for older children. Most measures of performance use pen and paper approaches, the measure of success is the correctness of the answer and, if method is given a role, efficient use of standard algorithms is rewarded. There have been some studies that have shown there is a tendency for different methods and approaches to be used, while overall performance is the same (Carr & Jessup, 1997; Fennema, Carpenter, Jacobs, Franke & Levi, 1998; Gallagher & DeLisi, 1994). The studies of young children are of particular interest as this is where there are generally no performance differences showing. In a longitudinal study of 44 boys and 38 girls as they progressed from grades 1 to 3 Fennema et al. (1998) interviewed the children twice a year with some number based tasks. The interview approach allowed for approaches and mental strategies to be investigated as well as performance. They found that the boys used significantly more derived facts and invented algorithms while the girls used significantly more counting strategies and modelling, though there was no difference in correctness of responses (Fennema et al., 1998). These differences indicate another look is needed at gender differences in attainment in mathematics.

THE STUDY

The findings reported in this paper are based on data gathered as part of the Early Numeracy Research Project (ENRP, Clarke, 2001), a large scale project with teachers and children in grades 0 – 2 (ages 5 – 8). One of the aims of the project was to evaluate the effect of professional development and the key design elements of school improvement (Hill & Crévola, 1999) on student numeracy outcomes (in this context numeracy and mathematics could be considered equivalent). To monitor the effects the students were assessed for their mathematical understanding twice a year.

Sample, instruments and methods

All students in grades 0 – 2 in 35 *trial* schools, representative of schools in Victoria, Australia, participated in the three year long study from 1999 to 2001. A sample of students from a set of 35 *reference* schools, matched in terms of geographical location, socio-economic status, language background, school size and indigenous population, was used as a control group. While over 11000 students participated altogether the data reported here is based on the 1237 children (F=565, M=672) who began in grade 0 in March 1999 and were still with the project in grade 2, November 2001. Of these 942 (F=423, M=519) were in trial schools and the remaining 295 were from the reference schools. The project finished at the end of 2001 but data were collected in November 2002 from a smaller random sample of 630 (F=305, M=325) of the children who had been with the project all the way through. Of these 438 (F=208, M=230) were in trial schools and 192 were from reference schools.

A task based interview assessment was used in March (the beginning) and November (the end) of each school year to assess the children in the project. This interview assessed a number of domains of mathematics from the curriculum areas of number, measurement and space but this paper is looking specifically at the domain of Addition and Subtraction Strategies. The development of the interview assessment and the related framework of

growth points has been described elsewhere (Clarke, Sullivan, Cheeseman, & Clarke, 2000). As can be seen the Growth Points for the domain of Addition and Subtraction Strategies, shown in Figure 1, are based on the mental strategies the children use rather than the just correctness of the answers. For example students answering questions such as $27 + 10$ and $6 + 4$ by counting on, while they may obtain 37 and 10, may be operating at growth point 2 or 3 rather than growth point 4.

- GP 1. Count all (two collections)
Counts all to find the total of two collections.
- GP 2. Count on
Counts on from one number to find the total of two collections.
- GP 3. Count back/count down to/count up from
Given a subtraction situation, chooses appropriately from strategies including count back, count down to and count up from.
- GP 4. Basic strategies (doubles, commutativity, adding 10, tens facts, other known facts)
Given an addition or subtraction problem, strategies such as doubles, commutativity, adding 10, tens facts, and other known facts are evident.
- GP 5. Derived strategies (near doubles, adding 9, build to next ten, fact families, intuitive strategies)
Given an addition or subtraction problem, strategies such as near doubles, adding 9, build to next ten, fact families and intuitive strategies are evident.
- GP 6. Extending and applying addition and subtraction using basic, derived and intuitive strategies
Given a range of tasks (including multi-digit numbers), can solve them mentally, using the appropriate strategies and a clear understanding of key concepts.

Figure 1. ENRP Growth Points for the domain of Addition and Subtraction Strategies.

The framework and interview deliberately included Growth Points and corresponding questions which would be normally considered beyond the curriculum at the grade 0-2 level. For example the tasks for Growth Point 6 included tasks like estimating whether $134 + 689$ and $1246 - 358$ were larger or smaller than 1000 with the explanation being sought, and the mental calculation of three digit addition and subtraction.

Analyses, results and discussion

Initially the students were assigned growth points for each interview period, based on the interview data, by trained personnel who had shown high reliability (Rowley & Horne, 2000). It is acknowledged that the growth points do not form an interval scale so an interval scale from 0 to 6 which mirrored the growth points fairly closely was created to enable statistical comparisons of the data (Horne & Rowley, 2001).

Figure 2 shows the mean of the growth points scale for girls and boys at each testing period in the trial and reference schools over the three years of the project and the subsequent year. As can be seen, while the growth for the trial school children exceeded that of the reference school children, the gender difference is clearly there in both and reference schools.

* Reduced sample size

Figure 2. Growth on the Addition and Subtraction Strategies Scale for trial and reference schools by gender

In the trial schools during 2002 the students were no longer being taught by teachers who

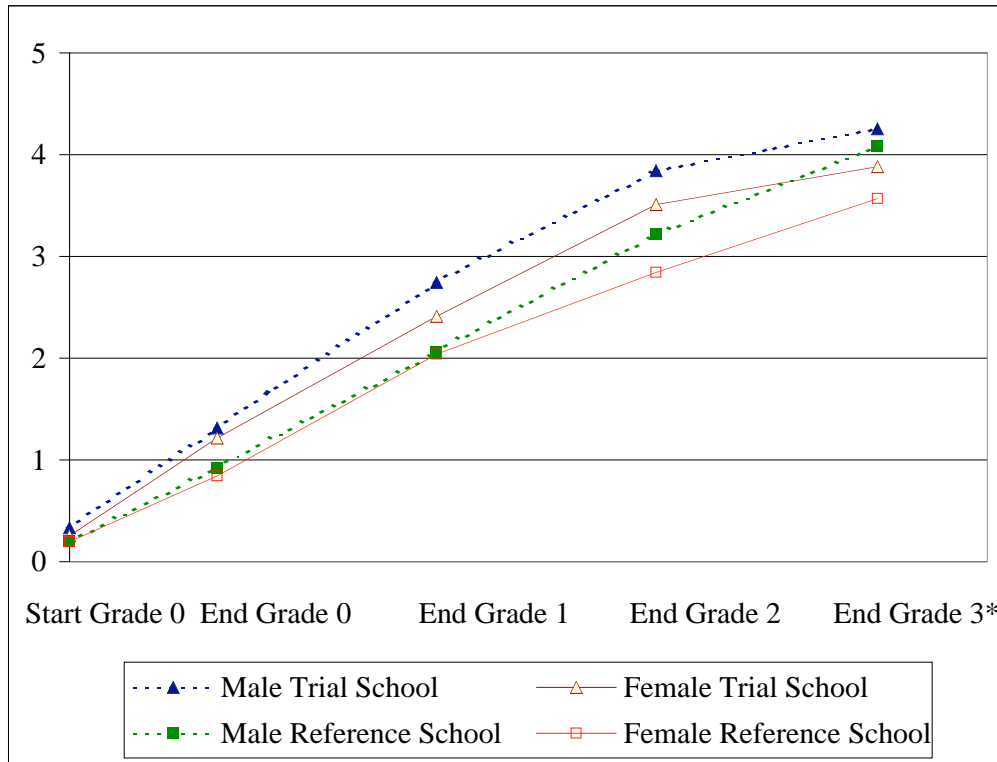

had participated in the extensive professional development provided as part of the project. The impact of this shows in the reduced growth during 2002. It can also be seen that the gender gap is increasing.

Analysis of Covariance was done to investigate the growing gender difference. Table 1 shows the ANCOVA results for November 2001 (end of Grade 2) and November 2002 (end of grade 3). Because there were some differences on entry in March 1999 (start of grade 1) the growth points for addition and subtraction on entry to the project were used as the covariate in the analysis. The independent variables investigated were Gender and a variable Data, which represented participation in the project as a trial or reference school.

Both gender and participation in the project independently had a significant impact on attainment but there was no significant interaction between participation and gender meaning that, on this domain at least, the gender differential was the same in both trial and reference schools. The interval scale was used to enable statistical investigation to highlight aspects that needed further study and gender is clearly one of these.

End Grade 2		End Grade 3	
<i>N</i> = 1237		<i>N</i> = 630	
F	Sig.	F	Sig.

Covariate: Start Grade 0	68.1	0.000	47.2	0.000
GENDER	19.8	0.000	25.9	0.000
DATA	65.3	0.000	7.4	0.007
GENDER * DATA	0.2	0.689	0.8	0.385

Table 1. ANCOVA for Addition and Subtraction Strategies comparing boys and girls in both trial and reference schools with the start of Grade 0 as the covariate.

While the means in the growth graph above show part of the picture, the spread of the children across the growth points enables the nature of the differences to be investigated. Table 2 shows the percentages of boys and girls in the trial and reference schools who had demonstrated attainment of each growth point at the interview time.

	Boys					Girls				
	Mar 1999	Nov 1999	Nov 2000	Nov 2001	Nov 2002*	Mar 1999	Nov 1999	Nov 2000	Nov 2001	Nov 2002*
	Start Gr 0	End Gr 0	End Gr 1	End Gr 2	End Gr 3	Start Gr 0	End Gr 0	End Gr 1	End Gr 2	End Gr 3
Trial Schools										
GP 0	70.7	13.8	1.2	0.4		67.1	11.0	2.2	0.2	
GP 1	19.3	43.1	17.0	1.3	2.2	26.0	48.8	19.9	4.0	1.4
GP 2	8.7	32.9	35.9	22.2	6.1	6.4	35.4	44.7	27.2	17.8
GP 3	1.2	8.6	15.6	12.1	10.9	0.5	4.5	15.8	15.4	11.5
GP 4	0.2	1.2	20.5	25.0	27.8			14.4	26.7	33.7
GP 5		0.2	9.3	35.6	41.7		0.2	3.1	26.2	34.6
GP 6		0.2	0.6	3.3	11.3				0.2	1.0
Reference Schools										
GP 0	77.8	23.2	6.6	2.0		77.5	16.9	5.2	1.4	
GP 1	17.0	47.2	25.4	9.2	2.1	17.6	58.8	24.3	12.0	4.1
GP 2	5.2	27.5	45.9	30.1	16.8	3.5	21.3	51.3	41.5	20.6
GP 3		2.1	10.7	14.4	8.4	1.4	1.5	11.3	16.2	19.6
GP 4			8.2	22.2	22.1		1.5	7.0	16.9	37.1
GP 5			3.3	20.3	44.2			0.9	11.3	15.5
GP 6				2.0	6.3				0.7	3.1

* reduced sample size

Table 2. Percentage distribution of boys and girls across the addition and subtraction growth points through grades 0-2.

While it is clear that more trial school children have reached the upper growth points than reference school children it is also clear that in both trial and reference schools more boys than girls have attained the upper growth points. Since GPs 1-3 are concerned with different counting strategies and GPs 5 and 6 with derived strategies the data for the trial schools is amalgamated in table 3 based on the strategy used.

	Boys					Girls				
	Mar 1999	Nov 1999	Nov 2000	Nov 2001	Nov 2002*	Mar 1999	Nov 1999	Nov 2000	Nov 2001	Nov 2002*
No successful strategy	70.7	13.8	1.2	0.4		67.1	11.0	2.2	0.2	
Counting Strategies	29.1	84.6	68.4	35.7	19.2	32.9	88.8	80.3	46.7	30.7
Basic Strategies	0.2	1.2	20.5	25.0	27.8			14.4	26.7	33.7
Derived Strategies		0.4	9.9	38.9	53.0		0.2	3.1	26.4	35.6

Table 3. Percentage distribution across strategy types for boys and girls in trial schools.

Notice that more girls in grade 0 moved to using counting strategies but then more boys moved to basic and derived strategies. By the end of grade 3, 53% of the boys are effectively using derived strategies but for the girls this percentage is less than 36%. In the reference schools this difference was more marked with nearly 50% of the boys but less than 19% of the girls using derived strategies. Likewise 30% of the girls but only 19% of the boys in the trial schools are still using counting strategies by the end of grade 3 while in reference schools these percentages are 44% for the girls and 27% for the boys.

It is of some concern that gender differences in strategies are showing so early in schooling. The percentage of girls using counting strategies for addition and subtraction is higher than that for boys in grades 2 and 3 while a greater percentage of the boys than the girls have moved past counting on to derived strategies. It is also noticeable that the percentage of boys moving on to more complex problems applying addition and subtraction strategies is higher.

CONCLUDING COMMENTS

These results show that there are differences in the strategies used by girls and boys in tackling addition and subtraction problems as early as grades 2 and 3 and support the findings of the study by Fennema et al. (1998). What is not so clear is why these differences exist.

There were differences between the trial and reference schools in the project, though these differences reduced in the year following the project completion. One possible explanation is the expectations the teachers had of the children. The teachers of grades 0-2 in the trial schools, in response to questionnaire items, claimed that a major change in their teaching was that they had changed their expectations of what it was possible for young children to do in mathematics, and that they used the framework of growth points to extend all children rather than the curriculum document for the particular grade (Clarke, 2000). The teachers of Grade 3, however, had not participated in the project and hence, like the teachers in the reference schools, used the curriculum document. There may be a similar effect for the gender difference. The impact of teacher expectations limiting children, and school curriculum where algorithms for addition and subtraction

are often taught in Grade 3 combined with the girls wishing to please may contribute to the differences in strategies, but this is speculation. This raises the question of whether and why expectations and teaching might differ for girls and boys. Another possibility may be that the girls rely more on the methods with which they have most confidence and avoid the risk taking of trying their own approaches. Again this raises questions rather than answering them. Is risk taking greater among boys than among girls at this age? Is there a difference in the perceptions of boys and girls about what the teachers require and about the type of responses required in mathematics? Do these patterns of different strategies rather than different performance continue in higher grades?

Apart from speculating on the reasons for the differences there is also a concern about the impact of this difference for the future mathematical learning and participation of students in mathematics and this raises further questions. Does the lack of derived strategies and the reliance on counting hinder further development or is this just demonstrating different pathways? Further study that uses techniques to tap strategies rather than just performance is needed at all levels.

Acknowledgements:

The main team of researchers involved in the ENRP includes D. M. Clarke (director), J. Cheeseman, B. Clarke, A. Gervasoni, D. Gronn, M. Horne, A. McDonough, P. Montgomery, A Roche, G. Rowley, and P. Sullivan. All of this team have been involved in the research presented here. This research was funded by the Victorian Department of Employment, Education and Training, the Catholic Education Office (Melbourne), and the Association of Independent Schools Victoria.

References:

- Carr, M., & Jessup, D. L. (1997). Gender differences in first grade mathematics strategy use: Social and metacognitive influences. *Journal of Educational Psychology*, 98(2), 318-328.
- Clarke, D. M. (2000). The early numeracy research project: Some insights from an exciting first year. In Department of Education, Employment and Training. (Eds.), *High expectations: Outstanding achievement* (Proceedings of the Early Years of Schooling P-4 conference, CD-ROM). Melbourne: DEET.
- Clarke, D. M. (2001). Understanding, assessing and developing young children's mathematical thinking: Research as powerful tool for professional growth. In J. Bobis, B. Perry, & M. Mitchelmore (Eds.), *Numeracy and beyond: Proceedings of the 24th Annual Conference of the Mathematics Education Research Group of Australasia* (Vol. 1, pp. 9-26). Sydney: MERGA.
- Clarke, D. M., Sullivan, P., Cheeseman, J., & Clarke, B. A. (2000). The early numeracy research project: Developing a framework for describing early numeracy learning. In J. Bana & A. Chapman (Eds.), *Mathematics education beyond 2000* (Proceedings of the 23rd annual conference of the Mathematics Education Research Group of Australasia, pp. 180-187). Fremantle, Western Australia: MERGA.
- Fennema, E., Carpenter, T. P., Jacobs, V. R., Franke, M. L., & Levi, L. W. (1998). A longitudinal study of gender differences in young children's mathematical thinking. *Educational Researcher*, 27(5), 6-11.

- Gallagher, A. M., & DeLisi, R. (1994). Gender differences in scholastic aptitude tests – Mathematical problem solving among high ability students. *Journal of Educational Psychology*, 86, 204-211.
- Hill, P. W., & Crévola, C. A. (1999). The role of standards in educational reform for the 21st century. In D. D. Marsh (Ed.), *Preparing our schools for the 21st century* (Association of Supervision and Curriculum Development Yearbook, pp. 117-142). Alexandria, VA: ASCD.
- Horne, M & Rowley G. (2001). Measuring growth in early numeracy: Creation of interval scales to monitor development. In M. van den Heuvel-Panhuizen (Ed.), *Proceedings of the 25th conference of the International Group for the Psychology of Mathematics Education, Vol. 3* (pp. 3-161 – 3-167). Utrecht, The Netherlands: Freudenthal Institute.
- Leder, G. C. (2001). Pathways in mathematics towards equity: a 25 year journey. In M. van den Heuvel-Panhuizen (Ed.) *Proceedings of the 25th conference of the International Group for the Psychology of Mathematics Education. Vol. 1* (pp. 1-41 – 1-54). Utrecht, The Netherlands: Freudenthal Institute. [July 12-17].
- Leder, G. C., Brew, C. & Rowley, G. (1999). Gender differences in mathematics achievement – Here today and gone tomorrow. In G. Kaiser, E. Luna, & I. Huntley (Eds.), *International comparisons in mathematics education* (pp. 213-224). London: Falmer Press.
- Lokan, J. Ford, P. & Greenwood, L. (1996). *Maths & Science on the line: Australian junior secondary school students' performance in the Third International Mathematics and Science Study*. Melbourne: Australian Council for Educational Research.
- Lokan, J. Ford, P. & Greenwood, L. (1997). *Maths & Science on the line: Australian middle primary school students' performance in the Third International Mathematics and Science Study*. Melbourne: Australian Council for Educational Research.
- Lokan, J., Greenwood, L., & Cresswell, J. (2001). *15-up and counting, reading, writing reasoning: How Literate are Australia's students? The PISA 2000 survey of students' reading, mathematical and scientific literacy skills*. Melbourne: ACER
- Mullis, I. V. S., Martin, M. O., Fierros, E. G., Goldberg, A. L., & Stemler, S. E. (2000). *Gender differences in achievement, IEA's Third International Mathematics and Science Study*. Boston: International Study Centre, Boston College.
- Rowley, G., & Horne, M. (2000, December). *Validation of an interview schedule for identifying growth points in early numeracy*. Paper presented at the Australian Association of Research in Education conference, Sydney.

HIGH ACHIEVING GIRLS IN MATHEMATICS: WHAT'S WRONG WITH WORKING HARD?¹

Ann C. Howe

North Carolina State University

Sarah B. Berenson

North Carolina State University

The participation of women in graduate studies and mathematics-related careers remains a social and economic problem in the United States. Part of a larger study to understand this lack of participation, here we present preliminary findings of girls who are high achievers in middle grades mathematics. This interpretive study documents girls' voices from feminist perspectives and reports their perceptions of what it takes for them to be successful in advanced math classes. Girls attribute their success to a) strong family support, b) desire to understand mathematics, c) assertiveness, and d) belief in hard work.

FOCUS, BACKGROUND, AND FRAMEWORKS

An excellent math student tries hard. They don't give up. They ask for extra help if they know they need it. They, um, no matter what grade they get, if they're trying hard and they know they need help then they're doing really good. I think if you try your best and a B is all you can do and you just can't quite get it then ... you're doing good.

Jolee, Rising 8th Grade Girl

The focus of this study is to identify factors that high achieving adolescent girls associate with their success in mathematics. A synthesis of the mathematics achievement literature no longer supports the common notion that boys consistently outperform girls in mathematics. Gender differences in achievement still persist in secondary schools, on college entrance exams, and among middle grades talented youth. Achievement differences are generally not significant at the elementary and middle school levels (Beaton, Mullis, Martin, Gonzalez, Kelly, & Smith, 1996; Chipman, 1996). In terms of female participation in mathematics, Chipman (1996) believes that representation of the number of undergraduate mathematics degrees granted to women is equal to that of men, and that women's under-representation in physics, engineering, and computer science may be unrelated to their attitudes toward mathematics. She reports that women are under-represented in mathematics graduate studies, and that this may be attributable to a gender difference in confidence that, in turn, may reflect the failure of the culture to recognize women's mathematical contributions. In other words, when the mathematician's culture does not value women's contributions, women's self-confidence is shaken and goals of advanced mathematical study are judged unattainable. There is conflicting evidence in the literature concerning the relationship between attitudes, such as confidence, and achievement (Ma & Kishnor, 1997; Ruffell, Mason, & Allen, 1998).

¹ This research was supported, in part, by National Science Foundation Grant #9813902, Girls on Track and National Science Foundation Grant #0204222, Women and Information Technology. The views expressed here do not necessarily reflect the views of the National Science Foundation.

While earlier studies (Fennema & Sherman, 1977) report high correlation between these factors, a recent meta-analysis of studies of attitude and achievement found only weak relationships and Fennema (1996) herself questions assumptions that guided her earlier work on gender differences. "Perhaps," she writes "our belief about the [gender] neutrality of mathematics as a discipline may be wrong" (p.22). In stating her new position, she expresses concern as to whether we have asked the right questions in previous gender studies. Fennema has opened the door to new directions of inquiry along with the need for another set of assumptions and frameworks for studying gender and promoting equity in mathematics education. This view is also espoused by Damarin (1995), who recognizes the empirical research accomplishments of Fennema and others, but urges the adoption of frameworks that incorporate feminist perspectives. She suggests that these perspectives "must be actively pursued and constructed as a way of knowing, which begins with the lives of (particular) women in the world" (p.247).

Our study adopts a perspective that begins with the individual rather than a socially constructed theoretical perspective or world-view. If, as Damarin suggests, knowledge resides with the individual, then we assume that learning begins with the individual's prior experiences and beliefs. This perspective leads us to ask how we can change the culture to value and use the contributions of young women. Rather than an approach that seeks to change girls, we seek to discover their strengths by listening to their voices so that their strengths can be incorporated into mathematics education as it is enacted in the classroom. As Shultz and Cook-Sather (2001) advise, we seek to gain new insight as to how high achieving girls approach their study of mathematics by listening as they speak to their experiences.

MODE OF INQUIRY AND DATA SOURCES

Data were gathered from interviews of participants in the *Girls on Track* project, a program designed for middle school girls who have demonstrated their ability to pursue upper level math courses. The girls were rising seventh or eighth graders and on the "fast track" in math leading to the study of calculus by their junior or senior years in high school. All girls who made application for this free camp were accepted into the *Girls on Track* program.

These are daughters of baby-boomers who are economically secure and ambitious for their children. All but two girls live in intact two-parent families where the father is the main breadwinner and works as a computer scientist or engineer, an accountant, or in some other position at one of the large technology or scientific companies in the area. Most of their mothers are also employed but they hold a wider range of jobs, including computer engineer, pharmacist, teacher, nurse, business manager and others. One girl, whose mother died, lives with her grandmother; another, whose parents are separated, lives with her father but these girls, as well as all the others, have stable, caring families.

Girls on Track provides a two-week summer camp for 80 girls with team-building activities to investigate community problems, build computer skills, strengthen proportional reasoning, learn about careers and gender issues while engaging in math-related sports algebra. Camp counselors were asked to select 1-2 girls from their teams who they anticipated would continue in their studies of advanced mathematics. From this

list, 16 girls were interviewed at or near the end of the two-week summer math camp. All but two of the girls were rising 8th graders; 3 were Asian Americans, 6 were African American and nine were Caucasian. The prompts in these semi-structured interviews were: (a) What was math like for you last [school] year? (b) What grade would make you unhappy? (c) Where did you go when you wanted help? (d) What is your favorite subject? and (e) What careers interest you? The interviews were videotaped, the videotapes were transcribed and analyzed. Content analysis was used to develop categories that were then used to code the transcripts.

RESULTS

Four factors emerged as dominant in these high achieving students' minds as they talked about their experiences in math class and what they had to do to achieve success. These factors are explained below.

High Expectations

The girls have high expectations that are encouraged and supported by their families and, often, by their teachers. They are confident that they will experience success in mathematics and they define success as achieving high grades. The following excerpts from interviews are typical.

Interviewer: What was math like for you last year?

Elizabeth: I didn't take pre-algebra last year and I struggled a little bit at the beginning but now I love math. It is one of my favorite subjects. My teacher told me algebra would be a challenge but to just keep my head screwed on right and I could do it. The first quarter I made a C and my mom was like "No, you can do better than that" so ever since then I've made an A.

Interviewer: What algebra grade would make you unhappy?

Brandy: A (grade of) C would make me unhappy because my mother really expects a lot out of me because I'm supposed to be going into 7th grade and I'm going into 8th. She expects a lot out of me and I don't want to disappoint her.

The one element present in each of the girl's lives, without exception, is unquestioning, constant family support and help when needed. This takes different forms and may come from siblings or other relatives as well as from mom and dad but is there for all of these girls. Girls report that one or both parents help them regularly when they have trouble doing homework. Some examples of what the girls say about the kind of help they receive:

Ann: When I couldn't do some of the problems in homework I told my mom and she said "okay we will work on them", because she buys workbooks like the teachers use. She buys them from everywhere and she makes me work on the weekends and over the summer.

Keisha: If I have a problem I can't solve and I go to my mom and she can't figure it out then my dad will sit down with me after dinner and we will go through it step by step until we figure out the answer. Basically he helps me along but I do most of it.

- Interviewer: What would your parents do if you got a bad grade?
- Brandy: They wouldn't get mad at me, they would ask me why I got the bad grade and then help me to improve. I don't think they would get mad at me, I think they would help me. They would probably hire a tutor.
- None of the girls seemed to feel that their parents put excessive pressure on them to succeed; they seemed to have adopted or internalized their parents expectations and made them their own.
- Melissa: My mom and dad brought me up as a straight A students and I am used to getting straight A's and if I get a B I am really disappointed.
- Interviewer: Do they[parents] put pressure on you?
- Melissa: No, really they just like me to do my work and try to get better grades if I get bad ones.

Desire to Understand Math

These girls all want to understand what they are doing in math. One said she wants to know *if I'm really learning and not just memorizing*.

- Gail: I didn't just look at [my returned test or homework papers] and go "Oh, yeah, this is right or this is wrong". If I found something wrong and the teacher gave me the right answer I would go back and try to figure out what I did wrong and how to solve it.
- Alice: I like a challenge and not just something I can zip through. Something I really have to think about and work hard to get the answer. You have to know how you got the answer. You have to know all kinds of math, not just one type. You have to be good at all the steps, not just knowing the answer.

The desire to understand, and their opinions of their teachers, came out in response to the question "How was math for you this year?" They were not asked directly about their teachers but all gave an opinion which, in almost every case, depended on whether the teacher helped them understand the topic or concept being studied. Six girls said they had good teachers; *She really helped me understand it or she did a lot of activities with us and it wasn't just out of the book*.

- Angel: We had a really good teacher. She made it a lot of fun and she made it easier so if we didn't understand she explained it really well and went over it until everybody got it.

Four girls had both positive and negative things to say about their teachers while six were critical of teachers who *really didn't want anybody to do anything well*.

- Fran: [She] let the boys get her off track and then she confused everybody when she tried to explain [in the time remaining].

Several complained about teachers who wanted students to do problems only one way.

- Sitna: Sometimes I felt like the teacher wouldn't spend enough time on one thing. Sometimes I wouldn't understand things the way she was going through it and some of the times she wanted us to do the problems her way and that was harder for me because I knew my own simple way.

Then there was Kelly who only said that her teacher was *grumpy all year long* and made her feel that she wasn't doing her best.

Assertiveness

These are not the "good girls" who are passive in class, remaining quietly in the background while the teacher asks the boys the hard questions. Their desire to understand, as well as their desire to get a good grade, prompts them to ask questions in class and to seek help offered by teachers before and after class. One girl explained that she had to "take the lead" in asking questions.

Lisa: Nobody would ask questions rarely [if] ever because they'd be embarrassed or something.

Interviewer: Did you ask questions?

Lisa: Yes. And then other people would ask a question after I did. So they'd not feel so embarrassed if somebody [else] started out asking questions.

Another said, *If I don't get it, I don't get it and I'm just going to raise my hand*. When these girls get lower grades than they want they go to the teacher and ask why they got the low grade and what they can do to bring it up.

Interviewer: What would you do if you got a C?

Marlene: I would ask the teacher how I got it and ask her to tell us the percentage of the grade and stuff like that. And I would go to her and ask how did I get this [grade] and sometimes if she had problems with it she might raise your grade a couple of points

Interviewer: Would you mind going in after school for help?

Marlene: We did that. The math teacher had a whole bunch of kids after school.

Belief in Hard Work

What they all do to bring up a grade or maintain an A, is to work hard or harder and what makes them happy when they get the grade they want is *I know I worked for it*. When they get the A that they all work for and expect, they feel good *because I know I worked for it* or *because I really pushed myself* or *because I worked so hard for that grade*. When they don't get the grade they want or expect, they don't blame the teacher; they put the onus on themselves. *I go back and try to figure out what I did wrong* or *I ask for extra help and study more and make sure I understand the topic*. *If I got a C, said Sitna, I'd just work more and ask the teacher for stuff to review*.

For these high achievers, a good math student is *someone who tries hard and does their best*. One of the questions posed to all the girls was "What is your definition of an excellent math student? The responses given below are representative of the group.

Sitna: Somebody who always tries their hardest and not necessarily a great, you know, a highly great person. [One] who asks questions in class, who's always participating, never half asleep or anything and always trying their best to do what they can.

Marlene: One that is working and tries the hardest but then also asks questions and actually understands it and keeps working.

And what did Kelly, who said her teacher was grumpy all year and not very helpful, do? This is what she said:

Kelly: I went back into the books and I had taken Sylvan Learning Center and I asked them for help and they went over it with me. I took notes in class and we had a student teacher that helped us. I wrote down notes and did extra problems so I would do my best. And that worked.

EDUCATIONAL IMPORTANCE

These interviews present a picture of girls who like math, who are almost desperately serious about their schoolwork. They want to live up to the expectations of their parents but also want to live up to their expectations for themselves. They worry about alienating their friends by making good grades but are not deterred. The interviews confirm what we have long known, that girls, unlike boys, believe that success comes from hard work rather than ability (Wolfeat, Pedro, Fennema and Becker, 1990). This theme ran through all the interviews; girls returned to it over and over. A survey of teachers involved in *Girls on Track* found that teachers think that girls who make As work harder than boys who make As. But these are not the girls referred to by Johnston and Nichols (1995) who "work hard absorbing cut and dried knowledge" (p. 97). All 16 girls, without prompting said that they want to understand what they are studying in mathematics. The want to know how problems work not just how to work problems and get the right answers.

A number of researchers report that teachers in their studies believe that boys have more ability in mathematics than girls (Li, 1999). In a study of the gender beliefs of Finish teachers, Soro (2002) states that teachers believe boys think more deeply about mathematics than girls. These studies find that teachers, including the *Girls on Track* teachers, believe that girls work hard or put more effort into their studies than boys. We question if these stereotypical beliefs about boys and girls reflect a devaluation of effort and hard work on the part of teachers.

Cook-Sather (2002) advocates conversations with students as an important step towards educational reform and the need to incorporate students' perspectives in policy and practice issues. Rather than examining girls' deficits in relation to the culture, here we reported on girls' beliefs about the strengths they bring to the study of mathematics. As a consequence of this perspective, we must examine our world-views about girls' beliefs. We question the education culture's lack of value of hard work for adolescents in mathematics. Despite evidence to the contrary, many continue to believe in the "math gene," especially for boys (Soro, 2002). Recall that we are not studying gifted youth, but those who achieve in the top 20-30%. These attitudes send messages to boys and girls that if you just use your innate ability to understand mathematics, without studying, then you have more value than someone who has ability and works hard to understand mathematics. Certainly as adults, and especially as women, we know the value of hard work to attain life goals. Girls learn from us about hard work, only to be disappointed when their efforts are not valued in an educational setting. We ask, *What's wrong with working hard in math class?*

References

- Beaton, A., Mullis, I., Martin, M., Gonzalez, J., Kelly, D., & Smith, T. (1996). *Mathematics achievement in the middle school years*. Boston: Center for the Study of Testing, Evaluation, and Educational Policy, Boston College.
- Chipman, S. (1996). Female participation in the study of mathematics: The US situation. . In G. Hanna (Ed.), *Toward gender equity in mathematics education* (pp, 285-296). Boston: Kluwer.
- Cook-Sather, A. (2002). Authorizing students' perspectives: Toward trust, dialogue, and change in education. *Educational Researcher*, 31 (4), 3-14.
- Damarin, S. (1995). Gender and mathematics. In W. Secada, E. Fennema, & L. Adajian (Eds.), *New directions for equity in mathematics education* (pp. 242-257). New York: Cambridge University Press.
- Fennema, E. & Sherman, J. (1977). Sex-related differences in mathematics achievement, spatial visualization and sociocultural factors. *American Educational Research Journal*, 14, 51-71.
- Fennema, E. (1996). Mathematics, gender, and research. In G. Hanna (Ed.), *Toward gender equity in mathematics education* (pp.9-26). Boston: Kluwer.
- Johnston Johnson, P. & Nicholls, J. (1995) Voices we want to hear and voices we don't. *Theory into Practice*, 34 (2), 94 -100.
- Li, Q. (1999). Teacher beliefs and gender differences in mathematics: A review. *Education Research*, 41(1), 63-77.
- Ma, X., & Kishor, N. (1997). Assessing the relationship between attitude toward mathematics and achievement in mathematics: A meta-analysis. *Journal for Research in mathematics education*. 28(1), 26-47.
- Ruffell, M., Mason, J., & Allen, B. (1998). Studying attitude to mathematics. *Educational Studies in Mathematics*, 35. 1-18.
- Shultz, J. & Cook-Sather, a. (2001). *In our own words*. Lanham, MD: Rowman and Littlefield.
- Sorro, R. (2002). Teachers' beliefs about gender differences in mathematics: 'Girls or boys?' scale. In A. Cockburn & E. Nardi (Eds.), *Psychology of Mathematics Education 26: Proceedings of the 26th Annual Conference*, (pp. 4-225-4-232). East Anglia University, UK.
- Wolfe, P., Pedro, J., Fennema, E. & Becker, A. (1980). Sex differences in high school students' causal attributions of performance in mathematics. *Journal for Research in Mathematics Education*, 11 (5), 356 - 366.

•

Page Intentionally Left Blank

MENTAL FUNCTIONING OF INSTRUMENTS IN THE LEARNING OF GEOMETRICAL TRANSFORMATIONS

Verónica Hoyos

CAEM, Universidad Pedagógica Nacional, Mexico

*A case study is presented on what is learned by a very advanced Math student in a ninth grade class (fifteen years old, approximately). This case was obtained from an exploratory study¹ carried out in a classroom of eighteen students when the employment of certain cultural artifacts was introduced to approach the theme of basic geometrical transformations. The analysis of the activity from a communicational approach to learning (Sfard, 2001) was useful to detect objectification of the geometric properties involved. Also, probable use schema construction derived from the manipulation of Cabri-*II*² software and of large jointed machines allowed for hypotheses to be put forward on the realization of internalization processes (Mariotti, 2002).*

THEORETICAL FRAMEWORK

The first step for all socio-cultural and historic points of view on the studies of mind (Cole, 1995, p. 190), is the assumption that the defining characteristic of the human species is its need and ability to inhabit an environment transformed by the previous members of its species. Such transformations, together with the transfer mechanism for these transformations from one generation to another, are the result of an ability/proclivity among humans to create and employ artifacts. Artifacts, in turn, are features of the material world incorporated into human action as means of coordination or articulation with the physical and social environment.

Since school use of computers and new technologies is on the rise, it becomes urgent to identify key points around which to organize their use in fostering diverse educational processes (Mariotti, 2002, p. 697).

One of the current lines of research into processes of semiotic mediation, specifically cognitive processes of instrumental genesis, with the source of its analysis being the self-same nature and manipulation of the artifacts employed (Mariotti, 2002).

This approach (idem, p. 703) sees an instrument as the unity between an object (any artifact, such as a technical mechanism) and the organization of potential actions or plans

¹ Details of this exploration may be found in the research report “ Coordinating mediation of activity in the learning of geometrical transformations,” published in the proceedings PME-NA 2002.

² In particular, the geometric transformations’ menu was used jointly with the Help command, which displays a legend that *explains* the general features of the transformation in question and *names* the elements therein. This Help command plays a central role in our study, as could be seen on the research report “Coordinating mediation of activity in the learning of geometrical transformations,” published in the proceedings PME-NA 2002.

for use, which thus constitute a structured set of invariants corresponding to a class of possible operations. These schema function as organizers for the user's activities.

According to Vygotsky's notion of internalization (Mariotti, 2002, p. 706), the internalization process can transform tools into psychological tools when an internally oriented tool becomes a "psychological tool" and molds new meanings. It is in this sense that a tool can function as a semiotic mediator.

Mariotti (*idem*, p. 707) points out that a key facet of the internalization process is the distinction between the use of an artifact with an external or internal orientation together with a transition from the external to an internal orientation. In this view, an artifact and the schema for its use become an instrument, which can function internally, and once implemented contains the potential to shape new meanings.

In addition, Crawford's (1996, p. 137) review of the contributions by Russian theorists into the functioning of the mind reports Davidoff's position that the internalization process entails not only a transition from the external to the internal plane, but also a transition from collective to individual activity.

In the framework of this transition, this paper presents one student's results at the end of each practical activity. This high-achieving student is named Guillermo. Just as in Crawford's work (*ibidem*), the collective activity took place as a joint practical activity and was expressed through communication and language.

Finally, recent progress into a communicational approach to learning (Sfard 2001) in the classroom allows for understanding the reflection process as a mediator among the intellectual and personal components of cognitive activity. This is in accordance with Semenov (Crawford 1996, p. 139) having in mind the thought phenomena that occurred during problem solving.

The latter would be equivalent to saying (Crawford 1996, p. 137) that the subjects establish connections starting from reflecting on the objects of a problem and moving toward consideration and evaluation of their own acts and strategies throughout the process of cognitive activity.

AIMS, METHODOLOGY, AND RESULTS

The observations detailed below were collected from an exploratory study (see endnote (i)) carried out in a ninth grade class in a public school in Mexico. As may be seen by his actions, Guillermo is an outstanding student within the classroom observed. With ease and accomplishment he worked, paired with a student named Aníbal, all the tasks presented in a set up of then practical activities (50 minutes each) implemented in the classroom. Video logs were obtained of Guillermo's communication, especially because each pair was asked to describe what they had done at the end of each designed activity.

It might soon see that their descriptions reveal differing use schemes for the artifacts, as well as an internalization or assignment of new meanings. The latter probably will be made manifest through a later example of his solution to one of the problems assigned.

First, it is intended to present empirical references to the use schema construction or instrumentalization; then the probable articulation of this instrumentalization, together with the possible internalization and objetification the student achieved.

Instrumental genesis

At the end of the reflection and translation learning activities, during his description of what he had accomplished, Guillermo makes reference to the various moments of the activities performed during the two learning scenarios that were set up (see the bibliographical reference as in the endnote (i)). First, the student briefly mentions what he did within Cabri-II. Then, when describing his work with the pantographs, it might be seen how he advances toward characterization of geometry's invariants of the reflection and translation. The description might show how he mentally incorporated the use of other geometric tools (like the ruler and compass, which at no time were physically present) to that of the jointed machines instrumented here.

Guillermo describes activating Cabri-II's Reflection command as making the initial and image objects "move in opposite directions:"

Guillermo (hereinafter G): What we saw with this machine [the jointed machine for reflection or axial symmetry] was the same as for axial symmetry, what we were seeing, for example... If we took these by one point, then they are moved [two corresponding points in an initial triangle and its image] [it is noticed that he is manipulating the jointed machine, moving its drawing guide] they go opposite ways. Like [what] we were seeing within the Cabri software... What we were verifying here [with the jointed machine] was that axial symmetry is practically a reflection of the original figure, if we move [the design guide] to the left ... As an example, when we move the original figure from left to right, the reflection goes from left to right. [his partner Aníbal signals he has made a mistake] Yes. So what did you notice about the relationship?

Interviewer (hereinafter I): Let's see. Let's see. Once more.

G: If you move from left to right, [G now handles the jointed machine's design guide] this [the jointed machine's tracer] moves from right to left.

I: And so where will the axis of symmetry be here?

G: The axis of symmetry would be this line. [he points to the bar that serves as the machine's axis of symmetry]

I: And so if I say, put a point here, [I sets a point on one of the figures the students drew earlier, on the same work plane under the machine] how will I know which is the corresponding one — without using the machine?

G: This one... [the point the interviewer set down] ... Tracing a line [he picks up a ruler and places it over the jointed machine, perpendicular to the axis of symmetry] that is perpendicular. We make it go through the point and, in this figure over here, [in the image] we can calculate more or less where it will appear, which will be round about here.

I: Yea. But if I don't have any figure, [the interviewer places a point anywhere outside the figures the students have drawn] say, I just have this point, so, how do I know which is the corresponding one over there [in the image plane]?

- G: It'll be just the same, doing a line that crosses perpendicularly.
- I: Yea, so that it crosses, for example, here, [the interviewer places the ruler over the axis of the machine] I trace a perpendicular...
- G: Right from this one, [the student shows the perpendicular's point of intersection, which was signaled physically with the ruler the instructor placed on the axis of symmetry] we could take a compass, [the student opens his hand, he's forming a compass with his fingers] and draw a circle that goes the radial distance from here to here, [he now shows with his fingers a perpendicular segment from the drawn point to the axis of symmetry] so here, [showing by hand a portion that would be the complement of the diameter of an imaginary circle he has traced with his finger compass] where the line intercepts the circle, [the imaginary circle] we'll get the point.

Comment: In reality, in the preceding passage Guillermo's statement on the reflection properties (or axial symmetry) has both degrees of specificity and generality that indicate he has abstracted and made objective the invariant property of geometrical reflection. It is also noteworthy that the mental experiment he is performing in response to the question about how we find the reflection of any point placed on the work plane, as well as the way he accompanied these actions ostensibly (by moving his hands). Further, it is interesting to note how this segment shows that from the interaction between the Interviewer (I) and the student (G), G makes progress in the precision of reflection's principal property: any two corresponding points under reflection will be at the same distance of the axis of this transformation.

Internalization

As explained above, Guillermo is an outstanding student, who even from the first description of what he performed on dilation with the software — unlike the executions of his classmates — achieved remarkable precision and signification on the use of terms and the degree of generality and specificity of his symbolic representations:

- I: [as the students describe their computer work] Which ... which longitude?
- Aníbal: What we have between this... [indicates the computer screen] What there is between A and A', and between ...
- G: [Points at the monitor] From A' to point O, or the dilation [center], from B' to the point, [at the center of dilation O, which he indicates with his finger]; from C' to the point, [idem previous note] and from A, B, and C to the point [idem previous note], so you can get them and divide them and see if they coincide with... with... What is it? With the...
- A: With the scale?
- G: Yea ... With the scale.
- I: Or the dilation factor. Yea, scale. That's fine, or the dilation factor.

While the description Guillermo and Aníbal draw out is now quite coherent insofar as the properties of dilation, in fact, what is of interest to us right now is the description Guillermo composed for the written report at the end of the task.

Comment: In this direct quote there appears an explicit reference to the angles of the figures, which would complement his earlier description in answer to the computer worksheet on dilation.

Solving problems and idiosyncratic evaluation

To exemplify the signification and use of the geometric properties he learned, we cite Guillermo's answer to problem 2, which read like following.

Problem 2. "Points P' and Q' are the points reflected of P and Q in respect to line L Can you find line L using your ruler, but without measuring? Which lines can you trace to find the reflection axis?"



Figure 2. An image of Problem 2.

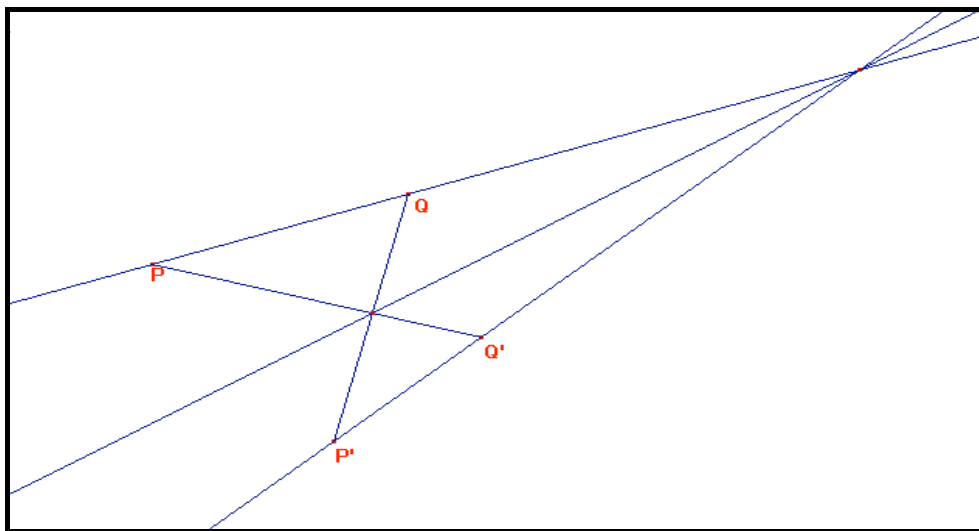

Figure 3. Guillermo's graphic solving procedure to Problem 2.

The description of Guillermo's solution was the following:

I: Let's see. Explain this [what you did] to me, Guillermo.

G: First, since the points are like this, in a trapezoid, I took point Q and point P', [see above for the figure and lines] and made a segment, just like with P and Q'. Then to get the other point, to make the straight line, I extended the segment that goes from P to Q and from P' to Q' and got a point of intersection. So this point of intersection and this one [points to the first point of intersection obtained, to the intersection of the diagonals of quadrilateral PQQ'P'] join with a straight line. And the straight line comes up, which is the one that makes the axis of symmetry.

The final passage also might concern the question of internalization and/or signification of the terms in use. We present a segment of the last interview with Guillermo, where he was asked to offer his opinion about the work he carried out in all the sessions:

I: Let's see Guillermo, tell me how you feel about these work sessions.
G: Yea, well, alright.
I: Right. Has what we've done been interesting for you?
G: Yea, because it made us think awful hard.
I: Yes. Did you like the computer work?
G: Yea, just that it's easier with the computer than doing it here, directly. [he points to the jointed machines]
I: But the work with these machines, does it seem productive? I mean, it leaves you with something. Interesting, isn't it?
G: You learn more than with computers, cause you do the work.
I: You learn more with computers, is that what you think?
G: No, you learn more here, [points to the jointed machines] cause here you do the work and the tracing and on the computer the only thing you do is lead it.

It is clear that Guillermo finds the work with the jointed machines more significant. From our point of view this is so due to the role these artifacts played here in order to reflect on the actions taken to solidify or objectify the notions whose learning was in play.

Students might naturally tend to assign greater value to learning gained once it an objectivization process has taken place, as they will contrast their current capacities against those they had previously been able to perform, during a previous stage. Upon completion of the activities, Guillermo feels armed with techniques and notions that provide problem-solving abilities (see for example his solving procedure to Problem 2), about the geometrical problems that he may not have been able to confront at the conclusion of the first stage of learning.

Idiosyncratic use of contextual terms (as Guillermo has just shown) to evaluate attainments fulfilled might be evidence of cognitive attainment that probably is only reached through accomplished internalization of instruments in use.

CONCLUSIONS

The actions performed in the second scenario* were structured inversely from those implemented in the first. In the first scenario, the support provided by the Cabri-II

software allows initial activation of the invariant geometric properties involved in the chosen geometric transformation, by accessing the geometric transformations' menu. On the other hand, in the manipulation of pantographs, the necessary first step was to create a drawing and establish a comparison with the drawing obtained simultaneously from the tracer of the jointed machine in turn. Straight away, students were asked to determine what kind of geometric transformation was being used. It was in fact, an inversion of the procedure compared to the actions performed within Cabri-II.

In this way, complementary to what was obtained from using the software, an objectification was observed in the second scenario, resulting from manipulating of the jointed machines, or pantographs. It evidenced greater comprehension of the notions in relation to a more appropriate mathematical use of the terms. The evidence that students have established numerical or specific relationships between the traced figures might demonstrate how the terms or symbols in use could become adequate representations of invariant properties of geometric transformations.

Finally, it might be that the probable internalization that may have occurred throughout the implementation of learning scenarios set up here — speaks of a research productive issue into mediated action (Wertsch, 1993), which could be developed at the classroom, as this piece of research attempted to show.

References

- Cole, M. (1995). Sociocultural setting, intersubjectivity, and the formation of the individual. In Wertsch, J., Del Río, P., and Alvarez, A. (Eds.), *Sociocultural Studies of Mind* (pp. 1-34). USA:Cambridge University Press.
- Crawford, K. (1996). Cultural Processes and Learning: Expectaciones, actions, and Outcomes, Chap.9 in *Theories of Mathematical Learning*. Steffe, Nesher, Cobb, Goldin, Greer (eds.), New Jersey: LEA.
- Mariotti, A. (2002). "The Influence of Technological Advances on Students' Mathematical Learning". In Lyn D. English (ed.), *Handbook of International Research in Mathematics Education*. New Jersey: LEA, Pub.
- Sfard, A. (2001). Learning Mathematics as Developing Discourse. Speiser, R., Maher, C., & Walter, Ch.(eds.), *Proceedings of PME-NA XXIII*. ERIC: Snowbird, Utah (USA).
- Wertsch, J. (1993). *Voces de la Mente: Un enfoque sociocultural para el estudio de la acción mediada*. Madrid: Visor (Aprendizaje).

A PERSPECTIVE FOR EXAMINING THE LINK BETWEEN PROBLEM POSING AND PROBLEM SOLVING

Jinfa Cai Stephen Hwang
University of Delaware

In a previous study, we posited a link between Chinese sixth grade students' problem solving and problem posing based on a pattern-formation strategy (Cai & Hwang, 2002). A similar parallel structure between problem solving and problem posing did not obtain for the U.S. sixth graders in the study. The present study attempts to locate this type of parallel structure by analyzing a broader sample of U.S. students. The results of this study show that U.S. seventh graders are much more likely than sixth graders to use abstract strategies. The findings appear to support a relationship between the use of abstract problem solving strategies and the tendency to pose extension problems (problems that go beyond the given information) for the seventh graders.

INTRODUCTION

Problem posing lies at the heart of mathematical research and scientific investigation. Indeed, in scientific inquiry the process of formulating a problem well can be more significant than the discovery of a solution to the problem (Einstein & Infeld, 1938). In mathematics education, there is a broad consensus that students should have the opportunity to develop their mathematical problem posing abilities (Brown & Walter, 1990; NCTM, 2000). It has been suggested that such activities not only help to lessen students' anxiety and foster a more positive disposition towards mathematics, but they may also enrich and improve students' understanding and problem solving (Brown & Walter, 1990; NCTM, 2000; Silver, 1994).

Given the importance of problem-posing activities in school mathematics, some researchers have started to investigate various aspects of problem-posing processes (e.g., Silver, 1994). One important direction for such investigation has been to examine the link between problem posing and problem solving (e.g., Cai & Hwang, 2002; English, 1997; Silver & Cai, 1996). Kilpatrick (1987) provided a theoretical argument that the quality of the problems subjects pose might serve as an index of how well they can solve problems. Certainly, effective problem solving strategies can often involve the posing of related or subsidiary problems (Polya, 1957). In addition, several researchers have conducted empirical studies to examine the link between problem posing and problem solving. For example, Silver and Cai (1996) analyzed the responses of more than 500 middle school students to a task asking them to pose three questions based on a driving situation. The students' posed problems were analyzed by type, solvability, and complexity. Silver and Cai used eight open-ended tasks to measure the students' mathematical problem-solving performance. They found that problem-solving performance was highly correlated with problem-posing performance. Compared with less successful problem solvers good problem solvers generated more, and more mathematically complex, problems. However, in this study the problem solving tasks and problem posing tasks were not embedded in parallel mathematical contexts.

In a recent cross-national comparative study, Cai and Hwang (2002) examined the relationships between sixth grade students' problem posing and problem solving using tasks with identical mathematical structures. They found differential relationships between problem posing and problem solving for U.S. and Chinese students. There was a much stronger link between problem solving and problem posing for the Chinese sample than there was for the U.S. sample. In addition, they found a parallel between the Chinese students' problem solving strategies and the sequences of problems they posed, while no such parallel could be identified for the U.S. sample. Cai and Hwang speculated that the differential relationships between problem posing and problem solving for U.S. and Chinese students might be due to the disparities in the U.S. and Chinese students' problem-solving strategies. While the Chinese students were more likely to use abstract strategies, the U.S. students almost exclusively used concrete strategies and drawing representations. This relatively consistent lack of abstract strategy use made it impossible to identify a similar link between problem solving and problem posing for the U.S. sixth graders.

Only sixth grade U.S. and Chinese students were included in the above-mentioned study. From a developmental perspective, it is probable that older students would be more likely to use abstract problem solving strategies. The main purpose of the present study is to examine both U.S. sixth and seventh grade students' mathematical problem solving and problem posing in the hope of identifying a link between the two. If, indeed, the seventh graders are much more likely to use abstract problem solving strategies than the sixth graders, one would hope to see a similar link between problem solving and problem posing as was observed in the Chinese sample in Cai and Hwang (2002).

METHOD

Subjects

A total of 98 sixth graders (42 girls and 56 boys) and 109 seventh graders (52 girls and 57 boys) participated in the study. These students were selected from four public schools in suburban Pittsburgh. Although the sample is not atypical for the Pittsburgh area, the expectations for students in these schools are high, with each of the communities proud of the percentage of their students who go on to higher education. The majority of the students come from middle-class families; only a small proportion (about 3%) would qualify for reduced-price lunches.

Tasks and administration

Three pairs of problem-solving and problem-posing tasks were administered to each student. Figure 1 shows the two pairs of tasks for which data are reported in this paper. For each of the problem posing tasks, students were asked to pose one easy problem, one moderately difficult problem, and one difficult problem. For each of the problem-solving tasks, students were asked to answer several questions based on the given pattern. The problem-solving tasks were collected in one booklet and the problem-posing tasks in another. Students were given 20 minutes to complete the tasks in the problem-posing booklet. The following day, students were given 40 minutes to complete the three problem-solving tasks. All data were collected via students' written responses.

Dots Problem-Solving: Look at the figures below.



(Figure 1) (Figure 2) (Figure 3)

1. Draw the 4th figure.
2. How many black dots are there in the 6th figure? Explain how you found your answer
3. How many white dots are there in the 6th figure? Explain how you found your answer.
4. Figure 1 has 8 white dots. Figure 3 has 16 white dots. If a figure has 44 white dots, which figure is this? Explain how you found your answer.

Dots Problem-Posing: Mr. Miller drew the following figures in a pattern, as shown below.



(Figure 1) (Figure 2) (Figure 3)

For his student's homework, he wanted to make up three problems BASED ON THE ABOVE SITUATION: an easy problem, a moderate problem, and a difficult problem. These problems can be solved using the information in the situation. *Help Mr. Miller make up the three problems.*

Doorbell-Solving: Sally is having a party, the first time the doorbell rings, 1 guest enters.

The second time the doorbell rings, 3 guests enter.

The third time the doorbell rings, 5 guests enter.

The fourth time the doorbell rings, 7 guests enter.

Keep on going in the same way. On the next ring a group enters that has 2 more persons than the group that entered on the previous ring.

1. How many guests will enter on the 10th ring? Explain how you found your answer.
2. In the space below, write a rule or describe in words how to find the number of guests that entered on each ring.
3. 99 guests entered on one of the rings. What ring was it? Explain or show how you found your answer.

Doorbell-Posing: Sally is having a party, the first time the doorbell rings, 1 guest enters.

The second time the doorbell rings, 3 guests enter.

The third time the doorbell rings, 5 guests enter.

The fourth time the doorbell rings, 7 guests enter. Keep

on going in the same way. On the next ring a group enters that has 2 more persons than the group that entered on the previous ring. For his student's homework, Mr. Miller wanted to make up three problems BASED ON THE ABOVE SITUATION: an easy problem, a moderate problem, and a difficult problem. These problems can be solved using the information in the situation. *Help Mr. Miller make up the three problems.*

Figure 1: Two pairs of problem-solving and problem-posing tasks

Data coding and inter-rater reliability

Student responses were coded using the schema in Cai and Hwang (2002). Each response to a problem-solving task was coded for three factors: correctness of answer, mode of representation, and type of solution strategy. Details about solution strategies and representations are described in the results section. Student responses to the problem-posing task were coded along two dimensions. The posed problems were first classified into extension problems, non-extension problems, or others. A problem is considered an extension problem if it asks about the pattern beyond the first several given figures or terms. A non-extension problem restricts itself solely to the first several given figures or terms in a pattern. After this initial coding, each extension or non-extension problem was further categorized according to the nature of the problem. To ensure high reliability in the data analysis, two raters independently coded at least 10% of the student responses from each sample. The inter-rater agreements were 91% to 100% for coding correctness of answers, solution strategies, and solution representations in problem solving tasks. The inter-rater agreements were 84% to 92% for coding responses to the problem posing tasks.

RESULTS

Problem solving

Table 1 shows the percentages of sixth and seventh grade students correctly answering each of the four Dots questions and two Doorbell questions. Overall, the seventh graders have a significantly higher mean score for the six questions than the sixth graders (means of 3.8 and 2.8, respectively; $t = 4.505$, $p < .001$). As Table 1 shows, the results are essentially consistent across the two tasks. As might be expected from the increasingly abstract nature of the problems in each situation, the students in each grade experienced more difficulty as they worked through the sequence of problems in each situation. Comparing the performance of students across grade levels, it is clear that the seventh graders generally outperformed the sixth graders on all problems.

Grade	Dots Q1	Dots Q2	Dots Q3	Dots Q4	Doorbell Q1	Doorbell Q3
6 (n=98)	76.5	50.0	35.7	27.6	70.4	23.5
7 (n=109)	87.2	75.2	50.5	39.4	83.5	41.3
<i>p</i>	.05	.00	.03	.07	.03	.01

Table 1: Students' success rates on each of the Dots and Doorbell questions

To examine students' solution strategies, we focused on the last Dots question and the last Doorbell question. These questions were the most amenable to the use of abstract problem solving strategies. Each strategy was coded as concrete, semi-abstract, or abstract. Concrete strategies involve making lists, drawing pictures, or guessing and checking. Semi-abstract strategies consist of multiple computational steps without a recognition of the overall pattern. For example, a semi-abstract strategy for finding the ring number at which 99 guests entered might look like: $99 \div 9 = 90$; $90/2 = 45$; $45 + 5 = 50$. Abstract strategies were based on some recognition of the general pattern governing the problem situation. For example, for the Dots questions, a student who realized that

the number of white dots in the n th figure was $(n + 2)^2 - n^2$ was coded as using an abstract strategy. Strategies that were fundamentally incapable of producing a correct answer were coded as unfeasible. Table 2 shows the percentage distributions of students in each grade using concrete, semi-abstract, and abstract strategies.

Grade	Dots Question 4				Doorbell Question 3			
	Concrete	Semi	Abstract	Other	Concrete	Semi	Abstract	Other
6 (n=98)	62.2	5.1	0.0	32.7	35.7	7.1	5.1	52.0
7 (n=109)	52.3	10.1	0.0	37.6	29.4	13.8	11.0	45.9

Table 2: Percentages of students using each of the strategies

As expected, abstract strategy use increased with grade level. The seventh grade students tended to use more abstract strategies than the sixth graders. However, this trend is more evident in the Doorbell question than in the Dots question. This is primarily due to the fact that no student in either grade chose an abstract strategy for the Dots question. There was, however, an increase in the use of semi-abstract strategies for the seventh graders.

Comparing the abstractness of strategies with students' problem-solving success, it appears that those sixth and seventh grade students who used more abstract strategies tended to have a higher success rate. In particular, students who used an abstract strategy for Doorbell question 3 had a success rate of 85%, but those students who used concrete strategies only had a success rate of 53%. Because no student used an abstract strategy for the last Dots question, there is no data to make a similar comparison.

Problem posing

As noted above, each posed problem was coded as an extension problem or a non-extension problem. In general, an extension problem is a problem concerning the pattern beyond the given figures. However, some problems were phrased so generally as to make it difficult or impossible for a solver to know how to answer them (e.g., "What's the pattern?"). Based on our previous work, we chose to exclude these problems from the category of extension problems in further analyses.

Looking from the sixth to the seventh graders, there is a definite trend in extension problem posing. In both the Dots and Doorbell situations, the seventh graders appear to pose more extension problems. The mean number of extension problems posed by sixth graders is 0.48 for the Dots situation and 1.58 for the Doorbell situation. In contrast, the mean number of extension problems posed by seventh graders is 1.03 for the Dots situation and 1.83 for the Doorbell situation.

Table 3 shows the percentage of students in each grade posing zero, one, two, or three extension problems for both Dots and Doorbell situations. While less than 15% of the sixth graders generated at least two extension problems for the Dots Situation, about 37% of the seventh graders did so ($z = 3.86$, $p < .01$). A similar, but weaker version of this pattern holds for the Doorbell data. Overall, the students appear to have produced more extension problems for the Doorbell situation than for the Dots situation.

Grade	Dots Situation				Doorbell Situation			
	Zero	One	Two	Three	Zero	One	Two	Three
6 (n=98)	69.4	17.3	9.2	4.1	28.6	15.3	25.5	30.6
7 (n=109)	48.6	14.7	22.0	14.7	20.2	15.6	25.7	38.5

Table 3: Percentages of students posing zero, one, two, and three problems

Beyond the division into extension and non-extension problems, the posed problems were coded into specific categories based on the types of questions being asked. The posed problems for the Dots situation were classified as: (1) Count dots in one figure, (2) Count dots in multiple figures, (3) Compare number of dots in figure(s), (4) Draw a figure, (5) Specific rule-based problems, and (6) General rule-based problems. The posed problems for the Doorbell situation were classified into: (1) Number of guests on a ring, (2) Ring number for some number of entering guests, (3) Total number of guests for several rings, (4) Total number of rings for some total number of entered guests, and (5) Specific rule-based problems.

Regarding the type of problems posed, there is little difference between the sixth and seventh graders in either situation. Looking across all the posed problems related to the Dots situation in both sixth and seventh grades, the most common types were the general rule-based problems and extension problems asking for the number of dots (black, white, or both) in a single figure. In addition, there were a considerable number of extension problems that asked for a drawing of a figure. In the Doorbell situation, the most common posed problem type was an extension problem asking for the number of guests entering at a given ring number. A substantial number of the posed problems were coded as irrelevant or missing. Of the remaining cases, the most common were extension problems asking for the total number of guests that had entered at a given ring number.

Relationships between problem solving and problem posing

Since the students did not use any abstract strategies for the Dots problem-solving task, this part of the analysis is limited to the Doorbell problem-solving task. For the seventh graders, students who posed at least two extension problems tended to use problem-solving strategies that were more abstract. Specifically, over 30% of the students who posed at least two extension problems used abstract strategies, but only about 14% of the students who posed fewer than two extension problems did so. For the sixth graders, this pattern does not appear to hold. This seems to be due to the fact that very few sixth graders chose to use abstract strategies.

Problem-solving success appears to be related to the tendency to pose extension problems across the two grade levels and two problem situations. Table 4 shows the relationship between problem solving performance and the number of extension problems posed. Indeed, the sixth graders posing at least two extension problems outscored their counterparts posing fewer than two on every problem except the first Dots problem, often by more than ten percentage points. In the case of the seventh graders, all the Dots and Doorbell questions follow this pattern.

	Dots Questions				Doorbell Questions	
	Q1	Q2	Q3	Q4	Q1	Q2
<i>6th Graders</i>						
At Least 2 Extension	69.2	61.6	53.8	38.5	92.3	30.8
Fewer Than 2 Extension	77.6	48.2	32.9	25.9	67.1	22.4
<i>7th Graders</i>						
At Least 2 Extension	92.5	85.0	52.5	40.0	87.5	50.0
Fewer Than 2 Extension	84.1	69.6	49.3	39.1	81.2	36.2

Table 4: Problem solving success vs. Number of extension problems posed

DISCUSSION

In our previous study, we posited a link between Chinese sixth grade students' problem solving and problem posing based on the notion of a pattern-formation strategy (Cai & Hwang, 2002). The Chinese students tended to solve problems using abstract strategies, finding and applying formal patterns. This tendency toward a pattern-formation strategy found a parallel in the problem posing results. A common sequence of problems posed by the Chinese students began with a problem that could be interpreted as data collection (e.g., counting the number of dots in multiple given figures). This was followed by a problem that resembled a data-analysis and trend-seeking strategy (e.g., comparing the number of dots across multiple given figures). The final problem was often of an extension type, as if testing or making use of a proposed pattern. A similar parallel structure between problem solving and problem posing thinking did not obtain in the U.S. sixth graders in the study.

The present study attempts to locate such a parallel by analyzing a broader sample of U.S. students. One way to conceptualize a link between problem solving and problem posing activities lies in the realization that complex problem solving processes often involve the generation and solution of subsidiary problems (Polya, 1957). Because extension problems are defined as involving an extrapolation from given data to unknown situations, it seems reasonable to believe that the ability to pose such problems would be associated with more robust problem solving abilities. More specifically, one might expect that abstract problem-solving strategies would be most benefited by a propensity for posing extension problems, since abstract strategies depend on the ability to identify and make use of the patterns that define a situation. The results of this study show that U.S. seventh graders are much more likely than the sixth graders to use abstract strategies. In addition, the findings appear to support a relationship between abstract problem solving strategy use and the tendency to pose extension problems for the seventh graders.

Both this study as well as the previous study (Cai & Hwang, 2002) provide one perspective from which to examine the link between students' problem solving and problem posing. In particular, they suggest the feasibility of studying this link by examining the relationship between types of problem solving strategies and the tendency

to pose extension problems. This perspective should have direct instructional implications. Researchers (e.g., Silver, 1994) have suggested that student-posed problems are more likely to connect mathematics to students' own interests, something that is often not the case with traditional textbook problems. Thus, encouraging students to generate extension problems may not only foster positive attitudes toward mathematics and greater understanding of problem situations, but it may also help students develop more advanced problem-solving strategies.

Acknowledgements

Preparation of this paper is supported, in part, by a grant from the Spencer Foundation. Any opinions expressed herein are those of the authors and do not necessarily represent the views of the Spencer Foundation. We are very grateful for the assistance of Marcia Seeley for data collection. Thanks also go to Yi Long, Jennifer Nsian-Kumi, Tao Wang, and Sylvia Yuan for data coding and analysis.

References

- Brown, S. I., & Walter, M. I. (1990). *The art of problem posing* (2nd ed.). Hillsdale, NJ: Erlbaum.
- Cai, J., & Hwang, S. (2002). Generalized and generative thinking in U.S. and Chinese students' mathematical problem solving and problem posing. *Journal of Mathematical Behavior, 21*, 401-421.
- Einstein, A., & Infeld, L. (1938). *The evolution of physics*. New York: Simon & Schuster.
- English, L. D. (1997). The development of fifth-grade children's problem-posing abilities. *Educational Studies in Mathematics, 34*, 183-217.
- Kilpatrick, J. (1987). Problem formulating: Where do good problems come from? In A. H. Schoenfeld (Ed.), *Cognitive science and mathematics education* (pp. 123-147). Hillsdale, NJ: Erlbaum.
- National Council of Teachers of Mathematics (2000). *Principles and standards for school mathematics*. Reston, VA: Author.
- Polya, G. (1957). *How to solve it* (2nd ed.). Princeton, NJ: Princeton University Press.
- Silver, E. A. (1994). On mathematical problem posing. *For the Learning of Mathematics, 14*(1), 19-28.
- Silver, E. A. & Cai, J. (1996). An analysis of arithmetic problem posing by middle school students. *Journal for Research in Mathematics Education, 27*, 521-539.

MULTIPLICATIVE STRATEGIES OF NEW ZEALAND SECONDARY SCHOOL STUDENTS¹

Kathryn C. Irwin
University of Auckland

Secondary school students' use of multiplicative strategies in an exploratory New Zealand Numeracy Project was examined. This Numeracy Project enabled teachers to interview each of their students concerning their mathematical knowledge and strategies. The percentage of students who used multiplicative strategies increased from initial to final assessment. However, the percentage of the students from two low socio-economic schools was significantly lower, both at the initial and final assessment, than that from two upper socio-economic schools. It is suggested that it may be inappropriate to expect secondary school students to repeat the progress through additive stages that Piaget reports for younger children. Instead, it may be better to move them directly to multiplicative thinking.

BACKGROUND

Gelman (1999) suggested that multiplicative concepts are not among the naïve mathematical concepts learned by all. Tirosh and Graeber (1990) and others have written about the difficulties that pre-service teachers have with mathematical concepts that involve multiplicative thinking. Yet many activities, including operating with rates and fractions, require the flexible use of multiplicative procedures. This paper discusses a project intended to help students develop multiplicative strategies.

The development of multiplicative concepts have been widely discussed by mathematics education researchers (e.g. Harel & Confrey, 1994). A quick review of the incomplete set of PME proceedings on my shelves shows that in 1988 there were working groups on rational numbers, in 1990 and 1992 on ratio and proportion, and in 1999 on multiplicative processes. The difficulty of acquiring such concepts is well known to researchers, but not necessarily to teachers.

For the purposes of this paper, multiplicative concepts are defined as any concept that requires considering groups of numbers as a single unit. Piaget (1985/1987) discussed multiplication as more complex than addition, as it involves implicit quantification. Students who operate multiplicatively know that there is a certain quantity in each of the numbers multiplied, but do not need to refer to the individual items or numbers in a group. He describes several stages that young children go through as they develop this understanding, with Stage IIB and III being truly multiplicative.

Mulligan and Mitchelmore (1997) also described a developmental model for young children's approaches to multiplication problems. Their model showed multiplicative concepts to arise out of additive ones. The developmental pattern that they described is

¹ This Project is copyright by the New Zealand Ministry of Education. This research into the effectiveness of the project is also funded by the New Zealand Ministry of Education. The views expressed are those of the author.

similar to that used in the project described here and is similar to that commonly used in New Zealand schools. In this model, children move from direct counting to rhythmic counting, skip counting, additive calculation, and finally to multiplicative calculation.

Both Mulligan and Mitchelmore and Piaget describe the nature of multiplicative thinking used by young children, aged 7 – 10. Yet, as indicated above, many adults and older students fail to develop multiplicative thinking. Students continue to use additive calculation or repeated addition and do not move to multiplicative strategies. While using addition appropriately may give accurate answers, it is time consuming for more than the simplest problems and does not permit children to understand the more complex activities of finding a fraction of a number, working with rates, or linear algebra. These students fail to move to the stage of implicit quantification that Piaget refers to as seen in much younger children.

Despite researchers knowing that multiplicative concepts are difficult to teach and learn, New Zealand secondary school teachers discovered this anew in 2001 and 2002. Their discovery was the result of the introduction of a Numeracy Project (New Zealand Ministry of Education, 2002) for children from the ages 5 through 14. A major aim of this project was to alert teachers to the numerical strategies that their students used so that they could help them develop more advanced strategies and related numerical knowledge. While the project is generally accepted in elementary schools, its use in secondary schools is experimental. This paper examines the proportion of New Zealand students, in their first year of high school (age 14), who used multiplicative strategies when appropriate, both at the initial and final stages of the project, and the percentage of students who advanced to the use of more advanced strategies during the project. Factors that contribute to this change are given in comments by teachers, school administrators, and project facilitators. This paper discusses only a small portion of the data from this project.

METHOD

Participants

The secondary schools that participated in this project were those that either expressed an interest in being included or were asked by the Ministry of Education if they would be willing to be included. Results reported here come from four schools that were in the project for the second year in 2002. The students attended two schools in low socio-economic areas (N=189) and two in relatively high socio-economic areas (N=225). Schools in New Zealand are given a decile ranking based on the socio-economic background of the parents, with Decile 1 being the lowest and Decile 10 the highest ranking. Ethnicity of the students varied with decile ranking, with more students of Maori or Pacific Island ethnicity in the lower decile schools and more students of a European background in the upper decile schools.

The Numeracy Project

In the Numeracy Project all teachers assessed each of their students individually, using an assessment that took about 20 minutes each. (The Ministry of Education paid for other teachers to take their classes while they did this assessment.) The assessment covered strategies used for doing addition, multiplication, and proportion problems mentally, and

knowledge of the number sequence, base 10 grouping, fractions and decimals. Stages for doing multiplication problems were: counting, skip counting, repeated addition, deriving answers from known multiplication facts (“early multiplicative”), and using a range of mental multiplicative strategies (“advanced multiplicative” or “proportional”). There were suggested procedures for helping students to move from their diagnosed level of knowledge or strategy to higher levels. A facilitator was provided for each school who explained the framework of the project, demonstrated the interviews, and helped teachers with their planning based on the results of the assessment. This facilitator also taught sample lessons in each class and watched the teaching of the classroom teachers, praising what was working well and making suggestions for ways to help students advance their strategies or knowledge.

Problems

Only the percentage of students demonstrating multiplicative thinking on the scales of multiplicative and proportional items are presented here.

Problems used in the assessment of multiplication were, in brief: given a grid of eight rows of five trees, how many rows would be added if 15 more trees were planted; if $3 \times 20 = 60$, what would 3×18 be; if $8 \times 5 = 40$, what would 16×5 be; how many muffins would there be in 6 baskets if there were 24 in each basket; and how many cars could be fitted out with 72 wheels. Proportional problems were: what is $\frac{1}{4}$ and $\frac{3}{4}$ of 28; $\frac{3}{5}$ of 35; if 10 balls of wool made 15 beanies how many balls would be needed for 6 beanies; and what percentage of a class were boys if there were 21 boys and 14 girls. All problems were to be solved mentally.

Teachers scored items by the strategies that students used, as described in the previous section. For example, if students used a combination of multiplying and adding they were considered “early multiplicative” and if they found $\frac{3}{5}$ of 35 by dividing and then multiplying would be considered advanced multiplicative.

Data gathering

Each school entered codes for mathematical strategies that individual students used on each scale on a national database. For this paper, I have analysed the strategies used on multiplication tasks and proportion tasks for the two top decile and two bottom decile schools involved. I also interviewed a sample of teachers, heads of mathematics departments, principals, and all facilitators.

Data from both 2001 and 2002 showed that students at a higher grade level started well below the level reached by students in the lower grade by the end of the year, so gains in strategies could not be attributed to maturity or existing tuition.

RESULTS

One facilitator reported that the main effect of the project was “teacher awareness”. When the program was first introduced in 2001, teachers were shocked at the low level of achievement of their students.

Principal: Some of the findings blew me out of the water. Place value, ... we had taken for granted. Students had a veneer of knowledge.... Schools have to respond to where students are.

Perhaps the biggest shock in 2001 was that 43% of students from Decile 1 to 4 schools were unable to find 1/3 of 24, even if given counters. They did not appear to know what was requested of them. Only 8% of the students from the higher decile schools were unable to do this initially.

The full results for 2001 have been reported in Irwin and Niederer (2002).

The following table shows the initial and final percentage of Year 9 students, in lower and upper economic groups, who used multiplicative strategies for problems designated as multiplication and proportion.

Decile 1 schools N=189		Decile 8,9 schools N =225	
Initial	Final	Initial	Final
24%	34%	66%	83%

Table 1. Percentage of students who used multiplicative strategies from schools rated as of lower and upper socio-economic status at initial and final periods of a numeracy project in 2002.

Statistical analysis (Newcombe, 1998) showed that a significantly smaller proportion of students in Decile 1 schools used multiplicative strategies, both at the start and finish, than did students in the Decile 8 or 9 schools ($p < .01$). An increased number of students from both groups came to use multiplicative strategies, but by following the recommendations of the project to teach the next higher stage, developmentally, students from lower decile schools had much less opportunity to become multiplicative thinkers because they started at lower stages.

	Decile 1	Decile 8,9
Students on ceiling initially	5%	37%
Total students gaining	40%	49%
Students gaining within additive strategies	23%	7%
Students moving from additive to multiplicative strategies	11%	25%
Students who gained within multiplicative strategies	5%	17%

Table 2. Percentage of students gaining at least one stage on the numeracy framework. All percentages are based on the number of students not already at ceiling.

In terms of the stages provided in the project, 40% of the students in Decile 1 schools, not already at the ceiling level, improved, and 49% of the students from the Decile 8 and 9 schools improved. Table 2 shows that their improvement was at different levels.

These data show that students did move up stages according to the hierarchy assumed by the project, a hierarchy also proposed by Mulligan and Mitchelmore (1997) for young children. However, adopting this progression left the students from lower economic areas still well behind their peers from more affluent areas. In accordance with the directions of the project, most low decile students worked on additive strategies, whereas most upper

decile students worked on multiplicative strategies. With this emphasis, it is not surprising that more than twice the percentage of upper decile students progressed from additive to multiplicative thinking.

DISCUSSION

The main questions raised by these data are: (1) what brought about the increased use of multiplicative strategies, and (2) does this project, which emphasises methods used by much younger children, disadvantage lower decile students.

What brought about the change? Teachers reported that there had been major changes in their knowledge of individual students, and in their teaching. Teaching was different in each of the schools despite the suggestions from the project. Some reported a change from their existing pattern of whole-class teaching, usually using a textbook, to teaching skills and strategies that they had not previously taught, and to teaching in groups. Others reported adding an initial portion to their lessons on number sense, working from their students' known levels. None of these schools abandoned their usual curriculum, but they did give more time to numeracy than previously. Comments included:

Teacher: They are finding the work within their means, so I can actually sit down with one or two or three students. It is that that is reaping the benefits. I am able to listen to them and hear what is going on in their heads and help them with the best strategy for them rather than doing one thing for the whole class.

Head of a mathematics department: Most people would say that their classes are happier. That doesn't mean that they are more saintly but certainly they are happier because they have things that they can do. The kids in the bottom group are much happier. It has been most successful for them.

Facilitator: They are listening to their students, and moving from there.

Listening to students has been seen as essential to good teaching from Plato through to current educators. Constructivist classes are characterised by teachers listening to students and students listening to one another (e.g. Kamii & Warrington, 1997). Yet these secondary teachers had possibly been preoccupied by their own teaching agenda and not had the time to listen to their students. The interviews gave them the initial opportunity to listen, and facilitators helped them to continue to listen while in the project.

Does the project continue to disadvantage lower socio-economic students by encouraging them to move up through a framework developed for young children? This is a serious concern, especially as one hope was that the experimental project would prove to be remedial for this group. However, in using a developmental framework appropriate for young children the project developers apparently expected older children to move through the same stages. These students may have only two more years of schooling and are unlikely to spend much more time on numerical concepts. This suggests that the majority will leave school as additive thinkers. It might be more appropriate to introduce them directly to thinking about groups of numbers as units, with inherent quantification. One Head of Mathematics from a Decile 1 school commented that these students are overly dependent on algorithms.

Head of Mathematics: We need to teach them to go back to skip counting. They see a hard multiplication problem and want to do it with the algorithm rather than seeing that they could multiply it by a larger number and subtract.

Many teachers have commented that when elementary school students have been through the project, this problem will not be seen in secondary schools. It seems unlikely that this problem will go away that easily. It would seem more important to introduce these secondary school students directly to thinking of nested quantities, as in Piaget's Levels IIB and III (Piaget 1983/1987). This would be more in the spirit of remedial programs for adults such as that introduced by Triesman (Mathematics Department, University of Illinois, 2002). Engaging the students in the value and power of multiplicative thinking as young adults could be more beneficial than expecting them to move up through the stages of young children.

References

- Gelman, R. (1999). Naive Mathematics. *The MIT Encyclopaedia of the Cognitive Sciences*. R. A. Wilson & F. C. Keil. Cambridge, MA: MIT Press. 575 - 577.
- Harel, G. & Confrey, J. (eds.) (1994) *The development of mathematical reasoning in the learning of mathematics*. Albany NY: State University of New York Press.
- Irwin, K. C. & Niederer, K. (2002). An evaluation of the Numeracy Exploratory Study years 7-10, 2001. *Wellington: Ministry of Education*.
- Kamii, C. & Warrington, M. A. (1997) Multiplication with fractions: A constructivist approach. *Hiroshima Journal of Mathematics Education*, 5. 11-20.
- Mathematics Department, University of Illinois (2002). Merit Workshop Program for Emerging Scholars in Mathematics at the University of Illinois at U-C. Retrieved January 6, 2003 from <http://www.math.uiuc.edu/MeritWorkshop/uriModel.html>
- Mulligan, J. T. & Mitchelmore, M. C. (1997). Young children's intuitive models of multiplication and division. *Journal for Research in Mathematics Education*, 28. 309-331.
- New Zealand Ministry of Education (2002) New Zealand Numeracy Projects. Retrieved January 4, 2003 from <http://www.nzmaths.co.nz/Numeracy>.
- Newcombe, R. J. (1998). Two-sided confidence intervals for the single proportion: comparison of seven methods. *Statistics in Medicine*, 17, 873-890.
- Piaget, J (1987). *Possibility and necessity*. (H. Feider, Trans.) Minneapolis: University of Minnesota Press. Original work published in 1985.
- Tirosh, D., & Graeber, A. O. (1990). Inconsistencies in preservice elementary teachers' beliefs about multiplication and division. *Focus on Learning Problems in Mathematics*, 12, 65-74.

EFFECTIVE VS. EFFICIENT: TEACHING METHODS OF SOLVING LINEAR EQUATIONS

Kathy M. C. Ivey

Western Carolina University

The choice of teaching an effective method—one that most students can master—or an efficient method—one that takes the fewest steps—occurs daily in Algebra I classrooms. This decision may not be made in the abstract, however, but rather in a ready-to-hand mode. This study examines how teachers solve linear equations when the purpose is pedagogical and when it is mathematical. Their answers reveal a definite preference for students to solve linear equations in a standard order even if it is not the most efficient way. The most efficient solutions show much more variation, but these answers still exhibit a clear tendency to follow the standard order in general.

INTRODUCTION

Many discussions of mathematics teaching and learning set up a dichotomy between conceptual and procedural learning based on the work of Hiebert (1986). Star(2000, 2002) examines a third alternative of “intelligent” procedural knowledge or “procedural understanding.” This type of understanding, he contends, leads students to more efficient methods for solving routine problems. Procedural understanding also makes students more flexible and innovative with greater understanding of algebraic processes. Star’s work looks at a way to enhance or develop this type of understanding in students. However, he takes as unproblematic that teachers recognize and value the most efficient methods for solving linear equations. He also contends that there is a standard way to solve linear equations taught in the United States. I examine these two issues from a teacher perspective. While there may be a general method that teachers present for solving linear equations, their own work may not be constrained by that method. Furthermore, teachers have competing pedagogical demands of effectiveness and efficiency when teaching students how to solve linear equations. In this paper, I theorize that teachers may value effective techniques more than efficient for students’ solutions to linear equations.

THEORETICAL FRAMEWORK

Teachers, like all of us, operate in a world with many demands. They must teach particular content—at least in most schools—that will be tested in procedural ways, and at the same time, they must help students become mathematically literate problem solvers. This work occurs within a culture bounded by the nation, the state, the community, the school, and the department within which they teach. Recognizing that teachers must often manage dilemmas, as Lampert (1985) describes, brings pedagogical decisions to the forefront in any discussion of what happens in a classroom. Working from the hermeneutical tradition of Heidegger and Gadamer allows an examination of

teacher actions and decisions in particular instances without losing sight of the larger context within which they work (see Williams, Walen, & Ivey, 2000). The pedagogical decisions that teachers make are bounded by what they perceive as necessary and possible—their hermeneutic “horizons” (Gallagher, 1992). What they come to know about teaching is always done in context, never in isolation. Furthermore, many pedagogical decisions are made in a “ready-to-hand” or unreflected upon manner. Thus not all choices are based on what is mathematically best or most efficient. Many decisions of what and how to teach are based on what is most effective for producing procedural knowledge, particularly in basic classes such as Algebra I.

Historically, we have known that a dilemma exists between effective and efficient methods. Tall (1989) points out that a student’s ability to conceive of algebraic expressions as objects is an important step in moving from arithmetic to algebraic reasoning. But the ability to recognize algebraic expressions as chunks to be treated as a single variable is closely related to how recently students have worked with this kind of activity (Linchevski and Vinner, 1990). At the same time, Wenger (1987) describes the inability of students to make good choices about what to do next in simplifying expressions. These findings delineate the dilemma for teachers—how to encourage strong algebraic reasoning in students while making sure that they can actually simplify expressions and solve equations.

Teachers’ own understanding of methods for solving linear equations may be flexible and innovative in Star’s (2002) use of these terms, but their expectations for students may not be. By examining teachers’ solution methods under different circumstances, the dilemma can become overt, and their “ready-to-hand” pedagogical choices become “present-at-hand” or objects available for examination.

METHODS AND DATA SOURCES

Twenty pre-service and in-service teachers volunteered to participate in this study. The in-service teachers included middle-grades, high-school, and community-college teachers. Each participant completed a three-page questionnaire anonymously. The various pages of each questionnaire were coded for identification, but participants’ names were not recorded. Page 1 contained questions about demographic information including number of years of teaching experience, number of years of beginning algebra teaching experience, mathematical preparation, and level taught. Other questions asked participants i) to “list the steps that a student would need to know how to do to be able to solve any linear equation,” ii) if there were a standard order for performing those steps, and iii) if their textbook presented a standard order. Additionally, on pages 2 and 3, participants were asked to solve linear equations “showing all the steps that you would want your students to show” and “in the most efficient way,” respectively. Figure 1 contains the questionnaire condensed by removing the space for answers.

Each participant completed the questionnaire sequentially with no knowledge of what the next page would ask, nor with an opportunity to revise any answers. The resulting work was coded for demographic responses and for operations performed in each step of the various problems. A step was construed to be what was completed between one line of

written symbols and the next. All coding was completed by the author. There were no ambiguous cases of what constituted a step. Comparisons of the methods for solving each equation were made across participants on each question, and methods for solving equations were compared across questions for each participant. These comparisons resulted in several themes emerging from the data. The primary results are considered in the next section.

Page 1	
1. I teach at _____middle school _____high school _____community college _____ college or university	
2. I have taught for _____0 years _____<3 years _____3 - 10 years _____>10 years	
3. I _____regularly teach _____have taught _____have never taught Algebra I .	
4. My highest earned degree in mathematics or mathematics education is: _____none _____undergraduate minor _____undergraduate major _____Master's degree _____Ph.D.	
5. List all the steps that a student would need to know how to do to be able to solve any linear equation. (For example: add the same thing to both sides.)	
6. Is there a standard order that you expect students to perform the steps you listed above?	
7. Does your algebra textbook present a standard order of steps to solving linear equations?	
Page 2	
Solve each problem showing all the steps that you would want your students to show.	
1. $2x + 4 = 10$	2. $3(x+2) = 21$
3. $3(x+1) = 15$	4. $4(x+1) + 32 = 5(x+1)$
5. $4(x+1) + 3(x+2) = 20$	6. $3(x+1) + 6(x+1) + 6x + 9 = 6x + 9$
7. $4(x+1) + 2(x+1) = 3(x+4)$	8. $4(x+1) + 2(x+2) = 3(x+4)$
9. $4(x+1) + 2(x+1) = 3(x+1)$	10. $4(x+2) + 6x + 10 = 2(x+2) + 8(x+2) + 6x + 4x + 8$
Page 3	
Solve each problem in the most efficient way.	
a. $3(x+1) = 15$	b. $4(x+1) + 2(x+2) = 3(x+4)$
c. $4(x+2) + 2(x+2) = 3(x+6)$	d. $4(x+3) + 2(x+3) = 3(x+3)$
e. $3(x+1) + 6(x+1) + 6x + 9 = 6x + 9$	f. $4(x+3) + 32 = 5(x+3)$

Figure 1. Solving Linear Equations Questionnaire

RESULTS

Standard Order

From their answers to the question about a standard order for solving linear equations, five participants do not believe there is a standard order for solving linear problems. The other 15 participants name from two to seven steps that are more or less specific, but generally name the same order—to simplify (distribute, get rid of fractions, combine like terms), add or subtract from both sides, then multiply or divide both sides. In solving the problems on page 2, most participants want students to show essentially the same work in a relatively standard order—distribute, combine like terms, subtract like terms, and divide. The main difference is whether participants want to see subtraction of variable terms and constant terms in separate steps or in one step. The majority of responses, approximately two to one on each question, show subtraction of variable terms and constant terms separately. Table 1 shows how many participants (N=20) perform the standard order on each problem 1 through 10. Also in Table 1 are the numbers of participants who use a chunk, such as $(x + 1)$, as a unit in solving these problems. These results indicate that participants do expect a standard order for solving linear equations.

Problem number	Completed Standard Order	Worked with Chunks
1	20	NA
2	17	0
3	17	0
4	20	2
5	19	NA
6	20	2
7	20	3
8	20	NA
9	19	3
10	19	2

Table 1. Standard order completion and use of chunks on problems 1-10. (N=20)

Problem number	Completed Standard Order	Worked with Chunks
a	9	NA
b	20	NA
c	19	11
d	19	10
e	20	10
f	20	8

Table 2. Standard order completion and use of chunks on problems a-f. (N=20)

Using Chunks

In contrast to the answers on page 2, the questions on page 3 show substantially different responses. Table 2 shows the number of standard order completions and the use of chunks on problems a through f. One of the main differences obvious from the results given in Table 2 is the use of chunks. While few participants use chunks in answering the first ten problems on page 2, a substantial increase in use of chunks is seen in the last four

problems on page 3. The standard order is generally followed but without distributing first when chunks are used. This use of chunks indicates that participants have a flexible and innovative understanding of algebraic variables when solving problems themselves.

Individual Responses

In the first ten problems, all uses of chunks are by the same three individuals. One person is a pre-service teacher, and the other two people have been teaching for three to ten years and regularly teach Algebra I. All three individuals consistently use chunks in the last four problems on page 3.

Two individuals—both high school teachers, one with fewer than 3 years experience and the other with 3 to 10 years experience—show a check step on the problems on page 2. One shows it on every problem, the other on the first four problems only. Neither person shows a check step on any problems on page 3.

$$\begin{aligned}4(x+1) + 3(x+2) &= 20 \\4x + 4 + 3x + 6 &= 20 \\7x + 10 &= 20 \\(20-10) \div 7 &= \frac{10}{7}\end{aligned}$$

Figure 2. An unusual solution

A different individual—also a high school teacher with 3 to 10 years of experience—shows an unusual solution technique on all problems on page 2. (See Figure 2.) Standard algebraic notation is used for the distributive step and for the combine like terms step. At that point, the “arithmetic” steps—subtraction and division on both sides—are performed as a unit with no variable showing.

DISCUSSION

Standard Order

As noted by Thompson (1984), what teachers say they believe and what they do are not always the same. In this study participants are much more uniform in their expectations of a standard order for solving linear equations when demonstrating how they want students to solve problems than when discussing the idea in the abstract. Essentially all of the participants show a standard order when solving problems, even though a third of the participants say there is no standard order for solving linear equations. Roughly half of the participants say that their textbooks do not show a standard order, or they do not know if their textbooks show a standard order. One participant provides her students with a template to follow in solving linear equations that outlines the standard order because the book does not show it. Thus there is a mixed response on the existence of and in some cases the need for a standard order when participants discuss the issue. When the actual expected work is shown, however, the standard order is almost universally followed.

The instructions given on page 2 and page 3 produce different responses to essentially the same questions. All page 3 questions have an exact or very nearly exact analog on page 2. Two interesting variations in solutions on page 3 are worth noting. On problem a, 11 out

of 20 participants change the standard order and divide first, resulting in a two step solution, the most efficient possible. This change is particularly noteworthy in that on problem 3 (the same problem as problem a) only three participants expect students to divide first. This difference in responses supports participants' views that a standard order is not necessary for solving the problems, but also indicates their preference for students to follow a standard order. The second variation is in how the subtraction steps are performed. On page 2, most participants want to see students subtract variables and constants in separate steps. On page 3, however, almost all participants subtract variables and constants in a single step. Again we see a difference in how participants want students to demonstrate solutions and how they demonstrate solutions themselves.

Use of Chunks

Participants are also unlikely to treat chunks as single variables when showing what they expect students to do, but instead begin each problem by using the distributive property to remove parentheses. When working problems for efficiency, however, participants use chunks freely, but generally still adhere to the same standard order for solutions. The use of chunks, in most of these problems, does not lead to more efficient solutions in terms of number of steps, but it does show flexibility. In one case the use of chunks does create a much more efficient solution. On problem d, one participant notes that the “variable $[x+3]$ is the same on both sides and constants are not equal so $x+3$ must equal 0.” This observation reduces the problem to one step of subtract 3 from both sides.

Individual Problems

There is much more uniformity between participants' answers on page 2 than within a single participant's answers on pages 2 and 3. In general, the responses on page 2 are interchangeable between participants. Responses to page 3 problems show much more innovation in order of steps and flexibility in using chunks between individuals. Interestingly enough, there are no apparent differences between individuals based on any of the demographic categories.

The inclusion of a check step on page 2 problems also points out the variation within one person's answers. She saw the check step as important for students to show, as evidenced by her willingness to include it on all ten problems. The check step is abandoned, however, when an efficient solution is the goal. This implies that the check step has a pedagogical use but not an efficient use.

CONCLUSIONS

Teachers, both pre-service and in-service, in this study expect students to solve linear equations in a standard order—distribute (and other simplifications), combine like terms, add and subtract, multiply and divide. This expectation is clearer from worked examples than from descriptions of a standard order. Furthermore, differences in level of teaching, years of experience, frequency of teaching Algebra I, and level of mathematics preparation do not affect teachers' expectations.

The purpose for solving linear equations appears to affect what teachers do in solving linear equations. When the purpose was clearly pedagogical—show what students should

show—teachers’ expectations were uniform. When the purpose was efficiency, teachers’ solutions varied more, showing both innovation and flexibility.

The dilemma that teachers face, to teach effective methods or efficient methods, is thus brought out in a way that can be examined. A standard order provides an effective way for students to routinely solve linear equations correctly. That order, however, is not necessarily the most efficient way and is certainly not the only possible way. Within the context that teachers work, the solution to the dilemma appears to be the recognition that there are multiple orders possible and a variety of innovations possible in solving linear equations, however, the importance of this skill makes a standard order the expectation for students’ work.

This study supports Star’s (2002) contention that there is a standard order for solving linear equations in the United States. It also demonstrates that teachers expect that standard order from students but are able to vary from it themselves when trying to solve problems efficiently. This portion of the study brings out another pedagogical decision made every day by teachers, but one that is made perhaps in a ready-to-hand way without conscious reflection.

References

- Gallagher, S. (1992). *Hermeneutics and Education*. Albany, NY: SUNY Press
- Hiebert, J. (1986). *Conceptual and procedural knowledge: The case of mathematics*. Hillsdale, NJ: Lawrence Erlbaum.
- Lampert, M. (1985). How do teacher manage to teach? *Harvard Educational Review*, 55(2), 178-194.
- Linchevski, L., & Vinner, S. (1990). Embedded figures and structures of algebraic expressions. In . Booker, P. Cobb, & T.N. de Mendicuti (Eds.), *Proceedings of the Fourteenth International Conference for the Psychology of Mathematics Education* (Vol. II, pp. 85-92). Mexico City, Mexico: Centro de Investigacion y de Estudios Avanzados del I.P.N.
- Star, J. (2000). Re”Conceptualizing” procedural knowledge in mathematics. In M. L. Fernandez (Ed.), *Proceedings of the twenty-second annual meeting of the North American Chapter of the International Group for the Psychology of Mathematics Education* (Vol. I, pp. 219-223). Columbus, OH: ERIC Clearinghouse for Science, Mathematics, and Environmental Education.
- Star, J. (2002). Re-conceptualizing procedural knowledge: The emergence of “intelligent” performances among equation solvers. In D.S. Mewborn, P. Sztajn, D.Y. White, H.G. Wiegel, R.L. Bryant, & K. Nooney, (Eds.), *Proceedings of the twenty-fourth annual meeting of the North American Chapter of the International Group for the Psychology of Mathematics Education* (Vol. II, pp. 999-1007). Columbus, OH: ERIC Clearinghouse for Science, Mathematics, and Environmental Education.
- Tall, D. (1989, April). *Concept image, computers, and curriculum change*. Invited address presented at the research pre-session of the annual meeting of the National Council of Teachers of Mathematics, Orlando, FL.
- Thompson, A. (1984). The relationship of teachers’ conceptions of mathematics teaching to instructional practice. *Educational Studies in Mathematics* 15, 105-127.

- Wenger, R. H. (1987). Cognitive science and algebra learning. In A. H. Schoenfeld (Ed.), *Cognitive science and mathematics education* (pp. 217-251). Hillsdale, NJ: Lawrence Erlbaum.
- Williams, S.R., Walen, S.B., & Ivey, K.M.C. (2000). Ontology and phenomenology in mathematics education. In M. L. Fernandez (Ed.), *Proceedings of the twenty-second annual meeting of the North American Chapter of the International Group for the Psychology of Mathematics Education* (Vol. I, pp. 231-235). Columbus, OH: ERIC Clearinghouse for Science, Mathematics, and Environmental Education.

STUDENT'S CONCEPT OF INFINITY IN THE CONTEXT OF A SIMPLE GEOMETRICAL CONSTRUCT

Darina Jirotková, Charles University, Prague, CZ

Graham Littler, University of Derby, UK

The research described in this paper was undertaken to determine student-teachers' understanding of infinity in a geometrical context. The methods of analysis of students' responses is presented and these were found to be universally applicable. The findings show that school mathematics does not generally develop the students' ideas of infinity (Eisenmann, 2002). We believe that discussion about infinity could lead to the development of cognitive ability and hence the need for teachers to have a sound knowledge of infinity and the necessary communicative skills.

INTRODUCTION AND FRAMEWORK

Infinity has always intrigued mathematicians, philosophers and other scientists throughout our history. It is such a profound concept that consideration of it has always led thinkers to formulate the most deep and innovatory ideas of their time (Bolzano, Newton, Leibniz, Cantor). Early thoughts about it had to wait until mathematics changed from a purely practical discipline to a more intellectual one, around 600 BC. However the Greeks did not develop their ideas. Zeno and Archimedes were exceptions (Hejny, 1978). It was not until the sixteenth century that further developments were made. John Wallis, the first person to have used the symbol ∞ , in 1650 discovered a formula which used the division of two 'infinite products' (Maor, 1991).

Early in its development, infinity was considered in relation to either the very small or very large and considered generally as potential. Cantor changed these ideas completely by accepting actual infinity as a mathematical entity and the infinite set as a totality (Cantor, 1955).

Cantor's theories and the concept of infinity, especially actual infinity, are still found difficult to grasp today by many students of mathematics. These difficulties result in vague and inconsistent answers to be given to problems involving infinite sets, for example. They have been researched amongst others by Fischbein, Tall, Tirosh and Tsamir (1979, 1980, 1996, 1999) mainly in a numerical setting and the research looked at the influence of students' intuition of finiteness on their ideas of infinity. Fischbein, Tirosh and Hess (1979) found that pupils considered infinity to be either a process which was infinite or one which came to an end.

Monaghan (1986, 2001) argues that when ideas about limiting processes are presented in a geometric context they are stronger than when presented in a numeric context. It is assumed that basic geometrical objects can be visualised and are considered part of the real world hence it is more difficult to consider the infinite phenomena of these objects. Most of current mathematical education researches into infinity have been carried out in the arithmetical field. We have used the geometrical field for our research and we hope that our results will contribute to the knowledge of a student's understanding of infinity and to the methods of gaining insight into it.

AIMS OF RESEARCH

The word infinity belongs to children's natural vocabulary from their early years. It is often linked to two emotions; excitement of penetrating into something beyond the real world, and fear of the unknown. The children cannot have any direct experience of infinity from the real world so they project their real experiences into the word 'infinity'. Hence by a mental process using abstraction, absolutism and idealisation they create a mental construct, a tacit model of infinity (Fischbein, 2001).

We believe that, as in history, the investigation of the phenomenon of infinity considerably enhanced the development of human knowledge, so consideration of infinity by students could significantly contribute to their cognitive development. To discuss the phenomena of infinity with students demands deep preparation by the teacher. The teacher should have a sound knowledge of infinity him/herself but also have knowledge of the way students perceive infinity. This second aspect requires the teachers to undertake small scale research in their classrooms so that they able to recognise and rectify the pupil's own misconceptions and to distinguish whether the underlying problem was with their understanding of infinity or with their inability to express their ideas correctly.

There are ample topics in the school mathematics curriculum which offer good opportunities for discussions on infinity such as natural and rational numbers, progressions, limits, line segments, straight line etc., however there is no curriculum heading of infinity in school syllabuses as far as we are aware. Most teachers only superficially refer to infinity occasionally by saying 'the series of natural numbers goes on and on into infinity', 'the plane can be extended in all directions into infinity', etc. and do not go deeper into this phenomenon because he/she would not wish to show their own uncertainty. It therefore depends entirely on the teacher whether or not they can lead effective discussions.

Our aim for the research was to find out what the student's understanding of infinity was when related to a geometrical context. We hoped the research would give us an insight into the cognitive mechanisms which determine the development of the understanding of the concept of infinity, to identify obstacles which hinder such a development and find tasks and procedures which will help to educate and re-educate students to avoid or overcome the obstacles. A secondary aim was to develop a universal methodology for this research which could be easily used by practising teachers.

METHODOLOGY

The research was carried out in two stages. In 1995 the methodology for this research was developed by a team led by M. Hejny at Charles University, Prague (see Jirotkova, 1996, 1997, 1999). During this stage, particular emphasis was placed on the responses of the students to Task 1. The second stage was to verify the method of analysis of the responses and then to extend the research to the individual by interviewing selected students and using the series of tasks developed for this purpose.

Research Tool

We did not want the students to be aware that we were particularly seeking information about their understanding of infinity so our research tool was one which contained an indirect request for this. The students mentioned infinity spontaneously. They were given:

Task 1: Try to define your own understanding of the concept of a straight line.

Our analysis in the first stage of our research resulted in the development of a series of tasks to be used with individual students for diagnosis, follow-up work and the development of their thinking and communicative skills. We list below two of them which are referred to in our analysis.

Task 2: Look at the statements below. Decide which of the two children is correct.

Adam: *A straight line has two 'infinities'. If I go in one direction I'll reach infinity. If I go in the opposite direction I'll also reach infinity.*

Boris: *Those two 'infinities' are the same, so there is only one infinity on a straight line. It is the place where both ends join together like a circle.*

Task 3: Given a straight line b and a point A not lying on b , consider all squares $ABCD$ whose vertex B is on the straight line b . Draw square $ABCD$ with: (a) the smallest possible area, (b) the greatest possible area. Draw the diagonals AC and BD and mark the centre of the square. If you do not have enough room on your paper to mark a certain point draw arrows to indicate the direction in which it lies.

Research Sample

In 1995 Task 1 was given to 72 primary school student teachers. They were in their first year at University and had not taken a course in geometry nor had any course influenced their understanding of infinity. Hence their knowledge of infinity was that gained at school or through life experiences which probably developed tacit models of infinity in their minds (Fischbein, 2001). In 2002 the same tool (Task 1) was used with 102 student teachers: 43 first year students studying to teach mathematics in secondary schools and in the process of having their first course on geometry; 25 students studying to teach special needs pupils who had not taken any University course in geometry; 10 second year primary education students who had taken a course in geometry; 24 first year primary education students who had not taken a course in geometry at the university.

The same task was given to 18 English students who were studying on a primary post-graduate certificate of education course. This was done because the translation of the responses of the Czech students into English might lose or cause slight changes in emphasis from the original responses. We hoped to gain authentic English statements with which to compare the translations.

Method of Research

Task 1 was given to all the students verbally. They were asked to write their responses on paper. No time limit was set. Each of the 174 **responses** received were considered and from them we chose those responses which contained the explicit use of the word 'infinity', 'infinite', 'end', 'endless', 'never-ending', 'end-point'.... We then split these responses into simple ideas which we called **statements**. The statements which did not

mention words similar to those listed above were discarded. In this way we were left with 92 different statements. For instance in Alice's response: *A straight line is a line segment of infinite length, (1) and is a simple direct line which does not have and end or a beginning (2) or both are in infinity (3). It could be defined as a circle of infinite radius (4).* Alice's response gave us four contributions to our list of statements. The statements, which we considered had similar meanings, were grouped together and represented by a single authentic statement, which we called a **phrase**. For instance the authentic phrase 'an infinite set of points' represented several other statements: *join of infinitely many points, non finite set of points ordered linearly, consists of infinitely many points etc.* In this way we got 26 different phrases.

Contrary to the classification of students by their understanding of infinity used by Sierpinska (Tall, 1996), we have classified the phrases used by the students. That is, we did not analyse individual student's understanding, just the phrases within their responses. This was the first level of our analysis.

In the second level we decided to classify the phrases in a non-mathematical way, that is, we grouped them by the grammatical aspect. In **Group A** we put all phrases in which infinity was expressed as a noun as if the author accepted the existence of infinity. In **Group B**, we put those phrases which expressed infinity as an adjective or adverb. In these phrases the existence of infinity was not indicated directly and was considered to be a property of the straight line. This property is defined in the phrases of **Group C** implicitly. The students formulate it as the opposite or absence of finiteness by denying the existence of the end(s), end-points of a straight line.

In level 3 of the analysis we looked for those phenomena which created the students' understanding of infinity, described them and classified the students' responses according to them. We consciously interpreted the phrases in a way which exceeded the preciseness of the author of the phrase. We were aware that the students' images of the concept of infinity might be vague and fuzzy and that they may also lack the ability to articulate their images. Our experience would indicate that such an approach gives an insight into the whole problem. It also enabled us to suggest ideas of how to diagnose a student's difficulties and find means of developing their understanding and communicative ability.

These levels of analysis took place in both stages of the research. In the second stage of our research as indicated in the aims above, we went further and focussed on the student as an individual. When a response from a student contained statements which were contradictory, or were inconsistent, we interviewed the student to see whether the contradictions or inconsistencies were caused by misconceptions of the word infinity or the lack of communicative skills. For this we chose some of the series of suggested tasks mentioned above.

RESULTS AND DISCUSSION

Results

The first level of our analysis resulted in the following list of phrases classified into three groups. All phrases refer to the straight line.

Group A

- A1.....begins and ends at infinity,
- A2.....has its beginning and ending at infinity,
- A3.....the end points are at infinity,
- A4.....beginning at infinity, going on in the opposite direction to infinity,
- A5.....goes to infinity in both directions,
- A6.....starts at infinity and leads to infinity,
- A7.....goes from infinity to infinity,
- A8.....could be extended into infinity.

Group B

- B9.....has an infinite number of points,
- B10...is infinite,
- B11...is an infinite connection,
- B12...is an infinite line segment,
- B13...is infinitely long,
- B14...is an infinite figure of points,
- B15...is an infinite set of points,
- B16...is an infinite series of points.

Group C

- C17...does not have either beginning or end point,
- C18...without beginning or end,
- C19...does not begin and end anywhere,
- C20...with the beginning and end missing,
- C21...with unlimited beginning and end,
- C22...I can never see the end or the beginning,
- C23...does not end
- C24...not ending anywhere
- C25...is not finite, not ended,
- C26...it is not possible to determine the end point.

Returning to the example of Alice above, statements (1) and (4) were classified in phrases B12 and B14 respectively, statement (2) in C17 and statement (3) in A3.

Group A. In this group's phrases we found four polar phenomena which characterised the students' ways of expressing infinity or the infiniteness of a straight line.

- P1 - number of 'infinities' on the straight line, one or two;
- P2 - number of times the word 'infinity' was used in a phrase, one or two;
- P3 - quality of infinity: (a) beginning or end, (b) locality or direction;
- P4 - potentiality or actuality.

DISCUSSION

We now consider each of these phenomena more closely:

P1. Phrase A8 speaks of one infinity, whereas all the other phrases could imply that there were two infinities. However we cannot exclude the possibility that both the infinities implied by the writers were the same in their imagination. This uncertainty led us to construct Task 2 (see above). In this Boris explicitly declares '...there is only one infinity on a straight line. It is the place where both ends join together, like a circle'. This idea corresponds to the idea of a straight line in topology.

P2. Phrases A1, A2, A3, A5, and A8 use the word ‘infinity’ once and in A4, A6 and A7 it is used twice. From our comments related to the phenomenon P1 you can see it is not possible to say that the number of times the word infinity is used determines the number of infinities in a student’s understanding.

P3(a). When the two infinities are mentioned we can consider the different qualities of the infinities. In phrases A1, A2, A6 the quality of the infinities are different, one is the beginning and the other, the end. In the others the quality is the same.

P3(b). When it is said that the straight line has its end in infinity, infinity is being used as a label for a particular place on the straight line which is ‘very far away’, ‘unreachable’. These responses imply that the authors of them might not have considered the infiniteness of the straight line. On the other hand, when they say the straight line ‘goes towards infinity’ (A4, A5, A7) they speak about infinity as a direction and that the straight line is like a ‘signpost’ pointing in the direction of infinity. In A4 and A7 the word infinity is used twice and in each case the quality of it is different. The first time the word is used, in A4, it signifies a place where the process of creating the line starts. The second ‘infinity’ is a signpost for the direction in which the straight line goes. In A7 these infinity qualities are reversed ‘goes from infinity to infinity’. In our interpretation the other phrases refer to infinity as a location. We are aware that our interpretations depend on our own experiences so again we created Task 3 to help us determine how the students understood the aspect of quality.

P4. If you compare A2 and A5 then phrase A5 can be interpreted as stressing the process of creating the straight line. The writer considered the process and not the completion of it. The straight line thus existed in its possibility (potentiality) of being realised and not in its completion. In this case we interpreted infinity as having two properties: an indication of direction and that it was unreachable. Such an interpretation of infinity we called potential. Phrase A2 speaks about the beginning and end of the straight line as if they were two points at some place called infinity. The writers of such statements looked at the line as a whole, an object, which has been completed. The image of infinity as a fixed locality and its infiniteness supports this understanding and is close to what is called in mathematics actual infinity. This was also found in phrases A1 and A3 ‘begins and ends/end points are at infinity’.

Group B. In these statements, infinity is considered to be a property of the straight line but does not state the existence of infinity directly. The analysis of group B was based on the gradual elimination of single phrases. We started to look for unique phenomena within the phrases but most were applicable only to part of group B. After ordering the phrases the analysis enabled us to tabulate it as follows:

has	is						
	directly	indirectly					
		quality	quantity				
			continuously	discretely			
					without order	with order	
B9	B10	B11	B12	B13	B14	B15	B16

The table shows how it is possible to bifurcate the phrases progressively. Infinity was considered as belonging to the straight line by the use of 'has' in B9, in all the other phrases it was considered as a property of the straight line using 'is'. This was the first bifurcation. For the second, the infinity property was expressed directly in B10 but indirectly in the others. The connection between infinity and a straight line was quality in B11 and quantity in the others. Phrase B12 was difficult to classify since it could have been interpreted in both ways. The quantity property is represented by an object which is continuous in B13 and discrete in the remainder. B14 caused similar problems to B12 since it could be interpreted as either continuous or discrete. Note that discreteness can be without order B15 or with order B16.

We considered that the students we investigated understood the word 'figure' as referring to a continuous object hence we felt that B14 should be classified with B13 rather than B15. We used the table as a tool for the analysis of Group B. We accept it is not universal because it relates only to those phrases taken from our sample. This means that our analysis of Group B is different from that of Group A where the criteria are universal. Nevertheless the methodology in which the table was created, that is the division into a series of phenomena by which we characterised single cells, is universal.

Group C. As in group B the authors did not speak of infinity directly. They also deny the existence of the end(s) of the line. We were aware though that saying the end does not exist did not imply that infinity is being inferred. However we thought that in the phrases C17 to C22, the non-existence of the beginning and end was connected with the image of the infiniteness of the straight line in the sense of them being unattainable. In C22 and C26 the existence of the end is declared but the end is moved beyond the writer's horizon, which from our perspective does not influence the structure of the straight line.

In the second stage of our research we interviewed those students who gave contradictory or inconsistent statements and presented them with tasks to help them and us to clarify their understanding of infinity and the means to express their ideas. The results of this work will be the subject of a further paper.

CONCLUSIONS AND FURTHER RESEARCH

We confirmed that the original method of analysis was sound and provided a useful tool to determine students' concepts of infinity. The development of the supplementary tasks for diagnosis and follow-up work were found to be particularly useful. We have listed two of these to which we refer in our analysis. Student's reactions to them confirmed our initial interpretations. The research is currently continuing with particular emphasis on student's solutions of the supplementary tasks, which will allow us to compare their understanding of infinitesimally small and infinitely large infinity. We are working on methods of analysis to do this.

The research was supported by grant GA_R 406/02/0829.

References

Cantor, G. translated by Jourdain, P.E.B. (1955). *Contributions to the Founding of the Theory of Transfinite Numbers*. Dover Publications, New York.

- Fischbein, E., Tirosh, D., Hess, P. (1979). The Intuition of Infinity. *Educational Studies in Mathematics*, Vol. 10, 3-40.
- Fischbein, E. (2001). Tacit Models and Infinity. *Educational Studies in Mathematics*, Vol. 48, Nos. 2-3. 309-329.
- Eisenmann, P. (2002). Predstavy zaku o nekonecnu. In Jirotková, D., Stehliková, N. (Eds). *Proceedings Dva dny s didaktikou matematiky*. PedF UK Praha, 7-14.
- Hejn_, M. (1978). Achilleus a korytnacka ako problem. *Matematika a fyzika ve skole*. 2(9), 102-105.
- Jirotková, D. (1998). Pojem nekonecno v geometrických predstavách studentu primární pedagogiky. *Pokroky matematiky, fyziky a astronomie*, 43, 4, 326-334.
- Jirotková, D. (1996). Understanding of Geometrical Infinity. In Luengo, R.(Ed). *Proceedings of ICME-8*, Sevilla, Short Presentations, 287.
- Jirotková, D. (1997). Creating the concept of infinity in a geometrical context. In Hejn_, M., Novotná, J. (Eds). *Proceedings of ERCME 97*, Charles University, Pod_brady, 89-94.
- Maor, E. (1991). *To Infinity and Beyond*. Princeton University Press, New Jersey.
- Monaghan, J. (1986). *Adolescents' understanding of Limits and Infinity*. Unpublished PhD thesis, Mathematics Education Research Centre, University of Warwick, UK.
- Monaghan, J. (2001). Young people's ideas of Infinity. *Educational Studies in Mathematics*, Vol. 48, Nos. 2-3., 239-257.
- Tall, D. (1996). Thinking about infinity. *International Handbook of Mathematics Education.*, 504-511.
- Tirosh, D. (1991). The role of students' intuitions of infinity in teaching the Cantorian theory. In Tall, D. (Ed). *Advanced Mathematical Thinking*. 199-214.
- Tsamir, P. (1999). Prospective teachers' acceptance of the one-to-one criterion for the comparing infinite sets. In Zaslavsky, O. *Proceedings of PME 2.3 Haifa*, 4-305 – 312

BEYOND DISCOURSE: A MULTIMODAL PERSPECTIVE OF LEARNING MATHEMATICS IN A MULTILINGUAL CONTEXT

Hector Morales Lena Licón Khisty

University of Illinois Chicago

Kathryn Chval

National Science Foundation

This paper presents the idea of multimodal teaching and learning and discusses how this perspective can help better understand the learning of students. The discussion is based on data gathered in a qualitative study of a fifth-grade bilingual classroom where at-risk students were successful in mathematics. We report on one class episode and one student as a case study for understanding multimodal learning. Analyses focus on how students use various texts such as speech and calculator keystrokes as resources to create meaning. This work suggests that a broader perspective and use of modes can support learning and provide students, especially those at-risk, with greater access to mathematics.

Research in mathematics education over the last several years has included communication such as speech and written texts as important factors in learning (e.g., Steinbring, Bartolini Bussi, and Sierpiska, 1998). However, there also has been a tendency to assume that learning is primarily a linguistic accomplishment. Such thinking has obscured the fact that there is actually a multiplicity of modes of communication by teachers and students, including such modes as gestures and actions (Nunez, 2000), and that all of these modes express meaning and contribute to learning. Ignoring these other modes of communication or not bringing them to the forefront of consideration in the learning process, can blind us to key elements of the meaning making process. Moreover it can cause educators to overlook the full range of various resources students draw on to create mathematical meanings. The purpose of this discussion is to consider the idea of multimodal teaching and learning and to present a particular classroom episode to demonstrate how students fluidly and simultaneously use multiple texts to create meaning of a geometric problem.

MULTIMODAL TEACHING AND LEARNING

Our discussion and analyses draw on the work of Kress and his colleagues (e.g., Kress, Jewitt, Ogborn, and Tsatsarelis, 2001). In this work, communication refers to all meaning-making systems, or “modes”; these are organized, regular, and socially specific means of representation (Jewitt, Kress, Ogborn, and Tsatsarelis, 2001). Learning can be seen as a “...process in which pupils are involved in actively ‘remaking’ the information and messages (or complexes of ‘signs’) which teachers communicate in the classroom. In this way learning...is the pupils’ ‘reshaping’ of meaning (signs) to create new meanings (signs)” (Jewitt et al. 2001, p.6). Learning, therefore, is rooted in a dynamic process of sign making, but one which is devised, organized, and used according to social needs and practice (Halliday, 1985). Inherent in this conception of learning is that “...meaning arises as a consequence of choice and that meaning is multiple (Jewitt et al. 2001, p.6). In other words, when we make meaning, we choose to speak, use gestures, make drawings,

move our bodies, or use whatever resource available to communicate or represent our meaning, and we use multiple modes simultaneously.

In classrooms, teachers use a complex of signs or an ensemble of communicative actions to convey specific meanings. Students remake these signs to convey their own meanings or messages of what they have learned. The richer the complex of signs, the more resources students can select and use to make new meanings. These resources or signs are integrated with those that the student already has from other experiences and knowledge including those from outside of school. Therefore, the representational resources available play a key role in mediating the meanings a student produces (Jewitt et al. 2001). Students' text, be it spoken or written, can be considered as 'signs' or evidence of their thinking or meaning making or choices they make in an active and complex transformation. In essence, a multimodal perspective provides a conceptual resource for observing crucial relationships among situated, embodied, and connectionist aspects within emergent forms of cognition.

We apply these ideas to one student's writing, which was part of a lesson solving a geometric problem. We first present a context that includes the problem that had to be solved, another student's oral presentation of a solution, and then the writing. We analyze the writing by examining the connections and selection of resources this student made to convey his meaning. Our intention is to understand the thinking process the text represents in order to better be able to understand multiple modes of communication. We conclude with the implications of a multimodal perspective for learning and for teaching.

CONTEXT OF THE STUDY AND THE DATA

The data were gathered as part of a qualitative study of a bilingual fifth-grade teacher's classroom (Chval, 2001). This teacher had a reputation for implementing standards-based mathematics and for consistently having high achievement gains in mathematics for a majority of her students. Unlike most classrooms in this school and neighborhood, students regularly used TI-30 calculators. In addition, students developed skills in speaking, reading, and writing calculator keystrokes. They used keystrokes to analyze the strategies of others, and to create and articulate reasoning to justify their solutions.

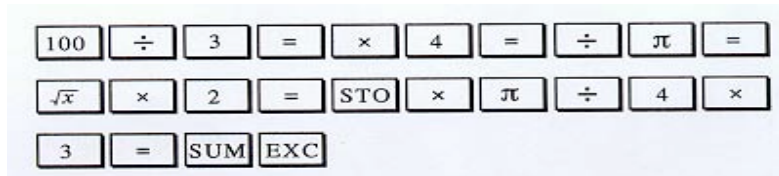

Figure 1: Violetta's calculator keystrokes for problem 1.

Late in the school year, the students were given two problems one of which was: "A three-quarter circle has an area of 100 square centimeters. Calculate the perimeter of the three-quarter circle." Students had already solved similar problems involving full circles; however, the three-quarter element was completely new. Students worked individually and collaboratively to solve this problem. All of them solved the first problem, but only one student, Violetta, solved the second problem. As a result, Violetta volunteered to present the solutions for both problems at the board to the class. Violetta drew a sketch of a three-quarter circle on the board and then wrote the calculator keystrokes for her

solution to the first problem (see Figure 1). As she wrote each keystroke, she explained the meaning behind it.

The following is a transcription of Violetta's presentation of the first problem:

01: Violetta: We are going to find the perimeter of the three quarter-circle. The area of the... The area of the three quarter-circle are 100 square centimeters. Now, we are going to go backward from the area to the perimeter. One hundred divided by three equals the area of one quarter-circle. Multiply by four to get the area of the whole circle. Divide by pi to get the area of the square built on the radius. You take the square root to get the radius. And then you multiply by two to get the diameter. Then we store it. [A reference to the student's calculator.] Then we multiply by pi to get the circumference of the circle. Then we divide it by four to get the quarter-circle. Then we multiply by three to get the curvy part of the three quarter-circle. Then we sum it, sum it to memory. [Another reference to the calculator.] So we can get the circumference, the perimeter, of the three quarter-circle.

After Violetta's presentation and the resulting class discussion, students were asked to write about Violetta's explanation to the problem. Juan's final draft follows.

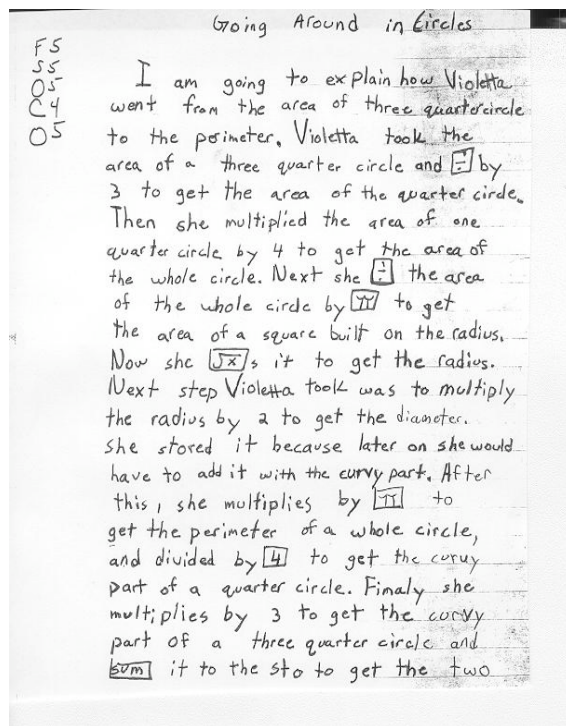

Figure 2.

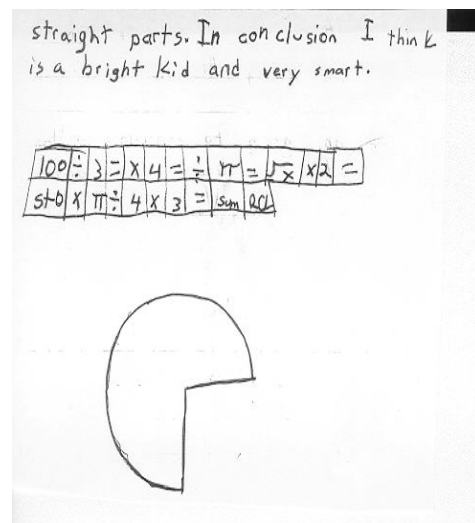

Figure 3.

A MULTIMODAL ANALYSIS OF JUAN'S WRITING

Juan's writing and expression of his mathematical understanding began when the problem was assigned and he went to work to solve it. Violetta's talk contributed to his understanding as well. However, dialogue or talk can be considered only one part of a broader range of modes that contributes to Juan's learning. For our purposes, we concentrate on understanding the interrelationships specifically between four modes of semiotic mediation: Juan's mathematical writing (Written Text), the calculator keystrokes (Mathematical Symbols), Violetta's presentation to the class regarding the same problem (Written & Spoken Text), and the three-quarter circle drawing (Geometric Figure).

We suggest that meanings are being constructed as he moves continuously from the written text to Violetta's spoken text to the geometric figure to the calculator keystrokes in no predetermined order. In this fluid process, Juan uses a variety of signs to create his written text. Each mode shapes his meanings as he constructs his text, but likewise, the written text becomes a mode itself that in turn shapes new meanings for him. To write his text he has to construct meanings regarding how these three modes of signs (Violetta's talk, the geometric figure, and the keystrokes) relate to each other to form a coherent idea.

We partitioned Juan's writing into three sections: finding the area of the whole circle (Table 1); finding the diameter of the circle (Table 2); and finding the perimeter of the three-quarter circle (Table 3). This organizes the data and identifies the various modes of communication that were available to Juan as he wrote his text and the kind of meanings he constructed in this multimodal process. Each table contains Violetta's talk in regards to her presentation to the class, the keystrokes that both Violetta and Juan wrote down either on the board or in Juan's writing, and the geometric images of the three-quarter circle that Juan and Violetta refer to in their explanations.

PART 1: FINDING THE AREA OF THE WHOLE CIRCLE

We begin by looking at Juan's written text regarding finding the area of the whole circle. Juan took what Violetta said, "one hundred divided by three equals the area of one quarter-circle" and changed it to "Violetta took the area of a three quarter circle and \div by three to get the area of the quarter circle." For Juan the 100 (what Violetta said) and the area of the three-quarter circle (what Juan writes) have the same meaning. Juan also included the keystroke symbol \div to help him express his mathematical thinking. His choice to use the "divide" keystroke suggests he equates the word "divides" with the \div keystroke. Altogether, this leads us to believe that, in fact, one can map the calculator keystrokes to Juan's written text (see Table 1). For example, every time Juan uses the expression "to get" in his text, this relates to the keystroke symbol "=". Reciprocally, one may assume that Juan gave the equal symbol the meaning "to get." The use of "to get" also suggests a connection between the keystroke steps and the mathematical concept the steps represent.

Although Juan only included the picture of the three-quarter circle, we wondered what role the images of the three-quarter circle, one-quarter circle, and the whole circle played in the kinds of meanings Juan constructed in this part of his discussion. Over the course of the school year, the students had worked so much with circles in various forms that they seem to be able to visualize the image of a one-quarter circle. In essence, the

students have a strong conceptual history for solving the current problem, and this helps them in the current context. Therefore when Violetta says, “multiply by 4 to get the area of whole circle,” she is actually guiding her peers, including Juan, in forming an image of four quarter-circles forming a whole circle. In Table 1, we see that only the first geometric figure (the three-quarter circle) was evident in Juan’s writing, but clearly the other two images of circles were evident in Juan’s thinking.

<p><i>Violetta’s Talk on her problem to the class</i></p>	<p><i>“The area of the three quarter circle are 100 square centimeters. We are going to go backward from the area to the perimeter. One divided by three equals the area of one quarter-circle. Multiply get the area of the whole circle.”</i></p>							
<p><i>Keystrokes</i></p>	<table border="1" style="margin-left: auto; margin-right: auto;"> <tr> <td style="padding: 5px;"><i>100</i></td> <td style="padding: 5px;">\div</td> <td style="padding: 5px;"><i>3</i></td> <td style="padding: 5px;">$=$</td> <td style="padding: 5px;"><i>X</i></td> <td style="padding: 5px;">4</td> <td style="padding: 5px;">$=$</td> </tr> </table>	<i>100</i>	\div	<i>3</i>	$=$	<i>X</i>	4	$=$
<i>100</i>	\div	<i>3</i>	$=$	<i>X</i>	4	$=$		
<p><i>Geometric Figures</i></p>								
<p><i>Juan’s Writing</i></p>	<p><i>I am going to explain how Violetta went from the area of the three quarter circle to the perimeter. Violetta took the area of a three quarter \div by three to get the area of the quarter circle. Then she multiplied the area of one quarter circle by 4 to get the area of the whole circle.</i></p>							

Table 1. Finding the area of the whole circle.

PART 2: FINDING THE DIAMETER OF THE CIRCLE

After Juan found the area of the circle, he divided by pi. In an earlier lesson, the students were given a circle with a diameter of 10 centimeters inscribed in a square with a side length of 10 centimeters. The square was partitioned into four equal squares built along the radius of the circle. Through various classroom activities students discovered that four squares built on the radius overestimated the area of the circle and three squares underestimated the area. As a result, students thought about building a square on the radius and multiplying by pi to calculate the area of circles. Thus, dividing by pi for Juan meant geometrically that he was finding the area of the square built on the radius (see Table 2). Again the historical context plays a critical role in Juan’s understanding.

Also in Table 2, notice that in Juan’s writing he embeds the keystroke symbols (e.g., 4, π , SUM) inside his narrative in a way that fits grammatically and syntactically with his explanation. We also can see that Juan uses different tenses (e.g., “multiplies,” “divided,” and “would have to add”) throughout his narrative. Writing is the most complex mental function, and it is misleading to think of writing as simply symbolic representation of speech (Wells, 1999) although there is a relationship between the two modes of language.

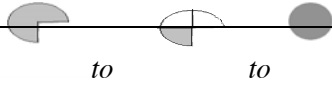
Both speech and writing express the same underlying meanings; however, writing is inherently a problem-solving situation fostered by attempts to create a visual representation of the meanings communicated in speech (Wells, 1999). Writing requires extraordinary deliberate analytical action which we see as Juan balances his written words (“area of a square built on a radius”) with Violetta’s spoken words, the keystrokes, and the geometric image of a quarter circle, all of which represent the area of a square built on a radius.

<i>Violetta’s Talk on her problem to the class</i>	<i>“The area of the three quarter circle are 100 square centimeters. We are going to go backward from the area to the perimeter. One divided by three equals the area of one quarter-circle. Multiply that by four get the area of the whole circle.”</i>							
<i>Keystrokes</i>	<table border="1" style="margin-left: auto; margin-right: auto;"> <tr> <td style="padding: 5px;">100</td> <td style="padding: 5px;">÷</td> <td style="padding: 5px;">3</td> <td style="padding: 5px;">=</td> <td style="padding: 5px;">X</td> <td style="padding: 5px;">4</td> <td style="padding: 5px;">=</td> </tr> </table>	100	÷	3	=	X	4	=
100	÷	3	=	X	4	=		
<i>Geometric Figures</i>	<p style="text-align: center;"><i>From</i> <i>to to</i></p> <div style="text-align: center;">  </div>							
<i>Juan’s Writing</i>	<p><i>I am going to explain how Violetta went from the area of the three quarter circle to the perimeter. Violetta took the area of a three quarter circle \div by three to get the area of the quarter circle. Then she multiplied the area of one quarter circle by 4 to get the area of the whole circle.</i></p>							

Table 2. Finding the diameter of the circle.

PART 3: FINDING THE PERIMETER OF THE THREE-QUARTER CIRCLE

Finally, Juan and Violetta took the circumference of the whole circle and divided by four to find the length of one-fourth the circumference, which Violetta calls the “curvy part.” Then both students multiplied by three to get the “curvy part” of the three-quarter circle. The “curvy part” is represented geometrically in Table 3. Juan and Violetta used four keystrokes related to the calculator’s memory system, namely “SUM,” “STO,” “EXC,” and “RCL.” The “STO” key was used by both students to save the value of the diameter of the circle. Juan added his curvy part “to the STO” and Violetta added hers “to memory.” In both cases, the students used the “SUM” key in their keystroke text to add the value of the diameter to the value of the “curvy part,” but recovered the value of the diameter in slightly different ways as their keystroke text demonstrates in Figures 1 and 2. Juan used “RCL” and Violetta used the “EXC” key, both of which give the same results. This is very important because it is evidence that Juan and Violetta are not simply copying text.

Also each student used different geometric images for combining the curve of the circle and the perpendicular radii, and represented the process in different linguistic styles. Juan combined the “curvy part of the three-quarter circle...and the two straight parts” (radii). Violetta, on the other hand, combined “...the curvy part of the three-quarter circle. Then we sum it, sum it to memory.” The memory she is referring to is the value of the diameter of the circle that she stored earlier. Even though they expressed the three-quarter circle differently, their keystrokes were the same for both of them with the exception of the last keystrokes (RCL and EXC). Clearly both Juan and Violetta seem to understand that the diameter is two times the radius and can be shaped geometrically by perpendicular radii to connect the three-quarter circle. Juan, therefore, is able to move between different ways of representing the diameter to make sense of the problem at hand and additionally balance spoken text, keystrokes, geometric images, and his own text.



<p><i>Violetta's Talk on her presentation to the class</i></p>	<p><i>Then we multiply by pi to get the circumference of the circle. divide it by four to get the quarter circle. Then we multiply by the curvy part of the three quarter-circle. Then we sum it, sum it to [Another reference to the calculator.] So we can get the circumference perimeter, of the three quarter-circle.</i></p>
<p><i>Keystrokes</i></p>	
<p><i>Geometric Figures</i></p>	
<p><i>Juan's Writing</i></p>	<p><i>After this, she multiplies by π to get the perimeter of a whole and divided by 4 to get the curvy part of a quarter circle. Finally multiplies by 3 to get the curvy part of a three quarter circle and to the sto to get the two straight parts.</i></p>

Table 3. Finding the perimeter of the three-quarter circle.

CONCLUSION

Our purpose has been to draw attention to the idea of multimodal teaching and learning in mathematics. The case we discussed presents an example of how students use many modes of signs as resources for learning or meaning making. This suggests that educators need to utilize multiple modes of communication and encourage students to utilize them also. Unfortunately, there is a tendency to inadvertently limit students' access to and use of multiple modes as evidenced by the infrequent use of calculators, drawings, manipulatives, enactment, or even student presentations. For second language learners,

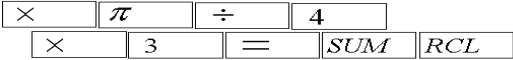
this infrequent use of multiple modes of communication actually limits their means to express their thinking and denies them more than one way to access mathematics.

References

- Chval, K. B. (2001). *A case study of a teacher who uses calculators to guide her students to successful learning in mathematics*. Unpublished doctoral dissertation, University of Illinois at Chicago.
- Jewitt, C., Kress, G., Ogborn, J., and Tsatsarelis, C. (2001). *Exploring learning through visual, actional, and linguistic communication: The multimodal environment of a science classroom*. *Educational Review*, 53 (1), 5-18.
- Halliday, M. (1985). *An introduction to functional grammar*. London: Edward Arnold.
- Kress, G., Jewitt, C., Ogborn, J., and Tsatsarelis, C. (2001). *Multimodal teaching and learning*. New York: Continuum.
- Nunez, R. (2000). *Mathematical idea analysis: What embodied cognitive science can say about the human nature of mathematics*. Opening plenary address in Proceedings of the 24th International Conference for the Psychology of Mathematics Education, 1:3-22. Hiroshima, Japan.
- Steinbring, H., Bartolini Bussi, M., and Sierpinska, A. (1998). *Language and communication in the mathematics classroom*. Reston, VA: National Council of Teachers of Mathematics.
- Wells, G. (1999). *Dialogic inquiry: towards a sociocultural theory and practice of education*. New York: Cambridge University Press.

THE SPONTANEOUS EMERGENCE OF ELEMENTARY NUMBER-THEORETIC CONCEPTS AND TECHNIQUES IN INTERACTION WITH COMPUTING TECHNOLOGY¹

Carolyn Kieran

Université du Québec à Montréal

kieran.carolyn@uqam.ca

José Guzmán

Cinvestav-IPN

jguzman@mail.cinvestav.mx

We present in this paper five case studies of instrumental genesis of number-theoretic concepts and techniques involving multiples, divisors, and numerical decomposition. The pupils, who were 12 to 15 years old, used the multi-line screen display of the graphing calculator to explore numerical tasks related to the “Five steps to zero” problem. The paper begins with a mathematical task analysis of various techniques that could be used to determine divisibility by 9. Findings show that the use of the technological tool permits students of this age to spontaneously develop variants of these techniques within tasks that simultaneously afford the co-emergence of related conceptual notions.

A body of current research in computer-supported mathematics learning environments is oriented toward the theoretical development and empirical study of the interactions among the following concepts: artefact, instrument, technique, task, and theory (e.g., Artigue, 2001; Guin & Trouche, 1999; Guzman & Kieran 2002; Lagrange, 2000; Mariotti, 2002; Trouche, 2000; Varillon & Rabardel, 1995). In particular, these studies discuss the role played by the instrument in the process of instrumental genesis within the context of specific tasks and with pupils of different ages and technological experience. In a paper presented last year at PME (Guzman & Kieran, 2002), we reported, for example, on the perceptions expressed by case-study students of the role played by the calculating tool in the evolution of their numerical conceptual schemas. The present paper, which is quite different, analyses the nature of the mathematical techniques that emerged spontaneously in representative participants of the study. By means of two case studies from each of Secondary 1 and 2, and one from Secondary 3, we illustrate the number-based interactions between students and their calculators and show how, within a given set of tasks, the students developed numerical techniques that were afforded by the technology-supported environment in which their numerical explorations occurred. The emergence of these techniques provides further evidence of the intertwining nature of the development of procedural and conceptual learning in mathematics.

THE RESEARCH STUDY

The study was carried out in Mexico and Canada during the two school years of 1999-2000 and 2000-2001. Its aims were to investigate the role that calculating technology can play in the emergence and development of numerical thinking in students during their first three years of secondary school. Teaching activities were designed that focused on the mathematical content of factors, divisors, and prime and composite numbers. One of

¹ We thank the Social Sciences and Humanities Research Council of Canada (Grant # 410-99-1515) and CONACYT of Mexico (Grant # I32810-S) for their support of the research described in this paper.

these activities was a week-long sequence based on the “Five steps to zero” problem (Williams & Stephens, 1992) given below (along with an example done in four steps—one operation per step). Students were initially pretested on their knowledge of the related mathematical material. The aim of the short pretest was to see if students had the basics that were needed to deal with tasks involving factors and multiples. During the week’s activities that are reported in this paper, students worked alone or in groups—as they wished. From time to time, individual students presented their work to the class by means of the classroom view-screen that was hooked up to their calculator. There were occasions on which students were questioned about the approaches they were using, but no classroom teaching as such took place. At the conclusion of the week’s activities with this problem, four students from each of the six participating classes were individually interviewed.

"Take any whole number from 1 to 999 and try to get it down to zero in five steps or less, using only the whole numbers 1 to 9 and the four basic operations +, -, x, ÷. You may use the same number in your operations more than once." (based on Williams & Stephens, 1992)

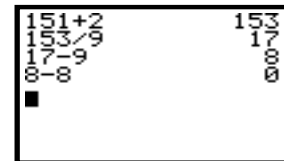

MATHEMATICAL ANALYSIS OF TECHNIQUES

The task of bringing a whole number down to zero in the minimum number of steps (the constraint of minimization was added at the start of the second year of the project) would suggest the use of the largest divisor possible, which according to the rules of the game is 9. The technique of prime decomposition, which a more experienced student of mathematics might turn to, would in many cases involve primes outside the rules of the game and would thus not be admissible. Our “expert” would then likely turn to the criterion for divisibility by 9 and possibly proceed in the following way(s) if presented with, for example, the number 989.

Criterion for divisibility.

Our expert first notices that 989 is not divisible by 9 (without obtaining a remainder) for its digits do not sum to a multiple of 9—they sum to 26. So she has two choices if she still wants to try division by 9. She can add 1 to or subtract 8 from 989. The former leads to a quotient of 110 and the latter, to its predecessor 109. As neither 110 nor 109 is immediately divisible by 9, the entire process of reaching zero will require six steps:

This try: $989 + 1 = 990$, $990 / 9 = 110$, $110 - 2 = 108$, $108 / 9 = 12$, $12 / 6 = 2$, $2 - 2 = 0$

Chaining factors.

Undaunted by a six-step solution, our expert has other techniques to try. As the number 989 is odd, division by 8 is not feasible. And a quick mental calculation lets her know that division by 7 is equally impossible. So, to save some time, our expert—aided by a calculator—decides to try to chain factors as a speedy way in which to find two factors that will work. Chaining three 9s, which yields 729, does not get close enough to 989. So she next tries dividing 989 by implicit chains of two factors to see if she can get to a quotient, that when truncated or rounded, will work back up to a product that is within 9 of 989. When she divides 989 by 49 (i.e., 7×7), she is rewarded by a quotient having a small-enough decimal portion that, when truncated, works back to a number within 9 of 989 and, thus, a solution.

Trials: $9 \times 9 \times 9 = 729$, $989/81 = 12.2$, $989/72 = 13.73$, $989/64 = 15.4$, $989/49 = 20.18$
Subsequent trial to work back to a number within 9 of 989: $7 \times 7 \times 5 \times 4 = 98$ (5 and 4 being the factors of the truncated quotient of 20.18)
Solution: $989 - 9 = 980$, $980/7 = 140$, $140/7 = 20$, $20/5 = 4$, $4 - 4 = 0$

The division algorithm.

A person unaware of the criterion for divisibility by 9 might approach the task from the perspective of the division algorithm whereby any whole number can be expressed as the product of two whole numbers plus remainder, that is, $a = b \times c + d$ (in this case, $989 = 9 \times 109 + 8$). Operationalizing this theorem into a solution could take many forms as the value of c is obtainable by various means. The example below, for instance, illustrates the carrying out of a trial division by 9, followed by the multiplication of the truncated quotient with 9 in order to see how far the product is from the initial number, 989—an approach that we will call the “division algorithm invoking trial division.”

Example: $989/9 = 109.8888889$, $9 \times 109 = 981$, $989 - 8 = 981$, $989/9 = 109$, and so on

A variant of this approach, which we call the “division algorithm invoking trial multiplication,” involves carrying out, perhaps several, trial multiplications in order to find the value of c . For example, $9 \times 106 = 954$, $9 \times 108 = 972$, $9 \times 109 = 981$ --the latter trial clearly bringing the solver into the interval that is within 9 on either side of 989.

However, both of the solution paths suggested by the division algorithm will, for the given number 989, engender a six-step solution. Dividing by 9, after adjusting the given number by subtracting, will not produce a five-step solution for 989; other divisors less than 9 must be found (as in the “chaining factors” approach above). In actual fact, all of the whole numbers from 1 to 1000, with the exception of 851 and 853, can be reduced to zero in five or fewer steps. These two exceptions require six steps--851 being the product of the two primes 23 and 37, and 853 being itself prime. All of the numbers in the vicinity of these two, that is, within 9 on either side of 851 and 853, require five steps to reach zero, thus necessitating six steps for these two.

Without knowing in advance the minimal number of steps required to bring such numbers down to zero, the expert finds herself searching for multiples of, especially, 8 or 9, in the immediate vicinity—being careful to avoid, if possible, those composite numbers whose prime decomposition includes primes beyond the range of the acceptable divisors, as each of these requires an extra step in order to be converted to some divisible number. But while the non-expert may share the same general goals as the expert, he or she may lack the techniques of the expert for generating fruitful solution paths and may thus have to rely on a great deal more trial-and-improvement. Despite the importance of elementary concepts of number theory to the field of mathematics, we know very little about the ways in which students at the lower levels of secondary school develop such content knowledge. A few related studies have been carried out with preservice elementary school teachers (e.g., Lester & Mau, 1993; Martin & Harel, 1989; Zazkis & Campbell, 1996); however, as pointed out by Zazkis and Campbell, such concepts have received scant attention in mathematics education research. The upcoming section describes the techniques developed by the 12- to 15-year-old students of our study (none of the case-study examples included below knew the criterion for divisibility by 9) and

suggests how their increasingly instrumented² use of the technology within these tasks was an indispensable tool for the growth of their number theoretic concepts.

THE CASE STUDIES

Secondary 1: The cases of Marianne and Mara Marianne and Mara were mathematically strong, according to both their teacher and their pretest results. From the very beginning of their work with the activity sequence being reported herein, they showed a preference for trying to find the largest divisors possible for the given numbers, or for first transforming the given numbers by addition or subtraction into numbers that could potentially be divided by 7, 8, or 9; but all was by means of trial-and-improvement. However, towards the end of the week-long sequence, a new technique emerged for Marianne, that of the use of the “division algorithm invoking trial multiplication.” This became evident when she was invited to come to the front of the class, where a classmate threw her the challenge of bringing 971 down to zero in the minimum number of steps possible. Figures 1a and 1b show each calculator entry she tried—her approach being demonstrated on the classroom view-screen.³

L2: 9 □ 86	774
L3: ⁽²⁾ 9 □ 76	684
L4: 9 □ 97	873
L5: 9 □ ⁽³⁾ 1	
L6: 9 □ 99	891
L1, L2, ..., L6	
L7: 9 □ 105	945
L8: 9 □ 110	990

Figure 1a (Marianne)

L9: 9 □ 107	963
L10: ⁽²⁾ 9 □ 106	954
L11: 9 □ 108	972
L12: 971 + 1	972
L13: 972/9	108
L14: ⁽³⁾ 108/6	18
L15: 18/9	2
L16: 2 - 2	0

Figure 1b (Marianne)

Having found the value of c to be 108 in $a = b \times c + d$, where $a = 971$ and $b = 9$ (see L11 of Figure 1b), Marianne generated a five-step solution (L12-L16).

During the same class session, Mara was invited to come forward to the view-screen and was given the number 731 to tackle. A new technique seemed to emerge for her during the very moment that she worked on this problem (see Figures 2a and 2b). Her first tries consisted, up to line 16 (see Figs. 2a & 2b), of what we would call “the unsystematic search for another number that is a multiple of 9, in the vicinity of the given number.” But then in L17, we notice the evolution from the “unsystematic search for a multiple of 9” technique to one that was new for Mara, that of the “division algorithm invoking trial division.” She seemed to have taken note, perhaps for the first time, of the quotient produced in L16, and then used the rounded-up quotient as a trial factor in L17. The product of 9 and 82 (i.e., 738) suggested to her the exact adjustment necessary to be made

² According to Varillon and Rabardel (1995, p. 85), a tool becomes an instrument for the subject when “the subject has been able to appropriate it for himself—has been able to subordinate it as a means to his end—and, in this respect, has integrated it with his activity.”

³ Legend for calculator-screen transcriptions: Ln—refers to the line of the calculator display screen. A set of screen lines that is crossed out denotes those that the student has deleted from the screen. The small number in parentheses indicates the time taken by the student before entering the number that follows—5 blinks of the screen cursor being equal to one unit in parentheses.

to the given number 731 in order to have a number (738) that would be divisible by 9. It did not lead to a five-step solution; but it represented an advance in the development of her mathematical thinking.

L1 : $731^{(1)} + 1$	732
L2 : $732/9$	81.33
...	
L10 : $731 - 8$	723
L11 : $723/9$	80.33

Figure 2a (Mara)

L16 : $731/9$	81.22
L17 : $9 \square 82$	738
L18 : $731 + 7$	738
L19 : $738/9$	82
L20 : $82/2$	41

Figure 2b (Mara)

Secondary 2: The cases of Pablo and Nicolas Pablo was an average student in mathematics, according to both his teacher and his pretest results. During the first few days of the activity sequence designed around the “Five steps to zero” problem, Pablo had developed the technique involving the “division algorithm invoking trial division.” This was seen in his immediate use of this technique when his classmates proposed to him that he try the number 931 (see Figure 3). On one of his earlier worksheets he had described his technique as follows: “I divide the given number by 9, and the whole number that I obtain, I multiply it by 9. After, I subtract in order to have a multiple of 9 and afterwards divide by 9.” What is of interest, however, is that he did not continue with this technique all the way down to zero. There was a lengthy pause (see L4 of Fig. 3), followed by the unsystematic search for another number, in the vicinity of 103, that would be a multiple of 7, or 8, or 9 (see L7). We conjecture that he had developed the awareness that, each time it was used, his initial technique involved two steps--the adjustment up or down of the given number, followed by the division by 9. Thus, continuing with it would not lead to a five-step solution when the quotient after performing the second division by 9 was greater than 9. He was therefore searching for an alternate technique to apply to the second round of his solving process, one that would permit him to bring numbers in the vicinity of 100 down to zero in three or fewer steps.

L1 : $931/9$	103.44
L2 : $9 \square 103$	927
L3 : $931 - 4$	927
L4 : $ans/9$	$103^{(5)}$
...	
L7 : $107/7$	14.71

Figure 3 (Pablo)

L5 : $9 \square 9 \square 4$	324
L6 : $9 \square 9 \square 5$	405
L7 : $9 \square 8 \square 5$	360
L8 : $362 - 2$	360
L9 : $360/9$	40
L10 : $40/8$	5

Figure 4 (Nicolas)

Because the case of Nicolas was described in detail in Guzman and Kieran (2002), it will suffice to mention here that Nicolas, a bright student of mathematics, developed over the course of the week’s activity with the “Five steps to zero” problem a technique that combined the “chaining of factors” approach with the “division algorithm invoking trial multiplication.” It took the form: $a = b \times c \times d + e$ (where a is the given number; b , c , and d are the factors whose product is within the interval of 9 on either side of a ; and e is the remainder) (see Figure 4 for his work with the given number 362).

Secondary 3: The case of David David was mathematically strong, according to both his teacher and his pretest results. From the very beginning of his work with the activity sequence, he showed a preference for trying to “find the largest divisors possible (e.g., 9,

8, 7, 6) for the given number.” As was indicated during the interview with him at the end of the week’s activities, when he was presented with, for example, the number 546, he was quite consistent with the application of this technique (see Figures 5a and 5b). When, however, the given number was not divisible by one of these factors, as was the case with 323 which was presented to him later in the interview, we noted that he had developed the technique of the “division algorithm invoking trial division”—but with a twist. Rather than rounding or truncating the quotient after dividing by 9, he successively tried to eliminate the decimal portion of the quotient by adjusting the given number up or down in a quite systematic way (see Figures 6a and 6b).

L1 : 546/9	60.66
L2 : 546/8	68.25
L3 : 546/7	78
L4 : ans/9	8.66
L5 : 78/8	9.75
L6 : 78/6	13

Figure 5a (David)

L7 : 546/7	78
L8 : ans/7	11.14
L9 : 78/6	13
L10 : ans - 4	9
L11 : ans - 9	0

Figure 5b (David)

L1 : 323/9	35.88
L2 : 326/9	36.22
L3 : 324/9	36
{L1, L2, L3}	

Figure 6a (David)

L4 : 323 + 1	324
L5 : ans/9	36
L6 : ans/9	4
L7 : ans - 4	0

Figure 6b (David)

DISCUSSION

Mathematics educators have, for decades, tended to view conceptual and procedural knowledge as two quite different entities—the latter being clearly associated with the development of techniques, skills, and mathematical processes; the former with the understanding of the objects being manipulated (see, e.g., Hiebert, 1986). The notion that a learner could be fostering conceptual learning at the same time as perfecting his/her expertise with mathematical procedures has, until now, never really been elaborated. However, the growth of new theoretical perspectives, related to the use of technology in the learning of mathematics, currently furnishes us with the tools to think about conceptual and technical work in terms of their interaction and co-emergence rather than as completely separate activities.

In the mid-1990s, in France, when Computer Algebra Systems (CAS) started to make their appearance in high school mathematics classes, researchers (Artigue et al., 1998) noticed that teachers were emphasizing the conceptual dimensions while neglecting the role of the technical work in algebra learning. However, this emphasis on conceptual work was producing neither a clear lightening of the technical aspects of the work nor a definite enhancement of students’ conceptual reflection (Lagrange, 1996). From their observations, the research team came to think of techniques as a link between tasks and conceptual reflection. Lagrange has argued that a technique “plays an epistemic role contributing to an understanding of the objects that it handles particularly during its elaboration; it offers also an object for conceptual reflection when comparing it with other techniques or discussing its consistency” (Lagrange, in press, p. 2). While this theoretical perspective has been elaborated within the context of CAS, the findings of the

present study point to its relevance for other technology-supported learning environments in school mathematics.

The case studies reported in this paper support the thesis that students' conceptual development with respect to elementary number-theoretic notions is enhanced by their technical work on tasks involving computing technology. Secondary 1 and 2 students' work during the early part of the week-long activities on the "Five steps to zero problem" tended to be based on much more primitive techniques, such as converting the given number into one that ended in 5 or 0 in order to carry out a division by 5 (Guzman, Kieran, & Squalli, 2001). Very few students at these two grade levels initially used the technique of increasing or decreasing the given number so as to make it divisible by 9 (in contrast, this tended to be the dominant technique employed by Secondary 3 students right from the start). However, without any instruction, most of these students evolved toward variants of this latter technique. The case studies described herein show the different ways in which this technique developed and the forms that it took. The case of Mara illustrated in particular how her specific technique emerged spontaneously while she was in the process of attempting to find a solution. As was seen with all of the cases presented above, it was primarily the division algorithm, involving some version of either trial division or trial multiplication, that served as the basis for exploring divisibility by 9, and related notions of multiples and numerical decomposition.

None of the cases presented here were aware of the criterion for divisibility by 9, and space constraints did not allow for including extracts of the work of students who were so aware. Students not knowing this rule needed to develop their own techniques for finding out if a number was divisible by 9, if they wished to divide by the largest number possible in the "Five steps to zero" activity. Some educators may ask, why not immediately teach them the criterion for divisibility by 9? Suffice it to say that the students, who at the outset of this activity knew the rule of adding up the digits of the given number to determine whether the total was a multiple of 9, did not develop the repertoire of number-theoretic techniques or conceptual notions described above. In fact, when their use of the criterion for divisibility by 9 did not bring them to zero in five steps, they floundered—their subsequent work tending to be unsystematic. They behaved as if there was no need to struggle with developing a technique, as they already had one—even if it did not always lead to a solution. Thus, the richness that was observed in the approaches that emerged in the cases presented above was not, in general, seen in those who had begun this study with the criterion for divisibility by 9.

Salomon, Perkins, and Globerson (1991) have distinguished "effects with technology obtained during intellectual partnership with it, from effects of technology in terms of the transferable cognitive residue that this partnership leaves behind in the form of better mastery of skills and strategies" (p. 2). The students who knew the criterion for divisibility by 9 were relatively successful working with the technology. But because they did not have to work to find a technique for determining if a number was divisible by 9, the numerical explorations that were engaged in by the case-study students and others were absent in them. Thus, it was those who did not have the prior awareness of this criterion who could be said to have benefitted most from the effects of the technology. In their search for techniques for handling the task at hand, their number sense with respect to factors, divisors, and numerical decomposition evolved in a manner that was not evident among their criterion-aware peers.

In 1995, Verillon and Rabardel, the pioneers of instrumental theory related to technological artefacts and instruments, posed the questions: “How are instruments, derived from modern technology, associated by subjects with their actions and, as such, inserted in their activity? What influence does this have on activity? How is it modified?” (p. 84). We hope that the case studies presented herein, against the backdrop of the mathematical analysis that was offered with respect to the divisibility-by-9 part of the task, have been able to partially respond to these questions by illustrating the interaction that occurred for these subjects between their use of the calculator as a means for developing new techniques and its role in the emergence of new ways of thinking about number and its structural decomposition.

References

- Artigue, M., Defouad, B., Duperier, M., Juge, G., & Lagrange, J.B. (1998). *Intégration de calculatrices complexes dans l'enseignement des mathématiques au lycée*. Paris: Université Denis Diderot Paris 7.
- Artigue, M. (2001). *Learning mathematics in a CAS environment: The genesis of a reflection about instrumentation and the dialectics between technical and conceptual work*. CAME, Utrecht, NL.
- Guin, D., & Trouche, L. (1999). The complex process of converting tools into mathematical instruments: The case of calculators. *Int. Jour. of Computers for Math. Learning*, 3, 195-227.
- Guzman, J., & Kieran, C. (2002). The role of calculators in instrumental genesis: The case of Nicolas and factors and divisors. In *Proceedings of 26th PME Conference* (Vol. 3, pp. 41-48). Norwich, UK.
- Guzman, J., Kieran, C., & Squalli, H. (2001). The multi-line screen calculator and the emergence of numerical strategies in secondary 1, 2, and 3 students. In *Proceedings of 25th PME Conference* (Vol. 1). Utrecht, NL.
- Hiebert, J. (1986). (Ed.). *Procedural and conceptual knowledge: The case of mathematics*. Erlbaum.
- Lagrange, J.-b. (1996). Analysing actual use of a computer algebra system in the teaching and learning of mathematics. *International DERIVE Journal*, 3, 91-108.
- Lagrange, J.-b. (2000). L'intégration d'instruments informatiques dans l'enseignement: Une approche par les techniques. *Educational Studies in Mathematics*, 43, 1-30.
- Lagrange, J.-b. (in press). Learning techniques and concepts using CAS: A practical and theoretical reflection. In *Computer Algebra Systems in School Mathematics*. Reston, VA: NCTM.
- Lester, F.K., Jr., & Mau, S.M. (1993). Teaching mathematics via problem solving: A course for prospective elementary teachers. *For the Learning of Mathematics*, 13(2), 8-11.
- Mariotti, M.A. (2002). Influence of technology advances on students' math learning. In L. English (Ed.), *Handbook of Inter. Research in Math. Educ.* Mahwah, NJ: Lawrence Erlbaum.
- Martin, W.G., & Harel, G. (1989). Proof frames of preservice elementary teachers. *JRME*, 20, 41-51.
- Salomon, G., Perkins, D.N., and Globerson, T. (1991). Partners in cognition: Extending human intelligence with intelligent technologies. *Educational Researcher*, 20(3), 2-9.
- Trouche, L. (2000). La parabole du gaucher et de la casserole à bec verseur: Étude des processus d'apprentissage dans un environnement de calculatrices symboliques. *E.S.M.*, 41, 239-264.
- Verillon, P., & Rabardel, P. (1995). Cognition and artifacts: A contribution to the study of thought in relation to instrumented activity. *European Journal of Psychology of Education*, X, 77-101.
- Williams, D., & Stephens, M. (1992). Five steps to zero. *Calculators in math. education*. Reston, VA: NCTM.
- Zazkis, R., & Campbell, S. (1996). Divisibility and multiplicative structure of natural numbers: Preservice teachers' understanding. *Journal for Research in Mathematics Education*, 27, 540-563.

SECONDARY SCHOOL MATHEMATICS PRESERVICE TEACHERS' PROBABILISTIC REASONING IN INDIVIDUAL AND PAIR SETTINGS

Hari P. Koirala

Eastern Connecticut State University

Fairly large amount of research on students' conceptions of probability has been reported in the literature. Most of this work represents school students' reasoning of probability in individual setting. This study provides 8 secondary school mathematics preservice teachers' reasoning of probability in both individual and pair settings. Consistent with previous studies the findings of this study indicate that preservice teachers' conceptions of probability are often different across settings. However, a few preservice teachers who strongly believed in formal reasoning provided consistent argument across all settings if similar tasks were presented. It is suggested that the teaching of probability should provide an opportunity for students to interact in both individual and group settings.

INTRODUCTION AND THEORETICAL FRAMEWORK

Fairly large amount of research on student conceptions of probability has been reported in the literature. Several researchers have explored K-12 and first-year college students' conceptions of probability and have reported that students' conceptions of probability are often different from those presented in schools (Kahneman & Tversky, 1972; Konold, Pollatsek, Well, Lohmeier, & Lipson, 1993; Shaughnessy, 1992; Tversky & Kahneman, 1982; Van Dooren, De Bock, Depaepe, Janssens, & Verschaffel, 2002). A few studies have also explored preservice teacher's understanding of probability and have reported that similar to students at K-12 and first-year college, preservice teachers' conceptions were often informal and intuitive particularly when the probability tasks were novel and non-routine (Bramald, 1994; Koirala, 1999, 2002).

Most of these research reported in this field have focused on students' conceptions of probability in individual settings. Because researchers have emphasized the importance of interactions generated from collaborative and cooperative learning (Carvalho & César, 2001; Kieran & Dreyfus, 1998; Mueller & Fleming, 2001), it is important to investigate how people reason similarly or differently in individual and group situations. The purpose of this paper is to provide some insight into this area of individual versus pair problem solving in the context of probability problems. This study sought to answer the following questions:

What kinds of probabilistic reasoning do secondary school mathematics preservice teachers demonstrate in individual and pair settings?

In what ways do preservice teachers' reasoning of probability vary across individual and pair settings?

How do preservice teachers perceive the individual and pair problem solving in probabilistic situations?

RESEARCH METHODS

Participants

This is a part of larger study in which 40 secondary school mathematics preservice teachers participated in solving 15 probability problems in written, pair, and/or individual interview settings. This paper focuses on 8 secondary school preservice teachers, who had taken at least 10 mathematics undergraduate courses, including a probability and statistics course. These preservice teachers were paired into four groups based on their responses to a written questionnaire and a probability problem. Each pair consisted of preservice teachers with diverse backgrounds and opinions so as to produce interactions that would help broaden the exploration of students' conceptualization of probability.

Tasks

This study is based on data collected from three tasks, one in the written setting, one in the pair setting, and one in the individual interview setting. Although the participants were asked to solve several other problems, only three are selected for this study because these three tasks are almost identical and allowed the researcher to track participants' views in individual and pair settings.

The task in the written setting was called the birth sequence task, and asked participants to select the most likely sequence of births in a family. In the pair setting, the participants were given the head-tail sequence task, wherein participants were asked to determine the most likely sequence of alternatives that might result from flipping a fair coin six times. The head-tail sequence task was repeated in the individual interviews to determine whether or not the participants transferred their knowledge from the pair setting to the individual setting. The detail of each task is provided below.

Written Task

1. Birth sequence task

A couple plans to have six children. Which of the following orderly sequence of birth is most likely? (Boys = B, Girls = G).

- (a) BGBBBB
- (b) BBBGGG
- (c) GBGBBG
- (d) BGBGBG
- (e) All four sequences are equally likely.

Give reasons for your choice.

(Modified from Kahneman & Tversky, 1972 and Konold et al., 1993)

Pair Task

1. Head-tail sequence task

Which of the following orderly sequences is most likely to result from flipping a fair coin six times? (Heads = H, Tails = T).

- a) HTHHHH
- b) HHHTTT
- c) THTHHT
- d) HTHTHT
- e) All four sequences are equally likely.

Give reasons for your choice.

(Modified from Kahneman & Tversky, 1972 and Konold et al., 1993)

Interview Task

1. Head-tail sequence task

Same from the pair task

At the final stage of the interview, the participants were asked to determine if the orderly sequences would be still equally likely if the number of trials was increased from 6 to 20.

DATA COLLECTION AND ANALYSIS PROCEDURES

The written component of this study was presented in a test-like situation and participants' work was collected on the same day. Their written work was analyzed and the participants were paired after two weeks. In the pair-problem solving, participants were asked to discuss possible solutions to the task. That is, pairs discussed and attempted to solve the task together. The investigator observed the pairs' work and made notes. Only in certain circumstances, for example if pairs stopped talking or reached an agreement very quickly, did the investigator provide prompts. The discussions were audiotaped. The participants were interviewed in the individual setting after a week. They were given the same head-tail sequence task from the pair setting in this interview. Each interview was audio-taped and then transcribed.

The researcher coded, analyzed, and categorized each response from written, pair, and interview settings using qualitative data analysis methods, in particular the constant comparative method (Guba & Lincoln, 1989) and the interactive model (Huberman & Miles, 1994). Their responses were categorized in three different ways based on their use of formal or informal probabilistic reasoning, their change of reasoning from one setting to the other, and their perception of solving problems in individual and pair settings.

RESULTS AND DISCUSSION

While attempting to solve probability problems, the preservice teachers used both formal and informal probabilistic reasoning. Their formal probability was often based on university courses and informal probability was based on their everyday intuitions and experiences. Four out of 8 preservice teachers provided formal reasoning in the birth sequence task, which was presented in a test like situation in the written setting. In the birth sequence task of the written component they reasoned that all four sequences are equally likely because "the probability of having a boy or a girl does not depend on the previous child's sex." Three out of these 8 preservice teachers reasoned that since there

were six births the probability of each sequence is $\frac{1}{64}$. The participants who provided informal reasoning in the written task demonstrated some elements of representativeness heuristic (Kahneman & Tversky, 1972). According to this heuristic: (1) the outcome in the sample should look like its parent population and (2) events in an outcome should appear random. Four preservice teachers provided informal and inconsistent reasoning in their written responses. For example, in the birth sequence task two participants selected that the sequence GBGBBG would be most likely because they had the same number of boys and girls and the sequence also appeared more random.

In the pair setting, it was clear that all preservice teachers wanted to solve the tasks using their mathematical knowledge from a formal perspective. In particular, all four preservice teachers who provided formal reasoning in the written setting also provided formal reasoning in the pair-problem setting. For example, a formal thinker stated:

It's equally likely because the probability of having a head doesn't depend on ... a previous throw. The probability of getting a tail is not going to be greater if you had a head in the previous throw. If you had a head in the first time, the probability of getting a head in the second time is still one half. Doesn't matter if you've 10 heads in a row, the probability of getting the eleventh head is still one-half and the probability of getting the eleventh tail is still one-half.... What happened in the past doesn't influence the present throw.

Similarly, another preservice teacher, who provided formal reasoning in the written setting argued that all the four sequences in the head-tail sequence task of the pair setting are equally likely. According to this preservice teacher,

... no matter how many times you flip the coin it's a 50/50 chance of whether or not you're getting a heads or a tails and there is no order to it. Every time you do it doesn't depend on the time before. If I get a head this time ... there is no effect whether or not I get a head or tail the next time.

In all the pairs the formal thinkers started the conversation and provided formal reasoning as above. When the informal thinkers in the pair settings heard this kind of formal reasoning, they often quickly agreed with the formal thinkers and stated that “even if it’s a tail or a head for the first time the probability of having a tail or a head for the second time would be still 50%.” In two cases the informal thinkers resisted initially but changed their mind when further convinced by their partners. However, the interactions between them were positive and no tensions were noticed.

In the interview setting, all the preservice teachers recognized that the head-tail sequence task was repeated from the pair setting and all of them initially stated that all sequences are equally likely. Clearly the informal thinkers learned from their interactions in the pair setting and provided formal answers in the interview setting. In further probing, one preservice teacher who had provided informal reasoning in the written setting and had shown some initial resistant in the pair setting was not convinced in the interview setting that all sequences were equally likely. This participant stated:

Okay, first of all I thought that all four outcomes are possible and then I realize that ... it also deals with order. When you say for example b) is HHHTTT... the first one of course is half/half, either half head or tail. Then if you want to produce a second head I think the probability of producing a head and a tail would be different because since the first time

is not a tail so I think increases the probability of having a tail instead of a head. That's why I'm thinking that the ... four outcomes will not be equally likely. You have to look at the order in order to decide which one is most likely. ... Here the first one is head and then tail then following four heads. I guess when I think about it ... I'm trying to think about ... a possible answer and also ... I try to use my common sense to decide. I think the first two are not most likely. c) and d) are probably likely in the sense they're more even like three tails and three heads but the order is different. It looks that c) is more random than this one [d]. So I feel somehow that the random is more likely.

Clearly the pair interaction was not sufficient for this preservice teacher to change her mind. The above response shows an important element of representativeness heuristic as described by Kahneman and Tversky. Interestingly, this preservice teacher has also shown the same kind of reasoning in the written setting.

Furthermore, the preservice teacher responses differed when the interview task was modified by increasing the number of trials from 6 to 20. Three of the formal thinkers who had used a mathematical procedure in the written and pair settings still provided formal reasoning even when the task was modified. For the modified head-tail sequence task with _____ they were quick to say that the probability of getting a sequence in the task was $(\frac{1}{2})^{20}$. But one of the four formal thinkers, who had not used a mathematical procedure as this one, was not sure if all of the sequences would be equally likely if the number of trials was increased up to 20. None of the four preservice teachers who had provided informal reasoning in the written setting were ready to agree that all four sequences are equally likely if the number of trails was 20. One of these preservice teachers clear stated that when _____ the right answer should be (e) wherein all sequences are equally likely especially because of the relatively small sample size. If the sample size was large enough, she would think that a sequence with nearly an equal number of heads and tails would be most likely. Preservice teachers who provided inconsistent reasoning across various settings, was because of the conflict between their informal beliefs and their mathematical knowledge of probability.

With regard to their perceptions on individual versus pair problem solving, they reported that they felt comfortable in the pair setting because solving the given problem was a shared responsibility of both participants. The preservice teachers were asking questions and providing answers to each other without hesitation, even though the investigator was present during the pair problem solving. They all thought that they had fun solving problems in a pair situation. The informal thinkers, in particular, thought that they learned important probabilistic reasoning from their peers even though this learning was not transferred in a more difficult probabilistic situation.

CONCLUSIONS AND IMPLICATIONS

The secondary school mathematics preservice teachers demonstrated both formal and informal reasoning in this study. Three of 8 preservice teachers consistently used a formal mathematical procedure in all the settings. The informal thinkers who could not use a mathematical procedure were the ones who demonstrated inconsistent informal reasoning in various settings. Despite this inconsistency they reported that solving problems in pairs was helpful for them both socially and academically. They felt comfortable and also

demonstrated some formal probabilistic reasoning in the interview setting when the same task was presented. The findings of this study are similar to those found by Carvalho & César (2001) and Kieran and Dreyfus (1998) that the participants benefited from peer interactions that took place in pair problem solving.

This has an important implication for teaching probability. Because many students and preservice teachers find probability to be difficult and confusing (Bramald, 1994; Kahneman & Tversky, 1972; Koirala, 1999, 2002; Konold et al., 1993; Shaughnessy, 1992; Tversky & Kahneman, 1982; Van Dooren, et al., 2002), it is important that they have opportunity to share their thinking with their peers and learn from those social interactions. It has to be noted, however, that the informal thinkers carried their learning to the interview setting only when the same task was presented. This might be because the participants had only a small amount of time to interact in the pair setting. It is critical that they have more opportunity to participate in various types of problem solving in pairs or groups to increase the likelihood of their ability to transfer their learning in a different situation.

In all settings of this study, formal probabilistic reasoning was valued by the preservice teachers. Regardless of the number of mathematics course taken, a preservice teacher who used formal probability usually led the discussion in the pair problem solving. However, the formal thinkers not necessarily took the largest number of mathematics and probability courses. There was one preservice teacher in particular who had taken only 10 mathematics courses, including a probability and statistics course, provided a strong formal reasoning than any of the other preservice teachers who participated in this study. She led the discussion even though she was paired with a student who had completed an undergraduate major in mathematics with 16 courses.

This raises a question about the purpose of a probability course taught in school or university. Is the purpose of a school or university probability course to enhance students' formal probabilistic thinking? If so, why do preservice teachers who have taken a large number of university courses do not show formal reasoning while attempting to solve probability problems? If the secondary school mathematics preservice teachers with a reasonably strong background in mathematics do not show a formal probabilistic reasoning, then how can school students with a comparatively weak background in mathematics be expected to show a formal reasoning? These questions raise important issues about what, why, and how we should teach probability in schools, colleges, and universities.

References

- Bramald, R. (1994). Teaching probability. *Teaching Statistics*, 16 (3), 85–89.
- Carvalho, C., & César, M. (2001). Peer interactions and statistics learning. In M. van den Heuvel-Panhuizen (Ed.), *Proceedings of the 25th Conference of the International Group for the Psychology of Mathematics Education* (Vol. 2, pp. 217-224). Utrecht, The Netherlands: Freudenthal Institute.
- Guba, E. G., & Lincoln, Y. S. (1989). *Fourth generation evaluation*. Newbury Park, CA: Sage Publications.

- Huberman, A. M., & Miles, M. B. (1994). Data management and analysis methods. In N. K. Denzin & Y. S. Lincoln (Eds.), *Handbook of Qualitative Research* (pp. 428-444). Thousand Oaks, CA: Sage Publications.
- Kahneman, D. & Tversky, A. (1972). Subjective probability: A judgment of representativeness. *Cognitive Psychology*, 3, 430-454.
- Kieran, C., & Dreyfus, T. (1998). Collaborative versus individual problem solving: Entering another's universe of thought. In A. Olivier and K. Newstead (Eds.), *Proceedings of the 22nd Conference of the International Group for the Psychology of Mathematics Education* (Vol. 3, pp. 112-119). Stellenbosch, South Africa: University of Stellenbosch.
- Koirala, H. P. (1999). Inconsistencies in preservice teachers' thinking about probability. In F. Hitt & M. Santos (Eds.), *Proceedings of the Twenty First Annual Conference of the North American Chapter of the International Group for the Psychology of Mathematics Education*, Vol. 2 (pp. 479-484). Columbus, OH: ERIC Clearinghouse for Science, Mathematics, and Environmental Education.
- Koirala, H. P. (2002). Secondary school preservice teachers' understanding of probability: An experiment with three dice. *Focus on Learning Problems in Mathematics*, 24(4), 20-34.
- Konold, C., Pollatsek, A., Well, A., Lohmeier, J., & Lipson, A. (1993). Inconsistencies in students' reasoning about probability. *Journal for Research in Mathematics Education*, 24 (5), 392-414.
- Mueller, A., & Fleming, T. (2001). Cooperative learning: Listening to how children work at school. *The Journal of Educational Research*, 94(5), 259-265.
- Shaughnessy, J. M. (1992). Research in probability and statistics: Reflections and directions. In D. A. Grouws (Ed.), *Handbook of research on mathematics teaching and learning: A project of the National Council of Teachers of Mathematics* (pp. 465-494). New York: Macmillan.
- Tversky, A. & Kahneman, D. (1982). Judgments of and by representativeness. In D. Kahneman, P. Slovic, & A. Tversky (Eds.), *Judgment under uncertainty: Heuristics and biases* (pp. 84-98). Cambridge: Cambridge University Press
- Van Dooren, W., De Bock, D., Depaepe, F., Janssens, D., & Verschaffel, L. (2002). Secondary school students' illusion of linearity: Expanding the evidence towards probabilistic reasoning. In A. D. Cockburn and E. Nardi (Eds.), *Proceedings of the 26th Conference of the International Group for the Psychology of Mathematics Education* (Vol. 4, pp. 305-312). Norwich, England: University of East Anglia.

•

Page Intentionally Left Blank

SOCIAL TRANSFORMATION OF STUDENTS' CONCEPTUAL MODEL: ANALYSIS OF STUDENTS' USE OF METAPHOR FOR DIFFERENTIAL EQUATIONS¹

Mi Kyung Ju Oh-Nam Kwon

Kyung-Hee Shin Kyoung-Hee Cho
(Ewha Womans University)

This research applies the discursive approach to investigate the social transformation of students' conceptual model of differential equations. The analysis focuses on the students' use of metaphor in class in order to find kinds of metaphor used, their characteristics, and a pattern in the use of metaphor: Based on the analysis, it is concluded that the students' conceptual model of differential equations gradually becomes transformed with respect to the historical and cultural structure of the communal practice of mathematics. The findings suggest that through participating in the daily practice of mathematics as a historical and cultural structure, a learner becomes socially transformed to a certain kind of a cultural being with historicity. This implies that mathematics education is concerned with the formation of historical and cultural identity at a fundamental level.

INTRODUCTION

What does a student learn in mathematics class? How does a student change as s/he participates in mathematical practice in class? This paper aims to address these questions by applying social practice theory to analyze mathematics classroom discourse in order to investigate students' social transformation in mathematics class. The notion of social transformation is the core of social practice theory. In social practice theory, knowledge such as mathematics is the historical and cultural structuring of social existence in a mathematics community. Learning is a process of legitimate peripheral participation through which a learner renegotiates his/her epistemological standpoint with respect to the cultural organization of a community (Lave & Wenger, 1991; Wenger, 1998).

Although the notion of mathematics as an abstract, disembodied, universal, value-free and transcendental truth has traditionally been the most dominant discourse in shaping teaching and learning mathematics at schools, the newly developing perspective on social practice has influenced theory and practice in mathematics education in a fundamental way. Indeed, recently, the notion of community and practice has become increasingly popular in theoretical discourse of mathematics education and has become the basic unit for analysis of classroom interaction. From this perspective, cultural and social processes are integral to mathematical activity. The mathematics class is considered of as a practice community where participants negotiate their mathematical meanings and ways of doing mathematics to create their own mathematical culture through daily practice of mathematics (Cobb & Bauersfield, 1995; Voigt, Seeger, & Waschescio, 1998).

This research applied socio-cultural perspectives to the analysis of mathematical practice in the classroom in order to investigate the social transformation of students. Social practice theorists argue that the cultural epistemological standpoint historically

¹ This research was supported by Korean Research Foundation Grant (KRF-2002-037-B00053, KRF-2002-041-B00468).

constructed by a mathematics community is mediated through mathematics. As a consequence of the mediation, a learner's epistemological perspective becomes socially transformed. Then, how does social transformation happen? How is the process like? This research seeks to answer these questions by analyzing students' discursive practice in mathematics class.

METAPHOR AS A CULTURAL MODEL

Contemporary cognitive scientist has shown that mathematical cognition is fundamentally metaphorical (Lakoff & Nunez, 2000). It has been shown that human beings are born with innate arithmetic ability such as subitizing. In addition, recent brain research has discovered that some mathematical abilities are associated with certain areas of the brain (Lakoff & Nunez, *ibid*). This represents conceptual metaphor through which the primitive innate mathematical abilities become elaborated into higher level of mathematical abilities. Metaphor as a cross-domain mapping bridges between the source domain of physical sensorimotor experience and the target domain of an abstract concept enables people to reason about an abstract concept following the inferential structure of a source domain of tangible sensorimotor experience (Lakeoff & Nunez, 2000).

Based on the theory of metaphor, Lakoff and Nunez (2000) argue that mathematics as we know it is brain-and-mind-based. That is, mathematics is a product of the function of the brain and of the body, and our experience in the world. Primitive innate mathematical abilities become elaborated into a more sophisticated kind of mathematical knowledge through experience. In the process, it is conceptual metaphor that mediates the experiential world to mathematical knowledge. On one hand,, the existence of innate arithmetic ability explains the universality of mathematical concepts such as numbers. On the other hand, the universal innate arithmetic ability becomes transformed to a culturally specific kind of mathematics by conceptual metaphor through which the culturally specific inferential structure of lived-in experience is transferred to the domain of mathematics. In this regard, mathematical metaphor represents a cultural model of mathematical concepts.

Cultural models are defined as presupposed, taken-for-granted models of the world that are widely shared by the members of a society and that play an enormous role in their understanding of that world and their behavior in it (Quinn & Hollan, 1987). When considering that mathematics is a product of metaphor reflecting a specific cultural structure share in a society, conceptual models of mathematics are cultural models. Cultural knowledge such as mathematics is organized into a culturally structured model that provides a culturally shared basis for seeing, reasoning, and in general, doing. Metaphor plays an important role in the construction of the cultural model since it allows for knowledge to be mapped from known domains of the culturally structured lived-in world onto conceptualizations in the social and psychological abstract domains. For instance, Ju (2001) found that while professional mathematicians creatively applies metaphor in mathematical arguments, the use of metaphor should be legitimized by peer mathematicians. The notions of legitimacy and taken-to-be-shared in the use of metaphor imply that mathematical metaphor is related to the conceptual model culturally shared in a mathematics community.

RESEARCH DESIGN

In this research, language is taken as a unit of analysis under the assumption that “Facets of cultural values and beliefs, social institutions and forms, roles and personalities, history and ecology of a community may have to be examined in their bearing on communicative events and patterns” (Hymes, 1974, p.4). Metaphor is one of the important communicative patterns shared in a mathematics community (Ju, 2001; Lakoff & Nunez, 2000; English, 1997; Pimm, 1987). More importantly, as discussed in the above, metaphor can be seen as a significant indicator in depicting the cultural model of a mathematical concept. Therefore, by investigating the patterns in students’ use of metaphor, especially, how it changes through students’ participation in mathematics practice in class this paper aims to describe how students’ model of a mathematical concept – particularly differential equations in this research – becomes transformed and in what way the transformation is social. For this purpose, the discourse analysis specifically focuses on the following questions: what kind of metaphor did students use in representing their mathematical reasoning? What are the characteristics of the metaphors used? How did the students’ use of metaphor change through the semester?

Data was collected through participatory observation in a differential equations course at a university in Korea through a fall semester in 2002. All class sessions were video recorded and transcribed for later detailed discourse analysis. The instructional design of the differential equation course is based on the philosophy of Realistic Mathematics Education (RME). The core of RME approach is progressive mathematization, that is, mathematizing both everyday-life experience and mathematical subject matter itself (Treffers, 1987). Through progressive mathematization, students do not merely seek solutions for specific tasks, rather they renegotiate their mathematical meaning and a taken-as-shared mathematical reality emerges gradually. For progressive mathematization, context problems are essential. They provide grounds for students to develop context-specific solutions through horizontal mathematization. This turns into the object of mathematical analysis in the following stage of vertical mathematization to emerge into a taken-to-be-shared reality (Gravemeijer & Doorman, 1999).

In this research, a set of context problems was developed for the students. This leads to a series of processes of horizontal and vertical mathematization, which became the basis for the mathematical reinvention that the instructor intended. The context problems were constructed to reflect mathematical phenomena experientially realistic to the students. The context problems were also of historical significance. For instance, one of the worksheet problems was concerned with spring-mass motions which historically motivated the invention of differential equations (Kline, 1972). In the class, the students formed small groups of three or four to work on the context problems. While the students worked in a small group setting, the instructor interacted with the students. After the small group discussion, the students joined together for the purpose of a whole class discussion. Several students came to the front to share their results and the instructor facilitated the sharing of their mathematical ideas.

FINDINGS

Kinds of Metaphor Used and Characteristics

Mathematically, solutions of different equations have dual aspects. On one hand, they are treated as objects: something satisfying a given equation. On the other hand, differential equation solutions are functions representing phenomena changing with respect to the independent variables assigned. These dual aspects of differential equation solutions reflected in the students' use of metaphor, can be largely categorized into two types: machine metaphor and fictive motion metaphor.

“A Function Is A Machine” is one of the grounding metaphors for functions (Lakoff & Nunez, 1997). In the machine metaphor, functions are regarded as machine processing inputs to produce outputs. The notion of algorithm is based on the machine metaphor in the sense that an algorithm as a metaphorical machine operates on input to yield output. Followings are examples from the class:

Since the time interval decreased to 0.5..I mean as Δt decreased to $1/2$, the coefficient of the rate of the change decrease ..so we made it $0.1P$. Then what we computed last time was P ..uh PO begins with $3P$.. $P1$ is 3 .. $P1$ is 1 there but 1 ..because (it) means 0.5 , $3+_$ we add there what we put 3 into P (in the equation). As a result, 0.342 came out. We add it to get 3.342 .

In this example, the students worked on a context problem concerning prediction of population. In the previous session, the students predicted an animal population for each year with a given differential equation $dP/dt = 0.3P(1-P/12.5)$. In this session, the problem required that students predict the animal population for every six months. In the above transcript, the student presented her solution of how to make a prediction from the differential equation. In her explanation, she treated the given differential equation as a machine. With the changed time interval, she changed the coefficient as if modifying the machine to fix a new purpose. Then she entered a number to operate the machine and a number sprung out of it.

With the machine metaphor, the students regarded differential equations as a device for calculation, so they needed to enter a number to acquire a numeral value. As a result, their approaches were quantitative and their reasoning focused on the product of change identified by differential equations. Due to the focus on the product, motion mmetaphor did not highlight the process of change, in particular the rate of change in the differential equation. Also, since they had to input definite numbers into differential equations, their approaches were discrete. In the above example, the student constructed the approximate solution graph of a differential equation by computing values at discrete points.

“Fictive motion metaphor” is another dominant kind of metaphor that the students used, in which the solution of a differential equation is represented as a trajectory of a moving point. In general, the fictive motion metaphor, variables are travelers moving along axes and the function relating the variables is conceptualized as a traveler moving across the plan or space. The following examples of the fictive motion metaphor from the class:

Whatever P is, if it becomes 12.5 , it keeps going just this this

When P is smaller than 12.5 , the rate of change is positive so it keep increasing. Then as it gets closer to 12.5 , uh to the continuously changing increment..uh..if it becomes 12.5 , it does not increase anymore.

In these examples, the students were dealing with the same population problem discussed in the above. However, the students approached the context in a different way. In the

analysis, the students thought of a solution in terms of trajectory of a point continuously moving along. As a result, the students viewed problems situations as continuously changing. For instance, when the student used the verb “become” instead of “be” in the first example to represent a continuous change. Because the fictive motion metaphor represents a solution as a trajectory of a moving point, the students focused on the entire patterns of a solution curve. So the students qualitatively reasoned about differential equations based on the holistic pattern of solutions instead of precise values.

SOCIAL TRANSFORMATION IN THE USE OF METAPHOR

So far, kinds of metaphor used and their characteristics have been identified. Now, what is the pattern in the students’ use of metaphor in the class? In what spect is the pattern social? In other words, does the pattern indicate the path of the students’ transformation with respect to the cultural organization of communal practice of mathematics? In this regard, one of the salient patterns in the use of metaphor is concerned with the switch between the two types of metaphor. Generally, there was an observed tendency for students to rely more often on fictive motion metaphor than one machine metaphor through out the semester.

In the beginning of the semester, the students were more likely to interpret their mathematical tasks as algorithmic and discrete and as a result, they applied the machine metaphor more often. This is partly due to the nature of mathematical tasks. For instance, in the beginning of the semester, the course provided context problems to lead the students to reinvent Euler’s method. In this way, discrete and algorithmic approaches were intended by the course designer. However, the tendency was also the product of the students’ own conception of “what is mathematics?” In the beginning of the semester, the students often expressed the view that law-like-principles or algorithms were the only “real mathematics”. This kind of mathematical belief is the product of their previous mathematical practice such as grade-making in mathematics class. However, machine metaphor rarely matched a given mathematical situation of change, as it was not efficient in revealing the changing aspects of the phenomenon under inquiry. Through meaning negotiation, the students realized the weakness of the machine metaphor and switched to the fictive motion metaphor, which is more appropriate to highlight the continuity of a changing situation. In this section of the paper, a sequence of examples will be presented to illustrate the way that the students proceeded from the machine metaphor to the fictive motion metaphor. The examples are taken from a session in which the students investigate a context of population growth to decide which change in the population is determined, the initial population or time.

The students began their discussion with the machine metaphor, as illustrated here:

Student A: Before..in high school we learned Fibonacci sequence. Like there are two rabbits and they reproduce once a year and the babies reproduce in a year..I thought that this (problem) is similar to that.... When I thought about this problem in terms of Fibonacci sequence, we have to multiply by the number of fish to get this number so the equation is concerned with P. When we make a Fibonacci sequence, the degree is t. So t seems to be involved too.

This student A began her discussion with a discrete model of population growth. She applied the notion of sequence to the situation and thought only about the population at each generation without taking account for the process of population growth between

generations. She tried to explain how to obtain population at a certain moment. Thus, she developed an algorithmic expression to determine which variables were involved with population change.

However, the algorithmic discrete model was not quite persuasive and another student B disputed:

Student B: I still believe that only P is involved with the population growth. In the beginning, I thought that time might be involved..(drawing a graph)..For instance, starting from an initial value it seemed to be related to time, if it starts from here, then it will merge from this point. So the population can be expressed in terms of only P regardless time.

Student A: But then...the parents and the babies reproduce together.

Other students: Should they reproduce just once?

In this argumentation, Student B introduced fictive motion metaphor by representing the population growth as a process changing along a curve. With the metaphor, she highlighted the continuity in the population growth. As a result, she could see the context as an integrated whole and the insight enabled her to make a more meaningful claim.

Following Student B's dispute, Student A replied by trying to perpetuate her discrete model based on the machine metaphor. In listening to their argument, several students began to question the appropriateness of the model presented by Student B. through further meaning negotiation, the class ended with more elaborated argumentation based on fictive motion metaphor. In particular, after the discussion, the class introduced software producing slope fields of differential equations. The technology visualizes slope fields in a very dynamic way, which enables the students to manipulate slope marks and see the continuity of the change. Through the experience, the students came to appreciate the appropriateness of fictive motion metaphor as language to represent contexts concerning differential equations. Moreover, their use of fictive motion metaphor became more sophisticated.

Student C: In the cases that the number of fish is 3 and 5, respectively, if we look at the relation on the graphs, the slope was steeper when an initial value is larger..since they reproduce to the same degree..so if you put the cursor here, the curve is identical to that curve starting from here. Like this if it start from 2, doesn't it become 3 at a certain moment? Right? Because the same species reproduces to the same degree.

In the above example, Student C represented the population growth as a curve made by a traveling point (e.g., "starting from here", "doesn't it becomes 3"). By saying "to the same degree", she emphasized the notion of rate of change in differential equations. Also, she explains the change in the slope in terms of the change in the steepness of the travel route. These aspects of fictive motion metaphor extends it from an ordinary metaphor for function to a metaphor specifically representing differential equations and revealing the notion of "rate of change" in these equations.

The above examples were taken from a session in the early stage of the semester and the emergence of the fictive motion metaphor out of the machine metaphor had taken through out an entire session. However, students applied fictive motion metaphor increasingly and more efficiently throughout the semester. At the end of the semester, it was observed that students promptly switched between the two metaphors depending on their appropriateness for a given mathematical task. This implies that the machine metaphor is not redundant. Rather, the machine metaphor provided an intermediary stage

for the students to transgress to the model of differential equations based on fictive motion metaphor.

The change in use and efficiency is interpreted as evidence that students' conceptual model become transformed according to the historical and cultural organization of practice in the mathematics community. In this regard, the transformation is social. It is social transformation in the sense that it reflects the instructional design of the course as communal practice. For instance, in the first session, the professor contrasted two notions of differential equations: its algorithmic aspect and its meaning as language for describing changing contexts. However, the instructional design does not merely reflect the instructional designer's private belief. It is related to the historical and cultural meaning of differential equations grasped by him/her at a fundamental level. The subject of differential equations was historically invented as a language describing motion, that is, continuously changing situations such as the two-body problem in astronomy, spring-mass, and elasticity (Kline, 1972). In this aspect, fictive motion metaphor is the historically and culturally legitimate model of differential equations shared within the mathematics community. This suggests that change in the use of metaphor indicates a renegotiation of the students' conceptual model with respect to historical and cultural organization of the mathematics community.

CONCLUSION

The purpose of this research was to describe the social transformation of students in a differential equations course based on the analysis of mathematical metaphor that students used in class. The analysis shows that machine metaphor and fictive motion metaphor were the most dominant kinds of metaphor used by the students. Through meaning negotiation, the students realized their weakness and strength as a language for differential equations. Throughout the semester, the students gradually came to apply fictive motion metaphor more frequently and efficiently. This tendency in the use of metaphor is interpreted as indicating the social transformation of students' conceptual models of differential equations in the sense that the students came to grasp the cultural legitimacy of fictive motion metaphor.

Although metaphor used in the class were classified into two types, each participants used metaphor creatively based on one's own understanding of the problem context. As a result, diverse perspectives evolved and through meaning negotiation, they emerged to form shared mathematical meaning in the class. As a consequence, the participants develop their own culture of mathematics in the class. In this regard, the mathematics class can be seen as a community of practice. It has its own unique culture which is distinct from the culture of the larger mathematics community but not entirely.

This suggests that the meaning negotiation in mathematics class is not an arbitrary process but firmly grounded to the history and culture of a larger mathematics community. Through participating in the practice of mathematics mediating a historical and cultural structure of a mathematics community, a learner becomes transformed to a certain kind of a cultural being with historicity. Then, what creates a link between the two communities? Although the culture of a mathematics class is the product of co-engagement among the participants, it is important to note that a mathematics teacher plays a critical role in the process. Even though the professor did not instruct in the class, she insinuated her mathematical perspective by her use of metaphor and in terms of her

instructional design. For instance, context problems played an important role in the class in the sense that they affected the students' choice of metaphor. Also, it was observed that technology contributed to the formation of cultural models of differential equations in the class by affecting the process of metaphorical switch. However, it is fundamentally a mathematics teacher who selects context problems and technologies in order to infuse one's own mathematical perspective of legitimate practice of mathematics. In this regard, there is asymmetry in the relation between a teacher and a student in terms of whose notion of mathematics is to be legitimized. However, a teacher's intervention is critical when it lays the foundation of a future possibility instead of confining students' potentiality.

This description of social transformation in mathematics class ultimately reveals the intricateness of learning mathematics. Learning mathematics is experience of liberation but at the same time of enculturation with respect to a specific history and culture. How do these two poles of experience lead to the creation of a learner as an integrated whole? What is the role of a mathematics teacher in the process of social transformation? What resources does a mathematics teacher rely on to support the process? Further investigation of social transformation will help to provide answers to these questions, based on the historicity and culture of mathematics.

References

- Cobb, P., & Bauersfeld, H. (Eds.). (1995). *The Emergence of Mathematical Meaning: Interaction in Classroom Cultures*. Hillsdale, NJ: Lawrence Erlbaum Associates.
- English, L. (1997). *Mathematical Reasoning: Analogies, Metaphors, and Images*. Mahwah, NJ: Lawrence Erlbaum Association.
- Freudenthal, H. (1973). *Mathematics as an Educational Task*. Dordrecht: D. Reidel.
- Gravemeijer, K., & Doorman, M. (1999). Context Problems in Realistic Mathematics Education: A Calculus Course as an Example. *Educational Studies in Mathematics*, 39, p. 111-129.
- Hymes, D. (1974). Toward ethnographies of communication. In *Foundations in Sociolinguistics: An Ethnographic Approach* (p. 3-28). Philadelphia: University of Pennsylvania Press.
- Ju, M.-K. (2001). *Being Mathematician: An Ethnographic Account of the Cultural Production of a Mathematician at a University*. Unpublished Doctoral Dissertation: University of California, Davis.
- Kline, M. (1972). Ordinary Differential Equations in the Eighteenth Century. In *Mathematical Thought from Ancient of Modern Times* (p. 400-435). New York: Oxford University Press.
- Lakoff, G., & Johnson, M. (1999). *Philosophy in the Flesh: The Embodied Mind and Its Challenge to Western Thought*. New York: Basic Books.
- Lakoff, G., & Nunez, R. (2000). *Where Mathematics Comes From*. New York: Basic Books.
- Lave, J., & Wenger, E. (1991). *Situated Learning: Legitimate Peripheral Participation*. Cambridge, MA: Cambridge University Press.
- Levinson, B., Foley, D.E., & Holland, E.C. (1996). *The Cultural Production of the Educated Person: Critical Ethnographies of Schooling and Local Practice*. Albany, NY: State University of New York Press.
- Pimm, D. (1987). *Speaking Mathematically*. New York: Routledge and Kegan.
- Holland, D., & Quinn, N. (Eds.). (1987). *Cultural Models in Language & Thought*. New York, NY: Cambridge University Press.
- Treffers, A. (1991). Didactical Background of a Mathematics Program for Primary Education. In L. Streefland (Ed.), *Realistic Mathematics Education in Primary School* (p. 21-57). Utrecht: CD-B Press.
- Voigt, J., Seeger, F., & Waschescio, U. (Eds.). (1998). *Culture of Mathematics Classroom*. New York: Cambridge University Press.
- Wenger, E. (1998). *Communities of Practice: Learning, Meaning, and identity*. New York: Cambridge University Press.

13 YEAR-OLDS' MEANINGS AROUND INTRINSIC CURVES WITH A MEDIUM FOR SYMBOLIC EXPRESSION AND DYNAMIC MANIPULATION.

Chronis Kynigos and Georgos Psycharis

University of Athens, School of Philosophy and Computer Technology Institute.

We explore how 13 year-olds construct meanings around the notion of curvature in their classroom while working with software that combines symbolic notation to construct geometrical figures with dynamic manipulation of variable. The ideas of curve as intrinsic dynamic construction, and curve as object with properties related to its positioning on the plane were some of those developed. The use of symbolic and graphical notation in conjunction with the dynamic manipulation played an important part in the generation of these ideas, which was interwoven with the activity and the use of the tools.

THEORETICAL FRAMEWORK

In this paper we report research aiming to explore how 13 year-olds construct meanings around the concept of curvature with 'Turtleworlds', a piece of geometrical construction software which combines symbolic notation through a programming language with dynamic manipulation of variable procedure values (Kynigos et al., 1997). The students worked in small collaborative groups in their classroom during a weekly computer-based project-work session established in their school. They were engaged in a project to build models of bridges by constructing, experimenting with and editing intrinsic arc procedures (Kynigos, 1993) and by manipulating their variable values to observe Cabri-style continual change of the constructed figures.

In our task design and research perspective, we adopted a constructionist approach to learning (Harel and Papert, 1991), focusing particularly on the notion of using both formalism *and* dynamic manipulation to construct mathematical meaning. Along with diSessa, 2000, we argue that symbolic language interfaces in computational expressive media provide rich opportunity for student engagement with *meaningful* formalism. We suggest that formalism is a powerful, inherently mathematical medium for expressing mathematical ideas. It has, however, been placed in the background of attention, given the well-established problem of 'meaning-less' formalism in understanding mathematical ideas (Dubinsky, 2000), coupled with the advent of dynamic manipulation interfaces which provide access to such ideas bypassing formal representation (Laborde and Laborde, 1995). In the results section, we adopt an instrumentalist view of the 'Bridge microworld' with 'Turtleworlds', i.e. we focus on the instrument constructed by the students rather than the artefact designed by the researchers (Marioti, 2002). Turning for a moment at the microworld *artefact*, however, it is important to say that the epistemological validity (Balacheff and Sutherland, 1994) and the pedagogical design of the software and the activity involved an integrated use of both formal mathematical notation and dynamic manipulation of variable values as part of a coherent available

representational register. We were interested to study the ways in which the students interacted with these representations and the ways in which the meanings they constructed structured and were structured by them, in the sense of Noss and Hoyles, 1996. Study on the generation of mathematical meaning with microworlds based on constructions with symbolic notation seems to have been rather fragmented from that involving dynamic manipulation of geometrical figures (Arzarello et al., 1998). It may be that research interest in those two arose in different – almost sequential – times, or that the coherence and potential of properties of each type of corresponding software environment have been so exciting, that joining the two has not received much thought apart from a few exceptions (e.g. Clements and Sarama, 1995, Schwartz, 1997). Healy and Hoyles (1999) state that:

‘the critical difference between programming environments and direct manipulation interfaces revolves around this emphasis in interaction on symbolic control, in the former case, *as opposed* to visual control in the later, p. 236 (our emphasis).

However, we suggest that geometry is a field where mathematical formalism and graphical representation of objects and relations are dynamically joined in interesting ways and that *joint* symbolic and visual control may have important potential for mathematical meaning-making processes. In Turtleworlds, what is manipulated is not the figure itself but the value of the variable of a procedure. Dragging thus affects both the graphics and the symbolic expression through which it has been defined, combining in that sense these two kinds of representations and corresponding epistemological validities.

In order to study the meanings generated during the students’ work with the ‘bridge’ microworld, we found Vergnaud’s (1987) notion of ‘conceptual field’ particularly useful, even though it was originally articulated within a cognitive perspective and focused on mathematical concepts rather than student knowings. Vergnaud argued that it makes no sense to perceive of a mathematical concept on its own. Rather, it is more useful to see it in terms of a set of concepts tightly related to it, a set of situations in which it may be used and a set of available representations. Our interest was thus to keep a wide lens with respect to students’ generation of meaning *around* curvature, in the sense that we were interested in their use of curvature-*related* ideas in their construction of bridges. Although we were interested in the concept of curvature through the epistemological domain and the representational repertoire of this particular piece of software, we were nonetheless prepared to keep an open mind in order to interpret the meanings students generated for themselves while we observed them constructing their bridge models (Balacheff, in press). We were particularly interested in connections made by the students between mathematical situations they were dealing with and the ways in which they used the available formalism and graphical representations to express them.

RESEARCH SETTING AND TASKS

Although curves are often found in many areas of the curriculum (circles, arcs, trigonometry, function graphics etc.), at least in Greece where the study took place, there is not much focus on the nature of curvature as a context for generating mathematical meaning. For instance, the importance of arcs seems to lie on the angular and trigonometric properties within the corresponding circles rather than on the nature of

curve. Function curves are in a sense even more dissociated from curvature investigations in the sense that they are more abstract representations of mathematical relations rather than geometrical figures themselves, even though students have been reported to treat them as such (Ainley et al., 2000).

The activity was part of a wider study involving five schools situated in England, Italy and Greece, each using their own Logo-based software. The task was to engage students in building the model of a bridge¹ and to then bring them into email contact to discuss their construction methods and techniques and to provide information about the specific bridges they modelled. The research reported here involved a primary school in a town called Larissa, where a weekly small group project work session, taught by the students' normal teacher, had been established involving the use of 'Turtleworld' microworlds amongst other exploratory software. At the time of the study, the students had already had experience with traditional Logo constructions including variable procedures. During the 'Bridge' microworld project they were introduced to the dynamic manipulation feature of the software called 'variation tool'. After a variable procedure is defined and executed with a specific value, clicking the mouse on the turtle trace activates the tool, which provides a slider for each variable. Dragging a slider has the effect of the figure dynamically changing as the value of the variable changes sequentially. The graphics, the tool and the Logo editor are all available on the screen at all times. In the corresponding classroom activity, the students were engaged in trying to build the arcs of models of bridges of different sizes and shapes using the following Logo procedure called 'mystery', which was given to them from the beginning.

```
to mystery :a :b :c
  repeat :a [fd :b rt :c]
end
```

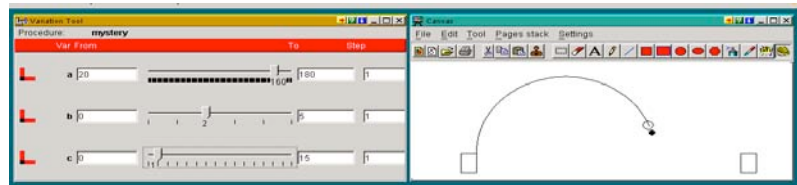

In this procedure the first variable changes the length of the arc, the second its width and the last its curvature. Dragging any of the three sliders corresponding to the respective variable causes an effect resembling continual change of the curve. During the activity, which lasted for 6 hours in total over 3 weeks, we took the role of participant observers and focused on two groups of students, recording their talk and actions and on the classroom as a whole recording the teacher's voice and the classroom activity. Our aim was to gain insight into a) the kinds of mathematical meanings constructed around the notion of curvature and arcs, b) the ways in which meaning generation interacted with the use of the available tools.

METHOD

In our analysis we used a generative stance, i.e. allowing for the data to shape the structure of the results and the clarification of the research issues. We read the data looking for incidents where mathematical meaning was discussed amongst students or where we identified ideas in use. Classroom observations were conducted in all five schools (6 hours in each one) as well as interviews with teachers. Here we use data from one classroom using the variation tool. A team of two researchers participated in each

data collection session. Two video cameras were used, one for each group. A microphone captured all that was said in the groups under study. Background data was also collected (i.e. observational notes, students written works). Verbatim transcriptions of all audio-recordings were made. The researchers occasionally intervened to ask the students to elaborate on their thinking, with no intention of guiding them towards some activity or solution.

RESULTS

Semi-circles as dynamic constructions

In our focus group of three students, the use of the available dragging modality during their exploration oriented the students to play with the idea of discrete versus continuous changes in variable values perceiving continuous curve change as the ‘limit’ of them reducing the dragging step of the slider. They firstly constructed two rectangular bases for their bridge model with a distance of 500 turtle steps between them, as instructed by their teacher. They were to investigate how they could find a method to make a semicircle join the bases together if they wanted to be able to make bridges of varying widths with their model. At first they seemed to move the sliders of the variation tool at random just because the microworld allowed them, making comments stemming from the observation of the visual feedback of the continuing changes in the variables. They engaged in dragging, which gradually moved from this mode (equivalent to that of ‘wandering dragging’, Arzarello et al., 1998) to become more systematic and focused in their attempt to create curvy – like semicircles. In the end they decided that a) in order to have a curvy shape they needed small turn and step measures and b) in order to get a semicircle the values of the iteration and turn variables would have to be constant. They then decided to edit their procedure and substitute variables (:a) and (:c) with constant values of 180 and 1. They executed the new procedure with a step value of 1 and noticed that it fell short from joining up the two bases. While dragging the slider of variable (:b) (the length of step) they observed the differences in the moving semicircle each time. After a while they saw that the appropriate value would be between 4 and 5. In fact, they saw that for (:b)=4 the moving edge of the semicircle fell before the upper left vertex of the rectangle representing the opposite base while for (:b)=5 it went past it. One of the students then suggested the use of decimals for the slider step. They then dragged the variation tool in the scale of 4 to 5 using decimals for the step but the arc still did not link the two bases neatly. Observing these changes one student suggested changing the step again from 0,1 to 0,01.

S2: We need it [the arc] to be further along.

S1: It doesn't fit [i.e. the other side]. Why?

S2: It needs one more step [i.e. a different step] / 0,01.

The way in which pupils ‘see’ the need to extend the shape of the arc is still in the stream of their exploration through dragging. The control of meaning is ascending (Arzarello et al. 1998), i.e. they are manipulating the variation with precise intent and taking control on the continuity of the designed curve. The students’ decision to change the slider step reflects the way in which the computational setting provided a web of structures which pupils could control and exploit at a particular moment, shaping the available resources to

suit their purpose (Noss and Hoyles, 1996). Furthermore, as a result of their dynamic manipulation, they decided to go back to the formal description of the figure and express one of their findings by changing the code from variables to constants even though this was actually not necessary since they could have simply not moved the sliders corresponding to variables (:a) and (:c).

Curves as Geometrical Figures

This episode is about a different group of students who caught our attention when they decided they wanted to make horizontal arcs, which were not so intensely curved as these created by semicircles. Their goal was to create a bridge which looked like one they had found in a book about bridges of Thessalia, the area in which their school was located. The idea that changing the curvature was possible, however, was brought up in the context of their initial dragging to create different curves. They used the mystery procedure with all three variables and they were dragging the sliders trying to discover some rule or invariant property so that they could change the curvature of the arc without losing its fit onto the bases. When they experimented by giving corresponding values to the iterations variable (:c), they realised by observing the screen outcome that the shape seemed to be tilted towards the left and decided to insert a command to turn the turtle towards the right before it began to make the arc. They then edited their mystery procedure to look like this.

```
to arc :a :b :c
  rt :a repeat :c [rt 1 fd :b]
end
```

In this sense, the students inserted a new feature influencing their construction and began to investigate whether there is some underlying property. In contrast to the tendency of the students in the first section to substitute variables with constants, they decided to insert a variable value for the initial turn so that they could investigate by changing it with the use of the variation tool. It is interesting, however, that in effect, they did not change the curvature in their investigation since they substituted the variable turn by a constant value of 1. In that sense, what was changing was the length of the arc of the same circle. They inserted the value of 45 degrees for (:a) and then began to change the others so as to get a ‘differing curvature’ for their arc.

S2: Just a minute. I’ve got an idea. Instead of having 180 degrees here, since we don’t want to draw a semicircle... Yes, let’s have 45 degrees here and 45 here and the rest of it 90, here.

Firstly, they moved the corresponding slider to a value of 45 for variable :a and then the slider for variable (:c) to 90. By dragging the variable (:b) slider, they ‘found’ the value which would give the right size for their arc. The researcher asked them how they knew which values to give for variables (:a) and (:c) and one student’s response was:

S2: It’s all part of the semicircle, i.e. the semicircle has 180 repeats inside it, let’s say at the beginning we turned 45 degrees from the one side and assuming that there would be 45 on the other side, 45 plus 45 we have 90 degrees, and subtracting from 180 of the semicircle we have the part of the semicircle, the half / and we have 90 repeats.

The students seem to have taken into consideration the symmetrical nature of the arc ('assuming that there would be 45 on the other side') and to have built on the previous properties they discovered. The researcher did not rest with this explanation, asking for a more elaborate one where he probed whether the students were able to generalize the description of their 'rule' to other values for variable (:a). He found out that they in fact had already tried other values for (:a) and brought them in as examples to their explanation.

R: If I didn't turn 45 degrees and turned 30, what would have happened?

S2: Yes, 30 plus 30 sixty, 120 times repeat, 120 times. We tried this here. The more we turn at the beginning, the less we repeat. And the step changes.

It is particularly interesting in the above excerpts that the student's descriptions switch from referring to specific sets of values in concrete cases to attempting a more generalized kind of language explaining the interdependence represented by the variables of the construction. In that sense, they refer to the constructed objects from a detached point of view (Marriotti et al., 2000) mentioning qualitative properties of them such as interdependence. This type of generalization is in accordance with Noss and Hoyle's (1996) notion of 'situated abstractions' since mathematical invariants that underpinned student's actions in the course of interaction were rooted in action and articulated – quasi-mathematically – in the operational terms of the available tools. The mathematical idea tapped by pupils through this 'theorem in action' (Vergnaud, 1987) is that of co-variation between two values as a relational property of an evolving object when the value of a variable changes.

CONCLUSIONS

Some interesting meanings around curvature seemed to have emerged in this classroom activity, through the students' engagement with the graphical and symbolic interdependence of Turtleworlds. Amongst these were the idea of continuity, the dynamic nature of mathematical relations, using the curve as starting point in generating arc properties, discovering unexpected properties of arc positioning and engaging in experimental and formal maths in the same activity. It is worth mentioning here that in contrast to the ways curve is presented in school, pupils have attached a variety of meanings to the notion during their exploration with the provided tools. The use of symbolic and graphical notation in conjunction with the dynamic manipulation of the way the figures evolved as variable values changed, played an important part in the generation of these ideas which was interwoven with the activity and the use of the tools. The kinds of understandings supported by such media in varying mathematical activities warrants further research. Hershkowitz and Kieran (2001) wonder if the use of advanced computational tools in algebra signals the beginning of the loss of the algebraic representation from our mathematical classes at a secondary level. It is interesting to reassess which – if any – aspects of this kind of representation of mathematical ideas are important for the generation of mathematical meaning.

Notes

1 NETLogo: the European Educational Interactive Site, European Community, Educational Multimedia Taskforce, Joint Call on educational Multimedia, MM1020, 1998-1999.

References

- Ainley, J., Nardi, E. and Pratt, D. (2000) The construction of meanings for trend in active graphing, *Int. Jnl. of Computers for Mathematical Learning*, 5: 85-114.
- Arzarello, F., Micheletti, C., et al. (1998) *Dragging in Cabri and Modalities of Transition from Conjectures to Proofs in Geometry*, Procs of the 22nd PME Conf., Stellenbosch, South Africa, Vol. 2., 32-39.
- Balacheff, N. (in press) Meaning: a Property of the Learner–Milieu System. Kilpatrick, J., Hoyles, C., Skovsmose, O. *Meaning in mathematics education*. Kluwer.
- Balacheff, N. and Sutherland, R. (1994) Epistemological domain of validity of microworlds: the case of Logo and Cabri-geometre, *Lessons from learning*, Lewis, R. and Mendelsohn, P. (Eds), Elsevier Science B.V. (N. Holland), IFIP, 137-150.
- Clements, D. H. & Sarama, J. (1995) Design of a Logo environment for elementary geometry. *Jnl. of Mathematical Behaviour*, 14, 381-398.
- DiSessa, A. (2000) *Changing Minds: Computers, Learning and Literacy*. MIT Press.
- Dubinsky, E. (2000) Meaning and formalism in mathematics, *Int. Jnl. of Computers for Mathematical Learning*, 5: 211-240.
- Harel, I. and Papert, S. (eds) (1991) *Constructionism: Research Reports and Essays*, Ablex Publishing Corporation, Norwood, New Jersey.
- Healy, L. and Hoyles, C. (1999) Visual and Symbolic Reasoning in Mathematics: Making connections with computers? *M/al Thinking and Learning*, 1, 1, 59-84.
- Hershkowitz, R. & Kieran, C. (2001) *Algorithmic and meaningful ways of joining together representatives within the same mathematical activity: An experience with graphing calculators*, Proceedings of the 25th PME Conference, Utrecht, The Netherlands, 1, 96-107.
- Kynigos C. (1993) Children's Inductive Thinking During Intrinsic and Euclidean Geometrical Activities in a Computer Programming Environment, *Educational Studies in Mathematics*, 24, 177-197.
- Kynigos, C., Koutlis, M., Hadzilacos, T. (1997) Mathematics with Component Oriented Exploratory Software, *Int. Jnl. of Comps for M/al Learning* 2, 229-250.
- Laborde, C. and Laborde, J-M. (1995). What about a learning environment where Euclidean concepts are manipulated with a mouse? In A. diSessa, C. Hoyles and R. Noss with L. Edwards (Eds), *Computers for Exploratory Learning* (pp. 241–261). Springer-Verlag.
- Mariotti, M. A. (2002) Influence of Technology Advances on Students' Math Learning. In L. English (Ed), *Handbook of International Research in Mathematics Education*, Mahwah, Lawrence Erlbaum.
- Mariotti, M. A. (2000) Introduction to proof: The mediation of a dynamic software environment, *Educational Studies in Mathematics* 44: 25-53.
- Noss, R. & Hoyles, C. (1996) *Windows on Mathematical Meanings*, Kluwer.
- Schwarz, B. B. (1997) Understanding symbols with intermediate abstractions: An analysis of the collaborative construction of mathematical meaning, in C. Pontecorvo, R. Saljo and L. B. Resnick (eds.) *Tools, Discourse and Reasoning*, Springer Verlag, Berlin, pp. 312-335.

Vergnaud, G. (1987) *About constructivism*, Proceedings of the 11th PME Conference, Dordrecht, 43-54, Montreal.

THE PROBABILISTIC THINKING OF PRIMARY SCHOOL PUPILS IN CYPRUS: THE CASE OF TREE DIAGRAMS

Iasonas Lamprianou & Thekla Afantiti Lamprianou

University of Manchester

In this research work we explored the nature of 9-12 year old pupils' responses to probabilistic problems with tree diagrams. It was found that a large percentage of pupils failed to respond correctly even to very simple problems that demanded the identification of 'possible routes/paths' in figures with tree diagrams/mazes. The results also revealed the existence of subjective elements and other errors in pupils' thinking. The data were generated in year 2000 when the new mathematics books were introduced extensively in the primary schools. Comparisons are done by age and gender. The results of the study form a general overview and build the basis for further and more focused research because the relevant literature, especially regarding Cyprus, is very sparse.

INTRODUCTION

The probabilistic thinking of primary school pupils has been the center of much research during the last decades. One could claim that Piaget and Inhelder (1975) initiated a vast amount of research into pupils' capacity to compare two probabilities. Other researchers followed and studied pupils' probabilistic thinking (Green, 1983; Fischbein & Gazit, 1984; Kapadia & Borovnik, 1991; Canizares, Batareno, Serrano & Ortiz, 1997).

The identification of errors and misconceptions of pupils are of paramount importance in order for the teachers to maximize their teaching effectiveness. To this end, much of the recent research has focused on specific probabilistic errors and misconceptions (Afantiti Lamprianou & Williams, 2002; Alatorre, 2002; Lamprianou & Afantiti Lamprianou, 2002; Kafoussi, 2003; Lamprianou & Afantiti Lamprianou, 2003).

Not all the areas have, however, been researched adequately. One of the relatively under-researched areas, especially in the context of the primary schools in Cyprus, is the way the pupils think and respond when confronted with questions that demand interpretation of tree diagrams (e.g. find possible routes in a maze) and multiplication of probabilities.

Green (1987) described a situation where pupils were confronted with such a question, which asked them to follow a robot's path through junctions of a maze and decide at which exit the robot was most likely to end up. Green mentioned that the question had been designed to be difficult for the younger pupils but easier for the older pupils who had met tree diagrams and multiplication of probabilities before. Green said

However, the results of large scale testing showed that the item was extremely difficult for *all* [italics his] pupils ... Interviews conducted with individual pupils indicated that although they [the pupils] had studied tree diagrams they could not see the relevance of that work to the problem posed. (p.157.)

Ojeda (1999) also used similar questions. In an experiment, marbles were allowed to roll free through a maze with several exits. Pupils were asked to identify the exit from which most of the marbles would come out. Others were asked to identify the proportion of marbles that would come out of each of the exits. Ojeda found that many pupils failed to understand how the maze worked and failed to understand issues of equiprobability e.g. at a junction, a ball has 50% chance of going right or left.

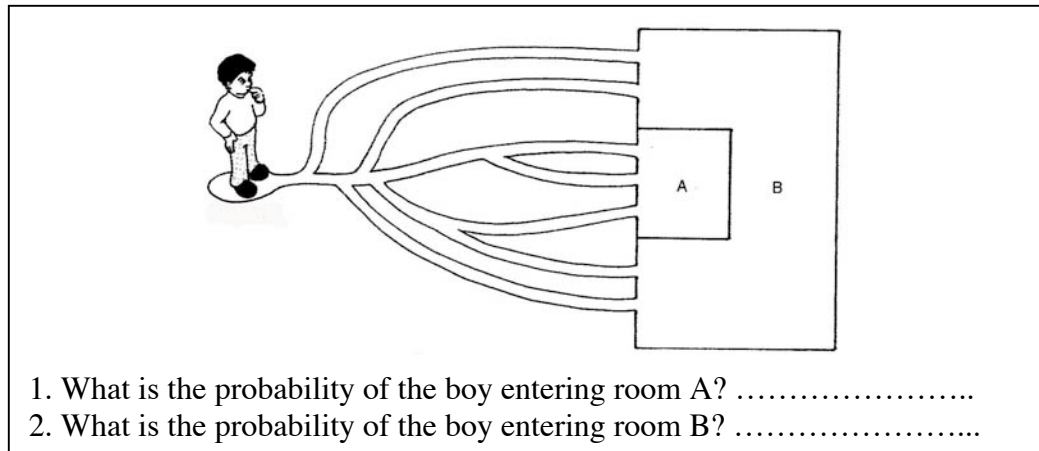

Figure 1: A sample of the ‘tree diagram’ questions of the ‘new’ mathematics books

Questions very similar to the one mentioned by Green are included in the recently introduced 5th Grade mathematics books for Cyprus primary schools (see Figure 1). The 5th Grade pupils of this study had therefore met this type of questions before. The 6th Grade pupils had never been confronted with this type of question, however, since such questions did not appear in their books (at the time of the study they had not yet received the new version of the mathematics books). The 4th Grade pupils are also assumed to be largely unfamiliar with these types of questions because such questions do not appear in the revised 4th Grade books.

However, no published research exists that investigates the way the pupils in Cyprus think when attempting such probability questions with tree diagrams. The relevant literature at the international level is also relatively sparse. This research is important because it investigates an under-researched topic in the context of the primary education in Cyprus. This topic is also relatively under-researched at the international level as well.

AIMS

This study explores the probabilistic thinking of primary school pupils in Cyprus aged between 9-12 years old when attempting questions involving tree diagrams. It also aims to study the effect of grade, age and gender on pupils’ thinking. In addition, the research studies the extent to which subjective elements affect the pupils’ thinking.

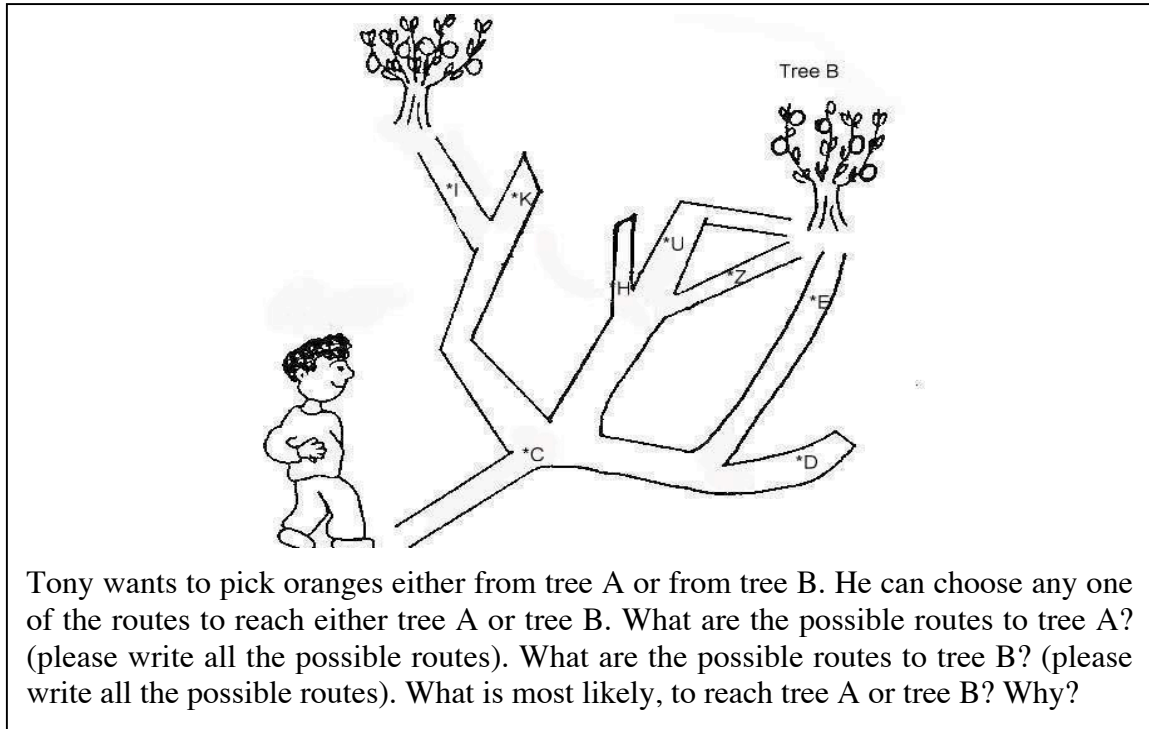

Figure 2: Example of a question of the test

METHOD AND INSTRUMENT

The research instrument (a test) was developed through a series of pilot steps. The final version of the test consisted of five questions. A sample of the questions is given in Figure 2. The question in Figure 1 also appeared in the test with very slight changes.

As is indicated in Figure 2, each question consisted of several other questions (except from question 1 which had no sub-questions). Overall, the questions may be classified into the four groups displayed in Table 1.

	Type of Questions	N of Questions
1	Indicate the possible routes (e.g. What are the possible routes?)	8
2	Indicate the most likely outcome (e.g. What is most likely, to reach tree A or tree B?)	4
3	Indicate the probability (e.g. What is the likelihood to reach tree A?)	4
4	Explanation (e.g. Why?)	1
	<i>Total number of questions</i>	<i>17</i>

Table 1: A classification of the test questions

This table indicates that the test may be divided into three major scales which test (a) the ability of the pupils to 'read' and interpret tree diagrams and find possible routes (questions of category 1); (b) the ability of the pupils to indicate the most likely between two possible outcomes taking into account the possible routes for each one (category 2); and (c) the ability of the pupils to compute the probability of events to happen (category

3). Finally, an 'Explain Why' question forms a fourth category but cannot really be named as 'scale' as it consists of only one question. Each correct response is awarded a mark. Therefore, the number of questions in each scale/group also represents the number of maximum available marks.

In the analysis, the performance of the pupils in the four groups of questions, hence scales, will be considered separately because each of the scales measures a different skill. It is also meaningful to investigate the relationship of the demographic variables of the pupils with their performance on each of the scales mentioned in Table 1.

THE SAMPLE

The final instrument was administered to 776 pupils in four different randomly selected district schools in Cyprus. Approximately 50% of the sample were boys (N=391), one pupil did not specify his/her gender and the rest were girls (N=384). The sample consisted of 264 pupils in Year 4 (34%), 242 pupils in Year 5 (31.2%) and 270 pupils in Year 6 (34.8%).

THE RESULTS

The results of the research will be presented in two sections. First, the results will be discussed briefly, without any reference to demographic variables (e.g. gender, grade or age). Then, a more elaborate analysis will follow with reference to the demographic variables of the pupils.

Overview of the results

Questions of the first scale (What are the possible routes?):

A large number of pupils failed to identify the possible routes in the tree diagrams of the questions. For example, considering the question in Figure 2, only 70% of the pupils were able to identify the possible routes to tree B (i.e. the routes $C \rightarrow U$, $C \rightarrow Z$ and $C \rightarrow E$). On the other hand, only 55% of the pupils managed to identify the route to tree A. In general, the percentages of the correct responses to the eight questions of the first scale 'ranged from 49% to 84%. Across the eight questions of the scale, the average score was only 5.2 with a standard deviation of 2.1 marks.

Questions of the second scale (What is the most likely outcome?):

The success rate of the pupils on this scale was comparable to their success rate on the first scale. For example, 68% of the pupils indicated correctly that reaching tree B (in the question of Figure 2) was more likely than reaching tree A. A percentage of 61% managed to indicate correctly that, in the question in Figure 1, the boy was more likely to enter room B rather than room A. On average, the pupils answered 2.6 of the 4 questions correctly.

Questions of the third scale (What is the probability of an event?):

A very small number of pupils managed to correctly identify the probability that events would happen. For example, on the question in Figure 1 only 2 pupils succeeded in computing the probability of the boy entering room A and only 5 pupils succeeded in computing the probability of the boy entering room B. However, 68% of the pupils answered correctly that the boy was more likely to enter room B rather than room A. Similarly surprising results were also found in other questions: the pupils could not

correctly compute the probability that events would happen but they gave correct responses to the ‘What is the most likely outcome’ questions.

A closer inspection of the responses of the pupils revealed that they used a simplistic approach to the questions of this scale, which coincidentally allowed them to give a correct response. For example, in the question of the Figure 1, four routes end in room B and three routes end in room A. This helped 314 pupils to answer that the probability of the boy entering room A was $3/7$ and the probability entering room B was $4/7$, therefore the boy was more likely to enter the room B rather than room A. Similar results were found for other questions.

The ‘Explain Why’ question:

Only one question of this type was included in the test. This was the last question of Figure 2. The pupils were allowed to express their responses in an open way. Their responses were aggregated into groups and are presented in Table 2.

Category of response	N	%
There are more routes leading to tree B	472	60.8
The route [a specific route] is straight/shorter	125	16.1
Tree A has more fruits than tree B	6	0.8
It is easier to follow a single route [to tree A]	6	0.8
Other answers	63	8.1
No answer given	104	13.4
<i>Total</i>	<i>776</i>	<i>100.0</i>

Table 2: A categorization of the responses to the ‘Explain Why’ question of Figure 2

According to the table, 61% of the pupils explained that they decided upon the most likely event using a probabilistic mode of reasoning (‘There are more routes leading to tree B’). A small percentage of the pupils (13.4%) did not give any answer. A rather low 8% of the sample gave explanations that could not be categorized easily (‘Other answers’ category). The rest (17.7%) of the sample explained that they decided upon the most likely event based on subjective elements like the length of the routes, the number of fruit on the tree etc.

The role of grade, age and gender

Questions of the first scale (What are the possible routes?):

No statistically significant difference was found between the performance of boys and girls on this scale (mean_{boys}= 5.13; mean_{girls}= 5.30; t=1.129; p=0.259). However, a statistically significant difference was found between the pupils of different grades (mean of 4th Grade=4.59; mean of 5th Grade=5.72; mean of 6th Grade= 5.39; F=20.103; p<0.001). More specifically, the 5th and 6th Grade has statistically significantly higher performance than the 4th Grade. The 6th Grade has lower performance than the 5th Grade but the difference is not statistically significant.

The Pearson correlation between the age (measured in months) and the performance on the first scale was not found to be statistically significant (N=729, r=0.04, p=0.350). When, however, the correlation between the age and the performance was computed for each grade individually, small but statistically significant and negative correlations

appeared for the 4th and 6th Grade (4th Grade: N=238, $r=-0.183$, $p=0.005$; 5th Grade: N=225, $r=-0.127$, $p=0.057$; 6th Grade: N=266, $r=-0.184$, $p=0.003$). The correlation for the 5th Grade was small and negative but marginally non-significant.

Questions of the second scale (What is the most likely outcome?):

No statistically significant difference was found between the performance of boys and girls on this scale ($\text{mean}_{\text{boys}}=2.56$; $\text{mean}_{\text{girls}}=2.55$; $t=0.075$; $p=0.940$). However, a statistically significant difference was found between the pupils of different grades ($\text{mean 4}^{\text{th}} \text{Grade}=2.04$; $\text{mean 5}^{\text{th}} \text{Grade}=2.89$; $\text{mean 6}^{\text{th}} \text{Grade}=2.77$; $F=30.258$; $p<0.001$). More specifically, the 5th and 6th Grade had, statistically, significantly higher performance than the 4th Grade. The 6th Grade had lower performance than the 5th Grade but the difference was not statistically significant.

The Pearson correlation between the age and the performance on the second scale was statistically significant and positive (N=729, $r=0.14$, $p<0.001$). When, however, the correlation between the age and the performance was computed for each individual grade, small, statistically insignificant and negative correlations appeared for all Grades (4th Grade: N=238, $r=-0.112$, $p=0.086$; 5th Grade: N=225, $r=-0.107$, $p=0.109$; 6th Grade: N=266, $r=-0.107$, $p=0.083$).

Questions of the third scale (What is the probability of an event?):

The performance of the pupils was so poor (fewer than 5 pupils answered correctly in each case) that no further investigation by gender or age was meaningful. The percentage of correct responses was usually between 0% and 1%.

Alternatively, it was attempted to identify the pupils who employed the more simplistic approach described in the section ‘Overview of the results’. One mark was awarded to the pupils whenever they employed the simplistic approach to answer a question. The result was a score which measured the extent to which the pupils used the simplistic approach to respond to the questions of this scale. A larger score meant that the pupils used this technique more. The average score was 1.44 indicating that the ‘average’ pupil responded to one and half questions (out of four) using the simplistic approach.

No statistically significant difference was found between the performance of boys and girls on this scale ($\text{mean}_{\text{boys}}=1.51$; $\text{mean}_{\text{girls}}=1.37$; $t=1.243$; $p=0.214$). However, a statistically significant difference was found between the pupils of different grades ($\text{mean 4}^{\text{th}} \text{Grade}=0.66$; $\text{mean 5}^{\text{th}} \text{Grade}=1.92$; $\text{mean 6}^{\text{th}} \text{Grade}=1.76$; $F=54.53$; $p<0.001$). More specifically, the 5th and 6th Grade had statistically significantly higher performance than the 4th Grade. The 6th Grade had lower performance than the 5th Grade but the difference was not statistically significant.

The Pearson correlation between the age and the performance on the third scale (using the simplistic approach) was statistically significant and positive (N=729, $r=0.242$, $p<0.001$). When, however, the correlation between the age and the performance was computed for each grade individually no statistically significant results were found.

The ‘Explain Why’ question:

Table 3 indicates that there was a significant tendency of the 4th Grade pupils to give more subjective and fewer probabilistic responses. On the contrary, the 5th and 6th Grade pupils gave significantly fewer subjective but significantly more probabilistic responses.

Grade	Various responses	There are more routes leading to tree B	Subjective responses (e.g. the number of fruit)	No response given
4 th Grade	11%	44.3%	30.7%	14%
5 th Grade	5.8%	71.1%	9.1%	14%
6 th Grade	7.4%	67.8%	12.6%	12.2%

Table 3: A classification of the ‘Explain Why’ responses by Grade
 Within the Grades, however, no difference to the average age of the pupils who gave each of the responses was recorded.

DISCUSSION AND CONCLUSION

It was found that even the pupils who had met tree diagrams and multiplication of probabilities in the past could not see their relevance to the questions of the test. This agrees with previous research (Green, 1987). In this study, many pupils employed a rather simplistic technique to answer the questions. They counted the number of all possible routes to any destination to formulate a sample space; they counted the number of favorable events (the possible routes to the target); they computed the probability to reach a destination by dividing the favorable events by the sample space size. Although this technique was, in principal, incorrect, for the pupils it was a very reasonable solution.

Another one of the significant findings of the research was that one in six pupils’ probabilistic thinking was governed by subjective elements. Those pupils decided upon the most likely event by taking into consideration factors like the length of the route or even the number of fruit on the trees in the figure! Approximately 30% of the 4th Grade pupils (who did not have much exposure to these kind of questions) explained their response in the question in Figure 2 using subjective elements. The percentage for the 5th Grade pupils was only 9%, but again, this group had these types of questions in their mathematics books. Finally, only 12% of the 6th Grade pupils responded in a subjective way although they had never encountered this type of question before. All in all, it seems that teaching and age can significantly improve pupils’ probabilistic thinking.

Gender did not seem to have much effect on the responses of the pupils. Age correlated significantly with the score of the pupils on the scales. It was striking that age, within the grades, correlated significantly but negatively with the ability of the pupils to identify the possible routes of the tree diagrams. No obvious explanation for this seems to exist.

This study investigated the interaction of primary school pupils with questions that demanded interpretation of tree diagrams and multiplication of probabilities. Overall, the results agree with previous research (Green, 1987; Ojeda, 1999). Still much remains to be researched, especially in the context of primary education in Cyprus. It is important to further investigate the failure of the pupils to realize the relevance of the tree diagrams and of the multiplication of probabilities when answering the questions in the test. It is also important to investigate the conditions under which some pupils’ thinking is affected by subjective elements. Finally, it is important to study whether the probabilistic thinking of the same pupils is influenced by subjective elements when confronted with probability questions of a different nature e.g. when picking coloured marbles randomly from a bag. Semi-structured interviews with pupils are planned as a next step.

References:

- Afantiti Lamprinou, T. & Williams, J. A developmental scale for assessing probabilistic thinking and the tendency to use a representativeness heuristic. In A.D. Cockburn & E. Nardi (Eds.). Proceedings of the 26th Conference of the International Group for the Psychology of Mathematics Education (PME). (v.3, 273-280). Norwich: UEA. (2002)
- Alatorre, S. A framework for the study of intuitive answers to ratio-comparison (probability) tasks. In A.D. Cockburn & E. Nardi (Eds.). Proceedings of the 26th Conference of the International Group for the Psychology of Mathematics Education (PME). (v.3, 273-280). Norwich: UEA. (2002)
- Canizares, M.J., Batarena, C., Serrano, L. & Ortiz, J.J. (1997). Subjective elements in children's comparison of probabilities. In E. Pehkonen (Ed.). Proceedings of the 21th Conference of the International Group for the Psychology of Mathematics Education (PME). University of Helsinki.
- Fischbein, E., & Gazit, A. (1984). Does the teaching of probability improve probabilistic intuitions? *Educational Studies in Mathematics*, 15, 1-24.
- Green, D. R. (1987). Encouraging probabilistic thinking. *Journal of Computer Assisted Learning*, 3, 156-163.
- Green, D.R. (1983). A survey of probability concepts in 3000 pupils aged 11-16 years. In D.R. Grey, P. Holmes, V. Barnett & G.M. Constable (Eds.). Proceedings of the First International Conference on Teaching Statistics (v.2, 766-783). University of Sheffield.
- Kafoussi, S. (2003). Discussing about the concepts of probability in a kindergarden classroom. In A. Gagatsis & S. Papastavridis (Eds.). Proceedings of the 3rdth Mediterranean Conference on Mathematics Education (MCME). (459-466). Athens: Hellenic Mathematical Society and Cyprus Mathematical Society.
- Kapadia, R., & Borovnik, M. (Eds.) (1991). *Chance Encounters: Probability in Education*. Dordrecht: Klauer.
- Lamprinou, I. & Afantiti Lamprinou, T. The nature of pupils' probabilistic thinking in primary schools in Cyprus. In A.D. Cockburn & E. Nardi (Eds.). Proceedings of the 26th Conference of the International Group for the Psychology of Mathematics Education (PME). (v.3, 273-280). Norwich: UEA. (2002)
- Lamprinou, I., & Afantiti Lamprinou, T. (2003). Pupils' probabilistic thinking in primary schools in Cyprus: common errors and misconceptions. In A. Gagatsis & S. Papastavridis (Eds.). Proceedings of the 3rdth Mediterranean Conference on Mathematics Education (MCME). (449-458). Athens: Hellenic Mathematical Society and Cyprus Mathematical Society.
- Ojeda, S. A. (1999). The research of ideas of probability in the elementary level of education. In O. Zaslavsky (Ed.). Proceedings of the 23rd Conference of the International Group for the Psychology of Mathematics Education (PME). Haifa: Israel Institute of Technology.
- Piaget, J., & Inhelder, B. (1975). *The origin of the idea of chance in children*. London: Routledge & Kegan Paul.

PRE-SERVICE TEACHERS' TRANSITION FROM "KNOWING THAT" TO "KNOWING WHY" VIA COMPUTERIZED PROJECT-BASED-LEARNING

Ilana Lavy & Atara Shriki

Emek Yezreel College, Oranim Academic College of Education

The aim of the study was to examine the effects of implementing computerized project-based-learning (CPBL) approach into a didactical course for third year pre-service mathematics teachers. In this paper we focus on impacts concerning the pre-service teachers as learners. Analysis of the data revealed three main sub-categories relating to aspects concerning the pre-service teachers as learners: the development of self-confidence in mathematical competence; the contribution of the computerized environment; and the impacts of the classroom discussions. We give evidence to the students' transition from "knowing that" to "knowing why" the CPBL approach is a promising learning/teaching method for turning the mathematics experience into an exciting and challenging one.

INTRODUCTION

Calls for reforms in mathematics education (e.g. NCTM's standards, 2000) emphasize the importance and the advantages of teaching through problem-based-learning. Our experience shows that although in-service teachers are exposed to innovative teaching methods, they tend to avoid employing them in their classrooms. Informal interviews with teachers revealed that the main reason for this phenomenon is that although they are familiar with new methods, they do not have the required confidence for incorporating them into their teaching framework. Moreover, the teaching and learning processes that are involved seem to them rather vague. We believe that in order for teachers to become aware of the various processes associated with methods such as problem-based-learning, they should experience it themselves for a long period of time. We assume that such an experience would help teachers assimilate it into their pedagogical content knowledge (PCK) and consequently will be motivated to try this method in their classes.

BACKGROUND

Many researches agree that PCK is an essential component of teachers' knowledge (e.g. Even & Tirosh, 1995). PCK consists of knowledge about the subject matter and knowledge about students. The latter refers to decisions concerning teaching methods and strategies.

Obviously it is impossible to reach an agreement regarding what should be the constituents of PCK and what are the appropriate approaches that should be taken in order to convey them. It is clear that each teacher/educator chooses his/her approaches in accordance to former experience. We believe that experiencing new teaching methods such as project-based-learning (PBL) in general or computerized project-based-learning (CPBL) in our case, would promote both the subject matter and knowledge about students.

A PBL is a teaching and learning strategy that involves students in complex activities, and enables the learners to engage in exploring important and meaningful questions through a process of investigation and collaboration. Via PBL students ask questions, make predictions and decisions, design investigations, collect and analyze data, use technology, share ideas, build their own knowledge by active learning, and so on (Krajcik, Czerniak and Berger, 1999). PBL enables students working relatively autonomously over an extended period of time and ending with products or presentations (Jones, Rasmussen & Moffitt, 1997; Thomas, Mergendoller & Michaelson, 1999). As a consequence, concepts of the discipline are learned through the process of project conducting.

Research (e.g. Krajcik et al, 1998) points to various advantages of PBL: it develops a sense of personal contribution to the process of learning; increases motivation; raises the self satisfaction; helps in developing long-term learning skills and a deep, integrated understanding of content and process; involves cooperating with each other and hence increases the ability to share ideas in order to solve problems; promotes responsibility and independent learning; engages students in various types of tasks, thereby meeting the different learning needs of many different students; develops the ability of collecting and presenting data, etc.

There are many advantages to integrating computer software into the setting of PBL. Among them: it enables the students to make experiments, observe stability/instability of phenomena, state and verify conjectures easily and quickly, etc. (Marrades & Gutierrez, 2000).

Students might also encounter several difficulties while learning in PBL approach. Among them: inability to generate meaningful questions; trouble in managing complexity and time; problems in processing data and developing a logical argument to support claims (Krajcik et al., 1998). According to the authors, those findings point to the need for incorporating a range of "scaffolds" within the PBL process in order to help students overcome their deficiencies.

Research show (e.g. Greens & Schulman, 1996) that classroom communication can serve as suitable "scaffolds": *“Communication is essential to students' successful approach to, and solution of, mathematical explorations and investigations. Students must communicate with others to gain information; share thoughts and discoveries; brainstorm, evaluate and sharpen ideas and plans; and convince others”*.

The present study examines the impacts of implementing the CPBL approach combined with classroom discussion into a didactical course for mathematics PST.

THE STUDY

In the current study we examine the effects of integrating a CPBL into an annual course named "Didactical foundations of mathematics instruction" for PST of mathematics. This course focuses on theories and didactical methods implemented in teaching and learning geometry (in the first semester) and algebra (in the second semester) in junior high-school. 25 college students (8 male and 17 female students) in their third year of studying towards a B.A. degree in mathematics teaching participated in the research. This course is

the second didactical course they were participating in. The previous one was taken in their second year of studying.

In our study we attempt to characterize the various processes PST experienced while engaging in CPBL. In this paper we focus on aspects relating to the students' experiences both as mathematics and didactics learners

In order to clarify what we mean by CPBL and what we believe should be its phases; we exhibited a ready-made project, which was based on Morgan's theorem (Watanabe, Hanson & Nowosielski, 1996). Afterwards the students had experienced CPBL, which included the following phases: (1). Solving a given geometrical problem, which served as a starting point for the project; (2). Using the "what if not?" strategy (Brown & Walters, 1990), for creating various new problem situations on the basis of the given problem; (3). Choosing one of the new problem situations and posing as many relevant questions as possible; (4). Concentrating on one of the posed questions and looking for suitable strategies in order to solve it; (5). Raising assumptions and verifying/refuting them; (6). Generalizing findings and drawing conclusions; (7). Repeating stages 3-6, up to the point in which the student decided that the project has been exhausted.

The research data included: (a). Transcripts of videotapes of all the class sessions. (b). Two written questionnaires. (c). Students' portfolios that included a detailed description of the various phases of the project and reflection on the process. (d). Informal interviews.

During the class sessions the students raised their questions and doubts, asked for their classmates' advice, and presented their work.

The students could choose to work individually or in pairs. They used dynamic geometrical software in the various stages of the project.

RESULTS AND DISCUSSION

Analysis of the data obtained from the transcripts, questionnaires, portfolios and interviews revealed a remarkable impact on students' views and attitudes that are connected with the learning and teaching of mathematics. In this paper we focus on some of the changes that emerged during the work on the project regarding didactical aspects.

Analysis of the data points at three main sub-categories relating to aspects concern with the PST as learners: the development of self-confidence in mathematical competence; the contribution of the computerized environment; and the impacts of the classroom discussions.

The development of self-confidence in mathematical competence-

Most of the students stated that they had changed their view as regards "what is mathematics" and what can be considered as "doing mathematics". At the beginning of the course, most of the students perceived the mathematics as a domain in which they had to act according to rigid given rules. They believed that the mathematicians' task is to formulate regularities and to create problems and their assignment is to prove and to solve them. By the end of the course most of the students felt differently:

“I changed my perception of mathematics in 180⁰. I am surprised by myself “; “I discovered many interesting things that I did not previously think of. Things that were beyond my expectations”; “New ideas came into my head regarding how to begin the thinking on new problems and how to cope with them”; “The work on the project raised my motivation to investigate and discover mathematical regularities, pose new problems and not accept anything as obvious”; “The work on the project helped me realize that not everything in mathematics is black or white, and that you can have fun while doing mathematics”.

As the students were asked to clarify their statements, we noticed a conceptual change in their thinking, one that implies a shift from perceiving themselves solely as mathematics learners to "mathematics makers" as well. While as mathematics learners their "mission" is to solve given problems, or to prove already known theorems, as mathematics creators they become part of the mathematical community by being able to pose new problems and find new mathematical regularities.

This change of view caused many students to explicitly distinguish between the traditional methods of learning mathematics and the CPBL approach, and stated that their ability to discriminate between them was a kind of insight they gained from working on the project:

“...when I need to prove a mathematical regularity, I know that the regularity is valid and all I have to do is to prove it formally. Whereas working on the project was accompanied by different feelings. The search for regularities, that might not exist, raised doubts and fears but also curiosity and motivation”.

The above quotation points to a very important aspect, which is fundamental to the conceptual transition from implementing traditional methods of problem solving in which the learner does not question the validity of the problem to posing new problems whose validity is questionable.

Along with the feelings of lack of confidence, which were expressed by raising doubts and a sensation of "fear", there were curiosity and motivation.

Students report that the recognition of their ability to find new regularities and not just work mechanically changed their self confidence in their mathematical competence:

“...The important thing is that I am capable of finding new things. It is true that what I had found is not very interesting to the mathematical community, but who cares? The fact that I am working and thinking of what to do next – this is new to me”.

This student, like many others, found out that the process of doing mathematics became more significant to her as she was no more solely "results oriented".

Apart from the students who benefited from the activity, there were three students who did not feel any change during the period of working on the project. Moreover, they explicitly expressed their resentment, since we insisted that they continue their work. Interviews with those students revealed that they found it very difficult to work in a different manner from the one they were used to. After a few attempts to find "interesting regularities" with no success, they gave up and lost their motivation to keep on looking.

The contribution of the computerized environment

Most of the students were not used to utilizing computer software for discovering unfamiliar mathematics facts. All the students found that the usage of the dynamic geometrical software had a major impact on their work:

“Without the software I would not have progressed in the project”; “The software enabled me to find a proper method for working on the project; everything is in front of your eyes”; “The software directed me to think completely differently”; “Things can be discovered not just by using formulas and theorems but also through self investigation using the software”; “The software helped me to think in various directions to discover new facts which I could not think of by myself”; “The software influenced the investigation route. Since the software does all the technical work, all I have to do is to think. It is easier. If I had to do the whole work by myself – I would probably give up”; “The software made the inquiry process more qualitative, quick and efficient and thus the probability for new and surprising discoveries to emerge was raised”.

From the above quotations it can be seen that the students believe that unless they had carried out their project via a computerized environment they would not have reached so many mathematical regularities. The software provided them the freedom of thinking about *“what questions should I pose and how should I test them”* rather than wasting energy in performing a Sisyphean task such as computations and drawings. This kind of learning was new for them, especially the insight that they can regulate their own learning and modes of thinking. The fact that they could easily create new problem situations and visualize them facilitated their work and enabled them to elaborate their investigations.

An important aspect of using the software was raised by the students:

“Working with the software provided me a sense of 'a proof in front of my eyes'. I will never forget it. No doubt that the formal proof is required but visualizing the proof is not less important”.

As was stated before, the students were familiar with the accepted routine in which they were given a statement, already known to be valid, and their task was to provide a formal proof. Since during the work on the project they had to raise their own hypotheses and to test them, the software provided them a sense of "security". They felt that they can see a "visual proof" to what they had just discovered, and thus they were motivated to prove it by formal means.

The impacts of the classroom discussions

The main purpose of the classroom discussions was to provide the students the required "scaffolds", which were previously mentioned.

Most of the students emphasized the impact of the classroom discussions on their progress in the project. Students reported that their classmates' presentations encouraged them to keep on looking for "interesting" regularities. When they were asked to define what are "interesting regularities" they said that this should be *“something new - something that I did not know before”*.

One of the most significant findings was that the presentations set "normative standards" to what should be considered as an "interesting discovery". These standards went higher and higher as time passed.

During the presentations, many original ideas were raised by the students and assisted the members of the group that presented the work to articulate their findings. Additionally, it often caused them to think of alternative ways of investigation. Moreover, the rest of the students also benefited from the process since the new coming ideas caused them rethink possible alternatives for their own projects.

“Observing the presentations of my classmates helped me think how to alter and expand my project”.

In fact, through the classroom presentations the students were simultaneously thinking in both directions: how to help their presenting mates to find new ideas, and how to assimilate those ideas into their own project.

Even the three mentioned students, who had difficulties coping with the project, found the discussions to be very helpful:

“I found the discussions to be helpful for me since together we succeeded to prove things and to learn a lot of geometry. It is nice that everyone contributes a little bit and together we learned a lot”.

Students also related to our role, as the classroom instructors, in monitoring the discussions. They said that even in situations in which it looked as if no "valuable" results would emerge, the fact that we instructed them to probe for alternative problems, eventually led them to discover new directions of investigation.

The discussions also had a "side effect" which we did not anticipate: some of the discussions had a negative impact on part of the students, especially those who were slightly disappointed by not yet finding "interesting findings". Instead of being encouraged, they got the feeling that they will never be able to reach the normative standards that were informally established.

CONCLUSIONS

Since all the students had already taken a didactical course in their previous year of studying, when they began the present course they were already familiar with the concepts "investigation activity" and "problem-based learning". They all knew that it is important to employ such methods in the classroom, but they did not really know why. Therefore, based on our prior experience, we can assume that the chance that they would choose to integrate the methods into their future classrooms was probably low. Experiencing the processes that are involved in employing the methods, via CPBL, enabled most of them to understand the "why" aspect. We can presume from the various data resources that they now realize that learning through problem posing encourages the development of self-confidence in mathematics competence, develops mathematical qualifications, and turns the learning process into an exiting and challenging one. :

“ I am sure I will adopt this method to be used in my mathematics classrooms and I will also use the method for looking for connections between mathematical regularities”; *“I*

want my students to go through the experience we had...”; “now I know that as part of the mathematical proof it is important for the students to see why the statement is true, as we did it in class”; “working on the project made me understand why it is important to encourage students to work on exploration tasks and to discover by themselves the mathematical regularities instead of getting them as obvious”; “ I know now for sure that there is a need to show the mathematics and not just to teach definitions and formulae ”.

FINAL REMARKS

It is not often that we, as teachers’ educators, get to hear: “...Everything was so intriguing and exiting...When we had the feeling that we were finally reaching something, we kept checking it with the aid of the computer just to be sure. At those moments we were tense...We were afraid to discover that it is not always true... I could hear my heart beats strongly ...Only after we discovered that we were right, a huge smile spread slowly on my face...I felt real joy and pride, and my confidence rose...But this feeling did not cause me to rest, it only motivated me to think of another problem, one that would be even more interesting”. We must admit that while reading those sentences a huge smile spread slowly on our faces. This was our benefit from the process they had experienced.

References

- Brown, S. I. & Walter, M. I. (1993). Problem Posing in Mathematics Education. In Stephen I. Brown & Marion I. Walter (Eds.) *Problem Posing: Reflection and Applications*, Hillsdale, New Jersey: Lawrence Erlbaum Associates. 16-27
- Even, R. & Tirosh, D. (1995). Subject-matter knowledge and knowledge about students as source of teacher presentations of the subject-matter. *Educational Studies in Mathematics*. 29: 1-20
- Greene, C. & Schulman, L. (1996). Communication processes in Mathematical Explorations and Investigations. In: Portia C. Elliott & Margaret, J. Kenney.(Eds.) *Communication in Mathematics, K-12 and Beyond*. 1996 yearbook, NCTM.
- Jones, B. F., Rasmussen, C. M., & Moffitt, M. C. (1997). *Real-life problem solving: A collaborative approach to interdisciplinary learning*. Washington, DC: American Psychological Association.
- Krajcik, J. S., Blumenfeld, P. C., Marx, R. W., Bass, K. M., Fredricks, J., & Soloway, E. (1998). Inquiry in project-based science classrooms: Initial attempts by middle school students. *The Journal of the Learning Sciences*, 7, 313-350.
- Krajcik, J., Czerniak, C. & Berger, C. (1999). *Teaching Children Science - A Project-Based Approach*, McGraw-Hill College, New York
- Marrades, R. & Gutierrez. A. (2000). Proofs produced by secondary school students learning geometry in a dynamic computer environment. *Educational Studies in Mathematics*, 44, 87-125.
- NCTM - National Council of Teachers of Mathematics (2000)., *Principles and standards for school mathematics*. Reston, VA: NCTM.
- Thomas, J. W., Mergendoller, J. R., & Michaelson, A. (1999). *Project-based learning: A handbook for middle and high school teachers*. Novato, CA: The Buck Institute for Education
- Watanabe T., Hanson R., & Nowosielski F. D. (1996). Morgan's Theorem. *The Mathematics teacher*, 89 (5), 420-423

MATHEMATICS COMPETITIONS, GENDER, AND GRADE LEVEL: DOES TIME MAKE A DIFFERENCE?

Gilah C. Leder, David G. Pederson and Graham H. Pollard

La Trobe University – Bundoora, University of Canberra and University of Canberra

In this paper we draw on data from a large mathematics competition, for the years 1987 to 2000 and use two different but closely related measures to investigate possible gender differences in performance. Our analyses revealed that small gender differences in favour of males persisted but had decreased over time. Consistent with reports from previous studies, gender differences in performance were more marked at senior high school than at junior high school grades.

INTRODUCTION

Gender differences in performance on mathematical tasks and participation in post compulsory mathematics courses have attracted much attention over the past three decades. A careful reading of the literature reveals that there is considerable overlap in the performance of males and females (see, e.g., Fennema, 1974; Leder, 2001). Friedman's (1995) appraisal: "while gender differences in mathematics are small and apparently decreasing over time, they still exist" (p. 22), offers an economical summary of the major research findings. However, when achievement is reported in terms of (usually low-stake) classroom grades, females are often rated slightly higher than males (Kimball, 1989). Gender differences in performance, most often in favour of males, continue to be reported when above average performance is considered, for students in advanced post compulsory mathematics courses, and on selected mathematical tasks assessed through standardised or large scale testings. For example, data from the large *Third International Mathematics and Science Study* [TIMSS], in which 41 countries and some 15,000 schools participated, revealed that there were few differences in average mathematics achievement by gender in grades 4 and 8 but that there were substantial gender differences in mathematics achievement in favour of males in grade 12 (Mullis, Martin, Fierros, Goldberg, & Stemler, 2000). These authors further argued:

The trends in achievement by gender are so pervasive across countries and the sampling procedures employed so rigorous that a clear pattern can be discerned across primary, middle, and secondary school. The gender gap in achievement becomes larger as students progress through school in most countries (Mullis et al, 2000, p. 5).

Findings from a recent large scale testing program in the USA (National Assessment of Educational Progress [NAEP], 1999) point to a more pervasive performance difference on that instrument. Those data revealed a consistently higher performance by males at three age levels, 9, 13, and 17, with the difference largest for the oldest age group.

The TIMSS data, like many studies before it, indicated that performance can be affected by question content:

Internationally, in mathematics, males tended to perform higher than females on items employing spatial reasoning, reading maps and diagrams, as well as problems involving

percentages or area. Females tended to perform higher on items requiring common algorithms. (Mullis et al, 2000, p. 98)

Males' higher performance on items involving geometry and topology are frequently reported (see, for example, Hyde, Fennema, & Lamon, 1990), although again there is some evidence that the magnitude of performance differences appears to be decreasing (Friedman, 1995).

In addition to question content, it has also been shown that the format of assessment may affect apparent gender differences in mathematics achievement. On average, males – as a group - seem to do better than females on multiple-choice items, but not on unstructured items or on those which require an essay-type response (see e.g., Halpern, 2002; Leder, Brew, & Rowley, 1999).

In the remainder of this paper we draw on a unique and large data base, the Australian Mathematics Competition [AMC]. In earlier explorations of the AMC data some gender differences in performance were found (Leder & Taylor, 1995; Taylor, Leder, Pollard, & Atkins, 1996). Here we examine, for data spanning the years 1987 to 2000, whether gender differences in performance continue to be found, whether they varied with grade level and whether any differences found were consistent over time. (We also examined whether gender differences in performance were affected by question topic area: arithmetic, algebra, geometry, and “other”. However, space constraints do not allow a description of the coding used to define question category, nor of the metric devised to correct for possible differences in correct response rates for different topic areas and needed to enable a realistic comparison to be made of the performance means for different topic areas.)

The scope and format of the AMC are described in the next section.

THE AUSTRALIAN MATHEMATICS COMPETITION [AMC]

The AMC began in 1978. Each year three papers are set: one for students in grades 7 and 8, one for students in grades 9 and 10, and one for students in grades 11 and 12. These are known as the Junior, Intermediate, and Senior papers respectively. Females and males have been approximately equally represented in the entries for the Junior and Intermediate papers, but each year more boys than girls have elected to sit for the Senior paper.

Students are given 75 minutes to answer each paper, which contains 30 questions, and are asked to choose the correct response from a set of five alternative responses. Each of the first ten questions, the second ten questions and the third ten questions in each paper are awarded 3 marks, 4 marks and 5 marks, respectively, for a correct response. One quarter of the marks assigned to a question for a correct response is deducted for an incorrect response.

The Competition has become both a national and international event. More than 90% of Australia's high schools and some 30% of eligible students (i.e., over half a million students) now participate. As well, over the years students from an increasing number of other countries have entered the Competition, with students from 38 different countries doing so in 2000.

Because of the large number of students attracted to the Competition, the organisers elect to use questions which are readily able to be computer marked, i.e., multiple choice questions. Much care is taken by the problems committee in designing the actual items to be used. Basic manipulation arithmetic, algebra, and geometry questions are included, as are routine and non-routine problems from the same domains. Some questions are closely linked to work likely to have been covered in class. Other items are intentionally expected to be unfamiliar to the students sitting for the Competition papers. The acknowledged limitations of the Competition papers - multiple choice questions to be answered in a limited period of time – must be balanced against the extensive penetration of the Competition into the Australian school population and thus the large and diverse group of students reached by the Competition papers.

A COMMENT ON CONTEXT

Reducing gender inequities has been a high priority, over the past three decades or so, in Australia as well as in many other countries. Means to achieve this have included grants to schools to initiate special intervention programs, media campaigns to encourage females to continue with mathematics and enter traditional male fields which rely on strong mathematical background, and putting in place legislation to address discriminatory practices in fields such as education, employment, and welfare. However, during the 1990s, increasing concerns began to be voiced about boys' educational performance (see, e.g., Forgasz & Leder, 2001). In Australia, these concerns led to the publication of the influential report *Boys: Getting it right. Report on the inquiry into the education of boys* (House of Representative Standing Committee on Education and Training, 2002). A list of recommendations to improve the quality and educational environment for students, and for boys in particular, is included in the report.

More boys than girls still elect to take the most demanding mathematics subject offered at the senior high school level. However, performance data presented in the report indicated that, as a group, girls now outperform boys in almost all subjects examined in state wide examinations held at the end of high school (grade 12). In mathematics, too, girls – on average – obtain a higher mark than do boys. These findings are at variance with the performance data for large scale testings reported at the beginning of this paper. It is noteworthy that items found on the grade 12 examination papers include short answer items as well as more open-ended items which require a description of the process used to reach a solution, as well as reaching the solution *per se*.

This brief sketch indicates the context in which the longitudinal data, described in the remainder of this paper, were gathered.

THE STUDY

Retrievable AMC data were available for the years 1987 to 2000 and so the analysis was on the performance results for Australian students for those 14 years. As indicated above, the aim was to determine whether gender differences were found, varied with grade level and changed over time.

The total number of questions posed on the three papers over the time period considered was 1260, the product of 14 (years) x 3 (papers) x 30 (questions)¹. Since each question paper was attempted by students at two different grade levels, there were thus 2520 *items of information* available for analysis.

Measuring gender differences in performance – operational definitions

Two measures of gender difference were used.

- One measure was the difference in the percentage of males (MC) and females (FC) who chose the correct response for a given item, i.e., (MC – FC). This measure is denoted by (M-F), focuses solely on correct responses, and does not distinguish between omitted and incorrectly answered items since both are treated as incorrect answers.
- The second measure was the difference in the percentages of males (MCIR) and females (FCIR) who selected the correct response for a given item, given that they choose a response for that item, i.e., [MCIR - FCIR]. This measure is denoted by (M-F)IR and excludes omitted items.

THE RESULTS

Measuring gender differences in performance – differences over time

As described earlier, for each question there were five alternative responses. The probability of choosing the correct response for any item by chance was thus 0.2. We therefore considered FM CIR, the percentage of females and males combined who chose the correct response to a question, given that a response was chosen, and eliminated from our analyses all items for which FM CIR was less than 20%, since it was considered that those questions would not provide useful information on the difference in achievement between males and females. This reduced the initial data set from 2520 to 1964 *items of information*.

Comparison of two seven-year periods

To allow possible changes in performance over time to be explored, we clustered the 14 years of performance data into two: from 1987 to 1993 – designated as Time 1 or T1 - and from 1994 to 2000 – designated as Time 2 or T2, and calculated gender differences in performance in terms of the two measures described earlier. For example, for students in grade 7, the mean of (M-F) for Time 1 was 2.43 and for Time 2 the corresponding mean was 2.15. There was therefore a decrease in the mean gender difference of 0.28 percentage points from one seven year period to the next. Similar calculations for each grade and both measures of gender difference gave the means shown in Table 1. These data reveal that mean gender differences in performance (in favour of males) were consistently less for Time 2 (the years 1994 to 2000) than for Time 1 (1987 to 1993). The effect sizes (Cohen, 1988) corresponding to the differences in means for Time 1 and Time 2 are also shown in Table 1. They were consistently less than 0.2, i.e., consistently small according to Cohen's definition.

¹ However, each year some questions were used in more than one paper so that the number of questions attempted by students was only 906. *different*

Although the results for the two measures of difference were similar to one another, the data in Table 1 further illustrate that the index chosen for measuring gender differences in performance can influence the apparent magnitude of that difference.

Table 1: Gender difference in performance over two periods: 1987 to 1993 (Time 1) and 1994 to 2000 (Time 2), separately for six grades.

Grade	Variable							
	(M-F)				(M-F) R			
	Time1	Time2	T2 - T1	Effect size	Time1	Time2	T2 - T1	Effect size
7	2.43	2.15	-0.28	-0.073	1.77	1.48	-0.29	-0.078
8	2.75	2.41	-0.34	-0.088	2.12	1.82	-0.30	-0.081
9	3.38	3.06	-0.32	-0.089	2.61	2.39	-0.22	-0.060
10	4.57	3.99	-0.58	-0.148	4.10	3.37	-0.73	-0.189
11	4.64	4.37	-0.27	-0.071	4.42	3.98	-0.44	-0.109
12	6.11	6.06	-0.05	-0.010	6.37	6.13	-0.24	-0.055

Change over a 14-year period: from 1987 to 2000

On the assumption that the mean gender difference in performance was linearly related to time, the means in Table 1 were used to estimate the percentage changes in the mean gender difference from 1987 to 2000. For example, for students in grade 9, (M-F) for Time 1 (centred on 1990) was 3.38 and for Time 2 (centred on 1997) was 3.06. The estimated annual change in the mean of (M-F) was thus $(3.06 - 3.38)/7 = -0.046$. The fitted value for (M-F) for 1987 was $(3.38 + 3(0.046)) = 3.52$ and the fitted value for (M-F) for 2000 was $(3.06 - 3(0.046)) = 2.92$. The estimated percentage change in (M-F) from 1987 to 2000 was therefore -17% . Similar calculations for each grade and for both measures of difference gave the percentages shown in Table 2.

Table 2: Estimated percentage change in the mean gender difference from 1987 to 2000

Grade	(M - F)	(M-F) R
	Percentage change	Percentage change
7	-20	-29
8	-22	-25
9	-17	-15
10	-22	-30
11	-11	-18
12	-1	-7

For both measures, the difference in the performance of males and females was less in 2000 than in 1987, with the change being generally larger for (M-F)|R than for (M - F). For the latter, the difference was approximately 20% for students in grades 7 to 10, but smaller for students in grades 11 and 12.

Measuring gender differences in performance – differences by grade

Grade related gender differences in performance, for the 14 year period or for the *items of information* available for analysis, are summarised in Table 3. For both measures of gender difference the mean difference in favour of males increased markedly from grade 7 to grade 12. Except at grade 12, the gender difference in performance was larger for (M – F) than for (M-F)IR, i.e., larger when omitted answers were counted as incorrect responses.

Table 3: Mean gender difference from 1987 to 2000 for two measures, by grade

Grade	Measure	
	(M-F)	(M-F)IR
7	2.29	1.62
8	2.57	1.97
9	3.20	2.48
10	4.27	3.73
11	4.50	4.20
12	6.09	6.25

An example

As already indicated, some questions are used on more than one AMC paper. In 1993, the following question appeared on the Junior, Intermediate, and Senior AMC paper and was thus attempted by students in grades 7, 8, 9, 10, 11, and 12.

On my flight from Christchurch to Sydney, the following is shown on the information screen in the passenger cabin:

Current speed 864 km/h

Distance from Departure 1222km

Time to Destination 1 h 20 min

If the plane continues at the same speed, then the distance in kilometres from Christchurch is closest to

(A) 2300 (B) 2400 (C) 2500 (D) 2600 (E) 2700

Student performance on this question, at each grade level, is summarised in Table 4.

The data in Table 4 indicate that

- for both males and females, the percentage of students with a correct answer increased with grade level;
- more males than females obtained the correct answer at each grade level;

and

- the difference in the percentage of males and females with the correct answer increased with grade level.

Although the two measures gave consistent results, the magnitude of the difference in mean performance in favour of boys was less for (M-F)/R than for (M-F), i.e., was less when comparison of performance was restricted to items actually attempted by students.

Table 4: Gender difference in performance for one question, at 6 grade levels

	Grade					
Measure of gender difference	7	8	9	10	11	12
MC [% of males who chose the correct response]	23.6	29.4	37.0	41.3	50.0	56.5
FC [% of females who chose the correct response]	18.2	23.2	28.8	31.7	40.1	44.6
(M-F) [defined as MC – FC]	5.4	6.2	8.2	9.6	9.9	11.9
(MC)IR [% of males who chose the correct response, given a response was chosen]	31.8	36.6	43.5	48.0	55.7	61.6
(FC)IR [% of females who chose the correct response, given a response was chosen]	28.0	32.3	37.8	42.0	49.6	54.2
(M-F)IR [defined as (MC)IR - (FC)IR]	3.8	4.3	5.7	6.0	6.1	7.4

A FINAL COMMENT

The AMC is a popular and carefully devised multiple choice mathematics problem paper, widely attempted by students in grades 7 to 12 in Australia as well as in a range of other countries. In this paper we examined Australian data gathered over a 14 year period. Our explorations confirmed that gender differences in mathematics performance in favour of boys persist, at least on multiple choice questions such as those found on the AMC papers, that these differences in performance appear to be decreasing over time, and that they are far more marked for students in the upper secondary grades than for those in the lower secondary grades. These findings are at variance with other (Australian) test data which indicate that males' performance in mathematics, as well as in various other subjects, is lower than that of females. Differences in the types of items found on the different test papers, and differences in the format of response required from students, may account for the different findings.

Use of two different measures for calculating gender differences gave consistent results which nevertheless varied in the strength of the differences observed. Thus reports of the magnitude of gender differences in performance on mathematics problems may well be affected by the choice of metric used for quantifying such differences.

References

Cohen, J. (1988) *Statistical power analysis for the behavioral sciences* (2nd ed.). Hillsdale, NJ: Lawrence Erlbaum Associates

- Fennema, E. (1974) Mathematics learning and the sexes: A review. *Journal for Research in Mathematics Education*, 5(3), 126-139
- Forgasz, H. J., & Leder, G. C. (2001) The Victorian Certificate of Education – a Gendered Affair? *Australian Educational Researcher*, 28(2), 53-66
- Friedman, L. (1995) The space factor in mathematics: Gender differences. *Review of Educational Research*, 65(1), 22-50
- Halpern, D.F. (2002) Sex differences in achievement scores. Can we design assessments that are fair, meaningful, and valid for girls and boys? *Issues in Education*, 8(1), 1-19
- House of Representative Standing Committee on Education and Training (2002, October) *Boys: Getting it right. Report on the inquiry into the education of boys*. Canberra: Commonwealth of Australia
- Hyde, J.S., Fennema, E., & Lamon, S.J. (1990) Gender differences in mathematics performance: A meta analysis. *Psychological Bulletin*, 107, 139-155
- Kimball, M.M. (1989) A new perspective on women's math achievement. *Psychological Bulletin*, 105, 198-214
- Leder, G.C. (2001) Pathways in mathematics towards equity: a 25 year journey . In M. van den Heuvel-Panhuizen (Ed.) *Proceedings of the 25th conference of the International Group for the Psychology of Mathematics Education*, (Vol 1, pp. 41-54). Utrecht, the Netherlands: Freudenthal Institute, Faculty of Mathematics and Computer Science, Utrecht University
- Leder, G. C., Brew, C., & Rowley, G. (1999) Gender differences in mathematics achievement: Here today and gone tomorrow? In G. Kaiser, E. Luna, I. Huntley (Eds.) *International comparisons in mathematics: The state of the art* (pp. 213 - 224). London: Falmer Press
- Leder, G., & Taylor, P. (1995) Mathematics and gender: A question of testing? In B. Grevholm & G. Hanna (Eds.) *Gender and mathematics education. An ICMI Study* (pp. 271-280). Lund: Lund University Press
- Mullis, I.V.S, Martin, M.O., Fierros, E.G., Goldberg, A.L., & Stemler, S.E. (2000) *Gender differences in achievement. IEA's third international mathematics and science study*. Chesnut Hill, MA: TIMSS International Study Centre
- National Assessment of Education Progress [NAEP] (1999) *NAEP trends in academic progress*. Washington: US Department of Education
- Taylor, P. J., Leder, G.C., Pollard, G..H., & Atkins, W..J. (1996) Gender differences in mathematics: Trends in performance. *Psychological Reports*, 78, 3-17

DYNAMIC GEOMETRY AND THE THEORY OF VARIATION

Allen Leung

The University of Hong Kong, China

In this paper, the theory of variation in the tradition of phenomenographic research approach is placed in the context of Dynamic Geometry Environment (DGE). Central concepts of discernment, variation, simultaneity and space of learning in the theory of variation are discussed for simple dragging episodes in DGE to illustrate the potential partnership between the two enterprises. Implications for further research will be discussed at the end.

INTRODUCTION

What makes Dynamic Geometry Environment (DGE) a powerful mathematical knowledge acquisition microworld is its ability to visually make explicit the implicit dynamism of “thinking about” mathematical, in particular geometrical, concepts. By implicit dynamism I mean when engaging in mathematical activities or reasoning, one often tries to comprehend abstract concepts by some kind of “mental animation”, i.e. mentally visualizing variations of conceptual objects in hope of “seeing” patterns of variation or invariant properties. The success of perceiving such patterns or properties usually helps to bring about understanding of the underlying formal abstract concept. However, this is usually a pure-thought process and often lacks corresponding representation in physical reality. In geometry, DGE provides a quasi-reality (Euclidean in nature) embedded in computational technology in which such a cognitive dynamism could be given a visual manifestation. In particular, one of DGE’s power is to equip us with the ability to retain (keep fixed) a background geometrical configuration while we can selectively bring to the fore (via dragging) those parts of the whole configuration that interested us in a mathematical thinking episode. Research has been done in studying dragging strategies employed in DGE and the general conclusion is that dragging in DGE plays a key role in forming a mathematical conjecture (see for examples, Arzarello, F., 2000; Hölzl, R., 1996; Leung, A. & Lopez-Real, F., 2000). Recently, a dragging scheme was suggested by Leung and Lopez-Real (2002) to visualize a proof by contradiction for a geometrical theorem. The cognitive transition from experimental Mathematics (verification and conjecturing) to theoretical Mathematics (formal abstract concept and proof) is an elusive process that is yet to be fully understood. Dragging experiences in DGE open up a “space” in which the reification (Sfard, 1991) of mathematical processes into mathematical concepts might be able to take place. In a dragging episode, what can be experienced is a simultaneous variation of different aspects of an evocative computational object (Hoyle, 1991) and a temporal integration (a simultaneity of the past

and the present) of accumulated mathematical knowledge. This confluence of simultaneities may hold the key to concept formation.

Discernment, variation and simultaneity are the central concepts in the phenomenographic research approach in which learning and awareness are interpreted under a theoretical framework of variation (see for example, Marton & Booth, 1997). In short, phenomenography is about categorizing the limited number of qualitatively different ways of seeing, or experiencing, a phenomenon in a hierarchical fashion. In particular,

To discern an aspect is to differentiate among the various aspects and focus on the one most relevant to the situation. Without variation there is no discernment...Learning in terms of changes in or widening in our ways of seeing the world can be understood in terms of discernment, simultaneity and variation. (Bowden and Marton, 1998, p.7)

Marton, Runesson and Tsui further asserted

that various degrees of expertise, that is, the capability of acting in powerful ways within a certain domain, is reflected in the various ways of seeing, i.e., in the various meanings seen in a particular scenario or problem. (Marton, Runesson and Tsui).

DGE is rooted in variation in its design. It is a milieu where mathematical concepts can be given visual dynamic forms subject to our actions, powerful or not. DGE is a natural experimental ground to experience the theory of variation since it has the built-in mechanism that enables the generation (via intelligent construction and dragging by us) of various qualitatively different ways of literally seeing a geometrical phenomenon in action. In the following discussion, I will attempt to describe, using simple examples in DGE, how the rudiments of the theory of variation can be perceived under DGE, and how the theory of variation can shed light on the process of concept formation in DGE.

DISCERNMENT

In order to see something in a certain way a person must discern certain features of that thing. (Marton, Runesson and Tsui)

Discernment comes about when parts (features) are being focused and temporarily demarcated from the whole (background). In DGE, it is possible to define a way of seeing (discernment) in terms of actually seeing invariant critical features (a visual demarcation or focusing) under a continuous variation of certain components of a configuration. For example, a triangle ABC is constructed in DGE with the values of its interior angles and their sum measured and calculated respectively by prescribed functions in the particular chosen DGE (see Figure 1 for a Sketchpad version). The vertex C is then being dragged (a continuous action on the triangle ABC), hence varying the shape and the values of the interior angles of the triangle continuously (a continuous feedback of the dragging action). In such a dynamic episode of dragging resulting in a

simultaneous twofold interdependent variation, what remains invariant is the sum of the interior angles, that is, it is always equal to 180° . The visual constancy of $m\angle ABC + m\angle BCA + m\angle CAB = 180.00^\circ$ in midst of variations brings to the fore, hence the discernment of, a critical feature of a “generic” triangle, i.e. the sum of the interior angles of any triangle is equal to 180° .

Variation

...variation enables learners to experience the features that are critical for a particular

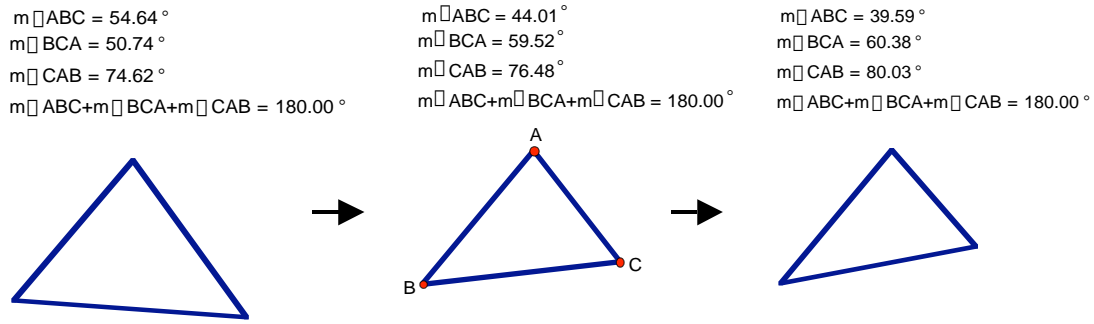

Figure 1.

learning as well as for the development of certain capabilities. In other words, these features must be experienced as dimensions of variation. (Marton, Runesson & Tsui)

A dimension of variation is an aspect of the whole that can be subjected to vary. Dragging in DGE brings about a visual experience for different dimensions of variation in a geometrical situation. I will illustrate this with a simple construction problem in geometry:

(P) Given two arbitrary points A and B, construct a circle that passes through A and B.

The key to this construction is to locate the centre of the circle. How does one see A and B as being points on the same circle? If A and B are regarded as the endpoints of a diameter of a circle, then the center C of the circle can easily be located as the midpoint of the line segment joining A and B. Points A and B can be dragged to different positions (see Figure 2) resulting in circles of different sizes with C = the midpoint between A and B as the centre. Hence we can think of C as a ‘circle-valued’ function with independent

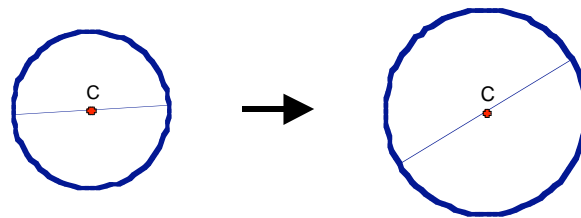

Figure 2

‘variables’ A and B. As A and B vary, C varies (hence the circle containing A and B) accordingly by keeping its relation to A and B invariant.

This provides a simple solution to the construction problem. However, instead of regarding AB as a diameter, A and B can be arbitrary points on a circle. In this case, to locate the centre C of a desired circle, one has to think about radius instead of diameter. This variation in the perception of the problem instantly opens up new dimensions of variation for the geometrical situation that are conducive to deeper understanding of the problem. Construct an arbitrary point C. Join A, C and B, C and measure their lengths. C can then be dragged to a position at which the numerical values of the lengths of AC and BC appear to be the same (see Figure 3).



Figure 3

This position is then the centre of a circle that passes through points A and B. However, this is not only position such that this drag-to-fit strategy works (e.g. see Figure 4 for another such position with a different value for the radius). Consequently, one can construct more than one circle that passes through points A and B. By dragging (hence varying) C, we are literally looking for those positions on the computer screen at which the relation $BC = AC$ holds.



Figure 4

Contrast

... in order to experience something, a person must experience something else to compare it with. (Marton, Runesson & Tsui)

The positions of C that are either circle producing or not circle producing bring about such a contrasting experience.

Generalization

“...in order to fully understand what ‘three’ is, we must also experience varying appearances of ‘three’...” (Marton, Runesson & Tsui)

Is it possible to find all circle producing positions for C? Can the ‘appearance’ of the invariance length $BC = \text{length } AC$ be visualized?

In most of the DGE, it is possible to visually trace the movement of a point when the point is being dragged. In Figure 5, the path (or locus) of point C is being traced while it is dragged in a way that would keep the lengths of BC and AC as equal as possible. This kind of dragging strategy is called lieu muet dragging (Arzarello, Micheletti, Olivero and Robutti, 1998). The traced path (locus) traced is called a locus of validity by Leung and Lopez-Real (2002). In fact, the locus of validity for this problem is the perpendicular bisector of the line segment AB. Hence, in DGE, it is possible to have an objective visualization of ‘generalization’ in variation.

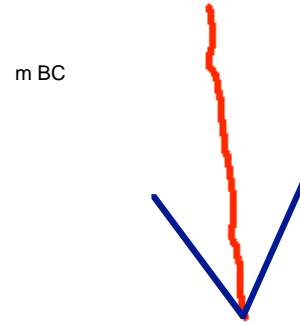

Figure 5

Separation

In order to experience a certain aspect of something, and in order to separate this aspect from other aspects, it must vary while other aspects remain invariant. (Marton, Runesson & Tsui)

Throughout this dragging episode, the positions of A and B remain fixed while C is varying. Even though the invariance of the positions of A and B is not a given condition to the problem, it is a necessary condition to separate out the locus of validity when C varies in a specific way. The locus of validity is the critical feature that emerges under the two constraints:

- C1:A and B are fixed,
- C2:length BC = length AC.

Fusion

If there are several critical aspects that the learner has to take into consideration at the same time, they must all be experienced simultaneously. (Marton, Runesson & Tsui)

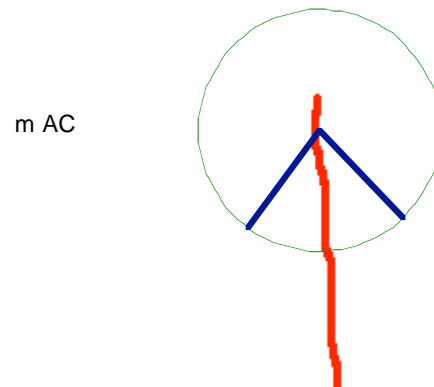

Figure 6

Constraint C2, the locus of validity and the circle that passes through points A and B are three critical aspects that can be manifested visually and simultaneously in a continuous manner. Figure 6 is a snapshot of such a fusing experience as C is dragged along the locus of validity. It is interesting to ponder on the idea that simultaneity seems to suggest equivalence, since in this case, the three critical aspects can be regarded as equivalent to each other.

Simultaneity

...to experience variation amounts to experiencing different instances at the same time. (Marton, Runesson & Tsui)

Experiencing variations simultaneously is a unique feature of DGE. This is what makes DGE a powerful knowledge acquisition medium. Different parts of an evocative computational object can be varied continuously via different dragging strategies in real time. This brings about a simultaneous awareness of different critical aspects of a geometrical situation, hence creating a potential space for seeing mathematical structure and meaning in different qualitative ways. This kind of simultaneity is likely to constitute the crucial moment when mathematical conjecturing, and even formulating of mathematical proof, occurs. In expounding the construction problem (P) in DGE, the emphasis on seeing at the same time different parts of the whole, or variation under a fixed constraint, has been the underlying theme that carries the discussion. Two types of simultaneity can be distinguished, one is on space and the other one is on time.

Synchronic Simultaneity

...a way of seeing something as the discernment of various critical features of an instance simultaneously... .. (This) is the experience of different co-existing aspects of the same thing at the same time. (Marton, Runesson & Tsui)

This is a spatial type of simultaneity. Figure 6 is such an example of a synchronic simultaneity in DGE. Different critical features (the numerical values of the lengths of CB and AB, an approximate trace of the locus of validity, the circle that passes through A and B) ‘co-exist’ visually in the same picture at a point in time all being parts of one spatial configuration, hence producing a simultaneous experience of the whole-parts relations.

Diachronic Simultaneity

In order to experience variation in certain respect, we have to experience the different instances that vary in that respect simultaneously, i.e., we have to experience instances that we have encountered at different points in time, at the same time. (Marton, Runesson & Tsui)

This is a temporal type of simultaneity. In DGE, diachronic simultaneity can assume a physical appearance. Dragging in real time composes a mini-movie episode (in some DGE, this can even be recorded and replayed), a weaving together of continuous temporal instances of variation of critical features in motion. In particular, in the case of the construction problem (P), diachronic simultaneity is visually manifested as the trace of a possible locus of validity that can bring about structure and meaning to the problem. Each ‘previous’ location of C on the locus of validity is a past experience (knowledge) and is visually in co-existence with the ‘present’ location of C.

Furthermore, diachronic simultaneity in DGE can be thought of as a temporal (in the sense of dragging in real time) integration (continuous summing up) of synchronic simultaneity. The integrated object, e.g. the locus of validity, can be thought of as a generalized and ever changing figure-ground structure that encompasses a totality of

experiences of a dragging episode, bringing about an awareness of the mathematical concepts involved.

Space of Learning

Creating a space means opening up a dimension of variation. (Marton, Runesson & Tsui)

The metaphor of a space of learning in variation theory is particularly apt when perceived in DGE. On an ontic level, DGE is a quasi-real virtual space in which geometrical objects and concepts can be visually constructed and manipulated. On an epistemic level, DGE is equipped with built-in devices (e.g. dragging, animation) to open up multiple dimensions of variation in any given geometrical situation, thus creating a space of learning in the sense of variation theory. A dimension of variation can be a measurement of certain geometrical quantity like length, a geometrical object like point, or any “drag-sensitive” (i.e., vary under dragging) part of a geometrical configuration. These dimensions of variation are “aspects of a situation, or the phenomena embedded in that situation, that can be discerned due to the variation present in the situation.” (Marton, Runesson and Tsui) The choice of these dimensions makes up an *observable space* that has the potential (via dragging) to bring to awareness of certain pattern of variations (or invariance), e.g. the existence of a locus of validity. This in turn contributes to the understanding of a certain mathematical concept. For the construction problem (P), the locus of validity is the perpendicular bisector of AB and the ‘answer’ to, or the mathematical concept behind, (P) is:

There are infinitely many circles that can pass through any two arbitrary given points.

Furthermore, the dragging episode opens up a space of learning (via exploration) in which variation leads to an experience of the equivalence between the problem (P) and its locus of validity. Equivalence is a deep mathematical concept.

IMPLICATIONS

I hope the above discussion carried enough conviction to suggest that there is a natural partnership between two well-established educational enterprises: DGE and the theory of variation. It would be worthwhile research to investigate how the framework of variation theory can enlighten our understanding on how students learn Mathematics in DGE and consequently, how to make DGE a pedagogically powerful environment to acquire mathematical knowledge. The idea of simultaneity seems to be a promising agent to help to bridge the gap between experimental Mathematics and theoretical Mathematics, or the transition between the processes of conjecturing and formalizing. This gap has been a cognitive black box that has yet to be totally opened. I hope the introduction of the theory of variation into DGE research can stimulate further insights, discussions and research agenda, and may even catalyze the process of opening this black box.

References

- Arzarello, F., Micheletti, C., Olivero, F. & Robutti, O. (1998) Dragging in Cabri and Modalities of Transition from Conjectures to Proofs in Geometry. *Proceedings of PME 22: Psychology of Mathematics Education 22nd International Conference*, 2 (pp.32-39). Stellenbosch, South Africa
- Arzarello, F. (2000) Inside and Outside: Spaces, Times and Language in Proof Production. *Proceedings of PME 24: Psychology of Mathematics Education 24th International Conference*, 1 (pp.23-38). Hiroshima, Japan.
- Bowden, J. and Marton, F. (1998) *The University of Learning*. London: Kogan Page.
- , C. (1993) Microworlds/Schoolworlds: the transformation of an innovation. In Keitel, C. & Ruthven, K. (Eds.) *Learning from Computers: Mathematics Education and Technology* (pp. 1-17). Berlin: Springer-Verlag.
- Hölzl, R. (1996) How does 'dragging' affect the learning of geometry. *International Journal of Computers for Mathematical Learning*, 1, 169-187.
- Leung, A. & Lopez-Real, F. (2000) An analysis of students' explorations and constructions using Cabri geometry. In Clements, M.A., Tairab, H., & Yoong, W.K. (Eds.) *Science, Mathematics and Technical Education in the 20th and 21st Centuries* (pp. 144-154). Universiti Brunei Darussalam.
- Leung, A. & Lopez-Real, F. (2002) Theorem justification and acquisition in dynamic geometry: a case of proof by contradiction. *International Journal of Computers for Mathematical Learning*, 7, 145-165.
- Marton, F. and Booth, S. (1997) *Learning and Awareness*. New Jersey, Lawrence Erlbaum Associates, INC, Publishers.
- Marton, F., Runesson, U. and Tsui, A.B.M. (forthcoming) The space of learning. Chapter One in Marton, F. & Tsui A.B.M. (Eds.) Marton, F. & Tsui, A. B. M. (Eds) (forthcoming) *Classroom Discourse and the Space of Learning*. New Jersey, Lawrence Erlbaum Associates, INC, Publishers.
- Sfard, A. (1991) On the dual nature of mathematical conceptions: reflections on processes and objects as different sides of the same coin. *Educational Studies in Mathematics*, 22, 1-36.

ENHANCING TEACHERS' UNDERSTANDING OF STUDENTS' LEARNING BY USING ASSESSMENT TASKS

Pi-Jen Lin

National Hsin-Chu Teachers College, Taiwan

The study was designed to enhance teachers' understanding of students' learning by using assessment tasks. Four third-grade teachers and the researcher collaboratively set up a school-based assessment team in the two-year Assessment Practices in Mathematics Classroom project that assisted teachers in implementing assessment as integral part of instruction. The assessment tasks along with students' responses to the tasks and classroom observation were major methods of data collection. Interweaving the tasks with analyzing students' responses to the tasks was a valuable way of assessment in which students enhanced their learning and teachers gained better understanding of students learning informing their instructional decision-making.

INTRODUCTION

There is increasing evidence that knowledge of children's thinking is a powerful influence on teachers as they consider changing their instruction (Fennema et al. 1996). A cohort of research suggests that as teachers' knowledge of students' thinking grew, their knowledge of mathematics increased, and instructional change occurred (Simon, 1995). Assessment integral to instruction contributes significantly to all students' mathematics learning (NCTM, 2000).

The Principles and Standards for School Mathematics emphasized that every instructional activity is an assessment opportunity for teacher and a learning opportunity for students (NCTM, 2000). For teachers to attain the necessary knowledge, assessment integral to instruction should become a focus in teacher education programs. Amit and Hillman (1999) provide teachers in Israel and the United States with new approaches to instruction and assessment using open-ended, real world problems. Chambers (1993) describes how teachers use the results of informal methods such as observing, listening, and questioning to help them make informed instructional decisions. The tasks involved in the previous studies on assessment were administrated merely either as a part of ongoing classroom activity for assessing students' thinking or at the end of instruction.

It is not adequate that the tasks were administrated merely during instruction to understand how each student thinks according to his natural way of thinking in a typical classroom with 30 to 35 students. Thus, there is a need to extend the use of tasks for assessing what each student knows about the material presented in each lesson. This indicates that teacher education programs should provide teachers with the opportunity to design assessment tasks, which the tasks were generated from the content of one day lesson and students' responses to the tasks were served as the decision of making further instruction of next day lesson.

The focus of this study was on helping teachers designing assessment tasks and analyzing students' written work, as an aspect of assessment integral to instruction. The assessment tasks were generated from the content learned in the flow of instruction. Thus, the mathematics contents included in the third-grade textbook were used as one dimension of

the assessment framework of the study. Reformed curricula call for an increased emphasis on teachers' responsibility for the quality of the tasks in which students engage. The high quality of tasks should help students clarify their thinking and develop deeper understanding through formulating problems, communicating mathematics with understanding, and justifying other's way of thinking (NCTM, 2000; MET, 2000). Thus, formulating problem, communicating mathematics, justifying one another's thinking were considered as the other dimension of the assessment framework of the study.

According to De Lange (1995), a task that is open for students' process and solution is a way of stimulating students' high quality thinking. However, the design of open-ended assessment tasks is a very complex and challenging work for the teachers who are used to the traditional test. This can only be achieved by establishing an assessment team who support mutually by providing them with the opportunities for dialogue on critical assessment issues related to instruction.

The Professional Standards for Teaching Mathematics recommended that teachers could use task selection and analysis as foci for thinking about instruction and assessment (NCTM, 1991). Tasks as defined by the Standards are the problems, the questions, and exercises in which students engage (1991, p.20). Tasks referred to this study included the problems in which students engaged presented in students' journal, as an informal way of assessing what mathematics each student learned and what students' solutions displayed in a lesson. Thus, the tasks for understanding how students were thinking in the lesson were not well prepared prior to the instruction; rather, they were generated from a lesson. Analysis as defined by the Standards is the systematic reflection in which teachers engage (NCTM, 1991, p.20). Analyses referred to in the study included the reflections teachers made to monitor how well the tasks for fostering the development of every student's thinking and to examine relationships between what the teachers and their students were doing and what students learned.

THE ASSESSMENT PRACTICES IN MATHEMATICS CLASSROOM PROJECT

The Assessment Practices in Mathematics Classroom (APMC) project funded by the National Science Council was designed to develop a teacher program in which assisted teachers in implementing assessment into classroom practice. The paper reported here was part of the data collected in the first year study of the two-year project. An aim of the project was to assist teachers to explore their understandings about how students develop their understanding of mathematics, and how this can be supported through the program.

To reach the aim, teachers were encouraged to use students' journal as a way of gathering the information about students' thinking processes, strategies, and their developing mathematical understanding. Assessment tasks were served as the prompts of students' journal since 1) journal writing is likely to bring to light thoughts and understanding that typical classroom tests do not elucidate (Norwood & Carter, 1996); 2) we want to establish a better means of communication among students, parents, and teachers about mathematics leaning taking place in classrooms; 3) we are looking for a better way to assess each student's entire learning process by writing about mathematics.

In generating mathematical tasks as the core of the APMC project, the concerns included that: 1) supports a method of assessment that allows students to demonstrate their strengths; 2) stimulates students to make connections for mathematical ideas; 3) promotes high quality of problem-posing, communicating, and justifying one's way of thinking; 4) generates good tasks that do not separate mathematical processes from mathematical concepts; 5) generates the assessment tasks for inspecting what and how students learned from a lesson. To generate the high quality of the tasks from today's lesson, the tasks involved in each journal including one or two problems were reasonable.

The philosophy of the APMC project was based on social constructivists' view of knowledge, in which knowledge is the product of social interaction via dialects in a professional community (Vygotsky, 1978). Therefore, activities related to generating assessment tasks were structured to ensure that knowledge was actively developed by the teachers, not imposed by the researcher. The assessment tasks in the study were generated by participants' professional dialogues and provided them with opportunities to examine their assessment practices. Thus, participants were frequently involved in observing teaching together, dialoguing as a group, and reflecting on the quality of tasks.

The study reported in this paper was designed to support teachers' understanding of students' learning by the use of assessment tasks as part of a school-based professional development project. There was a research question to be answered: How assessment tasks do teachers use in supporting their understanding of students' learning mathematics?

METHODS

To achieve the goal of the study, a school-based "assessment team" consisting of the researcher and four third-grade teachers was set up to discuss the assessment issues which occurred in one teacher's classroom by comparing to others. The school involved in the project was selected because of teachers' willingness to learn, administrators' support and ever collaborating with the researcher on other projects. Four teachers were selected from same third-grade teachers so that they could support each other in their efforts to effect change. Besides, same mathematical content lent itself to a focus and similar issues of assessment addressed drew attention from each teacher, leading to in-depth discussions. Thus, third-grade classrooms were one context of teachers' learning to design tasks. Participation in regular weekly meetings was the other primary context. The year of teaching for four teachers (Yo, Mei, Jen, and Ying) is from 5 to 16. The role of the researcher was not to provide ready-made tasks for teachers to use, but to create opportunities for the teachers to construct their own assessment tasks for students.

The teachers had little knowledge of assessment integral to instruction, so that classroom observation was used as a means of increasing their awareness of generating assessment tasks initiated from the lessons that were observed by them together. The assessment team had routine weekly meetings for three hours. The meetings were for providing the participants with the opportunities of sharing their creative tasks with others and helping them rethink the value of tasks in gathering information about students' in-depth understanding. The participants required bring their students' responses to the tasks for others to analyze in weekly meeting. Because the use of tasks was to promote students'

understanding rather than just for a work, the following questions were supplied to nudge the teachers to rethink: What do you expect to learn about your students from this task? Are you satisfied with your students' performance on the task? Did you really gain what you want to gather? Each teacher needed to report in public in the meeting what they learned from the tasks and what information they gathered from students' responses.

Data for this study was gathered through classroom observations, assessment tasks, and teachers' analyses of students' responses to the tasks throughout the entire year. The weekly meetings were audio-recorded and then were transcribed. Tasks and students' responses to the tasks were copied as major methods of the data collected in the study. Students' responses to the tasks as the examples of the paper for illustration were transcribed to be as faithful as possible to the students' exact words. Analyzing each task for teachers together was designed to expand each teacher's perspectives of students' learning.

RESULTS

The results showed that the tasks gathering information about students' learning from students' responses to the tasks helped the teachers clarify students' own thinking, develop their students' critical thinking, recognize where students need to remediation, and understand various cognitive levels among students.

Helping teachers clarify students' own thinking mathematics

A type of task the teachers designed in the study was for helping students to clarify their own thinking. This type of task reveals that the teachers provided opportunities for their students with writing about mathematics for organizing their thinking developed in a lesson. A task shown in Figure 1 was designed to use multiple representations to illustrate mathematical ideas they learned in classroom. Ying designed the task for clarifying her students' understanding of multiplication by asking them to translate it into pictorial and symbolic expressions. The written work sketched in Figure 1 showed that Wei-Der clarified his concept of "equally sharing" by using pictures and symbols. The response helped the participants realized that Wei-Der did not master the basic facts of multiplication, since his answer listed a sequence of multiplication expressions from $3 \times 1 = 3$, $3 \times 2 = 6$...to $3 \times 8 = 24$ instead of getting $3 \times 8 = 24$ directly.

<p>Task: Chinese version</p> 	<p>Task: English version</p> <p>24 pencils Ying has were to be shared equally among 3 kids. How many pencils would each kid have?</p> <p>Solving it by drawing. (b) Using open sentence represent it and then solving it by using operation. (Ying, 11/02/2000)</p>
---	--

Figure 1: Wei-Der's Journal Writing

Helping teachers develop students' critical thinking

The task in Figure 2 generated from one day's lesson was administered to examine whether each student perceived others' solutions discussed in Jen's classroom. As observed, the emphasis Jen placed to how a problem is solved as important as its answer. Student's statements were open to question and elaborate from others in her classroom. The questions she asked commonly in her classroom included "Do you think it is true?"

English version A cow produce bucket of milk. How many buckets of r do 5 cows prod totally?	English version There are 5 third-gr classes in Din-Pu scho There are clocks in e class. How many clocks there altogether	English version: A supermarket s eggs. There are eggs in each car How many eggs d have to pay fo cartons of eggs?	English version: I cannot get allowance. My elder bro cannot get allowance. My elder si cannot get allowance. My youn brother cannot get allowance. younger sister cannot get allowance. I cannot get allowance. Mom cannot allowance. Because we are naug There is no money we get altogether.
---	---	--	--

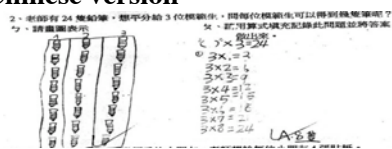
Figure 3: SuFigure 4: Wu’s Writ Figure 5: Liu’ Writing Figure 6: Tsai’s Writing

The teachers analyzed each student’s writing in a weekly meeting. They reported that 11 out of 35 students could not give a clear description of the multiplicand with number 1. Four students’ reposes to the task demonstrated in Figure 3, 4, 5, and 6 reveal their various cognitive levels of multiplication. Ying said that Wu had trouble with the multiplicand 1, as shown in Figure 4. He explained “1” presented in $1 \times 5 = ()$ by the words “clocks in each class” instead of “a clock in each class”. The researcher recommended Yo bring the improper problem to classroom to ask other students help repair it. Next day, Yo acted as though she needed help and then asked students, “Is it [*There are 5 third-grade classes in Din-Pu school. There are clocks in each class. How many are clocks there altogether?*] wrong? Could you help me to repair it so that it can be solved?” As observed, students concentrated to repair the improper problem (Observation, 10/13/2000).

The task also showed that the third-graders had difficulty with understanding the multiplicand with number 1 by using pictorial representation. Sue drew a cow shown in Figure 3 standing for the context “each 5 cows producing a bucket milk”. Likewise, Wu had difficulty with modeling the problem she posed by using $_ \times _ = _$ representing $1 \times 5 = 5$, as shown in Figure 4.

The teachers agreed that Tsai’s cognition of multiplication, as shown in Figure 6, still stayed at “repeated addition” while Liu had better understanding of multiplication. Nevertheless, the problems Liu posed displaying in Figure 5 were not reasonable in real situation. Mei, one of the teachers, said that the cartons with no egg selling in market were not a real situation in daily life. She further suggested that the problems formulated by the students were better than those she had ever posed in classroom. For instance, a problem posed by another student was that “A policeman has a gun with no bullet. He fired at a robber 7 times. How many was the robber hit?” The problems students posed in students’ journal became a good source for her further instruction.

Helping teachers recognize where students need to remediation

Another assessment task enabled teachers to make immediately instructional remediation for next day lesson conducted in Mei’s lesson relevant with angle.

After grading students’ journal writings, the teacher, Mei, perceived that eight of her students had a misconception of an angle. According to students’ responses to the task, Mei understood that students misunderstood the size of angle either as the width between two sides of the angle, as Wen’s writing in Figure 8, or as the distance between the vertex

and the label of an angle, as shown Chang's writing in Figure 9. As a result, they identified the task with the incorrect answer in which B is larger than A. Mei perceived that there is a need for students to correct the misconception of an angle in next day lesson.

<p>Task: Chinese version</p> <p>1. 小玉上課時，畫了一個旋轉角，並畫了二個旋轉方向的記號，他不知道甲和乙那一個旋轉的角度比較大，請您告訴他，並說明理由。</p> <p>(Mei, 04/21/2001)</p>		<p>Task: English version</p> <p>inda drew a rotated angle with A and B as direction. I cannot tell which angle is larger in the Figure 9. Please help her to solve it with your explanation.</p>	
<p>那一個旋轉角度比較大？——一樣大</p> <p>理由是：因為都是從同一個地方開始，轉到同一個地方停止旋轉的。</p>		<p>那一個旋轉角度比較大？乙比較大</p> <p>理由是：因為甲的寬度小，乙的寬度大。</p>	
<p>Student's response: English version</p> <p>They have the same size. Because both angle A and B started with the same place and ended with the same place.</p>		<p>Student's response: English version</p> <p>The angle B is larger than A. Because the width of angle B is longer than A, so that B was larger than A.</p>	
<p>Student's response: English version</p> <p>The angle B is larger than A, since that the distance from the vertex to angle A is farther than to angle B.</p>			

Figure 7: Shung's Writing

Figure 8: Wen's Writing

Figure 9: Chang's Writing

At the very beginning of the next day lesson, Mei asked Wen to come to the front of the classroom to explain his wrong answer. Wen said: "The width between two sides of the angle A was longer than that of the angle B". Soon after his explanation, the class made noise, even in front of the observers. "How come?" "Impossible." were voices of what they shouted from their seats. "Why did you disagree with Wen's thought?" Mei said. At this time, many hands were waving and Shung was pointed by the teacher to explain for Wen. Shung explained with "Both angles A and B start at the same place and stop at the same place." displayed in Figure 7. Mei asked Shung to demonstrate what she means by "starting at the same place and stopping at the same place". Shung exhibited an angle with a stick from a line rotated to an ending line on the blackboard (Observation, 04/23/2001).

CONCLUSION

The main conclusion of the study was that designing tasks along with analyzing students' responses to the task was an effective approach for enhancing teachers' knowledge of students' learning, since it provided the teachers with the opportunities to share insights of students' learning when they discussed students' responses to the tasks. The finding is consistent with the previous research on assessment integral to instruction (Heuvel-Panhuizen, 1996). However, the assessment tasks integral to instruction referred to in the study were characterized by the tasks conducted by the researcher collaborating with same grade classroom teachers. Most of the tasks for assessing students' learning referred to in previous studies are either designed by researchers only, or the assessment is merely a test at the end of instruction (Heuvel-Panhuizen, 1996). Comparing to assessment tasks developed by individual, sharing multiple perspectives of monitoring how well each task in a school-based assessment team was more likely to enrich the quality and the varieties of tasks. The tasks designed in the study provided more opportunities for students to clarify and extend their understanding and for teachers to gain knowledge of students' thought informing instructional decision.

A result of the study showed that the task dealing with problem posing allowed teachers to gain insights into the way students constructed mathematical understanding. The problem-posing tasks can be served as an assessment tool and gather the information of students' cognitive levels. Furthermore, the improper problems students posed as an indicator of their unclear conception can be made profitable when asking students to help repaired them and inform teachers making instructional decision. A second result in the study was that the task dealing with students' misconception seems to be likely to enable teachers to make immediately remediation for the misconceptions. Thus, correcting students' misconceptions became a common work for the teachers at the very beginning of each lesson.

Finally, the task displaying various solutions that students resolved for a problem in a lesson helped teachers examine the individual understanding to one another's' methods. The classroom discourse on mathematical ideas became a major resource of conducting such kind of assessment task. As a result, this contributed the teachers to optimizing the quality of assessment and instruction, and thereby optimized the learning of the students. The question of how effective the tasks developed in the study may be with promoting teachers' instruction will be a focus in the next stage of the study.

References

- Amit, M. & Hillman, S. (1999). Changing mathematics instruction and assessment challenging teachers' conceptions. In B. Jaworski, T. Wood, & S. Dawson (Eds.) *Mathematics teacher education: Critical international perspectives* (pp. 17-25). London: Falmer Press.
- Chambers, D. (1993). Integrating assessment and instruction. In N. L. Webb (Ed.) *Assessment in the mathematics classroom* (pp.17-25). NCTM Yearbook.
- Lambdin, D. V., Kehle, P. E., & Preston, R. V. (1996). *Emphasis on assessment: Readings from NCTM's school-based journals*. Reston, Va: Author.
- De Lange, J. (1995). Assessment: No change without problems. In T. A. Romberg (Ed.) *Reform in school mathematics and authentic assessment* (pp.87-173). New York: Suny Press.
- Fennema, E., Carpenter, T. P., Franke, M. L., Levi, L., Jacobs, V. R. & Empson, S. B. (1996). A longitudinal study of learning to use children's thinking in mathematics instruction. *Journal for Research in Mathematics Education*, 27, 403-434.
- Heuvel-Panhuizen, M. (1996). *Assessment and realistic mathematics education*. Utrecht: CD-Press.
- Ministry of Education of Taiwan (2000). *Nine-year curriculum integration for school mathematics in Taiwan*. Taiwan: Taipei.
- National Council of Teachers of Mathematics (1991). *Professional standards for teaching mathematics*. Reston, Va: Author.
- National Council of Teachers of Mathematics (1995). *Assessment standards for school mathematics*. Reston, Va: Author.
- National Council of Teachers of Mathematics (2000). *Principles and standards for school Mathematics*. Reston, Va: Author.
- Norwood, K. S. & Carter, G. (1996). Journal writing: an insight into students' understanding. In D. V. Lambdin, P. E. Kehle, & R. V. Preston (Eds.), *Emphasis on assessment: Readings from NCTM's school-based journals* (pp. 81-84). Reston, Va: Author.
- Simon, M. (1995). Reconstructing mathematics pedagogy from a constructive perspective. *Journal for Research in Mathematics Education*, 26, 114-145.
- Vygotsky, L. S. (1978). *Mind in society*. Boston, Harvard University.

EARLY MATHEMATICS TEACHING: THE RELATIONSHIP BETWEEN TEACHERS' BELIEFS AND CLASSROOM PRACTICES

Sharon Sui Ngan Ng
Hong Kong Institute of
Education

Francis Lopez-Real Nirmala Rao
The University of Hong Kong

This paper describes a pilot study which is part of a larger research project into theories underpinning the teaching and learning of early mathematics in Hong Kong. In this pilot study we focus on the relationship between teachers' beliefs and their instructional practice in pre-school and lower primary school. Findings reveal that there were more consistencies between beliefs and practices in kindergarten teachers compared with primary grade teachers.

INTRODUCTION

There is much research evidence showing that teachers' beliefs concerning both the nature of mathematics and the learning of mathematics are significant factors influencing their instructional practices. For example, Thompson (1984, 1992) showed that the patterns of teachers' behaviours are likely be manifestations of consciously or unconsciously held notions, beliefs and preferences concerning the discipline of mathematics. Yelland, Butler and Diezmann (1999) have also pointed out that beliefs about how children learn influences the ways in which teachers interact with learners. In Hong Kong there is a dearth of research concerning beliefs and practice related to the pre-school stage and this is one of the rationales for this study.

A significant piece of research conducted on early childhood teachers is that of Vartuli (1999). Her study covered teaching in Head Start, kindergarten, and first to third grade classes. In her research, Vartuli reported that as grade level increased the level of self-reported developmentally appropriate beliefs and practices decreased and the same held true for observed practice. That is, there were more consistencies between beliefs and practices in Head Start and kindergarten teachers compared with primary grade teachers. Vartuli also makes the following ironic comment: "It appears that as children get older they are allowed less responsibility for their own learning".

METHODOLOGY

The pilot study involved three teachers belonging to a K2 class (4-year-olds) a K3 class (5-year-olds) and a primary one class (6-year-olds). One pre-school and one primary school were selected as being reasonably typical of mainstream schools in Hong Kong. Data were collected in one school year and all teachers were addressing addition.

Videotaped classroom observation, questionnaire and interviews were used to collect data. Three consecutive lessons on mathematics teaching were videotaped. To ensure that the videos captured normal classroom teaching a standardized briefing note was used to make sure that teachers involved were clear about the aims of the research. In addition, the teachers were later asked to judge how typical the videotaped lessons were, compared with their normal classroom teaching.

Whereas videotaped classroom observation served to study teachers' behaviours and classroom practices, the questionnaires and interviews served to investigate teachers' conceptions and beliefs. The questionnaire data was essentially used to serve as prompts during follow-up interviews to make explicit teachers' conceptions on the nature of mathematics and its teaching and learning. Two stages of interview were scheduled. The first stage aimed at mainly exploring the beliefs of teachers whereas the second stage, with the help of video extracts, aimed at investigating the relationship between teachers' beliefs and their classroom practices. Video and interview data were transcribed and read by the first author and an independent specialist in early mathematics education. High consistency was obtained between the two raters.

RESULTS

Thompson (1992) noted that the studies of teachers' beliefs and conceptions have focused on beliefs about mathematics or beliefs about teaching and learning, or both. According to Ernest (1989) and Schoenfeld (2001), teachers' beliefs can be investigated from several aspects: teachers' views of the nature of mathematics, their views of its teaching and learning, their past experiences in learning and teaching mathematics as well as the cultural beliefs and values that shape their teaching. In the following sections we attempt to illustrate some of these aspects with respect to the teachers studied.

Teachers' views of the nature of mathematics

Although teachers might not be aware of their own beliefs about the nature of mathematics, they actually hold beliefs and values that may play a significant role in shaping their approaches to teaching and patterns of instructional behaviour (Nickson, 1992; Thompson, 1992). The interview and questionnaire data showed that all three sampled teachers held very similar views about the nature of mathematics. This can broadly be described as the "static" view of mathematics knowledge, which believes that mathematics is a product that is discovered, not created (Ernest, 1989; Thompson, 1992). It has been suggested that mathematics teaching adopting this view is characterized by skill drilling in arithmetic operations and emphasising standardized calculating procedures and accurate results (Thompson, 1992). This is reflected in the following comments:

There are a lot of formulas in mathematics that you have to memorize... When you are sure of how to use the formulas, you can get the answer... More practices with the formulas will enable mastery of specific kinds of mathematics calculations. (K3 teacher)

[Mathematics] is fixed. To me, that means the result, the answer is fixed ... There is more chance to succeed. If they [the children] got one hundred marks [in maths], they are very excited... It is comparatively more difficult to get full marks in other subjects. (P1 teacher)

Teachers' attitudes towards mathematics

In addition to their views on the nature of mathematics, there was also a consistent attitude displayed by all three teachers. As noted by Comiti and Ball (1996), elementary mathematics teachers usually have little post secondary subject study and thus are not subject experts. Therefore, it might not be a coincidence that all the sampled teachers claimed that they did not do well in their own mathematical studies. The sentence "I am weak in mathematics" can be found in every interview of both primary and pre-primary

teachers. They did not have very positive attitudes towards studying mathematics themselves.

I don't like mathematics. Whenever I think of it, I hate it! (K2 teacher)

Teachers' negative attitudes are likely caused by their own experiences in learning mathematics. Both primary and pre-primary teachers reiterated that they learnt mathematics in a very traditional way, usually involving the drilling of mathematical symbols and reciting mathematical formulae.

To me, [mathematics] is boring. I don't like mathematics. When I was young, I learnt mathematics in a very traditional way... The teacher was not using any activities... All I know is to recite formulas or to calculate with calculators. (K3 teacher)

My feelings are that mathematics is something very difficult... [What my teacher looked for] were correct answers. We had to do a lot of exercises mechanically and to get the correct answers without knowing why... The way of drilling mathematics is not applicable today. It was painful. (P1 teacher)

Teachers' views of mathematics teaching and learning

However, negative experiences in learning mathematics *may* have a positive impact on teachers' beliefs about the appropriate way to teach the subject. The three teachers were very keen on building children's positive attitudes towards mathematics and cultivating their interest in the subject. They were enthusiastic towards mathematics teaching, hoping that children will not learn to hate the subject as they did.

I want children to get involved in the subject. I know some of them don't like mathematics. I will encourage them. (P1 teacher)

They were eager to motivate children and arouse their interests and were also well aware of current trends in mathematics teaching and learning (advocated by the Education Department in Hong Kong and in their own training programs) such as learning through play, using concrete manipulatives, stressing problem-solving, discussion and logical thinking.

[I have learnt to] use games and activities to teach. (K3 teacher)

Activities, discussion, play, open-ended problems [are the current teaching methods]. It is not passing knowledge to children any more. (K2 teacher)

It is a training to change my attitudes of teaching mathematics; using games and play to teach mathematics. (P1 teacher)

From the questionnaire and interview data it appeared that the teachers were equipped with pedagogical knowledge to enable them to transform and represent mathematical knowledge for teaching. However, the videotaped classroom images showed that the teachers were implementing them in very different extent and depth.

The lessons and the relationships with teachers' beliefs

1. The pre-primary lessons

Integrated learning was the main organisational approach in the kindergarten school. There would not be any specific time slot allocated to teachers teaching mathematics or children learning mathematics individually or in groups. Mathematics learning took place not only in large group teaching and group times but also integrated with other activities

such as physical exercises, music activities and during daily routines such as queuing up to washroom, waiting time and morning exercises.

Figure 1 shows the time children spent in each kind of work in the lessons in K2 and K3, for approximately three hours each day. Teachers started and ended the day at different times, accounting for the differences in total time the video captured. Normally, teachers introduced new concepts during large group teaching, followed by instructing the children about tasks they have to finish during group time or at home. Children then finished their work according to their speed during group times. They were free to choose other activities or play with other materials available in class after finishing their assigned work. Activities were used in both large group teaching and during group times to motivate children. The design of many activities were targeted at helping children to find the “correct answers”. In this respect, beliefs about mathematics were consistent with teaching. Nevertheless, although mechanical drilling was also evident, the pre-primary lessons appeared to be generally activities-based, stressing the relation between arithmetic statements and real life situations. The pre-primary teachers seemed to be trying to implement their pedagogical beliefs despite some other constraints, such as school schedules, parents’ aspirations and so on. A typical example concerned playing a game which resulted in all the possible pair-bonds for a sum of 8 being discovered. Overall, a consistency between beliefs about teaching and classroom practices was clearly identified.

Figure 1 Children's activities in pre-primary lessons

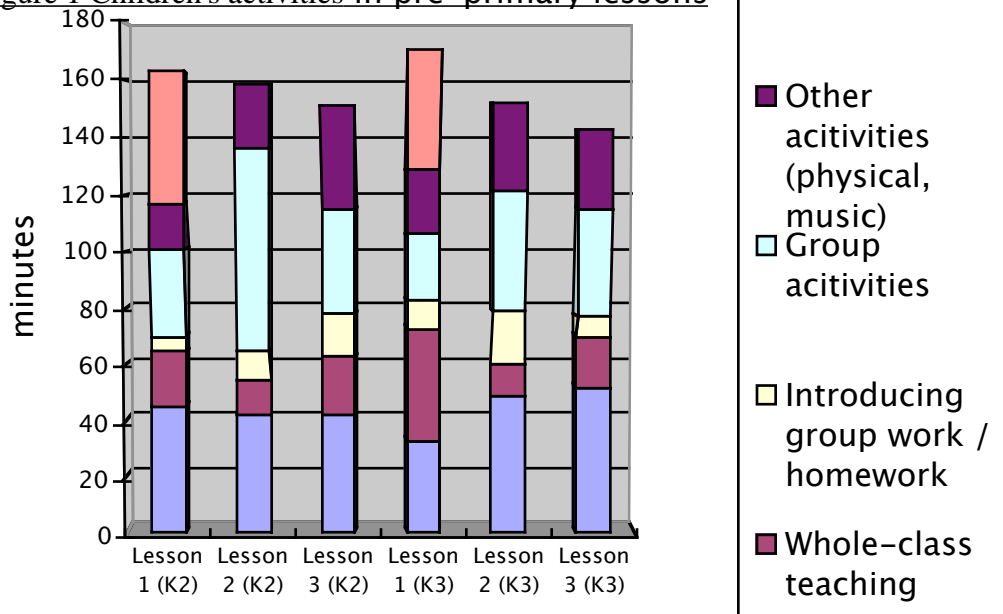

2. The primary lessons

The Primary lessons usually last for 35 minutes each. Figure 2 shows the modes of teaching adopted in the three mathematics lessons. Large group teaching appeared to be the dominant mode of teaching, accounting for almost 80% of the time in the lesson. As the video data revealed, the teacher mainly taught according to the textbook. The script of

a lesson usually began with a review of previous work, followed by the acquisition phase. After introducing the basic concepts, children were usually asked to do consolidation work, often in the form of written exercises in the textbook. Teachers would check answers with children to make sure that the answers were “correct”. In this respect, the teacher's beliefs and practice was consistent.

Figure 2 Modes of teaching in Primary 1

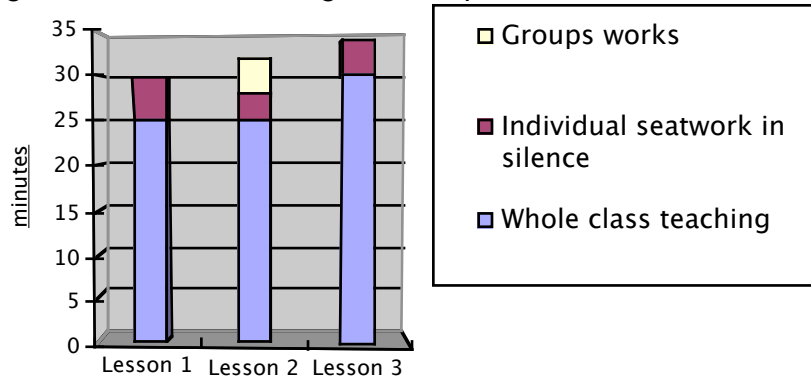

On the other hand, video images revealed a technique-oriented approach; a repeated drilling of verbal counting skills and manipulation of abstract numerals on the blackboard. This was quite contrary to the teacher's professed beliefs about the best way to teach mathematics. Some games and activities were introduced but a very limited time was spent on them. Instead, pencil and paper work dominated. It appeared that there was a gap between what the teacher professed and what was being practised.

Teachers' awareness of the relationship between beliefs and practices with the help of video extracts

By using video extracts during the second interview, teachers were able to identify the degree of consistency between their beliefs and their instructional practices. Both pre-primary teachers found that their beliefs and practices were quite consistent although they admitted that there were pressures from parents, and sometimes the school, pushing them to adopt a more skill-oriented teaching approach. However, they still found flexibility in implementing what they believe. These perceptions were in accord with the authors' observations.

On the other hand, the primary school teacher was not initially aware of the discrepancy between her beliefs and instructional practices. With the aid of video clips, the teacher became aware that she was not practising what she believes.

The video shows no relation with the current trend of mathematics education at all. I am just teaching arithmetic operations... My classroom practices are not the same as what I am thinking... I have to reorganize the whole curriculum. (P1 teacher)

The video clips served as a powerful stimulus to help the primary teacher become aware that although she professed belief in some current teaching ideas she was not implementing them. She also realized that she was not fully utilizing the teaching resources available in the classroom to avoid abstract teaching of symbols and numbers.

The teacher reflected on her own practices and provided reasons for the inconsistency. The first reason was discipline; she noted that it was necessary to train the children to get accustomed to daily classroom discipline.

In the beginning of the term, their discipline is not satisfactory. Thus, it is necessary for the children to sit and listen... Later, when I realize that children are interested in learning mathematics, I can use other teaching approaches. (P1 teacher)

The irony of her comment is that it is quite likely the children will *never* become interested while they are forced to just 'sit and listen'. Other reasons given were time limit, the textbook and preparing children for examinations.

I remembered that I am teaching in a hurry. Hurrying to finish [all topics] on the textbook... It was very tight. I have to hurry preparing children to sit for examination also. (P1 teacher)

The final reason the teacher gave was a lack of preparation.

Not enough preparation. I haven't thought thoroughly what to teach. I have to be frank, it is a failure. Actually, I can work harder on this. (P1 teacher)

Although the time spent in each kind of activity was not directly comparable because of the different teaching approaches, it was quite clear that the pre-primary teachers were practising what they believe whereas the primary teacher was not. These preliminary findings appear to validate Vartuli's results (described earlier) but in the Hong Kong context.

DISCUSSION AND ANALYSIS

One of the problems associated with research on beliefs and practices is to distinguish between genuinely held beliefs and professed 'beliefs' that may simply be rhetoric. The latter may be an expression of what the teacher thinks he/she *should* believe, especially related to current curriculum trends. All three teachers in this study were well aware of the pedagogical approaches advocated in their teacher training programmes and in the guides issued by the government Education Department. However, this study shows that the primary teacher's professed beliefs in such approaches was not reflected in her instructional practice. One interesting comparison can be made between two of the teachers' comments:

Children will have a deeper understanding by manipulating concrete materials themselves. It is necessary for children to experience before they understand (K2 teacher)

Especially for lower primary children, they need to compute more in order to master the mathematical concepts (P1 teacher)

These two comments vividly illustrate a fundamentally different belief about how children learn mathematics. For the K2 teacher, concrete experiences come *before* understanding whereas the implication in the P1 teacher's comment is that computational skill comes first. (It is also interesting that she does not use the word *understanding* related to concepts, but rather mastery). Nevertheless, we should not infer from this that the primary teacher does not also believe that activities and games can be important in learning, as she professes. All three teachers commented in their interviews on the constraints on them being able to implement their teaching beliefs. We have already seen

some of these for the P1 teacher. A frequent comment from all three concerned parental pressure.

Parents are looking for children's marks only. They don't bother whether their children understand or not. Parental expectations are critical in influencing my approach to teaching. (P1 teacher)

[Parents] are concerned about children's assessment results very much. I have to follow the schedule of the school as well as the expectations of the parents. (K3 teacher)

However, perhaps the most significant factor concerning the comparison between the pre-school teachers and the primary teacher lies in the constraints imposed by entry into the 'formal' education system. For example, a timetable of thirty-five minute lessons (common in Hong Kong) might not be long enough and flexible enough for teachers to allow children to have hands-on work after large-group teaching. Moreover, different subjects being taught by different teachers (again common) does not easily allow flexible handling of time. In addition, the fixed syllabus and the adoption of specific textbooks in primary schools imposes additional constraints. By contrast, pre-primary school teachers generally use the whole three-hour teaching time, except for some special subject teaching such as English (Figure 1). This longer and continuous time slot allows teachers to have flexibility in arranging different activities for children. In addition, since pre-primary schools are considered as a "preparatory stage" for formal schooling in primary school, there is no prescribed syllabus. Although the expectation of parents on an academic-oriented teaching content is substantial, the teachers in this study did manage to adopt teaching strategies in line with their beliefs. However, further study of other teachers in kindergarten and primary schools will inform us whether or not the pattern discussed in this article is indeed a common one.

References

- Comiti, C. & Ball, D. L. (1996). Preparing teachers to teach mathematics: a comparative perspective. In Bishop, A. J. (et al.). (Eds.). *International handbook of mathematics education*. (pp. 1123-1153). Dordrecht: Kluwer Academic Publishers.
- Ernest, P. (1989). The knowledge, beliefs and attitudes of the mathematics teacher: a model. *Journal of Education for Teaching*, 15(1), 13-33.
- Fang, Z. (1996). A review of research on teacher beliefs and practices. *Educational Research*, 38(1), 47-65.
- Nickson, M. (1992). The culture of the mathematics classroom: an unknown quantity. In D. A. Grouws (Ed.). *Handbook of research on mathematics teaching and learning* (pp. 65-97). New York: Macmillan.
- Pajares, M. F., (1992). Teachers' beliefs and educational research: cleaning up a messy construct. *Review of Educational Research*, 62(3), 307-332.
- Schoenfeld, A. H. (2001). Mathematics education in the twentieth century. *Education across a century: the centennial volume*. Illinois: NSSE (National Society for the Study of Education).
- Thompson, A. G. (1984). Teachers' conceptions of mathematics. *Educational Studies in Mathematics* 15, 105-127.

- Thompson, A. G. (1992). Teachers' beliefs and conceptions: a synthesis of the research. In D. A. Grouws (Ed.). *Handbook of research on mathematics teaching and learning* (pp. 127-146). New York: Macmillan.
- Vartuli, S. (1999). How early childhood teacher beliefs vary across grade level. *Early Childhood Research Quarterly* 14, (4), 489-514.
- Yelland, N., Butler, D. & Diezmann, C. (1999). *Early mathematical explorations*. United States: Pearson Publishing solutions.

FACTORS MOTIVATING REFORM: LEARNING FROM TEACHERS' STORIES¹

Azita Manouchehri

Central Michigan University

In current study we interviewed 21 mathematics teachers who aspired to reform-based mathematics instruction. It was our hope to establish whether there were common traits among this teacher population, which could have influenced their supportive disposition towards innovative instruction. The participants shared several characteristics. (1) They were confident in their ability to control student learning and possessed a detailed vision of the type of teaching that could advance student learning. (2) They held strong philosophical views on the role of education in general and of mathematics in particular, they believed them to be apparatuses for social change. They assumed teaching as a moral and ethical act and themselves as change agents. (3) They viewed their implementation of the Standards as work in progress.

INTRODUCTION

Reform documents such as Professional Teaching Standards (1991) and Principles and Standards for School Mathematics (2000) suggest that mathematics teachers should engage all students in learning more and better mathematics. Despite the wide spread endorsement of these Standards by educational researchers, reformed practice remains a novelty in school settings (Wilson & Ball 1996). It is widely accepted that teachers' reluctance to conform to new methods of teaching is due to their limited knowledge of mathematics or deeply held beliefs about mathematics as a didactic discipline that is best learned through direct instruction (Putnam & Borko 2000). Current challenges in mathematics education include identifying those elements that facilitate teacher development, designing strategies that reach and impact teachers, and documenting the process of change as it occurs in school settings (Anderson 2001). Although there are significant gaps in our knowledge of the mathematics education reform process and intricacies associated with it, the one most profoundly visible is the absence of an understanding of those factors within the teacher that motivate their commitment to instructional change. Elsewhere we have argued that the available body of research in mathematics education represents the researchers' assessment of elements that contribute to the teachers' choice of pedagogy and their rationale for supporting or opposing mathematics reform (Author 2002). Research studies that reflect teachers' own perspectives on issues concerning standards-based practice are rare. A study of innovative teachers can provide insight into the phenomenon of teacher thinking and assist in isolating factors that enhance, rather than impede teacher development (Goodson 1996). The current research pursued this inquiry. The overarching goal of our research was to better understand mathematics teachers and their motives for supporting Standards-based practice. Two questions guided our inquiry:

¹ This research was supported by the office of the President at Central Michigan University for the project, "The Practice and Research of Mathematics Reform: Listening to Teachers' Voices," (PRIF 174-01).

1. What features seem common among teachers who claim strong support of current efforts for reform in mathematics teaching?
2. What factors seem to contribute to the teachers' thinking regarding their support of reform recommendations?

METHODOLOGY

Participant selection

Initially and as a part of a much larger research study in which we aimed to elicit high school mathematics teachers' views on standards-based curriculum and instruction we surveyed 400 high school teachers in Michigan (Author 2002). We asked the teachers to rate their confidence with new instructional roles and techniques suggested for their practice. We also asked teachers to comment on their beliefs about practices supported by various reform documents. For the purpose of the current research we wanted to study only those teachers who were strongly supportive of Standards-based teaching. Following classroom observations of 39 teachers who met the criteria, we selected twenty-one teachers to serve as participants for this study. Seven of these teachers taught in rural, nine in suburban, and five in urban school districts. Eleven of the participants were male and ten were female. Four of the participants were of African American Heritage, three of Asian, and the remaining fourteen were white. The teachers' average teaching experience was fifteen years. Three teachers had less than seven years of experience.

Data collection and analysis

Data collection for the study was in the form of interviews with teachers. We met with each teacher individually and in her/his school. Each interview session lasted approximately four hours. Interviews were audio-taped and later transcribed. During the individual interview session, each teacher was asked to comment on two issues:

1. Their views on the recommendations of reform, what they found difficult to implement or those they found easy.
2. Factors that they felt contributed to their assessment of these recommendations

The subsequent discussions were guided by teachers' reactions to the topics listed above and as we tried to gain a better understanding of their motives and thinking. In carrying out the interviews and in analysis of data we used the method of essence (Goodwin & Witz 1998), a qualitative research approach. The aim of this methodology is twofold:

1. to develop deep analytical insight into the phenomenon of teacher's thinking situated in the teacher in connection with his/her practice
2. to develop portrait of the individual teacher to communicate the deep-seated coherent unified essence of one's actual practice.

The emphasis throughout the entire period of data collection and analysis is on sympathetic sharing, a commitment to seeing the phenomenon as it is and seeing its "nature" and "essence." The goal of this methodology is to compile themes that emerge from each interview and to build a theoretical model based on the common themes that surface from various data sources (Smith 1994). In accordance with this design, once all interviews were completed, teachers' responses were categorized according to the common themes that emerged from their discourse. Although those features that were unique to each of the teachers were noted, in preparation of the final report we relied solely on common attributes among the participants.

FINDINGS

The participants shared several characteristics. (1) They were confident in their ability to control student learning and curriculum. (2) They held strong philosophical views on the role of education in general and of mathematics in particular, they believed them to be apparatuses for social change. They assumed teaching as a moral and ethical act and themselves as change agents. (3) They viewed their implementation of the Standards as work in progress. These various aspects of teachers' thinking were deeply intertwined. In fact, intense interactions among them influenced the teacher's pedagogy and their instructional goals.

Confidence & vision

Studies of teacher efficacy—teacher's confidence in their ability to monitor student learning—have provided support for its positive influence on teachers' behaviors in classroom. There is evidence that confident teachers tend to be risk takers (Saklofske, Michaluk, & Randhawa, 1988; Hoy & Woolfolk 1993). It has also been reported that confident teachers experience greater success in maintaining high standards of practice (Spector 1993). The same personal traits were evident among all our participants.

All twenty-one teachers held a high level of confidence in their ability to control their curriculum and the learning of students. Regardless of the setting in which the teachers worked, each felt in control of the conditions of their schools. These teachers felt they were successful in providing learning opportunities that allowed students to overcome not only cognitive barriers to learning mathematics, but also the social and economic obstacles with which they struggled inside, and outside schools.

I know I can help them learn, I know it is up to me to help them grow into critical learners. I know I can do that. I have had students in my classes that everyone else had given up on and yet I could reach them. I taught them good mathematics. These kids wanted to know why things worked and retaliated against education when people refused to answer them. It is about making it work and I know all the years of experience I have with me is telling me that what I am doing is right, I don't care if the principal is not happy or the parents come here and complain. I can handle them. (James)

A number of my former students have gone on to Ivy league colleagues. They are successful in their careers and they call me even today and tell me that I had an impact on their lives. I know I work in a setting where it is easy to give up, to say these kids will never go to college, that in all likelihood they may not even finish high school, but as long as they are in my class I know I can teach them, and I can teach them good mathematics. I can teach them enough mathematics that if they choose not to go to college it will not be because they do not know their stuff. (Tom)

The teachers' confidence was substantiated by their trust in their own ability to make sense of mathematics. All teachers seemed to possess an imagery of the Standards-based classroom as well as those teaching actions that facilitated its creation. An articulation of these visions was a prominent part of the teachers' discourse as they described their own instructional practices and their goals. Although for six of the teachers these visions derived from personal and first hand encounters with innovative instruction as learners, for others they were the result of a lack of satisfaction with traditional practice they had either experienced, or witnessed.

When I was in grad. School I worked with Pf. X who was a student of Moore. In his class we were expected to build mathematics, to state and prove theorems, he did not let us consult with references, he did not let us look at books, he wanted us to create knowledge. This was like 20 plus years ago. Even before Standards came about. After that experience I knew how I wanted to teach. I knew that was exactly what I wanted to do with my own students but it took me years to learn to make the change. When the Standards, the first set, came out I could relate to what they said, I had a vision of what they wanted to accomplish. That is what I strive for daily. Some days I am very successful, and some days I am not very successful (laughs) (Laticia)

My entire mathematics education was stand and deliver. When I started teaching almost ten years ago I did not know what kind of teacher I would be but I knew what kind of teacher I did not want to be. I knew I wanted to get my students to think. The problem then was that I did not have a lot of ideas, I mean strategies about how to do this. I know I made a lot of mistakes. I am still work in progress, you know. I still have a lot to learn, but knowing what I did not want to be, made me hungry for finding my own identity (Cara)

All teachers valued Standards for supporting their own visions of mathematics learning and teaching, and for providing curricular models they could use to realize these visions. The utility of the Standards for them, then, was not in their capacity for refining their views, but for enabling them to fulfill their own goals.

The teachers' view of self was profoundly influenced by their philosophies on the role of education in a democratic society. These philosophies also shaped their identities as mathematics teachers and the knowledge they considered worthy of sharing with learners.

Philosophical views on the role of education and children

Goodlad (1984) characterized teachers as stewards to schools and society. To him, teachers are stewards because they look after the school as an educational entity committed to the advancement of both its students and a larger human ecology. In this role, the teachers have responsibilities beyond their respective classrooms. Such interpretation of teaching determines, to a large extent, the capacity of teachers to renew themselves and to respond thoughtfully to the efforts of others to reform instruction. The teacher participants in this study espoused such view of teaching, and were driven by a "mission" to serve as change agents within their schools and in society at large.

All teachers appeared to assume educating children as a "calling," and a moral act. Their efforts at improving their own teaching were not motivated by professional expectations set by administrators, but by their personal philosophies on what it meant to be an educated individual and the role of schools in nurturing informed citizens. All teachers believed education should raise social awareness among learners. While for some of the teachers these philosophies were rooted in their religious beliefs, for others, they were provoked by their political interests. In both cases, these beliefs influenced what the participants considered as worthwhile mathematics knowledge for students to acquire. All teachers believed in mathematics as an apparatus for resolving social problems. They also viewed teaching mathematics as an act of membership in a community that had the power to alter social norms.

I think mathematics is the most powerful tool for helping people overcome challenges in life. Of course literacy is really important but it is with mathematics that one can analyze

decisions, political decisions I mean, the information they read in the paper, it is with mathematics that they can see through lies. We chose to neglect it for decades, we believed that only the elite needed to know mathematics, that only the elite could learn mathematics. Standards now are saying, hey this is for everybody, they are redefining the elite. (Travis)

Do you really think we would have as many problems in society as we do now if people knew more math? See, poor kids don't get to college because of math, so, what happens to them? They end up in minimum wage jobs, and the cycle of poverty continues. We refuse to accept that we have a problem- we have a class system, and whether we want to believe it or not mathematics contributes to this class system. I hear other teachers say that we makes no difference, that these kids will never go beyond the basics. They say let's teach them enough so they could balance their checkbooks. I say, hey that is not enough, we can do a whole lot more and that is what Standards are saying too. (Bobbiesue)

All teachers believed the primary function of their work was to help students develop the skills that either permitted them access to higher and better social standing, or greater social awareness. Naturally, the teachers' assessment of the Standards was filtered through these philosophical beliefs. Indeed, teachers' particular interests humanized the Standards to simultaneously serve two specific functions for them; an academic, and a political function. On the one hand, teachers seemed to have relied on the Standards to organize the curriculum they covered in class. On the other hand, they used them to legitimize their own choices in the presence of resistance or opposition they faced in their respective school.

This is the first time in education that we have made a commitment to educating ALL children, the first time ever. The 60s movement was not about all kids... But this one is. I support that. I am tired of all these people who think education is only for rich kids. I think a lot of teachers have used that statement to reduce academic standards and rigor. They say, "these" kids won't go to college, so they don't need this math class or that topic. Now, we have a document that says, hey it is your professional obligation, if nothing else, it is your professional obligation to teach "these" kids. That is the value of Standards for me. It gives me hope that we are finally talking about issues that matter.(Kyle)

Up till four years ago we used Saxon books in my school. I fought and fought trying to get them out of classrooms. No one listened. The excuse was that we were not up for textbook adoption, we can not endure the cost, we cannot do this, and we cannot do that. So, finally five years ago I was on the textbook selection committee. I went in having done my homework, I went in with the Standards and all, with examples from the addenda series. I said, this is what we ought to be doing, not Saxon. It took me a lot of campaigning to get the books changed. I must have called 500 people, from the superintendent's office, to parents, to school board—I mean everybody (laughs). We finally got new books.(Derek)

In discussing their views on the Standards all teachers shared stories of what they had observed of students' accomplishment in the presence of practices that paralleled them. In talking about students, they all conveyed a deep respect for children's ideas and their individuality, compassion for the students' need to be convinced and intrigued, and a conviction that by allowing children autonomy they would take ownership of mathematics.

I like giving my students choices, I like for them to think of this class as their own. So, if I ask them to do something and they say, no, I say, okay, how can we reach a healthy balance between what you want to do and what I think you should do. If we are serious about raising

critical thinkers, if we are serious about educating these kids then we must begin to reconsider how we interact with them. My students are more curious about learning, about mathematics than other teachers' students because they know I expect them to be curious.(Samantha)

A major problem in our society is that we think young people are incapable of making decisions. In my experience, in all the years of teaching, I have learned that if I provide fair choices, they want to learn. But if I try to force it down their throats then they retaliate. So, there are times that I tell them, hey you need to do this cause I say so. There are times that I say, hey you ought to do this cause my principle tells me you have to do it, and then there are times that I tell them: quite frankly I have no idea why you need to learn this—I have this relationship with my students, it is a give and take kind of relationship, like any other relationship in life. I tell them that too, that sometimes you have to do what you like and sometimes you have to do what you really don't like. We get beyond that quickly. They know I appreciate them and I know they appreciate me. (Laticia)

DISCUSSION

There is an increasing body of practitioner research and writing about the ways in which teachers' personal and professional selves evolve within the domain of practice. In mathematics education, examples of how the practitioners' evolving knowledge of children and how teachers' subject matter understandings change as they teach have been developed by teacher researchers (Ball 2000, Lampert 2001, Chazan 2000). This body of work portrays teacher as one who is sensitive to immediate needs of students while keeping an eye on a mathematical horizon (Ball 2000), the curriculum that needs to be shared and the opportunities for learning that need to be established for all learners. Moreover, this body of work portrays teaching as a complex network of decisions whose nature is dependent upon the teachers' ongoing assessment of cognitive and emotional needs of each individual learner, and the social dynamics of the classroom (Lampert 2001). The finding of the current work, while substantiating the theories of these researchers on the centrality of the teacher's reflective disposition on her ability to sustain innovative practice, extend their theses by proposing that analyzing teachers' work solely through the lens of their enacted curriculum, or mathematical goals may be limited.

Data indicated that political views and philosophies of teachers explicitly impacted their pedagogical choices, and the value they placed on the recommendations for reform as proposed by the Standards. Further, teachers' professional values and belief systems derived from a variety of sources, but especially from lived experiences as intellectual beings with missions and goals. The teachers' personal preferences defined their epistemological and pedagogical standpoints.

For the teachers in the study teaching was about learning, as much for them as for the learners with whom they worked. This view of teaching not only substantiated their confidence in their ability to influence student learning, but also their ability to be risk takers in classroom. This result certainly supports the findings of previous research which recognized teacher confidence as a powerful force in learning (Bandura 1982, 1997). We further argue that teacher confidence might be a significant variable in teachers' adoption of innovation. Moreover, based on the results of the study we propose that teachers' confidence might be closely tied to their philosophies about education. At this point,

much remains to be learned about this important aspect of teachers' work and how it develops in and through teaching.

These results have immediate implications for mathematics teacher education. In what follows we will elaborate on a few of these points.

TEACHER EDUCATION EFFORTS

Current design of many professional development activities perceive, and treat, teachers as consumers of a set body of knowledge about either a particular curriculum, or instructional technique, without taking into account their philosophies or personal interests and goals. Uniform inservice activities are designed and implemented without much attention to teachers' diverse orientations or intellectual needs. Discussions concerning reform frequently remain within a framework void of its social implications. This narrow approach to professional renewal naturally provides a superficial context for engagement or debate about reforming education. Perhaps, the lack of sensitivity to this fundamental issue accounts, at least in part, for the lack of widespread success of professional development activities designed for teachers. Professional development opportunities need to assume teachers as knowing agents who pick and choose aspects of reform according to the philosophies that inspire them. As Goodlad (1984) argued teaching can not be understood exclusively as instructing, as an activity that takes place behind the classroom door. Therefore, when we seek to change what teachers do behind the classroom door, we might experience far more success examining roles conceptually connected to instructing, rather than focusing exclusively on instructing itself. Professional development opportunities must provide teachers with an understanding of both the conditions under which, and contexts in which, innovation may enhance teaching, enrich children's lives, and cultivate a more profound social change.

Indeed, to fully appreciate the power of mathematics reform and of the Standards documents, a teacher must have a deep and thorough understanding of the nature and purpose of education in a free society. The Standards are less a matter of maintaining "active" classrooms, or demanding a more rigorous mathematics curriculum (although these are not unimportant features) than it is a matter of serving in the joint aspiration of making mathematics, and education, meaningful to children's lives. To have this understanding of the mathematics classrooms as a place engaged in education is to incur obligations beyond instructing. To help teachers develop such understanding, mathematics teacher educators need to go beyond accentuating the value of the Standards as sole academic documents, and expand on their capacity for social reconstruction.

The central tenet of the Standard documents is the need to increase mathematical literacy of children (Schoenfeld 2002). Inherent in the Standards' notion of mathematical literacy is the acquisition of skills required to live in civil and modern society, the competence to contribute to knowledge as well as benefit from it, the ability to think critically and act deliberately, the empathy that permits individuals to hear and thus accommodate others. The cultivation of these qualities make exceptional demands on teachers, demands that differ from those made on persons in most other occupations. Fulfillment of these demands requires that teachers understand the qualities of a citizen as well as the procedures of citizenship, and that they fully meet the conditions imposed by both. To

help teachers grasp these demands and to realize the vital role they play in productive functioning of our society must become a priority in mathematics teacher education at both preservice and inservice programs. This requires that those of us responsible for educating current and future teachers to expand our own horizon relative to the role and value of Standards in democracy. It also demands that we begin to think more systemically, and even harder, about what mathematics education reform is about and what the Standards are for.

In recent years much has been written on factors that impede teacher's ability to implement instructional change. In fact, some researchers have documented that even teachers chosen as exemplars of reform regress from the ideal, displaying the height of reform one day while regressing to traditional methods the next (Senger 1999). According to the teachers in our study, such was the case for them. However, they believed it naïve to judge their work as praiseworthy or blamable without taking into account their overall goals and long term plans. Indeed, it might be attractive to think that teachers should engage in innovations that make dramatic changes in their existing practices. Additionally, one might assume that the innovations that include maximum distance from traditional practice will have the greatest impact on student learning. However, innovations that are the most distant from the teachers' existing practices are less likely to succeed. Given these findings, we argue that to facilitate change in classrooms, professional development opportunities for teachers must take on, to put it in teachers' own words, an "evolutionary" approach to teacher education to have any impact on teachers' practice, or to be of any value to them. Moreover, teacher education must assist teachers to develop as evolutionary practitioners.

Evolutionary teaching is one that changes and evolves the teacher in profound ways, and over time. To view teaching as evolutionary, is to abandon the naïve pursuit of a rapid, fundamental transformation of one's practice but to see it as incessant process of refinement and growth. To be an evolutionary practitioner is to view learning new things, or old things in new ways, as a means to improve one's practice. In this role, the teacher sets out to learn something not only to teach that thing, but to change oneself in order to help students. For a teacher to be evolutionary is to understand how one's own learning impacts learners, not just inside the classroom, but in life. To fully embrace such view of practice, teachers must learn to view teaching as more than instructing children, and teaching mathematics as more than the act of sharing mathematical procedures. When we think of the teaching mathematics solely in terms of instructing, or exclusively about the transfer of subject matter, we may easily lose sight of the fact that the teaching is also about learning. By orchestrating situations in which the teachers recognize the value of evolutionary practice, and by assisting them in taking small and yet meaningful steps toward evolving their own knowledge, they will be in a better position to grasp the true meaning of reform, and will have a better chance of sustaining innovation in their classrooms.

References [Please contact the author at Azita.M@cmich.edu for a list of references]

DIFFICULTIES IN VECTOR SPACE THEORY: A COMPARED ANALYSIS IN TERMS OF CONCEPTIONS AND TACIT MODELS

Mirko Maracci

Dipartimento di Matematica – Università di Pisa, Italia

This paper reports on the first stage of a research project still in progress aiming at identifying undergraduate students' difficulties and errors in solving linear algebra problems. Some students' difficulties related to very basic notions of vector space theory are shown and discussed with respect to both Balacheff's theory of conceptions and Fischbein's theory of tacit models. Finally a brief discussion concerning the complementarity of the two frameworks is proposed.

INTRODUCTION: THE CURRENT STATE OF RESEARCH IN LINEAR ALGEBRA EDUCATION

As many researchers underline (Dorier, 1998; Harel, 1990; Tucker, 1993), the importance of linear algebra in many fields of mathematics, science and engineering is widely acknowledged by both mathematicians and scientists, who consider linear algebra as an important mathematical prerequisite for undergraduate students in science and technology. Coherently linear algebra courses are basic for a wide variety of disciplines: mathematics, physics, computer science, engineering and so on. Nevertheless up to the 90's linear algebra has not seemingly raised the interest of the community of the researchers in math education. It is only in the last decade that studies on this subject have been carried out and all of them highlighted a number of difficulties in teaching and learning linear algebra.

Two years ago Jean-Luc Dorier collected the most advanced studies in linear algebra education to present the state of research on the subject (Dorier, 2000). A complete overview of these researches is out of the goals of this brief report, we only would like to highlight one aspect shared by many of these studies, that is the effort of describing and interpreting the students' difficulties and errors in terms of very general paradigms. For instance Harel (2000) shows that the teaching of linear algebra usually violates fundamental didactical principles, that is the concreteness and necessity principles. Dorier and other French researchers (2000) point out what they call "obstacle of formalism" as the main source of students' difficulties and claim the need of explicitly taking into account the "formalizing, unifying, generalizing and simplifying nature of the concepts of linear algebra" when teaching linear algebra.

But formalisation, unification and generalisation are characteristics of any mathematical theory, and the above didactical principles are usually violated in any purely axiomatic approach to a mathematical field. Therefore, notwithstanding the undeniable progresses which these studies brought, we think that the adopted approaches could lead not to adequately take into account the specificity of linear algebra and of its fundamental notions. In particular seemingly no researches have been carried out according to paradigms like that of "misconceptions" (in the sense of Confrey, 1990) nor that of

“concept images” (Tall&Vinner, 1981) or of “epistemological errors” (Bachelard, 1938), which on the contrary are strictly related to the nature of the specific notions and provided efficient tools for analysing students’ difficulties in other mathematical domains (e.g. calculus).

In this report we are going to describe and interpret students’ difficulties in terms of *conceptions* and discuss the potentialities of this paradigm.

THE CK ϵ THEORY¹ BY BALACHEFF

Within the theory of situations (Brousseau, 1997), the ck ϵ theory - conception, knowing and concept - is an attempt to model “students’ knowing of mathematics under the constraints of acknowledging both their possible lacking of coherency and their local efficiency” (Balacheff&Gaudin, 2002, p.1).

The problem of elaborating such a theory is solved taking into account and formally defining the notion of “conception”, which has been widely used as a tool in didactical analysis, but which has been used most often as a common sense notion without any explicit definition (Artigue, 1991).

Starting from the definition of concept given by Vergnaud (1991), a formal definition of conception is proposed. Without adopting the formal language of the theory, one can say that a *conception* is characterised by:

- a set of problems, the sphere of practice of the conception;
- a set of operators, i.e. a set of actions performed to solve the problems;
- a representation system, which allows to represent both problems and operators;
- a control structure, which allows “to decide weather an action is relevant or not, or that a problem is solved” (Balacheff&Gaudin, 2002, p.7).

The three first components are those identified by Vergnaud in order to define a concept, to these components the control structure is added. According to this theory a conception may be seen as the instantiation of a knowing which has proved to be efficient with respect to a certain domain (i.e. a certain set of problems). Once conceptions are defined, one can also formally define *knowings* and *concepts*, anyway we won't present here the complete modelisation which can be found in Balacheff, 1995 and Balacheff, 2000.

One main hypothesis is that one can describe and interpret what is called the *state of knowings* of a student and hence her/his difficulties in terms of conceptions.

OUR RESEARCH

The study presented in this report is the first stage of a research still in progress aiming at *identifying undergraduate students’ difficulties and errors in solving linear algebra problems*. More precisely, our study focuses on students’ difficulties and errors related to *basic notions of vector space theory*, e.g. linear combination, linear dependence/independence, generators.

¹ Balacheff speaks of *ck ϵ model* rather than *ck ϵ theory*, notwithstanding we prefer here to use the term *theory* in order to avoid any confusion with the term *models* as used in Fischbein’s theory of tacit models to which we will refer later.

Up to now our study involved five medium-high achieving students in mathematics in their first year undergraduation. Students have been individually interviewed after the end of their first semester in linear algebra, during which they were introduced, via an axiomatic approach, to the basic notions of vector space theory, and whilst they were attending a second more advanced one. Students were presented with three different problems to be solved in individual interviews; no time constraints was imposed over the problem solving sessions, which were recorded.

The analysis of the transcripts of the interviews highlights a number of students' difficulties concerning basic notions of vector space theory. In the following we will present some excerpts from students' protocols showing some of such difficulties.

The problem we will refer to during our discussion is the following:

Problem. Let V be a \mathbb{R} -linear space and let u_1, u_2, u_3, u_4 and u_5 be 5 linearly independent vectors in V . Consider the vector $u = \sqrt{2}u_1 - 1/3u_2 + u_3 + 3u_4 - \pi u_5$.

- Do there exist two 3-dimensional subspaces of V , W_1 and W_2 , such that $W_1 \cap W_2 = \text{Span}\{u\}$?
- Do there exist two 2-dimensional subspaces of V , U_1 and U_2 , which do not contain u and such that u belongs to $U_1 + U_2$?

The answer to both the questions is that such subspaces of V exist. In order to successfully approach the problem one might try to describe the conditions which the subspaces must fulfil in terms of their possible generators. For instance $\text{Span}\{u, u_1, u_2\}$ and $\text{Span}\{u, u_3, u_4\}$ verify the conditions posed in the former question and $\text{Span}\{u_1, u_2\}$ and $\text{Span}\{u_3 + 3u_4, u_5\}$ verify the conditions posed in the latter one; this is just one possible solution, it is not the only one.

None of the interviewed students succeeded in solving this problem. In the following section we will present some excerpts from the transcripts of the interviews and we will propose a first analysis in terms of Balacheff's theory of conceptions.

4. Protocols

For the sake of brevity we can not discuss here all the 5 collected interviews, so we present some excerpts from only 3 protocols. The difficulties we are going to discuss can be considered exemplar being shared by the other interviewed students.

Protocol A: Fra.

Fra has just correctly answered the former question of the problem and she is now approaching the latter. Since the very beginning she expresses the feeling that the answer to the second question is negative.

- (a) **Fra:** I think that it is not possible because u is linear combination of 5 linearly independent vectors... and if one can write it as... that is it should be an element which can be written as the sum of an element of U_1 and of an element of U_2 , and then it should be linear combination of at most 4 linearly independent vectors... now let's see

Then Fra seemingly faces the task of proving her assertion or at least of ascertaining its truth (“let’s see”, item 74). In fact she does not prove it, on the contrary her assertion is never put under discussion and it is used as the conclusive and decisive argument in her solution to the problem.

- 1 **Fra:** [...] I find that anyway u is written as linear combination of 5 linearly independent vectors... then I cannot write u with only 4 linearly independent vectors
- 1 **Fra:** anyway u is written as linear combination of 5 linearly independent vectors, then I cannot write it as belonging to this sum $[U1+U2]$

Protocol B: Jas.

Jas approaches the problem starting from the last question. One of her first remarks concerns the uniqueness of representation of the vector u .

- 2 **Jas:** [...] a vector u is given, such that $u = \sqrt{2}u1 - 1/3u2 + u3 + 3u4 - \pi u5$. It is written in a unique way
2. **Jas:** then... let’s see, I must... I find u in just one way

The uniqueness of representation of u leads Jas to state that u belongs to $U1+U2$ only if vectors $u1, u2, u3, u4$ and $u5$ belong to $U1+U2$ too.

- 3 **Jas:** [...] u has to belong to their sum $[U1+U2]$, let’s see. I don’t think that it is possible, because if I take... let’s see [...] in order to get that u belongs to their sum $[U1+U2]$ I have to find in this sum at least both $u1$ and $u2$ and $u3$ and $u4$ and $u5$ [...] but if $U1$ has dimension 2 then I get that it does not contain more than 2 linear independent vectors which I can suppose to be $u1$ and $u2$...

Starting from the above argument and from considerations concerning the dimension of $U1$ and $U2$, Jas supposes $U1 = \text{Span}\{u1, u2\}$ and $U2 = \text{Span}\{u3, u4\}$ and negatively answers to this question. She similarly approaches the former question of the problem and as a consequence she fails to solve it.

Protocol C: Ele.

Since the very beginning of the session Ele seems a bit confused: at item 4 she wonders whether the space generated by a single vector $[\sqrt{2}u1 - 1/3u2 + u3 + 3u4 - \pi u5]$ might have dimension greater than 3. Some minutes later (item 23.) something similar occurs when Ele represents the space generated by $u1, u2$ and $u3$ as $\langle \sqrt{2}u1 - 1/3u2 + u3 \rangle$ instead of $\langle u1, u2, u3 \rangle$.

- 4 **Ele:** I have to establish whether this one $[\text{Span}\{\sqrt{2}u1 - 1/3u2 + u3 + 3u4 - \pi u5\}]$... I mean, whether the subspaces generated by this vector $[\sqrt{2}u1 - 1/3u2 + u3 + 3u4 - \pi u5]$... if its dimension is greater than 3, then it does not exist
- 5 **Ele:** [...] I’m looking at... [she writes $W1 = \langle \sqrt{2}u1 - 1/3u2 + u3 \rangle$] ... I want $W1$ to be a subspace generated by $u1$... by $u1, u2$ and $u3$ [she writes $W1 = \langle u1, u2, u3 \rangle$]

In the meanwhile, Ele states that the basis of the searched subspaces ($W1$ and $W2$) have to be subsets of the set of the given vectors $u1, u2, u3, u4$ and $u5$.

- **Ele:** well... then... I do not know... the intersection between these two [subspaces $W1$ and $W2$]... then, the intersection between these two subspaces has to be generated by u and then it has to be a linear combination, then... a multiple, because we are dealing with only one vector $[u]$, it $[W1 \cap W2]$ has to be a multiple of this linear combination $[\sqrt{2}u1 - 1/3u2 + u3 + 3u4 - \pi u5]$

- **Ele:** then [...], if the dimension of these two subspaces has to be 3, then I have to take, in order to have 3-dimensional subspaces, I should have... a basis with three linearly independent vectors... now, I can choose such vectors only among these five ones [u_1 , u_2 , u_3 , u_4 and u_5] ...

Coherently with her assertion Ele only investigates the case in which $W_1 = \text{Span}\{u_i, u_j, u_z\}$ and $W_2 = \text{Span}\{u_p, u_q, u_t\}$ (i, j, z, p, q and t are integers less than 5) and thus she negatively answers the question. The same assumption and the same behaviour are at the core of the (incorrect) solution which Ele gives to the latter part of the problem.

A FIRST ANALYSIS OF THE THREE PROTOCOLS

As we underlined above, all the students failed in solving the problem (Jas and Ele failed to answer both the questions while Fra failed to answer only the latter). In this section we analyse the previously highlighted students' difficulties and errors with respect to the theoretical framework of conceptions.

In each protocol we may identify the source of students' failure in incorrect assumptions which underlie and affect students' search for the subspaces W_1 and W_2 , and U_1 and U_2 , that is:

- **Fra:** u is a linear combination of 5 linearly independent vectors then it can not be written as a linear combination of only 4 linearly independent vectors (see item 86.)
- **Jas:** in order to get that u belongs to $U_1 + U_2$ one needs that u_1, u_2, u_3, u_4 and u_5 belong to $U_1 + U_2$ too (see item 13.)
- **Ele:** the generators of the searched subspaces must be taken out from vectors u_1, u_2, u_3, u_4 and u_5 (see item 21.)

These *assumptions* are never questioned during the problem solving activity, on the contrary as we remarked above they guide students' activity and provide them with the ultimate criteria to answer the posed problem. So students' behaviours, their actions and strategies are strictly related to these assumptions. According to the $ck\emptyset$ theory these assumptions and students' related actions may be interpreted in terms of *controls* and *operators* (students' schemas). We could go further in our analysis and detect a more complete list of *operators* and *controls* related to the highlighted assertions in order to model the students' behaviours as conceptions. Moreover we could eventually use this list as a diagnostic tool both to describe these students' behaviours in solving more problems and to describe other students' behaviours in solving this same problem.

However directly following this direction could cause us to miss one important point of the whole framework. In fact the $ck\emptyset$ theory shares Brousseau's view that *errors are not only the effect of ignorance, of uncertainty, of chance, but also the effect of a previous knowing which was interesting and successful* (Brousseau, 1997, p.82). Going on in a so analytic and detailed analysis of the protocols could lead to excessively fragment students' behaviours (problems, operators, language, control); as a consequence we could not be able to answer the question:

- Which is the *interesting and successful knowing* related to the stressed errors?

In order to answer this question, most researches following the $ck\emptyset$ theory start from a re-examination of previous works carried out according to paradigms such as that of

misconceptions, of concept-images or the like which despite the differences with the $\text{ck}\phi$ paradigm offer a suitable ground for an *a-priori* analysis in terms of conceptions. The lack of such researches in vector space theory education opens the problem of answering this question directly on the basis of the collected data. In order to solve this problem we will change perspective and try to use Fischbein's approach in terms of tacit models.

THE THEORY OF TACIT MODELS BY FISCHBEIN

Starting from the assumption that mathematical concepts and operations are essentially formal and abstract constructs whose meaning and coherence are not directly accessible to us and which we can not "spontaneously" manipulate, Fischbein states that we need to produce mental models providing us with a directly accessible, unifying meaning to concepts and symbols (Fischbein, 1989).

"Generally speaking, a system B represents a model of system A if, on the basis of a certain isomorphism, a description or a solution produced in terms of A may be reflected consistently in terms of B and vice versa" (Fischbein, 1983, p. 121). Among the different kinds of models which Fischbein distinguishes – e.g. intuitive or abstract models, tacit or explicit, analogic or paradigmatic – we are mainly interested in tacit models. Being beyond direct conscious control they very often tacitly influence solution strategies during problem solving. "A person may be convinced that the object of his solving attempts is a certain phenomenon – the object of his interest – while his mental endeavors deal in fact with a model of it" (Fischbein, 1983, p. 203). Students' systematic errors might be due to the limits of a tacit model.

Among the characteristics which according to Fischbein tacit intuitive models share, let us quote: being a structural entity rather than an isolated rule, having a "concrete, practical and behavioural" nature, autonomy, strength.

ANALYSIS IN TERMS OF TACIT MODELS

In this section we analyse students' reported behaviours in the light of Fischbein's theory in order to investigate the possible sources of students' assumptions and to eventually find out any common aspects among them.

As far as Jas is concerned, we can notice that she initially insists on the uniqueness of representation of u (items 4. and 8.). In fact the representation of u with respect to u_1, u_2, u_3, u_4 and u_5 is unique, being these vectors linearly independent, but Jas seemingly extends this property deducing that u can be represented only in the given form. If u can really be represented only in the given form then vectors u_1, u_2, u_3, u_4 and u_5 are indispensable for describing u and as a consequence Jas's key-assumption appears well founded.

Differently from Jas, Fra does not give any explicit hint suggesting the origin of her assumption, notwithstanding let us underline how what we identified as key assumption in Fra's protocol may be interpreted in the same terms as before: if the representation of u is unique then u can not be written using less than 5 linearly independent vectors.

Can we interpret Ele's error in a similar way? At a first glance it seems that Ele's assumption has not the same source as those of Fra and Jas. In fact she seems to assume that the only subspaces of V are those generated by a subset of the set constituted by $u_1,$

u_2, u_3, u_4 and u_5 ². Is such assumption so different from Fra's and Jas's ones? We think that it is not the case. As a matter of fact the set of generators of a subspace of V has to be such that any vector of this subspace must be represented as a linear combination of the generators themselves. But if any vector of our space is represented in a unique way as linear combination of u_1, u_2, u_3, u_4 and u_5 and *if this is the only way it can be represented*, then the generators of a subspace of V can be taken only out from vectors u_1, u_2, u_3, u_4 and u_5 . Moreover note that Ele's initial confusion (see items 4. and 23.) seems coherent with this interpretation.

Then we might interpret Fra's, Jas's and Ele's errors as due to the same tacit model, that is *a vector can be represented as linear combination of other vectors in a unique way*. So, according to this interpretation the tacit model is a distortion of a basic widely used (both to prove theorems and to solve problems) and widely known property³, i.e.: *the representation of a vector as linear combination of a given set of linearly independent vectors is unique*, but the same vector can be represented in different ways when changing the set of linearly independent vectors.

CONCLUSIONS

We carried out our analysis with respect to both the $ck\phi$ theory and that of tacit models, which respectively allow us to *identify the fundamental controls and operators mobilised by students* in order to solve the problem and to give a unitary interpretation of students' errors *finding out a common tacit model* beyond students' behaviours.

Moreover the provided interpretation, in terms of tacit models, suggests that the highlighted operators and controls may be related to a same conception, concerning the representation of vectors as linear combination of a given set of independent vectors. We could roughly label this conception under the expression *a vector has a unique representation as linear combination of independent vectors*. As already remarked, coherently with Balacheff's view that errors might be interpreted as due to the functional inertia of a knowing which has proved itself by its efficiency in enough situations (Balacheff, 2000), the found out tacit model is a distortion of one of the most powerful and efficient tool in vector space theory, i.e. the uniqueness of representation of vectors with respect to a given basis. *The students' highlighted controls and operators may be seen as consequences of this tacit model*.

The combination of the two paradigms shows its power if didactical implication are considered, in fact the identification of the unifying conception based on tacit models focuses on the potential source of the highlighted difficulties which may be interpreted as a distortion of a fundamental vector spaces property. On the other hand a more detailed description of this model in terms of conceptions (problems, operators, representation system, controls) would facilitate the diagnosis of students' errors related to such a tacit model.

² Ele correctly observes that one can suppose that V is generated by u_1, u_2, u_3, u_4 and u_5 .

³ We are referring to the linear algebra lectures attended by the students involved in our study.

References

- Artigue M., 1991; Epistémologie et didactique, *Rech. Did. Math.*, v.10, n.2/3, pp. 241-285.
- Bachelard G., 1938; *La formation de l'esprit scientifique*. Paris: Vrin.
- Balacheff N. 1995; Conception, connaissance et concept, in Grenier D. (ed.) *Didactique et technologies cognitives en mathématiques, séminaires 1994-1995*, pp. 219-244, Grenoble: Université Joseph Fourier.
- Balacheff N., 2000; Les connaissances, pluralité de conceptions – le cas des mathématiques, in Tcherinikine P. (ed.) *Actes de la conférence Ingénierie de la connaissance (IC 2000)*, Toulouse, pp. 83-90.
- Balacheff N., Gaudin N., 2002; Students conceptions: an introduction to a formal characterization, in *Les cahiers du laboratoire Leibniz*, n. 65, Dec. 2002, Grenoble, France.
- Brousseau G., 1997; *The theory of didactical situations in mathematics*, Kluwer Acad. Publ.
- Confrey J. (1990) A review of the research on students conceptions in mathematics, science, and programming, in Courtney C. (ed.) *Review of research in education*. A.E.R.A.16, pp. 3-56.
- Dorier J.-L., 1998; Etat de l'art de la recherche en didactique à propos de l'enseignement de l'algèbre linéaire, in *Recherches en didactique des mathématiques*, v.18, n.2, pp. 191-230.
- Dorier J.-L., (ed.) 2000; *On the teaching of linear algebra*, Kluwer Acad. Publ., The Netherlands.
- Dorier, J.-L., Robert, A., Robinet, J. and Rogalski, M., 2000; The obstacle of formalism, in Dorier, J.-L.(ed.) *On the teaching of linear algebra*, Kluwer Acad. Publ., The Netherlands.
- Fischbein E., 1983; *Intuition in science and mathematics*, Reidel Publishing Company.
- Fischbein E., 1989; Modelli taciti e ragionamento matematico, in D'Amore B. (ed.) *Matematica a scuola: teorie ed esperienze*, Pitagora Editrice Bologna, pp. 25-38.
- Harel G., 1990; Using geometric models and vector arithmetics to teach high-school students basic notions in linear algebra, in *International journal of mathematics education in science and technology*, v.21, n.3, pp. 387-392.
- Harel G., 2000; Three principles of learning and teaching linear algebra, in Dorier, J.-L.(ed.) *On the teaching of linear algebra*, Kluwer Academic Publishers, The Netherlands.
- Tall D., Vinner, S., 1981; Concept Image and Concept Definition in Mathematics with Particular Reference to Limits and Continuity, in *Ed. St. in Math.*; v.12 n.2, pp.151-69.
- Tucker A., 1993; The Growing Importance of Linear Algebra in Undergraduate mathematics, in *The college mathematics journal*, v.24, n.1, pp. 3-9.
- Vergnaud G., 1991; La théorie des champs conceptuels, in *Rech. Did. Math.*,v.10, n.2/3, pp.133-69.

FUNCTION AND GRAPH IN DGS ENVIRONMENT

Maria Alessandra Mariotti*, Colette Laborde** & Rossana Falcade**

*Dipartimento di Matematica di Pisa – **Laboratoire IMAG – Grenoble

Assuming that dynamic features of Dynamic Geometry Software may provide a basic representation of both variation and functional dependency, and taking Vygotskian perspective of semiotic mediation, a teaching experiment has been designed with the aim of introducing pupils to the idea of function. First data coming from the observations in Italian and French classrooms are presented.

INTRODUCTION

Since a long time, the notion of function has been at the core of a great number of studies, and the rich literature reports on a number of difficulties related to different aspects of the notion of function (Goldenberg, Lewis and O’Keefe 1992, Harel and Dubinsky 1991, Sfard 1991, Sierpiska 1992, Tall 1991, Vinner and Dreyfus 1989, Leinhardt, Zaslavky & Stein 1990). Difficulties of interpreting graphic information in terms of function are widely reported. It seems that for students there is a lack of explicit relationship between function and graph¹, (Vinner & Dreyfus, 1989, Dreyfus & Eisenberg, 1983); students are not able to move from the one to the other identifying domain and image of function or confounding decreasing behavior with negative values (Trigueros, 1996). Rigid and stereotyped ideas are often related to functions and their graphs (Markovits et al. , 1986, 1988 ; Schwarz & Hershkowitz, 1996).

Even with Graphic calculators students show difficulties to relate the graphs they saw on their GC to the algebraic representation of the function (Cavanagh & Mitchelmore, 2000). In summary, students have problems to grasp the idea of function as a relationship between variables (one depending on the other). Pupils have a discrete view of a function relating separate pairs of numbers, where each number may be considered as an input giving another number as result; pupils consider that there is a relationship between numbers, but the relation is conceived separately for each pair. In any case, the relationship of dependency between the two variables is not visible in the graph, that remains a static representation of the couple (x,y) and does not afford the meaning of dependency between the two variables that rather play a symmetrical role.

This paper is based on the starting assumption that the crucial aspect of the idea of function is the idea of variation or more precisely of co-variation, i.e. a relation between two variations (cf. below section Function as change).

Primacy of numerical setting (Goldenberg et al., 1992) and the lack of experience of functional dependency in a qualitative way may be considered as the main sources of the students’ difficulties. This is why we assume that it is important to start in an environment providing a qualitative experience of functional dependency, independently

¹ In French the word “graphe” refers to the algebraic notion of ordered pairs of numbers and the curve is called “représentation graphique” (graphical representation). According to the current use in English, in this paper we will use “graph” to refer to both meanings.

of a numerical setting. DG incorporates functional dependency and allows thinking the geometrical links in terms of functional dependency.

Starting from these assumptions and taking the Vygotskian perspective of semiotic mediation (Vygotsky, 1978, Mariotti, 2002) as well as using the theory of didactic situations (Brousseau, 1997), teaching experiments have been set up. Some data coming from classrooms observations will be presented here.

FUNCTION AS CHANGE

Although not expressed in the classic mathematical definition of function, the idea of variation and co-variation is a crucial component of the notion of function, as Tall clearly states: “One purpose of the function is to present how things change” (Tall, 1996, p. 288). Our assumption is that grasping the idea of function requires grasping the idea of co-variation, i. e. conditional change. As cognitive analysis highlights, motion – space changing over time – can be considered as one of the basic primitive perceptions of “dynamic and continuous” (by using the terms of Malik, 1980) variation.

A deep gap separates early notions of function, based on an implicit sense of motion, and the modern definition of function, that is "algebraic in spirit, appeals to discrete approach and lacks a feel for variable" (Malik, 1980).

A connection to the basic metaphor should be preserved in the idea of graph, that is in the spatial representation of a function in a coordinate plane; however, this can be done by considering the graph as the trajectory of a moving point P (Laborde 1999, p.170), representing the dependent variable, according to the variation of a variable point M on the axis of abscissas, representing the independent variable. This complex interpretation requires to reintroduce time and to consider the co-variation of P and M as a relation between two interrelated variations depending on time, what we call a dynamic interpretation of a graph.

Unfortunately, this dynamic interpretation is often neglected in the textbooks. In any case, a dynamic interpretation of a graph cannot be externally experienced and remains a sort of mental experiment, impossible to be shared. Unlike the paper and pencil environment, which cannot afford the representation of change through motion, the DGS environment can. In DGS environments the idea of variation is grounded in motion, so

that it is possible to experience variation in the form of motion: points can be dragged on the screen and represent the basic variables. As a consequence, DGS environments incorporate and represent the idea of variation and that of functional dependency.

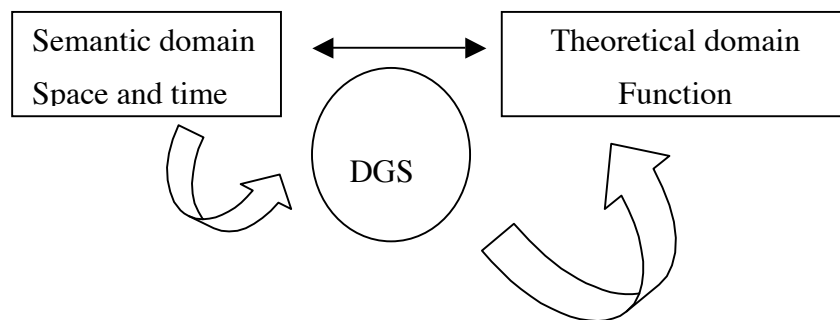

Figure 1

Thus DGS offer a powerful environment incorporating the semantic domain of space and time, where the notion of function can be grounded. We call that particular instance of function “Dynamic Geometrical Function”. This general idea can be interpreted in a Vygotskian perspective, according to the notion of semiotic mediation. The following section will develop this idea and explain how it was used in the design of our experiment.

THEORETICAL FRAMEWORK: TOOLS, SIGNS AND MEANING

Vygotsky distinguishes between the function of mediation of *technical tools* and that of *psychological tools* (or *signs* or *tools of semiotic mediation*) (Vygotsky, 1978: 53). The use of the term *psychological tools*, that refers to signs as internally oriented, is based on the analogy between tools and signs, but also on the relationship that links specific tools and their externally oriented (for the mastering of nature) use to their internal counterpart (for the control of oneself) (ibid.: 55).

Through the complex **process of internalization** (Vygotsky, ibid.), a tool becomes a «psychological tool» and will shape new meanings; in this respect a tool may function as a semiotic mediator.

As far as the DGS Cabri is concerned, previous studies (Mariotti & Bartolini, 1998; Arzarello, 2000, Mariotti 2001, Mariotti & Cerulli, 2001, Mariotti, 2002,) focused on the analysis of the specific elements of the microworld (dragging facility, commands available, macro ...) as instruments of semiotic mediation that the teacher can use in order to introduce pupils to mathematical ideas. We assume this theoretical hypothesis in the case of a set of particular tools, among those available in the microworld Cabri, and the meaning of function, as discussed above. In particular, assuming motion as a primitive metaphor of variation in the semantic domain of space and time, a crucial element emerges as a privileged representative (metaphor) of the idea of variation: the idea of trajectory.

The notion of trajectory entails the twofold meaning of motion: punctual and global; a trajectory is at the same time a sequence of positions of a moving point with respect to time and the whole object consisting in the set of all such positions.

The Trace tool, activated on a point, provides the track of the motion of that point. Trace tool can be used in the case of both a direct variation by dragging and an indirect variation. Although the final product of the Trace tool is a static image consisting in a set of points, the use of Trace tool involves time: actually, one can feel time running in the action of dragging, in particular when changing the speed of dragging, but also one can feel time running in the variation of the dependent point. As a consequence it is possible to grasp simultaneously the global and the punctual aspect of the product of Trace, which can be related to the global and punctual aspect of a **trajectory**.

In this sense, the use of the Trace tool and the mental constructs related to it, may refer to the idea of trajectory, and it can be considered as a potential tool of semiotic mediation for the mathematical meaning of trajectory. That supports our main hypothesis about the use of Trace as a tool of semiotic mediation.

Personal meanings concerning the idea of variation and co-variation as it emerges from pupils' activities in the Cabri environment may evolve into the mathematical meanings of function as a covariation .

THE TEACHING EXPERIMENT

Basic assumptions

Taking into account the main results obtained from the analysis on the correspondence between some Cabri tools and the meanings related to function, a sequence of activities was designed and implemented in two classes, in France and Italy (10th grade). This sequence was based on some general assumptions about the teaching/learning processes:

- Tools are part of the construction process of meanings, then they can be used by the teacher to foster this process according to intended meanings
- Learning is both an individual and a social construction.
- As a consequence the general structure of the activities consisted of two stages:
- firstly students were faced with tasks to be carried out in the Cabri environment,
- the various solutions were then discussed collectively under the guidance of the teacher.

General structure of the sequence

The activities of the sequence can be grouped in three phases:

1. Introduction of the variation and co-variation through exploring the effect of Macro constructions; a first definition of function, domain and image was given, based on the interpretation of a geometric situation in terms of function. "Dragging", "Trace tool" and "Macro tool" are the key elements on which semiotic mediation is based.
2. Introduction of the idea of graph, working on a text, drawn from the original work of Euler (Euler, 1743). According to this text, a graph of function gives the means to represent geometrically a numeric function.

"[...] Because, then, a unlimited straight line represents a variable quantity x , let's look for a method equally comfortable (useful) to represent any function of x geometrically.

[...]Thus any function of x , geometrically interpreted in this manner, will correspond to a well defined line, straight or curve, the nature of which will depend on the nature of the function.(
Translated by the authors)

(Euler, 1743, p. 4 -5)

Euler's method consists in generating the **trajectory** of the extremity M of a segment PM . One of the extremities, P is a variable point of the axe of abscissas and has a distance x from the origin O . The other extremity, M , is on the line perpendicular to the axe of abscissa passing through P and such that PM measures $f(x)$. Figure 2 shows how, according to Euler, the graph of the real function $f(x) = |x|$ would appear in Cabri.

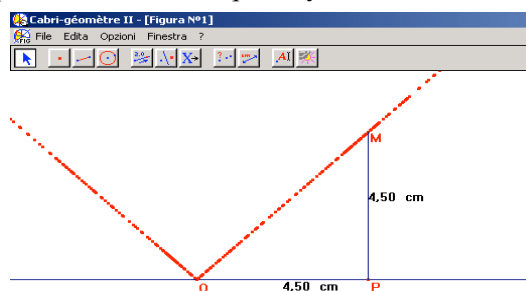

Fig. 2 Graph of $f(x) = |x|$ according to Euler's method

3. the use of the graph of a function in solving problems.

In the following section, some results will be discussed, concerning the first phase of the sequence, when the idea of function has to be related to the grounding metaphor of motion and in particular to the idea of trajectory.

THE FIRST ACTIVITIES AND THE NOTION OF TRAJECTORY

The first teaching session is carried out in the computer laboratory. Pupils are grouped in pairs and must produce a common written answer on a worksheet. In the first task the students apply an unknown macro-construction to three given points A , B and P they obtain a fourth point H . They have to explore systematically the effect of moving a point and have to fill in a table explaining what moves and what does not move when dragging each point. In a second question, they are suggested to use the Trace tool and asked to observe what happens, then to describe the movement of the different points, using the current language of geometry.

Students easily solved question 1 in both countries. They all perceived the difference between direct move of points A , B and P , which can be dragged directly by taking them with the mouse and indirect move of H , which cannot be grasped with the mouse but moves only when A , B or P is dragged. This became a reference situation on the basis of which the meaning of variable (dependent and independent) was going to be treated.

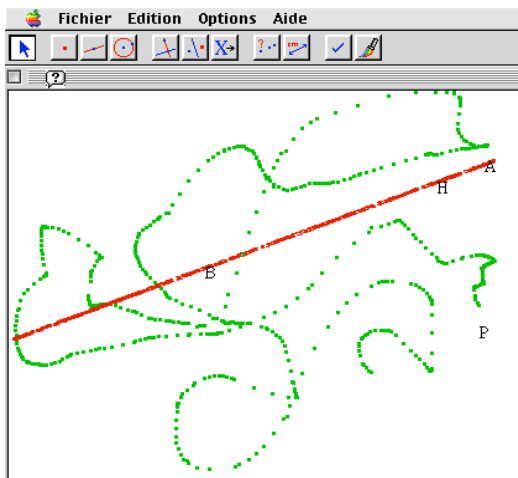

Fig. 3 Traces as they appear on the screen

The analysis of the pupils' answers confirms our main hypothesis about the contribution of the use of Trace in the emergence of the twofold meaning of trajectory. In fact, both the conception of trajectory as an object and as ordered sequence of points can be found in the pupils' formulations, as shown in the following examples drawn from pupils' written reports. Different meanings could be drawn from the interpretation of their words and expressions. ((I) Italian pupils and (F) French pupils).

Federica (I) drew the trace of both the variable point (independent variable) and the point H (dependent variable) and wrote:

“Dragging B , H forms a circle, passing through P and A

Dragging P , H forms a straight line, passing through B and A , which touches the circle in two points .

Dragging A , H forms a circle, passing through P and B .”

Laurent (F) writes: “Quand on déplace P , le point H fait une droite qui suit $[AB]$.

Quand on déplace A , le point H forme un cercle par B et P”

The expression “forms a circle” refers to the global aspect of the trajectory, the circle is the final product of a completed process.

In addition to the global conception of the trajectory (H forms a circle, a line...) the idea that point H is moving on that object was expressed.

Andrea (I): "When the position of P varies, H leaves a trace which always stays on the line passing through A and B"

Tiziano (I): "If one moves (drags) point P, H moves on the line containing (comprende) the segment AB"

Catarina (F): "Quand on utilise A, H fait un cercle passant par B et P. ... quand on utilise P, H se déplace en ligne droite en passant par A et B."

Sarah- Julia (F): "Quand A bouge, H décrit un cercle autour de diamètre BP"

Sonia (F): " Si on déplace A, A forme une trajectoire quelconque et H se déplace sur un cercle de diamètre BP."

Expressions like "describes", "se déplace en ligne" incorporate both the components of the conception of trajectory (global, as an object, and pointwise, as the sequence of positions taken along the time).

The students' answers show the use of dragging to identify on the one hand the nature of variables and on the other hand the domain and the image of function as trajectories.

The dragging tool moved in the following tasks from an external use to an internal one for several students. For example, Chrystelle and Cécile hesitated when identifying between points P and Q the dependent and the independent variables. Finally they evoked the dragging test which led them to write the correct relation $F(P) = Q$.

Chrystelle and Cecile wrote: "We associated point P to point Q because when we move P Q is moving on the trajectory (NN'). Therefore Q depends on P ($F(P) = Q$).

This latter example gives evidence of the internalization of the dragging tool; the following episode gives evidence of the fact that an internalization process was achieved and that the Trace tool became a 'psychological tool'.

THE CASE OF SONIA AND JULIE

Faced with the task of conceiving their own function Sonia & Julie correctly described a construction relating point M' to an independent point M and commented:

"M' varies in the plane and it's the symmetrical of M with respect to the angle bisector of angle MRM'. M' is dependent of R (M?) through a geometrical transformation."

According to the notes of observation, they used the Trace tool to check that M' depends on M: they activated the Trace Tool on both M and M', then by dragging M, verified that M' is moving because M' is leaving a trace. That is the use of Trace that was initially introduced in relation to dependency between variables. However, evidence of the internalization of this tool is given by the fact that it was also used to solve a new problem. In fact, in order to determine the nature of the function relating M and M', the two girls decided to move M along a small curve, deliberately regular (a knot), looking for an analogy between the trajectories of M and M'. They realized that the two traces looked identical, after this observation they identified the function as a reflection. This may be interpreted in terms of semiotic mediation.

The image and domain of function as reified by Trace are intentionally utilized in checking a conjecture based on their previous geometrical knowledge about reflection. That means that the Trace tool is used not only in exploration (externally oriented), but also in the reasoning which leads to the solution of the problem: it has become an intellectual tool (internally oriented).

CONCLUSIONS

As shown in the previous example, the expected results occurred in both countries. Pupils seem to have grasped variability as motion. From the combination of observation and action emerges the idea of co-variation, which is experienced through the coordination between eyes and hands and is incorporated in the conditional movement of points on the screen.

Similarly the twofold conception of trajectory, global and punctual, clearly emerged, in relation to dragging and Trace tools. We can say that the internalization of the dragging and Trace tools has contributed to construct both the global and the punctual aspects of the idea of trajectory, and this in connection to the introduction of the notions of domain and image of function. According to our hypothesis, the twofold conception of trajectory as object and sequence of points has been reinvested both in the interpretation of Euler's text and in its appropriation as a method to conceive dynamically a graph of function both as a set of points and as a curve. The size of this report does not allow to go further (see Falcade 2002 for further analysis).

Starting from these results which show clear evidence of the power of mediation provided by Cabri tools, new teaching experiments have been designed and are in progress, aimed to investigate the mediation process. They allow to refine our assumptions but confirm the main one concerning the idea of covariation. At the end of the second teaching experiments, both in France and in Italy (2002), the students were asked to express the conditions for two functions to be equal. It is possible to observe the emergence of the idea of coincidence point by point, as it is originated by the coincidence trajectory by trajectory. In the same time, most of the students, asked to describe the similarities and differences between geometrical and numerical functions, explained that the similarity consists in the dependence between two kinds of variables.

A final remark: previous discussion does not take into account the role of the teacher in the process of evolution of meanings. The role of the teacher develops at the meta level, when guiding the evolution of meanings: it becomes determinant in a process of semiotic mediation. Further investigations into the delicate role played by the teacher have been designed and are currently underway.

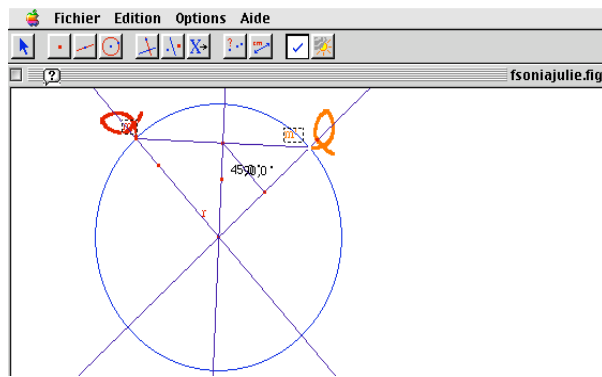

Fig. 3 What appears on the screen of Sonia and Julie

References

- Arzarello, F. (2000) Inside and outside: spaces, times and language in proof production. , In *PME Proc. Hiroshima*, II, pp I, 1-23
- Brousseau G. (1997) Theory of didactical situations in mathematics. Kluwer Ac. Pub.
- Cavanagh, M. & Mitchelmore, M. (2000) Student misconceptions in interpreting basic graphic calculator displays, In *PME Proc. Hiroshima*, II, pp. 161-168,
- Dreyfus, T. & Eisenberg, T. (1983) The function concept in college students □ *Focus on the Learning Problems in Mathematics*, 5, 119-132.
- Euler, L. (1743) *Introductio in analysin Infinitorum Tomus secundus Theoriam Linearum curvarum*, Lousannae.
- Falcade R. (2002) Cabri-géomètre outil de médiation sémiotique pour la notion de graphe de fonction, *Petit x*, 58, 47-81.
- Goldenberg E. P., Lewis P., and O'Keefe J. (1992) Dynamic representation and the development of an understanding of functions, In Dubinsky E., and G. Harel (1991.)
- Harel G. and Dubinsky E. (1991) *The concept of function* □ *Aspects of epistemology and pedagogy*, Washington, DCE □ Mathematical Association of America.
- Laborde, C. (1999) Core geometrical knowledge for using the modelling power of Geometry with Cabri-geometry, *Teaching Math. and its Application*, Vol. 18 n°4.
- Leinhardt, G., Zaslavky, O. & Stein, M.K. (1990) Functions, Graphs, and Graphing: Tasks, Learning, and Teaching. *Review of Educational Research*, v60 n1, 1-64.
- Malik, M.A. (1980) Historical and pedagogical aspects of the definition of function. *Int. Journal of mathematics education in science and technology*, 11 (4), 489–92
- Mariotti, M.A. & Bartolini Bussi M.G. (1998) From drawing to construction: teachers mediation within the Cabri environment, in *PME Proc.*, Stellenbosh, I- 180-95.
- Mariotti, M.A. (2001) Introduction to proof: the mediation of a dynamic software environment, (Special issue) *Educational Studies in Mathematics* 44, (1&2), Dordrecht: Kluwer, 25–53.
- Mariotti, M.A. & Cerulli, M. (2001) Semiotic mediation for algebra teaching and learning, *PME Proc.* The Nederland.
- Mariotti M. A. (2002) Influence of technologies advances on students' math learning, in English, L. et al.(eds) *Handbook of International Research in Mathematics Education*, LEA, 695-723.
- Markovits Z., Eylon B. & Bruckheimer, M. (1988) Difficulties Students have with the Function Concept, *The ideas of Algebra, K-12*, 43-60, NCTM Yearbook
- Schwarz, B.B. & Hershkowitz, R. (1996) Effects of computerized tools on prototypes of the function concept, *PME Proc.*, Valencia, IV –267-274.
- Sfard A. (1991) On the dual nature of mathematical conceptions □ reflections on processes and objects as different sides of the same coin, *Educational Studies in Mathematics*, 22 (1), 3-22
- Sierpinska A. (1992) On understanding the notion of function, Harel & Dubinsky (1991), 25-58,
- Tall D. (1991) The psychology of advanced mathematical thinking, D. Tall (ed.), *Advanced Mathematical thinking*, 3-21, Dordrecht □ Kluwer □
- Tall, D. (1996) Function and Calculus , In: A.J. Bishop et al. (eds.) *International Handbook of Mathematics Education* (Vol. 1, 289–325) Dordrecht: Kluwer
- Trigueros M., et al. (1996) College Students' conceptions of variable *PME Proc.* Valencia, IV -315-322.
- Vinner S. and Dreyfus T. (1989) Images and definitions for the concept of function, *JRME*, 20, 356-366
- Vygotskij L. S.: 1978, *Mind in Society*. Harvard University Press. University Press.

COLLECTIVE MATHEMATICAL UNDERSTANDING AS AN IMPROVISATIONAL PROCESS

Lyndon C. Martin

Jo Towers

University of British Columbia

University of Calgary

This paper explores the phenomenon of mathematical understanding, and offers a response to the question raised by Martin (2001) at PME-NA about the possibility for and nature of collective mathematical understanding. In referring to collective mathematical understanding we point to the kinds of learning and understanding we may see occurring when a group of learners, of any size, work together on a piece of mathematics. In employing and extending the theoretical work of Becker (2000), Sawyer (1997; 2000; 2001) and Berliner (1994; 1997), we characterise collective mathematical understanding as a creative and emergent improvisational process and illustrate how it can be observed in action.

THE NATURE OF MATHEMATICAL UNDERSTANDING

Drawing on the work of Pirie and Kieren (1994)¹, we see the growth of mathematical understanding as a dynamical and active process. The Pirie-Kieren theory offers a way of considering mathematical understanding that recognises and emphasises the interdependence of all the participants in an environment. It shares and is intertwined in an ecological view of learning and understanding as an interactive process. This location of understanding in the “realm of interaction rather than subjective interpretation”, together with a recognition that “understandings are enacted in our moment-to-moment, setting-to-setting movement” (Davis, 1996, p.200), allows and requires the conceptualisation of understanding not as a state to be achieved but as a dynamic and continuously unfolding phenomenon. Hence, it becomes appropriate to talk not about ‘understanding’ as such, but about the process of coming to understand, about the ways that mathematical understanding shifts, develops and grows as learners move within the world.

Davis (1996) claims that “a significant strength of the [Pirie-Kieren] model is that it can be used to interpret the mathematical actions of either individuals or groups of learners” and that “the model highlights the manners in which collective understandings do emerge...that cannot be located in any of the participants but which rather are present in their interactions” (p.203). However, as acknowledged by Kieren and Simmt (2002), the Pirie-Kieren theory is still essentially one of dynamical *personal* understanding, although it has been applied in limited ways to groups of learners. In considering the growing understanding of two learners working together, and to acknowledge the interactions and shared activities of the learners, Kieren, Pirie & Gordon Calvert (1999) chose to show the students’ growing understandings with one pathway, although in doing so they did not

¹ The Pirie-Kieren theory has been fully presented and discussed in a number of previous PME meetings and many of its features have been set out there and elsewhere. Hence it is not intended to elaborate on the theory here.

“intend to imply that [the students’] histories or understandings [were] identical” (p.220). We would suggest that in considering the notion of dynamical *collective* understanding it is not that the individual understandings and histories of learners are identical, but that alongside a personal dynamical understanding there also co-exists an understanding at another level, located in the interactions of the learners (see Davis & Simmt, 2002). We see mathematical understanding as an emergent phenomenon requiring simultaneous analysis at multiple levels, not just at the level of the individual. As mathematical understanding emerges at the collective level from the actions of individuals, so the collective also constrains and influences the individual, and thus “a purely reductionist model [one focused on individual learners] will still fail to represent the emergent higher-level entity - the collaboratively created frame” (Sawyer, 2001, p.214). However, we are not claiming that collective mathematical understanding is an automatic or simple occurrence whenever two or more people are working together. Indeed in other papers we have highlighted the way in which collective understanding fails to emerge from the interactions of a group of learners, and that what is observed is merely a set of individual understandings occurring simultaneously (see Martin, Towers, & Pirie, 2000). In contrast, in this paper we will illustrate what we are characterising as collective mathematical understanding and how we observe it to occur in action.

THE NATURE OF THE IMPROVISATIONAL PROCESS

In attempting to characterise collective mathematical understanding as an emergent process, we draw on the work of Becker (2000), Sawyer (1997; 2000; 2001) and Berliner (1994; 1997) on improvisational traditions within jazz and theatre. We extend this theoretical frame to consider collective mathematical understanding as a process with a similar nature and characteristics. Berliner (1997) claims that “the study of one musician’s creative process cannot capture the essence of jazz, because more than any other performance genre, a jazz performance is a collective, emergent phenomenon” (p.10). We contend that the same can be true of a group of individuals working together mathematically, and that to simply focus on the understanding actions of one or all individuals does not necessarily fully explain nor characterise the growth of the mathematical understanding as it occurs.

Sawyer (2000), in considering acts of collaborative emergence, suggests that “in an ensemble improvisation, we can’t identify the creativity of the performance with any single performer; the performance is collaboratively created” and that although each individual is contributing something creative, these contributions only make sense “in terms of the way they are heard, absorbed, and elaborated on by the other musicians” (p.182). In applying this to improvised theatre and verbal performance, Sawyer offers a number of key features of collective emergence. Of particular importance is the notion of ‘potential’, of the unpredictability of pathways of actions. Sawyer notes that “an improvisational transcript indicates many plausible, dramatically coherent utterances that the actors could have performed at each turn. A combinatorial explosion quickly results in hundreds of potential performances” (p.183). However, quite early in a scene Sawyer suggests that a “collectively created structure” has emerged from the interactions, which “now constrains the actors for the rest of the scene” (p.183). To remain coherent, subsequent actions must fit with this structure, yet of course will still add to it. Thus we

have a complex interplay between individual and structural actions as these co-emerge together.

In considering improvisational jazz, from a similar perspective as a collective emergent phenomenon, Becker (2000) offers a number of key characteristics of collective improvisation in a jazz performance. Of particular importance is the requirement that everyone pay attention to the other players and be willing to alter what they are doing “in response to tiny cues that suggest a new direction that might be interesting to take” (p.172). Becker notes the subtlety of the etiquette operating here, as every performer understands

that at every moment everyone (or almost everyone) involved in the improvisation is offering suggestions as to what might be done next. As people listen closely to one another, some of those suggestions begin to converge and others, less congruent with the developing direction, fall by the wayside. The players thus develop a collective direction that characteristically...feels larger than any of them, as though it had a life of its own. It feels as though, instead of them playing the music, the music, Zen-like, is playing them (p.172).

He also notes that unless the performers listen carefully, and where necessary “defer” to the collective mind, the music will “clunk along” with each individual doing nothing more than playing their own “tired clichés” (p.173). In improvisation, when one person does something that is obviously better (in the view of the collective) then “everyone else drops their own ideas and immediately joins in working on that better idea” (p.175). Of course this requires some understanding of what “better” might look like and of how to recognise it. So how does a group recognise what is better? In mathematics, “better” is likely to be defined as an idea that appears to advance the group towards a solution to the problem, the drawing on a concept that seems appropriate and useful in the present situation. Interestingly, Becker also suggests that in collaborative improvisations, as people follow and build on the leads of others, they “may also collectively change their notion of what is good as the work progresses” (p.175) leading to a creative production or performance that could not have been predicted prior to the activity.

COLLECTIVE MATHEMATICAL UNDERSTANDING AS AN IMPROVISATIONAL PROCESS

In this section we discuss how some of the theoretical principles of improvisation offered by Becker, Berliner and Sawyer might apply to children working mathematically. The ideas we are advancing here are based on data from many observational studies we have conducted over a number of years.² Here, we illustrate our thinking through considering an extract of video data of three Grade Six students starting work on a problem. The students have been posed the problem of calculating the area of a parallelogram, a figure with which they have not worked before.

Interviewer: Okay. So what I have here...is a little bit of a different shape for you. (*She passes over a piece of paper on which is drawn a parallelogram with no dimensions provided*)

Natalie: Parallelogram, I think?

² See Kieren (2001) for a discussion of our collective “research-in-process” (p.225).

I: Mmmmm! It's a parallelogram...well done. I wonder if you could figure out for me how to find out the area of that parallelogram. I have rulers here if you need a ruler.

N: Can try it...measure...sides. (*She measures two adjacent sides*).

Stanley: Ten

N: Mm hm. And that's ten right? (*She points to the opposite side*). They're both ten. And then the top one is longer, and that is...

Thomas: it's eighteen.

N: Yep. So that's ten... and eighteen. (*She writes the numbers on the sides*). Ok, so we could...

T: multiply

N: ...the area, yeah ten by eighteen ...and then see what we get.

T: It would be this...

N: yep (*pause*) and then if we wanted to do...so that would be the area then?

S: But look at the shape.

N: I know that's what I'm saying that can't be right cause that - that's a little bit...

S: Okay. Wait, I know.... draw a straight line, here and here, you get triangles, and squares. (*He adds lines to the parallelogram, see Figure 1*)

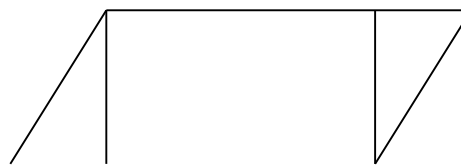

Figure 1

T: Oh I know...

S: Now these triangles...I think...

T: is half?

N: These triangles will make up that square though. So then if we just measure that....

S: and times by two.

N: Yeah. Because these two, these triangles make that square, right? .

T: That'll work.

S: I think...

N: So if we...what is...this it's still, it's not eighteen though, anymore. Because we're cutting it... it will be twelve. (*She measures the sides of the rectangle that has been created*).

T: and then ten

N: and this side is...no it wouldn't be ten. (*She is referring to the width of the rectangle, i.e. the perpendicular height of the parallelogram*).

T: Like, eight?

N: this side is eight, yep. So...

S: and then 12 times 8...is...

T: ...is...ninety...

S: Yeah, ninety-six.

T: ...six

N: So ninety-six times...

S: So ninety-six times two, so uh ninety-s...

T: a hundred...I mean no, not a hundred...yeah a hundred – eighty-uh... three?

S: *ninety*- three...

N: ninety-six. One ninety-six.

S: Okay.

N: How does that work? Two times six is twelve. One ninety...two.

T: So it's one ninety-two.

S: Yeah, one ninety-two...

N: is the area of that. So it's the area of the whole...

We recognise that in this short piece the students do not find a correct answer to the problem. However, they continued to work for several more minutes after this, as they realised (after a question from the interviewer) that their strategy of simply doubling the area of the rectangle did not quite work. Our focus here though is not the correctness of their mathematics, but the improvisational character of their mathematical interactions.

There are many interesting aspects to this transcript, and to the ways in which the students work collectively together here. Firstly, the discourse appears as though one person (rather than three) was speaking. The students complete one another's sentences, but more than that they seem to be speaking with one voice. Indeed, it is almost as though you could remove the names of the speakers in the transcript and read it as a monologue. This is also true of the emerging mathematical understanding, which like the conversation, cannot be separated into three pathways of growth, and indeed only makes sense when considered collectively. The students are engaged in making a collective image for the concept of area of a parallelogram, and although this is emerging from the contributions of individuals, we see a single image being made - that to find the area of a parallelogram one doubles the area of its internal rectangle. It is not possible to discern individual pathways of growth of mathematical understanding, and we would contend that in this case these do not really exist.³ The growth in mathematical understanding is occurring at the collective level. This claim echoes Sawyer's (2000) suggestion, which we cited earlier, that "in an ensemble improvisation, we can't identify the creativity of the performance with any single performer; the performance is collaboratively created" (p.182).

It is interesting too to note that although these students were working in an interview scenario, they pay little attention to the presence of the interviewer. Instead, like Becker (2000) noted of jazz performers "the improvisers are trying to solve a problem or perform a feat for its own sake or their own sake, because it is there to do and they have agreed to

³ Interestingly, when the researchers first worked with this data they attempted to produce individual mappings for each student's growth of understanding and found this to be both frustrating and impossible.

devote themselves collectively to doing it” (p. 174). The students here are committed to solving the problem that is posed, for its own sake. There is a powerful sense of collective purpose throughout the whole session, beyond what is transcribed here, with the priority always being meaningful and useful engagement with the mathematics. The devotion displayed by these three students to the problem is striking and it is worth noting that the students were so engrossed in the collective problem-solving that they failed to notice the bell ringing to signal the end of the session. Their focus is uncommon, and has been remarked upon by other teachers and researchers who have viewed the episode, including the students’ own Grade 6 teacher, who had not often asked these three students to collaborate as a group throughout the year, preferring, as do many teachers, to “spread the wealth” of these mathematically-able students by distributing them around various other groups in the classroom. It should be noted that our focus here is not group work, per se, but rather collective mathematical understanding, so we will refrain from further comment on group organisation, other than to note that our data suggest that, not to deny the importance of mixed-ability groupings in the classroom, there is also much to be gained by having students of comparable mathematical ability work together.

When offered the parallelogram, a shape that the students had not worked with in the context of area before, they initially began to cast around for strategies to find the area. At this stage there is no way to predict how the mathematics will unfold, nor even what mathematics will emerge from the interactions. Like the early stages of any improvisational performance, there is both ‘unpredictability’ and ‘potential’, with the group listening to the suggestions of each other as they work on making their image. Initially, no one idea is collectively taken up, nor discarded. Natalie takes the lead in measuring all the sides. Stanley and Thomas follow along. Thomas suggests multiplying, which is briefly picked up by Natalie, but no-one seems satisfied that that will produce an appropriate solution. Suddenly, when Stanley adds two lines to the diagram (see Figure 1) saying “draw a straight line here and here, you get triangles and squares” the energy of the group lifts and all three students appear to recognise the potential of the strategy. At this stage we see a collectively created structure starting to emerge, as the group have now collectively chosen which pathway to pursue, effectively rejecting all other previously offered ideas in favour of something which, for the moment, appears to be ‘better’. That is, as suggested earlier, it is a lead that seems likely to further their image making and continued growth of understanding. Here, there is a high level of attentiveness between the three students, they listen to each other, and to the mathematics as it emerges from their engagement. We see a deferring to a group mind, including a willingness to abandon personal motivations, which allows a collective image to emerge.

Of course, and as Becker (2000) commented, the collective notion of what is ‘good’ and ‘better’ may change as an improvisational episode progresses. In our example, Stanley’s move was clearly the critical moment in the episode - but only because the other students were prepared to ‘take the cue’, to adapt their developing thinking to follow a new direction. However, as already noted, the group later recognised that ‘doubling the area of the interior rectangle’ was an inadequate image and collectively worked to make their image into one that was ‘better’ - leading to a correct solution that satisfied the group. Their final image (one that is consistent with the particular parallelogram offered in the

question, but not generalisable) centres on the idea of the area of the interior rectangle being equivalent to four of the end triangles (see Figure 1). This image was “a result that could not have been foretold from anything they knew and were used to doing before they started” (Becker, 2000, p.175) but instead emerged through the continual and complex interactions of the three students.

CONCLUDING REMARKS

In this paper we have advanced the basis of a theoretical framework that provides a way to observe, consider and characterise the growth of collective mathematical understanding. To view the process of doing mathematics as a form of improvisation provides a powerful mechanism for going beyond an analysis of individual actions and for recognising the power and potential of collaboration for enabling the growth of understanding. A focus on the improvisational character of collective mathematical understanding re-orientes our attention to the significance of the level of activity in which the understanding emerges. As Sawyer (1997) notes, “the central level of analysis for performance study is not the individual performer, but rather the event, the collective activity, and the group” (p. 4). Indeed, the science of complexity has already prompted us to acknowledge that “complex unities must be studied at the level of their emergence” (Davis & Simmt, 2002, p. 833) and we believe this to be true of mathematical understanding. Whilst we do not wish in any way to devalue the place of dynamical personal understanding, we would also argue, that as a complex system, mathematical understanding must also be considered at the other levels at which it is seen to emerge, in particular that of the collective. Our work suggests the need to pay close attention to the collaborative work of students and to focus on their ‘improvisational performances’ in mathematics, rather than just the resulting product of such engagements. We would contend that this attention can provide a rich insight into both how mathematics should be seen as something more than merely an individual activity and also how mathematical understanding is a phenomenon that emerges and exists in collective action and interaction.

References

- Becker, H. (2000). The etiquette of improvisation. *Mind, Culture and Activity*, 7(3), 171-176.
- Berliner, P. (1994). *Thinking in jazz: The infinite art of improvisation*. Chicago: University of Chicago Press.
- Berliner, P. (1997). Give and take: The collective conversation of jazz performance. In R.K. Sawyer (Ed.), *Creativity in Performance* (pp.9-41). Greenwich, CT: Ablex Publishing.
- Davis, B. (1996). *Teaching mathematics: Toward a sound alternative*. New York: Garland.
- Davis, B., & Simmt, E. (2002). The complexity sciences and the teaching of mathematics. In D. Mewborn, P. Sztajn, D. White, H. Wiegel, R. Bryant, & K. Nooney (Eds.), *Proceedings of the twenty-fourth annual meeting of the North American Chapter of the International Group for the Psychology of Mathematics Education*, Vol. II, (pp. 831-840). Athens, GA.
- Kieren, T. (2001). Set forming and set ordering: Useful similies in observing the growth of mathematical understanding? In R. Speiser, C. Maher, & C. Walter (Eds.), *Proceedings of the twenty-third annual meeting of the North American Chapter of the International Group for the Psychology of Mathematics Education*, Vol. I, (pp. 223-233). Snowbird, UT.

- Kieren, T., Pirie, S., & Gordon Calvert, L. (1999). Growing minds, growing mathematical understanding: Mathematical understanding, abstraction and interaction. In L. Burton (Ed.), *Learning mathematics: From hierarchies to networks* (pp. 209-231). London: Falmer Press.
- Martin, L.C. (2001). Growing mathematical understanding: teaching and learning as listening and sharing. In R. Speiser, C. Maher, & C. Walter (Eds.), *Proceedings of the twenty-third annual meeting of the North American Chapter of the International Group for the Psychology of Mathematics Education*, Vol. I, (pp. 245-253). Snowbird, UT.
- Martin, L.C., Towers, J. & Pirie, S. (2000). Growing mathematical understanding: Three layered observations. In M.L. Fernandez (Ed.), *Proceedings of the twenty-second annual meeting of the North American Chapter of the International Group for the Psychology of Mathematics Education*, Vol. 1 (pp. 225-230). Tucson, AZ.
- Pirie, S., & Kieren, T. (1994). Growth in mathematical understanding: How can we characterise it and how can we represent it? *Educational Studies in Mathematics*, 26 (2-3), 165-190.
- Sawyer, R.K. (1997). *Creativity in Performance*. Greenwich, CT: Ablex Publishing.
- Sawyer, R.K. (2000). Improvisational cultures: Collaborative emergence and creativity in improvisation. *Mind, Culture and Activity*, 7(3), 180-185.
- Sawyer, R.K. (2001). *Creating conversations: Improvisation in everyday discourse*. Cresskill, NJ: Hampton Press.

SUPPORTING TEACHER CHANGE: A CASE FROM STATISTICS

Kay McClain

Vanderbilt University

This paper provides an analysis of a teacher development experiment (cf. Simon, 2000) designed to support teachers' understandings of statistical data analysis. The experiment was conducted as part of collaborative efforts between the author and a cohort of middle-school mathematics teachers during the 2000-2001 academic year. Analysis of the episodes in this paper document the evolution of the teachers' understandings as they participated in activities from an instructional sequence designed to support conceptual understanding of statistical data analysis. In this process, I highlight the mathematical issues that emerged as the teachers worked to further their own understandings.

INTRODUCTION

The purpose of this paper is to provide an analysis of the development of one group of teachers' understandings of statistical data analysis. The analysis builds from the literature on students' understandings by taking prior research in classrooms as a basis for conjectures about means of supporting teachers' development. In particular, the analysis in this paper will focus on a collaborative effort conducted between the author of this paper and a cohort of middle-school teachers. The collaboration occurred during the 2000-2001 academic year. The teachers participated with the author in monthly work sessions designed to support their understandings of effective ways to teach statistical data analysis in the middle grades (ages 12-14). Fundamental to this effort was attention to the development of the teachers' content knowledge. The instructional activities utilized during the course of the collaboration were taken from a classroom teaching experiment conducted with a group of seventh-grade students during the fall semester of 1997 (for a detailed analysis of the classroom teaching experiment see Cobb, 1999; McClain & Cobb, 2001). The intent of the instructional sequence is to support middle-school students' development of sophisticated ways to reason statistically about univariate data. The overarching goal is that they come to reason about data in terms of distributions. Inherent in this understanding is a focus on multiplicative ways of structuring and organizing data.

The intent of the teacher collaboration was then to take the seventh-grade instructional sequence as a *means of support* for the learning of the teacher cohort. This support included tasks from the instructional sequence, computer-based tools for analysis that accompanied the sequence, the teachers' varied inscriptions and solutions to tasks from the sequence, and norms for argumentation that were negotiated during the work sessions.

In the following sections of this paper, I begin by describing the theoretical framework that guided the analysis. I then provide a description of the method of analysis and the data corpus. I follow by outlining the instructional sequence that was the basis of the teacher collaboration. Against this background, I provide an analysis of episodes from the

work sessions intended to document the teachers' developing understandings of statistical data analysis.

THEORETICAL FRAMEWORK

The analysis reported in this paper was guided by the emergent perspective (cf. Cobb & Yackel, 1996). The emergent perspective involves coordinating constructivist analyses of individual activities and meanings with an analysis of the communal mathematical practices in which they occur. This framework was developed out of attempts to coordinate individual students' mathematical development with social processes in order to account for learning in the social context of the classroom. It therefore places the students' and teacher's activity in social context by explicitly coordinating sociological and psychological perspectives. The psychological perspective is constructivist and treats mathematical development as a process of self-organization in which the learner reorganizes his or her activity in an attempt to achieve purposes or goals. The sociological perspective is interactionist and views communication as a process of mutual adaptation wherein individuals negotiate mathematical meaning. From this perspective, learning is characterized as the personal reconstruction of societal means and models through negotiation in interaction. Together, the two perspectives treat mathematical learning as both a process of active individual construction and a process of enculturation into the mathematical practices of wider society. Individual and collective processes are viewed as reflexively related in that one does not exist without the other. Together, these two aspects provide a means for accounting for the teachers' activity in the social context of the work sessions.

METHOD OF ANALYSIS

The particular lens that guided my analysis of the data was a focus on the normative ways of solving tasks, or what Cobb and Yackel (1996) have defined as *mathematical practices*. These practices focus on the collective mathematical learning of the classroom community and thus enable one to talk explicitly about collective mathematical learning (cf. Cobb, Stephan, McClain, & Gravemeijer, 2001). This analytical lens therefore enabled me to document the collective mathematical development of the teacher cohort over the course of the year.

In order to conduct an analysis focused on the learning of the community, it is important to account for the diverse ways in which the teachers participate in communal practices. For this reason, the participation of the teachers in discussions where their mathematical activity is the focus then becomes data for analysis. The diversity in reasoning also serves as a primary means of support of the collective mathematical learning of the teacher cohort. As a result, "an analysis of classroom mathematical practices characterizes changes in collective mathematical activity while taking into account the diversity in individual [teachers]' reasoning" (Cobb, 1999, p. 10). An analysis focused on the emergence of classroom mathematical practices is therefore a conceptual tool that reflects particular goals (Cobb, et al., 2001).

DATA

Data for this study consist of videorecordings of each monthly work session and of the weeklong summer work sessions. In addition to the videotape there is a set of field notes

taken by a research assistant, copies of the teachers' work, copies of their students' work on the same tasks, and audiotape of interviews conducted with each teacher. This comprehensive data corpus allowed for the longitudinal analysis of the emergence of the mathematical practices by testing and refining conjectures against both the activity of the cohort and of the individual teachers within the cohort. This was done in a manner described by Cobb and Whitenack (1996) and is consistent with Glaser and Strauss' (1967) constant comparative method.

INSTRUCTIONAL SEQUENCE

In developing the instructional sequence for the seventh-grade classroom teaching experiment, the goal of the research team was to develop a coherent sequence that would tie together the separate, loosely related topics that typically characterize American middle-school statistics curricula. The notion that emerged as central from the synthesis of the literature was that of distribution. In the case of univariate data sets, for example, this enabled the research team to treat measures of center, spreadout-ness, skewness, and relative frequency as characteristics of the way the data are distributed. In addition, it allowed the research team to view various conventional graphs such as histograms and box-and-whiskers plots as different ways of structuring distributions. The instructional goal was therefore to support the development of a single, multi-faceted notion, that of distribution, rather than a collection of topics to be taught as separate components of a curriculum unit. A distinction that was made during this process which later proved to be important is that between reasoning additively and reasoning multiplicatively about data (cf. Harel & Confrey, 1994; Thompson, 1994; Thompson & Saldanha, 2000). Multiplicative reasoning is inherent in the proficient use of a number of conventional inscriptions such as histograms and box-and-whiskers plots.

As the research team¹ began mapping out the instructional sequence, it was guided by the premise that the integration of computer tools was critical in supporting the mathematical goals. The instructional sequence developed in the course of the seventh-grade teaching experiment in fact involved two computer tools. In the initial phase of the sequence, the students used the first computer tool to explore sets of data. This tool was explicitly designed for this instructional phase and provided a means for students to manipulate, order, partition, and otherwise organize small sets of data in a relatively routine way. When data were entered into the tool, each individual data value was shown as a bar, the length of which signified the numerical value of the data point (see Figure 1). A data set was therefore shown as a set of parallel bars of varying lengths that were aligned with an axis. The first computer tool also contained a value bar that could be dragged along the axis to partition data sets or to estimate the mean or to mark the median. In addition, there was a tool that could be used to determine the number of data points within a fixed range.

¹ The research team was composed of the author, Paul Cobb, Koeno Gravemeijer, Maggie McGatha, Jose Cortina, Lynn Hodge and Carla Richards.

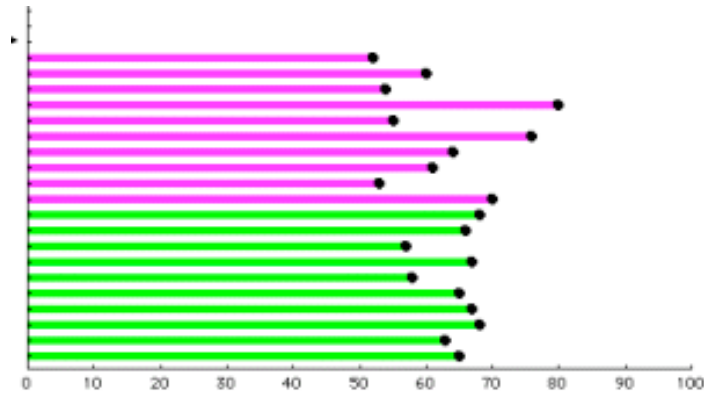

Figure 1. Data displayed in first computer tool.

The second computer tool can be viewed as an immediate successor of the first. As such, the endpoints of the bars that each signified a single data point in the first computer tool were, in effect, collapsed down onto the axis so that a data set was now shown as a collection of dots located on an axis (i.e. an axis plot as shown in Figure 2).

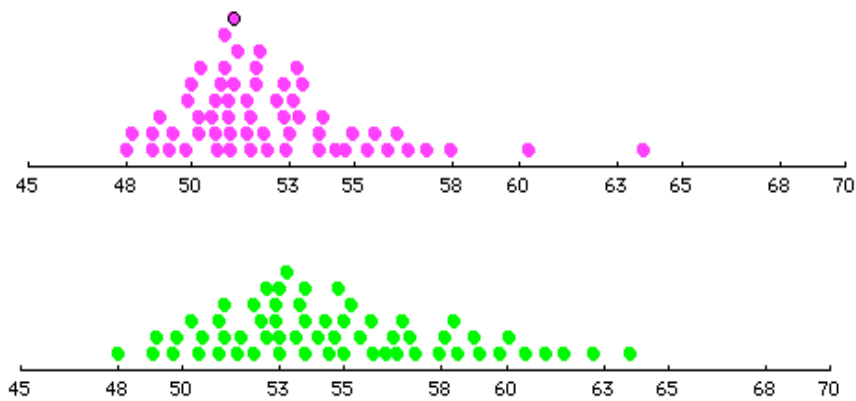

Figure 2. Data displayed in second computer tool.

The tool offered a range of ways to structure data. The options included: (1) making your own groups, (2) partitioning the data into groups of a fixed size, (3) partitioning the data into equal interval widths, (4) partitioning the data into two equal groups, and (4) partitioning the data into four equal groups. The key point to note is that this tool was designed to fit with students' ways of reasoning while simultaneously taking important statistical ideas seriously.

As the research team worked to outline the instructional sequence for the seventh-grade classroom, it reasoned that students would need to encounter situations in which they had to develop arguments based on the reasons for which the data were generated. They would then need to develop ways to analyze and describe the data in order to substantiate their recommendations. The research team anticipated that this would best be achieved by developing a sequence of instructional tasks that involved either describing a data set or analyzing two or more data sets in order to make a decision or a judgment. The students

typically engaged in these types of tasks in order to make a recommendation to someone about a practical course of action that should be followed.

RESULTS OF ANALYSIS

The initial activities of the teacher cohort involved the teachers analyzing data on the braking distances of ten each of two makes of cars, a coupe and a sedan. The teachers were given printouts of the data inscribed in the first computer tool as shown in Figure 1 and asked to decide which make of car they thought was safer, based on this data. My decision to use printouts of the data was based on my own experience in working with students on these tasks. I had noticed that when students were asked to make initial conjectures based on informal analysis of the printouts, their activity on the computer tool seemed more focused. They used the features on the tool to substantiate their preliminary analysis instead of to explore the structures that resulted from the use of the features. I was also curious to see if the tools we had designed offered the teachers the means of analyzing data that fit with their initial, informal ways of analyzing the data.

As the teachers began their analyses, they proceeded to find ways to structure the data that supported their efforts at analysis. In this process, they placed vertical lines in the data to create cut-points and to capture the range of each set. As an example, Mary Jean noted that, “A full forty percent of the coupes stopped in less than 60 feet and if you go to 62 [feet] it goes to sixty [percent] and there are only twenty percent of the sedans below even 62 [feet].” But Gayle disagreed noting that, “Those two that took a long time to stop are significant.” She continued by stating that, “all the sedans stop in around sixty to seventy feet and it might even be better (pointing to the two data values that were less than sixty feet).” Alice followed by arguing that “all of the sedans took over 58 feet to stop” whereas “forty percent of the coupes were able to stop in less than 58 feet.”

It is important to note that the discussions of the various solutions were based on what the teachers judged to be important about *braking*, not about the ways of structuring the data. For example, creating cut points and reasoning about percentages or proportions of the data set above or below the cut point was accepted without justification as a way to structure the data. Questions arose not over the method (e.g. creating cut points), but over warrants for the claims. As an example, Gayle’s disagreement with Mary Jean’s argument was not based on the manner in which Mary Jean had structured the data, but on the conclusion she reached as a result of her particular cut point. This was typical of the discussions of all arguments that were presented on tasks using the first computer tool. As a result, what became constituted in the course of public discourse was partitioning data sets and reasoning about the proportions formed. Arguments then had to be formulated to justify claims made from such partitions — not to justify the act of partitioning and reasoning about proportions. This is an important distinction in that it indicates that the first normative way of reasoning or mathematical practice that became constituted within the cohort was that of partitioning data sets and reasoning about resulting proportions.

A shift to the second computer tool began with the introduction of the speed trap task. The task was based on data collected on the speeds of two sets of sixty cars. The first data set was collected on a busy highway on a Friday afternoon. Speeds were recorded on the

first sixty cars to pass the data collection point. The second set of data was collected at the same location on a subsequent Friday afternoon after a speed trap had been put in place. The goal of the speed trap (e.g. issuing a large number of speeding tickets by ticketing anyone who exceeds the speed limit by even 1 mile per hour) was to slow the traffic on a highway where numerous accidents typically occur. The task was to determine if the speed trap was effective in slowing traffic (see Figure 2 for the speed trap data displayed in the second computer tool).

As the teachers worked on their analysis, most of them drew a vertical line across the two data sets to create a cut point at the speed limit and reasoned about the number of drivers exceeding the speed limit both before and after the speed trap. They used a range of strategies to describe the partitions including ratios and percentages. As they worked, their arguments indicated that they were reasoning about the data as *aggregate* (cf. Konold, et al, in preparation). In particular, the perceptual unit in their analysis was the entire distribution of values. They reasoned about the relative number of cases in various parts of the distribution (e.g. exceeding the speed limit), and did so in terms of percentages and/or proportions. For this reason, they were concerned with the relative density of the data in certain intervals. In particular, they were concerned about the amount of data clustered within an interval across the data sets (e.g. number of cars exceeding the speed limit both before and after the speed trap).

As an example, Regis created cut points at 50 miles per hour (mph), 53 mph, and 55 mph. He then examined the data to look for shifts within those intervals. He argued that before the speed trap, 25 drivers were traveling in excess of 55 mph. After the speed trap, that number was reduced to 10. He then argued, “that’s 15 less and since the sample was 60, 15 out of 60 is 25%. So 25% fewer drivers were speeding.” It appeared that in the course of making this argument, Regis was able to coordinate the differences in the frequencies (e.g. analogous to the y values) across the x-axis in a multiplicative sense (cf. Thompson, 1994). This type of reasoning was typical of the solutions developed by the teachers and indicates that the second normative way of reasoning involved a concern for relative density across data sets where the teachers viewed data as aggregate.

The final collection of tasks in the instructional sequence involved data sets with unequal numbers of data points. In the first task from this collection, data was presented on two sets of AIDS patients enrolled in different treatment protocols — a traditional treatment program with 186 patients and an experimental treatment program with 46 patients. T-cell counts were reported on all 232 patients (see Figure 3). The task was to determine which treatment protocol was better at producing high T-cell counts. As the teachers worked on their analysis, they initially noted that the clump, cluster, or hill of the data shifted between the two groups. In particular, they characterized the shift by creating cut points around a T-cell count of 525 and reasoning about the percentage of patients in each group with T-cell counts above the cut point. They noted that the cluster of T-cell counts in the traditional treatment program was below the cut point whereas the cluster of T-cell counts in the experimental was above. In addition, they could use the four-equal-groups inscription to further tease out the differences in how the data were distributed. As an example, Diane reasoned that, “seventy-five percent of the patients in the experimental

treatment group are in the same range as only 25% of the patients in the traditional treatment.”

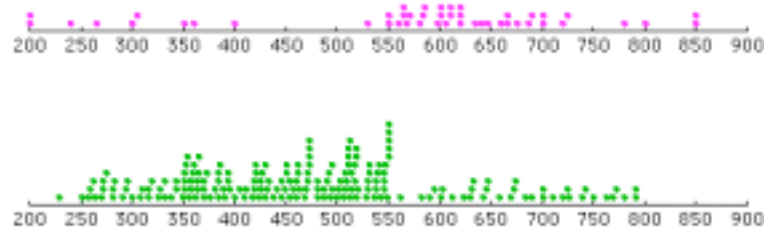

Figure 3. AIDS data displayed in the second computer tool.

Thompson (personal communication, October, 2002) notes that the ability to scan the axis from left to right and read the frequency as the rate at which the total accumulates over the x-axis is what is entailed in seeing distributions as density functions. This concern for relative density is a step towards what Thompson views as an endpoint in reasoning about distributions. This density perspective is consistent with what Khalil and Konold (2002) found in their analysis of expert data analysts.

Although this analysis does not permit claims about the teachers’ ability to view the data sets in such a sophisticated manner, the results of their analysis do indicate that they were coordinating the relative frequencies as they worked to find ways to describe the shifts in the data. The third normative way of solving tasks that emerged was therefore that of structuring the data multiplicatively to describe shifts and changes in the distributions.

CONCLUSION

The resulting shifts that emerged in the normative ways of reasoning indicate a mathematical progression over the course of the year. In particular, the first practice to emerge was that of partitioning data sets and reasoning about resulting proportions. The second practice entailed a concern for relative density across data sets where the teachers viewed data as aggregate. The third and final practice involved the ability to view the data in two data sets distributed on the x-axis and simultaneously coordinate the relative density of the distributions when structured multiplicatively. These normative ways of reasoning or mathematical practices can be thought of as the realized learning route (cf. Simon, 1995) of the community. As a result, the practices that emerged in the course of interaction document the learning of the teacher cohort by characterizing changes in collective mathematical activity while highlighting the diversity in individual teachers’ reasoning.

References

- Cobb, P. (1999). Individual and collective Mathematical learning: The case of statistical data analysis. *Mathematical Thinking and Learning*, 5-44.
- Cobb, P., Stephan, M., McClain, K., & Gravemeijer, K. (2001). Participating in classroom mathematical practices. *Journal for the Learning Sciences*, 10(1&2), 113-164.
- Cobb, P., & Whitenack, J.W. (1996) A method for conducting longitudinal analyses of classroom videorecordings and transcripts. *Educational Studies in Mathematics*, 30, 458-477.
- Cobb, P. & Yackel, E. (1996). Constructivist, emergent, and sociocultural perspectives in the context of developmental research. *Educational Psychology*, 31, 175-190.
- Glaser, B. & Strauss, A. (1967). *The discovery of grounded theory: Strategies for qualitative research*. Chicago: Aldine.
- Harel, G. & Confrey, J. (1994) *The development of multiplicative reasoning in the learning of mathematics*. NY: SUNY Press.
- Khalil, E. & Konold, C. (2002) *How experts and novices visually inspect graphs*. Poster presented at the annual meeting of the North American Chapter of the International Group for the Psychology of Mathematics Education, Athens, GA.
- Konold, C., Khalil, E., Higgins, T., & Russell, S.J. (in preparation), *Data seen through different lenses*.
- McClain, K., & Cobb, P. (2001). Supporting students' ability to reason about data. *Educational Studies in Mathematics*, 45(1-3), 103-129.
- Simon, M. A. (2000). Research on mathematics teacher development: The teacher development experiment. In A. Kelly & R. Lesh (Eds.), *Handbook of research design in mathematics and science education*. Hillsdale, NJ: LEA.
- Thompson, P.W. (1994). The development of the concept of speed and its relationship to concepts of speed. In G. Harel and J. Confrey (Eds.) *The Development of Multiplicative Reasoning in the Learning of Mathematics*. (pp. 179-234). NY: SUNY Press.
- Thompson, P. & Saldanha, L. (2000). *To understand post counting numbers and operations*. White paper prepared for the National Council of Teachers of Mathematics.

DESCRIBING THE PRACTICE OF EFFECTIVE TEACHERS OF MATHEMATICS IN THE EARLY YEARS

Andrea McDonough

Doug Clarke

Australian Catholic University

Australian Catholic University

Within a major numeracy project, there were marked differences in achievement between classes, which, as reported in Sullivan and McDonough (2002), we attribute to the teachers. To gain insights into the practices of effective teachers, six case studies of highly effective teachers at the Prep (first year of school) to Grade 2 level were conducted. This paper shares the research methodology and insights into the practices of the case study teachers. It suggests that the description of the practices of effective teachers can inform the work of those involved in teacher education.

INTRODUCTION

Few would dispute that the knowledge, beliefs and practice of the teacher are major influences on learning in the mathematics classroom. As a result, those responsible for teacher education (both preservice and inservice) seek to assist preservice and inservice teachers to develop the knowledge and skills likely to increase their effectiveness. But what is it that effective teachers do? This paper shares insights from intensive case studies of six highly effective teachers. These teachers were participating in a large scale numeracy project, focusing on the first three years of school, and they were chosen because of the particularly impressive growth in their students' understanding of mathematics, as revealed by a one-to-one interview. We believe that descriptions of the practice of these particularly effective teachers that arose from these case studies provide a framework that will be useful to all those involved in mathematics teacher education.

CHARACTERISTICS OF EFFECTIVE TEACHERS

Classrooms and schools are complex places. To gain insights into what goes on in effective classrooms, that is, how teachers might best assist children to grow in mathematical understandings in these environments, it is of value to study the practices of those who are effective.

For many years researchers have sought to describe teacher behaviours that correlate positively with growth in student achievement. For example, as early as the 1970s and 1980s, the so-called *process-product* research sought to describe behaviours that correlated positively with student achievement (see, e.g., Brophy & Good, 1986). More recent research has provided a range of insights into the practices of effective teachers.

Within the large scale numeracy project drawn upon for the present paper, a study was conducted of growth in understandings related to Length for children in their first year of schooling (Sullivan & McDonough, 2002). It revealed marked differences in achievement between classes, irrespective of geographic or socioeconomic variables. Interviews with the most effective teachers revealed that they had a clear vision of the mathematical experiences needed, were able to engage the students, and were prepared to probe the thinking and understanding of the children.

In a major study of effective primary school mathematics teaching in the United Kingdom, Askew, Brown, Rhodes, Johnson and Wiliam (1997) studied the practices of a number of different teachers, with varying levels of effectiveness. Using mean class gains on a test involving aspects of the number system, computation, and problem solving, orally administered by teachers with children writing their answers, teachers were grouped into broad categories according to effectiveness. Insights into the practices of effective teachers came primarily from focus schools and case studies of individual teachers, six of whom were identified as highly effective.

The teaching practices of the highly effective teachers

- connected different ideas of mathematics and different representations of each idea by means of a variety of words, symbols and diagrams;
- encouraged students to describe their methods and their reasoning, and used these descriptions as a way of developing understanding through establishing and emphasising connections;
- emphasised the importance of using whatever mental, written or electronic methods are most efficient for the problem at hand; and
- particularly emphasised the development of mental skills.

Brown, Askew, Baker, and Millett (1998, p. 373) noted that international observational studies “seem to show some agreement on some of the aspects of teacher quality which correlate with attainment. These included the use of higher order questions, statements and tasks which require thought rather than practice; emphasis on establishing, through dialogue, meanings and connections between different mathematical ideas and contexts; collaborative problem solving in class and small group settings; and more autonomy for students to develop and discuss their own methods and ideas.”

Reflecting on a range of research studies, Brown (1999) noted also that “quality of teaching is more important than class organisation. ... it’s not whether it’s whole-class, small group or individual teaching but rather what you teach and how you interact mathematically with children which seems to count” (p. 7).

The six intensive case studies discussed in this paper provide much support for the findings of others, while adding new insights to the discussion.

THE EARLY NUMERACY RESEARCH PROJECT

To explore the features of highly effective teaching of mathematics, we draw on results from the Early Numeracy Research Project (ENRP)¹ that investigated mathematics teaching and learning in the first three years of schooling, involving teachers and children in 35 project (“trial”) schools and 35 control (“reference”) schools (for details see Clarke, 2001; Clarke, McDonough, & Sullivan, 2002).

There were three key components within the ENRP:

- the development of a research-based framework of “growth points” in young children's mathematical learning (in Number, Measurement and Geometry);
- a 40-minute, one-on-one interview, used by all teachers to assess aspects of the mathematical knowledge of all children at the beginning and end of the school year (February/March and November respectively);
- extensive professional development at central, regional and school levels, for teachers, coordinators, and principals.

The ENRP framework of growth points in young children's mathematical learning encompassed nine mathematical domains within three strands: Number (Counting, Place value, Addition and subtraction strategies, Multiplication and division strategies); Measurement (Length, Mass, Time); and Space (Properties of shape, Visualisation orientation).

Within each domain typically five or six growth points were stated with brief descriptors for each. To illustrate the notion of a growth point, consider the child who is asked to find the total of two collections of objects (with nine objects screened and another four objects). Many young children “count-all” to find the total (“1, 2, 3, . . . , 11, 12, 13”), even once they are aware that there are nine objects in one set and four in the other. Other children realise that by starting at 9 and counting on (“10, 11, 12, 13”), they can solve the problem in an easier way. Counting All and Counting On are therefore two important growth points in children’s developing understanding of Addition. The ENRP Growth Points informed the creation of assessment items for the one-to-one interview, and the recording, scoring and subsequent analysis. For examples of ENRP growth points and interview tasks within the domain of Multiplication and division strategies, see Sullivan, Clarke, Cheeseman, and Mulligan (2001) and within the domain of Length see Sullivan and McDonough (2002).

Interviews were conducted by the classroom teachers, who were trained in all aspects of interviewing and recording. The processes for assuring reliability of scoring and coding are outlined in Rowley and Horne (2000).

The data from the ENRP arise from intensive interviews with large numbers of children, with trained interviewers, and experienced coders, with double data entry, and using a framework for learning based on interpretation of research. We argue that these data provide a reliable measure of learning, and a further perspective on previous research on the ways that teachers influence student learning.

IDENTIFYING HIGHLY EFFECTIVE ENRP TEACHERS

While the three key components of the ENRP, as listed above, informed, involved, and potentially empowered the project teachers, it was the teachers, professional learning teams, and schools who ultimately made the decisions of whether and how the information and experiences provided within the project would impact upon their classroom practice. The approach taken fits with Doyle’s (1990) Reflective Professional paradigm according to which both preservice and inservice teacher education should

foster capacities of observation, analysis, interpretation, and decision making. ... Within this framework, research and theory do not produce rules or prescriptions for classroom application but rather knowledge of methods of inquiry useful in deliberating about teaching problems and practices. (Doyle, 1990, p. 6)

Rather than a recipe, the notion of rich ingredients that are combined to meet the needs of individual children, the mathematics and the teaching context, using the professional judgement of teachers, was the approach taken. For this reason, the practices of effective teachers were not determined by the researchers and could not be anticipated.

The key criterion for selection of highly effective teachers, that is, student growth, was ascertained from interview results for 1999 and 2000 showing children’s mathematical growth across the nine ENRP framework domains. The six case study teachers with high student growth were chosen to represent a cross section of grades with one teacher from

each of Grade Prep (first year of school in Victoria), Grade Prep/1 Grade 1, Grade 1/2 and Grade 2. One highly effective teacher of Prep children from predominantly non-English speaking backgrounds was selected also for study. The case study teachers had taught within the ENRP and at the same level for the three years of the project, and represented a cross-section of situations such as school location and school socio-economic profile. The teachers are later referred to by grade level (e.g., Ms Grade 1), except for the teacher of the non-English speaking background children: Ms NESB.

Being mindful of the need to avoid spurious conclusions, the case study methodology incorporated corroboratory and alternative sources of data (LeCompte & Goetz, 1982).

The six teachers were studied intensively through use of the following data sources:

- five lesson observations by teams of two researchers (three consecutive days in the middle of the school year, and two consecutive days a couple of months later), incorporating detailed observer field notes, photographs of lessons and collection of artefacts (e.g., worksheets, student work samples, lesson plans);
- teacher interviews following the lessons (audiotaped and transcribed) to discuss the teacher intentions for the lesson, and what transpired;
- teacher questionnaires completed through the duration of the project; and
- teacher responses to other relevant questions and tasks posed to them.

Decisions needed to be made on the kinds of notes that would be taken in the lesson observations. The decision was taken to attempt to note as much as possible of what transpired in the lesson in a relatively “free” form. We were guided in this decision by the experience of others. For example, Stigler and Baranes (1988) conducted mathematics classroom observations in three countries using two methods. In the first, a structured coding scheme was used with an elaborate time sampling plan. It was therefore possible to obtain estimates of the percentage time given to various classroom activities. In the second study, the researchers “decided to trade the greater reliability of an objective coding scheme, for the inherent richness of detailed narrative descriptions of mathematics lessons” (p. 294). The ENRP research team made the same decision.

However, the research team did agree on a broad framework for the observations, interviews and analysis made up of nine categories: Mathematical focus; Features of tasks; Materials, tools and representations; Adaptions/connections/ links; Organisational style(s), teaching approaches; Learning community and classroom interaction; Expectations; Reflection; and Assessment methods. This framework was chosen to be quite broad, to avoid constraining our observations because of what we may have hoped to see. Our aim was to describe the practice of demonstrably effective teachers and to look ultimately for common themes, not to judge.

Many steps were involved in the case study data collection and analysis, beginning with detailed observer notes of each lesson using a laptop to record as much as possible of what was said and what happened, without interpretation. After each of the lesson observations by two observer/researchers, independent analysis of the lesson was carried out according to the categories agreed upon by the team and listed above.

Following the first three lessons each observer/researcher team worked together to produce a summary statement for the teacher. These statements were shared verbally with the research team in a meeting in which two “critical friends”, not involved in the

research, then provided feedback on the kinds of themes they were hearing. This process occurred again after five lessons had been observed for each teacher.

	Effective teachers of Prep to Grade 2 mathematics . . .
Mathematical focus	<ul style="list-style-type: none"> • focus on important mathematical ideas • make the mathematical focus clear to the children
Features of tasks	<ul style="list-style-type: none"> • structure purposeful tasks that enable different possibilities, strategies and products to emerge • choose tasks that engage children and maintain involvement
Materials, tools and representations	<ul style="list-style-type: none"> • use a range of materials/representations/contexts for the same concept
Adaptions/ connections/ links	<ul style="list-style-type: none"> • use teachable moments as they occur • make connections to mathematical ideas from previous lessons or experiences
Organisational style(s), teaching approaches	<ul style="list-style-type: none"> • engage and focus children’s mathematical thinking through an introductory, whole group activity • choose from a variety of individual and group structures and teacher roles within the major part of the lesson
Learning community and classroom interaction	<ul style="list-style-type: none"> • use a range of question types to probe and challenge children’s thinking and reasoning • hold back from telling children everything • encourage children to explain their mathematical thinking/ideas • encourage children to listen and evaluate others’ mathematical thinking/ideas, and help with methods and understanding • listen attentively to individual children • build on children’s mathematical ideas and strategies
Expectations	<ul style="list-style-type: none"> • have high but realistic mathematical expectations of all children • promote and value effort, persistence and concentration
Reflection	<ul style="list-style-type: none"> • draw out key mathematical ideas during and/or towards the end of the lesson • after the lesson, reflect on children’s responses and learning, together with activities and lesson content
Assessment methods	<ul style="list-style-type: none"> • collect data by observation and/or listening to children, taking notes as appropriate • use a variety of assessment methods • modify planning as a result of assessment
Personal attributes of the teacher	<ul style="list-style-type: none"> • believe that mathematics learning can and should be enjoyable • are confident in their own knowledge of mathematics at the level they are teaching • show pride and pleasure in individuals’ success

Figure 1. Common themes emerging from ENRP case studies of effective teachers.

Following the lesson observations, interviews and meetings with the “critical friends”, it was decided to use the original framework to describe the practices of effective teachers. For each of the nine categories, one researcher was responsible for identifying common themes within summary documents, and summarizing within tables. These tables were checked by the teams of researcher/observers to ensure accurate interpretation of teacher summaries and that all themes were substantiated by data collected within the study. The tables were also cross-referenced with reports from the “critical friends”. From this

process a list of 25 practices of effective teachers evolved. It was agreed to list common elements where evidence was available for at least four of the six teachers.

THE PRACTICES OF HIGHLY EFFECTIVE TEACHERS

The description of effective teachers, as revealed in this study, is given in Figure 1 above. Because of their relative brevity as compared to field notes, a selection of classroom vignette summaries, teacher interview statements and observer/researcher summaries are shared below to illustrate practices of these teachers.

ILLUSTRATING EFFECTIVE PRACTICES

Two of the 25 effective teacher themes are illustrated below. The first is “Effective early numeracy teachers hold back from telling children everything.”

In a lesson observed in Ms NESB’s Prep class, the teacher worked with a group making two digit numbers. Each child chose a card with a two digit number written on. (The teacher had removed the ‘teen’ and ‘decade’ numbers.) The children then used base 10 blocks (tens and ones) to build a model of their selected number. Ms NESB watched the students build their models, which most children did correctly. Ahmed had the number 52, but he built a model of 25. The teacher watched, but did not intervene. After a few minutes, the teacher asked if everyone had finished building. She then told them each child would explain their model.

As Ms NESB gave these instructions, Ahmed looked at the other children’s models, and changed his to correctly show 52. The teacher noticed, but said nothing. Several children were asked to explain their models. While this happened, Ahmed changed his model back to show 25. The teacher looked at his model and said, “Let’s come back to you, Ahmed.”

Several other children explained their models, and Ahmed again changed his model to correctly show 52. The teacher then asked the other children: “Is Ahmed’s correct now?” The children all affirmed this and Ahmed was able to explain his model.

Ms NESB explained later why she did not draw the child’s attention to the error. She believed Ahmed could correctly model 52, and that he would eventually correct this himself by comparing to other children’s models. “Ahmed knew he’d made a mistake, it just took him a while, as soon as he started counting he realised he’d made a mistake.” She involved the other children in confirming Ahmed’s thinking.

A second theme is “Effective early numeracy teachers listen attentively to individual children.”

This feature of Ms Prep’s teaching was observed repeatedly over the classroom observations. Ms Prep seemed to talk directly to individuals when interacting with them. These discussions had the characteristics of an individual conversation, even when student initiated. The research/observer summary report following the first three visits included the following comment:

[The teacher] was very positive towards the children. She praised them for their thinking. She showed caring and respect for individual children, giving them her attention even when within a group situation. She answered individual children’s questions and followed their train of thinking, unless it was totally off the topic. In an interview following a lesson observation she

explained that if a child asks a question she will answer “even if ... the rest of the class is rolling around the floor. I think, quick, I have got to explain that with this child so that they go away knowing or understanding what they have done.”

Summary statements written at the end of the data collection by the researcher/observers for two other case study teachers included the following:

Ms Grade 1/2 was a caring teacher, who listened carefully to children and their strategies in solving problems ... She endeavored to find out where the children were at, and to extend and challenge them appropriately.

Ms Grade 2’s classroom was a place where learning mathematics was taken seriously. It was also infused with enjoyment, success and appreciation. Expectations were very high in terms of both content and mathematical behaviours. Learning opportunities were carefully and thoughtfully structured for her children. Fundamentally each child was required to engage with a specific mathematical concept in a lesson and given some flexibility, choice or options within which to work. ... Ms Grade 2 communicated with children in a highly personalised way and knew about the thinking of individuals.

A common element within these reports is the attention given by teachers to individual children and their learning through one-to-one interaction and focused listening, which commonly informed planning of appropriate learning experiences. This interaction was not dependent on class organization strategies, with, for example, Ms Grade 1/2 frequently working with a small group and Ms Grade 2 always observed to work with her class as a whole. It appears that it was the interaction features illustrated here, combined with others practices from the list of 25 provided in Figure 1 that enabled these teachers to be highly effective in their teaching of mathematics.

CONCLUSION

It is interesting to consider the extent to which the list of 25 teacher behaviours and characteristics presented in Figure 1 has application to other grade levels. We believe that similar research in Grades 4-12 (and possibly beyond) would yield many elements in common with these. As suggested earlier in this paper, there is potential for teacher education courses to be informed by the findings from this research on highly effective teachers of mathematics. If further research reveals such applicability then this has implications for all educators of preservice and inservice teachers of mathematics.

¹The Early Numeracy Research Project (ENRP) was a collaborative venture between Australian Catholic University, Monash University, the Victorian Department of Education and Training, the Catholic Education Office (Melbourne), and the Association of Independent Schools Victoria. The project was funded in 35 project (“trial”) schools and 35 control (“reference”) schools. The views presented here are those of the authors.

References

- Askew, M., Brown, M., Rhodes, V., Johnson, D., & Wiliam, D. (1997). *Effective teachers of numeracy: final report*. London: King’s College.
- Brophy, J. E., & Good, T. L. (1986). Teacher behavior and student achievement. In M. C. Wittrock (Ed.), *Handbook of research on teaching* (3rd ed., pp. 328-375). New York: Macmillan.
- Brown, M. (1999). Is more whole class teaching the answer? *Mathematics Teaching*, 169, 5-7.

- Brown, M., Askew, M., Baker, D., Denvir, B., & Millett, A. (1998). Is the National Numeracy Strategy research-based? *British Journal of Educational Studies*, 46(4), 362-385.
- Clarke, D. M. (2001). Understanding, assessing and developing young children's mathematical thinking: Research as powerful tool for professional growth. In J. Bobis, B. Perry, & M. Mitchelmore (Eds.), *Numeracy and beyond* (Proceedings of the 24th Annual Conference of the Mathematics Education Research Group of Australasia, Vol. 1, pp. 9-26). Sydney: MERGA.
- Clarke, B., McDonough, A., & Sullivan, P. (2002). Measuring and describing learning: The Early Numeracy Research Project. In A. D. Cockburn & E. Nardi (Eds.), *Proceedings of the 26th Conference of the International Group for the Psychology of Mathematics Education* (Vol. 1, pp. 181-185). Norwich, United Kingdom: School of Education and Professional Development, University of East Anglia.
- Doyle, W. (1990). Themes in teacher education research. In W. R. Houston (Ed.), *Handbook of research on teacher education* (pp. 3-41). New York: Macmillan.
- LeCompte, M. D., & Goetz, J. P. (1982). Problems of reliability and validity in ethnographic research. *Review of Educational Research* 52(1), 31-60.
- Rowley, G., & Horne, M. (2000, December). *Validation of an interview schedule for identifying growth points in early numeracy*. Paper presented to the Australian Association for Research in Education Annual Conference, University of Sydney, New South Wales.
- Stigler, J. W., & Baranes, R. (1988). Culture and mathematics learning. In E. Z. Rothkopf (Ed.), *Review of research in education* (pp. 253-306). Washington, D.C.: American Educational Research Association.
- Sullivan, P., Clarke, D. M., Cheeseman, J., & Mulligan, J. (2001). Moving beyond physical models in learning multiplicative reasoning. In M. van den Heuvel-Panhuizen (Ed.), *Proceedings of the 25th annual conference of the International Group for the Psychology of Mathematics Education* (Vol. 4, pp. 233-240).
- Sullivan, P., & McDonough, A. (2002). Teachers differ in their effectiveness. In A. D. Cockburn & E. Nardi (Eds.), *Proceedings of the 26th Conference of the International Group for the Psychology of Mathematics Education* (Vol. 4, pp. 249-256). Norwich, United Kingdom: School of Education and Professional Development, University of East Anglia.

MATHEMATICS TEACHER PROFESSIONAL DEVELOPMENT AS THE DEVELOPMENT OF COMMUNITIES OF PRACTICE

Rebecca McGraw

University of Arizona

Fran Arbaugh

University of Missouri –
Columbia

Kathleen Lynch,

Catherine A. Brown
Indiana University –
Bloomington

In this research report we share results of a study of an adaptation of Lesson Study, a form of professional development typically used in Japanese elementary schools, with secondary mathematics teachers in the United States. We draw on Wenger's (1998) concept of "communities of practice" and Grossman, Wineberg, and Woolworth's (2001) discussion of "pseudocommunity" to present our analysis of two types of activities: a cycle of lesson development, implementation, and revision as it occurred in one lesson study group (LSG), and book discussions that occurred in large group meetings all LSGs. Our analysis suggests that activities such as these can support community of practice development and that "community development" is useful as a concept for structuring and studying mathematics teacher professional development.

Many teachers and providers of professional development have become interested in Lesson Study, a form of professional development typically used in Japanese elementary schools (Stigler & Hiebert, 1998). In Japan, *research lesson* or *study lesson* refers to lessons that teachers jointly plan, observe and discuss. The same two words in reverse order, *lesson research* or *lesson study*, refer to an instructional improvement process of which the research lesson is the heart (Lewis, 2000). When a Japanese school engages in *Lesson Study*, teachers form *Lesson Study Groups* (LSGs). (See Lewis, 2000 for an extended discussion of LSGs and the process of Lesson Study.)

In this research report, we share some results of the use of an adaptation of Lesson Study with secondary mathematics teachers in the United States. The research was conducted as part of a professional development project titled Collaboration for Enhancing Mathematics Instruction (CEMI), funded by Lucent Technologies Foundation. CEMI lesson studies are conducted in LSGs consisting of middle and high school mathematics teachers, university mathematicians, university mathematics educators, and pre-service secondary mathematics teachers. The CEMI participants began meeting as a large group and in their smaller LSGs during the fall of 2000. We report here on the activities of one LSG during the spring of 2001 and the large group during the spring of 2002. It is the goal of the CEMI project to adapt the Japan lesson study model for several purposes including providing professional development for project participants and bringing together people with diverse perspectives but with the common goal of providing secondary students with quality mathematics education. The research component of the

project seeks to understand these activities and their impact on the participants and the participants' classroom teaching.

We present here results from analyses of two types of CEMI activities. The first activity consisted of a cycle of planning, implementation, and reflection engaged in by one LSG. The second activity consisted of a series of book discussions engaged in by the CEMI project participants as a whole. Wenger's (1998) indicators of communities of practice and Grossman et al.'s (2001) discussion of *pseudocommunity* guided our analyses.

This report is one piece in an ongoing research project. Previous analysis presented at PME-NA (Brown, McGraw, Koc, Lynch, & Arbaugh, 2002) focused on aspects of assistance (Tharp & Gallimore, 1988) present in lesson study activities. In this report, we look more broadly at the activities of the CEMI project in an effort to understand how communities of practice may develop in this context. Examining the data in multiple ways through different lenses allows us to understand better this particular professional development experience and the ways in which this experience supports teachers' professional growth. Considering two CEMI professional development activities in the first and second year of the project from a community of practice perspective, we address the following questions.

To what extent have communities of practice developed within a LSG?

To what extent can a LSG be characterized as a community of practice?

What are the specific indicators of community of practice formation or lack thereof in the context of the LSG work?

To what extent can the CEMI participants as a group be characterized as a community of practice?

In addition, in the conclusion of this report, we discuss how the work presented here influences the future direction of our research and professional development efforts.

Learning and Communities of Practice

Underlying the analyses presented here is a focus on learning as a social process that occurs through participation in practice.

Learning in this sense is not a separate activity. It is not something we do when we do nothing else or stop doing when we do something else.... Learning is an integral part of our everyday lives. It is part of our participation in our communities and organizations. The problem is not that we do not know this, but rather that we do not have very systematic ways of talking about this familiar experience. (Wenger, 1998, p.8)

Adopting this perspective on learning, we focus on participation in the practice of teaching as we try to understand and support mathematics teacher learning.

Notably absent from the lives of teachers in the U.S. and elsewhere is the opportunity to develop and/or participate in professional communities as an integral part of the practice of teaching. This does not mean that teachers do not learn, but rather they are limited in their ability to learn *from each other* because they do not regularly engage in practice *with each other*. From a learning through participation perspective, we can cast our work as teacher educators (and, we suspect, recent work of many teacher educators) in part as

an effort to help teachers develop professional communities based in practice, or, to use Wenger's (1998) term, *communities of practice*.

Communities of practice are communities developed out of and defined by members' collective engagement in a joint enterprise (Wenger 1998). It is through this engagement that meanings are negotiated and a shared repertoire of routines, words, tools, and ways of doing things are developed. Because communities of practice are typically informal structures, indicators that they have formed can be found in the ways members interact, rather than in formal statements or the attainment of specified goals. Some indicators that a community of practice has formed include: (1) shared ways of engaging in doing things, (2) the rapid flow of information among members, (3) the absence of introductory preambles, (4) the quick setup of a problem to be discussed, (5) knowing what others can contribute, (6) ability to assess the appropriateness of actions or products, (7) specific tools, representations, and other artifacts, (8) local lore, shared stories, and inside jokes, and (9) jargon and shortcuts to communication (Wenger, 1998). Using these indicators, we can consider the extent to which our professional development efforts result in the formation of communities of practice.

For this analysis, we also draw upon the notion of *pseudocommunity* (Grossman et al., 2001).

As community starts to form, individuals have a natural tendency to *play community* – to act as if they are already a community that shares values and common beliefs.... The imperative of pseudocommunity is to “behave *as if* we all agree.” (p. 955)

In pseudocommunities, individuals do not question or challenge each other. Speaking in generalities without negotiating meanings allows individuals to maintain a superficial level of agreement during conversations. Behaviors associated with pseudocommunity are expected when a group of individuals is first brought together; however, if true community is to form, then individuals must begin to press for clarification, raise alternative viewpoints, or in some way attempt to negotiate shared, collective, community-level meanings and modes of action.

We believe communities of practice could be fertile ground for teacher learning, and, therefore, are interested in the extent to which they develop in various settings. We do not wish to give the impression, however, that the content of learning within such communities is unimportant. As previously stated, this paper is one piece in an ongoing research project concerned with not only the creation of sites for mathematics teacher learning, but also the substance and nature of the learning that occurs within those sites.

CONTEXT AND METHODOLOGY

CEMI supported three LSGs in the spring of 2001. Each LSG was charged with following a lesson study cycle similar to that used by Japanese elementary teachers: develop a lesson collaboratively, teach the lesson, revise the lesson, teach the lesson again, and revise the lesson again. We report on one of the three LSGs in this paper. (We call this focus lesson study group LSG1.) The members of LSG1 were two in-service secondary mathematics teachers, Mr. Davis and Ms. Cochran; two pre-service secondary mathematics teachers; one university mathematician; one mathematics education

professor; and two mathematics education doctoral students. The LSG met six times and the planned lesson was taught by each of the two teachers.

LSG group work continued during the fall semester of 2001. Members were added and groups reconfigured according to individual interests and teachers' teaching assignments. During this semester, the mathematics educators (professors and doctoral students) raised a concern about the need for balance within the project between curriculum development and reflection on issues related to teaching and learning mathematics. Consideration of research is an integral component of lesson study in Japan, but not typically considered a part of the practice of teaching in the U.S. The project leader suggested that it might be useful to temporarily suspend LSG activities in order to read and discuss books related to important issues in mathematics education and other project participants voiced support for the idea. Instead of meeting in their individual LSGs, CEMI participants met five times during the spring of 2002 as a whole group to discuss three books (agreed upon by the participants): *Beyond Formulas in Mathematics Teaching and Learning* (Chazan, 2000), *The Learning Gap* (Stevenson & Stigler, 1992), and *The Teaching Gap* (Stigler & Hiebert, 1999).

The data used for this report are two-fold and were collected in the spring semester of 2001 and the spring semester of 2002. We report on the activities of one LSG during the spring of 2001 and of the large group during the spring of 2002. Data collected from LSG1 pertaining to this report were audio-taped accounts of six meetings. In addition, we utilized audio-taped accounts of five large group book discussion meetings from the spring of 2002.

Audiotapes were transcribed and transcripts were verified for accuracy. Data were coded using the indicators of community of practice (Wenger, 1998) described previously. The first three authors used data from two LSG1 meetings to negotiate meanings of codes and establish inter-rater reliability. Subsequent coding of the remainder of the data was divided among the first three authors. We then extended our analysis and searched for indicators of pseudocommunity (Grossman et al., 2001) or lack thereof in LSG1 activities and large group book discussions.

RESULTS

Indicators of community of practice, such as the lack of introductory preambles, the rapid flow of information among members, and the use of tools, and artifacts, were noticeably absent from the early meetings of LSG1, but were more prevalent in later meetings. LSG1 members decided to focus their lesson plans on developing second-year algebra students' understandings of sequences and series. Between planning meetings, group members located materials related to the topic and then spent considerable time during the initial planning meetings sharing and discussing these materials. The following excerpt is representative of the context of these discussions.

I think if we do something like the auditorium problem, and you're given the information.... Your friend buys you a concert ticket in seat 995 in a concert hall. Sixty-five seats in row one, 67 seats in row two, 69 seats in row three. So the number of seats in a row, and they understand that there are going to be two added to each row.... And then you have the questions. How many seats in the last row? How many seats total in the concert hall?
(unidentified LSG1 member, 3/21/01)

Explanations like this occurred frequently during initial LSG1 meetings. Members spent time describing their individual interests and concerns with respect to teaching sequences and series, various methods for organizing classroom activities, and the ways in which they felt they could contribute to the group. For example, Ms. Cochran informed the group that she had easy access to a computer lab should they need one. Although this may be considered as evidence that a community of practice has not formed, we view it as a necessary precursor to community development, leading to a point in the future when group members will have shared knowledge of certain problems, and an understanding of what others know and can do related to lesson development and implementation.

Evidence exists across LSG1 meetings of members challenging one another. One such exchange involved whether to allow students to use graph paper to divide shapes into fractional parts (students would then find the sum of the parts as a way to estimate the sum of an infinite series):

Is there a certain kind of graph paper that we could use that would lend itself to this kind of drawing – that would help them be more exact? ...

Maybe, but I'm not sure that graph paper is the right thing because ... I don't think that being able to draw well is what [we want them] to think about...

I wonder in terms of drawing whether it might be even easier to have people cut out the triangles... (exchange between members at the 3/21/01 LSG1 meeting)

This excerpt is the beginning of a protracted debate over how to have students carry out this activity in a way that would maximize their understanding of fractional parts and their sum. Exchanges such as this one are evidence that these LSG1 members were not strictly bound by the norms of agreement indicative of pseudocommunity. They were willing to make statements that might put themselves in conflict with other group members for the sake of the joint enterprise. Such exchanges occurred not only in the planning phase but also after implementation, during the reflection/revision stage.

As the meetings progressed, we found the LSG1 members beginning to use shortcuts to communicate, for example the use of the term “the concert hall” during the 3/28/01 LSG1 meeting to refer to the problem described previously. We also noted use of jargon such as “connections” and “communication” used to refer to the discussion of specific standards in *Principles and Standards for School Mathematics* (National Council of Teachers of Mathematics, 2000). This jargon came from previous discussions of these standards by CEMI participants as a whole that were appropriated by LSG1. We also found, however, a few instances of the unquestioned use of jargon by group members, such as references to “standards.” The lack of negotiation of meanings of such terms is troublesome, because, without negotiation, a community-level understanding of the term cannot be reached.

We found some evidence in LSG1 activities of inside jokes and the rapid flow of information among group members. We also found a few instances of talk that we consider the precursor to shared ways of doing things and the ability to assess the appropriateness of actions and products. For example, one of the LSG members suggests a method for dividing up the labor of lesson development in a productive manner. This

method of division of labor then would have the potential to become a shared way of doing things in the future.

Overall, as we consider the activities of this LSG, we find not a community of practice, but a group of individuals engaged in a joint enterprise and beginning to develop a shared repertoire of words, tools, and ways of doing things. Identifying some precursors to the indicators of community of practice described by Wenger (1998), we characterize this LSG as having the potential for community development.

Evidence of community of practice among all CEMI participants was extremely difficult to find, at least in the data we analyzed for this report, i.e. the book discussions that constituted the large group activities of the spring of 2002. Because participants made use of the posting and replying feature of the project web site prior to book discussion meetings, we found some instances of individuals knowing what others thought and referring to others' ideas. But this is somewhat different than knowing what someone else knows and can do related to the joint enterprise of planning and implementing a mathematics lesson. In the case of the book discussions, the joint enterprise was simply to read and discuss the books. Although we might call this a kind of practice, it does not seem to be the kind of practice that suggests community development, at least not in our case. This does not mean the book discussions were not a useful part of the CEMI professional development project or that they did not impact the work of the LSGs, but we were unable to see either the indicators of community or the potential for the indicators in the book discussions.

In terms of pseudocommunity, we found a pattern in which participants did not question the positions of others, but were willing to voice alternative viewpoints.

I think Chazen drew some unnecessarily harsh lines ... when he was talking about are variables unknown or are they this or are they that ...

I liked thinking about it because it made me think about math and teaching math in a different way ...

I thought Chazen was too strident in saying the way the traditional people look at it is as the unknown. Maybe that's what he remembers ... [but] it wasn't for me the defining moment between traditional and whatever the current way is ...

I don't think the kids pick up whether it is unknown or whether it is relationship (comments made by four CEMI participants related to Chazen (2000), 2/21/02)

Although multiple reactions to the book are expressed and each speaker's comments relate to those of the previous speaker, we do not see participants challenging each other's statements. This excerpt was typical of the book discussions, in that participants did not often push to reach consensus on issues presented in the books.

DISCUSSION

We are interested in making professional collaboration an integral part of the practice of teaching secondary mathematics. In pursuit of this goal, we seek to understand how such collaborations may be developed and sustained. Analyses of two types of CEMI project activities using Wenger's (1998) indicators of community of practice suggest that the joint enterprise of lesson study may lead members of newly formed LSGs to engage with

each other in ways that could be characterized as “community forming.” We postulate that the creation or appropriation of artifacts, the development of shared knowledge, and the increase over time of the use of shortcuts to communicate that we found in LSG1 are indicative of movement toward community of practice. We also found instances in which LSG1 members were willing to debate how best to design and implement the lesson, indicating a break in the superficial agreement characteristic of pseudocommunity (Grossman et al., 1998). We did find other evidence of pseudocommunity, however, such as the acceptance without negotiation of general but important terms such as “standards.”

Reflecting on the course of CEMI activities through the lenses of community of practice and pseudocommunity, we can see our (and other project mathematics educators’) desire to engage the large group in reading about and discussing issues related to the teaching and learning of mathematics as an attempt to focus attention on participants’ underlying beliefs about teaching and learning, and to stimulate negotiation of meanings for some of the language that went uninterrogated in the LSGs. Analysis of the book discussions shows that although a variety of understandings and interpretations were brought out, negotiation of meanings in order to achieve consensus did not occur. We can speculate that this was due to the lack of a joint enterprise that required consensus. It may also be due to this lack of joint enterprise that we did not find indicators, or the precursors of indicators, of community of practice in the book discussion data.

The research presented here influences the future direction of our work in multiple ways. With respect to CEMI project activities, it suggests we should seek to maintain LSGs over longer periods of time – multiple semesters – so that the groups have opportunities to move beyond the “community forming” stage of development. Also, it would be beneficial to integrate large group and LSG activities so that the various understandings raised in the large group could be negotiated through the joint enterprise of the LSGs. With respect to research, we plan to analyze data on the other LSGs in order to gain greater insight into the community of practice aspects of LSG work. We need also to understand better the extent to which the development of communities of practice in LSGs and other joint activities can be valuable to teachers both individually and collectively.

References

- Brown, C. A., McGraw, R., Koc Y., Lynch, K., & Arbaugh, F. (2002). Lesson study in secondary mathematics. In D. S. Mewborn, P. Szatjn, D. Y. White, H. G. Wiegel, R. L. Bryant, & K. Nooney (Eds.), *Proceedings of the of the twenty-fourth annual meeting of the North American Chapter of the International Group for the Psychology of Mathematics Education*, 3, 1427-1438. Columbus, OH: ERIC Clearinghouse for Science, Mathematics, and Environmental Education.
- Chazan, D. (2000). *Beyond formulas in mathematics teaching and learning: Dynamics of the high school algebra classroom*. New York: Teachers College Press.
- Grossman, P., Wineburg, S., & Woolworth, S. (2001). Toward a theory of teacher community. *Teachers College Record*, 103(6), 942-1012.
- Lewis, C. (April 2000). *Lesson study: The core of Japanese professional development*. Paper presented at the Annual Meeting of the American Educational Research Association, New Orleans, LA. (Available at http://www.lessonresearch.net/AERA_2000.html).

- National Council of Teachers of Mathematics. (2000). *Principles and standards for school mathematics*. Reston, VA: Authors.
- Stevenson, H. W., & Stigler, J. W. (1992). *The learning gap: Why our schools are failing and what we can learn from Japanese and Chinese education*. New York: Simon & Schuster.
- Stigler, J., & Hiebert, J. (1998). Teaching is a cultural activity. *American Educator*, Winter, 4-11.
- Stigler, J. W., & Hiebert, J. (1999). *The teaching gap: Best ideas from the world's teachers for improving education in the classroom*. New York: The Free Press.
- Tharp, R., & Gallimore, R. (1988). *Rousing Minds to Life: Teaching, Learning, and Schooling in Social Context*. New York: Cambridge University.
- Wenger, E. (1998). *Communities of practice: Learning, meaning, and identity*. Cambridge: Cambridge University Press.

THE EMERGENCE OF MATHEMATICAL GOALS IN A RECREATIONAL PRACTICE

Luciano Meira

Federal University of Pernambuco Brazil

Mônica Correia

Federal University of Paraíba
Brazil

While the influence of individuals' participation in practices of economic subsistence on the development of mathematical knowledge has been widely reported in the literature, there are not as many studies about the relationship between cultural life and mathematical cognition in the context of recreational practices. This article reports a study on the development of arithmetical knowledge and reasoning in the context of adults' and children's engagement in a game of dominoes. The study was carried out in a small community in Northeastern Brazil, where twenty-five individuals were regular players of the game. The results show that subjects with little or no formal schooling were highly sophisticated in performing arithmetic operations, examining hypothesis, and coordinating the rules and goals of a complex game. Implications for the study of recreational practices and their interplay with school instruction are discussed.

Very many studies have discussed how the organization of specific professional practices lend support to the development of widely diverse mathematical competencies (e.g., Nunes, Schliemann and Carraher, 1993; Lave, 1988; Saxe, 1991; and many others). Much less of the psychological research on culture and cognition has focused on mathematical activities that people engage in as they participate in recreational practices. We explore in this article various aspects of a specific recreational activity which engages children and adults from a rural community in Northeastern Brazil, players of a domino game called "lustrado". In order to understand the interplay amongst engagement in such activity and the development of mathematical knowledge by players, we employed Saxe's (1991) framework of emergent goals. Saxe describes four parameters that determines the emergence of goals in a practice: 1. The activity structure, as complexes of actions that emerge repeatedly over time through a cyclic structure; 2. Social interactions, in the context of which individuals construct and share specific goals; 3. Artefacts (instrumental tools) and conventions (symbolic means) which function as the material basis for action; and 4. Prior understandings in the form of experiences and knowledge that individuals bring into a practice. Central to Saxe's framework is the notion that goals are emergent phenomena, continuously transforming and being transformed by the social and material structuring of settings. Thus, emergent goals motivate actions which in turn trigger the emergence of new goals. In an important sense, emergent goals do not "belong" to individuals. Rather, they emerge at the intersection of personal understandings, the structure of one's activity, the cultural forms or conventions (e.g., Hindu-Arabic numerals) and cultural artefacts (e.g., currency) of one's practice, and the social interactions among co-participants of the practice. Saxe's (1991) framework was used in this study to the extent that it helped us as researchers to organize, coordinate, describe and interpret the critical relations among actors' purposeful actions and the scenarios of their activities. As suggested above, the emergence of goals has a reciprocal relationship to the activities one is engaged in. Activities are realized through one's actions in specific

settings. These actions involve at the same time cognitive, social, and material aspects of the phenomena under investigation in the form of prior understandings, social interactions, and the use of conventions and artefacts. Thus, the study of emergent goals is expected to contribute to our understanding of how people use and transform mediating tools in activity. The article brings about three sets of contributions: 1. An illustrative analysis of practices from the perspective of Saxe's framework; 2. An interpretive look at the relations between cultural participation and mathematical cognition in the context of a recreational practice; and 3. A discussion of how knowledge constructed outside school might relate to school knowledge.

EMPIRICAL STUDY

The game. Though played with the same pieces and most of the rules of traditional dominoes, the lustrado opens four instead of the regular two ends and the players' main goal is to play the pieces so that the sum of values in all ends is a multiple of five. The game is played by four people each of whom starts up with 6 pieces (out of the 28 set; a subset of 4 pieces is set aside to be used optionally by any of the players as needed). A game is played through several rounds and it ends when any of the players reaches 200 points. In each round players take turns to play their pieces with the goal of building a summation multiple of five (among other goals). Each round comes to an end when any of the players plays his or her last piece (or, as in the traditional domino, none of the players have pieces that match the available ends). The winner at each round gets the sum of all points he or she made during the round (the total sum of all sums multiple of five) plus the multiple of five closest to the sum of values in all pieces not played by his or her opponents. The convention [a;b] will be used to represent the values on the face of a domino. As a piece is connected to one end or extremity available in the game, "a" will stand for the value on the free side and "b", the value to be connected (for instance, [5;2] may connect to an end with the piece [2;1]). Pieces with the same value on both squares contribute to the sum with the full number of dots (for example, [5;5] counts as 10).

The players. Subjects in the study were 25 villagers in small neighboring farms surrounding a countryside town in Northeastern Brazil. The group had 15 adults (agricultural workers aged 16 through 61) and 10 of their children (aged 6 to 13). Of the fifteen adults, 14 had left school before finishing fourth grade and one was in high school (a woman who was also an elementary school teacher in a nearby village). All the children were enrolled in school at the time of the study: 8 of them in classes up to fourth grade, one in seventh and one in eighth grade. These individuals were the only players of lustrado in the community (with the exception of two adults who refused participation in the study). Therefore, nearly the entire population of players in this particular community were also the subjects of the study.

The observations and tasks. The study included open interviews with local informants, naturalistic-ethnographic observations and videography of spontaneous games, along with individual problem solving sessions. Two types of tasks were used in the problem-solving sessions: 1. A school-like task with problems about multiples (though we did not use this particular term, that is, we asked the subjects to, for instance, recite the numbers between 49 and 70 if we were counting by 7s) and arithmetic operations (addition and multiplication); 2. A game-like task which included arranged games involving multiples

other than “five” and simulations of game situations frequently observed during spontaneous tournaments (the subjects were asked either to imagine or chose from available options a domino they would find most “appropriate” to play next in an ongoing fictitious game).

ANALYSIS

The analysis will be parsed into three interrelated sections, following the parameters suggested by Saxe's framework of emergent goals, though grouped in a somewhat different fashion: 1. Activity structure; 2. Social interactions, artefacts and conventions of the practice; and 3. Prior understandings and the mathematics at play.

Activity structure. This part of the analysis aimed at characterizing the game as a structured activity. Two general phases seemed important for the players themselves during the game: 1. The start of a round; and 2. Making decisions at each turn. Each phase incorporated complexities that sparked the emergence of diverse goals. At the start of a new round, each player would receive six domino pieces and analyzed the set in regard to at least the following two aspects: 1. The number of repeated values across the pieces (e.g., [1;2], [5;1] and [1;1] all have “ones”); 2. The number of dominoes with “fives” (e.g., [2;5]) and/or “blanks” (e.g., [0;6] and [5;0]). Players with many repeated values at start up were believed to have better chances of dominating one or more ends within a round. To realize this during the game, players built hypotheses about the dominoes other players could have, which in turn involved careful consideration of the pieces in one's own hand and those already played by others. Dominoes with a blank or five (in any combination) were important because scoring in the game depended on generating sums multiple of five. Dominoes with a blank allowed the “cancellation of surplus values” in a sum: for instance, if the current sum of values in all ends was 18 and one of the ends had a 3 on it, a player would score 15 points by playing the [0;3] piece at that end, or “ $18 - 3 + 0 = 15$ ”. Dominoes with fives were even more valuable for they could be used to cancel surplus values and at the same time add value to a sum: for instance, if the current sum was 18 and one of the ends had a 3, a player would score 20 points by playing the [5;3] piece at that end, or “ $18 - 3 + 5 = 20$ ”. [This representation of the players' actions as arithmetical expressions is not intended as a description of the procedure effectively implemented by the players as they “read” the sum of all values at the ends, a theme discussed later.] After examining the dominoes received at the start of a round, players would then decide what piece to play first among all possible starts. For instance, say that the very first player in a round had many pieces with repeated values in his or her initial set. If he or she would chose to initiate the game with one among such pieces, the other players would rapidly loose their dominoes containing that value (for the first turn may require the other players to play up to three dominoes with, for example, a “5” on them out of the seven pieces with this value). In such cases, opponents would become vulnerable in subsequent turns since they would be more likely not to have an exemplar of that specific value. The episode below, extracted from annotations taken during observation of a spontaneous game among adults, illustrates this situation:

Levi got the pieces [1;2], [1;5], [5;2], [3;1], [5;0], [1;1], and started off the round with [1;1]. In doing so, he caused two opponents to play dominoes with a “1” and a third opponent was made to “pass” (not being able to play any of his pieces). Thus, after the

very first turn, Levi kept for himself three out of the four dominoes with “1” still to be played. Later on in the game, he effectively gained control over a relatively large number of ends within the round.

Game participation also required many decisions on subsequent turns. In this second phase, players seemed to repeatedly analyze and build hypotheses about at least the following five factors: (1) The number and values of dominoes still in the hands of opponents, based on a count of the number and values of dominoes already disclosed; (2) The chances of missing a turn at playing; (3) The chances of having the last domino of a kind; (4) The summation of all dominoes one had at a given moment; and (5) The possible values of the four pieces left aside at the beginning of each new round. These factors contribute to the complexity of the game, specially when played by adults. As a consequence of all these factors, the decisions made by players resulted in a complex system of goals and activities which we have categorized as follows: (1) Scoring. The very basic goal of building sums multiple of five was a relatively complex one since each domino could be played in eight different ways per turn (1 domino times 2 values per piece times 4 ends); (2) Tracking opponents. Sometimes a player's prime goal would not be scoring, but constructing hypothesis about the pieces his or her opponents could have. This action relied on careful observation of the opponents' game, specially at moments in which they avoided an extremity or missed their turn; (3) Individualizing ends. Typical among players who collected many pieces with repeated values at start up, this goal was aimed at making opponents to miss a turn and/or not score at specific ends.; and (4) Lowering deficits. As the loss of a round was inevitable, players very rapidly attempted to play their pieces, specially those with the greatest values (e.g., [5;6], [6;6] etc.) since the winner of a round added to his or her final score the multiple of five closest to the summation of all pieces not played by his or her opponents. The players' activity in each round and along the turns was structured and continuously oriented by these goals, which emerged either individually or combined. Goals emerged in different ways and combinations depending on circumstantial aspects of the activity, e.g., whether the game involved only adults or children and adults, as we will show in the next section. In sum, participation in the game involved a recurrent and cyclic structure of goals which included the summations at each turn and the examination of hypothesis about where and how to play.

Social interactions, artefacts and conventions of the practice. Our observations revealed that engagement with the game was not primarily guided by strict rules and routines of action. Instead, the players' activity could be better described as emerging from a sophisticated set of local goals, social interactions and culturally constituted mediational artefacts. The emergence of individuals' goals depended on the game's structure as delineated in the previous section, but also on the nature of interactions among players (e.g., who plays against whom) as well as on the discursive conventions typical to the practice (who talks and what is said). An important outcome of the study in regard to social interactions emerged from comparative observations of spontaneous tournaments involving only adults or children with those in which adults and children played together. When playing amongst themselves, the children were a lot more concerned with scoring than with, for instance, tracking opponents or individualizing ends. The opposite was observed during spontaneous games involving only adults, as

they struggled to combine scoring with the goal structure of hypothesis building and tracking of opponents as described earlier. Yet, in games involving adults and children, the former tended not to use more elaborate strategies but to direct their game towards scoring only (typical among children) while the later more frequently attempted to make use of strategies such as lowering deficits and individualizing ends (typical among adults). Adults would still win over the children in such games, but such a process of “mutual appropriation” of goals (Newman, Griffin and Cole, 1989) could certainly support the development of expertise among the younger players as they imitated the deployment of advanced strategies under adult supervision. Curiously, a different result was obtained when we compared adults’ and children’s performance in interviews with simulated games. The task involved the presentation of an on-going fictitious game and asked the subjects to chose amongst several options or imagine the domino piece they found most appropriate to play in the situation presented (half of the tasks showed a set of actual pieces to choose from while in the other half the subjects were asked to freely imagine “the best piece”). We then categorized the subjects’ responses according to whether the chosen piece (actual or imagined) represented the best, intermediary or worst option for scoring in that particular turn (when presenting the simulation, however, we did not specify any playing goals or whatever we meant by “the best piece”). Finally, we grouped the subjects’ answers in a performance scale of four levels (A through D), in which each level marked the percentage of answers in the upper category (“best options”). Thus, level A grouped the subjects who chose (or imagined) the best option in 90 to 100% of all tasks presented; level B, 80 to 89%; level C, 70 to 79%; and level D, less than 70% of all answers in the best option category. Based on this schematic view of the subjects’ performance on the game-task, we found that the children chose more of the assigned best options than the adults (40% of the children’s answers in level A compared to 33% of the adults’ in this level). [Note that all but two players of lustrado in the community took part in the study. Since almost the entire population of players were interviewed, this sort of direct comparison of frequencies should be sufficient to determine meaningful differences between groups.] This result runs contrary, or so it seems, to the observation of spontaneous games in which adults were more successful than children. A possible answers comes from a close examination of the study itself, in particular of the research scenario it created. Indeed, the game-task presented simulations that, though representative of the actual game, were removed from the usual game context. The subjects were then asked to chose or imagine “the best piece” to continue an arranged fictitious game which was presented individually in a problem solving session. As it was, this task re-contextualized the game practice in a way that obscured the dynamics of the game itself. For instance, the strategy of tracking opponents did not immediately result in scoring: its effects could only be noticed at a later time in the case a player had become dominant at specific ends. The analysis indicates that 46.7% of the adults’ answers to the game-task were attempts to deploy this strategy against only 30% of the children’s answers to the same tasks. However, this strategy was really not effective (or “the best option”) in the simulated games since there were no opponents to be defeated. On the other hand, scoring was the main overt strategy for the children in up to 40% of all their answers, against only 13.33% of the adults’ answers. In sum, the unexpected result –more children than adults in the upper level category for the simulation task– was due precisely by an unintended effect of our re-contextualizing the

game as a problem-solving task. Indeed, our initial conception of “the best piece” was limited to the goal of scoring (typical amongst the children). On the other hand, none of the simulations presented had a history of play (either past or future) or actual opponents against whom to use more elaborate strategies (typical amongst the adults). It seems though as if the adults had constructed virtual opponents and consistently attempted to employ in this new game scenario well known strategies that proved ineffective.

Prior understandings and the mathematics at play. Our first attempt to account for the mathematics at play in the lustrado prioritized the notion of multiples of a number. It is of importance that the participants themselves described their activity in the game as directed towards finding “multiples of five”. Nonetheless, our observations indicated that players were most of their time performing sums which involved the values of pieces played at the ends on each turn. More importantly, players also constantly dealt with cancellation of surplus values: the process through which a player calculated the difference between the sum of all ends and the closest multiple of five, and then chose a piece-value that could null the difference and possibly add up to a multiple of five. Consider, for instance, a player's (João, aged 26) answer to what piece he would like to have in a situation with the ends [4;1], [2;2], [3;3] e [6;6] (“ $4 + 4 + 6 + 12 = 26$ ”): “Uh, I wanted to have a three by four ([3;4], with the ‘four’ connecting on [4;1]).... I’d play here ([4;1]), I’d make 25, because look, 4 ([2;2]) and 6 ([3;3]), 10; plus 12 here ([6;6]) makes 22, right? And three by four here (on [4;1]), 25 (which is obtained by first canceling out the 4 in [4;1] by connecting the [3;4] to it, which we can represent as $26 - 4 = 22$; then adding the 3 from [3;4] to the previous ‘result’, $22 + 3 = 25$.)” We observe in this episode that the player seemed to visualize the needed piece and its best position through a process involving sums and cancellations of surplus values. This process was very present and seemingly crucial to players. On the other hand, recognition of scoring values (multiples of five from 5 to 35) happened to be trivial, which run contrary to our initial hypothesis of the centrality of multiplicative operations in the game. From analyzing the players’ behaviors, we suggest that they had either memorized a multiplication series with the appropriate values (5, 10 etc.) or, alternatively, that they could regenerate the entire sequence by repeated addition by 5s beginning with five. Players’ ability to generate lists in such a way is shown in the following quote, registered as an adult approached a school-task which asked for multiples of 3: “3, and 3, 6, and 3, 9 and 3, 12, and 3, 15, and 3, 18, and 3, 21.” Also, when asked to play the lustrado using multiples of 7 instead of the usual 5, players had no difficulties in generating the list of scoring values, as in the following quote: “it’s by 7s, if it comes out 6 you don’t score, it’s 7, 14, 21.” Further evidence that players seemed not to be aware of more elaborate notions about multiples is given in the following. When asked to spell out multiples of a number between two given values (without access to any part of the sequence of multiples) or when asked to continue a given sequence, children and adults alike (including those with higher schooling) did not do as well as in the previous situations:

Interviewer- If I were counting by 7s, what numbers would be between 49 and 70?

Isamara- 49 and 70?

Interviewer- Yeah.

Isamara- It would be 49, 52, 59/

Interviewer- We’re counting by 7s.

Isamara- Oh! It's 49... 50, wait, I was confused, 49 then 56, 63, zero... 70.

In sum, we did not find strong evidence for the use of multiplicative structures among the players, beyond their knowledge of multiplication facts and repeated additions. In spite of this, participation in the game may have had a positive effect on players' performance in school-like tasks. Indeed, we observed extensive use of oral strategies of decomposition and repeated groupings (as discussed by Nunes, Schliemann and Carraher, 1993) also employed by the players during the games for calculating partial and total scores. Consider, for instance, the following strategies employed by the players when solving arithmetical operations presented in a school-like fashion: (a) $72 + 12 = ? \rightarrow "70 + 10 = 80; 80 + 4 = 84"$; (b) $240 \times 30 = ? \rightarrow "240, \text{ times three, it's } 200 \text{ times three, equals } 600, \text{ plus } 100 \text{ from } 40 \text{ times three } (120), \text{ plus } 20 \text{ left over (from } 120), 720 \text{ (the subject solved the problem as if it were } 240 \times 3)"$. Although applied generally, these methods produced a greater number of correct responses for additions (56.7%), more often used in the game, than for multiplications (30%, considering the mean frequency of correct answers among adults and children). However, comparative analyses of the subjects' performance according to their school level suggest that school knowledge of counting, computation and multiples did not have an important contribution for performance in the game-task. Additionally, none of the three subjects in the upper school levels were regarded within the community as specially good players. In order to verify these observations, we run a multidimensional analysis that included data from all tasks (school and games-tasks), field notes and videos. Two contrasting groupings (or poles, each of which formed by matched subjects) resulted from this analysis. The groups differed in the game strategies most likely employed by its members, but no differentiation was found in regard to schooling or age. This analysis also showed that the best players (as determined by observations of spontaneous games and informal assignments from the players themselves) had a good performance in the school-task (particularly in questions about multiples) but were not in the higher grades of schooling. Seen in the light of all previous analyses, this suggests that mathematical knowledge developed within the game practice may have influenced the subjects' performance in the school-task, though we did not find evidence for reciprocal effects.

CONCLUSIONS

This study offered a set of analyses about individuals' participation in a recreational practice and their development of mathematical knowledge. Engagement in such a practice was shown to involve players with arithmetical knowledge, the exam of hypotheses and the coordination of goals of relatively high complexity. We hope thus to have contributed to a characterization of a well-structured and efficient body of knowledge developed outside schooling but reasonably distant from practices of economic subsistence, usually described in the literature. In regard to school instruction, this study draws attention to the following question. As constructivist pedagogies (in their many forms) gradually made their way into grade school, games and other sorts of artefacts were credited as providers of "concrete" scenarios for the learning of otherwise "abstract" (therefore intangible) mathematical concepts. Games have indeed been used with the goal of overcoming well-known problems of traditional instruction such as its overemphasis on memorization and algorithmic skills. Yet, we must notice the complex relations between what have been (inadequately) called "formal" and "informal"

knowledge (sometime contrasted as “school” versus “everyday” knowledge). It is not uncommon to find both in research and teaching, interpretations of studies such as those by Nunes, Schliemann and Carraher (1993) and Saxe (1991) as if out-of-school practices were meaning-oriented while school activities were, by definition, meaningless. As a consequence, it is tempting to import “real-world”, “everyday” activities to school as tasks. We see this false dichotomy as fetishizing the “real-world” and the “everyday” (usually taken as belonging exclusively to out-of-school places and practices), by encapsulating them in tasks that could eventually enter the classroom and replicate the system of meanings of the “same” activity as historically realized outside school. The use of money in make-belief situations as a way to teach about arithmetics is a case in point. Money, a familiar cultural artefact, and its use in pretend games of buy-and-sell within school are believed to create situations tailored to profit from the web of meanings previously lived in by the children out of school, with the effect of making “transparent” the mathematics behind the game. However, several authors have shown the complexities involved in such pedagogical practices and the ways in which children’s experiences with money out of school radically differ from the ways that money gains entry in school as a knowledge domain (Meira, 2000; Brenner, 1998; Walkerdine, 1988). Thus, this sort of transfer is largely insufficient for the development of scenarios for learning within school, and usually create a whole new set of problems for mathematics instruction. Perhaps a more productive strategy would be to think of school learning environments oriented towards explicit reflection and discussion about different and contrasting ways of constructing meanings for mathematics. In arithmetics teaching, for example, the lustrado game could be used in school activities as a culturally specific mode of signifying numbers and computations, and then contrasted with other modes of arithmetical sense-making such as those developed by candy-sellers (Saxe, 1991) or professional mathematicians. Through discussion and argumentation, the game would be appropriately re-contextualized (not de-contextualized) as an acceptable (from the pupils’ viewpoint) and rich artefact for the development of mathematical knowledge and discourse within school.

References

- Brenner, M. (1998). Meaning and Money. *Educational Studies in Mathematics*, 36, 123-155.
- Lave, J. (1988). *Cognition in practice: Mind, mathematics and culture in everyday life*. Cambridge: Cambridge University Press.
- Meira, L. (2000). Lo real, lo cotidiano y el contexto en la enseñanza de las matemáticas. *Uno: Revista de Didáctica de las Matemáticas*, 25, 29-74.
- Newman, D., Griffin, P., & Cole, M. (1989). *The construction zone: Working for cognitive change in school*. Cambridge: Cambridge University Press.
- Nunes, T., Schliemann, A., & Carraher, D. (1993). *Street mathematics and school mathematics*. New York: Cambridge University Press.
- Saxe, G. B. (1991). *Culture and cognitive development: Studies in mathematical understanding*. Hillsdale: Erlbaum.
- Walkerdine, V. (1988). *The mastery of reason: Cognitive development and the production of rationality*. London, UK: Routledge.

ABSTRACTING THE DENSITY OF NUMBERS ON THE NUMBER LINE – A QUASI-EXPERIMENTAL STUDY

Kaarina Merenluoto

Department of Teacher Education, University of Turku, Finland

The starting point for this study was the resistant nature of prior knowledge in conceptual change from natural numbers to rational numbers observed in our previous study. Thus, in this study the effects of deliberately teaching the abstraction of the density of numbers on the number line was tested in a quasi-experimental study at the beginning of students' first course in calculus. The results suggest a significant and stable effect in the post test between the test group and control group. This effect had an important relation to the level and quality of abstraction of the number line, which was found in the short essays written by the participants of the test group during the intervention.

INTRODUCTION

In the discussion of conceptual change in science learning (e.g. Vosniadou, 1999) the term “conceptual change” has referred to a radical change or reorganization of prior knowledge which is typical to learning of concepts in science. Thus, there are plenty of empirical research from the viewpoint of conceptual change for example in the field of biology (e.g. Ferrari & Chi 1998; Hatano & Inagaki, 1998) physics (e.g. Vosniadou, 1994; Ioannides & Vosniadou, 2002) and some also of mathematics (e.g. Merenluoto & Lehtinen, 2002a and b; Vamvakoussi & Vosniadou, 2002). The most characteristic results in these studies were the resistant nature of students' prior knowledge, and the fact that the students' difficulties primary seemed to be due to the quality of prior knowledge of the student than to the complexity of the concept to be learned.

Results from above mentioned studies in the field of mathematics refer to mistaken transfer of the properties of natural numbers to the domains of more advanced numbers. In the midst of this mistaken transfer is the fundamental discrete nature of natural numbers. For the learner, it poses a cognitive conflict with the compact nature of rational numbers and the continuum of real numbers. By the term discrete is meant the instinctive feeling connected to numbers that there is always the “next number” or to be precise: that every number has a successor and no two numbers have the same successor (e.g. Landau, 1960). This intuition of a “next” number seems to have the same self-evident, self-justifiable and self-explanatory characteristics as primitive intuition described by Fischbein (1987) thus easily leading to overconfidence. As such it seems to act as an obstacle for conceptual change in more advanced domains of numbers: revision the thinking of numbers does not even come to mind for the students.

In our extended survey (reported e.g. in Merenluoto & Lehtinen, 2002 a and b) a majority of the students on upper secondary school level still spontaneously used the abstraction of discrete natural numbers familiar to them in describing the density of rational and real numbers on the number line. There were, however, students who referred to the infinite density of numbers using operational explanations like the possibility to add decimals. This kind of explanation seems to be based on an abstraction, which is very similar to the abstraction of continuity of natural numbers: you can always add more numbers. Thus,

according to Vosniadou (1999) this kind of learning seems to be based more on enrichment of prior knowledge than on a radical change. Any indications to a more radical conceptual change in thinking of numbers were found only in very few explanations where the students stated how the “next” number is not defined in the domain of rational and real numbers.

In order to gain more understanding of supporting the conceptual change from discrete numbers to the density of numbers, a teaching experiment was planned according to the suggestions of Ohlsson and Lehtinen (1997) who claim that abstraction is a prerequisite of learning; contrary to the traditional thinking where learning is seen as a procedure from concrete to generalization or abstraction. This means that for the learner two objects or relations are seen as similar to the extent that they fit the same abstraction. But to fit something to an abstraction the learner must already possess that abstraction, and moreover, what is needed, is that the teacher deliberately focuses the attention of the students to the essential features of the abstraction (see Dreyfus 1991).

AIM OF THE STUDY

The aim of the study is to describe our experiment and its results, especially how the effect was related to quality of abstraction of the number line the participants presented in the beginning of the intervention.

METHOD

Participants and design

Two groups of students on upper secondary school level and studying advanced courses in mathematics was selected for the study. The selection of the groups based on the results from our previous study: both groups used the same textbook in mathematics and both schools were scored above median in our previous survey, but they were not the same students.

A quasi-experimental design with pre, post and delayed tests for both groups was planned. The pre test was carried out at the beginning of students’ first course in calculus, the post test about six weeks later, and the delayed test again about six weeks later. A short intervention period (2 hours) described below, was organized for the test group after their pre test, while the control group proceeded in the normal way. The test group consisted of 21 students (9 boys and 12 girls, age 16-17 years) and the control group of 25 students (15 boys and 10 girls, same age) who participated in both pre- and post tests.

Procedure of intervention

The intervention was planned by us, but carried out by the mathematics teacher of the test group, who was following our plan. We wanted to involve the teacher to the planning period, but he was not willing to. The intervention period was, however, tape recorded and observed. It had three phases. In the first phase the teacher began with the elements of everyday knowledge of the students, and started a discussion on numbers, next numbers and continuity of natural numbers. During the second phase the students were given an exercise, where they were asked to mentally add numbers on the number line with the help of given questions (Table 1) and then write with their own words how they think of it. This was done in order to activate students’ prior knowledge on the subject, to

make them aware of their own mental conception of numbers and to define the quality and level of their abstraction of the density of numbers on the number line in the beginning of the experiment. These short essays were qualitatively analysed.

In this exercise we ask you to consider, how you “see” or think the numbers on the number line and write it down. It is likely that everyone “sees” them a little differently. Try to be as exact as possible. You can use following questions to assist your thinking:

How do you “see” the number line? – Explain in your own words.

Add the numbers 1, 2, 3 ... on the line in your mind. How long it is possible to continue?

Continue then with fractions $\frac{1}{2}$, $\frac{1}{3}$, $\frac{1}{4}$, $\frac{1}{5}$... How long it is possible to continue?

On what interval on the number line are these numbers placed?

How many irrational numbers it is possible to add between the numbers given above?

TABLE 1. The instruction for the exercise, given to the test group in the second phase of the experiment.

At the third phase, the teacher guided the students into a discussion of different domains of numbers, where their attention was deliberately focused on gradual adding the density of the numbers on the number line with rational and real numbers. Then, the teacher presented one number on the blackboard and asked if anyone could give a number, which is close to it. He asked the students if anyone could give a number which could be still closer to the given one. He even made a bet, and promised a small sum of money to the student, who could give a number, so close to the given number that the teacher would not be able to find a number still closer. Some of the students, especially boys, had their expressions brightened of the hope for some extra money. But during the process they experienced, how it is always possible to find a number which is closer to the given number than any given positive number. Finally the teacher presented the concept of limit as an abstraction of infinite divisibility, where the “next” number is not defined.

Pre-, post and delayed tests

The questions pertaining to the density of numbers on the number line in the tests were from the same questionnaire which we used in our previous survey, reported before (Merenluoto & Lehtinen, 2002a and b), namely: “*How many fractions/ real numbers there are between two given numbers ($\frac{3}{5}$ and $\frac{5}{6}$; .99 and 1.00) on the number line*”; and the questions posing a cognitive conflict: “*Which one is the ‘next’ after $\frac{3}{5}$ or ‘closest’ to 1.00*” (four items, alpha .828). The answers were scored on scale from zero to four, thus the maximum score was 16 points.

RESULTS

In the test group students’ grades in mathematics had a mean of 7.5 (on a scale 4 - 10) and the respective measurements for the control group were 7.1, the difference was not statistically significant. Likewise there were no statistical differences between the groups in the scores of the pre test. The overall results run parallel with our previous survey: the formal understanding of the different domains of numbers was quite low.

Effect of the intervention

The scores in post- and delayed tests had a significant difference between the test group and control group. MANOVA (repeated measures) revealed a significant main effect of the intervention, $F(1, 44) = 10.46$; $p = .002$; with an effect size $\eta^2 = .192$ and power $.885$, between the pre- and post tests. In the delayed test the loss in the control group was notable, more than half of the students did not want to bother in answering the same questionnaire third time. But there was difference between groups also in the delayed test, ($\eta^2 = 3.60$, $p = .05$). The results (Fig.1) refer to a quite stable effect.

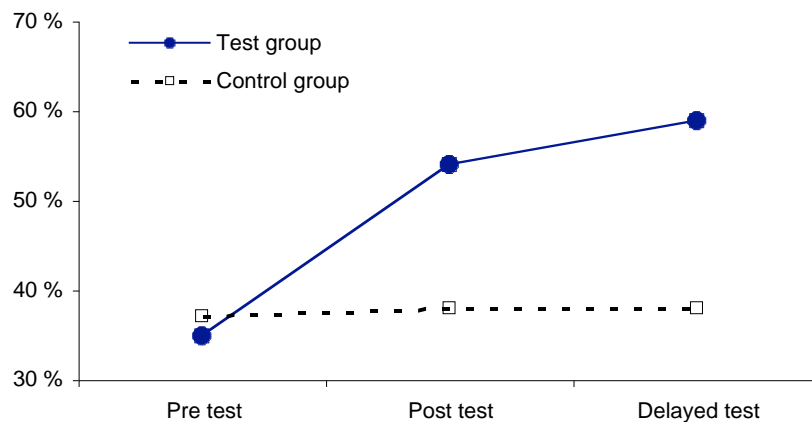

Figure 1. Means of scores as percentages of maximum for both groups in pre, post and delayed tests

In an analysis of change between the scores in pre- and post tests, the students were divided into four distinctive groups: (1) three students (14%), with low scores in both tests; (2) ten students (48%) with a small change (better answer only in one of the density questions), (3) four students (19%), with a prominent change: low scores in the pre test and high scores in the post test, (4) four students (19%), who already had high scores in the pre test. The respective grouping in the control group yielded to a statistically different distribution respectively: 56%, 20%, 4%, and 20% (Mann-Whitney, $z = -2.89$; $p = .004$)

Essays of the density of numbers on the number line

In most of the descriptions of the students from groups one and two, it was easy to identify the model of number line presented in the text books on mathematics.

The students in the first group were girls, who described their thinking of the number line in a very concrete way, or had mistakes in their descriptions, like follows:

My number line is so long that nobody is able to measure it, I can not even image which is the smallest or largest number and if they even exist. When I think the numbers 1, 2, 3... it is long but when I think the numbers $\frac{1}{3}$... it still gets longer... they all go between numbers 1 and 2 or between numbers 2 and 3. – Lisa¹

¹ All the names have been changed.

My number line is a line with small cross lines on it. I'm able to think numbers until number 10, but then the rest are so far away that I'm not able to see them. I'm not able to put all those fractions on it, because there is not enough space – may be I could fit a couple of irrational numbers on it, though.– Lena

Their explanation had a very low level of abstraction. In both pre- and post tests they gave answers based on the abstraction of discrete numbers, for example: “*the fraction 4/5 is the next number after 3/5, because it just popped into my mind – Lena.*”

In the second group with a slight change between the tests, there were nine girls and one boy. To this group it was typical that they explained in their essay of the number line, how it is possible to endlessly add fractions between numbers. In the post test they, however, used the familiar abstraction of discrete numbers in describing the density of numbers. The only change in their answers in the post test, was that they explained, how there are an infinity of real numbers between .99 and 1.00, because it is possible to add decimals. Typical to these students was that they had hardly any explanations to their answers in the tests. In their essays they used a little higher level of abstractions than those the previous group. For example, Karen explains about the possibility to change the scale of the number line:

My number line just continues... and it is possible to change its' scale if needed. There are whole numbers on even intervals and a lot of fractions between them. My number line is like a world and you can use it to examine the space, globe, but also the tiniest bacteria with it.

Maria refers to the possibility to add decimals:

My number line continues without an end... It is possible to continue as long as you want to. It is possible to write endlessly fractions depending on how many decimals you use. First I examined only integers, then my picture enlarged and the numbers were closer to each others... finally their space between them disappeared when I got into smaller numbers.

Sara described her number line between concrete and imaginary associations, but stated how she felt able to imagine infinity of numbers if needed:

My number line continues without an end, it has small cross lines on it with numbers above. ... I associate it to a thermometer... It is so long that it goes around the world... There are fractions also and it is possible to write them until knowledge and skills come to their ends. Every number has its place on the line and so have the fractions also. It's impossible to see the irrational numbers, but if needed I feel able to imagine them on it.

The students in the third group were boys, with a prominent change between the tests. They gave answers based on abstraction of discrete natural numbers in the pre test, but in the post test they referred to infinity of numbers between rational and real numbers and to the impossibility to define the “next” one, reasoning these with the possibility of adding decimals. The prominent change might have a relation to their somewhat more elaborative explanations in their essays. One of them had frustrated expressions also in his essay.

Eric, for example, had identified the logic of numbers which for him was the same for natural numbers and fractions and told of about his versatile ability to use numbers:

I see numbers in a different way depending on the situation and I'm able to operate with them on versatile ways, only very large and very small numbers are difficult to handle. The

numbers have their logic order on the number line and while it is easiest to think with whole numbers, it is as easy to think the fractions because the logic is the same, they fit between _ and zero.

Tom's explanation had an advanced abstraction how all that is needed are the numbers between zero and one. Especially in the post test, he seemed to be a little frustrated while he explained: "*by adding decimals you are always able to find a larger number, because mathematics has its own incomprehensible world of peculiar concepts*". Indications of this kind of frustration and of thinking numbers mostly at school situations were, however, visible already in his essay at the beginning of the intervention:

I can see it as an endless horizontal line, and I can think numbers on it until 10, after that I don't want to be bothered to do unnecessary thinking, it is not needed here. It's no use to put small fractions on the number line, only thing you need is the interval between zero and one – which you can expand as long as you want to. It is too much for me to think of the cardinality of irrational numbers, because it is easier to think the number line as a line of whole numbers. Some numbers I associate to different situations, some are lucky numbers, and sometimes they are just a grey mass for me. Quite often I associate them only to mathematics and after that to some of my teachers.

The students in the fourth group were boys, who gave high level answers already in the pre test and most of them even higher in the post test. These students were patient with the tests, and gave advanced level of explanations. Their essays referred to spontaneous and intentional pondering of numbers. They demonstrated some unique and elaborative ways to deal with the abstraction of number line, which for them still was somewhat framed with the concrete. For example, John was tackling this problem by writing about the difficulty from uneven divisions:

I see number line as a long line, but in order to help my thinking there are cross lines on the places of whole numbers like in the set of coordinates. It is not difficult to think of integers, but the difficulty comes from uneven divisions. It's easy to fold a paper in half or in four parts, but $1/3$ is not so easy and because of that, thinking of those numbers is more difficult. Thus, with paper it is easily done, but as imagined it is difficult to focus – the numbers smaller than $1/20$ are already difficult to think, they finally pile up to a same place.

Tim tackles the problem by abstracting a third dimension for his dynamic model of number line:

As a whole I see the number line from very far – a vague mass of white numbers on black background. Then when I think the numbers in the beginning, like numbers 1-10, I zoom closer. If I want to, I can browse the integers back and forth, which I could continue forever, but usually it's not needed.... If I want to examine the fractions I zoom deeper between numbers one and two, take the left half of the interval and zoom in to that. It is possible to continue forever, but usually $1/21$ is already too much. It is frustrating to think of something that is endlessly continuing. In order to examine the irrational numbers I usually zoom back outside of the number line, take an approximate value of needed number and using that dive into the depths.

In Tim's explanation, there was a little mistake, but his description on finding the needed irrational number with the help of approximate values was profound.

CONCLUSION

Most of these students were still far from a radical conceptual change in their number concept, namely changing their frame of reference of numbers from natural numbers to real numbers with rational numbers, integers and natural numbers as sub sets. However, this experiment, although it was small, gave some important results for future research in finding ways to support the conceptual change in mathematics.

The main effect of this intervention was evident in the groups two and three, where the students totally or partly changed their abstraction of discrete numbers to an operational level of abstraction of density of numbers by adding decimals and moreover, this change seemed to be quite stable. Thus the main results from the intervention were that it is relatively easy to foster a change as long as it stays on the operational level or as an enrichment kind of change.

In order to foster a more radical kind of change in mathematics, metaconceptual awareness referred also by Vosniadou (1999) seems to be mandatory. This means that the students need to be aware of how they think about numbers and consciously pay attention to the differences between different kinds of numbers. The writings of the students in the fourth groups referred to this kind of situation. The elaboration level of the best writings refers to metacognitive skills of the best succeeded students. Thus it suggests also to the need to consider metacognitive, motivational and intentional factors in the endeavours to facilitate conceptual change. Using writing as a tool in teaching mathematics (e.g. Conolly & Vilardi, 1989) an in research of supporting conceptual change has been used earlier (e.g. Mason, 2001) according to our results it might be a useful especially in teaching metacognitive skills.

The writings and answers of the students in the two first groups revealed especially the low level of mathematical thinking of these students. Thus, what are needed are more experience and exercises to awaken and develop the metacognitive skills in mathematics. Low levels of abstraction were also related to deficiencies in basic knowledge of numbers. There were also a clear division between boys and girls, all the girls were in the two first group and almost all the boys in the third and fourth group. It is possible that the possibility of earning extra money during the intervention called especially the attention of the boys who sat in the front part of the class, while all the girls sat in the back. Thus, the boys had a real experience of the potential infinite division. On the other hand in several studies it has been found that in questions pertaining to infinity, girls seem to be more cautious in their conclusions, which was found also in our previous study (Merenluoto 2001).

References

- Conolly, P. & Vilardi, T. (Eds.) (1989). Writing to learn mathematics and science. New York: Teacher college Press.
- Dreyfus, T. (1991). Advanced mathematical thinking processes. In D. Tall (Ed.) *Advanced mathematical thinking*. Dordrecht: Kluwer Academic Publishers, 25-41.
- Ferrari, M. & Chi, M. T. H. (1998). The nature of naive explanations of natural selection. *International Journal of Science Education*, 20 (10), 1231-1256.

- Fischbein, E. (1987). *Intuition in science and mathematics. An educational approach*. Dordrecht: D. Reidel Publishing Company.
- Hatano, G. & Inagaki, K. (1998). Qualitative changes in intuitive biology. *European Journal of Psychology of Education*. 12(4), 111-130.
- Ioannides, C. & Vosniadou, S. (2002). The changing meanings of force. *Cognitive Science Quarterly*, 2 (1), 5-62.
- Landau, E. (1960/1951). *Foundations of analysis. The arithmetic of whole, rational, irrational and complex numbers*. New York: Chelsea Publishing.
- Lehtinen, E., Merenluoto, K. & Kasanen, E. (1997) Conceptual change in mathematics: From rational to (un)real numbers. *European Journal of Psychology of Education*. Vol. XII, (2), 131-145.
- Mason, L. (2001). Introducing talk and writing for conceptual change: a classroom study. *Learning and Instruction*, 11, (4-5), 305-330.
- Merenluoto, K. (2001). *Lukiolaisen reaaliluku. Lukualueen laajentaminen käsitteellisenä muutoksena matematiikassa*. [Students' real numbers. Enlarging the number concept as a conceptual change in mathematics, a doctoral dissertation]. Publications of the University of Turku, C 176. Painosalama.
- Merenluoto, K. & Lehtinen, E. (2002a). Conceptual change in mathematics: understanding the real numbers. In M. Limón & L. Mason (Eds.) *Reframing the processes of conceptual change. Integrating theory and practice* (pp. 233-258). Dordrecht: Kluwer Academic publishers.
- Merenluoto, K. & Lehtinen, E. (2002b). Certainty bias as an indicator of problems in conceptual change: the case of number line. In A.C. Cockburn & E. Nardi (Eds.) *PME, Proceedings of the 26th Annual Conference* (Vol 3, pp. 337-344). University of East Anglia, Norwich, UK.
- Mikkilä-Erdmann, M. (2002) *Textbook text as a tool for promoting conceptual change in science*. Publications of the University of Turku. B 249. Painosalama
- Ohlsson, S., & Lehtinen, E. (1997). Abstraction and the acquisition of complex ideas. *International Journal of Educational Research*, 27 (1), 37-48.
- Vamvakoussi, X. & Vosniadou, S. (2002). What mental models do students use regarding the structure of the domain of rational numbers? In A.C. Cockburn & E. Nardi (Eds.) *PME, Proceedings of the 26th Annual Conference*. University of East Anglia, Norwich, UK, Vol, 1-326
- Vosniadou, S. (1994). Capturing and modelling the process of conceptual change. *Learning and Instruction*, 4, 45-69.
- Vosniadou, S. (1999). Conceptual change research: state of art and future directions. In W. Schnotz, S. Vosniadou, & M. Carretero (Eds.) *New perspectives on conceptual change*. Killington, Oxford: Elsevier Science, 3-14.

MEASURING CHILDREN'S PROPORTIONAL REASONING, THE "TENDENCY" FOR AN ADDITIVE STRATEGY AND THE EFFECT OF MODELS

Christina Misailadou and Julian Williams

University of Manchester

We report a study of 10 -14 year old children's use of additive strategies while solving ratio and proportion tasks. Rasch methodology was used to develop a diagnostic instrument that reveals children's misconceptions. Two versions of this instrument, one with "models" thought to facilitate proportional reasoning and one without were given to a sample of 303 children. We propose a methodology for examining systematically the pupils' additive errors, their effect on ratio reasoning and how contingent on "model" presentation this is. First we provide a measure on which pupils, item-difficulty and additive errors can be located. We then construct a new measure, which we name "tendency for additive strategy". Finally, we find that the presence of "models" affects this new measure and draw inferences for choices of items in assessment and teaching.

INTRODUCTION

This study builds on previous work on children's misconceptions while solving ratio and proportion tasks and especially on their use of an "additive strategy" to obtain an answer.

The additive strategy is the most commonly reported erroneous strategy in the research literature related to ratio and proportion. When using this strategy to solve a ratio item, "the relationship within the ratios is computed by subtracting one term from another, and then the difference is applied to the second ratio." (Tourniaire & Pulos 1985, p.186)

In this study we aim to contribute to teaching by developing an instrument that can help teachers diagnose their pupils' misconceptions, including the use of the additive strategy. Twenty-four, missing value items were used to construct the instrument. Some of these items have been adopted with slight modifications of those used in previous research and others have been created based on findings of that research. (CSMS 1985, Lamon 1993, Tourniaire 1986, Cramer, Bezouk & Behr 1989, Kaput & West 1994, Singh 1998) All of the items were selected having as a criterion their diagnostic potential as reported in the above studies. This is their potential to provoke a variety of responses from the pupils, including errors stemming from well known misconceptions. Furthermore, we tried to use a variety of problems as far as "numerical structure" and "context" is concerned. As a result of this selection, errors indicative of common and frequent misconceptions such as the additive strategy were expected to occur. In addition, we hoped that less frequent misconceptions or even ones that are not mentioned in the research literature would also occur.

Finally, two versions of the instrument were tested (both of these versions can be seen in full on the web at <http://www.education.man.ac.uk/lta/cm/>). The first version ("W") contains all the twenty-four items presented as mere written statements. The second version ("P") contains the same items but this time most of them are supplemented by

“models” thought to be of service to children’s proportional reasoning. These models involve pictures, tables and double number lines. Our purpose was to compare the difficulty of the parallel items for the children and to spot differences in the strategies used in each type of items.

This paper reports the results from the scaling of both versions of the instrument and focuses particularly on the occurrence of the additive strategy. The scaling of the instrument provides a measure on which pupils, item difficulty and additive errors can be located. We present the results for its non-model form. Based on these results, we construct a new measure which we name “tendency for additive strategy” (again for the non model form). Finally we examine the “model effect” on the tendency for additive strategy.

METHOD

In order to be able to administer more items to the same sample of pupils, each version of the test consisted of two separate test forms with common linking items. Thus, Test W was divided in Test W1 and Test W2. Test W1, designed to be easier, consisted of sixteen items and Test W2 had the same number of items, but was designed to be more difficult. Eight of the items were common for both tests. Exactly the same pattern applies for tests P1 and P2 into which Test P was divided. Finally, we equated Test W1 and P1 through common items and we did the same for Test W2 and Test P2 in order to be able to compare the difficulty of the parallel items for the children.

The tests were given to a sample of 303 pupils aged 10 to 14 years old from 4 schools in the north west of England. Before administering the tests to the pupils, their teachers were asked to comment on the suitability of the items for their classes. They found that the items were generally acceptable for the pupils’ age and viewed them as valid assessment of the curriculum they are teaching. They commented though, on the difficulty of the items 3Paint and 6OnionSoup.

For each item of the test, all the pupils’ answers, correct and erroneous, were coded and the results were subjected to a Rasch analysis in the usual way using the program Quest. (For a summary of this method see Williams and Ryan, 2000: the Rasch scaling is the modern stochastic development of the Guttman scaling model used in the CSMS studies reported by Hart, 1981). This analysis allowed us to scale the most common errors for each item with its difficulty in the W and P form. The result was a single difficulty estimate for each item and an ability estimate for each child consistent with the Rasch measurement assumptions. Item “3Paint” fell outside a model infit statistic value of 1.3 (see Wright & Stone, 1979) reflecting the difficulty of this item for the sample.

Finally, we were able to validate the interpretation of significant misconceptions because for each item in the test, there were specific instructions to the children not only to write an answer but an explanation for it as well. Furthermore, in addition to the test analyses, we drew on structured clinical interviews with 13 children and structured small group interviews with 63 children about the test items. These interviews allowed us to validate the items and to confirm our interpretations about the strategies that were used to solve the items.

RESULTS

Scale of performance and additive errors

Several factors that are supposed to make ratio problems more susceptible to additive errors are mentioned in previous research studies. Some reports draw attention to numerical factors (e.g. Bell, Costello and Küchemann, 1985, mention as such a factor, the appearance, in a problem, of fractions other than halves) and others point out the context factors (e.g. Kaput and West, 1994, mention the “geometric figures” problems as the most vulnerable to additive errors). Since we tried to have in our instrument problems that are as varied as possible in numerical structure and context we decided to have a more systematic approach to the kind of additive errors that pupils make and to the kind of problems, in terms of numerical and context characteristics, that provoke an additive approach.

Table 1 below, consists of four columns. The numbers on the first column, beginning from the left, represent the logit scale on which items and cases are calibrated. The second column (the “Xs”) presents the distribution of the cases (pupils) according to their ability estimate. Here by the term “ability” we mean the performance of the pupil in this particular test and not a general mathematical ability. The third one (where each name represents a different question of our instrument) shows the distribution of the items (on the same scale) in reference to their difficulty estimates. (The names and the corresponding items can also be seen at the above web address) Finally, the last column presents the mean abilities of the pupils that produced particular additive errors. We name each of these errors by using the prefix “ad” and the name of the corresponding item. For example, by “Ad4OnionSoup” we indicate the mean ability of the pupils that gave an erroneous answer to the item “4OnionSoup”, as a result of the additive strategy. The additive errors listed in the table are most likely to be made by children at the ability adjacent or below. We have included only errors that occurred on more than 3% of the scripts on the grounds that one might expect to see one such occurrence in a random classroom of 30 children.

From the table below, it can be inferred that the mean ability of many of the pupils that gave additive errors is quite close to the mean ability of our sample. Afantiti-Lamprianou & Williams (2002) have demonstrated the usefulness of a different technique for scaling errors with case abilities, for a “representativeness tendency” measure as a diagnostic measure for probability items. Accordingly, we considered building a “tendency for additive strategy” measure as a diagnostic measure of tendency to inappropriately apply this strategy.

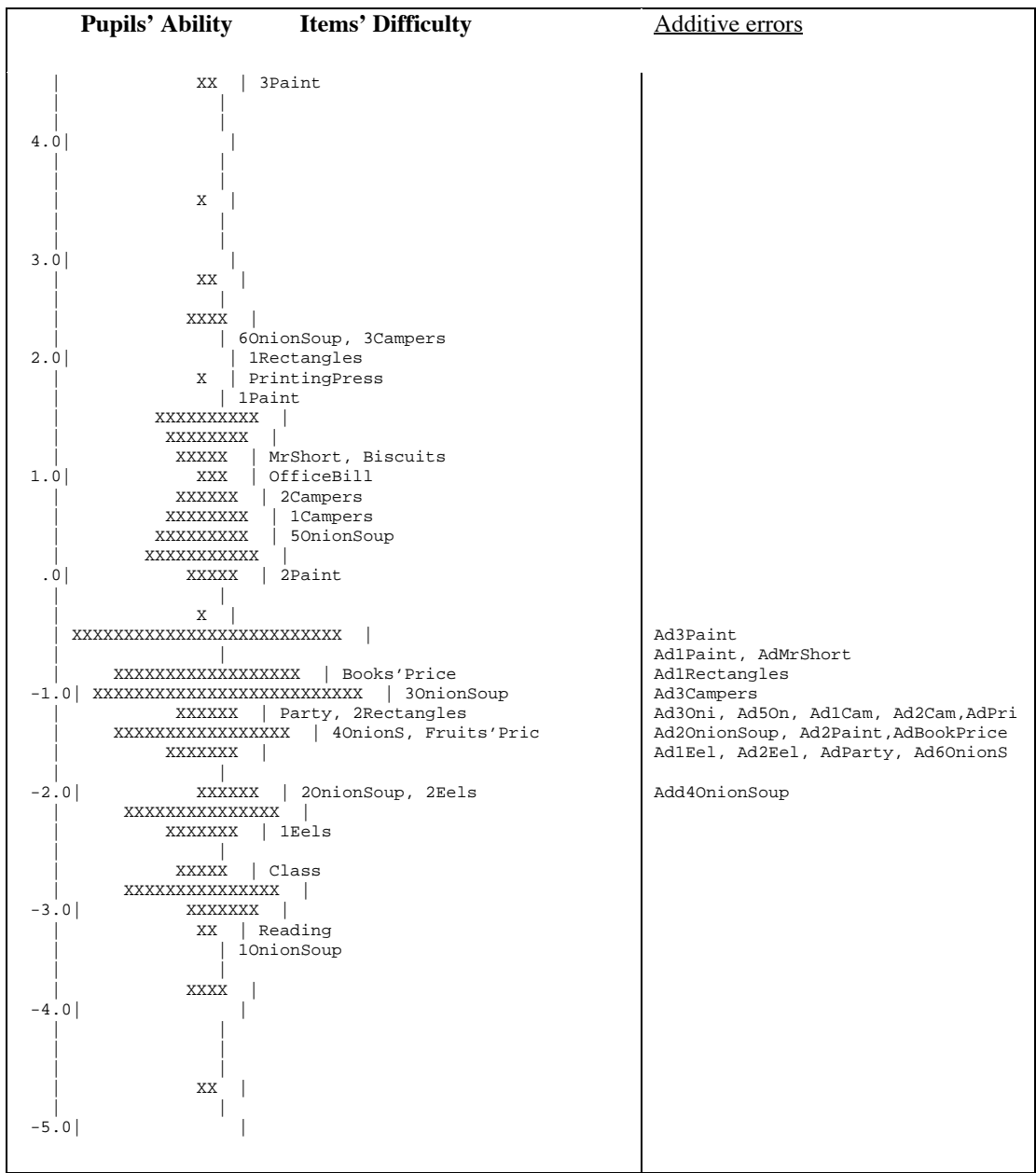

Table 1: Scale of performance and additive errors

The “tendency for additive strategy”

A second Rasch analysis was run using Quest. One mark was given only for the answer that indicated the use of an additive strategy and no marks were given for any other responses. The result was a single scale of items that can be seen in Table 2 below (none of the items fell outside a model infit value of 1.3).

Children that are higher up in this scale are more likely to use the additive strategy and items that are higher up in the same scale are the least likely to provoke additive errors-in these items only the pupils with a strong “tendency for additive strategy” made such errors.

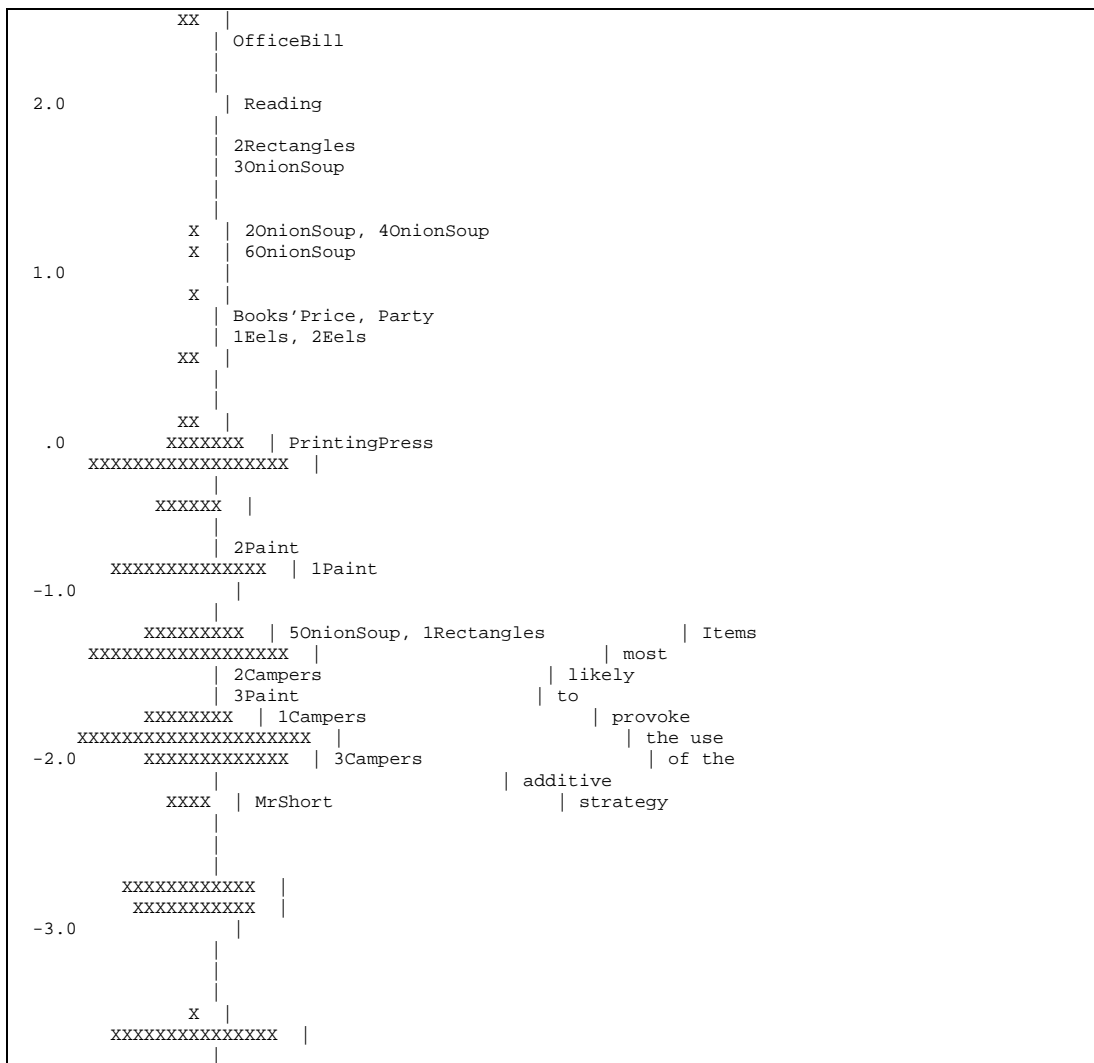

Table 2: Item and Person Estimates of the “tendency for additive strategy”

The outcome of this analysis is a measure of “tendency for additive strategy” for each person, which naturally correlates negatively with their “ratio reasoning ability” as measured previously (rho= -0.2). The regression equation was found to be to 2 SF:

$$\text{Ratio reasoning ability} = -0.28 \times (\text{Tendency for additive strategy}) - 1.5$$

According to the regression analysis of our data 4 % of the variability in “ratio reasoning ability” is accounted for by the “tendency for additive strategy”. It is interesting to note that this new measure diagnosis a pupils’ weakness but further research is needed for the rest of the variance to be explained. From inspection of the frequency of other errors though, we know that they will not account for much more variance than the “additive strategy” which is the strongest.

By taking into account the item analysis results for observed responses provided by Quest we distinguished on Table 2 the seven items of our test that most frequently provoke additive responses.

By inspection, these items indicate that the decisive factor for the difficulty of a ratio problem is its numerical structure. Five of these items are some of the most difficult numerically items of the instrument: neither the scalar nor the functional relationships in the given proportions are integer ratios and the answers cannot be obtained by a simple multiplication or division by an integer. Only the item “2Campers” has an easy numerical structure and consequently we assume that it is the “sharing context” that makes this item prone to additive errors.

Effect of models on “ratio reasoning ability” and “tendency for additive strategy”

As we have mentioned, we have created two versions of our instrument: one with and one without models. The table below (Table 3) presents the Rasch analysis estimates for the items of our instrument that were presented in both of these versions.

Item’s name	Ratio reasoning ability estimates			Tendency for additive strategy estimates		
	Difficulty of the item without models	Difficulty of the item with models	Difference in logits	“Additive estimate” of the item without models	“Additive estimate” of the item with models	Differ. in logits
1Paint	1.70	-.69	-2.39	-.76	-1.08	-.32
Reading	-3.22	-3.17	.05	2.03	1.55	-.48
2Paint	.11	-.84	-.95	-.70	-.86	-.16
Books’ Price	-.81	-.37	.45	.70	.52	-.18
1Campers	.65	1.68	1.03	-1.73	-1.38	.35
2Campers	.76	1.25	.49	-1.40	-1.38	.02
Class	-2.72	-1.76	.96	No score	No score	N.A.
Party	-1.23	-.88	.35	.70	.63	-.07
Fruit’s Price	-1.32	-.88	.44	No score	3.05	N.A.
3Paint	4.69	3.45	-1.24	-1.52	-1.51	.01
3Campers	2.19	2.29	.10	-1.91	-1.57	.34
Printing Press	1.85	1.09	-.76	-.03	.99	1.02
Biscuits	1.19	1.09	-.10	No score	No score	N.A.

Table 3: Comparison of the parallel items

All the estimates are given in logits. In the first scale, which measures “ratio reasoning ability” the difficulty estimates start from negative to positive logits for easier to more

difficult items respectively. In the second scale, which measures “tendency for additive strategy” the additive estimates start again from negative to positive logits, for more to less frequently provoking additive errors items respectively. A positive difference in column 3 indicates that the “non-model” item is harder (as designed) whereas a positive difference in column 6 indicates that the “non-model” item is less likely to encourage an additive strategy (also as designed).

We note that in nearly half of these items the “non-model” item is actually easier than the model version, and these include the easiest items and the items for which the model does not help avoidance of additive strategy. From the seven most interesting “additively” items, four (the ones highlighted in Table 3) were presented in a model as well as a non-model version. For all of them the model was a pictorial representation of their data.

We have already reported (Misailidou & Williams, 2002) that the addition of pictures in each of those items affected the kind and the frequency of the strategies that pupils had employed. As we can see on the table, the pictorial version of the item “3Paint” was easier than the other one whereas for all three of the “Campers” items the pictorial version was more difficult than the other one!

On the other hand, by looking at the “tendency for additive strategy” for all the four items we realize that for each item the pictorial version is located higher up the scale than the “without the model” version. It seems that, with the supplement of pictures, these additive errors became less frequent. We believe that, although the addition of a pictorial representation to a ratio item does not always make it “easier” for the children, it could decrease the item’s potential to trigger additive errors.

Generally, it seems that in our attempt to design “models” which support ratio reasoning, and the avoidance of additive strategies in particular, we succeeded best in the pictorial designs. We guess that the other “models” need to be taught to children and not just presented to them. Thus we see the significance of the new measure as a means of understanding the “model” effect: use of the difficulty of the model and non-model items alone is not so helpful.

CONCLUSIONS AND DISCUSSION

Our aim was to complement what has already been reported on the children’s inappropriate use of additive strategies in responding to test questions which are relevant to their curriculum. We have developed two scales which measure “ratio reasoning ability” and “tendency to additive strategy” and both scales contain “model” and “non-model” parallel items. We found that the additive tendency accounts for only a small proportion of children’s problems with ratio.

The influence of presentation on item difficulty and on additive tendency is strong and Table 3 suggests that items might be chosen selectively to provoke or avoid conflict between children’s different responses.

While most of the particular items we have used for our instrument are not new, the development, validation and calibration of the measures around the additive strategy is. We have demonstrated how these tools can be used for research purposes but we also believe in their importance on teaching practice and teacher education as well. We

suggest that the knowledge that teachers would collect from these scales might enrich their pedagogical content knowledge about ratio and proportion (in a manner discussed in Williams & Ryan, 2001) and thus help them improve their classroom practice.

We gratefully acknowledge the financial support of the Economic and Social Research Council (ESRC), Award Number R42200034284

References

- Afantiti-Lamprianou, T. & Williams, J. (2002). A developmental scale for assessing probabilistic thinking and the tendency to use a representativeness heuristic. In A. Cockburn & E. Nardi (eds.) *Proceedings of the 26th Conference of the International Group for the Psychology of Mathematics Education (PME)*. Norwich: University of East Anglia.
- Bell, A. Costello, J. & Küchemann, D. (1985). *Research on Learning and Teaching*. Windsor: NFER-NELSON.
- Cramer, K. Bezuk, N. & Behr, M. (1989). Proportional Relationships and Unit Rates. *Mathematics Teacher*, 82(7), 537-544.
- Hart, K. (1981). *Children's Understanding of Mathematics, 11-16*. London: John Murray
- Hart, K. Brown, M. Kerslake, D. Küchemann, D. & Ruddock, G. (CSMS). (1985). *Chelsea Diagnostic Mathematics Tests. Teacher's Guide*. Windsor: NFER-NELSON.
- Kaput, J. & Maxwell-West, M. (1994). Missing-Value Proportional Reasoning Problems: Factors Affecting Informal Reasoning Patterns. In G. Harel, & J. Confrey, (eds.) *The Development of Multiplicative Reasoning in the Learning of Mathematics*. Albany: State University of New York Press.
- Lamon, S. (1993). Ratio and Proportion: Connecting Content and Children's Thinking. *Journal for Research in Mathematics Education*, 24(1), 41-61.
- Misailidou, C. & Williams, J. (2002). Diagnostic Teaching and Ratio: The Effect of Pictorial representations on Strategies. In A. Cockburn & E. Nardi (eds.) *Proceedings of the 26th Conference of the International Group for the Psychology of Mathematics Education (PME)*. Norwich: University of East Anglia.
- Singh, P. (1998). *Understanding the Concepts of Proportion and Ratio among Students in Malaysia*. PhD Thesis. The Florida State University.
- Tourniaire, F. & Pulos, S. (1985). Proportional Reasoning: A review of the literature. *Educational Studies in Mathematics*, 16(2), 181-204.
- Tourniaire, F. (1986). Proportions in Elementary School. *Educational Studies in Mathematics*, 17(4), 401-412.
- Williams, J. & Ryan, J. (2000). National Testing and the Improvement of Classroom Teaching: Can they Coexist? *British Educational Research Journal*, 26(1), 49-73.
- Williams, J. & Ryan, J. (2001). Charting Argumentation Space in Conceptual Locales. In M. van den Heuvel-Panhuizen (ed.) *Proceedings of the 25th Conference of the International Group for the Psychology of Mathematics Education (PME)*
- Wright, B. & Stone, M. (1979). *Best Test Design*. Chicago: MESA Press.

MATHEMATICIANS' WRITING

Morten Misfeldt, morten@lld.dk

Learning Lab Denmark, Empdrupvej 101 DK-2400 Copenhagen

Computer systems that support collaboration among students are not easily adopted in mathematics education. A possible reason for this is that the computer is rarely the students' preferred writing tool in mathematics. This paper investigates the writing processes of two research mathematicians, and tries to understand what parts of the mathematical writing process it is relevant and possible to support with a computer, for research mathematicians as well as students of mathematics.

INTRODUCTION

In recent years many educational institutions have introduced computer systems to support collaboration among students. The use of such systems is, in the literature, referred to as Computer Supported Collaborative Learning or CSCL (see Koschmann, 1996). These systems seem to have had some success in many areas, but are typically not easily adopted in mathematics (see Guzdial et al., 2002). This somewhat contrasts with the results from a large interview-based study by Leone Burton (1999) on how research mathematicians come to know mathematics, revealing that the discipline is moving towards a more collaborative nature (see Burton, 1999 p. 137). The reason for the lack of success in introducing computer systems to support collaboration in mathematics education could be that mathematical notation is difficult or impossible to write in many computer systems. This problem was approached in Guzdial et al. (2002) by constructing a formulae editor for a very successful CSCL system (the CoWeb). The mathematics students did not adopt this improved system, which suggests that either the students did not want to collaborate or that the possibility of writing formulas was somehow insufficient to facilitate collaboration through such a system (or a combination of the two).

Writing on a computer is often a prerequisite for collaborating through a computer system, and an increasing amount of students' writing, at most levels and in most topics, is done using a computer. But in mathematics this is typically not the case, because the many graphical elements and complicated notation makes it easier to use pen and paper than the computer. Thus the introduction of computer supported collaboration in mathematics education is intimately connected to the development of writing tools that support the mathematical writing process.

This paper investigates the mathematical writing process through the cases of two research mathematicians. There are several reasons to look at research mathematicians' writing processes in order to understand why it is so hard to use computer systems for collaboration in mathematics education. First of all it seems reasonable to search for inspiration for students' collaborative writing processes among research mathematicians, since they according to Burton (1999) collaborate more and more. Another advantage of looking at research mathematicians is that, compared to others, they use computers for writing mathematically to a much larger extent.

Burton & Morgan (2000) have, in connection with the study described in Burton (1999), investigated the language used in mathematical research papers. Their focus is on the natural language used in finished research papers and their goal is partly to describe what type of writing is acceptable in the mathematical community (see Burton & Morgan, 2000 p.432). Where Burton & Morgan (2000) describe the natural language used in the finished paper, this study is concerned with the full range of representations and tools used by the mathematician throughout the entire writing process. And where Burton (1999) is an epistemological study, this study is more pragmatic in the sense that it describes existing practices of mathematicians and because it is motivated by the practical problem of why it is so hard to make students use a CSCL system in mathematics.

What this study does share with Burton (1999) and Burton & Morgan (2000) is an underlying assumption that a closer look at the practice of research mathematicians can reveal information of potential importance for mathematics education.

QUESTIONS

The main question of my research is: Why is it so difficult for mathematics students to collaborate through a computer system? And, can new technology or a different use of existing technology make it easier for students to collaborate in this way? These questions will not be answered completely here. But I will try to get closer to an answer by describing the writing processes of research mathematicians from an early idea to a finished paper. In particular, I will compare the purposes writing serves for the mathematician (e.g. to save information, work out a calculation, communicate to a collaborator etc.) with the types of representations he/she uses and the media (computer or pen and paper) he/she chooses.

METHODOLOGY

In this research report I present two cases to illustrate two somewhat different approaches to writing in mathematical research. Both cases are part of a larger interview-based study on the writing processes of research mathematicians, and the purpose of this report is partly to develop a framework for this larger study. I will describe the methodology of that larger study here. I have met all the participants in their offices where I interviewed them. The length of the interviews ranged from approximately half an hour to a little more than one hour, but most of the interviews lasted about 45 minutes. The interviews were organized as conversations around two main questions concerning (1) communication during collaborative research projects and (2) the use of writing in the personal research process. During the conversations the respondents sometimes referred to papers on their desks or in their archives. If a sheet of paper was especially interesting, for example because it contained a form of representation that was new to me, or because we had had an interesting conversation about it, I would ask for a photocopy of that sheet.

The interviews were taped and transcribed. In the analysis of the interviews I brought in samples of working papers where relevant.

RESULTS

In the following I account for the writing processes of two mathematicians “Peter” and “John”. I focus on the work they do when they are alone, without face-to-face contact with collaborators, where most communication is done using a computer.

Stepwise Writing: The Case of Peter

Peter uses three different media for writing mathematics (two paper-based and one electronic) and he clearly classifies his work according to the medium in use. The media are blank scratch paper (the backside of old printouts) for handwriting, a lined pad also for handwriting and his computer with an e-mail program and LaTeX ¹.

I followed Peter through a short writing process. When I first came to see him he explained that he had recently been thinking about a problem that he was working on together with a collaborator. He had the main idea worked out and had just begun the process of writing it out in detail. I received a photocopy of his detailed draft three days later and after a week I was cc’ed with a first edition of an article on the subject, that he e-mailed to his collaborator. Soon after that I interviewed him again.

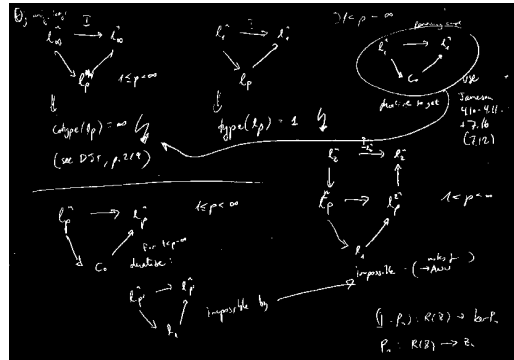

Figure 1: Scratch paper

Peter’s office contained a whiteboard next to a large bookshelf and across from that a small desk with Peter’s computer next to the main desk². When I first visited Peter, on the main desk, there was a pile of scratch paper (backside of old printouts), a folder, a pad of lined paper and two books. One sheet of scratch paper was placed in the middle of the desk and filled with scribbles (see figure 1). The folder was filled with sheets from the lined pad, and on the lined pad there was handwritten mathematical text (like the sheet to the left in figure 2).

Peter uses the scratch paper for personal scribbles, and he explains that these papers only make sense while he is in the process of working on a problem, and that most of them are

¹ LaTeX is a typesetting system widely used in the mathematical community. The author will write a source code in a text editor and process it to a print file. So the author will write:

$\$ \int_a^b f(t) dt = F(b) - F(a) \$$ in a text editor, to typeset: $\int_a^b f(t) dt = F(b) - F(a)$ in the

print file.

²The fact that the computer was on a separate desk is common among research mathematicians.

thrown away almost immediately. The content of the scratch paper has no obvious linear structure (see Morgan, 1997 p. 89); it consists of scribbles scattered around the paper.

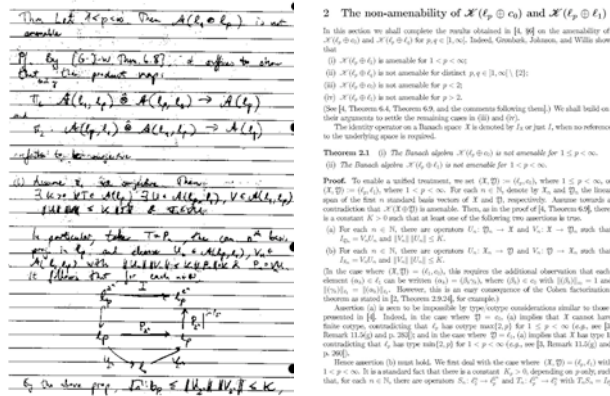

Figure 2: Lined pad and LaTeX version

Peter explains, “If I believe something [from the scratch papers] seems to be working out right then I will take the lined pad and try to write down as many details as possible.” Again, when that is done the scratch papers are thrown away but the lined paper with all the details are kept carefully in a system of folders. Peter explains that the purpose of writing it out in detail is twofold: to make the work accessible later, and to check in detail if his ideas are correct.

When Peter thinks he has enough work for an article, or a part of one, he will write a LaTeX version of his work. He describes that version as “much shorter, to fit an article”. The computer version is sent to collaborators for comments and proofreading, but the main reason for making the LaTeX version is to produce a paper.

Peter believes that the notes on lined paper in his folders contain more information than the finished paper. He keeps the notes partly to be able to go back and investigate ideas he never published, and also so he can always go back and check how he got to a specific result. Peter imagines that this would be practical if confronted with questions of how he got to a specific result, both to be able to defend his results and more easily acknowledge if he made a mistake.

Peter communicates with collaborators mainly by e-mail. He explains that the content is often very close to the content of the notes on lined paper that he keeps in his folders. To be able to express mathematics in an e-mail he will often use LaTeX code³ in the e-mail. This gives rise to some extra work with moving the content to another medium. To avoid this work, Peter has tried to fax the notes from the folder, but has had difficulties with

³ In e-mails a special use of the LaTeX commands has developed. Since e-mail does not support mathematical symbols it is common to use the LaTeX command whenever a symbol is needed, this style, sometimes denoted “pseudo LaTeX”, seems to be fully accepted in e-mail communication among mathematicians.

this. Peter explains that if, when writing, he had to think about how it could be faxed (i.e. choose a dark pen, avoid using the margin, think about a potential reader etc.), this would disturb his thinking and he would be less able to concentrate on checking the mathematical details of his idea.

Successive Writing: The Case of John

In the early stages of his writing, John uses paper and pen. He describes the “first treatment/phase one” work as being inaccessible to others and not for archiving, at least not without some explanations⁴. What John will do next then depends on how things proceed. If he gets to a publishable result he will very soon write an early version in LaTeX, and then start to work with pen and paper on a printout version of that, successively adding to and correcting the LaTeX draft, which therefore evolves dramatically over time. John explains that he deliberately does not try to get it right from the beginning. On the one hand, John writes the LaTeX draft to save his work and start the production of an article. On the other hand, the contents develop over time; the creative work is not over when the first draft is written in LaTeX. John argues that this way of working suits him better than trying to have it all figured out from the beginning.

If John does not arrive at something publishable he will sum up his work and save it in a large metal drawer. This is done with pen and paper, the same type of paper as he uses in the first phase. The summary consists of things like “I have been working on x using the approach y ; I got stuck there.” Apart from these overviews the summary consists of annotations and re-writings of some of the early stages of his research. The purpose of this summary phase is to make a saveable version of his early scribbling.

ANALYSIS

Functions of Writing Mathematically

The writing processes of Peter and John have led me to consider the following five different functions of writing in mathematics explained below. By distinguishing between these five functions I do not claim that they are mutually disjointed or that they completely cover what mathematical writing is. Rather, I try to give a framework for further analysis of the mathematical writing process.

(1) *Heuristic treatment* consists of getting and trying out ideas and seeing connections. (2) *Control treatment* is a deeper investigation of the heuristic ideas. It can have the form of pure control of a proposition or be a more open-ended investigation (e.g. a large calculation to find x). It is characterized by precision. (3) *Information storage* is to save information for accessing later. (4) *Communication* with collaborators and (5) *Production* of an article.

The first three functions are inspired by Duval (2000), who distinguishes two significant ways in which writing expands our cognitive abilities: To help save information and to support ongoing mental processes. Both heuristic treatment and control treatment support

⁴ He even explains how he sometimes tries to take up a project that has been sitting for a month and finds that his notes are unusable.

ongoing mental processes, and I believe the cases show that it is reasonable to consider them separately.

The Cases

With the framework from the previous section it is possible to describe the writing processes of Peter and John in some detail. In the following figures I have tried to map a timeline of how the functions of heuristic treatment, control treatment, and production come into play, and in which medium this occurs. Each box describes a specific medium used for a certain function at a certain stage, and is annotated with information regarding information saving and communication during this stage of work.

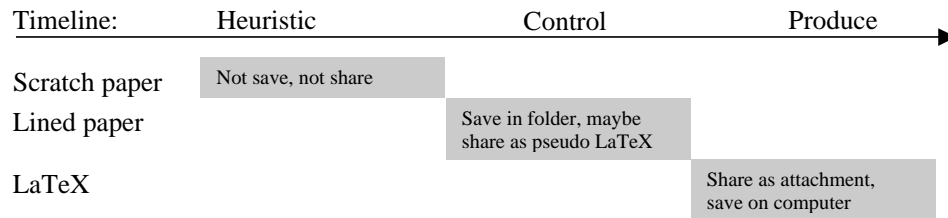

Figure 3: Diagram of Peter's writing process.

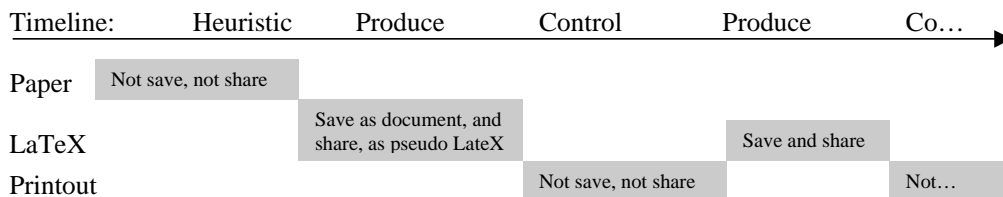

Figure 4: Diagram of John's writing process in the case where he arrives at something he decides could be an article. Note that in the last phases of his work he will switch back and forth between working with LaTeX and with a pen on a printout of his document.

Both Peter and John use pen and paper for heuristic treatment. But whereas Peter uses one type of paper for heuristic treatment and another type for control treatment, John just uses paper. John often combines pen and paper with LaTeX drafts in the control treatment phase. To save information Peter uses papers in folders and John uses either an evolving LaTeX draft or pieces of paper from heuristic or control treatment annotated in order to be saveable. They both communicate with collaborators by e-mail, sometimes attaching LaTeX files. To produce articles they both use LaTeX. But where Peter basically sits down and transcribes a paper draft to the computer in order to write an article, John's work will evolve from control treatment and personal saved work towards an article as a LaTeX file.

Both Peter's and John's working papers develop from containing mainly symbolic language in the heuristic phase towards the extended use of natural language in the control phase. But where the samples from Peter have a clear movement from nonlinear (see Morgan, 1998 p.89) writing in the heuristic phase towards linearity in the control and production phase, John's working papers are linear throughout the writing process. For Peter, the control treatment is intimately connected to saving information and

communication with collaborators, whereas the heuristic treatment does not seem to be connected to those functions. The production of an article is connected to communication with collaborators because Peter sends his drafts to his collaborators for comment, but production does not seem to be connected to either heuristic or control treatment. For John, there is a strong connection between the production of an article, the saving of information and control treatment because he saves his work in an evolving LaTeX document and checks details by working with a printout of his LaTeX document.

EDUCATIONAL PERSPECTIVES

Pen and paper play a central role in the heuristic phase of the two mathematicians' work; neither uses a computer in that phase. This suggests that the existing computer systems do not support heuristic mathematical writing among researchers. The mathematical activities of students, as well as their use of computers, are of course different from those of researchers, but one can at least question whether students will benefit from using the existing technology for heuristic writing when researchers do not. Since none of the mathematicians use the heuristic phase directly for saving information⁵ or for communication, it can be argued that computer support for heuristic mathematical writing is not essential for the success of computer supported collaborative learning environments.

The control treatment seems to be highly connected with communication and the saving of information, and both of the researchers are able to use computers to support that function. Therefore the development of better tools to support writing that serves a control treatment function seems to be relevant for the success of CSCL in mathematics.

Even though the cases show some similarities in the mathematical writing process, they definitely also show diversity. Students are also different and have different writing processes. I find it especially important to note that this framework does not suggest one canonical "best sequence of phases" in mathematical research. Rather than using technology to encourage or force students to approach problems in one specific way, I would suggest that the students, while working with mathematics, should have access to the best possible support for their writing at all times, and learn (implicitly or explicitly) to choose the kind of support that best suits the task at hand, acknowledging that this support will be different for different persons.

It goes without saying that as long as pen and paper are the primary support for one or more of the functions in mathematical writing (as seems to be the case at the moment) the students should have access to this medium at all times. Doing mathematics in computer labs without sufficient desk space is a problem when some essential work in mathematics is best done with pen and paper.

I believe that an increased awareness of the nature of mathematical writing processes can be relevant to mathematics education in general. The fact that at least some research mathematicians do not start producing their work before they have gone through a heuristic and perhaps also a control phase, could perhaps be relevant to the problem of

⁵ John actually uses some of his sheets from the heuristic phase in his archive, but these sheets go through major revision (annotation and re-writing) in order to be saveable.

how to introduce writing in mathematics education. For example, can the well-known problem of students writing too little text to answer word problems be described in the framework suggested here as students delivering their work too early rather than it being incorrect. So rather than encouraging a student to write more while working on a solution to the problem, thus giving the student the impression that he/she solved the problem incorrectly, the teacher might make the student aware that his/her work is proceeding well but needs to be written out in more detail in order to make sure that the results are correct and can be read by others. A different but related problem is the use of pre-made worksheets for students to fill out with solutions to problems. The sheets are made to help the students, but can end up disturbing their creative process by forcing them to think about the finished product (e.g. readability) too early in the process.

It is not entirely clear how an analysis of the writing and working processes of research mathematicians is relevant for mathematics education. On the one hand, many typical activities in the mathematics classroom greatly differ from mathematical research. On the other hand, I think that an awareness of the mathematicians' strategies and choice of medium in different stages of the writing process can give a new perspective on students' problems in mathematics. Moreover, I believe the problems that research mathematicians have in using computers for writing mathematically are potentially relevant for the introduction of computers in mathematics education.

References

- Burton, L. (1999). The Practices of Mathematicians: What do They Tell us About Coming to Know Mathematics? *Educational Studies in Mathematics*, 37 121-143.
- Burton, L. & Morgan, C. (2000). Mathematicians Writing. *Journal for Research in Mathematics Education*, 31, 4 429-453.
- Duval, R. (2000). Écriture, raisonnement et découverte de la démonstration en mathématiques. *Recherches en Didactique des Mathématiques* 20 (2000), 135-170.
- Guzdial, M., Lodovico, P., Realf, M., Morley, T., Carroll, K. (2002). When Collaboration Doesn't Work. *Proceedings of the 5th International Conference of the Learning Sciences*
- Koschmann, T. (1996). *CSCL: Theory and practice – of and emerging paradigm*, Lawrence Erlbaum Associates Publishers, New Jersey.
- Morgan, C. (1998). *Writing Mathematically: the discourse of investigation*, Studies in mathematics education, Falmer Press London.

A CO-LEARNING PARTNERSHIP IN MATHEMATICS LOWER SECONDARY CLASSROOM IN PAKISTAN: THEORY INTO PRACTICE

Razia Fakir Mohammad

Aga Khan University, Pakistan

My research involves studying mathematics teachers' classroom implementation of their learning from an 8 weeks in-service course at a university in Pakistan. In this paper I discuss my learning, resulting from participation in collaborative work with teachers in my research. I performed two roles: the role of teacher educator supporting teachers' trying out their new aims of teaching in the classroom and also the role of researcher collecting data during the teachers' engagement in their learning. I was also engaged in self-inquiry into my role as a teacher educator through my own reflection on the processes and issues of the teachers' learning as well as my participation in the two roles. The analysis of my participation in our collaborative partnership reveals that although I tried not to dominate, I recognised that my own ethical and theoretical perspectives of being a teacher educator in the Pakistani context made me react in ways that could be regarded as directing the teachers' thinking and behaviour. This became one of the major issues or tensions in my study. I was not aware of this issue until I experienced the reality of these teachers' practices.

As a doctoral student, I began this research as a study of how mathematics teachers' had implemented their learning into classrooms following their participation in an in-service education programme at a university in Pakistan. In the first phase, I adopted an interpretative stance in a phenomenological tradition in terms of understanding of teachers' classroom implementation of their learning following a university course. From Phase 1 I recognised that serious difficulties existed for the teachers in translating their learning from the university into activity in their classrooms. A need emerged on the part of teachers for support and guidance in the implementation of their learning objectives. In Phase 2, I, therefore, extended this research from a study of teachers' implementation strategies to a participatory study of processes involved in supporting teachers' learning and classroom implementation. In this paper I will focus on my own learning as a teacher educator and researcher.

THEORETICAL PERSPECTIVES

Wagner (1997) introduces the term of 'co-learning agreement' in research relationships between the participants in research. He discussed three modes of co-operation in educational research namely those of *data extraction agreement*, *clinical partnership* and *co-learning agreement*. The difference in these three forms of research relationship determines social arrangement, expectations of the participants, and implications of the research project. In a co-learning partnership, the research is seen as a more interactive social approach for the educational reform process. As Wagner states:

In a co-learning agreement, researchers and practitioners are both participants in processes of education and systems of schooling. Both are engaged in action and reflection. By working together, each might learn something more about the world of the other. Of equal importance, however, each may learn something more about his or her world and its connection to institutions for schooling (p.16).

Jaworski (2000) extends the co-learning idea to the relationship between teachers and teacher educators, as well as between teachers and researchers. She states, 'A co-learning partnership implies an explicit arrangement agreed between participants (p. 6). According to Jaworski, the consequences of such a negotiation would be a growth of knowledge for both the participants (e.g. teacher and researcher, or teacher and teacher educator) with recognition and resolution of everyday dilemmas of teaching, and teachers' learning.

I inferred that a commitment for learning could be an activator in the sense that it engages teachers in taking actions on the basis of their self-critical reflection, resulting in creating change at a rate, which, is feasible for practical needs (Schon, 1983; Carr & Kemmis, 1986). In this perspective, I assumed that the teachers' engagement in thinking and dialogue about their actions, in the context of their classrooms for improvement of practice, would advance their learning about mathematics teaching. This is parallel to the perspective of students' learning in a mathematics classroom, students collaboration with a teacher, where both teachers and learners consult and respect each other's experiences and knowledge as well as question them in order to enhance learning (Povey and Burton, 1999). Thus, these were my own philosophical starting points in working with the teachers through which teachers and teacher educators might achieve status of learners within their respective roles. However, the theoretical position, which I adopted, became challenged in the realities of the teacher's classroom.

METHODOLOGY

I worked with three teachers in the second phase of my research. They had resumed their teaching after attending an in-service course at a university in Pakistan. However, in this paper I shall report on some aspects of the work in the second phase with one teacher. The data in this phase of research mainly involve field notes, audio-recorded conversations, in the pre and post-observation meetings, with teachers and my reflective journal entries. I met each of the teachers once a week, (from mid December, 1999 to Early August, 2001 in the second phase of the research) on a regular basis, although, sometimes it was twice a week if a teacher needed my support. I first analysed data from observations and conversations to characterise the teachers' learning and identify issues. Analysis of my own learning began with a review of the examples and issues arising from my analysis of teachers' learning (Mohammad, 2002). I listed the issues in three groups related to the teacher educator's engagement in the collaborative work, its outcomes and its tensions. I further listed the issues from my reflective journal entries regarding analysis of work on particular events. Examining each example closely, I identified key events that presented dilemmas for me as a teacher educator. These key events address the issues and tensions of my actions, their relation to my philosophy of collaborative partnership and the practical reality of school.

WORKING FROM MY THEORETICAL PERSPECTIVES

Conceptually, I believed that teachers would learn best by exploring their own issues and identifying their own needs with my support. However, from my wider set of analysis of examples, there were many events which involve issues where I (as a teacher educator, in response to the teachers' needs) intervened and guided the teachers' actions in a way that seemed at first contrary to my ideology of development of teaching in a co-learning partnership. Such examples also highlight the difficulties I experienced in promoting a shared sense of participation in a co-learning partnership with the teacher. These difficulties exemplify issues related to sensitivity in not threatening these teachers' self-esteem in my commitment of a co-learning partnership. I offer the following examples in order to discuss the constraints and possibilities of working together.

Example 1: Planning Percentages

In one pre-observation meeting, the teacher asked me to discuss how to teach 'percentages'. He said that he had been teaching the textbook exercises since he had started teaching, and did not have any alternative ideas. We began the lesson planning by reading the relevant content^[1] of the textbook, because it was the only resource available at the school. When I asked him to share his understanding of the content, he could not explain anything other than the method in the book that multiplying a fraction by hundred converts to a percentage. It seemed to me that reading and understanding the content were two different issues for him. I shared some examples with him about using percentages in daily life (for example, examination grades, rates of tax, discounts) and the meaning behind that language. He said that now he remembered that percentage meant 'a part out of a hundred'.

The teacher then suggested that we needed to use some cards (or posters) for writing different examples from daily life, as he had used in his university course. He thought of different examples: 20% extra toothpaste, 50% off the cost, 2.5% Zakat^[2] etc, so the students could discuss the use of percentages and explore their meaning. However, he then raised an issue about access to resources. There was no material at the school, nor was there any arrangement for hanging charts in the classroom. I encouraged him to think about other possible ways to present this idea in terms of daily life examples, but he could think of nothing other than making posters. I suggested he could present examples by writing on the board or by expressing them verbally in order to initiate the discussion. He assumed that verbal explanation would be unattractive for the students, while writing was time consuming:

The writing could take more than 10 minutes, and in a 30-minute period, I do not think it is possible to teach a complete lesson. I do not think that verbal examples could motivate children to participate in the discussion. Children need stimulus; this is the beginning [to apply different methods] (6 Jan, 2000).

How to plan a lesson beyond the textbook was a demanding task for him. I asked him to think about introducing the topic by reviewing simple fractions. He responded positively to my encouragement and expressed an interest in learning but lacked the ability to initiate his thinking at this stage. He asked me how he could teach fractions and their relations to percentages as well as completing the textbook's exercise in the limited time

of a single lesson. I encouraged him further to think for himself. The teacher appeared frustrated by my further encouragement. He said ‘I am here to learn from you’. My judgment of the situation was that the teacher’s frustration might affect his behaviour so that he might not bring any change to his class. It was impractical to expect that he could explore new methods.

Example 2: Teaching Decimals

This was our last meeting in relation to our working together. In the pre-observation meeting the teacher said that his purpose was to teach the methods of converting decimals into common fractions and vice versa with reasoning. For this purpose, he had planned activities. However, the issue of the teacher’s limited understanding of decimals was not disclosed to me during his sharing of the planning. In order to discuss my dilemma as a teacher educator in this example, I need to provide some details from the lesson.

The teacher wrote on the board: $.1 = 1$ [I found it hard to understand what he meant here, but it became clear that it aided his idiosyncratic understanding of converting between fractions and decimals].

1 T You should remember that the decimal point always has a value equal to one.

He wrote a series of numbers on the board: $.1, .11, .111, .1111,$

2 T Observe the values of these numbers in common fractions.

Firstly he considered ‘.1’

3 T Write the number as a numerator. Remove the point from the number and write one as the denominator. Now count the numbers after decimal and put zeros accordingly in the denominator.

He wrote, $.1 \Rightarrow \frac{1}{10}$. (His verbal and written explanations were going on simultaneously).

He solved another question. He wrote, $.11 \Rightarrow \frac{11}{100}$.

4 T We can write this (*pointed to $.11$*) in this way.

He wrote, $\frac{11}{100} \Rightarrow \frac{1}{10} + \frac{1}{100}$ [I think he intended to write that $1/10 + 1/100 = .11$, which is another way to represent $11/100$, but what he wrote was incorrect].

Then he called one of the students and asked him to write $.111$ in common fractions. He guided the student to solve the question correctly in a similar way to the previous examples. (17 June, 2000)

The teacher had his own idiosyncratic way of thinking about the equivalence of decimal and fraction representations. He had given a mathematically meaningless explanation to the students; it seemed to me that he reasoned as follows:

- Given a decimal such as 0.111, write, $\frac{\quad}{1}$
- Count the figures after the point – in the case of 0.111; there are three figures, so write three zeros after the 1 in the denominator, i.e. $\frac{\quad}{1000}$
- In the numerator, write the figures that follow the decimal point, i.e. $\frac{111}{1000}$

The teacher's method produced correct answers but the explanation behind those answers made no sense mathematically. This was a case of his reconciling a new method of teaching with his limited knowledge of the concept. I could have discussed that issue with the teacher in the feedback session as I believed that dialogue promotes shared understanding. However, this was our last meeting regarding the research partnership. The teacher might not have had time to clarify his concept and then inform students' concepts.

Tension

I was aware that implicit assumptions as a researcher and my intervention as a teacher educator might encourage the teacher's dependency on me resulting in an expert-teacher rather than learner-learner partnership.

There was a conflict between different assumptions lying behind each of my roles. This raised the questions for me about how I could ignore my assumptions lying behind my commitment to achieve a co-learning partnership or my responsibility as a teacher educator to achieve teacher development. Could I separate them? Could the teacher gain the knowledge (he needed) by himself? Did my moral encouragement alter knowledge constraints? There was the possibility that the teacher's ignorance or lack might cause drawbacks in the students' learning and his teaching. It was also that teachers need a good understanding of mathematics to shift their practice towards the promotion of students' thinking (Ma, 1999). It was difficult for me to follow my own philosophy of learning in the face of the reality of these teachers' practice in school. I questioned my philosophy: How could my ideology fit in this context of constraints? Was the ideology flawed? I realized that working with my ideology would cost the teachers time, energy and motivation, which could result in disappointment.

My Intervention

Referring to Example 1, I involved the teacher in a paper folding activity through which he could experience an approach to the concept of fractions and their connections to percentages. It is evident (Mohammad, 2002) that when the teacher understood the concept himself he suggested that we could discuss different fractions by dividing a whole into parts, and then move to dividing it into a hundred parts. He also added that

we should include some verbal examples from daily life, as we discussed before, and then move to the textbook exercise.

Referring to Example 2 I realized a need to demonstrate the teacher's method with appropriate mathematical explanations so that he could find the gaps in his understanding as well as fill those gaps. To reduce a sense of threat of my intervention I asked him if I could take part in the teaching as I developed interest in that topic, and he accepted. I intentionally reviewed his first activity before I went on to the second part of his lesson in order to give an appropriate meaning of decimals because of the following reasons:

- I wanted to reduce any negative impression created by rejecting his methods, and I also wanted to protect him from humiliation.
- I wanted to maintain continuity in the lesson and wanted to teach the teacher ways to link the first activity to the other.

In the feedback session we discussed the topic further (for example, what is meant by 0.432). The teacher analysed his planning process, and his misinterpretation of decimal points. Analysing the impact of his limited knowledge in the lesson, he said that he had not taught the meaning of decimal points before, nor had he himself learned in this way. We discussed various issues, for example, my interruption in his teaching, and his learning of mathematics. The teacher said that my taking over the teaching was the right decision. He suggested such support might prevent the students from being given wrong concepts while the teacher could benefit from acquiring mathematical learning.

DISCUSSION

The above examples revealed that problems with mathematical knowledge presented a barrier to the teacher in unpacking the conceptual underpinning of mathematical procedures when they made the effort to plan and teach the lessons with reasoning. I, as a teacher educator, felt myself in a responsible position in terms of my understanding of teacher education, and the practical realities of the teachers, resulting in my taking a leading role. However, the differences in knowledge and understanding, in our partnership, were not viewed as teachers' deficits or a teacher educator's surplus but were appreciated as resources of co-learning. When the teachers received practical support from the teacher educator, they were able to resolve local problems and develop teaching. However, for long-term development teachers still need support and an understanding of the global issues of their comprehending what is needed within the development processes. I judge as teachers' needs were satisfied and their practical realities addressed, the two partners grew to achieve a relationship of trust in a co-learning partnership. I refer here to a teacher's comment at the end of a partnership day as an example of the issues raised by the collaborative partnership.

You are leaving me at the wrong time. With you, I understood my role in my improvement. I am becoming confident about how that learning situation could be improved in the inconvenient situation of the classroom (7 August, 2000).

It is important to recognise here that our partnership was still developing.

Conceptually a commitment to learning establishes a teacher educator as a learner along with the teachers. However, the responsibility of a teacher educator of teachers' developing teaching cannot be ignored. In the context of Pakistan, teachers have never been encouraged to question or analyse their own or others' actions within their schools, except their short-term experiences of learning at the University. In addition, teachers have limited knowledge and understanding of mathematics relating to new practice. Also, teachers might not be aware of their own mathematical misconceptions. Therefore, it is likely to be difficult to develop an attitude in which teachers see questioning as learning. Thus, the assumptions behind being reflective learners in isolation from teachers' limitations, without rationalisation of their reality, might not be enough to support teachers' learning in a collaborative partnership.

New Understanding of a Co-Learning Partnership

A co-learning partnership does not view an explicit authority on either side. However, the partnership itself is authoritarian - a common purpose of 'improvement' directs the partners to accept a mutual agreement and lead them to play their parts with appropriate support to achieve their development. This authority negotiates differences of knowledge and understanding positively leading the teachers to apply their learning of a new mode of teaching in their own classroom, within numerous constraints, and the teacher educator to take responsive actions to promote the teachers' self-realization within constraints and ignorance.

The nature of collaborative partnership cannot be achieved by the singular influence of any ideology or the theoretical assumptions of collaborative work. It is utterly dependent on the needs of the teachers and the reality of their context. Developing an attitude in which teachers see and experience questioning as learning should be integrated with the provision of adequate interventions. My study confirms that imposition leads to improvement only if it is central to teachers' needs and addresses the practical reality of their school. Input nurtures teachers' practice and thinking without taking away their autonomy. Also the threat of humiliation can be reduced if teacher educators sit with the teacher and offer support in ways consistent with encouraging the teacher's thinking and autonomy. Expecting teachers to be ongoing learners in their improvement without considering their constraints and providing appropriate support may retain the threat of power imbalance in terms of working relationships (between teachers and a teacher educator or schools and university) leading to unobtainable teacher development within the school environment. Differences in knowledge cannot be denied, nor can the critical reality for teachers in a school context. My conclusion is that the philosophy of a teacher educator causes tensions when it does not fit with the school reality.

Achievement of the collaborative culture of learning is not the result of a contribution of equal levels of knowledge and understanding. Rather it is the achievement of a growing relationship where a teacher educator supports teachers morally and practically while trying not to lower their self-esteem. Thus balance of power in a teacher educator's engagement does not imply an authority to impose his or her theoretical perspectives on teachers. Neither does it claim to achieve equal decision making status in the initial stages of collaboration between teachers and a teacher educator. The notion of power-imbalance could be perceived as a positive element in supporting teachers' learning

according to their real constraints. My study exemplifies how teacher educators might help teachers to gain a better understanding and confidence; and if knowledge is power and responsibility also a power then power always exists but a threat of power in impeding learning is reduced through a co-learning partnership. The need is not to deny this power but to declare ways to negotiate the power so as to create a trusting relationship for learning, i.e. a relationship where partners feel secure and confident and achieve mutual dependency and interdependency in decision-making. Thus, establishment of a co-learning partnership is to achieve a shared goal of learning from and with each other in a trusting environment that supports learning processes with an awareness and integration of contextual reality.

Endnotes

^[1] The textbook suggests ‘percentages are special fractions’

^[2] Zakat is one of the fundamentals of Islam; according to it Muslims are obliged to share 2.5% of annual saving with the poor.

References

- Carr, W. & Kemmis, S. (1986) *Becoming Critical: Education: Knowledge and Action Research*, London: The Falmer Press.
- Fakir Mohammad, R. (2002) From Theory to Practice: An understanding of the Implementation of In-service Mathematics Teachers’ Learning from University into the Classroom in Pakistan, Unpublished Doctoral thesis: The University of Oxford.
- Jaworski, B. (2000) *The Student-Teacher-Educator-Researcher in the Mathematics Classroom: Co-learning Partnership in the Mathematics Teaching and Teaching Development*, Invited Keynote Address MADIF (2) Svensk forening for Matematik Didaktisk Forskning (Swedish Society for Research in Mathematics Education.
- Ma, L. (1999) *Knowing and Teaching Elementary Mathematics*, London: Lawrence Erlbaum Associates.
- Schon, D. (1983) *The Reflective Practitioner*, New York: Basic Book.
- Wagner, J. (1997) The Unavoidable Intervention of Educational Research: A Framework for Reconsidering Researcher-Practitioner Cooperation, *Educational Research*, 26(7), pp. 13-22
- Povey, H. and Burton, L. (1999) ‘Learners as Authors in the Mathematics Classroom’, in Burton, L. (Ed.) *Learning Mathematics: From Hierarchies to Network*, London: Falmer Press.

PROSPECTIVE ELEMENTARY TEACHERS’ MISUNDERSTANDINGS IN SOLVING RATIO AND PROPORTION PROBLEMS

Cecilia Monteiro

Escola Superior de Educação de Lisboa, Portugal

This study explores difficulties that prospective elementary mathematics teachers have with the concepts of ratio and proportion, mainly when they are engaged in solving problems using algorithm procedures. These difficulties can be traced back to earlier experiences when they were students of junior and high school. The reflection on these difficulties by student teachers, comparing to informal ways of solving the problems is a fundamental step of the pre-service programme in which they are involved. In this communication I also present and discuss an attempt to promote development of prospective teachers’ own knowledge of ratio and proportion as well as their awareness of the pupils’ difficulties on this subject.

Teacher education programmes should provide both a profound mathematics understanding of the basic concepts of mathematics and the capacity of future teachers to be aware of the difficulties and the misconceptions of the students (e.g. National Council of Teachers of Mathematics, 1989, 1991, 2001), in order to enable future teachers to create adequate learning situations for their students. One of the basic concepts of the Portuguese elementary mathematics curriculum (grades 6-9) is the proportionality concept, which has been an obstacle to the learning of Mathematics. Most of the teachers teach this theme in a very formal way, emphasising the memorisation of the rules. Researchers on proportional reasoning have been looking for children’s strategies and errors (e.g. Hart, 1984, Lamon, 1993, Vergnaud, 1988). Vergnaud has mainly distinguished two kinds of strategies to solve situations involving direct proportions: the scalar operator “within” the same magnitude and the functional (across the measures) “between” the two magnitudes. Teachers should be aware of their own strategies and errors when they are dealing with situations of proportionality both direct (isomorphism of measures) and “inverse” (product of measures). They need to understand the differences between these two structures, respecting the invariance and the Cartesian graphs and to know what is the model that is underlying a specific problem.

In this study I will focus on the procedures and on the reasoning of future teachers in solving proportionality problems in the context of a teacher education programme. I begin by providing a short explanation of the programme inasmuch as it seems important to understand the process that prospective teachers followed until being prepared to elaborate lessons for their future pupils to teach ratio and proportion.

THE TEACHER EDUCATION PROGRAMME

The teacher education programme of this study lasts four years, has 28% dedicated to mathematics education, and during the two last years prospective teachers have 6 weeks in the third year and 3 months in the fourth year, of practice in real classrooms. During the practice they are responsible to plan lessons for their “borrowed” 5th and 6th grade pupils. They are accompanied by the teacher of the class and by the supervisor, that is a professor of the Higher School of Education.

What mathematics content elementary teachers need to know, and how their knowledge of mathematics relates to teaching practice and students' learning, are questions that every institution of teacher education should address. Literature in the field (e.g. Wood and Cobb, Yackel, 1991, and Ball, Lubienski, Mewborn, 2001) agree that mathematical content knowledge is important, but is not enough. The process by which teachers learn, the awareness of students' difficulties and the reflection upon their own understanding of mathematics are key features to take into account in pre-service courses. From early days until nowadays, many authors (e.g. Dewey, 1916, Erault, 1977, Zeichner, 1993) advocate the development of reflective thinking in teacher education. Reflection is focused as a very relevant feature to professional growth. One step to understanding the pupil's difficulties is to experience themselves these difficulties and reflect upon them (e.g. Zeichner, 1993). As the way how teachers learn influences the way how teachers work within their classrooms (e.g. National Council of Teachers of Mathematics, 1991), the programme intends to foster in prospective teachers the capacity to design problems, tasks and projects for their students which can provide a meaningful understanding of mathematics. This understanding of mathematics should be deeper in prospective teachers, "it requires that teachers themselves also understand the central ideas of their subjects, see relationships, and so forth" (Ball, Lubienski and Mewborn, 2001, p.43).

Based on these ideas, the mathematics course of the teacher programme, in which these prospective teachers were engaged, underlies three main principles: *Experimentation*, *reflection*, and *transference*. Experimentation since teachers should experiment mathematical activities and not just listen to transmitted knowledge. Reflection provides thinking and discussion on several aspects: the consideration of their own thought process and of the others of solving the task, the mathematical knowledge and concepts that model it, and the students' difficulties. This process can develop a deep understanding of mathematics, mainly related to elementary mathematics education. After that, future teachers are encouraged to product plans of lessons and materials to teach the pupils, in a process of *transferring*. Transference is very crucial, since prospective teachers have during the education programme to do their practice in real classrooms, which provides an evaluation and reflection of their planned lessons.

RATIO AND PROPORTION

In spite of the first explicit indication of ratio and proportion being in the 6th grade (11 years old children) curriculum, during the primary level (until 4th grade) Portuguese teachers teach proportion problems using the unit rate approach. For example, if 2 packs of cereals cost 10 euros, how much cost 4 packs? Primary teachers incite pupils to find the cost of one pack and then multiply by 4 to find the price of four packs. During the 6th grade teachers introduce the ratio notion mainly comparing the number of the elements of two discrete sets, as the number of girls and boys in a classroom. The proportion relationship is introduced as the comparison of two ratios, and students are asked to solve

problems using equations such as $\frac{a}{b} = \frac{c}{d}$ (the variable can have all the four positions) calculating the answer by the cross-product and divide algorithm, or the rule of three that has the same algorithm but that does not use fractions. For example:

packs	euros	
2	10	$x = 4 \times 10 \div 2$
4	x	

It is interesting to note that in 5th and 6th grades textbooks (and probably most of the teachers, as they followed the manual) the reducing to the unit strategy as described above is not used. Also, for instance, in $\frac{5}{15} = \frac{x}{45}$, students are not encouraged to look for the x , by multiplying 3 by 5 using the equivalence of fractions, but they are taught to use the rule.

A considerable amount of research has been developed approaching ratio and proportion, as well as investigating children errors and strategies when attempting to solve problems in this area (Hart, 1984, 1988, Vergnaud, 1988, Kieren, 1988, Cramer, Post and Currier, 1993, Behr, Khoury, Harel, Post, and Lesh, 1997). One source of difficulties may be a consequence of proportional reasoning to be a form of mathematical reasoning that involves a sense of co-variation and multiple comparisons (Cramer, Post and Behr, 1988). These authors refer to Piaget stating that “the essential characteristic of proportional reasoning is that it must involve a relationship between two relationships (i. e. a “second-order” relationship)” (p. 94). Some researchers, (e.g. Cramer, Post and Currier, 1993) call the attention to the fact that someone can solve a proportion using the algorithm, but this does not necessarily mean that he or she are mobilising proportional reasoning. Vergnaud analyses proportion situations in the conceptual field of multiplicative structures as they involve multiplication and division, and he says that “difficulties which students may be due to the context of application more than to multiplicative structures themselves” (p. 142).

METHODOLOGY

Participants: 19 pre-service teachers from a public High School of Education. They are attending a pre-service teacher programme to be teachers of 5th and 6th grades of mathematics and sciences; They are in the 4th year, the last one of the course. All of them completed the secondary school studying Mathematics. When they begin the programme they have a view of mathematics mostly as computation and rules; they have few autonomy, expecting that the teacher explains and afterwards they practice. During their teacher education programme, mathematics and its teaching and learning is based on problem solving and manipulative activities, following the process of the teacher education programme described above.

Prospective teachers tasks: *First task* - Participants were asked to solve three kind of problems, one simple direct proportional situation, one situation with an additive relation between the variables and an inverse proportional situation (product of measures) which are modelling by $y = kx$, $y = x+k$, and $y = k/x$, respectively. All of the situations have a constant k , but just the first and the third are situations in the conceptual field of multiplicative structures (Vergnaud, 1983, 1988). There was no discussion after this task, which was followed by the second one.

Second task: Participants had to solve four problems, one additive relation, two simple direct proportional problem, one with a missing value and the other involving a numerical

comparison of two rates. The fourth problem is a product of measures situation. They are told to solve the problems but now without using any known algorithm and to write an explanation of their reasoning in each problem. After that, prospective teachers discussed in a plenary session the processes they found to solve the problems.

According to the teacher education programme these two tasks are included in the experimentation phase. The following phase provided a long reflection upon the way they solved the problems in both tasks. Teachers were invited to find the similarities and the differences among the problems and to find the mathematical relation between the variables as well as to trace the Cartesian graphs of the situations. Students were asked to find new situations of the three mathematical models. Discussions took place in small groups of 4/5 students and in plenary sessions.

After that a more detailed attention was given to the direct proportion problems as they relate to the children curricula. In addition both scalar relationship and the function relationship were analyzed, as well as the “building up” strategy often used by children. Also problems of missing value, of comparison when the four values are known, use of whole numbers, fractional and decimals were discussed in a perspective of children learning.

Finally students were asked to develop plans of lessons to the 6th grade students. To develop these lessons they had textbooks used in schools (in Portugal there is not a unique manual), books and journals of mathematics education.

Data collection: The data was collected by the answers of the two tasks that were carried out individually, notes of the discussions in groups and plenary sessions, and the lessons that they prepared for children and that were developed in groups of 4/5 students.

MAIN FINDINGS AND DISCUSSION OF PROSPECTIVE TEACHERS’ ERRORS AND STRATEGIES

Problems	Right solution	Wrong solution	Strategy used for right solution	Strategy used for wrong solution
Additive relation $Y = k+x$	42%	58%	They did a schema or they calculate	100% of the mistakes are due to use of the rule of three
Direct proportion (missing value) $Y = kx$	100%	_____	74% calculate the price of the unit and then multiply. 26%used the rule of three	_____
Inverse proportion $Y = \frac{k}{x}$	58%	42%	They used a scalar factor, multiply one variable by the scalar and divide the other by the same scalar	75% used the rule of three 25% used a wrong schema

Table 1. Percentages of right and wrong answers and Strategies used (N=19)

First Task: The above table shows the errors and the strategies followed by students.

Second Task: The following table resumes the errors and the strategies followed by students. Remember that in this task the prospective teachers are asked not to use any rule to solve the problems and they were also asked to explain the procedure.

Problems	Right solution	Wrong solution	Strategy used for right solution	Strategy used for wrong solution
Additive relation	100%	_____	They did a schema	
Direct proportion Missing value task (<i>Mr Short and Mr Tall problem, Hart, 1984</i>)	74%	26%	50% use the unit rate strategy, 50%use the scalar (“within”) strategy	100% of mistakes are due to an additive reasoning
Direct proportion Comparison task (4 quantities are known) “ <i>In a table 10 children share 6 pizzas, in another table 8 children share 5 pizzas. In what table each children eats more pizza?</i> ”	68%	32%	46% calculate the amount of pizza for each child and then compare the ratios. 54%used an iconic representation.	67% of mistakes are due to an error of calculation of the ratio 33% of mistakes are due to an additive reasoning
Inverse proportion <i>12 workers open a trench, in 5 days, how many days did 3 workers need, if they did the samework in the same time.</i>	79%	21%	All used a scalar factor, multiply one variable by the scalar and divide the other by the same scalar	75% of the mistakes are due to an incorrect use of the scalar factor, they used it as a direct proportion 25% use the additive reasoning

Table 2. Percentages of right and wrong answers and Strategies used (N=19)

In first task, only seven prospective teachers did all the three problems in a right way. Two students always used the rule of three in all the situations, and another two made the mistake of using the rule of three in both first and third problem but they did not use it in the second, when it was indeed the right procedure, preferring the unit rate strategy instead. These findings seem to show that when students try to solve a problem with three known values and a fourth one unknown (a missing value problem), they choose the rule of three. During the discussion of the students strategies, most of them stated that in junior and secondary school they always followed the procedure of the rule of three. “Even in Physics I remember using this rule to solve a lot of problems” state one student. The second task followed immediately the first task, without any discussion in the class. In this task a greater number of students gave a right answer, however five students (26%) used an additive reasoning in the missing value problem of direct proportionality. Ten students solved all the four problems in a right way, and one student did all of them in a wrong way. They used more schemas now than in the first task. It is interesting to note that in the direct proportion problem of the first task everybody had the right

solution (most of them using the unit rate), and in the second task 32% failed. Perhaps this is due to the kind of problem (the first asked to know the price of 24 balloons knowing the price of three), the second asked to know how many paperclips were needed for Mr. Tall's height, knowing both Mr. Short's height in paperclips and matchsticks and Mr. Tall's height in matchsticks. During the group and plenary discussion of the reflection phase the students referred that they never did proportional problems without using a rule. They also stated that when they studied functions in the secondary school, they had studied the function $Y = K/X$ as well as the linear function, but always without perceived that they could be related to concrete problems like those of these tasks.

The analysis of the plans of lessons which they developed in the context of the transferring phase of the course, shows that prospective teachers were very aware of the possible errors of their future pupils. Most of them chose to begin by letting them to solve problems by using informal strategies, after exploring the scalar factor within the variables and the unit rate. They also created tasks to compare situations of proportionality and others, and at last the comparison between two quantities of a same discrete set. As the official curriculum explicitly focus the algorithms and rules they thought that they should teach also these aspects. So they dedicated one lesson to the rules and practice exercises.

General comments of the course: the strategy followed during this course has provided knowledge about some misunderstandings that prospective elementary mathematics teachers have with ratio and proportion concepts. The course had as a start point the self-awareness of these misunderstandings and a shared reflection about them, as well as the study of the mathematics content underlying these subjects. The elaboration of the lessons will be very useful during the pedagogical practice in real classroom inasmuch as it will provide an evaluation and a reflection about the lessons implementation, which will be developed later on.

Note: The work described in this paper is part of a project named "Teachers and New Competencies on Primary Mathematics", funded by Fundação para a Ciência e Tecnologia, Portugal.

References

- Ball, D. L., Lubienski, Mewborn, D. S., (2001). Research on Teaching Mathematics: The Unsolved Problem of Teachers' Mathematical Knowledge. Handbook of Research on Teaching. New York. Virginia Richardson.
- Behr, M.J., Khoury, H.A., Harel, G., Post, T., Leshm L., (1997). Conceptual Units Analysis of preservice Elementary School Teacher' Strategies on Rational-Number-as-Operator Task. In *Journal for Research in Mathematics Education*, Vol 28 n°1, pp48-69.
- Cramer, K., Post, T. & Currier, S. (1993). Learning and Teaching Ratio and Proportion: Research Implications. In D.T: Owens (Eds.) *Research Ideas for the Classroom Middle Grade Mathematics*. New York: Macmillan. pp.159-178.
- Cramer, K., Post, T. & Behr, M. (1988). In J: Hiebert & M.Behr (Eds), *Number Concepts and Operations in the middle Grades*. Reston, Va: NCTM
- Dewey, J. (1938). Experience and Education. Collier Macmillan Publishers. N:Y:
- Hart, K. (1984). Ratio: Children Strategies and Errors. London: NFER- NELSON.

- Hart, K. (1988). Ratio and proportion. In J. Hiebert & M. Beher (Eds), *Number Concepts and Operations in the middle Grades*. Reston, Va: NCTM
- Kieren, T. Personal Knowledge of Rational Numbers: Its Intuitive and Formal Development. In J. Hiebert & M. Beher (Eds), *Number Concepts and Operations in the middle Grades*. Reston, Va: NCTM.
- Monteiro, C. (2002)- A Formação para o Ensino da Matemática na Perspectiva da ESE de Lisboa. In Lurdes Serrazina (org,) *A Formação Para o Ensino da Matemática na Educação Pré-Escolar e no 1º Ciclo do Ensino Básico.* Inafop. Porto
- Vergnaud, G. (1988). Multiplicative Structures. In J. Hiebert & M. Beher (Eds), *Number Concepts and Operations in the middle Grades*. Reston, Va: NCTM.
- Zeichner, K. (1993). A formação reflexiva de professores. Ideias e práticas. Lisboa: Ed.
- National Council of Teachers of Mathematics (2001). Curriculum and Evaluation Standards for School Mathematics. Reston, Va.
- National Council of Teachers of Mathematics (1989). Professional Standards for Teaching Mathematics. Reston, Va.
- Wood, T., Cobb, P., Yackel, E., (1991). Change in Teaching Mathematics: A Case study. *American Educational Research Journal* Fall 1991, Vo.28. N°3, pp 587-616.

•

Page Intentionally Left Blank

WHAT COUNTS AS MATHEMATICAL DISCOURSE?

Judit Moschkovich

University of California, Santa Cruz

In this paper I use situated and socio-cultural perspective (Gee, 1996 & 1999) to examine descriptions of mathematical discourse and an example of student talk in a mathematics classroom. Using this example, I discuss how the distinction between everyday and mathematical discourse can help or hinder us in hearing the mathematical content in student talk.

The distinction between everyday and mathematical discourses can be useful for describing mathematics learning as moving from everyday to more mathematical ways of talking. However, this distinction has limited uses in the classroom. First, it is difficult to use this distinction to categorize student talk since it is not always possible to tell whether a student's competence in communicating mathematically originates in their everyday or school experience. And, while learning mathematics certainly involves learning to use more mathematical language, everyday discourse practices should not be seen only as obstacles to learning mathematics. During mathematical discussions students use multiple resources from student experiences both outside and inside school. Before we label student talk as everyday or mathematical, we need to seriously consider what we include or exclude in our definition of mathematical discourse practices. If we assume that mathematical discourse consists only of textbook definitions or those practices that mathematicians use in formal settings, we may miss the mathematical competence in student talk.

We can begin to characterize mathematical discourse using the mathematics register, as defined by Halliday (1978):

A register is a set of meanings that is appropriate to a particular function of language, together with the words and structures which express these meanings. We can refer to the "mathematics register," in the sense of the meanings that belong to the language of mathematics (the mathematical use of natural language, that is: not mathematics itself), and that a language must express if it is being used for mathematical purposes. (p. 195)

Halliday is not referring to technical vocabulary but to meanings, styles, and modes of argument: "We should not think of a mathematical register as consisting solely of terminology, or of the development of a register as simply a process of adding new words." (p. 195)

Forman (1996) describes some of the characteristics of mathematical discourse as its syntax and impersonal nature (sentences without subject or using the impersonal "you" as subject). She also describes the particular modes of argument valued in mathematical discourse: precision, brevity, and logical coherence. Research in mathematics classrooms has provided empirical evidence that learning mathematics includes sorting out multiple meanings between these two registers (Pimm 1987, Khisty, 1995; Moschkovich, 1996). This research has focused on the differences between the everyday and mathematical registers. Since there are multiple meanings for the same term or phrase, as students learn mathematics they are learning to use these multiple meanings appropriately. Several examples of such multiple meanings have been described. For example, the word "set"

and the phrase "any number" (meaning "all numbers") have different meanings in a mathematical context (Pimm, 1987).

These multiple meanings can create obstacles in mathematical conversations because students often use the colloquial meanings of terms, while teachers (or other students) may use the mathematical meaning of terms. Another difference between the everyday and the school mathematics registers is the meaning of relational terms such as "steeper" and "less steep" and phrases such as "moves up the y-axis" and "moves down the y-axis." Meanings for these terms and phrases that may be sufficiently precise for everyday purposes may prove to be ambiguous for describing lines in the context of a mathematical discussion (Moschkovich, 1996).

Learning mathematics involves, in part, a shift from everyday to a more mathematical and precise use of language. Studies have described how students' language can move closer to the mathematics register, becoming more precise and reflecting more conceptual knowledge. For example, students develop more restricted meanings for everyday terms (O'Connor, 1992) and refine the uses of everyday meanings so that they reflect more conceptual knowledge (Moschkovich, 1996, 1998).

Learning the mathematical meanings of words describes one important aspect of learning mathematics. Contrasting everyday meanings with the more restricted meanings of the mathematics register points to these multiple meanings as possible sources of misunderstandings in classroom discussions. However, the relationship between the everyday and the mathematics registers and communication in the classroom is more complex. First, mathematical discourse involves more than word meanings. Second, everyday meanings are not only obstacles but also resources for developing mathematical competence. And lastly, as Forman (1996) points out, in the classroom everyday and mathematical discourses are not separate but interwoven in discussions.

Forman (1998) and Wertsch (1990) suggest moving from individual word meaning to more general discursive practices to "identify the forms of speech or discourse characteristic of particular sociocultural settings" (Wertsch, 1990). This shift can broaden the characterization of mathematical communication beyond the use of particular words and their meanings. We can begin by using a definition of discourse as more than speech or writing. Gee (1996) defines Discourses as:

A Discourse is a socially accepted association among ways of using language, other symbolic expressions, and 'artifacts', of thinking, feeling, believing, valuing and acting that can be used to identify oneself as a member of a socially meaningful group or 'social network', or to signal (that one is playing) a socially meaningful role." (p. 131)

Mathematical Discourse includes not only ways of talking, acting, interacting, thinking, believing, reading, writing but also mathematical values, beliefs, and points of view. Participating in mathematical discourse practices can be understood in general as talking and acting in the ways that mathematically competent people talk and act when talking about mathematics. Gee's (1996) example of a biker bar illustrates the ways that any Discourse practice involves more than technical language. In order to look and act like one belongs in a biker bar, one has to learn much more than a vocabulary. While knowing the names of motorcycle parts or models may be helpful, it is clearly not enough. In the

same way, knowing a list of technical mathematical terms is not sufficient for participating in mathematical Discourse.

Are there some general characteristics of mathematical Discourse? Being precise and explicit, searching for certainty, abstracting, and generalizing are highly valued practices in mathematically oriented Discourse communities. Generalizing is exemplified by common mathematical statements such as “the angles of any triangle add up to 180 degrees,” “parallel lines never meet,” or “ $a + b$ will always equal $b + a$.” While generalizing is a valued practice, it is also important to make claims that are applicable only to a precisely and explicitly defined set of situations. For example, the statement “multiplication makes a number bigger” can be true or false depending on the set of numbers the claim refers to: “Multiplication makes a number bigger except when multiplying by a number smaller than 1.”

Many times claims are also tied to mathematical representations such as graphs, tables, or diagrams. Although less often considered, imagining is also a valued mathematical practice. For example, mathematical work often involves talking and writing about imagined things--such as infinity, zero, infinite lines, or lines that never meet--as well as visualizing shapes, objects, and relationships that may not exist in front of our eyes.

Mathematical Discourse, however, is not a single set of homogeneous practices. Although we might agree that mathematical Discourse is reasoned discourse (Hoyrup, 1994), it varies across individuals, communities, time, settings, and purposes. Current inquiry into the practices of mathematicians’ concludes that there is not one mathematics, one way of understanding mathematics, one way of thinking about mathematics, or one way of working in mathematics (Burton, 1999):

Out of the interviews with research mathematicians, I have a clear image of how impossible it is to speak about mathematics as if it is one thing, mathematical practices as if they are uniform and mathematicians as if they are discrete from both of these. (p. 141)

How do mathematical Discourse practices vary socially, culturally, and historically? Mathematical Discourse varies across different communities, for example research mathematicians and statisticians, or between elementary and secondary school teachers. Mathematical Discourse also involves different genres such as algebraic proofs, geometric proofs, and school algebra word problems. Mathematical arguments can be presented for different purposes such as convincing, summarizing, or explaining.

Mathematical Discourse is also historically situated. For example, mathematical arguments have changed over time (Hoyrup, 1994):

What was a good argument in the scientific environment of Euclid was no longer so to Hilbert; and what was nothing but heuristic to Archimedes became good and sufficient reasoning in the mathematics of infinitesimals of the seventeenth and eighteenth centuries. (p. 3)

Even mathematical definitions have changed over time. For example, the definition of a function has changed throughout history from the Dirichlet definition as a relation between real numbers to the Bourbaki definition as a mapping between two sets. Mathematical definitions can also differ across cultural contexts. For example, in Spanish

“the word trapezoid is reserved for the quadrilateral without any parallel sides, whereas trapezium is used when there is one pair of parallel sides. This is the opposite of American English usage.” (Hirigoyen, 1997).

Mathematical Discourse practices also vary depending on purposes. Richards (1991) describes four types of mathematical discourse. Research math is the spoken mathematics of the professional mathematician and scientist. Inquiry math is mathematics as used by mathematically literate adults. Journal math emphasizes formal communication and is the language of mathematical publications and papers. This type of mathematical discourse is seen as different from the oral discussions of the research community because written formal texts reconstruct the story of mathematical discoveries. Lastly, he defines school math as the discourse typical in the traditional math classroom, sharing with other classrooms the initiation-reply-evaluation structures of other school lessons (Mehan, 1979). Richards points out that school math has more in common with journal math than with research or inquiry math.

HEARING THE MATHEMATICAL CONTENT IN STUDENT TALK

Moving from individual word meaning to discursive practices complicates the distinction between everyday and mathematical Discourses. We may be able to identify whether a student is using the everyday or mathematical meaning for words such as prime, set, function, or steeper. However, it is more difficult to separate Discourse practices as belonging to one setting or another, and it may be impossible to identify the origins of Discourse practices that students use in the classroom. Students combine resources from multiple Discourse practices. Students use resources from both everyday and mathematical Discourses to communicate mathematically. As analysts or teachers, we cannot decide whether student talk reflects or originates in everyday or mathematical Discourse. It is also a challenge to hear not only one acceptable version of mathematical communication, but also multiple authentic mathematical Discourse practices

The example below illustrates how our views of authentic mathematical practices influence whether we hear students as participating in mathematical Discourse or not. The excerpt comes from a lesson in a third grade bilingual classroom in an urban California school. The students have been working on a unit on two-dimensional geometric figures. For several weeks, instruction has included technical vocabulary such as the names of different quadrilaterals. Students have been talking about shapes and have also been asked to point, touch and identify different instances. In this lesson, students were describing quadrilaterals as they folded and cut paper to form tangram pieces.

Towards the end of his lesson, there was a whole-class discussion of whether a trapezoid is or is not a parallelogram. The teacher had posed the following question:

Teacher: What do we know about a trapezoid. Is this a parallelogram, or not? I want you to take a minute, and I want you at your tables, right at your tables I want you to talk with each other and tell me when I call on you, tell me what your group decided. Is this a parallelogram or not.

After the students had discuss this question in their groups, the following whole-class discussion ensued:

Teacher: ((To the whole class)) OK. Raise your hand. I want one of the groups to tell us what they do think. Is this ((holding up a trapezoid)) a parallelogram or not, and tell us why. I'm going to take this group right here.

Vincent: These two sides will never meet, but these two will.

Teacher: How many agree with that. So, is this a parallelogram or not?

Students: Half.

Teacher: OK. If it is half, it is, or it isn't?

Students: Is.

Teacher: Can we have a half of a parallelogram?

Students: Yes.

Teacher: Yes, but then, could we call it a parallelogram?

Students: Yes.

The standard definition of a trapezoid is “a quadrilateral with one pair of parallel sides” and the standard definition of a parallelogram is “a quadrilateral with two pairs of parallel sides.” The students’ response to the question “Is this a parallelogram or not?” was “Half”, implying that a trapezoid is half of a parallelogram.

First, let us consider how “a trapezoid is half a parallelogram” might be a reasonable response to the question. A parallelogram has two pairs of parallel sides and a trapezoid has one pair of parallel sides. A trapezoid can be seen as a half of a parallelogram because a trapezoid has half as many pairs of parallel sides as a parallelogram.

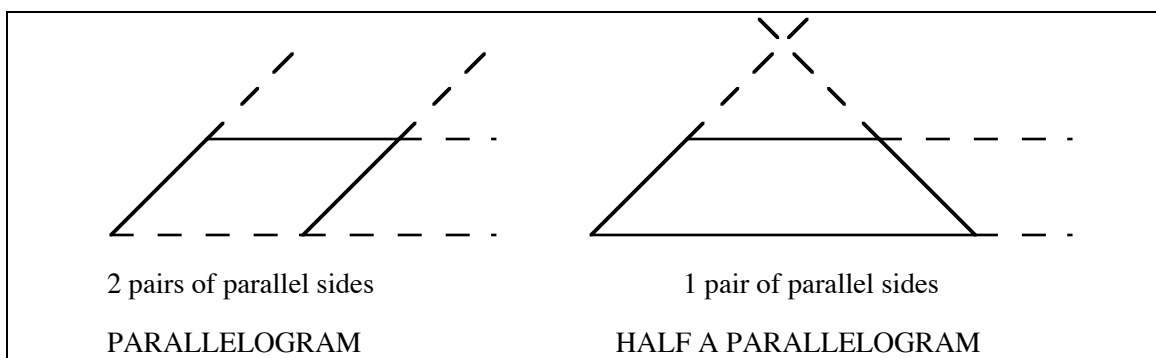

Figure 1: A trapezoid is half a parallelogram

How do the teacher’s and the students’ definitions compare? Students were focusing on whether and how these two figures possess the property of having pairs of parallel lines. The teacher was focusing on whether the figures belong to one of two *categories*: “figures with two pairs of parallel lines” or “figures with one or no pair of parallel lines.”

While for the students “half a parallelogram” was an acceptable specification, this was not acceptable to the teacher. The teacher’s initial question “Is this a parallelogram or not, and tell us why?” assumed that this was an either/or situation. The teacher’s point of

view was dichotomous: a given figure either is or is not a parallelogram. The teacher was using a formal dictionary definition of parallelogram. This definition is clearly binary: either this figure is a parallelogram or it is not a parallelogram. From this point of view, “half a parallelogram” is not an acceptable definition for a trapezoid.

We might conclude that because the teacher was using a dictionary definition, the teacher’s point of view reflects mathematical Discourse practices. We might also conclude that because the students are not using a formal definition, their point of view reflects everyday Discourse practices. But there is another way to consider these two different points of view.

Does one definition necessarily reflect more or less authentic mathematical Discourse practices than the other one? That depends on how we define authentic mathematical practices. If using dictionary definitions is the only practice we imagine that mathematicians participate in, then the teacher’s definition of a trapezoid is the only mathematical definition in this discussion. Instead, if we include “developing working definitions” as an authentic mathematical practice, then the students’ definition is also mathematical.

O’Connor (1998) discusses different types of definitions. She includes stipulative, working, dictionary, and formal as different categories of mathematical definitions. Stipulative and working definitions are developed as part of an interaction or an exploratory activity; dictionary and formal are given by a text. Constructing shared definitions “is a signal example of what we mean by authentic intellectual practices of mathematics and science” (p. 42.)

From this view of mathematical practices, using dictionary definitions is not the only authentic mathematical practice and using formal definitions is not the only way to participate in mathematical Discourse practices. The definition students used can be described as a working and stipulative definition. These students are actually participating in an activity that may be closer to the practice of scientists and mathematicians than to school practices of using only dictionary definitions.

CONCLUSIONS

The example above points to the complexity of mathematical communication in the classroom. Whether or not student talk sounds mathematical depends on how we understand the distinction between everyday and mathematical Discourses. There are many authentic mathematical Discourse practices. As analysts and teachers we should not confuse “mathematical” definitions with “textbook” definitions; we should clarify the differences between mathematical ways of talking and formal ways of talking mathematically. We should remember that Mathematical Discourse practices are varied.

Notes

This work was supported in part by a grant from NSF (REC-9896129 and REC-0096065).

References

- Burton, L. (1999). The practices of mathematicians: What do they tell us about coming to know mathematics? *Educational Studies in Mathematics*, 37: 121-143.
- Forman, E. (1996). Learning mathematics as participation in classroom practice: Implications of sociocultural theory for educational reform. In L. Steffe, P. Nesher, P. Cobb, G. Goldin, and B. Greer (Eds.) *Theories of mathematical learning* (pp. 115-130). Mahwah, NJ: Lawrence Erlbaum Associates.
- Forman, E., McCormick, D., & Donato, R. (1998). Learning what counts as a mathematical explanation. *Linguistics and Education*, 9(4), 313-339.
- Gee, J. (1996) *Social Linguistics and Literacies: Ideology in Discourses*, Second Edition. London, Taylor & Francis.
- Gee, J. (1999). *An Introduction to Discourse Analysis: Theory and Method*. NY: Routledge.
- Halliday, M. A. K. (1978). Sociolinguistics aspects of mathematical education. In M. Halliday, *The social interpretation of language and meaning*, (pp. 194-204). London: University Park Press.
- Hirigoyen, H. (1997). Dialectical variations in the language of mathematics: a source of multicultural experiences. In Trentacosta, J. and Kenney, M. J. (Eds), *Multicultural and Gender Equity in the Mathematics Classroom: The Gift of Diversity-1997 Yearbook*, Reston, VA, National Council of Teachers of Mathematics, pp. 164-168.
- Høyrup, J. (1994). *In measure, number, and weight: Studies in mathematics and culture*. Albany: SUNY.
- Khisty, L. L. (1995). Making inequality: Issues of language and meanings in mathematics teaching with Hispanic students. In W. G. Secada, E. Fennema, & L. B. Adajian (Eds.), *New directions for equity in mathematics education* (pp. 279-297). New York: Cambridge University Press.
- Mehan, H. (1979). *Learning lessons: Social organization in the classroom*. Cambridge, MA: Harvard University Press.
- Moschkovich, J. N. (1996). Moving up and getting steeper: Negotiating shared descriptions of linear graphs. *The Journal of the Learning Sciences*, 5(3), 239-277.
- Moschkovich, J. N. (1998). Resources for refining conceptions: Case studies in the domain of linear functions. *The Journal of the Learning Sciences*, 7(2), 209-237.
- Moschkovich, J. N. (1999). Supporting the participation of English language learners in mathematical discussions. *For the Learning of Mathematics*, 19(1), 11-19.
- O'Connor, M.C. (1998). Language socialization in the mathematics classroom.
- O'Connor, M. C. (1992). Negotiated defining: The case of length and width. Unpublished manuscript, Boston University.
- Pimm, D. (1987). *Speaking mathematically: Communication in mathematics classrooms*. London: Routledge.
- Richards, J. (1991). Mathematical discussions. In E. von Glasersfeld (Ed.), *Radical constructivism in mathematics education* (pp. 13-51). The Netherlands: Kluwer.

•

Page Intentionally Left Blank

MATHEMATICAL AND PEDAGOGICAL UNDERSTANDING AS SITUATED COGNITION

Judith A Mousley

Deakin University

One mathematics lesson was planned by two Grade 2 teachers together. Their separate teaching of it was videotaped, and each teacher was interviewed before and after her lesson. The “same” lesson resulted in different sets of worthwhile learning outcomes. In this research report, the notion of situated cognition is used as a tool for analysis of how this divergence seemed to happen. It is argued that the teachers’ development and uses of mathematical concepts were mediated by the social situations.

CONTEXTS OF ACTIVITY

Vygotsky’s seminal work focused on how social activity mediates cognitive development. In socio-cultural theories that draw on this work, understanding is portrayed as developing through interpersonal activity. One of these approaches, situated cognition, focuses attention on the influence of specific contexts (see, for example, Lave, 1988, 1993, 1996; Lave and Wenger, 1991; and Wertsch, 1991, 1995). “Contexts”, here, include unique personal interests, perspectives, interpretations and purposes of participants as much of the general nature of social locations and interactions (Cobb, 1990). They incorporate social settings, which are “repeatedly experienced, personally ordered and edited” (Lave, 1988, p. 151). Any social interaction is shaped and constrained by the features and norms of the particular context in which it evolves; so action takes place not merely *in* or *on* an environment, but *with* it. This is not a one-way influence because participants in any social activity bring to it their own sets of socially mediated attitudes, beliefs, experiences, and goals. The distribution of cognition thus depends on situated affordances (Salomon, 1993).

In this paper, I analyse how this complexity seemed to be played out when the “same” mathematics lesson was taught by two Year 2 teachers. My focus is on teachers’ cognition, rather than that of the children, although these are clearly interrelated.

THE RESEARCH CONTEXT AND METHODS

The data are drawn from a case study of four experienced primary teachers who planned their lessons for Grade 6 and Grade 2 in year-level pairs. The general aim of the project was to analyse what teachers do to develop children’s mathematical understanding. Case study, an epistemology of the particular (Stake, 1994), was considered appropriate for this research because it allows us to look beyond human behaviour in order to focus on meaning as it is developed and used in individual contexts. The focus of the project was mainly on the teachers’ understandings of their work. The fact that the “same content” was taught in two classrooms provided an opportunity to compare and contrast the finer elements of school contexts in which mathematics cognition develops.

The data were collected in one primary school over a period of four months. Mathematics lessons taught by each teacher (or each pair when they team taught) were videotaped for about one month. The teachers were interviewed before and after their lessons. The

audiotapes of the interviews and the videotapes were digitized and compressed. This footage was reviewed for episodes that illustrated specific foci of the project: activity, children's thinking, discourse, and assessment. Parts of the interaction were transcribed.

Some of the lessons were then selected for a closer analysis using the theory of situated cognition. It is one of these lessons, taught by "Ruth" and "Trina" that I report on here. These two Grade 2 teachers planned many of their lessons together.

RUTH'S LESSON

On the day previous to this particular lesson, Ruth and Trina (together) had asked me about possible meanings of a topic that was included in the school curriculum outline, because, as Ruth claimed, they had "never known what it means". The topic listed was "Rotational symmetry", and I could not think of any traditional Year 2 curriculum content that would be given that name. Ruth had already asked a Grade 6 teacher, Rob, and reported to Trina and myself that, "Rob said it's order by rotation or something". That comment was helpful for me, and I demonstrated what order of rotation means, saying that the word "symmetry" would be appropriate because images are repeated as some shapes are turned. Ruth thanked me and said, "We'll work something out anyway". Later that day, after I had left the school, the teachers planned their lesson together.

In the pre-lesson interview the next day, Ruth said that they had decided to have the children paste colored sectors inside circles drawn on art paper "to make a rotating pattern". They had found this activity in a teachers' resource book. They had decided "not to worry about the symmetry bit", said Ruth.

Ruth's lesson started with the children sitting on the floor. The meanings of the words "pattern" and "tessellating" were recalled from previous lessons. Ruth then said that they were going to make a tessellating pattern "to go around in a circle". She produced cut out colored sectors of circles, and there was some discussion about what they might be called but no specific name was given to the shape. Ruth illustrated how the sectors were to be pasted onto a piece of white paper to make a circle, and stressed the need to "put them in order to make a pattern". She then turned her pattern around and around, saying "It's round, so we can rotate it, like a wheel. It's a rotational pattern. We are going to make *rotational* patterns". The children were then directed to "Choose either two or four colors", with no explanation of why, to move to their tables, to make their "rotational patterns", and then to cut around their "circles". (This latter direction was repeated later.)

As their patterns were completed, Ruth introduced individual children to the notion of "quarter turn" and "half turn". She realised that the degree of turn was hard for them to see, given that the cut-out patterns were circular and each had more than one sector of the same color, so she encouraged them to write a figure 1 on their "first bit" and to think of that as the "top of the circle". Towards the end of the lesson, Ruth started to lead the children to see that use of two colors would mean that the pattern would look the same at each quarter turn; but use of four colors would require a half turn for this to happen. While videotaping the lesson I thought that this latter perceptual development had been planned, but after reviewing the videotape I realised that Ruth had come to understand this only as she was teaching the lesson. (I later asked her, and she agreed that this was the case.) One section of the videotape shows an unsuccessful attempt to help a child

solve a problem. The girl had used two colors, but in the order BGGBGG. She could not continue the pattern to complete the circle. Over the next few minutes Ruth looked at other children's patterns, listened reflectively to their discussions, physically turned and read out some of the patterns herself, and gradually started to talk with children about whether and when their images "look the same". She then went back to the girl to suggest making "a pattern ... like two lots of four or four lots of two. The girl understood what she meant and changed her pattern to BBGGBBGG, then showed Ruth and commented that it was "twos as well as fours". Ruth agreed and then asked the girl to turn her circle half way round to see if it looked the same "upside down", and then to use quarter turns.

By the time that the children had been called back to the floor to show and describe their work, Ruth seemed to have a clear understanding of the notion of order of rotation. This information was offered to them, employing a subtle shift from the idea of patterns forming a circle to the idea of the image being repeated several times as a circle is turned.

- Ruth: Put up your hand if you think Lewis' is a rotational pattern. (Many hands were raised.) How do you know, Nick?
- Nick It fits in the circle.
- Ruth: (Nodded.) What's rotational mean? What does rotate mean? (Some children's hands were raised. Ruth drew a circle in the air with her hand.) If something rotates, what can it do? If something can rotate ... (Drew another circle in the air. More hands raised.) Can you make your picture rotate, please Lewis? (Lewis hesitated.)
- Jamie Lee I can. (Turned her circle with four distinct quarter turns.)
- Ruth: Oh, you can! (Nodded, smiled. Lewis copied the action, turning his own picture around.) Good, Lewis. (Other children also turned theirs.) Is it the same pattern, then, as he turns it? ... Can you see the same pattern repeating? (Lots of nods.) Good.

As I interviewed Ruth after the first lesson, Trina listened to her describe what had happened. Ruth illustrated the order of rotation principle using two examples of children's work. In her description, there was a lot of emphasis on "turning the circles" and observing when they "looked the same". (At this stage I was still under the impression that this had been the intended learning outcome.) Ruth stressed the need for children to put a one on the first piece "so they can tell where the pattern starts". Ruth said that she was going to "do more on rotational patterns" in her next lesson.

For the following lesson, Ruth had the children color in four circles (marked into eights on photocopied sheets) to record what the patterns that they had made the previous day looked like after each of four quarter turns. The last part of the lesson was whole-class discussion about when two-color patterns looked the same (after each quarter turn) and when four-color pattern did (after each half turn). Some children spontaneously noted that the first and third circles always looked the same and the second and fourth did too, and a child that Ruth asked was able to talk about why this was the case. One girl said her record of the four turns was "a special one because all of the pictures [are] the same". She was also able to explain why: "There's four lots of black and white, and black is always on the top because it starts each quarter". Not all of the children would have understood these explanations, but from their fiddling with their own patterns while waiting for their turns and their responses to Ruth's questions it seemed that many had grasped the idea..

TRINA'S LESSON

Trina had planned the first lesson with Ruth, and she used the same materials to teach it to her own class. There was much more discussion than in Ruth's lesson about what the shapes are called, and specifically about why they are called "eighths". The idea of turning the "circle pattern" was introduced quickly, and the children were told to "put a number one where the pattern starts"—a direction that was repeated several times later. The children then lined up to chose "eight eighths, and only two or four colors".

- Trina (Apparently filling in time usefully for the children waiting in line to collect their sectors.) I wonder how many pieces you all need to make the circle.
- Jay It depends on how many colors you're getting.
- Jessica Eight.
- Trina (Nodded, smiled.) You'll need eight pieces. Good girl. Eight pieces to make your pattern. Eight eighths.
- Jessica If you have four colors you need two halves, two lots; and if you use two pieces you need four.
- Trina Mm, right. (Paused.) What did you say? You want two pieces ...
- Jessica If you have four colors you need two lots; and two colors need four lots.
- Trina Ah, right. Very good. You need eight all together.
- (and later)
- Trina (Filling in more time because children were still waiting for others to collect their pieces.) I want you to have a think about why they need two or four.
- Jessica I know.
- Trina Ahha! Jessica?
- Jessica If you use four it repeats twice, half, and if you use two it repeats four times, quarters. (...) If you had three you'd fill up three and then six and then you could not fit in three more.
- Trina Right. So you wouldn't really have a repeating pattern, would you?

As they finished the pasting activity, Trina asked each child to read out the pattern. She asked a few to "turn the circle around and read it again", but this seemed to be essentially a describing exercise with a focus on repetition of the pattern of colors around the circle.

- Trina What's your pattern?
- Child 1 Red, blue.
- Trina Good boy. Red blue. (Pointed to shapes.) Red, blue, red, blue, red, blue, red, blue. Easy, yes. (Attended to next child in the queue) What's your pattern?
- Child 2 Orange, yellow, red, blue, orange, yellow, red, blue.
- Trina You're going this way? Orange, yellow, red, blue. Excellent! (To next child) You tell me your pattern.
- Child 3 Red, green, red, green, red, green, red, green.
- Trina Okay. (Rotated child's circle several times as she spoke.) So if I turn it around any old way, it should still be red, green, red, green, red, green? (Child nodded and smiled.) Okay! Good!

Trina did not ask any questions about when quarter or half turns were needed to make the pattern look the same. However, there was a lot of talk about their "eights". In the post-lesson interview, Trina later told Ruth and I that it was "a good lesson for fractions". She

commented that the idea of “eighths” was not in the Grade 2 curriculum, but since the children had “understood it very well” she had thought that she “may as well press on with it”.

COGNITION AS SITUATED IN SOCIAL ACTIVITY

A key principle developed by Vygotsky is one of unity between mental functioning and activity, with the development of the mind resulting from goal-oriented and socially determined interaction between human beings and their environments. It is interesting to use this idea as a tool to analyse how implementation of ostensibly the same lesson plan led to different mathematical outcomes (and potentiality) for the two sets of pupils.

The teachers seemed to start with similar expectations for the lesson, and their knowledge about rotational symmetry seemed similar before the lesson. Many objects of the context—including the school curriculum, a resource book and the teaching aids it suggested, specific words (“pattern”, “rotational”, “order”, etc.)—seemed to be used in common ways. Interactions with Rob (the colleague) and with me may have too, but again these were shared. Apparently it was the enacted curriculum in their classrooms that led to a divergence. It was this social activity that seemed to have the strongest bearing on what mathematical ideas were made available to the children.

Understandings and interpretations gradually emerge through interaction, distributed among the participants’ interactions rather than individually constructed or possessed; and because cognition is both created and distributed in a specific activity context, it is necessarily situated (Salomon, 1993). Activity contexts are necessarily complex. For example, part of Ruth’s classroom interaction was with a girl who had followed her instructions but could not make a pattern, leading to reflective activity and growth of understanding by the teacher. Her development here was dialogic, involving social and mental activity. Note, though, that Trina also had this prompt, in the form of a girl’s impromptu explanation of why six sectors would not work, but that she did not seem to engage with it. Perhaps because it was not a problem for the child Trina was not put into a position where it became an “epistemological obstacle” (Sierpinska, 1994) that she had to engage with.

A further part of Ruth’s cognitive development was engagement with the idea of symmetry, even though she did not think of it this way. As Wertsch (1985) pointed out, the inner word extends the boundaries of its own meaning. Ruth employed her new understanding of order of rotation in ways that set up a context where the children were expected to grasp the same idea. Clearly some did, and so this cognition became somewhat distributed.

A concept ... will continually evolve with each new occasion of use, because new situations, negotiations, and activities inevitably recast it in new, more densely textured forms. So a concept, like the meaning of a word, is always under construction. (Brown, Collins & Duguid, 1989p.133)

It is useful to reflect on why neither of the teachers saw repeated patterns as anything to do with symmetry. Even a child’s comment to Ruth that “the same colors are opposite each other in all the patterns” did not provoke perturbation here. Sierpinska (1994) describes understanding as overcoming conceptual “epistemological obstacles”.

Students' thinking appeared to suffer from certain "epistemological obstacles" that had to be overcome if a new concept was to be developed. These "epistemological obstacles"—ways of understanding based on some unconscious, culturally acquired schemes of thought and unquestioned beliefs ... marked the development of a concept in history, and remained somehow 'implicated' ... in its meaning. (p.131)

It seems that the teachers' conceptualisation of "symmetry" was bound by their experience. The common notion of symmetry being reflection around an axis probably constrained their understanding of Rob's and my brief explanations of another form of symmetry. Higher-level aspects of symmetry such as "correspondence" and "congruity" are rarely articulated outside of secondary and tertiary mathematics classrooms, especially in relation to "symmetry". Perhaps a textbook exposition, or an immediate and confident explanation from me would have helped give the term new meaning for the teachers, but in actuality these were not elements of the context. Rob's explanation was drawn on in part, though, with the words "order" and "rotation" being used as a basis for their finding an appropriate activity in a textbook. In fact, it is not hard to see how the mathematical understandings of each of the participants in the unfolding scenario above (including my own) could be viewed as parts of a mutually constructed whole. It is also possible to see this whole as being made up of diverging, converging and interdependent learning trajectories.

Activity in the classroom situations served to raise some knowledge to a level of consciousness. For example, I would not have thought about "order of rotation" unless Ruth had misquoted Rob's interpretation of this term. Then Ruth's interpretation of my resulting explanation seemed not to be taken up until social activity stimulated her to reflect on the patterns that her pupils were making. Did Rob's and my "mentoring" roles on the previous day move Ruth's understanding enough to set up a zone of proximal development? This development certainly evokes Newman, Griffin and Cole (1989) discussion of a process whereby meaning is negotiated through groups of participants seeking "common ground of comprehension and understanding" (p.131), and then progressing from that point. This involves trying to discover what the other has in mind and adapting the direction of interaction accordingly, operating in what Newman, Griffin and Cole called "the construction zone" (p.131).

The social and person were inextricably interwoven. Without the contributions of others, the struggle to understand others, reflection on what had been said and observed, then translation of this into further activity and the resulting understandings of the teachers, students and researcher would not have eventuated. Lerman (1996), discussing Vygotsky's work, pointed out that development of knowledge is something that takes place between people that is then internalised secondarily by individuals (p.137). Clearly, though, internalization sets up zones for contributions that people can make to further social learning. Ruth's realization about quarter and half turns was communicated after the lesson to Trina, but Trina focused on other aspects of the potential of the activity for teaching and learning. Thus the social distribution of knowledge here was not a "blanket" one, but a networking of activities, tools (including words and concepts), and that was mediated by individuals. The community members participating in the learning context developed as a group, but not as one mind. Their learning was distributed among co-participants rather than over it.

I was interesting to me to see how individual engagement, or not, with an idea led to essentially different learning situations. However, the activity itself had still set up in Trina's room an opportunity for children to notice the phenomenon of the patterns being related to quarter and half turns, and in fact Jessica had reasoned about it even before undertaking the activity. The video of Trina's lesson shows a few instances of children in this classroom saying to each other, "It's the same, it's the same", as they turned their circles and paused after quarter or half turns—actions that were not suggested or modeled by their teacher. These children were commenting on the same observation that Ruth had made. They had achieved this understanding as a result of interactions with peers and interactions with physical (and perhaps linguistic) objects. Mentoring for some of the children, here, resulted from their observation of peer activity. There was a feeling (as I wrote in my filed diary) that "we are making some kind of sense together". Thus the differences in the teachers' developments of the same lesson seemed to lead to different learning foci for their students—but not necessarily to different learning opportunities and outcomes for those children who were ready to learn from the activity itself.

CONCLUSION

The research project reported on here draws on case study methods and theories of situated cognition. Case study allows researchers to capture evidence of and synthesise dimensions of teaching theory as well as practice. For me, it provided a methodological approach for describing components of classroom interaction; but also allowed inquiry into the origins of these elements, the meanings that they seem to hold for the subjects of the research, and the ways teachers and children interact with tools and traditions of mathematics education. Similarly, literature on notions of situated cognition has provided powerful tools for analysis of the case data.

Lave (1988, 1993, 1996), and Lave and Wenger (1991) proposed that the development of cognition is an integral part of generative social practice in the lived-in world, so the development of knowledge and social interactivity are interdependent and indivisible (Lave and Wenger, 1991). A further key principle of situated cognition theories that this paper has utilised is that dynamic mutual activity between actors and their environments lead to changes in participants and contexts over time. It is clear that the teachers' and children's mathematical understandings (as well as potentialities for further development of these) were mediated by the social environments in which they were developing.

My description of this "one" lesson, taught by two teachers, and of the subsequent lessons has been necessarily brief here, but is sufficient to demonstrate how mathematical understanding seemed to exist not only amongst individuals acting together in a social context, but across the tools (including language, beliefs and customs) and artifacts that were used. There's an element of voluntary control over what was learned by the various participants, but this too, was seen as "a product of the instructional process itself" (Vygotsky, 1934/1987, p. 69).

References

- Brown, J.S., Collins, A., & Duguid, P. (1988). Situated cognition and the culture of learning. *Educational Researcher*, 18(1), 32–42.

- Cobb, P. (1990). Multiple perspectives. In L. Steffe, & T. Wood (Eds), *Transforming children's mathematics education: International Perspectives* (pp. 200–215). Hillsdale, NJ: Lawrence Erlbaum.
- Lave, J. (1993). The practice of learning. In S. Chailin, & J. Lave (Eds), *Understanding practice* (pp. 3–32). New York, NY: Routledge & Kegan Paul.
- Lave, J. (1996). *Teaching, as learning, in practice. Mind, Culture and Activity*, 3(3), 149–164.
- Lave, J. (1988). *Cognition in practice*. Cambridge: Cambridge University Press.
- Lave, J., & Wenger, E. (1991). *Situated Learning: Legitimate peripheral participation*. Cambridge, UK: Cambridge University Press.
- Lerman, S. (1996). Intersubjectivity in mathematics learning: A challenge to the radical constructivist paradigm? *Journal for Research in Mathematics Education*, 27(2), 137–150.
- Newman, D., Griffin, P., & Cole, M. (1989b). Series forward. In Newman, Griffin, & Cole, (Eds), *The construction zone: Working for cognitive change in school* (pp. vii–viii). Cambridge, UK: Cambridge University Press.
- Salomon, J. (1987). Social influences on the construction of pupils' understandings of science. *Studies in Science Education*, 14, 63–82.
- Salomon, G. (1993). Editor's introduction, in G. Salomon (Ed.). *Distributed cognitions: psychological and educational considerations*. Cambridge: Cambridge University Press.
- Sierpiska, A. (1994). *Understanding in mathematics*. London: The Falmer Press.
- Stake, R. E. (1994). Case studies. In N. Denzin & Y. Lincoln (Eds), *Handbook of qualitative research* (pp. 436–247). California: Sage Publications.
- Vygotsky, L. (1934/1987). *Thinking and speech*. In R.W. Rieber, & A.S. Carton (Eds), *The collected works of L. Vygotsky. Volume 1: Problems of general psychology* (Trans. N. Minick). New York: Plenum.
- Wertsch, J.V. (1985b). *Culture, communication and cognition: Vygotskian perspectives*. Cambridge: Cambridge University Press.
- Wertsch, J.V. (1991). *Voices of the mind: A sociocultural approach to mediated action*. Cambridge, MA: Harvard University Press.
- Wertsch, J. V. (1985). *Vygotsky and the social formation of mind*. Cambridge, MA: Harvard University Press.

THE RELATIVE INFLUENCE OF THE TEACHER IN THIRD GRADE MATHEMATICS CLASSROOMS

Hanlie Murray

University of Stellenbosch, South Africa

Whereas different studies have each emphasised the importance of different variables for productive mathematics learning, this study has found the teacher to be of major importance. In the 13 third grade classrooms of five different elementary schools students' feelings about mathematics and their performance in routine and novel problems were examined. No strong links could be found between levels of positive or negative feelings about mathematics and performance in routine or novel problems, and neither between gender and any of the other items. There were, however, major differences in some items among the different classes in the same school, indicating that the teacher plays a crucial role in matters such as students' feelings towards mathematics, performance in routine and novel problems, and the occurrence of systematic errors.

INTRODUCTION

In the past number of decades, much effort has gone into investigating the effects of different variables on students' mathematical learning, for example mathematics anxiety, gender, the teaching approach, the teachers' content knowledge, etc. However, some of the research studies produce seemingly conflicting results on the relative importance of the different variables.

For example, it is not only popular belief but also substantiated by a number of research studies that mathematics anxiety has a detrimental effect on students' mathematical performance, that problem solving is more sensitive to mathematics anxiety than routine computation, and that girls suffer more from mathematics anxiety (and are better at routine computations and worse at problem solving) than boys (e.g. Wood, 1988; Fennema, Peterson, Carpenter & Lubinski, 1990; McLeod, 1994). Yet three overviews on research about mathematics anxiety (Wood, 1988; McLeod, 1994; Ma, 1999) report mixed results on the effects of mathematics anxiety on students' mathematics learning, because, according to Ma (1999) "...the relationship can change dramatically for students with different social and academic background characteristics" (p. 536). Students with different approaches to learning also experience learning environments in different ways, for example field-dependant learners and learners with surface approaches to learning feel more comfortable with structured, externally regulated environments (Vermetten, Vermunt & Lodewijks, 2002), whereas deep-level learners may experience irritation and frustration in such environments.

In the same way, the importance of the teacher in the learning environment has been brought into question by some studies and then again affirmed by others. After a large-scale comparison of primary schools' levels of performance in the United Kingdom, Lake (2001) concludes that "...the major influences on children's school performance clearly stem from outside school" (p.65) and that "differences in educational standards among primary schools are predominantly due to background wealth and health differentials" (p. 59). Brown, reporting on the Leverhulme Numeracy Research Programme, states that

“teaching and teachers have a rather small effect on pupils’ gains...at most 10% of the variance in attainment” (p. I-26).

However, those studies where students themselves were interrogated as to the reasons for their attitudes towards and achievement (or lack of it) in classroom mathematics, ascribe a major role to the teacher (for example, Jackson & Leffingwell, 1999; Quilter & Harper, 1988). In line with these studies, in 2001 and 2002 I requested our university’s B.Ed first year students to write a response to the question: “Which was your worst or most unpleasant year (or topic or semester) in school mathematics? Try to describe the reasons for your choice as clearly and honestly as possible”. These students are following a four-year degree course in elementary school education, come from stable, disciplined schools and obtained a good pass-mark in their twelfth-grade national school leaving examinations. In both groups, at least 90% of the students also elected and passed mathematics as twelfth-grade subject.

In both year groups, the “worst” grades nominated were spread over grades 1 to 12, and students indicated that their marks had also suffered in these years. The reasons given were as follows: (The two percentages refer to the 2001 and 2002 groups consisting of 77 and 63 students respectively.)

the teacher (72%, 70%)

the student wanted to make sense of the mathematics, but was not encouraged to do so, or the student was required to memorise methods and/or facts, but could not/would not learn in that way (8%, 8%)

the mathematics was too difficult (10%, 14%)

external factors such as changing schools, family crises, no friends in the class, unhappy in the school (10%, 8%).

The majority of students therefore experienced the influence of the teacher to be very important. The reasons given for teachers’ negative effects on students’ learning involved teachers’ lack of mathematical and pedagogical content knowledge, teachers’ lack of classroom management skills and discipline, and teachers’ unpleasant behaviour towards students, ranging from impatience to destructive personal remarks (by far the most common reason).

In the face of the conflicting reports on what affects students’ learning, we can only conclude that productive learning environments are indeed sensitive to many interrelated influences. As teacher trainers, however, we also need to be aware of what type of information can be of use to teachers, and I believe that making teachers aware of the impact they can and do have, is more important than concentrating on the influence of the home and locality of the students on students’ achievement.

In the study reported here, I have attempted to study the teacher as a variable in the mathematics classroom. For this purpose, five different schools providing for children from different socio-economic backgrounds were chosen, and written tasks including items on “feelings towards school mathematics” and items on mathematical problems were presented to their Grade 3 classes. Since these schools reshuffle their classes at the beginning of each academic year to create similar groups (i.e. the opposite of streaming

or setting), it was hoped that if classes in the same school were then compared, differences in feelings and performances could be attributed more to the effect of the teacher than to other (outside) influences.

The aims of this study were to gather information on:

- Gender. For example, are girls better at routine problems and boys better at novel problems? Are girls more prone to anxiety? Are some classrooms more conducive to girls' learning (or boys') than others?
- Feelings about mathematics. For example, do classes where students feel positive about their mathematics do better, or do they do better in specific problems but not in others?
- Differences among classes in the same school. To what extent do classes in the same school differ and in which ways do they differ? To what extent, therefore, is the teacher a factor in young students' mathematics learning?

METHOD

Five schools were chosen for this study because they reshuffle their classes at the beginning of each academic year and because among the five of them, they represent a range of teaching approaches to mathematics. Each class therefore contains a fairly evenly distributed balance of abilities, gender, socio-economic and home backgrounds and emotionally disturbed children (school B).

All 13 Grade 3 classes in the schools were involved, the class sizes ranging from 22 to 30 depending on the size of the school.

THE SCHOOLS

The five schools involved in this study will be called A, B, C, D and E. School A is a large elementary school in a large country town. The teaching approach is traditional. Schools B and C are also situated in country towns and use a teaching approach which welcomes students' informal methods and encourages some informal and whole-class discussion and feedback, but the teacher features strongly as arbiter and leader. Schools D and E are affluent suburban schools in a city, where the teachers are committed to implement a problem-centered approach to mathematics teaching and learning (Murray, Olivier & Human, 1998).

All five schools are stable, disciplined and well-organised. The principals of schools B, C, D and E are supportive of their staff and accessible to the students. The schools are multiracial but all students receive instruction in their home language except for the English-medium school D, where there are four or five African students in each class who receive their instruction in English.

The students of schools A, B and C are mixtures of very different socio-economic backgrounds. School B in particular includes children from a children's haven which

harbours emotionally and physically abused children, which comes to approximately three children per classroom.

All the teachers involved have similar school and teacher training qualifications. None were novice teachers.

The situation is therefore such that, although the schools themselves and their students and parent populations are different, the classrooms in each school are quite similar as regards students.

THE WRITTEN TASKS

The tasks were presented to the students during the sixth month of the academic year. The items addressed the following:

Students' feelings about the mathematics classroom. Students were requested to complete a number of sentences. In this report, the following sentences were used:

Item 1a) When we do mathematics, I feel ...

1b) When I have to do a difficult mathematics problem, ...

Routine calculations. Context-free two-digit addition, subtraction and multiplication problems involving "borrowing" and "carrying".

Division problems. A contextualised quotitive (grouping) problem ($100 \div 23$) and a contextualised partitive (sharing) problem ($96 \div 6$).

Proportional sharing. This contextualised problem involved dividing 20 in the proportion of 3:1. It may seem extremely easy, but very few of our lower elementary teachers think of posing this problem type, and the problem may therefore be regarded as novel (i.e. strange to the students).

Pattern extension. The first four dot configurations of a sequence are given. Students must then work out how many dots will be used in the fifth and then the twentieth configuration. This is regarded as a novel problem.

We also made provision for students to write free comments on their mathematics classroom and to draw a picture, but some schools could not give us time for this to be completed and they were therefore not taken into account.

In school B, one student from each class was interviewed, and the information obtained during the interview matched the student's responses to the written test exactly. In school B, the teachers also completed a beliefs questionnaire, but their expressed beliefs about pedagogical matters like how weak students should be handled, the role of memorization of facts, etc. were not substantiated by the information gained during their students' interviews nor by classroom observation and videotapes of their mathematics lessons. It was therefore decided not to use the teachers' questionnaires.

RESULTS

Students' responses to the written tasks were coded so that the way in which the student solved the problem, misconceptions, faulty reasoning, guesswork, etc. were preserved. These data were accumulated for each classroom, by gender and also for each classroom as a whole.

Students' responses for items 1a) and 1b) (completing the sentences) were coded as positive or negative only when students expressed themselves strongly. "OK" was not coded as positive, and "a bit uncomfortable" was not coded as negative.

Those responses for the mathematical items which showed flawed reasoning based on misunderstood properties of numbers and operations were later clustered under "systematic errors". Systematic errors therefore do not include careless mistakes, but are rather of the following type:

$$42 - 28 = 10 \text{ because } 40 - 20 = 20$$

$$20 - 8 - 2 = 10$$

FEELINGS ABOUT THE MATHEMATICS CLASSROOM

The sentence "When I do mathematics, I feel ..." gave what we feel to be a falsely positive impression which did not match the students' responses to item 1b), "When I have to do a difficult mathematics problem, ...". We had a similar experience in an earlier study (Murray, Olivier and Human, 1994), where students were invited to write free comments on their mathematics classrooms. Many would start off by saying "I love mathematics", but then continue by describing anxiety and fear. In this study, for example, in classroom B, school B, 86% of the students claimed that they felt good or great when doing mathematics, but 75% said that they were frightened, wanted to cry, wanted to run away, etc. when they had to do a difficult problem. We therefore take item 1b) responses as better indicators of students' real feelings.

Some responses for item 1b) show great distress, for example:

"I feel terrible"; "I feel like crying"; "I want to scream"; "I am scared".

Some positive responses were:

"I make a plan"; "I use my head and think it out"; "I am happy because I like difficult problems".

In each of schools A and B one of the classes had a much higher negative count than the other two classes in the same school, and these classes had a slightly lower success rate for most but not all of the mathematical items, including the novel problems. These classes did not have a higher incidence of systematic errors than the other two classes in the same school.

GENDER

In nine of the 13 classrooms girls' and boys' success rates were very similar, or girls might do slightly better in one or two items and boys slightly better in another one or two items.

In school B, classroom A, girls did better in the subtraction, quotitive division and proportional sharing problems (differences of 19, 18 and 46 percentage points).

In school D, classroom A, boys did significantly better in the division problems and in the proportional sharing (differences in success rate of respectively 42, 30 and 23 percentage points), yet girls obtained a 25 percentage point gain over the boys for the more difficult pattern extension problem. This was also the only classroom where there

was a significant difference between the “positive about mathematics and difficult problems” count for boys and for girls (boys 38 percentage points more positive).

DIFFERENCES AMONG CLASSES IN THE SAME SCHOOL

There was little difference between the two classes of school E. In school A, the one class had a very high count of negative feelings (more than three times that of the other two classes) and its success rates on the mathematical items were slightly lower than those of the other classes. School B classes showed major differences in the following items:

Classroom	A	B	C
negative feelings	36%	75%	21%
success rates for subtraction	55%	78%	100%
quotitive division	18%	50%	79%
partitive division	68%	50%	75%
proportional sharing	32%	21%	79%
pattern extension a)	36%	32%	58%
pattern extension b)	5%	4%	29%
systematic errors for subtraction	45%	21%	0%
quotitive division	69%	49%	21%

School C’s two classes had different success rates for subtraction (62%, 80%) and proportional sharing (48%, 84%). School D classes differed as follows:

success rates for			
quotitive division	87%	51%	81%
partitive division	61%	78%	95%
pattern extension a)	87%	43%	62%
systematic errors for			
partitive division	35%	21%	5%

Given the situation, we can only ascribe these differences in negative feelings and in performance among the classes of the same school to the influence of the teacher.

DISCUSSION

This study has not brought gender differences to light as regards feelings about mathematics, routine tasks or novel (problem-solving) tasks. In only one of the classes boys performed significantly better than the girls in most items and were also significantly more positive about mathematics, yet girls did better in the more difficult problem solving item. In all twelve other classes the success rates for boys and girls were very similar or girls scored slightly better.

As regards feelings about school mathematics, two of the thirteen classes showed high levels of fear or discomfort, but this did not lower the success rates for the mathematical items to a great extent as compared to the other classes of the same school. It is, however, extremely disturbing that these children are caused much distress by adults who are supposed to have their best interest at heart. Unfortunately such unpleasant experiences

may have lasting effects on students' learning. Many of my first-year students wrote that their "worst year" was something they never recovered from (compare also Jackson and Leffingwell, 1999).

As regards the mathematical items, the effect of the teacher could first of all be seen when the class performs badly in a contextualised problem with a specific mathematical structure. For example, class A in school B scored only 18% for quotitive division, which is much lower than the other classes and also much lower than their own score for partitive division. Since schools B, C, D and E do not "block" the operations (e.g. three months of addition, followed by three months of subtraction, etc.) but mix the problem types, the excuse cannot be that they have not dealt with that particular problem type yet, but rather that the teacher had neglected to include the problem type in her mix. The same problem with quotitive division surfaces in school D, class B, but not as severely. This emphasises the responsibility of the teacher to make available to her students the necessary opportunities for becoming familiar with different important mathematical structures.

The effect of the teacher on the development of systematic errors is well illustrated by the relatively high incidence of systematic errors in school D, class A, for partitive division, whereas in school B, class A, subtraction and quotitive division have very high incidences of systematic errors.

Systematic errors can develop when students imitate the teacher or a classmate's method without understanding, or when the methods constructed by the students are not sufficiently discussed and reflected on. Students may also misapply a technique because when it was first used (correctly), it did not provoke any argument from other students and the teacher therefore did not think it necessary to spend time on discussing it. For example, this works:

$$27 \times 16 = 27 \times 10 + 27 \times 6$$

so let us do the same here:

$$360 \div 16 = 360 \div 10 + 360 \div 6$$

Systematic errors may also occur as a result of limiting constructions being formed by students through limited exposure to a concept or through experiences of a particular (limited) kind (Murray, Olivier & Human, 1998). The above error could also have developed if students had for some time been solving addition and multiplication problems involving two- and three-digit numbers, but division problems limited to only single-digit divisors.

IN CONCLUSION

This study has found no gender-related differences in performance for different types of mathematical tasks among Grade 3 students, which encourages the idea that such differences reflect learnt behaviour and can be prevented. There does not seem to be a clear inverse relationship between negative feelings towards school mathematics and performance, but when other research is taken into account we may infer that factors like the classroom culture (teachers' and students' mutual expectations of one another) make this relationship far from straightforward. As regards teachers, there is very clear evidence that teachers do make a great difference to *what* students learn and *how* they

learn it; in other words, not only how well students learn mathematics but what kind of mathematics they learn.

This depends on the teachers' *choice* of tasks presented to the students, the *sequence* in which these tasks are presented, and especially the *classroom culture* he or she establishes (the teacher's and students' belief about the nature of mathematics and what is expected of them when they "do mathematics").

References

- Brown, M. (2002). Researching Primary Numeracy. In A.D. Cockburn & E. Nardi (Eds.), *Proceedings of the Twenty-sixth International Conference for the Psychology of Mathematics Education, Vol. I* (pp. I – 15 — I–30). Norwich, UK.
- Fennema, E., Peterson, P.L., Carpenter, T.P. & Lubinski, C.A. (1990). Teachers' Attributions and Beliefs About Girls, Boys and Mathematics. *Educational Studies in Mathematics, 21*, 55-69.
- Jackson, C.D. & Leffingwell, R.J. (1999). The Role of Instructors in Creating Math Anxiety in Students from Kindergarten through College. *Mathematics Teacher, 56*(5), 864-880.
- Lake, M. (2001). Home and locality: The real determinants of current educational achievement. *Ways of Knowing Journal, 1*(2), 59-68.
- Ma, X. (1999). A Meta-Analysis of the Relationship between Anxiety towards Mathematics and Achievement in Mathematics. *Journal for Research in Mathematics Education, 30*(5), 530-540.
- McLeod, D.B. (1994). Research on Affect in Mathematics Learning in the JRME: 1970 to the Present. *Journal for Research in Mathematics Education, 25*, 637-647.
- Murray, H., Olivier, A. & Human, P. (1993). Voluntary Interaction Groups for Problem-centered Learning. In I. Hirabayashi, N. Nohda, K. Shigematsu & F. Lin (Eds.), *Proceedings of the Seventeenth International Conference for the Psychology of Mathematics Education, Vol. II* (pp. II – 73 — II – 80). Tsukuba, Japan.
- Murray, H., Olivier, A. & Human, P. (1994). Young Students' Free Comments as Sources of Information on their Learning Environment. In J.P. da Ponte & J.F. Matos (Eds.), *Proceedings of the Eighteenth International Conference for the Psychology of Mathematics Education, Vol. III* (pp. 328-335). Lisbon, Portugal.
- Murray, H., Olivier, A. & Human, P. (1998). Learning Through Problem Solving. In A. Olivier & K. Newstead (Eds.), *Proceedings of the Twenty-second Conference of the International Group for the Psychology of Mathematics Education, Vol. I* (pp. I – 169 — I –193). Stellenbosch, South Africa.
- Quilter, D. & Harper, E. (1988). Why we didn't like mathematics, and why we can't do it. *Educational Research, 30*(2), 121-134.
- Vermetten, Y.J., Vermunt, J.D. & Lodewijks, H.G. (2002). Powerful learning environments? How university students differ in their response to instructional measures. *Learning and Instruction, 12*, 263-284.
- Wood, E.F. (1988). Math Anxiety and Elementary Teachers: What Does Research Tells Us? *For the Learning of Mathematics, 8*(1), 8-13.

THE ACTIVITY OF DEFINING

Talli Nachlieli and Anna Sfard, University of Haifa, Israel

This paper presents a rationale and a conceptual framework for a wider research project dealing with mathematical communication, and in particular with actions performed by interlocutors whenever they wish to clarify their use of a symbol, a word or an expression. The aim of such actions is often to repair a communicational breach resulting from differences in the interlocutors' uses of words. As was found in our study, only some of the defining actions would result in texts known as mathematical definitions. The point of departure of our research project is that the effectiveness of the defining actions is as much a function of the action itself as of its contexts. Our focus in this research is thus broader than in the past studies on definitions, and includes the when and why of defining along with their how.

Today, it is a common belief that learning with peers in small groups has many advantages over frontal learning, where the teacher is often the only speaker. And yet, such face-to-face interactions would sometimes be ineffective and, as such, would be lacking the basic feature that is a necessary condition for successful learning. Let me begin with an example of a situation where the participants fail to communicate¹. In the episode presented in Fig. 2, two 7 grade students are working together to answer question 3 appearing in Fig. 1.

The number of hours of daylight on any given day is a function of what day it is in the year, and of the latitude of the location. The number of hours of daylight in Alert, NWT (near the North Pole) was recorded every day in 1993. The graph below shows the information.

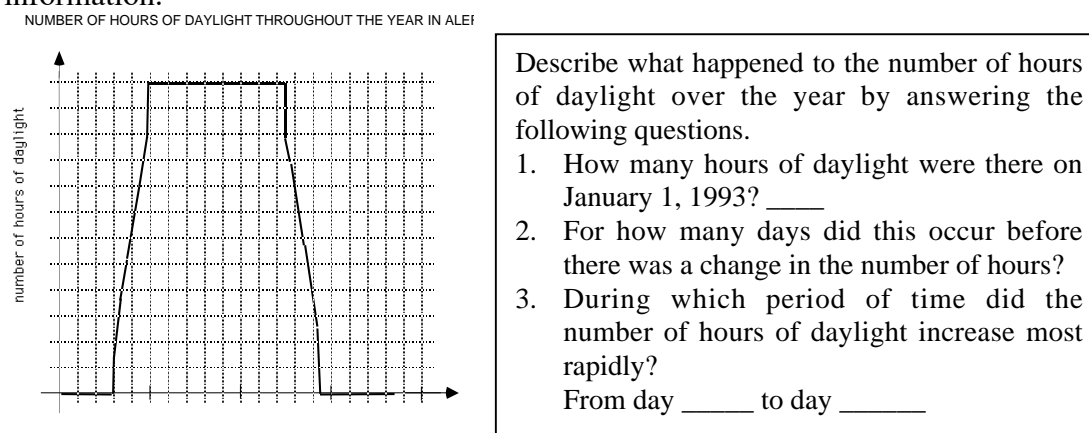

Figure 1: Daylight Episode, Activity sheet

At the first glance (see Figure 2 below) it looks like the boys are trying to collaborate in solving the task. At a closer look, we see a communication breach that persists all along the episode. This miscommunication is clearly apparent to both students, as they question

¹ This example appears in Sfard & Kieran (2001) in a different context.

each others solutions and cannot agree about the answer (see, e. g. [14]-[20]). They do try to repair the breach but their attempts are ineffective.

What is done	What is said
<p>[17]"here and here": G. points back and forth several times to the extremes of the upper horizontal line, about (100,24) to (250,24)</p> <p>[19]G. traces the "descent" of the line from x=100 to 0.</p> <p>[23]G. is still pointing at about 250 on x axis.</p> <p>[30] A. underlines "time" on G's question sheet.</p> <p>[31] G. traces horizontal line at 24 hours</p> <p>[32] "that didn't change: here A. traces horizontal line at 24 hours. "right here": A. puts pencil mark along graph from y=20 to 24.</p> <p>[35] G. traces ascent of graph from 0 to 100</p> <p>[37]G. traces a curve along graph from 0 to about 250.</p>	<p>[12] A: 60 to 100. From day 60 to 100</p> <p>[13] G: Cause, Oh no, no, no no no. Look, look. Up here. It's day 100 to day --- to day</p> <p>[14] Ari: What are you talking about?</p> <p>[15] Gur: 55.</p> <p>[16] Ari: Where?</p> <p>[17] Gur: Look, it changed most rapidly in between here and here. You see?</p> <p>[18] Ari: Oh? It's exactly the same.</p> <p>[19] Gur: No, because see, it moves up (mumble)</p> <p>[20] Ari: It goes up most rapidly</p> <p>[21] Gur: So it's from day 100</p> <p>[22] Ari: To day 100</p> <p>[23] Gur: No, from day 100 to day ---</p> <p>[24] Ari: No, No, No.</p> <p>[25] Gur: 2 hundred and sixty,</p> <p>[26] Ari: That's not how you're supposed to do it.</p> <p>[27] Gur: two hundred and eighty. To day</p> <p>[28] Ari: See, during which time. The time, the period of time has to change rapidly.</p> <p>[29] Gur: Oh. No, it says from day to day what?</p> <p>[30] Ari: Read the question. During which period of <u>time</u> - time.</p> <p>[31] Gur: Up here, time.</p> <p>[32] Ari: No, but that didn't change, it stayed still, which means it has to be right here,</p> <p>[33] Gur: No</p> <p>[34] Ari: which is about 90</p> <p>[35] Gur: Right here</p> <p>[36] Ari: No, right here</p> <p>[37] Gur: You don't get it, do you? If it was like this</p> <p>[38] Ari: Fine, it's from 60 to a hundred, ok?</p> <p>[39] Gur: No.</p> <p>[40] Ari: Yes. I'm writing that.</p> <p>[41] Gur: Why?</p> <p>[42] Ari: We can have different answers.</p> <p>[43] Gur: Why? I don't care.</p>

Figure 2: Daylight Episode

The extensive use of the indexical *it* in [17] and [18] is one of the reasons. The boys do not employ the word in the same way. In [17], Gur says ‘it changed most rapidly’ while pointing to a part of the graph that represents a constant function. It is thus plausible that

while using the word *it* Gur refers to the graph itself rather than to a mathematical object (function) which the graph is supposed to represent. Consequently, he tries to interpret the terms appearing in question 3 as referring to properties of the graph. However, the graph is a stable object and the terms *rapid* and *increase* both refer to processes. It seems that Gur helps himself out of the dilemma by interpreting the words ‘increase most rapidly’ as ‘there is the most *extreme* change in the shape’ (of the graph). To sum up, in [17] Gur uses the word *it* as a substitute for *the graph*.

In contrast, Ari seems to be using the words ‘increase most rapidly’ in the way intended by the authors of the worksheet, and thus in his case, the word *it* in [18] comes to replace the number of daylight hours (as represented by the graph). In [19] and [20] each of the boys continues to use the word *it* in his own way. In [28] Ari performs a defining action: he repeatedly stresses that it is ‘the time, the period of time [that] has to change rapidly’, thus clarifying retroactively that the word *it* in [18] had to do with time, or period of time, rather than with the graph as such. This clarification does not seem to work for Gur, so Ari takes a more direct attempt to focus Gur’s attention on the use of the word *time* ([30]). He does this by pointing to the written word *time* in the worksheet. In [32] the boy tries yet again to repair the miscommunication, but he uses the indexical *that* instead of explicitly saying that the number of daylight hours is what he has in mind. As a result, also this attempt at straightening things out proves futile.²

To sum up, throughout the episode Gur refers to the graph itself while Ari speaks about what is represented by the graph. The boys do not seem to be aware of this significant difference. Because of cases like this, the cases in which the participants use the same words in different ways, I undertook the present study. My focus is at what will be called here activity of defining - the activity that aims at keeping communication effective by clarifying uses of words. Defining actions are a natural answer to the type of communication breaches we saw in the Daylight episode. Yet, as the example shows, such actions do not have to be effective. This observation is a point of departure for the questions I ask in my study: What types of defining actions people use to perform spontaneously? Why is it that these attempts are often ineffective? Can the skills of defining be taught? Let me stress that the focus of the study is on the actions of defining and not just on their products. In particular, I will be looking at defining actions performed in mathematics classrooms, but not only on those that lead to mathematical definitions. Of course, mathematical definitions will be dealt with as one of many possible products of such an action. The unique role of such definition in keeping the mathematical discourse effective will also be discussed. And yet, the scope of defining actions to be considered in the study is much broader than that. The research project

² Another possible cause of confusion might be the fact that Ari uses the word *time* ([28] and [30]) in two different ways. In [28] he states: *The time, the period of time has to change rapidly*. The reference to a change in time suggests that he may, in fact, use the word *time* as a shortcut for *the number of hours of daylight per day*. Yet, in [30], Ari uses this same word as it is asked for by question 3 - *the time in year during which the number of daylight hours increase most rapidly*. His confusion is probably the result of the fact that the word *time* has a double meaning here and may be measured in days along the x-axis, and in hours along the y-axis.

devoted to the activity of defining deals above all with the question of when defining actions are undertaken by interlocutors and of what makes them effective or ineffective. In this paper, I will present only a very small part of this larger study.

COMMUNICATIONAL BREACHES AND EVENTS OF DEFINING

As was shown, the reason for the salient difficulty observed in the Daylight episode was the fact that Ari and Gur used the same words (increase most rapidly, time) in different ways. This type of communicational breach is not limited to mathematics. Indeed, this is a very common type of miscommunication that occurs in other types of discourse as well. One way to deal with situations like this is to engage in the activity of defining: The interlocutors have to make a transition to meta-discourse, that is, to the talk about their talk, in order to explicitly discuss and coordinate their uses of words. Two conditions must be fulfilled if such action is to happen and to be effective: First the participants must realize that the reason for the breach is their different uses of the same words, and second, they must arrive at an explicit agreement about the words' use. If so, in a study like this two questions must be considered: First, what prompts people to undertake defining actions? And second, how do they do this? The first question deals with the when of defining, whereas the second one with the how.

To address these two questions I will examine closely discursive events in which people try to communicate their use of words. These events will be called *events of defining* or *EoDs*, for short. An EoD consists of those three components:

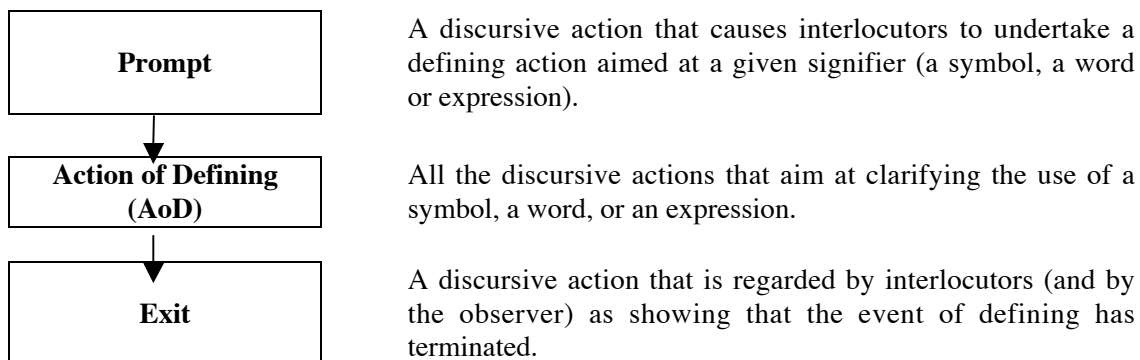

A very simple example of EoD appears in Figure 33.

Utterances	Activities	Analysis
Ron: What is a cone?		Prompt
Iris: It's this clown's hat over here.	Iris picks a cone from a set of solids.	AoD
Ron: Ah, ok.		Exit

Figure 3: An EoD - a cone

In this example, Ron's request for a clarification regarding the use of the word *cone* prompts Iris to perform the *action of defining* that involves a *metaphor*⁴ (Iris names the

³ EoD may be much more complex, as discursive events of defining have a recursive structure, that is, in any such events other EoDs may be nested.

⁴ A metaphor is using words from one discourse in a different type of discourse.

cone a clown's hat) and an *ostensive definition*⁵ (she picks up an example for a cone). Ron *closes* this event by accepting the AoD performed by Iris and thus signaling that an action of defining is no longer needed.

Referring to the three components of the EoD enables us to deal not only with the *how* but also with the *when* of definitions: by studying the AoD we learn about *how* one defines, and by scrutinizing the prompt and exit we get to know *when* one turns to an AoD, how she chooses the specific defining action, and how she decides that the process of defining can be regarded as completed.

AoD is a meta-discursive action supposed to inform others about the way one uses a word. Making the rules of the word use explicit is supposed to allow the interlocutors to mutually adjust their discursive ways and in particular, to coordinate their use of the words. Defining actions performed in real-life conversations are many and diverse, and they include pointing (*ostensive defining*), explaining by examples or metaphors, enumerating all the elements of the category, presenting necessary and sufficient conditions for an element to be included in the concept, etc. In mathematics, only the last type on our list counts as the proper type of defining action. In order to get to know all this diversity, there is a need for a very rich and diverse collection of data. In our study, in addition to extensive analyses of whole-class and small-group classroom interactions, we are looking at conversations between teen-agers at home and at youth movement meetings, at exchanges typical of TV and radio talk-shows, at discussions held in different committees in the Knesset (Israeli Parliament), and at problem solving activities the participants of which would not be able to proceed without making explicit decisions about their use of words. Numerous samples of all these types of discursive activity have been video-recorded and transcribed and they constitute the data base of this study.

STUDYING DEFINING IN CONTEXT

Much attention has already been given by researchers to the products of AoD known as definitions and to the ways in which these products are used (or not!) in school students' discursive activities. In this research project the focus is at the action of defining itself, and much attention is given not only to the *how* of this action, but also its *when* and *why*. In this way I hope to be able to answer some of questions that my own former research left open (Nachlieli, 1997). One of these questions concerns the ineffectiveness of mathematical definitions. More specifically, the problem under study is "What is it that often makes mathematical definitions ineffective?" Let me present this question in more detail.

The mathematical definition, which is one of the products of AoDs, is supposed to be the perfect answer for keeping communication effective. It seems that using this type of definition, as is the case in mathematics, increases the chance that all participants will start using the defined word in the same way. Mathematics is an attempt of mathematicians to create a perfect discourse where there are no ambiguities and where, in particular, no place is left for differing uses of the same words. And yet, as has been eloquently argued by philosophers of science on the one hand (see e.g. Lakatos, 1976), and by mathematics education researchers on the other hand, this hope is rather naïve,

⁵ The term *ostensive* means: by pointing, by showing physically.

since it does not take into account the complexity of human discourse and its essential dependence on contextual factors.

Indeed, past research on definitions and on their role in constructing concepts shows that formal mathematical definitions fail to determine students' use of words even when the students know these definitions (Hershkowitz & Vinner, 1984). Some of the studies simply document the existing gap (Hershkowitz & Vinner, 1984; Wilson, 1990), whereas others attempt to explain the phenomenon (Fischbein, 1993; Vinner, 1990; Fischbein, 1996). Various theories of learning imply that explicit definitions should be useful in constructing concepts, but different studies show that in many cases the definition is not helpful at all and that the students tend to ignore it even when they know it by heart (Hershkowitz & Vinner, 1983). What we found so far confirms all this and more: It not only shows that mathematical definitions are not always listened to, but it also makes us aware that the effectiveness of defining actions cannot be foreseen just by examining their final products. Let me show some evidence.

First, let us look at the case where mathematical definition turns ineffective. In the following episode Noam, an 11th grade student, is asked whether the shape presented Figure 4 is a kite. The following definition is written in front of him: A kite is a quadrilateral in which there are two pairs of equal adjacent sides⁶.



WHAT IS DONE	What is said
Points to that figure: 	[1] Teacher: Is this figure a kite?
	[2] Noam: No
	[3] Teacher: Why not?
	[4] Noam: Because it doesn't look like one.
	[5] Teacher: What does a kite look like?
Points to that figure: 	[6] Noam: like this
	[7] Teacher: What is the definition of a kite?
	[8] Noam: Reads the definition. According to the definition this is a kite but I know it is not.

Figure 4: the Kite Episode

Noam is familiar with the definition and confirms that the discussed figure fulfills the demands dictated by the definition ([8]). Yet, he refuses to accept the definition as the ultimate touchstone for determining whether the given case belongs to the category of kites. It seems that Noam identifies a figure to be a kite in a direct way, that is, his decision about naming is not mediated by any definition. His tendency for the direct identification is so strong that it seems as if the naming act was not a matter of a mere

⁶ In Hebrew there are two different words for the geometric figure that fulfills the given definition (Dalton) and for the flying object (afifon).

recognition, but rather of discovering the “real nature” of the figure. In situation like this, when the name seems to be a part of the thing itself, the explicit definition has little influence on the way in which the word is used.

In contrast, there are defining actions which, while theoretically insufficient and with little explanatory potential, would nevertheless fulfill their communicational goal. For example, in the episode in figure 3 Iris uses a metaphor and pointing (ostensive definition) to define a cone. These two defining actions, if analyzed independently of their context, seem like having a very small chance for doing their job properly. The fact that this AoD actually works makes it clear that the effectiveness of defining actions can by no means be seen as a straightforward result of the quality of the final definition. In other words, there is no point in trying to evaluate defining actions just by looking only at their textual products (the final definitions) and without considering such contextual factors as the history of the conversation, the common discursive habits of the interlocutors, and more.

All this shows that if the study of defining is to bring any useful results, it has to be conducted in as natural circumstances as possible. In the present context, the expression “natural circumstances” refers to situations in which people undertake defining actions spontaneously, in order to overcome naturally occurring communication breaches. As it turns out, this kind of study is quite difficult to perform because of the fact that people do not engage in defining actions as frequently as could be expected. Indeed, our data so far have shown that interlocutors do not seem too eager to reflect on their uses of words even when their communication limps and becomes obviously ineffective. The discursive activity of defining seems to be pushed aside by our strong tendency to use words in a direct, unmediated manner, without accounting for this use and without monitoring its appropriateness. This inclination for unmediated, spontaneous use of words is the basic characteristic of human communication. And no wonder: after all, the directness is the condition for the very possibility of communication. Indeed, just imagine ourselves deliberating on words’ definitions before actually using them. Our fate would be very much like that of the famous centipede who, while asked to think about the way it moved its one hundred legs lost the ability to move. Thus, reflecting on the choice of words before actually putting them into our sentences seems opposed to our most deeply rooted discursive habits. This would be enough to explain why explicit negotiations of words use may be a difficult task for most interlocutors. The additional obstacle stems from the fact that the directness of our choices of words comes together with the deep sense of their uses being extra-discursively determined. Like in the anecdote on a child who was able to understand how astronomers discovered new stars but still wondered how they discover these stars’ names, we sometimes have the feeling that things simply come with their names, and that no human definition can change it.

The above observations bring to mind Vygotski’s (1987) famous distinction between spontaneous and scientific concepts, made according to the way in which these concepts are learned. Similarly, we can distinguish between spontaneous and scientific uses of

words⁷. The spontaneous use develops through interactions with others, when we pick up discursive ways of our interlocutors. This learning by mimicking happens as if by itself, imperceptibly to ourselves. Scientific use, in contrast, must be deliberately taught. Its learning occurs not just by practicing word use, but also by reflecting on this practice. Explicit defining is a necessary part of this learning. In schools, one's spontaneous uses of words are supposed to be translated into scientific. For this modification to happen, the students will have to learn to suspend their spontaneous discursive decisions for the sake of reflective, meta-discursively mediated choices of words. This, as was already observed, is a difficult thing to learn. The overall aim of my study is to understand the mechanisms of words use and their relation to the activity of defining deeply enough to be able to propose ways for improving students' communication in large, and their mathematical communication in particular.

References

- Fischbein, E. (1996). The Psychological Nature of Concepts. In *Young children and future curriculum in mathematics: International Perspectives*. Dordrecht, Netherlands: Kluwer Academic Press.
- Hershkowitz, R. & Vinner, S. (1984). Children's concept in elementary geometry - a reflection of teacher's concepts? *Proceedings of the Eighth International Conference for the Psychology of Mathematical Education*, pp. 63-70.
- Lakatos, I. (1976). *Proofs and refutations*. Cambridge: Cambridge University Press.
- Nachlieli, T. (1997). The interaction between images and definitions in solving problems in geometry, *A study submitted for MA*, Tel-Aviv University.
- Sfard, A. & Kieran, C. (2001). Cognition as communication: Rethinking learning-by-talking through multi-faceted analysis of students' mathematical interactions. *Mind, Culture, and Activity*, 8(1), 42-76.
- Vinner, S. (1990). Inconsistencies: their causes and function in learning mathematics. *Focus on learning problems in mathematics*, vol. 12, 3&4, pp. 85-98.
- Vinner, S. & Hershkowitz, R. (1983). On concept formation in geometry, *ZDM*, 83/1, pp. 20-25.
- Vygotsky, L. S. (1987). Thinking and speech. In R. W. Rieber, & A. C. Carton (Eds.), *The collected works of L. S. Vygotsky* (Vol. 1, pp. 39-285). New York: Plenum Press.
- Wilson, P. S. (1990). Inconsistent ideas related to definitions and examples. *Focus on learning problems in mathematics*, vol. 12, 3&4, pp. 31-47.
- Wittgenstein, L. (1953). *Philosophical investigations*. Oxford: Blackwell.

⁷ According to Vygotsky (1987), *concept* is a word together with its meaning. If combined with Wittgenstein's (1953) interpretation of the notion of *meaning*, the term concept becomes tantamount to the *word together with its discursive use*.

COLLECTIVE LEARNING STRUCTURES: COMPLEXITY SCIENCE METAPHORS FOR TEACHING

Immaculate Namukasa and Elaine Simmt
University of Alberta

The purpose of this paper is to discuss the activities of collective learning structures. Drawing from ecological-complexity theory it elaborates on a theoretical framework for observing and acting upon collective learning. To interpret the relation between individual action, social interaction and the collective cognitive domain we adopt the thermodynamic notion of energy-rich matter and the enactivist notion of inter-objectivity. We study the structure, the behavior and the ecology of the collective cognitive domain not only as a catalyst for individual learning, but as a learning body in itself, that emerges from the actions and interactions of individual learning agents.

OBJECTIVES

Through our research we seek to understand the character of collective learning structures and to develop theoretical frameworks for observing and acting upon the learning systems in which students and teachers, as individuals, are nested. To study the relation between the individual and the social learning factors, we draw from ecological-complexity theory. Specifically, we use von Foerster's (1981) notion of energy-rich matter and Maturana's (2000) notion of inter-objectivity to interpret the collective learning that emerged in the context of a grade 7 classroom. We then read those interpretations against our theoretical framework in order to further develop it.

Many mathematics education researchers have recently turned their attention to the social aspects of learning (see *Educational Studies in Mathematics*, 2002, a special issue on discursive approaches). Even though most social cultural theorists engage in the systematic study of social-cultural processes (e.g. power relations, classroom practices and norms), a majority of them, akin to individual constructivists, unquestionably privilege the individual student (singular) as the only learning agent (Burton, 1999). Particular emphasis is placed on processes of interaction; less is said about the activities of the collective structures that emerge from and co-emerge with the interactions.

Some researchers such as Burton (1999), Cobb et al. (1997), Kieren and Simmt (2002), and Sfard (2001) have begun to reconceptualize the notion of "learning agents" to include the collective learning structures. To Sfard (2001) mathematical ability is not only an individual property but can be regarded as a property of the joint actions, "one that does not have an existence beyond these individual interactions" (p.49). Sfard developed analytical tools to explore joint activities of partnered students solving problems. Cobb et al. (1997) developed a construct, collective reflection to distinguish collective mathematics development. Cobb et al. recognize that the relation between the knowing acts of the individuals and those of the class as a whole is not linear, but rather one of recursive elaboration in which individual and collectives of learners are brought forth in immediate action (Kieren & Simmt, 2002). Kieren and Simmt explore collective understanding as a dynamical process arising from the "interactions of interactions" that is "related to the whole collective and its embodied setting rather than referenced to

individual knowing per se” (p. 866). They call for further research on how collective learning structures relate to individual acts and social interaction.

THEORETICAL FRAMEWORK

Ecological-complexity draws metaphors from complexity science. In the complexity view such phenomena as thought are construed not as solely individual-psychological events, but rather as part of a more inclusive phenomenon, namely, cognition (von Foerster, 1981). Cognition is described as an emergent property of a level of organization above that of the internal dynamics of a system (Maturana, 2000). In humans, cognition is a property arising from the interplay of brain, body and environment. In a manner compatible to that of distributed cognition theorists who suggest that intelligence is distributed among the social and material dimensions (See *Journal of Interchange on Learning Research*, a special issue on distributed cognition, 2002), complexity science allows us to study both the cognitive domain of collectives and of individuals.

The ecological-complexity view encompasses the neo-Vygotskian view that emphasizes the role of social activity in learning. However, individual learning is recognized as nested in the activities of the class (as a social system that, in turn, is nested in broader systems such as the cultures of a school). At each level of emergent organization new activities appear (See Davis & Simmt, 2002). Hence, the cognitive domain of the organs, of the individual learner, of collectives of students, and of the different cultures need not be subjected to the same possibilities and rules (Davis & Sumara, in press).

Rather than evacuating individual students’ experiential and sensory-motor accounts as some social-cultural theorists such as Lerman (2000) suggest, complexity theory explains the behavior of collectivities in a classroom in a different domain. As individual students act and interact, collective structures emerge. The behavior of the collective is a historical consequence of individual and inter-individual actions and that, in a recursive manner, the behavior of the collective occasions individual students’ sense making (Kieren & Simmt, 2002). The emphasis on emergent structures offers insights into studying the dynamics that afford learning systems (individual and collective) coherence without collapsing them into one. The meaning of objects, artifacts and concepts are not pre-given (in the culture or, even, in situated practice) but they arise in interactions and actions (Maturana, 2000). The objects that co-emerge with the learners acting and interacting provide the energy-rich matter for collective as well as individual learning. Von Foerster (1981) suggests that it is the thermodynamic concept of energy availability and transformation that may metaphorically explain links between organizational levels: the social to the individual level, the empirical to the abstract level, and so on.

MODES OF INQUIRY

Our research is classroom-based; and though some might suggest that it falls under the paradigm of action research, we do not call it such. However, it is similar to action research, for it is grounded in practice and our question is pragmatic. We ask: What can be done to enlarge the sphere of the possible as we engage students in mathematical activity? Our research, however, is also about theory building. We are interested in developing ways of making our observations about learning coherent. To pursue our practice-based and theoretical goals we find ourselves creating explanations based on our

observations of the “learning bodies” that emerged in a mathematics classroom. In the study Simmt taught grade 7 mathematics for one year. In a manner consistent with the complexity theory (particularly enactivism) that frames our research, we understood the students as complex systems nested within the class collective—also a complex system. Individual bodies (whether humans or social systems) were observed to learn as a result of their internal dynamics, and coupling with others and with the environment.

Burton (1999) maintained that over privileging the individual, as the only knowing agent, is the basis for individualized syllabi. In today’s complex and changing world, teams and networking are prevalent conditions of learning and working. Of particular relevance our analyses are the structure, the behavior and the ecology of collective learning structures. Studying collectives of many agents raises a possibility of construing collectives of students as complex bodies possibly with emergent properties such as mind.

AN INTERPRETIVE POSSIBILITY

We draw illustrative cases from two consecutive lessons on transformational geometry, the first one in which students began by exploring objects with three lines of symmetry.

Part 1

1. “Can you tell me the name of an object that would have 3 lines of symmetry? Some objects” A number of students raised their hands immediately but Edwin in a quiet voice blurted out.
2. “Triangle.”
3. Unaware that Edwin had made a response the teacher continued, “Imagine in your heads an object that has 3 lines of symmetry. Agnes.”
4. “Triangle.”
5. “What kind of triangle?” the teacher prompted.
6. “Equilateral.”
7. “Yeah. Do all triangles have 3 lines of symmetry?” the teacher asked.
8. In chorus the students responded. “No.”
9. After a number of contributions, there was soon some agreement that an equilateral triangle was the only one that had three lines of symmetry. “Okay, how many lines of symmetry does a square have? Joseph.”
10. “Ummm, eight.”
11. “Not a cube but a square,” the teacher responded as she drew a square on the overhead. A number of students began to call out,
12. “Four.”
13. But Joseph was not sure, “Four?”
14. “Four. Ah-ha, that is what people are saying,” the teacher nodded.
15. But another student agreed with Joseph’s first response. “No. Eight,” Stella added loudly.
16. “Let us see ...” The teacher began drawing in a vertical bisector. “There is a line here ...”
17. “Horizontally and two diagonally,” Joseph said guiding the teacher.
18. In a soft voice another student said, “Eight.”
19. “Eight?” the teacher acted confused.
20. “Four,” another student asserted. “Can you think of an object that would have eight?” the teacher asked.
21. Again in a chorus most of the students shouted, “Octagon.”
22. “This is an important question,” the teacher began. “Why did I pose it?”
23. John’s hand shot up.
24. The teacher called on him to offer an answer. “John.”
25. “I think it has more than eight.”
26. “Okay. Save it, save it for a second. Somebody said octagon. Let’s take a look.” The teacher drew an octagon.
27. Esther made an observation seemingly to herself but out loud. “An octagon doesn’t have ...”

28. *Tim also speaking to himself in an excited tone, "A circle, oh!"*
 29. *"Has more than 8," Edwin said, possibly responding to Tim.*
 30. *"Y-e-a-h," Tim continued.*
 31. *Janelle sitting close to Tim and Edwin said, "A circle has 180."*
 32. *"Really?" Tim asked Janelle.*
 33. *In the meantime, the teacher was still drawing lines in the octagon. It was obvious that she was unaware of Tim, Janelle and Edwin's conversation.*
 34. *As the teacher was drawing in the diagonals she and the students counted, "two three four ..."*
 35. *A few students audibly interjected her counting with a discussion of whether the octagon has 8 or 16 lines of symmetry: "That is 16." "Eight."*
 36. *The teacher concluded her drawing by counting together with the students "So if we have 1, 2, 3, 4; 1, 2, 3, 4. I think there are 8. Not 16. Where would the 16 be?"*
 37. *James interrupted at the moment the teacher was waiting to hear from the students who thought it had 16.*
- Part 2**
38. *"I know one that has infi—nite!"*
 39. *"You know one that has an infinite?" the teacher asked. "Don't say it," she said playfully.*
 40. *"There is a shape with lots," another student added.*
 41. *By now a number of hands were up. "You know one that has ... lots," the teacher pointed at students one by one as they shot their hands up to show that they knew.*
 42. *"Me too," a student uttered almost inaudibly.*
 43. *"You know one that has what?"*
 44. *"Lots," he replied.*
 45. *"Me too."*
 46. *"Infinite," another student said.*
 47. *"Infinite," the teacher repeated. "Infinite," another student said.*
 48. *"There are 16," another student said to another in the midst of the new "game." She was likely referring back to the octagon that was still being projected on the screen.*
 49. *"I think eventually ... It will run around," another student commented.*
 50. *Esther and Janelle had a side conversation, "There is 16...." "Why did she say [there is 8]?" Esther asked.*
 51. *"Okay, at the count of 3," the teacher instructed. "An object with an infinite number of lines of symmetry. 1, 2, 3."*
 52. *"Circle," the students called out.*
 53. *Edwin was a lone voice, "Nothing," he said.*
 54. *Although the teacher did not take up his suggestion. (It is not clear whether she heard it.) On the video record Janelle, John and Tim can be observed to discuss the question, of whether it would be possible to draw lines of symmetry for nothing.*
 55. *It was in that conversation that Tim turned to his colleagues saying, "I was thinking a sphere with the same diameter as a circle; a sphere will have more lines of symmetry than the circle."*
 56. *At the end of the class the researcher-observer asked Tim about his conjecture. He responded, "A sphere might have 360 times more lines than the circle."*

Figure 2. Individual and collective knowing systems

Energy-rich materials

In most lessons in the class, the moment-to-moment actions of individuals unfolded into what can be observed as the behavior of a collective learning structure. It was not the teacher's explicit intention, to explore with seventh graders the symmetrical properties of a circle. But by the time the teacher posed a question about the lines of symmetry a square has, it appears, the teacher and the students were drifting into naming objects with 4, 8, 16, ... lines of symmetry. While the teacher was drawing a square to assist students in determining whether it had 4 or 8 lines (lines 16-27 [16-26]), in the collective domain the project at hand arose to find an object with more lines. As the class was exploring objects with 8 lines of symmetry, Tim and Janelle began examining the circle [28-32]. James interrupted the discussion [38] saying that he knew an object with infinite lines. In the collective a project had emerged to find an object with most lines of symmetry.

The groups' interactions and conversation (including the teacher's drawings) appeared to have potentially availed energy rich materials to individual students. For instance, the numbers 180 and 360 that Janelle [31] and Tim [56] used in their conjectures, even at first glance, were not arbitrary. Why was it convenient for the students to use 180 and 360 but not, for instance, 32 and 64? To Bussi (2000), who explored the emergence of enriched use of mathematical tools, this is not arbitrary. Upon reflection we certainly could see where the numbers might have come from. However in the moment those interactions were simply part of the immediate collective intelligence of the class.

In the lesson that followed the significance of a protractor became apparent. When the teacher returned to the idea of an object with most lines of symmetry, other students conjectured, "a circle has 360 lines of symmetry; a circle has 1800 lines of symmetry". One student referred to taking a semi circle to deduce the properties of a circle. As the students empirically tested Tim's conjectures the teacher picked up a protractor. The protractor was a significant object that even in its physical absence (in the earlier lesson) had been a readily available visualization—the numbers 180 and 360. Yet the fact that it was a significant object did not only require the teacher to initiate the students to its cultural use. More was involved; the students together with the teacher, as they recursively coordinated their actions (when measuring angles), brought forth a protractor as energy-rich materials that could coordinate further actions even in transformational geometry. It is probable that in another grade 7 class with different experiences such *conceptual blending* of a measuring tool with lines of symmetry would not have been possible. Here we adopt Maturana's concept of inter-objectivity to elaborate on Vygotsky's notion of symbolic mediation. Whereas Vygotsky's notion emphasizes initiation and internalization, Maturana's (2000) notion of inter-objectivity focuses on the bringing forth of the objects in actions and interactions; objects emerge "as coordinations of doings that coordinate doings" (p. 462). Our retrospective analysis revealed how the protractor was frequently used and became a valued tool in the previous weeks. For example, it was used in measurement and in the introduction of the transformational geometry unit. Throughout these lessons the teacher showed special interest in the need for every student to have a protractor. As students together with the

teacher consensually coordinated actions, the protractor arose as an object that was energy-rich matter not only for individuals but also in the collective domain.

IMPORTANCE OF THE STUDY

Educators are likely to benefit from conceptual tools for observing the nested learning structures. Our analysis is in its early stages. We, nonetheless, speculate that the shifting of teacher's attention to include focusing on the class as a collective learning body has the potential to generate insights as it transcends the duality between the social and individual, the emergent and formal, and the mental and physical aspects of learning.

The complexity view of cognition makes nested learning structures visible. This illuminates the relation between the individual acts, social interaction and collective learning. For instance Tim's brilliant conjectures in this (and other) lessons can be explained as more than an individual attribute. Given the emergent classroom project and the availability of common experiences with the protractor, he, as a structure-determined system, was able to select "elements from rich sources on offer" in the collective and transformed them for his own use (Kieren & Simmt, 2002, p. 871). To a larger extent Tim's conjectures about the sphere were occasioned by the collective project. He was, perhaps, seeking to refute an earlier stated conjecture that the circle had most lines of symmetry. His conjecture offered to a group of his classmates made sense to them and to him because it arose in a community in immediate action, in the collective.

The role of the teacher is key to the nature of the class' collective learning structure. Due to limitations in space, it might suffice to observe the teacher is part of the collective who shares in the control of the collective: indeed she is nowhere to be seen in the immediate interactions around the lines of symmetry of "nothing" [53] or around the comparison of the circle to the sphere [56]. The collective is able to persist in spite the lack of immediate participation by some of its agents. On the other hand it is clear that the teacher's questions and comments were part of the collective project. When James interrupted, "I know one that has infinite, the teacher playfully said, "... don't say it" [39]. This culminated into other students reflecting and offering what they knew. James' comment together with the teacher's response appears to capture a pattern in the joint interaction, a dynamic of mutual learning among members of the community.

Some students just like Esther, perhaps attending to the segments as the amount of symmetry, grappled from far behind the great leaps that the emergent project afforded to the majority of students. Even students, whose voices are not present in the collective, still could never be considered not to support or be supported by the reflections of the collective body. For instance, Joseph's (mis)-understanding that a square had 8 lines of symmetry was central to occasioning the joint project toward examining the symmetrical properties of octagonal shapes [13-36]. It is not our intention to present the teaching in the lesson above as a model. Rather, we emphasize that, on a moment-to-moment basis, the actions and interactions of the students and the teacher in any mathematics class are central to the mathematical behavior of the collective and of individual students. Even conversations of sub-collectives such as Janelle, John and Tim [54] were in feedback loops with the collective and individual students' cognitive domain.

CONSEQUENCES FOR THEORY

We have identified three characteristics of knowing observed in the nested systems: reflections, insights and conceptual blends which co-emerge within the collective space; individual knowing is nested in collective knowing; and the collective reflections, conceptual blends, symbolic objects and the individual knowing recursively become the energy-rich materials to be taken up at either the individual or the collective level.

Collective structures emerge

The class that Simmt taught was a collection of unique students. Despite the diversity, it was apparent that, this group of seventh graders became a coherent collective, with patterns of behaviors. In addition to the learning behaviors that the teacher explicitly encouraged (see Davis & Simmt, 2002), students talked and played lots of the time, with mathematics at the core of their talk and play; they spontaneously broke out into small groups to offer conjectures to each other; and the labor of the mathematical tasks was distributed among the students (not in some organized way but in a locally emergent way) as they took advantage of each others' expertise and interests.

Burton (1999) noted the difficulty of establishing communities of learning in secondary classes that, unlike elementary classes, are taught by several teachers. This was an obstacle to encouraging a community of active mathematics learners. (Simmt had the opportunity of observing the same class with another subject teacher. She observed that the same community brought forth a totally different collectivity with that other teacher, one in which order, silence and independent seatwork was valued). Davis and Sumara (in press) raise the question of studying the differences between collective characters in, for instance, mathematics and language arts classrooms. Simmt's experience supports this.

In this mathematics class the collective that emerged was a student community engaging in mathematics. Moreover, the teacher worked towards avoiding a hierarchical community in which the teacher or textbook was the sole author of knowledge. The students recurrently interacted under mutual acceptance and, as such, the class was a social collective, which maintained a central, although always evolving, character that was certainly distinct from the language arts class that Simmt observed. Using Maturana's (1988, 2000) work, this collective could be distinguished at three levels:

- The structural level of agents at which recognizably unique individuals with diverse abilities and motivations contribute to the collective experiences. (At this level we might observe the internal dynamics, the processes of interaction.)
- The behavioral level—the collective whole that emerges as individual students act and interact has its own dynamics. It interacts with its medium that includes the teaching, the materials, the setting and other collectives. The changes that appear as observable as the collective body structurally changes to compensate for perturbations from its environment, such as collective understanding and knowledge, are the collective structure's behaviors (Kieren & Simmt, 2002; Maturana, 1988).
- The ecological unity level—the collective is nested in a larger unity, say, of the wider school mathematics community. In ecological contexts, the collective learning structure is defined by the whole to which it is a part.

We have discussed the activities of a collective learning structure in order elaborate on previous research on collective understanding reported at the last PME-NA meeting. To interpret how activities of the collective cognitive domain relate to individual acts and social interaction, we have observed that individuals' initial actions are important to both the individual and the collective cognitive domain. At anytime any student's structure is also an expression of the network of the collectives in which he/she co-exists. The behaviors of the collective are connected to its emergence from individual interactions, and they recursively become the conditions of possibility for individual learning. We have identified energy-rich materials, inter-objectivity and symbolic interactions as one aspect of the relationship between joint and individual knowing. Our analyses raise a question: What are the conditions of possibility for more intelligent learning collectives?

References

- Burton, L. (1999). The implications of a narrative approach to the learning of mathematics. In L. Burton (Ed.), *Mathematics Learning: From Hierarchies to Networks* (pp.23-35). London: Falmer Press.
- Bussi, B. M. (2000). The theoretical dimension of mathematics: A challenge for didacticians. In E. Simmt, B. Davis, & J. G. McLoughlin (Eds.), *Proceedings of 24th Annual meeting of Canadian Mathematics Education Study group*.
- Cobb, P., Boufi, A., McClain, K., & Whitenack, J. (1997). Reflective discourse and collective reflection. *Journal of Research in Mathematics Education*, 28, 258-277.
- Davis, B., & Simmt, E. (2002). The complexity science and the teaching of mathematics. In Denise Mewborn (Ed.), *Proceedings of the PME-NA XXIV October* (pp.831- 840), Georgia Center for Continuing Education, Athens, GA.
- Davis, B., & Sumara, D., (In press). Constructivist discourses and the field of Education: Problems and Possibilities. *Educational Theory*.
- Kieren, T., & Simmt, E. (2002). Fractal Filaments: A simile for observing collective mathematical understanding. In Denise Mewborn (Ed.), *Proceedings of the PME-NA XXIV October* (pp.865- 874), Georgia Center for Continuing Education, Athens, GA.
- Lerman, S. (2000). A case of interpretations of social: A response to Steffe and Thompson. *Journal of Research in Mathematics Education*, 31, 210-227
- Maturana, R. H. (1988). Reality: The search for objectivity or the quest for a compelling argument. *The Irish Journal of Psychology*, 9(1), 25-82.
- Maturana, H. (2000). The nature of the laws of nature. *Systems Research and Behavioral Sciences*, 17, 459-468.
- Sfard, A. (2001). There is more to discourse than meets the ears: Looking at thinking as communicating to learn more about mathematical learning. *Educational Studies in Mathematics*, 46, 13-57.
- von Foerster, H. (1981). *Observing systems: The systems inquiry series*. California: Intersystems.

MATHEMATICIANS ON CONCEPT IMAGE CONSTRUCTION: SINGLE 'LANDSCAPE' VS 'YOUR OWN TAILOR-MADE BRAIN VERSION'

Elena Nardi and Paola Iannone
School of Education
University of East Anglia, UK

Responding to an increasingly urgent need for collaboration between mathematicians and mathematics educators, the study reported in this paper engages mathematicians as educational co-researchers in a series of themed Focus Group interviews where a pre-distributed sample of mathematical problems, typical written student responses, observation protocols, interview transcripts and outlines of relevant bibliography is used as a trigger for reflection upon and exploration of pedagogical issues. In the extract exemplified here, a part of the sample that includes a question involving the concept of $\det(M)$, the determinant of an $n \times n$ matrix, triggers a conversation that reveals various images of the concept held by members of the group as well as their beliefs about personal and shared concept images.

Teaching mathematics at university and college level is rapidly changing as fewer and fewer students opt for exclusively mathematical studies (Holton 2001) and, at least in the UK, recruitment of good mathematics graduates to mathematics teaching is at an all-time low. Given the substantial gap between secondary and tertiary mathematics teaching approaches (LMS 1995), students feel increasingly alienated from the traditionalism of university-level teaching (HEFCE 1996). Moreover universities are more than ever accountable to society regarding the quality of their teaching. By the late 90s most responses to these changes were in terms of modifying the tertiary syllabus (Kahn & Hoyles 1997) and of meticulous topic-centred studies (e.g. calculus (Ganter 2000)). However, there has been a growing realisation that reform should be focusing on teaching, in terms of underlying principles and practices and, in particular, in terms of a consideration of students' experiences and needs (Jalling & Carlsson 1995). Moreover, research in mathematics education at this level, beyond offering assistance to university lecturers in this task (for example in the subtle, theory-informed yet accessible ways suggested in (Mason 2002)), needs to engage mathematicians themselves in pedagogically oriented self-reflective processes (e.g. Nardi & Jaworski 2002). The research we report here aims to contribute in this area.

AIMS AND METHODOLOGY

This project engages groups of mathematicians from seven institutions in the UK as educational co-researchers (the main body of data originates in the group of five mathematicians based in the University where the two authors work). It is a 15-month clinical partnership (Wagner 1997) between mathematicians and researchers in mathematics education that builds on the authors' (e.g. (Iannone & Nardi 2002) and others' (e.g. Jaworski, Nardi & Hegedus 1999) previous research. It is funded by the Learning and Teaching Support Network in the UK.

An appropriate forum for the type of collaboration intended in this project is the Focus Group (Wilson 1997): a meeting of a small number of individuals (our chosen 4-5 is seen

in the literature as suitable) with one or more researchers to discuss participants' perceptions, attitudes, beliefs, emotions etc. on a selection of topics in a non-threatening, exploratory environment. Focus Groups encourage and utilise group interactions or in Madriz's (2001) words, allow observation of 'collective human interaction' (Madriz 2001). Madriz advocates the use of Focus Groups for the purpose of facilitating the expression of vulnerable groups of individuals and a group of highly educated, male, white, middle-class mathematicians does not yield an immediate association with vulnerability. However, given the historical fragility in the relationship between mathematicians and mathematics educators and the novelty of engaging with educational research for our participants, we see the method of Focus Group as one that addresses a type of vulnerability intrinsic to our study.

Furthermore, even though the initiation of the discussion (see set up of Focus Groups in the Data Collection section) originates in us, the researchers, we have deliberately chosen not to provide to the group our interpretation of the data discussed in the meetings and to minimise the unveiling of our interpretations in the course of the meetings. This resonates with the literature on Focus Groups, e.g. with Madriz (ibid.):

...the interaction among group participants often decreases the amount of interaction between the facilitator and the individual members of the group. This gives more weight to the participants' opinions, decreasing the influence the researcher has over the interview process.

(p836)

...the researcher usually dominates the whole research process, from the selection of the topic to the choice of the method and the questions asked, to the imposition of her own framework on the research findings. Focus group minimises the control that the researcher has during the data gathering process by decreasing the power of the researcher over the research participants. The collective nature of the group interview empowers the participants and validates their voices and experiences.

(p838)

Indeed it allows the emergence of diverse voices amongst the group as well (e.g. more and less experienced mathematicians, pure and applied ones (Hersh 1993) etc.).

DATA COLLECTION

There are 12 Cycles of Data Collection, numbered 1-6 (data from this University's team) and 1X – 6X (for data from six other institutions in the UK). Six Data Sets will be produced one for each of the 1/1X – 6/6X Cycles. Provisionally each Cycle of Data Collection will focus on one of the following Themes (but this list is subject to change upon negotiation with the participants):

Theme 1 Formal Mathematical Reasoning I: Students' Perceptions of Proof and Its Necessity

Theme 2 Mathematical Objects I: the Concept of Limit Across Mathematical Contexts

Theme 3 Mediating Mathematical Meaning I: Language and Notation

Theme 4 Formal Mathematical Reasoning II: Students' Enactment of Proving Techniques and Construction of Mathematical Arguments

Theme 5 Mathematical Objects II: the Concept of Function Across Mathematical Topics

Theme 6 Mediating Mathematical Meaning II: Diagrams as Metaphors

For each Cycle a Data Set is produced. A Data Set consists of:

A short literature review on the theme supplemented by a bibliography for further consultation by the group.

Samples of data on the theme (e.g.: students' written work, interview transcripts, observation protocols) collected in the course of the authors' previous projects and doctoral work (e.g. (Iannone & Nardi 2002), (Nardi 1996)). There are usually five sets of examples in each Data Set, each on one mathematical question.

The group is asked to study the Data Set prior to a half-day meeting and be prepared to discuss their responses to the literature and the data sample in relation to their own experiences and views. They are also encouraged to support these views with brief samples of data that they have collected themselves. The Focus Group discussion at the meetings is audio-recorded on a digital sound recorder and the two researchers also bring along further examples to supplement and elaborate the issues raised in the Data Set. At the time of writing Cycles 1 and 2 have taken place and Cycles 3 and 4 have been set up. Volunteering institutions for Cycles 1X-6X have also been identified and the set up of these Cycles is currently in progress.

DATA ANALYSIS

Once a recording is complete, the digital sound file is transferred from the digital sound recorder to a computer and the Research Officer, the second author of this paper, produces a full transcript. Each recording, approximately 200 minutes long, gives a verbatim transcript of about 30,000 words. This text is roughly structured in parts according to the structure of the Data Set. Within each part the structure of the discussion may vary: sometimes the group starts from an epistemological analysis of the mathematical problem in question, including their own ways of responding to it, the question-setter's intentions, the prerequisite knowledge etc. and proceeds to an examination of the student examples and to an address of the general cognitive and pedagogical issues. Of course the conversation shifts backwards and forward from all of the above. As intended by the focus group methodology, the intervention by the two researchers is minimal and mostly of a co-ordinating and sometimes consolidating nature (see Example below).

The above structure, determined to a large extent by the participants but implicitly also dictated by the structure of the handout, has led to an almost natural emergence of Episodes from the text, namely self-contained pieces of conversation with a particular focus. In this paper we present one example of an Episode. In the spirit of data-grounded theory (Glaser and Strauss 1967) it is intended that Episodes will be the analytical units and, on the basis of the experience from Cycles 1 and 2, it is envisaged that from the Cycles of Data Collection 1-6 (plus the supportive data from Cycles 1X-6X) approximately 150 Episodes will emerge.

The two researchers are currently engaged with a first-level analytical triangulation (Jaworski, Nardi and Hegedus 1999) with regard to a consensus on their definition of the Episodes: working independently on a part of the transcript, they aim at achieving an agreement on a breakdown of each part in Episodes. A Story is then written up for each Episode, approximately 500 words long, namely a text which summarises the content as well as highlights the conceptual significance of the Episode for subsequent stages of analysis. A second-level analytical triangulation, regarding the content of the Stories, is also currently in progress.

To exemplify the above and also demonstrate the theoretical perspectives used in the analysis, below we offer an example of an Episode (see introduction below and a compressed version of the transcript in Fig. 1). A preliminary analytical account of the Episode, an expansion of its Story, follows.

AN EXAMPLE FROM CYCLE 1

In the following the participants are four of the five mathematicians of this university's team (renamed as A, B, C and D) and one of the mathematics educators and first author of this paper (renamed as ME).

In this part of the recording, Part III, the group have been discussing a Linear Algebra question which involves proving certain properties of the adjoint (or adjugate) of an $n \times n$ matrix. The expressions to be proved and the proofs themselves involve an extensive use of $\det(M)$, the determinant of a matrix. Almost a quarter of an hour into the conversation, the focus has shifted (the issues thus far have included: the question setter's intentions being about enacting a certain handling of algebraic definitions and properties; typical tendencies in the student responses, such as providing arguments for the 2×2 case and assuming in their proofs properties of determinants hitherto unproved in the course) towards speculating into how students perceive of determinants. Or as A puts it **'what the students actually feel when they do these things. And when you see a determinant how do you... how is one supposed to relate to it?'**

Extract: Cycle 1, 13:54 – 22:06 from Part III (35:08)

A: Is it just a bit of garbage that is sort of coming your way where you have to apply certain rules or are you... do you have a mental image of what it might mean? Do you think of a determinant as a volume or ... (*B offers* 'Something to be worked out'). And then how do you relate? You see when you see ... the adjoint is a cute way of getting the inverse of a matrix. So that could be my way of it. If I see adjoint I think of inverse and I then I would work from there. But that is justified by my requirement that I cannot handle a thing that is very complicated. So... inverse I can just about understand and then I work with that...

D, referring to the case in which the matrix is singular, suggests then that this image 'removes the true power of the adjoint'. A agrees and asks about 'the guidance given to the student' with regard to the ways in which the student will be 'picturing what this is'.

B: This is another example of trying to understand and appreciate ... the student's landscape. Everyone has their own personal landscape... I agree that determinant is a tricky one... even if they have seen it before at school. What I think this is... and I suggested earlier that the determinant might be thought of as a number to be worked out and I am sure that a lot of people think about this when they see an integral. A thing that you have to work out for all pieces involved in it ...

A wonders whether this is 'what you want to instill' in the students, that this is 'something that you have to work out' and B suggests that the students 'can be given some structure'. Given the diversity of images hitherto discussed, asks ME, is there any 'sharing of landscapes' between the mathematicians, who have been 'working with these things for a long time', and their students? D then offers the examples of sharing his images (of the Intermediate Value Theorem and of a 3×3 matrix as a transformation of a three space – 'they find it difficult to imagine that a pure mathematics lecturer can think of a 3×3 matrix as a transformation of a three space, they somehow... for them that is incongruous') with the students. ME suggests a conjecture: the students' attitude originates in the absence of links between the various courses. D agrees, suggests more examples where students were surprised at and at difficulty with how various

concepts ‘could be connected’ and returns to the concept of determinants ‘for cross products and volumes’ which he did not pursue in his lectures (but they will see later, adds C). B suggests that the Linear Algebra problem in question ‘is a good example of an opportunity to make that link between determinants as something which just saves you writing down a large number of elements’. So because, for example, the adjoint can be written out through the assistance of determinants, the students are given ‘an idea of the determinant as an object which just saves writing’, an image that his experience from the lectures suggests that students find helpful. A then returns to the issue of ‘sharing landscapes’.

A: I think that’s the reason why we are still in business, as lecturers. I think that that is what it is about. You are not just communicating facts, you are saying that this is one way you can view it and that is another way you can view it, let’s put these together somehow. And we are sharing such picture somehow...

ME and A insist on the importance of such link construction and D ponders on the difficulty of making such links ‘good’:

D: ... because on the opposite extreme if you think of determinants as cross products and volumes and so on... What the heck is a 4x4 determinant? Yes, of course it is a volume but mathematically you want them to think of an nxn determinant...

A: You see, making the connection I think becomes a personal issue because you need to link your pictures, not somebody else’s pictures and this is quite important. I... I don’t like this forced, you know, networking of all mathematics ... everything relates to everything...(that ‘assumes there’s just one network’ suggests ME). Yes ..., it is currently destructive, it is currently destructive. You need to have your own tailor-made brain version of what the thing is. It will have... it will be a tree, all fits... ordered according to your view. And you need to have ... and you need to do this in your own time, under the instruction or guidance and teaching and not, you know, some ... (*It is no good to impose any one ‘landscape’ on students, closes ME*).

Figure 1.

A PRELIMINARY ANALYTICAL ACCOUNT

Here we focus our examination mostly on the evidence on concept image construction (Vinner & Tall 1981) : the various images of the concept of $\det(M)$, the determinant of an $n \times n$ matrix, held by members of the group as well as their beliefs about the nature of these images.

The discussion on perceptions of the concept of determinant is initiated by A’s ‘a bit of garbage that is sort of coming your way?’, his evocation of an initial image of the concept as vacant of meaning, as devoid of a *raison-d’être* possibly held by students (the obstacles set by such images have been explored e.g. in (Nardi 1999)). Before A launches into an exposition on the type of image that he personally finds helpful, another attempt at exploring student-held images of $\det(M)$ makes its first appearance (and will subsequently become a pivotal one in the course of the conversation): B’s ‘something to be worked out’. We return to this a bit later. A in the meantime describes a *raison-d’être*, a powerful instrumental image (Skemp 1978) for the concept of the adjoint of an $n \times n$ matrix: through the property $\text{Adj}(M)M = \det(M)I_n$ of the adjoint one, under certain conditions, can derive an expression for the inverse of matrix M . The image emerges from his desire (‘justified by my requirement’) for simplicity, itself dictated by his learning need (‘I cannot handle a thing that is very complicated’). D is more hesitant about the potency of this image: ‘it removes the true power of the adjoint’ he proposes. In doing so he introduces a voice of caution with regard to the likely pitfall of fostering

potentially limiting images of the concept. He returns to the difficulty of avoiding this later. His intervention seems to prompt A's question about the role of the 'guidance given to the student' with regard to building images of the concept.

B's subsequent proposition takes this role further: beyond instilling concept images, one needs to try to 'understand and appreciate the student's landscape', a point with a flavour of constructivism in it (von Glasersfeld 1995). He advocates building up images of $\det(M)$ from the students' palpable understanding of it as 'a number to be worked out'. A's response reflects a certain suspicion towards algorithmic images as potential impediments to conceptual understanding (Skemp *ibid.*). B defends the approach as providing 'some structure' for the students.

ME then wonders whether 'landscapes' of images with clearly differing degrees of complexity are 'shared' with the students. D responds with an array of examples and a poignant observation: students find the idea that 'a pure mathematics lecturer can think of a 3×3 matrix as a transformation of a three dimensional space' 'difficult', even 'incongruous'. By reporting the students' resistance to his suggestion of a cross-topical image (one that blends elements of Algebra and Geometry), he initiates a discussion on the limitations of a 'compartmentalised view of mathematics' (used by another mathematician in (Nardi, Jaworski & Hegedus, in preparation)). Returning to determinants, D continues his advocacy for multi-context introduction of new concepts. He proposes viewing determinants in the context of cross-products and volumes – a view which he has not yet put forward in his lectures (but does come later in their studies, as C confirms).

B then returns to his earlier proposition to build subtler yet sturdy instrumental images of the concept on students' initial understandings and proposes $\det(M)$ as 'something which just saves you writing down a large number of elements'. He supports this with uses of this image for writing out the adjoint of a matrix and grounds his belief in his observation of student positive reactions to it in the lectures. A commends the student-centredness of B's proposition for the role of the lecturer as it contributes to building collectively shared landscapes. D's subsequent skepticism ('it is not easy to make it good') highlights a difficulty of the task: if we see determinants in the context of cross products and volumes, what is then a 4×4 , and even further, an $n \times n$ one, the ultimate abstract image that one needs to aspire that the students will eventually come to possess?

In his final comment A makes another, related point of caution (one that also resonates with constructivist views of learning): this image construction is a *personal* venture. A 'forced networking of all mathematics' where 'everything relates to everything' is a futile aspiration that detracts from the 'need to have your own, tailor-made brain version of what the thing is'. The futility lies in the assumption that this 'just one network' can in fact exist, concurs ME perhaps in an attempt to deter the possibility of the skepticism prevailing around the table about the *overall* value of the venture: in any case having a *singular* image cannot be in itself good. In fact it is 'destructive' concurs A. In her final comment ME suggests that imposing any one 'landscape' may not be a commendable aspiration but fostering multiple ones is (Janvier 1987): especially when coupled with the awareness that it is impossible for any one 'landscape' to be comprehensive.

Another central observation we wish to suggest in this account is how the discussion fluctuates creatively between an epistemological analysis of a particular concept (E), to a

psychological one ((Psy) - an exploration of individually held images and beliefs) and, eventually, a pedagogical one ((Ped) - the role of teaching as facilitating the students' concept image construction). It is this spiralling development that our methodology of Episodes/Stories etc. aspires to preserve and highlight benefits of. The way in which the consensus on the role of teaching was achieved by the group at the end of the Extract (E □ Psy □ Ped) can be instructive: through a creative and complementary juxtaposition of personally held views (images of the determinant of an $n \times n$ matrix), a pedagogical strategy is distilled, commonly agreed and firmly owned by the group. In this study, building on recently developed ideas on 'non-deficit' models of teaching (e.g. (Brown et al 1993)) we conjecture that the impact on practice of this sense of ownership has the potential to exceed the impact of externally imposed pedagogical prescriptions.

Furthermore we conjecture that the group's analyses are potent in a more theoretical way too: what is on offer in the data above and, significantly, grounded in the views of practicing mathematicians, is a description of concept image spaces as *dynamic* loci of human cognition. This is a description that enriches the *snapshot-static* ways in which the concept image / concept definition theory, one of the most defining tools of research in the area since its first appearance in the 1980s (e.g. (Vinner & Tall 1981)), is sometimes used.

Finally, *in place of a conclusion* and as an indication of how the analysis of each Episode is re-embedded in the original aims of the study (ultimately we aim at identifying cross-Episode patterns in attitudes, beliefs and practices), we wish to offer some brief observations on certain elements of the interaction between mathematicians and mathematics educators occurring in the Focus Group interviews.

In the extract at least two discreet but distinct roles of the mathematics educator are exemplified. In one occasion she poses a question (about a 'sharing of landscapes' between the mathematicians and their students) which appears to shift the conversation towards a more overt and focused consideration of student needs and teaching practices. In other occasions she repeats some of the words used by members of the group as if to consolidate the views discussed (e.g. when she brings together the comments on the importance of 'link construction'). These two roles, when adopted judiciously, resonate with the relevant descriptions in the literature (e.g. (Madriz 2001)) and with the collaborative aims of the study.

It is possible to argue that, despite a minimal participation of the mathematics educators in the conversations themselves, their presence is conspicuous in the sense that they hold an almost exclusive responsibility for offering the triggers for discussion through the pre-distributed Data Set. As evident however in the data collected so far in Cycles 1 and 2, the vibrancy of the group's views and the enthusiasm with which the members of the group engage in the conversation is helping the content of the conversations escalate beyond the remit of the pre-determined themes. In this sense the Data Set, while offering a concrete, solid basis for discussion, does not appear to be a straightjacket imposed by the researchers on the participants. Indeed the participants, by constantly re-shaping the focus of the discussion, are determining the actual content of the data and eventual focus of the research. They are thus *becoming co-researchers* – which is at the heart of what we believe to be a topical and much needed pedagogical enterprise.

References

- Brown, S. & McIntyre, D. 1993. *Making Sense of Teaching*. Buckingham, Philadelphia: Open University Press
- Ganter, S. L. 2000. *Calculus Renewal: Issues for Undergraduate Mathematics Education in the New Decade*, Dordrecht / Boston / London: Kluwer Academic Publishers
- Glaser, B. G. & Strauss, A. L. 1967. *The Discovery of Grounded Theory: Strategies for Qualitative Research*, New York: Aldine de Gruyter
- Glaserfeld, E. Von. 1995. *Radical Constructivism: a Way of Knowing and Learning* London, Washington D.C.: The Falmer Press
- HEFCE. 1996. *Mathematics Learning and Assessment: Sharing Innovative Practices*. London: Arnold
- Hersh, R. 1993. Proving Is Convincing and Explaining. *Educational Studies in Mathematics*. v24 n4 p389-99 1993
- Holton, D.A. 2001. *The Teaching and Learning of Mathematics at University Level: An ICMI Study*. Kluwer Academic Publishers
- Iannone, P. & Nardi, E. 2002. A Group as a 'Special Set'? Implications of Ignoring the Role of the Binary Operation in the Definition of a Group, *Proceedings of the 26th Annual Conference of the International Group for Psychology in Mathematics Education*, 21-26 July 2002, Norwich, UK Volume 3, p121-128
- Jalling, H. & Carlsson, M. 1995. 'An Attempt to Raise the Status of Undergraduate Teaching', *Studies of Higher Education and Research* No 1995: 2/3
- Janvier, C. 1987. *Problems of Representation in the Teaching And Learning of Mathematics*, Hillsdale, NJ: Erlbaum
- Jaworski, B., Nardi, E. & Hegedus, S. 1999. 'Characterising Undergraduate Mathematics Teaching'. p.121-128. In Zaslavsky, O.(ed.) *Proceedings of the 23rd Annual Conference of the International Group for Psychology in Mathematics Education*, Volume III. Technion University, Israel
- Kahn, P. E. & Hoyles, C. 1997. 'The Changing Undergraduate Experience: a Case Study of Single Honours Mathematics in England and Wales'. *Higher Education* 22 (3), 349-362
- London Mathematical Society. 1995. *Tackling the Mathematics Problem*. London, LMS
- Madriz, E. 2001. Focus groups in feminist research, in *Handbook of Qualitative Research*, second edition, edited by N K Denzin and Y S Lincoln
- Mason, J. 2002. *Mathematics Teaching Practice: A Guide for University and College Lecturers*. Horwood Publishing Series in Mathematics and Applications
- Nardi, E. 1996. *The Novice Mathematician's Encounter With Mathematical Abstraction: Tensions in Concept-Image Construction and Formalisation*. Unpublished doctoral thesis. University of Oxford
- Nardi, E. 1999. The Novice Mathematician's Inquiry About New Concepts: Bestowing Meaning Through Ambivalent Uses of Geometrical Metaphors. p57-68. In BROWN L (ed.) *Making Meanings in Mathematics*, a collection of extended and refereed papers from BSRLM - the British Society for the Research into Learning Mathematics. QED Publications: York
- Nardi, E. & Jaworski B. 2002. Developing a Pedagogic Discourse in the Teaching of Undergraduate Mathematics: On Tutors' Uses of Generic Examples and Other Pedagogical Techniques, *Proceedings of the 2nd International Conference on the Teaching of Undergraduate Mathematics*, 1-6 July 2002, Crete, Greece. Available on CD ROM and at <http://www.math.uoc.gr/~ictm2/>
- Nardi, E., Jaworski, B. & Hegedus, S. In preparation. From 'natural' but 'silly little tricks' to 'arsenal of techniques': A Spectrum of Pedagogical Development for the Teaching of Undergraduate Mathematics, revision to be submitted to *Journal for Research in Mathematics Education* by 30 June 2003
- Skemp, R. 1979. *Intelligence, Learning and Action*, London: Wiley
- Vinner, S. & Tall, D. 1981. 'Concept image and concept definition in mathematics with particular reference to limits and continuity.', *Educational Studies in Mathematics*, 12, 151-169
- Wagner, J. 1997. 'The Unavoidable Intervention of Educational Research: A Framework of Reconsidering Researcher-Practitioner Cooperation.', *Educational Researcher*, 26 (7). 13-22
- Wilson, V. 1997. Focus Group: a useful qualitative method for educational research?, *British Educational Research Journal*, vol. 2, n.2, 209-225

LEARNING IN AND FROM PRACTICE: PRE-SERVICE TEACHERS INVESTIGATE THEIR MATHEMATICS TEACHING

Cynthia Nicol and Sandra Crespo

University of British Columbia, Vancouver, Canada and Michigan State University

This study examines the learning of five pre-service teachers investigating a question stemming from their mathematics teaching as part of a final course project in their elementary teacher education program. Analysis of video recordings of group meetings and interviews indicate that as pre-service teachers completed their projects they developed a relationship with the discipline of mathematics and of teaching mathematics that included the inclination to seek conceptual understanding and pursue a stance of inquiry. This study builds on our understanding of connections between knowledge, practice, and identity and how a teacher education program can offer possibilities for pre-service teachers to negotiate new identities as mathematics teachers who can learn in and from practice.

INTRODUCTION

Many teacher educators and students would agree with Lampert and Ball's (1998) statement that, "overall teacher education has been a weak intervention on the powerful images, understandings, beliefs, and ways of thinking that prospective teachers bring with them from their prior experiences as students" (p. 24). One way of addressing this issue is to consider how teaching practice can be a context for learning to teach mathematics. Ball and Cohen (1999) speak about this in terms of learning *in* and *from* teaching practice. They argue for a broad view of "in practice" to include not just that which occurs in the classroom but all that is critically necessary in the activity of teaching. Practice in this sense is not specific to a particular place, nor to physical actions over mental ones, but instead to the explicit and the tacit activities that teachers have developed in order to teach (Wenger, 1998).

Research on professional development provided to practicing teachers that focuses on helping teachers learn in and from practice includes opportunities for teachers to examine students' thinking (Schorr & Alston, 1999; Vacc, Bowman, & Bright, 2000), reflect on teaching practices (Schifter, 1996), develop or discuss teaching cases (Barnett & Tyson, 1999), or participate in teacher study groups (Stigler and Hiebert, 1999). This research shows promise toward enhancing teachers' understanding of mathematics and pedagogy and how teachers use this knowledge to inform their teaching. However, we know less about how we might support beginning teachers to learn in and from practice. Some recent research focuses on introducing new technologies in mathematics teacher education as a resource for inquiry into practice or on integrating field-based experiences into mathematics curriculum and instruction courses (e.g. Lampert and Ball, 1998; Crespo, 2000; Nicol, 1999). Our study builds on this work to examine the learning that occurs when pre-service elementary teachers are given opportunities to investigate their own mathematics teaching practice.

THEORETICAL CONSIDERATIONS

Wenger (1998) provides a social theory of learning within communities of practice that we find useful for our work. A community of practice, according to Wenger, has coherence through the dimensions of mutual engagement and shared activities, a joint enterprise or shared goals, and a shared repertoire of social and physical resources that can be used to meet the negotiated goals. A community of practice could be, for example, a group of pre-service teachers teaching in the same school who come together to understand their practice. Wenger argues that learning involves the development of identity, the changing of who we are, in the context of the communities of practice that we participate in. He states: "Because learning transforms who we are and what we can do it is an experience of identity. It is not just an accumulation of skills and information, but a process of becoming—to become a certain person or, conversely, to avoid becoming a certain person" (p. 215). Our identities, then, are shaped and formed by our participation or non-participation in various practices which, in turn, shapes our communities of practice. Developing an identity in practice is a constant process of negotiation. "We are always simultaneously dealing with specific situations, participating in the histories of certain practices, and involved in becoming certain persons" (Wenger, 1998, p. 155).

Boaler and Greeno (2000) draw upon the work of Wenger (1998) and others to examine how high school students' knowing of mathematics can be understood as participation in particular social practices. In their interviews with students enrolled in advanced placement calculus courses they found that some were not interested in pursuing mathematics as a field of study because the requirements of the social practices in which they participated as mathematics learners were in conflict with the type of person they wanted to be. That is, these researchers found that different classroom practices encourage students to develop different relationships with the discipline of mathematics that profoundly influence their interest in and learning of mathematics (Boaler, 2002).

Ma's (1999) research is helpful in considering teacher's relationships to the discipline of mathematics. In interviews with experienced elementary school teachers in China, Ma found that these teachers had not only developed understandings of fundamental mathematics that were deep, broad, and thorough but also displayed various mathematical attitudes. Chinese teachers sought to "know how to carry out an algorithm and to know why it makes sense mathematically" (Ma, 1999, p. 108). These teachers shared a disposition to ask why and to explore the mathematical reasoning underlying mathematical procedures. They had developed a relationship with the discipline, to use Boaler's (2002) concept, that included the expectation that claims be justified with mathematical arguments and that problems be approached in multiple ways. They saw themselves as participating in a teaching practice that required not only strong procedural and conceptual understandings of mathematics but also the need, ability, and importance of conveying these understandings to students. Chinese teachers developed this relationship through teaching in a community of practice that valued and expected their participation in certain practices such as examining curriculum materials, working with colleagues, learning mathematics from students, and doing mathematics themselves. An important aspect of this research and of Boaler (2002) and Wenger's (1998) is that it

brings together learning, practice, and identity. It highlights how social practices, disposition and identity influence what teachers know, how they know it, and how they share their understandings with students. Our research builds on this work as we explore how we might design instructional environments that help beginning teachers develop a relationship to the discipline of mathematics and to the practices of teaching that enables them to learn in and from practice.

RESEARCH CONTEXT AND DESIGN

The Context

The context for this study is a Problem-Based Learning [PBL] cohort in a 12-month elementary education program for post-baccalaureate students at the University of British Columbia. Following the philosophy of problem based learning, students work in a small groups with a tutor to examine cases of teaching and learning. A final assignment for PBL students toward the end of their program is to construct and respond to their own written case of teaching and learning. This study focuses on a small group of PBL students who were invited to use their teaching practice as a context for their final case project and were provided with opportunities and support to use new technologies as a resource to do this.

Participants

This paper focuses on the experiences of five pre-service teachers in the 2001 -2002 PBL cohort who chose to explore a question related to mathematics teaching for their final case project. Participants were female ranging in age from mid 20's to early 30's. During their 13-week extended teaching practicum they met regularly, about every two weeks, as a group to discuss their teaching and the kinds of issues or problems they considered researching as part of their final case project. They were given access to laptop computers and digital video cameras so that they could collect and edit video clips of their teaching, interview pupils and teachers, and document student work. During the group meetings students used the technology not only to develop aspects of their final case projects but to also share teaching episodes or pupil's thinking in order to collectively help each other interpret and make sense of their teaching. After the practicum pre-service teachers were given three weeks to produce and respond to a case of teaching and learning. They had no other program responsibilities at this time.

Data Collection and Analysis

Data sources include: video excerpts of group meetings with pre-service teachers; transcripts of individual interviews with pre-service teachers as they began their case projects and again as they completed them, and pre-service teachers' completed cases produced as webpages. Case projects were analyzed for the kinds of questions investigated and how pre-service teachers carried out those investigations. Their reflections on the process of creating their case were drawn from data collected during the practicum, through the interviews, and from their case projects. These data were analyzed using Wenger's (1998) concept of identity in terms of pre-service teachers' developing ideas about mathematics, how they saw themselves teaching mathematics, the role of inquiry in their teaching, and how each of these developed as they constructed

their cases. Data were analyzed using direct interpretation of student responses across the development of their case projects (Stake, 1995).

RESULTS AND DISCUSSION

Framing and Investigating a Question

Pre-service teachers in this study chose to focus their cases around a question or issue stemming from their experiences teaching mathematics in the practicum. Their questions focused on issues of mathematical communication and dispositions, promoting conceptual understanding or numeracy, and designing meaningful curriculum integration with mathematics. Jan, curious as to why her Grade 1 and 2 students were more creative problem solvers in science than mathematics posed the question: How can I develop students' mathematical dispositions? While Nat, noticing that her students rarely spoke during mathematics class asked: How can I improve my students' mathematical communication so that enhanced student learning can occur? These case questions are not questions which framed action research cycles or teacher research projects but are instead broad questions posed by pre-service teachers that stimulated their thinking about how they were and how they might help their students' learn mathematics.

In responding to these questions some pre-service teachers used video clips of their teaching and student thinking as a way of interpreting their question. Tes, for example, skeptical for how mathematics might be meaningfully learned through other disciplines, created a short video clip of her teaching an "integrated math lesson" and shared this with her peers, teachers, and teacher educators asking for their response to the questions "Is this curriculum integration? and What significant math do you think students' are learning?" Collecting this kind of information, together with an examination of the research literature on conceptual understanding, Tes was able to re-conceptualize what curriculum integration could be and how it might look in the mathematics classroom. Pre-service teachers' case reports were a collection of video clips and text built as a webpage with interactive links and opportunities for more public shared discussion. Some pre-service teachers used video clips to support their text while others used text to support their analysis of video clips.

Imagining new Possibilities as Learners and Teachers of Math

Analysis of pre-service teachers' comments collected during group meetings, their reflections contained in the case reports, and interviews conducted as they began their extensive response to their cases indicate that all pre-service teachers were somewhat apprehensive about pursuing a project that focused on mathematics education. All five pre-service teachers stated that they earned good marks in high school mathematics and two stated they were in advanced math groups in elementary and high school. Yet, all said they did not enjoy learning or doing mathematics. Most spoke about their lack of passion in learning mathematics compared to learning in other subject areas. Nel's comments are representative of others when she states "My experience in other areas, such as English, was more open-ended [than math], there was room for your opinions and what counted was how you justified them. In math it was either right or wrong, black or white. It was so contrived." When asked why they focused their projects on questions of mathematics teaching most stated that they saw it as an opportunity to improve their

teaching of math. No pre-service teacher spoke about it as an opportunity to improve her own understanding of math.

Comments made by participants toward the end of their projects and in the final interviews suggest that as they researched their questions they extended their views of themselves as mathematics learners. Most commented that they now recognize not only the importance of their attitude toward math but also the importance of their own understanding of math for teaching. Through an analysis of student interviews and their teaching, pre-service teachers came to see the need to enrich their own knowledge of math. Nel, for example, reports that from watching her interviews with students she "realized [that] if I want to ask students open-ended questions then I need to have a broad range of knowledge and solid math background. Not just knowing how to do things but being able to find the math so that I can ask creative questions." While Tes states: "I need to have a deeper understanding of math itself so that I can understand what students are saying and doing." These comments indicate that in the development of their case projects, pre-service teachers found opportunities to extend their understanding of math. Although, only two of the five participants pursued these opportunities in an in-depth way, all spoke about wanting to continue learning more about the math they were expected to teach. What is significant is that pre-service teachers did this in a way that they found exciting and engaging. Their desire to deepen their understanding of math came not with anxiety but with curiosity and commitment to make sense of their students' thinking and provide meaningful tasks that promote student understanding.

As their projects progressed participants also began to consider new possibilities for themselves as mathematics teachers. Many spoke about the importance of conceptual understanding and their interest in helping students communicate their thinking. Tan, for example, interested in helping students "use math to help them understand their world better" explored how she might help students learn math through a study of social issues such a poverty. Tes, as with others, began to see possibilities for teaching mathematics that they had not seen while in the practicum. Many described the project as "life altering" for offering new ways of thinking about their teaching and envisioning themselves as teachers. They explored mathematical connections, issues, and problems they had not considered while they were teaching. In summarizing her experiences with the project Nel wrote: "The project was so amazing because I don't see myself as the same teacher anymore."

Becoming Inquiring Teachers of Mathematics

An analysis of pre-service teachers' discourse during the development of their projects and in the final interviews highlights their increased awareness of the need to make sense of teaching. Many mentioned that during the practicum they were unable to think deeply about their teaching. They referred to the usefulness of the group meetings where they shared video clips of their teaching. Yet, when they were teaching they considered these meetings and discussions as "add-ons" to their practice rather than part of their practice. Others spoke about the value of sharing and analyzing video clips within a community and the possibilities these offered in "seeing things differently" or in "making it okay to take a risk to learn something new." Pre-service teachers' commitment to their

investigation of teaching is evident in their repeated comments that the project "totally occupied" or "consumed" their thoughts. Further evidence is seen in their desire to continue their investigations and pursue questions (e.g. the relationship between mathematical disposition and gender or the nature of mathematics curriculum that fosters narrow thinking) that they did not have a chance to address in their case projects.

Conclusion

The results of this study provide insight into the development of pre-service teachers' learning about mathematics, pedagogy, and inquiry. Studies of experienced and prospective teachers' subject-matter knowledge indicate that teachers require a rich and connected understanding of the mathematics they will be teaching in order to teach well. Ma's (1999) research suggests that teachers can develop their understanding of mathematics for teaching over their teaching careers as well as develop productive attitudes, such as an inclination to pursue conceptual understanding of a concept, seek alternative solutions to problems, and require mathematical reasoning to justify. All students in our study spoke about their interest in developing their own understanding of mathematics and the need for this in order to better understand and hear their students' thinking as well as create meaningful problems for their students to explore.

The results of our study indicate that with an investigation of their own teaching pre-service teachers came to develop a different relationship to the discipline of mathematics. Rather than seeing mathematics as uninteresting and disconnected it became a place of curiosity and intrigue as they sought to make sense of their students' mathematical work. Their identities of themselves as learners of mathematics were being shaped to include the desire to make sense of mathematics, pursue multiple solutions to problems, and make connections within and beyond the discipline. This was intricately tied to their images of themselves as mathematics teachers. Pre-service teachers recognized that with a deeper understanding of mathematics they were able to see possibilities for teaching mathematics that had previously gone unnoticed. Although pre-service teachers discussed how their case projects profoundly changed their views of mathematics, teaching mathematics, and what is involved in making sense of teaching, how they use these new understandings and attitudes in their practice as beginning teachers is an area for further research. That is, how these identities as learners and teachers of mathematics continue to be negotiated as these teachers participate in the culture of schools is an important question.

Pre-service teachers in this study chose mathematics as an area to investigate. They were likely ready to, as Jan, said "take the risk" and study an area that was not their strength or first interest. This raises questions on how we might provide opportunities to engage other students who may not be as ready or willing to take this risk. Participants in this study were also unique in that the tools offered as resources for their learning. They had opportunities to form a community of practice that valued the investigation of teaching. They sought each other's ideas and suggestions in their attempts to make sense of their teaching. They engaged in discussion, debate, and pursued different points of view as they shared clips of their teaching with each other. Participating in this community provided opportunities for negotiating identities, of providing new visions of who they

are as learners of mathematics, how they imagine themselves as teachers in relation to others, and how they see themselves as students of teaching.

Certainly access to new technologies as resources for their learning was a factor shaping this community of inquiry. Collecting digital video clips, editing these, and making short movies to share with others structured the kinds of discourse and inquiry questions pursued by participants. Three of the five pre-service teachers spoke about how different their work on this project was from their previous teacher education experiences. They did not consider their previous teacher education work as an opportunity for in-depth critical reflection. Nor was the practicum a place for such learning. Instead, pre-service teachers found they were best able to learn in and from practice with opportunities to collect evidence or artifacts of their teaching and with time afforded them after the practicum to discuss and research issues related to these.

This study shows that pre-service teacher education can have a profound influence on students' understanding of mathematics and pedagogy as well as their inclinations to learn mathematics and study mathematics teaching. This study provides insight into the possibilities of providing pre-service teachers with support and time to participate in a community of inquiry, to negotiate identities as inquiring teachers, and to include inquiry in their lives as teachers. Building on Boaler's (2002) work and Ma's (1999) research, this study emphasizes the interconnectedness of knowledge, practice, and identity, and points to the possibilities teacher education can offer in helping pre-service teachers develop a relationship to the discipline of mathematics and of teaching mathematics that involves learning in and from practice.

References

- Ball, D. L. & Cohen, D. (1999). Developing practice, developing practitioners: Toward a practice-based theory of professional development. In L. Darling-Hammond & G. Sykes (Eds.), *Teaching as the learning profession: Handbook of policy and practice*, (pp. 3-32), San Francisco, CA: Jossey-Bass.
- Barnett, C. & Tyson, P. (1999). Case methods and teacher change: Shifting authority to build autonomy. In M. Lundeborg, B. Levin, & H. Harrington (Eds.), *Who learns from cases and how: The research base for teaching and learning with cases*, (pp 53-69). Mahwah, New Jersey: Lawrence Erlbaum.
- Boaler, J. (2002). The development of disciplinary relationships: Knowledge, practice, and identity in mathematics classrooms. In A. Cockburn and E. Nardi (Eds.), *Proceedings of the 26th Conference of the International Group for the Psychology of Mathematics Education*, Vol 2, pp. 113-120. Norwich, UK: University of East Anglia.
- Boaler, J., & Greeno, J. (2000). Identity, agency and knowing in mathematics worlds. In J. Boaler (Ed.), *Multiple perspectives on mathematics teaching and learning* (pp. 171-200). Westport, CT: Ablex.
- Crespo, S. (2000). Seeing more than right and wrong answers: Prospective teachers' interpretations of students' mathematical work. *Journal of Mathematics Teacher Education*, 3, 155-181.
- Lampert, M. & Ball, D.L. (1998). *Teaching, multimedia, and mathematics: Investigations of real practice*. New York: Teachers College Press.

- Ma, L. (1999). *Knowing and teaching elementary mathematics: Teachers' understanding of fundamental mathematics in China and the United States*. Mahwah, New Jersey: Lawrence Erlbaum.
- Nicol, C. (1999). Learning to teach mathematics: Questioning, listening, and responding. *Educational Studies in Mathematics*, 37(1), pp. 45-66
- Schifter D. (1996). *What's happening in math class? Envisioning new practices through teacher narratives*, (Vol 1). NY: Teachers College Press.
- Schorr, R. & Alston, A. (1999). Teachers' evolving ways of thinking about their students' work. In F. Hitt and M. Santos (Eds.), *Proceedings of the 21st Annual Meeting of the North American Chapter of the International Group for the Psychology of Mathematics Education*, (pp. 778-784). Cuernavaca, Mexico: Universidad Autonoma del Estado de Morelos.
- Stake, R. (1995). *The art of case study research*. Thousands Oaks, CA: Sage.
- Stigler, J. & Hiebert, J. (1999). *The teaching gap: Best ideas from the world's teachers for improving education in the classroom*. New York: Free Press.
- Vacc, N., Bowman, A. & Bright, G. (2000). Teacher change in the context of Cognitively Guided Instruction: Cases of two novice teachers. In M. Fernandez (Ed.), *Proceedings of the Annual Meeting of the North American Chapter of the International Group for the Psychology of Mathematics Education*, 22, Eric Document: ED446945.
- Wenger, E. (1998). *Communities of practice: Learning, meaning and identity*. Cambridge, Cambridge University Press.

MENTORING TEACHING OF MATHEMATICS IN TEACHER EDUCATION

Vivi Nilssen

Faculty of Teacher Education and Deaf Studies, Sor-Trondelag University College,
Trondheim, Norway

The paper is based upon a case-study of mentoring in teacher education in Norway. It describes the practice of the cooperating teacher and how mentoring in the practice-field contributes to student teachers learning. The main focus is how student teachers develop pedagogical content knowledge in mathematics through reflections with the mentor about their teaching episodes. The study draws attention to how Vygotsky's and others ideas about scaffolding and assisting in the Zone of Proximal Development (ZPD) can be useful in understanding how student teachers learn to teach mathematics. This paper specially focuses the role of imitation and modelling.

INTRODUCTION

This case study tells the story of a cooperating teacher¹ named Erik and his student teachers². It is interesting to see how these student teachers plan for interactive teaching over and over again. We know that student teachers have problem with handling this interactivity (Doyle 1977, Nilssen, Gudmundsdottir & Wangsmo-Cappelen 1996) and that mentors contribute to avoiding them because they are eager to ensure that the student teachers' lessons go smoothly (Edwards 1998). A hundred years ago Dewey (1904/1965) gave a warning about letting immediate skill be got at the cost of power to go on growing.

Though interactive teaching is difficult for novices in any subject, it seems to be even more true in mathematics. Several studies show that student teachers try to avoid interactivity, or even worse they think such teaching strategies do not belong in mathematics lessons. Those lessons should be quiet places where the teacher first explains what to do, and then the pupils work individually solving problems the way the teacher wants them to (Ball 1988, 1991, Calderhead & Robson 1991). Such working methods are far from both The Norwegian National Curriculum (L-97) and from the mathematics teaching the student teachers meet in Erik's classroom.

The essence of Erik's teaching method is that children solve problems using their knowledge and experience, that is, they develop their own strategies for solving math problems. The children explain their strategies to the teacher and to each other, and all strategies are accepted. Gradually they develop a common understanding and an effective way to handle problems. When studying mathematics at the teacher training college, the

¹I will use the word mentor when I talk about Erik because we can think of mentoring as helping someone to learn to teach in the context of teaching (Feiman Nemser & Beasley 1997, Collison & Edwards 1996).

² In Norway the students in the first year of the Teacher education programme for primary schools, practise in a school for two periods, each of them consisting of three weeks. 4-5 students are in the same class and have the same cooperating teacher. The cooperating teacher functions as their supervisor or mentor. During this period they have little contact with the teachers at the teacher training college.

students meet this new way of seeing the subject. It is not guaranteed that they will do so in their field practice though The ministry of education emphasise that it is necessary to ensure a good connection to the practice field.

METHOD

The field work in this study is done during a three week period in the practice field³. Erik and his student teachers were followed both in the classroom and in the mentoring processes. Data were collected in different ways, observations in the classroom, video recordings of the mentoring processes and interviews with the mentor and the student teachers. Some of the interviews were video interviews. That is interviews taking place while the mentor and I are looking at the video recording of the mentoring. Both interviews and the video recordings were transcribed. The compiled data were categorized through analysis and interpretation. In this process the use of theory plays an important role. Below I present one of the categories I've found regarding Erik's mentoring, the category of *modelling*.

THEORETICAL FRAMEWORK

The work of Vygotsky is well known, and in my opinion it offers a frame of reference to understand mentoring as well as teaching. Vygotsky argues that teaching (or mentoring, my comment) is good only when it "*awakens and rouses to life those functions which are in stage of maturing, which lie in the zone of proximal development*"⁴ (1956, p.278, here in Wertsch and Stone 1985, p.165). Vygotsky has defined this zone as "*the distance between the actual development level as determined by independent problem solving and potential development as determined through problem solving under adult guidance or in collaboration with more capable peer*" (1978, p.86).

In informal situations we learn a lot from imitations. According to Vygotsky "*a full understanding of the concept of the zone of proximal development must result in reevaluation of the role of imitation in learning*" (1978, p.87). We have to reconsider imitation as a starting point for learning. It is a sign of development when one imitates and get help from others. Imitation can be understood as a constructive process because what is imitated is chosen by the individual, it is something the individual wants to do. This aspect of Vygotskys theory is a useful way of approaching mentoring in the practice field because the student teachers often imitate methods they see in use by others (Ball 1991). Often they experience that they do not succeed because of lack of necessary knowledge (Nilssen et.al 1996, Campbell & Kane 1996).

Several studies show how student teachers develop their pedagogical content knowledge through reflection on episodes together with more capable persons. (Feiman-Nemser 1983, Grossmann 1989, Grossmann & Richert 1988, Shulman 1987). Mentoring in the practice field is a part of the Teacher education programme which is performed by a more capable person. The intermental process which takes place between the student teachers

³ Erik is one of three cooperating teachers participating in the study.

⁴ ZPD

and their mentor is of crucial significance to how the student teachers manage to bring their potential in use and make it part of their own teaching.

Tharp and Gallimore (1988, p.31) derive from Vygotsky that “*Teaching (or mentoring) consists in assisting performance through the zone of proximal development. Teaching (mentoring) can be said to occur when assistance is offered at point in the zone of proximal development at which performance requires assistance.*” Assistance of performance in the ZPD has been described as *scaffolding* by Wood, Bruner and Ross(1976). Scaffolds enable novices to perform a task which lies in the ZPD. Building scaffolds around a student teacher’s learning process is a balancing act between giving them real challenges, and ensuring that they can meet the challenges and not give up. But first of all the student teachers need to get interested in the task, called *recruitment* by Wood, Bruner and Ross (1976). Tharp and Gallimore (1988) have identified a similar form of assisting, the process of offering behaviour for imitation which they call *modelling*⁵. The understanding of the ZPD has been strengthened by the work of Wertsch (1984) and his identification of important conceptions. *Situation definition* is the way a situation is defined and understood. When persons share the same definition and are aware of it *intersubjectivity* occurs. This creates a common basis for communication.

RESULTS

Ole has finished his first lesson with division in class five (the pupils are 10 years old), and in the post-conference⁶ his first comment is that he felt it difficult because “I’m not feeling confident enough, and the pupils? – I thought they were restless”. Erik follows up by asking if there was something he felt was a success. Ole finds it difficult to answer, but by pushing him a bit Erik gets an answer, “I got them quite active, they took part in the learning”(vidobs3).

Erik’s next answer leads to this dialogue (1):

Erik: Aren’t we now talking about the same thing you thought were difficult? That’s when you thought the children were most active?

Ole: Yes, it was when I should explain this I thought it was hard

Erik: If we look at the children’s experience from the lesson, how do you think it was?

Ole: Probably it was fun

Erik: What made it fun?

Ole: Maybe that they could participate themselves?

Erik: Why did you experience that as difficult, their own participating?

Ole: No, it was not their participating which was difficult

Erik: I see, it was during the summary when they should explain their methods?

Ole: Yes

What Ole is describing here is a situation he will often meet when he is following his view on children and mathematics. How did he get into this situation? I think I will go back to the beginning.

⁵ Both Tharp & Gallimore (1988) and Wood, Bruner & Ross (1976) have identified several ways of assisting in the ZPD. In this paper I focus on imitation and modelling. In a paper presented at AERA 2002 I discuss other ways of scaffolding in the ZPD.

⁶ Erik is using a model for mentoring with pre-conference before the teaching and post-conference afterwards

Two of the student teachers have made a sketch for the division topic which they present to Erik and the other two students. Through comments like “We’ll let 20 other be part of the discussion, too” (vidobs2) Erik reveals that the pupils are important. Erik stresses this because his experience is that the student teachers are so concerned about their own achievements that they forget the pupils (aint20.3.). When the student teachers were in Erik’s class half a year earlier they observed what he was doing in the class. He talks about his first meeting with them this way:

They were incredibly nervous, they were really scared when they arrived, and in the first lesson I did it this way: I had a lesson where I made a good planning document and talked about the background ...and when they got a topic so firstly, they could in a way copy some, they could choose to, new topic, yes, but it could be put in the same pocket, they could use some methods, the sequence of operations, and they did and then they succeeded, it is not sure they will succeed but they’ll feel safer and they don’t have to plan from nothing....(aint20.3.,avint22.3.)

The student teachers’ planning this period shows that they have seen ways of teaching mathematics, ways that they are eager to test. Erik asks if Ole wants to take the first lesson because he has been thinking through the division topic. Ole agrees, and so he gets into the experiences that I reported in the beginning of the text (vidobs2).

In the class room Ole places the pupils on benches with their faces towards the blackboard. First Ole has a conversation with the pupils making attempts to capture what they know about division. They talk about the sign and what it is all about. Ole then gives groups of pupils (3 in each) 21 cubes and tells them to share. After doing this he tells them to explain how they did it. Here are some of the answers and Ole’s responses:

Group 1: We remembered that 7 times 3 is 21 and it is 21 here (On the board Ole writes $3 \times 7 = 21$)

Group 2: First we took three, then three, and so on

Group 3: Vi tried first, 6 and 6, 6 and 6, that is 24, too much

Ole: By trial and error?

Group 4: We counted like 3,3,3,3 (A girl is asking if it is suitable to use the square root)

Ole: You divided into parts of three? If I’ve understood it right two of the groups did the same? (He shows by splitting into parts of three)

Group 1: We did not divide like this, no, we divided into parts of seven

Ole tries to summarise by saying that both are right, it depends upon the question being asked⁷ He gives more exercises by increasing the amount of cubes, 25 cubes, 26 cubes and at last 30. In answering how they did it some of the groups use the same strategies as with 21 cubes. Some of the pupils begin to talk about fractions and decimals, and ask if they can write on the board. Ole allows them to do so. He sees that it is not correct, and tries to explain, but suddenly he tells them to do exercises (obs20.3.).

Now we are back where we started. Ole’s feeling of not being successful comes from the part of the lesson where the children show how they find the answer on problems by dividing cubes. In the post-conference Erik follows up dialogue (1) by saying:

I think you did this quite well, you are a first grader, you know. The children are active and that makes it difficult. Then they are going to describe a method and that is not easy for the

⁷ Ole means the difference between $21:7$ and $21:3$, but he doesn’t show the pupils what he means

teacher to understand, to grasp, and then you are going to explain back and that is difficult, too. It is a difficult way of working. I'll give you a tip, observe the children when they are working. You can observe some of the groups, and after a while you'll manage to observe some more. If you have looked at them you will understand better what they are telling you. (videobs3)

Erik asks the other students about their opinion of the way Ole introduces division (Dialogue 2).

Sara: Nice to do by themselves...find out...they have to think and not just sit watching, repeating it (for the other pupils) will make them more conscious.

Erik: How do you think this will affect their mathematical learning?

Sara: They have to understand what is going on.

Mari: Get it into fingers and head will make it their own before they get to the algorithm, but I can see that using concretes create restlessness,

Erik: I did not experience the situation as chaotic, I experienced it as activity...(to Ole) I see that there is the part you feel you did not succeed, but you did not master it badly...it is difficult because the pupils didn't explain that well and you haven't seen it... so what could Ole have done? To make sure he gets the right description?

Mari: Did they just talk? (Mari did not follow the lesson) They could have used concrete materials.

Erik: Like "Come here and show me"? That would have been a way of ensuring your understanding. Another thing you manage very well, when they explain and you don't understand, you don't give up at once, you really wanted to understand, and when you don't you get distressed. That is an important attitude

Ole: I couldn't ask once more, that would be embarrassing.

Erik: That's when you next time says, come up and show me.

Ole: Yes, I should have done so

Erik: That's things you have to learn...I think you managed to catch many different ways of solving the problem (vidobs3).

DISCUSSION

Wood et al. (1976) point out that the first step of scaffolding is *recruitment*, it is necessary to get persons interested in the task. Erik manages to get them interested by giving student teachers the opportunity to watch him and his class. They get a chance to see how teacher and pupils react upon each other, or as Dewey says, how mind answers to mind (Dewey 1904/1965). Erik has thus been offering behaviour for imitation, defined by Tharp and Gallimore (1988) as *modelling*. They draw attention to modelling as an important part of the scaffolding process. Both recruitment and modelling have the same function, a possibility of imitation. Erik is not only offering behaviour for imitation. By inviting them to take part in his planning, they also learn about the ideas lying behind, why he teaches the way he does and what his aim is. They gain access to his pedagogical reasoning. Dewey stresses the importance of giving the student teachers the possibility to observe not only the technical aspects of teaching, not only observe that this method works, but to know how and why it works (Dewey 1904/1965). This is necessary for student teachers to understand and to overcome the apprenticeship of observation (Lortie 1975). The student teachers imitate what they have seen, and according to Vygotsky (1978) it must be seen as a constructive and selective process as well as a sign of a developmental process. This is an important part of Erik's assisting performance.

As pointed out by Wertsch (1984) establishing a joint *situation definition* is crucial for the further dialogue. We can see how Erik is doing so by drawing attention away from the restless problem and focusing on the childrens learning in dialogue (1) . First of all it is important to ensure that they are talking about the same, that they share the same understanding and know that they do. But Erik also wants to draw attention to the children, an important aspect of pedagogical content knowledge (Shulman 1987). Erik chooses to have focus on the pupils' learning and in dialogue (2) we can see how he reinforces this. He also wants Ole to feel the success he deserved. Erik has offered teaching for imitation, and it is his job as a mentor to give support in a way that the student teachers can meet the challenges and not give up. When the student teachers are able to see the situations from outside and not so emotional, often negative, they will be in a better position to analyse what is really happening. Erik helps Ole to see that the pupils were active and not restless. This opens up for another conversation. Edwards and Collison (1996) strongly recommend to de-centre the student teachers' performance.

In the post-conference Erik tells the student teachers what *he* did in Ole's lesson. He *demonstrates* (Wood et al.1976) how he acts while pupils work to ensure he is capable of understanding their explanations. Afterwards Eriks asks if there are other suggestions to how Ole can get some more information from the pupils. In dialogue (2) we see the other student teachers take part in the discussion, and come up with other suggestions.

Maynard (1996) found that mentors often lack subject knowledge in certain curriculum areas. The mentors expressed that their contribution would be on developing student teachers understandings of child-centred approaches to teaching and pupil learning in the subject. That is no doubt an important part of pedagogical content knowledge. Through this study we can see how Erik manage to help student teachers make important experiences of a difficult teaching method in mathematics. He uses various kinds of scaffolding techniques⁸, but through the whole process he *models* a teaching mode where he is focusing on the pupils' learning of mathematics. And by using and managing such an interactive teaching mode the student teachers can learn much about differences in children's problem solving.

The cooperating teacher as a role model or a basis for imitation has not been well accepted in the teacher education programme in Norway during the last two decades (Skagen 2000). This study shows the importance of giving the student teachers the possibility to imitate teaching methods which is more than "seen-in-use", more than teaching which can be experienced through apprenticeship of observation (Lortie 175). They need to get into the ideas and knowledge behind what they imitates. Tharp and Gallimore (1988) state that the teacher must know about the task and the topic before she can scaffold the pupils in their work. As the mentor is in a role between the pupils and the student teachers, he also has to know about what the student teachers bring to the situations (Campbell & Kane 1996). It implicates that not all good teachers are good teacher educators. Edwards and Collison (1996) find that students rarely see themselves as learners in classrooms full of pupils. They are eager to be seen and act as competent

⁸ Discussed in the AERA paper

practitioners. I think my study shows the importance of regarding the learning aspect as an important one.

References

- Ball, D. (1988). American prospective teachers' images of mathematics teaching and learning and of students as learners of mathematics. Upublisert stensil, Michigan State University.
- Ball, D. (1991). research on teaching mathematics: Making subject matter knowledge part of the equation. I J. Brophy (ed.), *Advances in Research on Teaching*, vol.2. Greenwich:JAI Press, s.1-41.
- Calderhead, J. & Robson, M. (1991). Images of teaching: Student teachers early conceptions of classroom practice. *Teaching and Teacher Education*, 7 (1), s. 1-8.
- Campbell, A. & Kane, I. (1996). Mentoring and Primary School Culture. I McIntyre, D. & Hagger, H. (Ed.) *Mentors in Schools. Developing the Profession of Teaching*. London: David Fulton Publishers.
- Collison, J. & Edwards, A. (1996) *Mentoring and Developing Practice in Primary Schools. Supporting student teachers learning in schools*. Buckingham: Open university press
- Dewey, J (1904/1965). The relation between theory and practice in teacher education. In M. Borrowman (ed.) *Teacher education in America: A documentary history* (p.140-171). New York: Teachers college press.
- Doyle, W. (1977). Learning the classroom environment: an ecological analysis, *Journal of Teacher Education*, 28(6), s. 51-55.
- Edwards, A. (1998). Mentoring Student Teachers in Primary Schools: assisting student teachers to become learners. I *European Journal of Teacher Education*, Vol. 21, No.1. s. 47-62.
- L97, Læreplanverket for den 10-årige grunnskolen.(1996) Det kongelige kirke-, utdannings-, og forskningsdepartement. Utgitt av nasjonalt læremiddelsenter.
- Nilssen, V., Wangsmo-Cappelen, V. & Gudmundsdottir, S. (1996). «Døm tenkt på ein heilt anna måte einn ka æ gjor». *En kasusstudie av en lærerstudents matematikkundervisning i 2. klasse*. Trondheim: Tapir
- Feiman-Nemser, S. (1983). Learning to teach. I L.S. Shulman & G. Sykes (red), *Handbook of teaching and Policy*. New York: Longman, s. 150-170.
- Feiman-Nemser, S. & Beasley, K. (1997). Mentoring as assisted performance: A case of co-planning. I Richardson, V. (Ed.) *Constructivist Teacher Education: Building New Understandings* London: The Falmer Press
- Grossman, P. (1989). Learning to teach without teacher education. *Teachers College Record*, 91 (2), s. 191-208.
- Grossman, P. & Richert, A. (1988). Unacknowledged knowledge growth: a re-examination of the effects of the teacher education. *Teaching and Teacher Education*, 4 (1), s. 53-62.
- Lortie, D. (1975). *Schoolteacher. A Sociological Study*. Chicago: The University of Chicago Press.
- Maynard, T. (1996). Mentoring Subject Knowledge in the Primary School. I I McIntyre, D. & Hagger, H. (Ed.) *Mentors in Schools. Developing the Profession of Teaching*. London: David Fulton Publishers.
- Shulman, L. (1987). Knowledge and teaching: Foundations of the new reform. *Harvard Educational Review*, 57 (1), s.1-22.
- Skagen, K. (2000). Norsk veiledningstradisjon i lærerutdanning – analyse og kritikk. I Skagen, K. (ed.). *Kunnskap og handling i pedagogisk veiledning*. Bergen: Fagbokforlaget.
- Tharp, R.G. & Gallimore, R. (1988). *Rousing Minds to Life. Teaching, Learning and Schooling in Social Context*. Cambridge: Cambridge University Press.

- Vygotsky, L.S. (1978). *Mind in Society: The Development of Higher Psychological processes*. Cambridge, Mass.: Harvard University Press
- Wertsch, J.V. (1984). The Zone of proximal Development: Some Conceptual Issues. I Rogoff, B. &
- Wertsch, J.V. (Red.): *Children's Learning in the "Zone of Proximal development"*. Jossey - Bass Inc., Publishers. San Francisco. s. 7-17
- Wertsch, J.V. & Stone, C.A. (1985). The concept of internalization in Vygotsky's account of the genesis of higher mental functions. In J.V. Wertsch (Ed.), *Culture, communication, and cognition: Vygotskian perspectives* (p.162-179). Cambridge University Press.
- Wood, D., Bruner, J. S. & Ross, G. (1976). The role of tutoring in problemsolving. I *Journal of Child Psychology and Psychiatry*. Vol.17, 1976, p. 89-100.

GETTING ORGANISED: THE ROLE OF DATA ORGANISATION IN STUDENTS' REPRESENTATION OF NUMERICAL DATA

Steven Nisbet
Griffith University

This paper explores the role of organising data in representing numerical data in an organised way – a skill which does not come naturally to most students. Grade 6 children were given a series of lessons on organising data and then representing the data graphically. It was found that after instruction, more students were able to reorganise the data and produce an organised graph.

INTRODUCTION

This paper explores the effect of instruction on Grade six students' organisation and representation of numerical data. Previous studies (Nisbet, 2001, 2002, 2003 in press) have shown that while most students find it easy to re-organise and represent categorical data (e.g., eye colour), fewer students are able to do this with numerical data (e.g., number of books read).

By the end of Grade 6, Queensland students are expected to be able represent the data in tables, bar graphs, line graphs, circle graphs, histograms, etc. (Department of Education, 1987). The Australian Numeracy Benchmarks (Curriculum Corporation, 2000) state that the ability to organise, summarise, and display information graphically is essential for primary school students (i.e. Grades 1 to 7). Similarly, the National Council of Teachers of Mathematics Standards (NCTM, 2000) highlights the need for students at all school levels to organise and represent data.

Research into students' representation of data has included the development of a statistical-thinking framework by Jones, Thornton, Langrall, Perry, & Putt (2000). One construct in the framework - *Representing Data* - incorporates making representations that exhibit different organisations of the data. Four levels of thinking are proposed for the construct. Firstly, a Level 1 student produces an idiosyncratic display that does not represent the data in a valid way. A Level 2 student produces a valid display that represents the data but does not attempt to reorganise the data. A Level 3 student produces a display that not only represents the data but also shows some attempt to reorganise the data. A Level 4 student produces multiple valid displays, some of which reorganise the data.

Other studies provide further background for this study. Lehrer and Schauble (2000) investigated the process of data organisation with children in grades 1, 2, 4 and 5. Their results suggest that children at higher grades use more sophisticated strategies for organising data than those in lower grades. Nisbet, Jones, Thornton, Langrall, & Mooney (2003, in press) analysed Grades 1 to 5 students' representations of categorical and numerical data, and found that numerical data was more difficult for children to reorganise and represent than categorical data. Whereas 60% of the children were able to reorganise categorical data, only 20% could reorganise numerical data. Another study (Nisbet, 2001) found that many teacher-education students had similar difficulties

organising numerical data. All produced an organised graph from categorical data, but only 19% produced an organised graph from numerical data, with the majority of students merely drawing separate bars for individual pieces of data without reorganising the data into numerical categories.

Why do many students at all levels find it difficult to reorganise numerical data? It could be the verbal nature of the categories (e.g. blue eyes, brown eyes) make them more obvious compared to numerical data (e.g. 2 fish, 3 fish, etc.). It may be that the perceived need for reorganisation depends on the size of the data set – the larger the data set, the greater perceived need to organise the data. To test this hypothesis, Nisbet (2002b) asked students in Grade 9 and 11 to draw graphs of two sets of numerical data, one with 10 pieces of data, and one set with 30 pieces of data. With the smaller set, most students drew bar graphs showing no reorganisation of the data – just individual bars. However, with the larger set, more students reorganised the data according to frequencies of scores and then drew an organised representation. Those students having difficulty in reorganising the data were given prompts drawing attention to the frequency of the numerical values in the raw data. For the Grade 11 students, the ability to organise the data without prompting was greater for those of high mathematics ability. However, there was no similar ability effect for Grade 9 students. In another study (Nisbet, 2002a), the majority of Grade 7 students needed prompting to reorganise the larger set. However, the less mathematically able students required more prompts than their more able counterparts.

If students find the task of reorganising and representing large sets of numerical data difficult, and if these skills are not only desirable but also necessary in terms of the core curriculum, then ways need to be found to assist students to acquire these skills in a meaningful way. Pertinent research questions such as the following therefore arise: (i) To what extent does instruction assist students to learn skills in reorganising and representing numerical data? (ii) What teaching/learning activities are effective in assisting the students learn these skills? (iii) What benefit would be obtained by employing a *dynamic* approach (Russell & Friel, 1989) in which students investigate issues of interest to them and collect, analyse and represent their own data, in contrast to a *mechanistic* approach (Ernest, 1989) in which students are taught separate skills in a rule-based way, and analyse second-hand data; and (iv) What is the role of mathematics achievement in reorganising and representing data.

METHOD

Participants

The participants were 50 children in a double Grade 6 class at a government school in Brisbane, Australia. Their mathematics ability ratings (as judged by their teachers) were as follows: A+ (very high): 2 students; A (high): 5 students; B (good): 17 students; C (average): 17 students; and D (below average): 9 students. Six target students (across ability levels) were chosen for follow-up interviews. The study was conducted in the last weeks of the school year. The children had completed almost six years of schooling, and (according to the syllabus) should have had lessons each year on collecting and organising data, and constructing graphs to represent data.

Design

The study took the form of a teaching experiment (Cobb, 1999) in which students encountered a series of learning activities, and their performance was studied. The researcher worked with the two teachers to administer a pre-test, conduct the three lessons, and administer a post-test. These lessons covered methods of organising and representing data, and utilised data the students collected about themselves on topics of interest. The pre-test and post-test results were subsequently analysed.

Data collected

At the outset, the students were given a pre-test on organizing and representing data. The tasks were printed on paper for each student (Figure 1).

The following are data on the number of books read by 25 students in a term.													
2	3	6	3	4	2	0	5	5	3	1	2	4	4
4	3	3	2	5	5	6	1	2	3	3			
Task 1: Organize the data in some way that makes sense to you.													
Task 2: Represent the data in any way you like.													

Figure 1: Pre-test task

The students' responses were assessed in terms of the framework (Jones et al, 2000) and the six target students were interviewed along the following lines: (i) Please explain how you organized the data, and why it makes sense to you. (ii) Please explain how you represented the data and why you did it that way.

Two days after the last of the three lessons, the class was given a post-test on the topic (almost identical with the pre-test) and the six target students were interviewed about their responses. The post-test items are showed in Figure 3, and the interview questions were the same as for the follow-up to the pre-test (Figure 2).

The following are data on the number of CDs bought by 25 students in a year.													
3	4	6	3	4	2	0	5	5	7	1	2	4	4
4	3	3	2	5	5	6	1	2	3	3			
Task 1: Organize the data in some way that makes sense to you.													
Task 2: Represent the data in any way you like.													

Figure 2: Post-test task

Series of lessons

The lessons focused on the processes involved in collecting, organising and representing data, with particular attention to organising data. The *first lesson* focused on organizing some raw data on a topical issue presented to the students. (In subsequent lessons students collected data about themselves). After a brief discussion on healthy foods and take-away food, the students were presented data on take-away meals eaten by children in a hypothetical class (Figure 4).

The researcher demonstrated ways of organizing data (rank order, line plot, and tally table), and the students worked in pairs to reorganise and represent the data. In the *second lesson* the students collected, organised and represented data in a 15-item survey about their physical measurements, eating habits, plus estimates of time, length, distance, and

number (Figure 5). This lesson lasted $1\frac{1}{2}$ hours, and the students (to the teachers' amazement) stayed on task for most of the time.

Number of take-away meals eaten by children in the last month:									
2	4	2	7	4	0	4	3	5	1
5	8	1	7	5	1	3	4	6	5

Figure 3: Data for the lesson on organizing data

The *third lesson* included another survey, this time about topics suggested by the students, e.g., sport music, movies, DVDs, pets, families, careers, and pocket money (Figure 4). Students collected the data, then, in pairs, organised the data with line plots and tally plots, then drew organised graphs.

Sections	Items
Physical measure-ments	Your handspan in cm (fingers stretched apart) Your height in cm Your vertical reach in cm (one arm up) Your horizontal reach in cm (two arms stretched out)
Eating habits	How many times have you bought food from the tuckshop in the last 4 weeks? How many times have you eaten a bowl of cereal in the last 7 days? How many times have you eaten rice in the last 7 days? How many times have you drunk a can of soft drink in the last 7 days? How many times have you drunk a glass of milk in the last 7 days? How many pieces of fruit have you eaten in the last 7 days?
Estimates	Estimate of time interval (seconds) Estimate of length of rope (metres) Estimate of distance from school to city (km) Estimate of number of dice in a jar (to nearest 10)
Other	Time it takes you to travel to school (in minutes)

Figure 4: Items in the class survey for Lesson 2

The planning of instructional activities involved some logistical challenges. The first was motivating a double class, and keeping them interested and on-task. The keys to meeting this challenge were threefold: (i) ensuring the topics were interesting and relevant; (ii) having adequate space for whole-class and small-group activity; and (iii) having three teachers (two teachers plus researcher) to monitor the students. Re the first point, the topics selected for study were related to the students' world. As for space, the double classroom had generous dimensions, allowing a carpeted area for all children to sit close to the teacher, plus plenty of space for table clusters.

1	1
2	2
3	3
4	4
5	5
6	6
7	7
8	8
9	9
10	10
11	11
12	12
13	13
14	14
15	15

The second challenge was to collect data from the double class efficiently, and distributing the data to the pairs of students to analyse. The first technique devised was to print a survey sheet with 15 items listed twice (in parallel columns, as in Figure 5), and to have the students fill in their responses twice, producing 30 responses each. The students then cut the sheet into two halves and each half into 15 pieces. They then deposited the pieces into numbered plastic ice-cream containers. Each pair of students, therefore, received a large set of data to analyse.

Prior to filling in the sheets the students needed to measure their heights, handspans, etc., requiring appropriate measuring equipment to be available around the room. The second technique was to have a data collection sheet for each survey item, and to get the children to complete them in turn, and pass them around a single class.

Figure 5: Survey sheet format for Lesson 2

RESULTS AND DISCUSSION

The results show an improvement in the students' reorganisation and representation of numerical data. A comparison of pre-test and post-test scores reveals an increase in the number of students who were able to draw an organised graph – from 19 out of 50 (38%) in the pre-test to 47 out of 50 (94%) in the post-test.

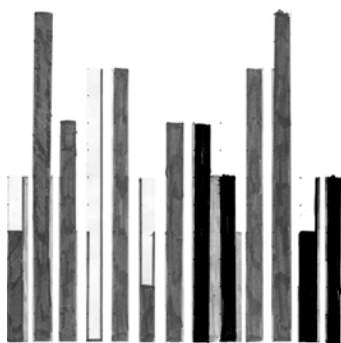

Fig. 6: Graph showing no reorganisation (pre-test)

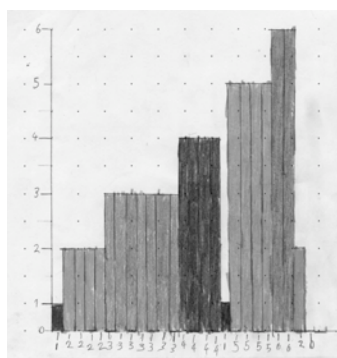

Fig. 7: Graph organised by magnitude (pre-test)

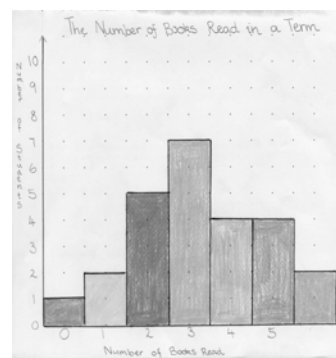

Fig. 8: Graph organised by numerical categories (pre-test)

In the *pre-test*, 31 students (62%) drew individual bars showing no re-organisation of the data (Figure 6). One student's graph also had 25 separate bars, but was organised by

magnitude, (mostly) (Figure 7). The other 18 students drew graphs organised by categories, showing frequency of students versus number of books read (Figure 8).

Methods of reorganising the data varied among the students. Of the 18 students who drew graphs organised in categories, six made a tally table first. Six students just jotted down how many people had read the numbers of books. Another student had circled or highlighted the numbers of books in different colours to help her reorganise the data – the 1s circled in black, the 2s highlighted in green, etc. The other students apparently just counted the frequency of occurrence of the scores without noting the frequencies.

The *interviews after the pre-test* revealed that the two A-level students had in fact counted the frequency of each score, and drawn their graphs from that information. One made a tally table. One B-level student thought about making a table but did not proceed. One of the D students (the one who colour coded the data) explained that the colours made it easy for her to count the frequencies. The other D student interviewed saw that 25 bars from 25 pieces of data would not fit the 13 divisions on the horizontal axis of the graph paper, so he split the divisions to fit all the bars in.

Regarding the *post-test graphs*, the majority (47 out of 50) showed a reorganisation of the data (Level 3). One showed bars in order of magnitude (similar to Figure 8). and 46 showed frequency versus numbers of CDs (similar to Figure 9). The other 3 graphs showed no reorganisation (Level 2) (similar to Figure 7), despite the fact that these students initially reorganised the data in a tally table or line plot. One of the teachers observed that one student had drawn the unorganised graph first, then reorganised the data in a tally table *and* a line plot afterwards.

Further in the *post-test graphs*, the majority of students demonstrated the ability to reorganise the data prior to drawing their graphs; 48 out of 50 made a tally table, and of these, 34 drew a line plot also. The other two drew a line plot only. It is surprising that three students went to the effort of reorganising the data in a tally table, but did not translate this reorganised data into an organised graph. Two of these students were rated by the teachers as B students, and the other as a D student. There is room for further research here on what prevents such students from drawing a representation of the reorganised data.

The *post-test interviews* revealed that students had no difficulty in reorganising data with either a table or line plot. These are obviously appropriate tools for reorganising data for Grade 6 children. The students understood the need to scan the raw data to note the lowest and highest values for the tally table, and readily adopted this as part of the procedure to reorganise the data. Also, the students revealed that they could interpret their own graphs i.e., they could explain what each bar meant. However, one D-level student reversed the meanings of the axes and confused the numbers of CDs with the number of students. One B-level student interviewed was one of three who had made a line plot to organise the data, but then drew a graph with individual bars. When asked why she drew it that way, she referred back to the original raw data, not her own reorganised data. She remarked, “The first person bought 2 CDs, the second bought 3 CDs, ...”. It appears that for some students the links between the reorganised data and

their graphical representation need to be made very explicit through student-teacher dialogue concerning the reorganised data and the graph.

There was no significant *effect of mathematics rating* on the level of graphs produced in the pre-test, nor the post-test, nor on the improvement in levels. Although the two A+ students produced graphs showing reorganisation of the data (Level 3) in the pre-test, so also did four of the nine D students. In the post-test, two of the three students who did not draw organised graphs were B students; the other was a D student. This result could imply that (i) the teachers' ratings may not be accurate; (ii) the skills required to reorganise and represent numerical data are fairly specific and not entirely coincident with general mathematics skills. Thus, it would be worthwhile to obtain a better measure of mathematics ability – a standardised measure with spatial and logical components as well as numerical components.

There was one unanticipated observation arising from this study – an association of pre-test results with *music experience*. When the researcher arrived for the pre-test, the teachers informed him that 17 of the students – members of the school orchestra – would be away at a recording session. Nevertheless, the teachers indicated that they would administer the pre-test to them later in the day. Hence the researcher had the pre-test papers in two separate bundles, and was able to code them according to orchestra membership. The results revealed that 9 of the 17 orchestra members (53%) had reorganised the data before drawing their graphs (Level 3), whereas 9 of the 33 non-members (27%) had reorganised the data before drawing their graphs (Level 3). Although a chi-square test showed no significant relationship between orchestra membership and level of pre-test graph, with more sensitive measures of music ability and handling data, the relationship could be explored further.

The possibility of an association with music ability is interesting in view of previous studies which show links between mathematics and music ability (Nisbet & Bain, 2000; Rauscher & Shaw, 1993). However the result here should not be taken any further at this point given that the teachers indicated that the orchestra members were “some of their brightest students”. An analysis of variance revealed a significant association between teachers' ratings mathematics ability and orchestra membership ($F = 10.344, p = .002$). It appears that the school orchestra attracts students of high mathematics ability. This result offers another opportunity for further research.

In summary, the most important finding of this study was the increase in the number of students who were able to reorganise numerical data and validly represent them. The study demonstrated that data-reorganising skills can be taught to Grade 6 students meaningfully, that such skills assists them to draw valid organised graphs, and that learning activities that involve students in collecting and analysing data about themselves are effective in sustaining interest and engagement. The study has also identified avenues for further research relating to the transition from reorganised data to their representation, utilising more sensitive measures of data handling, mathematics ability and music ability.

References

Cobb, P. (1999). Individual and collective mathematical development: The case of statistical analysis. *Mathematical Thinking and Learning, 1*, 5-43.

- Curriculum Corporation (2000). *Australian Numeracy Benchmarks*. Melbourne, Vic.: Author.
- Department of Education, Queensland (1987). Years 1 to 10 Mathematics Syllabus, Year Overviews. Brisbane: Curriculum Services Branch
- Ernest, P. (1989). The impact of beliefs on the teaching of mathematics. In P. Ernest (Ed.), *Mathematics Teaching: The state of the art*. New York: Falmer.
- Jones, G., Thornton, C., Langrall, C., Mooney, E., Perry, B., & Putt, I. (2000). A framework for characterizing students' statistical thinking. *Mathematical Thinking & Learning*, 2, 269-307.
- Lehrer, R., & Schauble, L. (2000). Inventing data structures for representational purposes: Elementary students' classification models. *Mathematical Thinking & Learning*, 2, 51-74.
- National Council of Teachers of Mathematics (2000). *Principles and standards for school mathematics*. Reston, VA: Author.
- Nisbet, S. (2002a). Year 7 students' representation of numerical data: the influence of sample size. In B. Barton, K. Irwin, M. Pfannkuch, & M. Thomas (Eds.) *Mathematics Education in the South Pacific, Proceedings of the 25th Annual Conference of the Mathematics Education Research Group of Australasia*, Auckland, NZ, July 7-10, 2002. (pp. 520-527). MERGA.
- Nisbet, S. (2002b). Representing numerical data: the influence of sample size. In A. Cockburn & E. Nardi (Eds.) *Proceedings of the 26th Annual Conference of the International Group for the Psychology of Mathematics Education*. PME 26, Norwich, UK. July 21-26, 2002. Vol. 3, pp. 417-424. Norwich, UK: University of East Anglia.
- Nisbet, S. (2001). Representing categorical and numerical data. In J. Bobis, M. Mitchelmore, B. Perry (Eds.) *Proceedings of the 24th Annual Conference of the Mathematics Education Research Group of Australasia*, Sydney, NSW, 1-4 July 2001. Sydney: MERGA.
- Nisbet, S. & Bain, J. (2000). Listen to the graph: Children's matching of melodies with their visual representations. In T. Nakahara & M. Koyama (Eds.) *Proceedings of the 24th Annual Conference of the International Group for the Psychology of Mathematics Education*. PME 24, Hiroshima, Japan. July 23-27, 2000. Vol. 4, pp. 49-56.
- Nisbet, S., Jones, G., Thornton, C., Langrall, C., & Mooney, E. (in press). Children's Representation & Organisation of Data. Accepted for *Mathematics Education Research Journal* 15 (1).
- Rauscher, F.H., Shaw, G.L., Ky, K.N. (1993). Music and spatial task performance, *Nature*. 365:611.
- Russell, S., & Friel, S. (1989). Collecting and analyzing real data in the elementary school classroom. In P. Trafton & A. Schulte (Eds.) *New Directions of Elementary School Mathematics, 1989 Yearbook*. Reston, Va: National Council of Teachers of Mathematics.
- Wood, D., Bruner, J., Ross, S. (1976). The role of tutoring in problem solving. *British Journal of Psychology*, 66, 181-191.

STRONG AND WEAK METAPHORS FOR LIMITS

Michael C. F. Oehrtman

Arizona State University

The metaphorical nature of first-year calculus students' reasoning about limit concepts is explored using an instrumentalist approach. Analysis of written and verbal language reveals that, while these students used motion terminology profusely when discussing limits, it was typically not intended to signify actual motion and did not play a significant role in their reasoning about limiting situations. In contrast, many of these students' employed other non-standard metaphors, involving for example collapsing dimensions, to explore these situations and to build their emerging understanding of limit concepts.

INTRODUCTION

Although limit concepts are foundational to the study of calculus, they have proven especially difficult for beginning calculus students to understand. Williams (1990, 1991) has revealed many ways in which students try to reason about limits using insufficient, intuitive ideas and metaphors for the concept including boundaries, motion, and approximation. Lakoff and Núñez (Lakoff & Núñez, 2000; Núñez, 2000) have attempted to show how intuitive ideas can form a more rigorous metaphorical basis for understanding limit concepts, but their work is neither based in student data nor intended as a theory of learning.

This paper presents results of a study investigating actual students' spontaneous reasoning about limit concepts and the aspects which determine whether that reasoning is helpful or a hindrance to developing a stronger understanding of limits.

Instrumentalism

Most previous research on students' understanding and learning of limit concepts has focused on the structural aspects of their knowledge. While it is important to account for the content and internal structure of knowledge, equally significant are the functional ways in which those knowledge structures are applied against specific problems. In order to address this aspect of knowledge in the theoretical perspective of this study, we turn to John Dewey's "instrumentalism."

To understand a human activity, according to Dewey, it is necessary to examine the ways in which relevant tools are applied *technologically* against problematic aspects of situations (Hickman, 1990). In its modern use, the word "technology" typically refers to physical inventions rather than cognitive tools used in mental activity. Dewey argued, however, that such Cartesian lines between environment and organism and between mind and body are not so definite. The same principles that apply to human physical tool use also apply to productive mental activity. For Dewey, describing tool use as technological meant that it is active, testable, and productive. A cognitive tool is selected and applied in a dynamic process which actively engages the attention of the individual. It is used to perform tests upon the problem that gave rise to its selection, and reciprocally, the tool is itself tested against the problem and evaluated for appropriateness. Fortuitous interactions between aspects of the tool and problem are complex, reciprocal, and implicative, thus

effecting change in both. The artifacts of this dialectic are new meanings, which as they emerge, present situations that may themselves become the object of further inquiry.

In this process, an original idea becomes more “coherent” and “densely textured.” Since inquiry is situated and ongoing, one cannot separate knowledge from the context of its origins; it is bound to the unique circumstances and processes through which it was created, and truth is emergent, not located externally. Consequently, Dewey’s focus is on the process of inquiry rather than on transient pieces of knowledge. Meaning for a proposition, symbol, or metaphor is defined in terms of the object’s function in particular productive activity, just as it is for a physical tool such as a computer or hoe.

Metaphors

Consistent with an instrumentalist approach, Max Black’s “interaction” theory of metaphorical attribution asserts that one must regard the two subjects of a metaphor as a complex, interacting system (Black, 1962, 1977). This requires two levels in which new and old meanings must be held active together: first, with respect to distinct meanings of the metaphorical subject with and without the context of the metaphor, and second, with respect to the extension of meaning imposed on the literal subject by the system. Strong metaphors, such as those that would be necessary for supporting creative thinking, force the relevant concepts involved to change in response to one another. The resulting perspective created is one that would not otherwise have existed, that is, strong metaphors are ontologically creative. In such metaphorical reasoning, one cannot simply apply an antecedently formed concept of the metaphor as-is; something new and actively responsive to the situation is required of all concepts involved. If pursued, the implications can support a degree of discovery that leads far beyond one’s original thoughts, providing the complexity and richness of background implications necessary for generating new ways of perceiving the world.

METHODOLOGY

Students from a year-long introductory calculus sequence at a large southwestern university participated in interviews and submitted writing samples covering their attempts to make sense of problematic situations involving limit concepts. To observe functional aspects of students’ thought, data collection in this study was intended to encourage students’ technological application of their metaphors against challenging problems. Ten questions, roughly paraphrased below, were presented to the students. The first two were presented in clinical interviews with 9 students during which problematic aspects were called out by the interviewer for resolution by the subjects. Problems 3 and 4 were given to the entire class of 120 students as a short writing assignment, and the remaining six problems were offered as extra-credit writing assignments to the entire class with 25-35 students responding to each one. Follow-up interviews were conducted with an additional 11 students.

1. Explain the meaning of $\lim_{x \rightarrow 1} \frac{x^3 - 1}{x - 1} = 3$.

2. Let $f(x) = x^2 + 1$. Explain the meaning of $\lim_{h \rightarrow 0} \frac{f(3+h) - f(3)}{h}$

3. Explain why $0.\overline{9} = 1$
4. Explain why the derivative $f'(x) = \lim_{h \rightarrow 0} \frac{f(x+h) - f(x)}{h}$ gives the instantaneous rate of change of f at x .
5. Explain why L'Hospital's Rule works.
6. Explain how the solid obtained by revolving the graph of $y = 1/x$ around the x -axis can have finite volume but infinite surface area.
7. Explain why the limit comparison test works.
8. Explain in what sense $\sin x = 1 - \frac{1}{3!}x^3 + \frac{1}{5!}x^5 - \frac{1}{7!}x^7 + \dots$
9. Explain how the length of each jagged line can be while the limit has length 1.



10. Explain what it means for a function of two variables to be continuous.

Multiple rounds of open and axial coding (Strauss & Corbin, 1990) were used to identify emergent metaphorical themes in the language used by the students while confronting the problematic issues presented in these problems. Refined metaphorical categories were then analyzed for the following properties of instrumental use: support of implicative reasoning, commitment to the context of the metaphor, change in understanding of the problem, and change in meaning of the context.

RESULTS

Eight major metaphorical contexts emerged from the data. Five contexts, involving collapse, approximation, closeness, infinity as a number, and physical limitation, possessed all four instrumental properties listed above, and were thus labeled “strong” metaphors. The other three contexts, involving motion, zooming, and arbitrary smallness, exhibited none of these instrumental properties and were thus labeled “weak” metaphors. A discussion of all eight contexts is beyond the scope of this paper (see Oehrtman, 2002 for details), so the following two sections present an example of one strong metaphor, collapse, and one weak metaphor, motion.

An Example of a Strong Metaphor for Limits: Collapsing Dimensions

The collapse metaphor, while mathematically incorrect, did afford many students the ability to reason powerfully about the mathematics. In this context, students characterized a limiting situation by imagining a physical referent for the changing dependent quantity collapsing along one of its dimensions, yielding an object one or more dimensions smaller. A version of this metaphor, anecdotally familiar to most calculus teachers, is a fallacious justification of the fundamental theorem calculus. In this incorrect argument, students focus on the referent for the numerator of the difference quotient imagining, for example, a “final thin rectangle” of area underneath the curve. Ignoring the denominator,

they then argue that the limit as the width “becomes” zero causes that slice to “become” the one-dimensional height of the graph.

The collapse metaphor was observed in two main versions involving the definition of the derivative and volumes of unbounded solids of revolution. In both the interviews and written assignments about the definition of the derivative, approximately one third of the responses involved significant use of a collapse metaphor (3 of 9 students for Problem #2 and 36 of 98 students for problem #4). While describing the volume of a solid of revolution, nearly one sixth of the students used a collapse metaphor (5 of 31 students).

In the case of the definition of the derivative, students would describe a dynamic secant line through two points with the base and height of a right triangle as in a standard slope illustration. Moving these points closer together yields secant lines closer to the tangent, and the collapsed object is achieved when the two points are moved to the same location. The result is the tangent line at that point (see Figure 1). Some students characterized this as taking the slope at a single point while others reported thinking of the slope between two points at the same location.

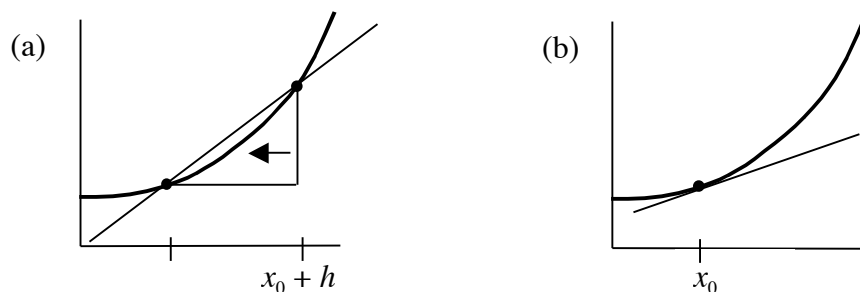

Figure 1: A secant line collapsing to a tangent. (a) Before collapse: a secant line between two points. (b) After collapse: a tangent line through “two points” at a single location.

Consider the following interview excerpt in which Amy wrestles with the role of h in the derivative definition and comes to the conclusion the two points become one:

As you take the limit, the value h is going to be getting continually smaller until it reaches zero at which point you'll be finding - the slope - of the line between $[3,10]$ and $[3,10]$...What you're doing is taking the limit of the slope - of what is - actually it's the slo-, it's not the slope of the tangent line, it's just what it ends up being, but you're taking the limit, you're taking the slope of two points. It only - and the limit is involved to allow you to eventually phase out the other point - and it just becomes to be, it would be just become the slope of the original po-, of the line at the original point... It involves taking x_2 and - and making it gradually closer to x_1 - until x_2 is equal to x_1 . Which - um - which you would also - you know y_2 would be equal to y_1 . And so - basically what you're doing is you're taking the slope of two points that are infinitely close together - so that they become the same point.

During the interviews, students were also asked to give an interpretation of the definition of the derivative for the position of a car as a function of time. The students all struggled with this new context, but while not ostensibly referring to their previous work, several who had already used the collapse metaphor gave a similar account for the new problem, imagining instantaneous speed to be an average taken over a time interval of no duration.

A different version of the collapse metaphor emerged while students attempted to explain how the volume of a solid of revolution could be finite (Problem #6). Here the dynamic object is a cross-sectional disk produced from revolving a point on the curve and varying in the dimension of its radius (Figure 2). The radius is imagined to decrease to zero at some definite point (possibly but not necessarily infinity) so that the two dimensions of the disk collapse to a point. Simultaneously imagining all of the collapsed “disks” beyond this point, one imagines the three dimensional solid “pinching off” to a one-dimensional line with no volume. Consider Karrie’s explanation for how the volume of a solid of revolution collapses in this manner:

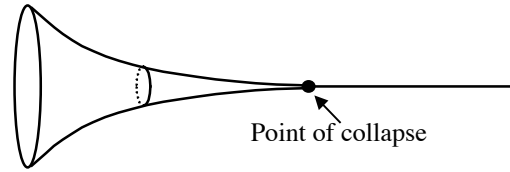

Figure 2: A collapsing solid of revolution.

The finite volume is not really finite in the same way that familiar containers such as bowls and ice cream cones are finite. The volume is the result of a line which stretches off into infinity into the x direction. Thus, we cannot actually imagine it pinching off and ending like an ice cream cone does. Rather, the radius of the disks in the volume gets so small as the x values get extremely large that at infinity the radius becomes zero in the same way that $.9999 \rightarrow$ is actually exactly the same as 1. This progressively smaller disks actually add up to a finite amount. I imagine this "pinching off" as the two-dimensional volume (looking only at the disks, and taking two dimensions at a time) wrapping more and more closely around the one-dimensional line that is the x -axis, and then, at infinity, losing that radius entirely to zero and becoming one-dimensional, like the line. This is where volume ends, but surface area continues to exist in that single dimension

For Karrie, the collapse occurs “at infinity” but the object continues to exist beyond this where “volume ends, but surface area continues to exist in that single dimension.” This caused some concern for Karrie, and her subsequent explanation was full of hedges to soften her commitment to a complete idea of collapse.

Even though the collapse metaphor is mathematically incorrect, students like Karrie were able to use it to see valid connections between different types of limits (e.g., $0.\overline{9} = 1$ and a solid of revolution), between different contexts involving the same limits (e.g., the definition of the derivative and instantaneous velocity), and between different representations of limits (e.g., the “collapsed” tangent discussed above and slope via numerical approximations “collapsing” to an exact value). Making such connections enabled these students to organize their thoughts for further inquiry and to make substantial progress conceptualizing the meaning of limits in difficult contexts.

An Example of a Weak Metaphor for Limits: Motion

Several researchers have found that a dynamic conceptualization of functions and variables is crucial to students’ understanding of key concepts in calculus such as limits (Monk, 1987, 1992; Tall, 1992; Thompson, 1994b). Unexpectedly, strong motion metaphors were nonexistent in the students’ responses in this study. While students frequently used words such as “approaching” or “tends to,” these utterances were not accompanied by any description of something actually moving. When asked specifically about their use of the word “approaches,” students almost always denied thinking of

motion and gave an alternate explanation. Motion for these students was something more “literal” as suggested here by Karen:

I guess with motion I think of - with motion I'm thinking force and work. I'm thinking of actual, like, locomotion. I don't necessarily think that that's what's happening when you're talking about a limit or talking about a number. I don't know that that's - I guess for me motion is a more literal term, like cars moving along the ground or I'm walking. That's more what I'm thinking than on the number line.

Only for Problem #10 about the continuity of functions of two variables were at least 10% of the students observed to discuss actual motion. In response to this question, 6 out of 25 students explicitly described something moving. Another 11 of the 25 respondents used motion language, but without applying it to an actual object. In the cases that something was imagined to be moving, that motion tended to be simply superimposed on another conceptual image that actually carried the structure and logic of their thinking. For example, all 6 of the motion references in responses to Problem #10 were to an object (an ant, a mouse, a moving truck, a baseball, the tip of a pencil, and a generic “you”) moving along the graph of the function. For both single- and two-variable cases, these students described the function as continuous if the object could move freely along the graph without having to traverse a jump or hole. In the following excerpt, a student describes continuity in terms of moving on the graph of a function of two variables.

A good example is the surface of a big wooden board. What does it mean for this to be continuous? Imagine a tiny mouse is on the board. If the board was continuous, the cute little mouse could venture all over the board without falling to its death. If the board wasn't continuous, maybe [it] contains a hole in the center.

Thus, the concepts about discontinuity for these students were presented as topological features of the surface (holes, cliffs, breaks, etc.). The addition of motion may add visual effect or drama, but not conceptual structure or functionality.

Whenever students used motion language, such as “approaches,” during the interviews, they were asked how they interpreted those terms. Of the 20 students interviewed, only eight ever agreed that they thought of motion when using a variation of the word “approaches.” Five of these students described the motion occurring on the graph of the function, one described motion along the x -axis, and two gave explanations in which it was impossible to tell what object was imagined to move. None of these students mentioned explicit motion other than during these exchanges initiated by the interviewer. Of the 12 students who denied imagining any type of motion, six explained that they thought of “approaches” as indicating closeness, five described picking points sequentially, and one student thought it meant that changing the value of input caused the output to change. Below are brief descriptions and examples of the responses from each of these categories.

Students’ descriptions of motion on the graph are exemplified by the previous excerpt involving a mouse running on the surface of a graph in which the reasoning is actually supported by static images such as breaks or holes. The single description of motion on the x -axis was not accompanied by corresponding motion on the y -axis. Instead she imagined moving to the point in question then “looking up” at the function value (or “the

hole” where the function should be.) Interestingly, she reported thinking this because the horizontal arrow in the limit notation indicated horizontal motion. Only one student explained that “approaching” meant that changing the input of a function caused a change in the output. In discussing the definition of the derivative, she described two points that “both approach the same limiting position” but denied that these points actually moved.

Half of the students (6 out of 12) who claimed to not think about motion when using words like “approaches” described a static closeness. For example, one used a metaphor of two train tracks meeting in the same place, with lengthy descriptions of “meeting up” in terms of being located in the same region in space. Karen, quoted earlier in this section drawing a distinction between “literal motion” and “approaching,” described the latter as meaning “close” in a very static sense:

I don't think that I necessarily picture motion, but picture that idea that you may have a value that your points are really close to that - so close that they - like in the first problem that they're almost that point but they're not quite that point, so I guess the way I think of approaches is that it's not necessarily moving from 3 to 2_ to 2. You know, it's not moving, but it's the idea behind that it may not be - it may not be 2, but it's really close to 2

Finally, five students specifically explicated the term “approaches” as a process of sequentially selecting points closer to the point at which the limit was being evaluated. Here, Darlene describes this as picking numbers.

Interviewer: OK. The word “approaches” has a lot of - it sounds kind of like something is moving. Do you think of motion at all?

Darlene: No.

Interviewer: No?

Darlene: That’s just the way it’s always been explained to me.

Interviewer: OK. So, people have used that word before?

Darlene: Yeah. The book uses that word, too. [*laughs*] ... I don’t really think about it that way. I just, you know, pick numbers. [*points at several distinct points on the x-axis successively closer to 1*]...I'm not saying like a car approaches point a. I don't think of it as like that. I think of it as like, OK, I'm gonna take this value [*points at the x-axis near 1*]. The next time I'm going to take this value [*points at a spot closer to 1*], so it's approaching - approaching in intervals basically. I don't - yeah. I'm not thinking - that's what I'm thinking of. I'm not thinking of it like moving motion, like that. Like I take this interval - like I take a point, then I take this point, then I take this point, then it's approaching - yeah.

CONCLUSIONS

Students in this study did not reason about limit concepts using motion metaphors. This is particularly surprising given the predominance of motion language used when talking about limits and abundant proclamations that intuitive, dynamic views of functions should help students understand limits. When these students did use motion language, their actual reasoning typically relied on a static graphical setting or, at most, the sequential selection of points. When they were asked to use limit concepts to think about

something new or approach a difficult problem, motion language tended to remain in the background and did not enter their descriptions as referring to anything actually moving.

Instead, other metaphors, such as collapsing dimensions, surfaced. This research found students using such metaphors as organizers of ideas and touchstones for reasoning. These metaphors became tools with which students were able to probe difficult problems, ask interesting questions, and develop further connections. They supported dynamic mental imagery that students were able to manipulate, extracting conclusions about the relevant mathematics. Although such reasoning was often technically incorrect, it remained a productive tool for the students' emerging understanding.

Such results suggest that research cannot fully uncover the nature of students' metaphors by examining only their surface language and responses to direct questions about their conceptualizations of the topic. Not only does this methodology miss the different structures that might appear in such problem solving contexts, but it also lacks the important characterizations of how conceptual tools are actually applied, of the questions the tools are used to ask and the resulting answers, and of the changes the tools undergo in the process. Students' reported structural organization of mathematical concepts does not account for their actual use of those ideas; research must look at richer data on their functional application of ideas in addition to their structure and logic.

References:

- Black, M. (1962). Metaphor. in M. Black. *Models and Metaphors*, Ithaca, NY: Cornell University Press, 25-47.
- Black, M. (1977). More about Metaphor. *Dialectica*, 31, 433-57.
- Hickman, L.A. (1990). *John Dewey's Pragmatic Technology*. Bloomington: Indiana University Press.
- Lakoff, G. & Núñez, R. (2000). *Where Mathematics Comes From: How the Embodied Mind Brings Mathematics into Being*. New York: Basic Books.
- Nunez, R. (2000) Mathematical Idea Analysis: What Embodied Cognitive Science Can Say About the Human Nature of Mathematics. In T. Nakahara & M. Koyama (Eds) *Proceedings of the 24th Conference of the International Group for the Psychology of Mathematics Education*, 1, 3-38.
- Oehrtman, M. (2002). *Collapsing Dimensions, Physical Limitation, and other Student Metaphors for Limit Concepts: An Instrumentalist Investigation into Calculus Students' Spontaneous Reasoning*, Doctoral Dissertation, The University of Texas, Austin, TX.
- Strauss, A. & Corbin, J. (1990). *Basics of Qualitative Research: Grounded Theory Procedures and Techniques*. Sage Publications, Newsbury Park, California.
- Williams, S. (1990). The understanding of limit: Three perspectives. In G. Booker, P. Cobb, and T. N. de Mendicuti (Eds.) *Proceedings of the Fourteenth Conference of the International Group for the Psychology of Mathematics Education*, 1, 101-108.
- Williams, S. (1991). Models of Limit Held by College Calculus Students. *Journal for Research in Mathematics Education*, 22, 219-236

APPLYING THEORY OF PLANNED BEHAVIOR MODEL ON STUDYING TEACHERS' CHANGE IN MATHEMATICS INSTRUCTION

Youngyool Oh

Gwangju National University of Education

The present study aims at gaining an understanding of structures underlying Korean teachers' willingness to change their traditionally-oriented mathematics teaching practice toward reform-oriented mathematics instruction. Elementary school teachers from a metropolitan city of Korea (N = 281) participated in this study. To deal with this problem, this study employs the Theory of Planned Behavior as a research framework and Structural Equation Modeling using AMOS 4.0 as a statistical model was used to analyze the data. The findings indicate that the TPB is a useful model for explaining teacher change in teaching practice, suggesting that beliefs-based programs will be effective for successful teacher education.

A recent view of educational reform calls for the fundamental change in teachers' instructional practice. This strong demand for change had been raised from diverse areas of the society as a result of considerable agreement that traditional schooling had failed to educate students in mathematics. In accordance with the needs for change in the method of teaching mathematics, research on the teaching and learning of mathematics has drastically increased over the last decade. Using the Eric database, Lubienski and Bowen (2000) found that approximately 20 percent of the articles related to elementary education in mathematics investigated teacher behaviors. This study revealed that more attention was increasingly oriented toward teachers' beliefs and knowledge regarding their roles in changing traditional ways of teaching mathematics.

The results of some studies (Franke, Fennema, & Carpenter, 1997; Raymond, 1997; Thompson, 1992) suggested that mathematics teaching seems to be more effective when teachers' beliefs are consistent with their teaching practices. Thus, teachers' beliefs about mathematics as well as its teaching and learning are now considered as essential component of good teaching. Although plenty of qualitative studies have been conducted on this area, a few quantitative studies focused on structural approach among variables have been found. By adopting a statistical method, the present study is interested in more deeply understanding the structural phenomenon underlying teachers' willingness to change their traditionally-oriented teaching practice in mathematics and their beliefs.

THEORETICAL BACKGROUND

Good teaching is not solely based on a teacher's effective transmission of mathematical knowledge. Rather, decades of research on mathematics teaching and learning reveal a consistent assumption that good mathematics teaching is based on how teachers view mathematics, their beliefs of how mathematics should be taught, and the extent of a teacher's mathematical knowledge.

Throughout the years, the image of good teaching has shifted back and forth between two conflicting philosophies. On the one hand is what has been called a “traditional,” “teacher-centered,” “rote-learning,” and “drill-and-practice” approach. On the other hand, one finds a “progressive,” “students-centered,” “meaningful learning,” and “reform-oriented” approach. Teachers that follow the traditional model have been metaphorically described as “knowledge distributors” given that they directly transmit what they know into their students’ heads. On the other hand, reform-oriented teachers have been seen as “facilitators,” or “stimulators” given that they assist students’ mathematical learning as they create a learning environment that reflect students’ ideas.

Recently, studies on teachers’ beliefs have been one of the most pursued research areas in mathematics education due to the realization of their importance on teaching and students learning. Some studies (Raymond, 1997; Brown & Borko, 1992; Thompson, 1992) have focused on examining the consistency between teachers’ beliefs and their actual teaching practice in the classroom, and other studies have found some constraints in teaching in a reform-oriented way. Generally speaking, there is an agreement that teachers are required to change their beliefs toward the reform-minded and their beliefs need to be consistent with actual teaching practice in their classroom in order to teach mathematics more effectively.

The theory of planned behavior (TPB) proposed by Fishbein and Ajzen (1975) has gained one of the most successful psychological models used to predict and understand human behavior that is socially relevant. Although few studies have employed the TPB in mathematics education, recent success in other academic areas, such as science education (Crawley & Kobala, 1994; Kobala & Crawley, 1992) and special education (Kalivoda & Higbee, 1998) has implied that this theory can play a significant role in understanding a structural approach to teacher change in mathematics teaching practice. The TPB is grounded on the assumption that “human beings are usually quite rational and make systematic use of the information available to them” (Ajzen & Fishbein, 1980, p. 5). The model proposes a causal relationship among the variables that influence the target behavior. According to the model, teachers’ change in mathematics teaching practice of mathematics is best predicted from teachers’ intention to teach mathematics in a students-centered way, called behavioral intention (BI). In turn, behavioral intention is a function of the other three predictor variables; that is, attitude toward the behavior (AB), subjective norm (SN), and perceived behavioral control (PBC). Thus, the theoretical TPB model was conceptualized into the structural equation model (SEM) to investigate teachers’ change in mathematics instructional practice.

RESEARCH METHODS

The population of the present study included all elementary school teachers who teach mathematics as part of their regular responsibility in a metropolitan city of Korea. Convenient sampling was used to select 21 schools to guarantee diversity in elementary mathematics teaching contexts regarding school educational goals, district resources, and socio-economic status. Finally, a total of 379 teachers completed a questionnaire used in this study. After both questionnaires with severely missing entries and outliers were

deleted from the data, a total of 281 subjects, 177 reform-minded and 64-traditionally-oriented, were considered as valid for final analysis.

The development of the instrument used in this study followed the guidelines recommended by Ajzen and Fishbein (1980). Among the components measured were behavioral intention, attitudes toward the behavior, subjective norms, and perceived behavioral controls. Teachers' behavioral intention toward the reform-oriented mathematics teaching was measured by their responses to the following 7-point likert scale: *I intend to teach mathematics in a students-centered way (e.g., exploring concepts, making the classroom as learning environment, and providing a variety of opportunities to learn)*. Attitude toward the behavior, subjective norm, and perceived behavioral controls were measure both directly and indirectly. For instance, a direct measure of subjective norm was measured by teachers' response to the statement "*Most people who are important to me think I should teach mathematics in a students-centered way*" by a 7-point likely-unlikely scale. On the other hand, an exemplary statement for the indirect measure of subject norm is "*My students think I should teach mathematics in a students-centered way*" by a likely-unlikely scale.

Structural equation modeling (SEM) with AMOS, standing for Analysis of Moment Structure (Arbuckle & Wothke, 1995), was adopted to analyze the data. The structural equation modeling includes two different variables: observed variables and latent (unobserved) variables. Latent variables are not directly measured but estimated from observed variables, which are direct measured. Eventually, many constructs of interest are unobservable in nature. In the theory of planned behavior model briefly described above, behavioral intention, attitude, subjective norm, and perceived behavioral control may not be directly observed; rather, there latent variables can be calculated from measured indicators. The theoretical framework of theory of planned behavior is consistent with the purpose of structural equation modeling for analysis in the sense that the structural equation modeling allows a researcher to evaluate an entire on a "micro-level" and to test individual effects on a "micro-level" (Kline, 1998, p. 13).

RESULTS

The structural equation modeling (SEM) of the theory of planned behavior (TPB) consists of measurement and structural components. The SEM designed for the present study includes the directly observed variables and the unobserved latent variables that are associated with the observed variables. The SEM using AMOS 4.0 for the TPB is based on the theoretically-grounded causal relationships between the latent variables, such as teachers' behavioral intention, attitudinal beliefs, subjective norms, and perceived behavioral controls toward changing traditionally-oriented instructional practice in mathematics.

The researcher first hypothesized for the structural part of the model that the teachers' willingness to teach in a reform-oriented mathematics instruction is dependent upon their attitudinal beliefs, subjective norms, and perceived behavioral controls. In the measurement model, a set of connections between the observed variables and the latent

variables were considered to see how well the observed variables are predicted by the latent variables.

For model 1 that was formulated on the basis of the TPB, maximum likelihood estimation gives a chi-square value of 44.80 with 11 degrees of freedom ($p = .00$), indicating that the original model did not appropriately fit the data. Another fit index, RMSEA = .11, also points out that the first hypothetical model did not adequately explain the data. That is, it seems to be concluded that the model 1 based on the theory of planned behavior cannot be directly adopted to predict and understand the phenomenon of how much elementary teachers are willing to change their traditional teaching practices toward the reform-oriented way of teaching mathematics.

According to Kelloway (1998), it seems acceptable to modify the model and assess its fit if the collected data were from one sample. Two sources in the present study were considered for generating an alternative model, such as correlation among the variables and theoretical grounds. Correlation analyses among the variables pointed out that SN was significantly correlated with ABI at the level of $p = .01$. This result indicated that the indirect measure of attitudinal beliefs shared its variance with subjective norm. Theoretically, it was not surprising that attitudinal beliefs was associated with subjective norms, considering that teachers' behavioral beliefs are influenced to some degree by expectations of some important others regarding teaching mathematics through a students-centered way (Raymond, 1997). Thus, an alternative model (model 2) was generated as a result of examining model 1. As shown in figure 1, one more path for the alternative model was added from subjective norm (SN), a latent independent variable, to an observed variable of attitude about the behavior (ABI).

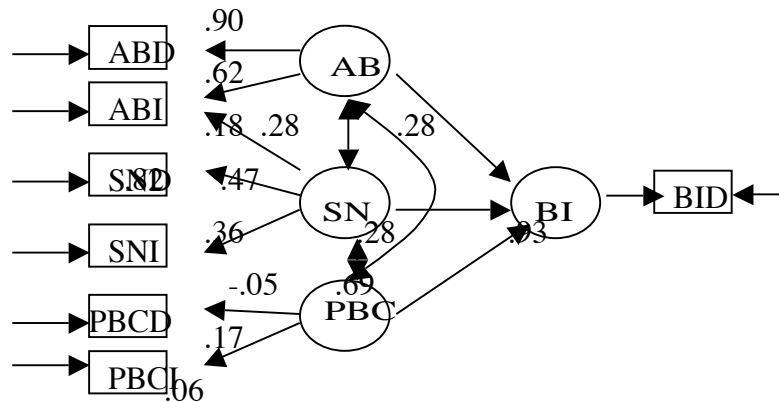

Figure 1. A structural equation of TPB model 2.

The results of measurement part of model 2 shown in figure 1 present that AB accounts for 81 percent of the variance in the direct measure of attitudinal beliefs (ABD). It can be interpreted that its reliability is at least 0.81 (Arbuckle & Wothke, 1995). Similarly, SN explains about 67 percent of the variance in SND. The Analysis of model 2 for the structural part presents the results of causal relationships among the latent variables used for the model. As in model 1, fit indices using maximum likelihood estimation were used to assess the adequacy of the structural part of model 2. Fit indices of both χ^2 (18.39) and χ^2/df (1.84) indicated that model 2 moderately fit the data ($p = .05$). Additionally, the value of RMSEA (.06) suggested that model 2 is an acceptable fit to the data. Thus, we may conclude that model 2 generated on the basis of theoretical grounds and exploratory analysis significantly improved the fit of the model to the data, implying that the revised model of theory of planned behavior better fit the data on teachers' change in mathematics teaching practice.

A particular interest in this study was given to whether the TPB model can be applied to the reform-oriented group of teachers regarding mathematics instructional practice. Thus, this study examined how well model 1 based on the theory of planned behavior fits the data, consisting of 177 reform-oriented elementary teachers toward mathematics instruction. Results for the reform-oriented group of teachers indicated the significant improvement regarding the prediction of latent variables on observed variables. For instance, attitudinal beliefs account for 67 and 70 percents of ABD and ABI, respectively, while 80 and 65 percents of variances in SND and SNI are accounted for by teachers' beliefs about important others. Considering the relationships among the latent variables, the standardized path coefficients for the structural portion of the model showed that teachers' behavioral intention to teach mathematics in a reform-oriented way was best predicted by their attitudinal beliefs with $\beta = .60$. The values of χ^2/df (1.38) with $p = .17$ and RMSEA (.05) indicated that the original TPB model is a good model for the data. This result implies that the theory of planned behavior appropriately explains regarding predicting and understanding the structure underlying reform-oriented teachers' willingness to teach mathematics in a students-centered way.

CONCLUSION

This study used a quantitative approach to provide a general perspective of how much teachers are willing to change their traditionally-oriented teaching practices toward reform-oriented way of teaching mathematics. The results indicate that the theory of planned behavior provides an adequate explanation on teachers' instructional change in mathematics. The present study shows that teachers' willingness to teach mathematics in a students-centered way is significantly influenced by teachers' attitudinal beliefs toward the reform-oriented way of teaching mathematics, their perceptions about important others (e.g., students and parents), and some control difficulties (e.g., shortage of instructional resources and teacher/students ratio). The findings of the present study support belief-based teachers' education programs, focusing on changing teachers'

traditionally-oriented perspectives on teaching mathematics toward the reform-oriented way.

The analysis on the reform-oriented group of teachers indicates that the theory of planned behavior as a research framework is well fitted to the data. This finding implies that the model might be more useful for explaining the reform-oriented group of teachers than the traditionally-oriented group of teachers. In other words, teachers with reform-mind tend to have more favorable perception about teaching in a students-centered way. Hence, they are more highly expected to accept the reform-oriented way of teaching mathematics.

The findings of the present study demonstrate what mathematics educators, teacher educators, and reform leaders need to know and what they should do to help teachers become reform-minded. In light of these findings, the effectiveness of teacher education programs for elementary teachers in Korea needs to be reconsidered. For instance, teachers participating in this study negatively evaluated the effectiveness of teacher education programs and noted the lack of opportunities to learn about reform-oriented instructional practices. By identifying factors essential to effective teaching, this study also enables mathematics teachers to follow the recommendations suggested by reform documents for mathematics.

References

- Ajzen, I., & Fishbein, M. (1980). *Understanding attitudes and predicting social behavior*. Englewood Cliffs, NJ: Prentice-Hall.
- Arbuckle, J. L., & Wothke, W. (1995). *Amos 4.0 user's guide*. Chicago, IL: SmallWaters Corporation.
- Brown, C. A., & Borko, H. (1992). Becoming a mathematics teacher. In D. A. Grouws (Ed.), *Handbook of research on mathematics teaching and learning* (pp. 209-239). New York: Macmillan.
- Crawley, F. E., & Kobala, T. R. Jr. (1994). *Attitude research in science education: Contemporary models and methods*. *Science Education*, 78(1), 35-55.
- Fishbein, M., & Ajzen, I. (1975). *Belief, attitude, intention and behavior: An introduction to theory and research*. London: Addison-Wesley Publishing.
- Franke, M., Fennema, E., & Carpenter, T. (1997). Changing teachers: intentions between beliefs and classroom practice. In E. Fennema & B. S. Nelson (Eds.), *Mathematics teachers in transition* (pp. 225-282). Mahwah, NJ: Lawrence Erlbaum Associates.
- Kalivoda, K. S., & Higbee, J. L. (1998). Influencing faculty attitudes toward accommodating students with disabilities: A theoretical approach. *Learning Assistance Review*, 3(2), 12-25.
- Kelloway, E. K. (1998). *Using LISREL for structural equation modeling: A researcher's guide*. Thousand Oaks: SAGE Publications.
- Kline, R. B. (1998). *Principles and practice of structural equation modeling*. New York: Guilford Press.

- Kobala, T. R. Jr., & Crawley, F. E. (1992). Attitude-behavior change in science education: Part III, results of an ongoing research agenda. (*ERIC Document Reproduction Service No. ED 356 142*).
- Lubienski, S. T., & Bowen, A. (2000). Who's counting? A survey of mathematics education research 1982-1998. *Journal for Research in Mathematics Education*, 31(5), 626-633.
- Raymond, A. M. (1997). Inconsistency between a beginning elementary teacher's mathematics beliefs and teaching practice. *Journal for Research in Mathematics Education*, 28(5), 550-576.
- Thompson, A. G. (1992). Teachers' beliefs and conceptions: a synthesis of the research. In D. A. Grouws (Ed.), *Handbook of research on mathematics teaching and learning* (pp. 209-239). New York: Macmillan.

•

Page Intentionally Left Blank

CHARACTERISTICS OF 5TH GRADERS' LOGICAL DEVELOPMENT THROUGH LEARNING DIVISION WITH DECIMALS

Masakazu Okazaki

Joetsu University of Education, JAPAN

If we consider the gap between mathematics at elementary and secondary levels, and the logical nature of the higher level, it is important that aspects of children's logical development in the latter grades in elementary school be clarified. We focused on 5th graders' learning "division with decimals" as it is known to be difficult to understand in its meaning because of the implicit model. We discuss how children may develop logic beyond the implicit model in terms of formational operational thinking. We suggested that children's explanations based on two kinds of reversibility were effective to overcome the model, and that the overcoming processes enabled them to conceive multiplication and division as a system of operations.

INTRODUCTION

In learning operations with decimals or fractions, children tend to acquire only the mechanistic procedures like "invert and multiply" in division with fractions. However, if the gaps between primary mathematics and that at secondary levels are considered, mindful of the logical nature of the latter, we think it necessary to encourage children to develop their logical reasoning in upper grades at elementary school.¹

Previous studies on the operations reported that the implicit model (e.g. Fischbein *et al.*, 1985) had a great influence on the child's decision making in solving problems. Recently such phenomena have been examined extensively as the intuitive rule theory (Tirosh and Stavy, 1999). However, the following problems are still existent; De Bock *et al.* (2001) listed similar research tasks. In what stages may the implicit model be overcome in learning operations with decimals or fractions, and how will children develop their logical reasoning in the overcoming process. To clarify these tasks, this study analyzes the characteristics of 5th graders' development of logical reasoning through classroom lessons on division with decimals.

THEORETICAL BACKGROUNDS

(1) Formal operational thinking

Inhelder and Piaget (1958) used the notion of "formal operation" to characterize adolescent thinking starting from about 11 years of age. They noted that, (a) it can proceed from some hypothesis or possibility, (b) it can be characterized as propositional

¹ In Japanese educational system, the elementary school continues from 1st to 6th grades, lower secondary school from 7th to 9th grades, and upper secondary school from 10th to 12th grades.

logic by combining the statements $p \rightarrow q$, $p \rightarrow q$, $\neg p$, $p \rightarrow q$ (cf. Jansson, 1986), (c) the object for thinking is the generality of the law, the proposition, etc., and (d) it includes two kinds of reversibility. In (d), one reversibility is inversion, which enables one to “return to the starting point by canceling an operation which has already been performed” (Inhelder & Piaget, 1958, p.272), and the other one is reciprocity, which is related to “compensating a difference” (p.273) and is “required for equating operations which are oriented in opposite directions”(p.154). Later this notion is used to analyze the characteristics of 5th graders’ reasoning.

(2) Mathematical meaning and the child’s implicit model in division

We can assume that in learning division with decimals, the mathematical meaning predominates and the difference from the child’s model causes his/her difficulty. Here, we briefly examine two problems. (A) “If 12 apples are fairly shared among 3 persons, how many apples does one person get?” and (B) “The price of 2.8 m of ribbon is 560 yen. How much does 1 m cost?” The both have a same structure because each answer is the quantity-per-unit and permit proportional reasoning. Mathematically saying, “If (a, b) is any ordered pair of rational numbers and $(a, b) \sim (ma, mb)$ [m : integer], the relation ‘ \sim ’ is equivalent. Then (partitive) division means to transform the element (a, b) into (quotient, 1) of the equivalent class $(a: \text{dividend}, b: \text{divisor})$ ”.

However, children’s conceptions of problem (A) and problem (B) are very different. Though division with integers permits one to imagine the situation that divides something into equal parts and to have the model that division makes the answer smaller, division with decimals doesn’t permit this thinking. Instead, the latter must be conceived proportionally. For example, $560 \div 2.8 = 200$ should be reinterpreted that 560 is to 2.8 what 200 is to 1. In the following we will focus on how this reinterpretation might occur and children develop their reasoning in the process.

METHODOLOGY

Data were collected from a fifth grade classroom in a university-attached school (20 boys and 18 girls). 7 lessons, in which the topic was division with decimals, were recorded by video camera and field notes.

During the first two lessons division problems were solved and discussed in which the divisors were bigger than 1 (e.g., “The price of 2.4 m of ribbon is 108 yen. How much does 1 meter cost?”), and the following ideas were constructed.

(a) There are many situations that are same as what 108 yen is to 2.4 m. (e.g., 216 yen is to 4.8 m; 540 yen is to 12 m; 1080 yen is to 24 m).

(b) If we multiply each number by 5 or 10, we can transform the problem into a division with integers (e.g., $108(\text{yen}) \div 2.4(\text{m}) = 1080(\text{yen}) \div 24(\text{m}) = 45$).

(c) We can solve by firstly finding the price of 0.1 m (e.g., $108(\text{yen}) \div 24 \cdot 10 = 45$).

Though the teacher next presented the problem in which the divisor is less than 1 (“The price of 0.8 liter of juice is 116 yen. How much does 1 liter cost? ”), they easily made the expression “ $116 \div 0.8$ ” and found the answer utilizing the thinking in (b) or (c) above.

However, when teacher asked them to explain what the expression ($116 \div 0.8 = 145$) should represent in the 3rd lesson, they began to feel uncertain and the cognitive state of disequilibrium became apparent (Piaget, 1985).

C1: 116 divided by 0.8... Why is the expression right? It might not be 145.

CA (Children; affirmative): It must be 145.

C1: It might be 145, but the answer for the problem is not 145 yen.

CA: Why? It must be 145 yen.

T: If 116 yen is to 0.8 liter, then 145 yen is to 1 liter. Is that wrong?

C2: I think the answer is the price of 0.1 liter.

C3: I also think that if we do $116 \div 0.8$, we get the price of 0.1 liter.

CN (Children; negative): I agree!

CA: No, its wrong!

Some children considered the answer 145 as the price of 0.1 liter. We consider this the influence by the implicit model “division makes the answer smaller”; for such phenomena didn’t come up in the previous lessons. Analyses that follow are devoted to the stages and characteristics during the time children were overcoming the difficulties.

PROCESSES OF OVERCOMING THE IMPLICIT MODEL

Logical explanations and the robustness of the implicit model

The idea “the answer of the expression is the price of 0.1 liter” was soon refuted.

C4: If 145 yen were to 0.1 liter, then 0.1 liter was more expensive than 0.8 liter.

C5: We must do $116 \div 8$ in order to work out the price of 0.1 liter.

C6: (After pointing that both $116 \div 0.8$ and $580 \div 4$ have the same answer) If we divide by 4 liter, of course the answer is the price of 1 liter. The idea of 0.1 liter is strange.

C7: ...(Referring to the expression $116 \div 8_{10}$) If we put this 10 in front, it is the same as $1160 \div 8$. So, I think this ($116 \div 0.8$) summarizes these expressions which were made to get the price of 1 liter of juice.

We can find the initial form of deductive reasoning in the above explanations. For example, C6’s utterance is interpreted as the reasoning that P3 is deduced from P1 and P2.

P1: If we divide 580 by 4, we get the price of 1 liter. (Agreed)

P2: $580 \div 4$ can be equivalently changed into $116 \div 0.8$. (Agreed)

P3: Therefore, $116 \div 0.8$ is the expression for finding the price of 1 liter.

It should be noted that such syllogism occurred through intersubjective conflict (Cobb, Yackel, Wood, 1993). However when the teacher asked children whether they feel the expression uncertain at the beginning of the 4th lesson, 70 % of them disclosed their feeling of uneasiness.

C8: Though I don’t know the reason, even with the division the quotient is bigger... than the dividend.

C9: I can understand that if we divide something by 2, we get half. But I don't know how we get 145 when we divide by 0.8.

T: Do you think that "divided by 0.8" is a problem?

Cs (Some children): Yes. It's unclear and strange.

Most children implicitly experienced the cognitive state of disequilibrium. This episode suggests that even if logical explanations are given, they aren't sufficient to overcome the disequilibrium resulting from the implicit model. Though the expression $116 \div 0.8$ was transformed into the other expression (e.g. $1160 \div 8$), it seems that the implicit model does not vanish without discussing what "divided by 0.8" itself means.

The process of equilibration based on the reversibility "inversion"

The equilibration began from a child's utterance based on the inverse operation.

C10: It is not good to consider $116 \div 0.8$. By reversing it, if we think of the problem as "The price of 1 liter of juice is 145 yen. How much does 0.8 liter cost?", it will be 116 (He calculated it)... I got it. So, division means ... even if the divisor may be a decimal or an integer, the answer is... 1 liter... to get 1 liter.

This opinion was very powerful and most children began to regard $116 \div 0.8$ valid as an expression for finding the price of 1 liter. Here it should also be noted that this explanation included the meaning of division (the quantity-per-unit). But the student's opinion was soon rejected because it had the character of checking after solving the division. The next child made the point more explicit. "If it is 116 times 0.8^2 , I can regard it to take 0.8 piece of 116. But, please tell me how do we do $116 \div 0.8$ ".

It seems that most children wanted to conceive the division as a concrete operation. The explanation based on the inverse operation was strong, but it still remained a concrete world, and they needed further explanations to attain a state of equilibrium.

The process of equilibration based on the reversibility "reciprocity"

In the second half of the 4th lesson, the teacher reflected on the previous activities on the number line, and proposed to rewrite it as a schema of proportion (fig.1); asking the children to consider the meaning of "divided by 0.8" on the abbreviated schema (fig.2).

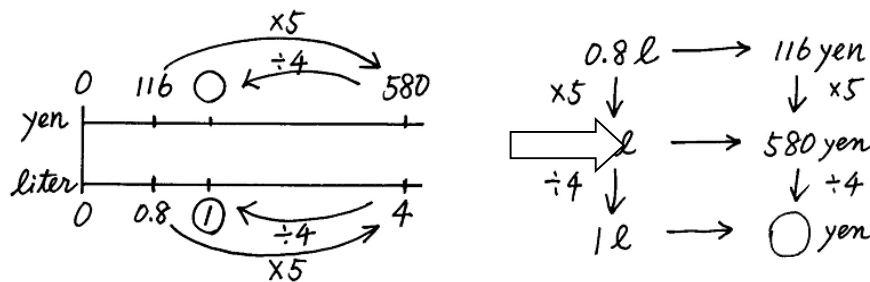

Fig.1 the activity on the number line and the translation to the schema of proportion

² In the Japanese notational system, we write 300_5 as the expression for the problem "The price of one apple is 300 yen. How much do 5 pieces of apples cost?" which is different from the English system.

T: Let us discuss by using these two parts.

C11: (He wrote on the blackboard “1.25” beside the left blank)

T: Really?

C11: 0.8 liter is 116 yen and 1 liter is 145 yen. I think some multiple of 0.8 liter is 1 liter. I calculated “1 divided by 0.8”. I found 1.25.

T: Wait. 1 divided by 0.8? Oh, it’s 1.25.

C11: If we multiply 0.8 by 1.25, then of course we must also multiply the price by 1.25. So 116 times 1.25 is 145.

Cs: Yes. It’s the same.

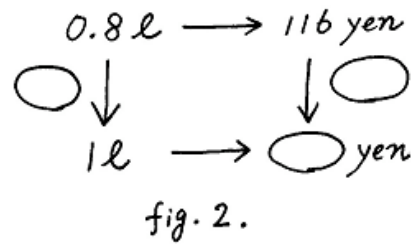

Though the teacher had expected them to put “÷0.8” into the blank, actually “□1.25” was natural for them. Next they reinterpreted their familiar expressions, e.g. $116 \square 10 \div 8$ as $116 \square 1.25$ and had still more confidence in the idea “□1.25”. Here, teacher tried to direct their focus to the relation between “□1.25” and “÷0.8”, though his orientation was suggestive.

T: This is “times 1.25”. Can you represent it by using division? By what do you divide 0.8 liter in order to get 1 liter?

C12: We divide it by 0.8.

T: If you divide 0.8 by 0.8, you get 1. Then by what do you multiply 1 liter in order to get 0.8?

C13: We multiply it by 0.8.

T: If we multiply 145 by some number, we get 116. What is the number?

C14: Oh, it’s 0.8.

T: Is there anything you notice?

C15: “□1.25” and “÷0.8” are same.

T: Everyone, check whether “÷0.8” is same to “□1.25”.

Cs: Oh, they are same.

T: Really? Can you say that this $(116 \div 0.8)$ is same as “116_1.25”?

C16: Yes. The same. It’s natural that the answer is bigger than the dividend.

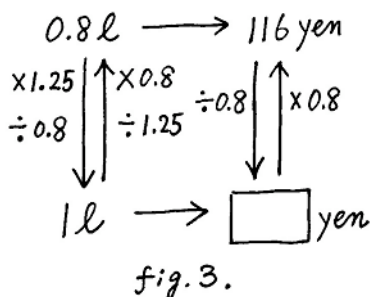

They made sense of “÷0.8” in terms of the “□1.25” that they had confidence in. In the 5th lesson the teacher and children again discussed those relations, and summarized as in fig.3. It then seemed that they were clearly conscious of the reciprocal relations and fully understood why we should divide by 0.8 and why the answer would then be bigger than the dividend.

DISCUSSION: THREE STAGES OF LOGICAL DEVELOPMENT

We found that there were three stages in children's logical development as they made sense of division with decimals.

Firstly, they conceived division by a decimal by drawing pictures or manipulating concrete objects. For example, they replaced the situation "108 yen per 2.4 m" with "540 yen per 12 m" by connecting 5 pieces of strip that represented 0.8 m of ribbon and solved it as the division by an integer.

Secondly, they began to reason at the hypothetical-deductive level, detached from the concrete level. Also, their object for reasoning was changed from the answer to the mechanism of the expression. The change occurred through their trials of refuting the idea that $116 \div 0.8 = 145$ was representing the price per 0.1 liter, which was influenced by the implicit model. In this justification process, they developed the syllogistic reasoning by combining some given facts, and sometimes operated on the expression itself; like C7's utterance above. Though these explanations show some characteristics of a formal operation, they didn't attain the cognitive state of equilibrium because of the obstinacy of the implicit model.

Thirdly, they constructed two explanations; each corresponded to two kinds of reversibility. One explanation was based on the inverse operation. It was when C10 inversed the division into the form of multiplication that they firstly realized the correctness of the expression. However, more explanations were needed because the multiplication had the character of checking after solving the division problem. Next they made sense of the expression by using multiplication in another way. It was to consider " $\div 0.8$ " as equivalent to " $_1.25$ " which was the flipside of the same coin. It was more natural for them to consider the operation changing 0.8 into 1 as " $_1.25$ " than as " $\div 0.8$ " because they had appreciated that $_1.25$ makes the answer bigger. We can deduce that this eventually led them to conceive multiplication and division as a system of operations, in other words to acquire formal operational thinking.

Here it should be noted that the above stages emerged not linearly, but as equilibration processes in which temporal regressions (disequilibriums) were often involved and more coherent ideas were constructed by coordinating some ideas with each other every time a temporary state of equilibrium was achieved.

Finally, we discuss mathematical characters of children's explanations, which were more or less logical even when the implicit model was not overcome, i.e. at the second stage. There are such properties in division as:

$$P1: a \div b = (a \square m) \div (b \square m); P2: (a \square m) \div b = (a \div b) \square m; P3: a \div (b \square m) = (a \div b) \div m;$$

$$P4: a \div b = (a \div m) \div (b \div m); P5: (a \div m) \div b = (a \div b) \div m; P6: a \div (b \div m) = (a \div b) \square m.$$

Property 1 and 6 emerged frequently (P1: $116 \div 0.8 = 1160 \div 8$; P6: $116 \div 0.8 = 116 \div 8 \square 10$) and the others were also used, though maybe implicitly. For example, in C7's utterance "If we put this 10 in front, it ($116 \div 8 \square 10$) becomes the same as $1160 \div 8$. So, I think this ($116 \div 0.8$) summarizes these expressions", we can find P2 and P4. However, further

research will be needed to clarify how these cognitive states develop into secondary mathematics.

FINAL REMARKS

Findings from this study are:

1. Logical parts, and parts sustained from the implicit model coexisted in 5th graders' reasoning.
2. It was not sufficient for overcoming the model to conceive division proportionally, since the model was more realistic and the expression of division was replaced with another expression.
3. Reasoning based on two kinds of reversibility contributed to overcoming the difficulties, and formal operational thinking was attained in the process. In particular, recognizing the reciprocal relations of operations made their adherence vanish, for the previous image (p) and the constructed image (_p) were combined (p__p), so they no problem deciding whether the answer was smaller or not.

We think it important to study how we can help children to develop logical thought under conditions that their implicit models are made explicit in order not to detach newly learned knowledge from children's minds.

References

- Cobb, P. *et al.* (1993). Theoretical orientation. *JRME Monograph 6*, Chap.3, 21-32.
- De Bock, D. *et al.* (2001). Do intuitive rules have predictive power? *Proceedings of the 25th PME*, 2, 321-328.
- Fischbein, E. *et al.* (1985). The role of implicit models in solving verbal problems in multiplication and division. *JRME*, 16, 1, 3-17.
- Inhelder, B. and Piaget, J. (1958). *The Growth of Logical Thinking from Childhood to Adolescence*. (trans. by A. Parsons and S. Milgram). Basic Books.
- Jansson, L. (1986). Logical reasoning hierarchies in mathematics. *JRME*, 17, 1, 3-20.
- Piaget, J. (1985). *The Equilibration of Cognitive Structure*. The University of Chicago Press.
- Tirosh, D. & Stavy, R. (1999). Intuitive rules: A way to explain and predict students' reasoning. *ESM*, 38, 51-66.

•

Page Intentionally Left Blank

NATHAN'S STRATEGIES FOR SIMPLIFYING AND ADDING FRACTIONS IN THIRD GRADE

John Olive

The University of Georgia

Nathan entered third grade having already constructed a Generalized Number Sequence (GNS) for whole numbers that enabled him to coordinate sequences of multiples to find a common multiple of two whole numbers. Nathan was able to apply the operations of his GNS to his understanding of part-whole relations and his emerging use of fractional language, in order to rename fractions generated through iterations of unit fractions (e.g. $\frac{3}{8}$ as another name for six iterations of $\frac{1}{16}$). Through structured teaching episodes, Nathan was eventually able to find common partitions for different unit fractions and use the common partition to produce (and name) the sum of the two fractions. The on-screen actions with the computer manipulatives, used in this teaching experiment, were both engendering and constraining for Nathan's construction of these mental strategies.

THE CONSTRUCTIVIST TEACHING EXPERIMENT¹

The research reported in this paper is part of an on-going retrospective analysis of videotaped data from a three-year constructivist teaching experiment with 12 children (Steffe & Olive, 1990; Steffe, 1998). A team of researchers began working with the children at the beginning of their third-grade and continued through the end of their fifth grade year in a rural elementary school in the southern United States. Pairs of children worked with a teacher/researcher using specially designed computer tools (TIMA) (Olive, 2000). The major hypothesis to be tested was that children could reorganize their whole number knowledge to build schemes for working with fractional quantities and numbers (the rational numbers of arithmetic) in meaningful ways (Olive, 1999; Steffe, 2002).

Previously Reported Results.

At PME 25 and PME 26 I reported how two children (Joe and Patricia) who had constructed an *Explicitly Nested Number Sequence (ENS)* (Steffe and Cobb, 1988) were able to construct iterable unit fractions and commensurate fractions during their second year (fourth grade) in the teaching experiment (Olive, 2001, 2002). In this report, I focus on the strategies that Nathan developed during the first year of the teaching experiment (third grade) that were based on his *Generalized Number Sequence (GNS)* (Steffe and Cobb, 1988). The GNS is a generalization of the operations on units of the ENS to composite units. It marks the transition from an "ones" world to a world of composite units.

¹ The teaching experiment was supported by grant number RED-8954678 from the National Science Foundation (NSF) in the United States. The retrospective analyses are being conducted under grant number REC-9814853, also from the NSF. Both grants are co-directed by Dr. Leslie P. Steffe and Dr. John Olive of the University of Georgia. All results and opinions in this paper are solely those of the author.

While a detailed report of Nathan's advanced multiplicative operations on fractions, developed during his fourth and fifth grades in school, has been published elsewhere (Olive, 1999) this report will be the first publication of Nathan's strategies developed during the first year of the teaching experiment (his third grade in school). A comprehensive publication that will report the complete retrospective analysis of the key case studies from the Project is currently being assembled (Steffe & Olive, in press).

The Special Case of Nathan

Nathan was a special case in a very important aspect of our teaching experiment: we were attempting (as teacher/researchers) to build models of the children's schemes for operating with fractions. Because I had been engaging in mathematical conversations with Nathan for many years (he is my son), my models of Nathan's mathematical schemes were much more viable than my emerging models of the schemes of the other children in the project. I was able to travel with Nathan along his reasoning paths and could provide meaningful signposts at critical junctions in those paths. I was not able to do this as successfully with the other children in the project, which was sometimes frustrating for them and for me! Nathan was also my "test pilot" for the TIMA software and so was more familiar with the actions available to him when using these tools.

Our goals for working with Nathan in the project were to take advantage of his special relationship with me, with the computer tools and with mathematics in order to map out possible ways in which the children might make use of the computer tools to construct their own strategies for operating with fractions. He was able to show us what was possible and demonstrate the enabling power of a GNS in constructing meaningful operations on fractions.

THE EVIDENCE FOR NATHAN'S GENERALIZED NUMBER SEQUENCE

Early in our work with Nathan he demonstrated evidence of a GNS when working with a problem involving coordination of two composite units (a three and a four). The problem had been posed within the context of our TIMA: Toys computer environment (Olive, 2000). Nathan was asked how many strings of three toys and strings of four toys would be needed to make a string of 24 toys. Nathan reasoned out loud as follows:

Three and four is seven; three sevens is 21, so three more to make 24. That's four threes and three fours!

Nathan created an iterable seven consisting of an iterable three and an iterable four. He used his units-coordinating scheme and unit segmenting scheme (Steffe, 1992) to produce 21 as the result of iterating seven three times and then saw 24 as requiring one more iteration of his three-string. Nathan had constructed 24 as a partitioned unit with two sub-partitions: three fours and four threes. He also used his decomposed seven later in the same episode to work out seven times eight: "That's 32 and 24!" -- strong confirmation that part-whole operations were available operations within his units-coordinating scheme.

DEVELOPING A LANGUAGE OF FRACTIONS

When we first started working with Nathan and his partner, Drew, on simple sharing tasks using the TIMA: Bars software (November of third grade), both children

demonstrated a naïve use of fraction language to describe the shares they created. For both children, their fraction words were associated with the number of visible parts in a share, not to a part-whole relation (e.g. when sharing 3 bars among 4 people, the share of one person consisted of 3 of 4 strips of one bar, that they named as one third “because there are three rows”). They also appeared to only have words for unit fractions (a fourth and a third). Nathan eventually related the unit fraction to the number of parts in the whole rather than the number of parts in one share.

During the next two teaching episodes (two weeks later) Nathan and Drew began to use a language of parts that made sense to them. They had set themselves the problem of sharing two bars among three mats. They had partitioned each bar into 36 parts (six rows of six parts each). They eventually found that each mat would get four rows each and that would make 24 parts each. Drew at first named the share of one mat “one fourth” (because the share consisted of four rows) but Nathan disagreed because there were *six* rows in each bar, so it couldn’t be “fourths.” They eventually came up with “four parts out of six” but did not have a fraction name for this quantity.

After working with Nathan and Drew for two months (through December) with TIMA: Bars, Nathan had constructed a meaningful language of fractions that included both mixed numbers and improper fractions. He could also create a whole bar given an unpartitioned part of the bar (e.g. make a whole bar given $\frac{2}{7}$ of the bar). The language was *internalized* in that it represented mental images of subdivided and subdivisible regions. It may not, at this point in time, have been *interiorized* in that the representations were still figurative rather than abstract quantities.

DEVELOPING OPERATIONS ON FRACTIONS

Nathan was asked in the last session of January to find out how much of a bar he would have if he joined a half of one bar with a third of another, congruent bar. His first response was “a whole bar!” He saw that he was wrong after carrying out the actions with TIMA: Bars and eventually reasoned that a whole bar would be a half plus a half. His strategy for finding a fraction to describe the half plus a third was, again, figurative. He tried different partitions and made visual comparisons. Three fourths was not quite right so he then tried sixths. Four sixths wasn’t big enough so he tried five sixths and found that it was the same size as the half plus a third. He described the amount, however, as “one sixth less than a whole bar!” The next series of episodes were designed to help Nathan construct a scheme for making commensurate fractions (Olive, 2002).

Renaming Fractions

In the first two sessions in February, Nathan began to reason multiplicatively when finding new names for fractions. In the first session he was asked to shade $\frac{1}{4}$ of a 12-part bar and reasoned that it would be three parts because “four threes in 12, so three pieces make one fourth.” Such reasoning was in stark contrast to Nathan’s reasoning in the first sharing activities the previous November. He no longer associated the fraction name with the number of parts in a share (3). Instead, the fraction ($\frac{1}{4}$) was firmly associated with the *multiplicative* relation between the share (number of parts) and the whole. Nathan had been able to make this important shift in a very short time span

because he could reason with composite units in the same way that Joe (Olive & Steffe, 2002) could reason with singleton units.

In the second session he was set the task of making as many different fractions as possible from a 12-part bar. He was asked to copy one of the 12 parts and asked what fraction this was; he responded with “one twelfth.” [Note: all of the fraction names were given verbally; there was no written symbolism at this point. For purposes of brevity I shall use the normal ratio notation to refer to the verbal fraction name.] He was asked to make $\frac{1}{2}$ and $\frac{1}{3}$ with this $\frac{1}{12}$ part. He had no problem with these fractions, making $\frac{6}{12}$ and $\frac{4}{12}$ respectively. He also named them in terms of the twelfths. He was next asked how many twelfths in $\frac{2}{3}$? This question confused him initially. Eventually he said: “Oh! Now I’ve got it -- $\frac{1}{3}$ is $\frac{4}{12}$ so $\frac{2}{3}$ would be $\frac{8}{12}$!” He went on after this to work with fourths: “ $\frac{1}{4}$ is $\frac{3}{12}$, $\frac{9}{12}$ is $\frac{3}{4}$, $\frac{6}{12}$ is a half which is $\frac{2}{4}$.”

Even though Nathan appeared to be reasoning with progressive numerical integrations and using both his whole number units-coordinating and unit-segmenting schemes (Steffe, 1992) the next question from the teacher indicated that these schemes were undergoing functional modifications and were in a fragile state of flux. The teacher asked Nathan if he could do the same thing for fifths. Nathan responded: “That would be $\frac{5}{12}$, $\frac{10}{12}$.” The teacher did not respond immediately and Nathan eventually asked: “Is it possible with fifths?” The teacher asked Nathan what he had done. Nathan indicated the $\frac{5}{12}$ -piece that he had created and said “ $\frac{5}{12}$ in $\frac{1}{5}$.” The teacher suggested he check that. Nathan copied the original bar, wiped it clean and partitioned it into 5 parts. He made visual comparisons between the twelfths and the fifths and eventually said: “You can’t make $\frac{1}{5}$ out of $\frac{1}{12}$ because it’s not even.”

Nathan continued with his task, making all the possible sixths and also skipping sevenths “because it’s not even!” He was not sure about eighths. The teacher asked him: “What would 8 pieces be?” Nathan replied “ $\frac{8}{12}$.” When asked to think of another fraction name for $\frac{8}{12}$ Nathan reasoned that: “4 pieces is $\frac{1}{3}$, $\frac{2}{3}$ is 8 pieces, so $\frac{2}{3}$ is $\frac{8}{12}$.” He then reasoned that $\frac{9}{12}$ would be $\frac{3}{4}$ because “3 pieces is $\frac{1}{4}$ and $3+3+3$ is $\frac{9}{12}$.” When asked what $\frac{10}{12}$ would be he responded that “2 pieces would be $\frac{1}{6}$ so would it be $\frac{5}{6}$?” He was later asked what $\frac{3}{6}$ and $\frac{1}{3}$ would be together. He reasoned as follows: “ $\frac{3}{6}$ would be 6 and $\frac{1}{3}$ would be 4, so 6 and 4 is 10 -- $\frac{10}{12}$.” The teacher asked what it would be in sixths? Nathan replied: “Oh! 2, 4, 6, 8, 10 -- so it’s $\frac{5}{6}$!” Nathan had used the equivalence of $\frac{2}{12}$ in $\frac{1}{6}$ to count by two’s up to 10 (a unit-segmenting activity) and produced the commensurate fraction of $\frac{5}{6}$ (a units-coordinating activity between units of $\frac{1}{12}$ and $\frac{1}{6}$).

The above illustrates the enabling power of Nathan’s GNS to both unitize and unite composite unit items that were now iterable unit fractions rather than iterable ones. Nathan was able to reason with three levels of units (the 12-part whole, any one part of that whole and any sub-composite unit of parts), maintaining the multiplicative relations among all three levels. He was able to do so because he had abstract composite units available to him prior to action. The teacher had helped Nathan make the renaming of fractions explicit through this activity. This episode marked the beginning of the

interiorization of Nathan's fractional language and the *internalization* of his operations on fractions.

Finding Common Partitions for Different Fractions

In the above episode, Nathan was given a partitioned bar (a 12-part bar) and asked to make other fractions using the partitioned bar. Our goal in the next sequence of episodes was for Nathan to construct a scheme for finding a common partition of a bar so that he could make two different fractions from the same bar. The first task that we used proved to be very confusing for Nathan. He was given two bars of the same size: one partitioned into 5 parts and the other into 3 parts. He was asked to cut the two bars into equal sized parts so that children could have the same amount from each bar.

Nathan: How can they get equal pieces without using the same number!?

Teacher: That's right! -- You've got to find out how to cut them into equal pieces.

Nathan: Give me a sheet of paper.

(The teacher did not supply a sheet of paper so Nathan proceeded to use the mouse to draw numerals on the computer screen! He made a 10 and a 6.)

Nathan: I would go 6, 12, --- 15. Ah! I have found it!

(Nathan wiped both bars clean, made two mats and partitioned each bar into 15 parts.)

Teacher: (Pointing to the first bar) How many fives are here?

Nathan: Three fives.

Teacher: (Pointing to the second bar) How many threes are here?

Nathan: Five threes. Oh! So there's 3 fives and 5 threes!

Once Nathan had realized that he had to use the original partitions of the bars to make further partitions he came up with the strategy of comparing multiples of each partition until he arrived at a common multiple (15). The act of forming the numerals for the second multiple of each partition (10 and 6) appeared to have been a critical act for Nathan. Was it simply a matter of providing an anchor of clarity in what had become a very confusing situation? Or did it indicate that the strategy Nathan was forming was based on the numerical relations among his interiorized composite units and as such he needed to focus on the numbers rather than on the partitioned bars?

The following episode (5 days later) indicated that Nathan's strategy for finding a common partition was well established. Given a 5-part bar and a 7-part bar he compared multiples of 5 and 7, talking out loud, until he arrived at 35. He repartitioned each bar into 35 parts and (at the teachers suggestion) filled each of the sevenths (consecutive groups of 5 parts) in one bar a different color and each of the fifths (consecutive groups of 7 parts) in the other bar a different color.

The next episode (two weeks later) confirmed that Nathan's strategy for finding a common partition for two congruent bars was indeed based on the interiorized abstract composite units of his generalized number sequence (Steffe, 1992). Given a 9-part bar and a 12-part bar, Nathan chose 36 as a common partition. He explained his choice *before acting* by saying "9 goes into 36 four times and 12 goes into 36 three times!" He then repartitioned the 9 vertical parts in the first bar with 4 horizontal parts and the 12

vertical parts in the second bar with 3 horizontal parts. His teacher then posed the problem of a 24-part bar and a 6-part bar. Nathan immediately said “That’s easy!” and made a horizontal partition of four parts over the six vertical parts of the second bar. He explained that “6 goes into 24 four times.”

Nathan’s strategy for finding a common partition (or lowest common multiple) indicated a coordination of both partitioning and segmenting operations, both of which could be reversed and used recursively. Nathan was able to posit an unknown partition of both bars that contained the 9 parts and the 12 parts (for instance). In order to find that unknown he created multiples of the existing partitions. But this operation represented, at each stage, a repartitioning of the unit whole NOT an iteration of the existing parts. He implicitly knew that by *splitting* each of the nine parts in two he doubled the number of total parts, but this splitting operation had been curtailed -- he went directly to doubling (and then tripling etc.) the number of parts. He used his segmenting operations with the composite units 9 and 12 to find the number that both would “go into.” He also used his units-coordinating scheme to keep track of how many times each of the existing partitions was used to find the common partition. The two results of these units-coordinations (four 9’s and three 12’s) were then used to repartition the unit bars, but in doing this the segmenting operation was reversed (or inverted) resulting in a further partitioning of each of the existing nine parts into four, and each of the existing 12 parts into three. Thus, “four nines” were transformed into “nine fours” and “three 12’s” into “12 threes”!

Finding the Sum of Two Fractions with Different Denominators

Although the above episode might suggest that Nathan’s scheme for finding common partitions of two different fractions was well established, he did not apply it automatically in subsequent episodes. When the context was changed slightly he used the computer manipulatives to make visual estimates for an appropriate common partition rather than reason numerically as he did above. He was able, however, to use the results of his common partitioning scheme to find the sum of the original two fractions as illustrated by the following episode.

The task situation was to form a union of two different fractions and find a fraction name to describe the sum. I set the problem of using a 3-part bar and a congruent 13-part bar. Nathan’s first action was to align the two bars as if checking for an immediate match between the partitions. He then started counting by threes. When he got to 39 he had made a record of 13 threes with his fingers. (He had run through the fingers of one hand twice for ten and had three fingers on the table to complete the 13.) He then partitioned the third, blank bar into 39 parts. He copied his $\frac{1}{3}$ piece and moved the copy over the 39-part bar to visually determine how many 39ths were needed to produce $\frac{1}{3}$. He did the same for the $\frac{1}{13}$ piece. When he had done this Nathan made the following comment:

Nathan: 39 and the 3 took 13 times to get to 39, so there are 13 pieces in it [the $\frac{1}{3}$], and the 13 took three times to get to 39 so there are 3 pieces in it [the $\frac{1}{13}$]!

Teacher: How much altogether?

Nathan: There are 13 plus 3 equals $\frac{16}{39}$ altogether!

Nathan appeared to have established an inverse relation between the multiples of 3 in 39 and the number of 39ths in $1/3$ (and similarly for the number of 39ths in $1/13$). This relation, however, may have only been a perceived regularity in his numbers rather than a logical deduction. To reinforce the logical connection I asked Nathan to make the 13 parts in the $1/3$ piece and the three parts in the $1/13$ piece (he did so). Nathan exclaimed: “The small pieces are the same size!” and then named them as 39ths.

I finally asked Nathan to find $1/4$ plus $1/7$. He immediately made a 28-part bar, a four-part bar and a seven-part bar (of equal size). He copied one part of the 4-part bar and dragged it up to the 28-part bar in order to determine how many $1/28$'s in a fourth! He did the same with $1/7$. He copied the appropriate number of $1/28$'s to make first $1/4$ then $1/7$. He joined these together and counted the parts to arrive at the solution of $11/28$! He had an extra $1/28$ part so I asked him if he could use that to make $1/4$ plus $1/7$. He immediately repeated it 11 times!

It appeared from this last activity that, although the numerical relations were becoming explicit for Nathan, the manipulations of objects in TIMA: Bars was a strong attraction that allowed him to use (lower level) visual strategies for finding his solutions. To effect a selection away from the visual solution to the addition of fractions problem, I asked Nathan (in the following episode) to tell me what he would do to find the sum of $1/4$ and $2/5$ *before* he did it. At first he said he did not know but I asked him to just tell me what he was going to do with the three candybars he had on the screen. [One was blank, one was in four parts and one in five parts. He had copied one fourth and two fifths.] He said he would make 20 parts in the top bar. I asked him why and he replied that both 4 and 5 “went into 20.” He then said that he would take five of the twenty parts for the $1/4$ and eight for the $2/5$ and join them together. I asked him what that fraction would be and he replied “ $13/20$!” I then asked him what $1/4$ plus $2/5$ was and he replied “ $13/20$.”

This episode confirmed for me that Nathan’s strategy for adding fractions with unlike denominators was now (at least) a figurative strategy that he could represent to himself without actually carrying out the operations using TIMA: Bars. It was now an *internalized* scheme for adding fractions.

DISCUSSION

Nathan’s schemes for simplifying fractions, finding common partitions for fractions with unlike denominators and for adding fractions were all developed through operations on fractional quantities. He was not taught any numerical procedures for these computations. Consequently, he was able to productively apply the computational operations he had constructed with whole numbers to these situations involving fractional quantities. His schemes for whole number multiplication and division, we conclude, were in the process of being reorganized to take into account the inverse relation between the number of parts and the size of a fractional part in relation to a unit whole. The iterable, abstract composite units of his GNS now included unit fractions and composites of unit fractions as items. Such a reorganization of whole number knowledge to incorporate fractional quantities is in contrast with the prevailing assumption that whole number knowledge is a “barrier” or “interferes” with rational number knowledge (Behr et al., 1984; Streefland, 1993), and points to ways in which we can help children avoid the

common mistakes they make when trying to apply computational procedures for adding fractions (e.g. add numerators and add denominators).

References

- Behr, M., Wachsmuth, I., Post, T., & Lesh, R. (1984). Order and equivalence of rational numbers: A clinical teaching experiment. *Journal for Research in Mathematics Education*, 14, 323-341.
- Olive, J. (2002). The construction of commensurate fractions. In A. Cockburn (Ed.) *Proceedings of the 26th Conference of the International Group for the Psychology of Mathematics Education (PME-26)*, 4, 1-8. Norwich, England: University of East Anglia.
- Olive, J. (2001). Connecting partitioning and iterating: a path to improper fractions. In M. van den Heuvel-Panhuizen (Ed.) *Proceedings of the 25th Conference of the International Group for the Psychology of Mathematics Education (PME-25)*, 4, 1-8. Utrecht: Freudenthal Institute.
- Olive, J. (2000). Computer tools for interactive mathematical activity in the elementary school. *International Journal of Computers for Mathematics Learning*.5(3), 241-262.
- Olive, J. (1999). From fractions to rational numbers of arithmetic: A reorganization hypothesis. *Mathematical Thinking and Learning*, 1 (4): 279-314.
- Olive, J. & Steffe, L. P. (2002). The construction of an iterative fractional scheme: The case of Joe. *Journal of Mathematical Behavior*, 21(4), 1-25.
- Olive, J. & Steffe, L. P. (1994). TIMA: Bars (computer program). Acton, MA: William K. Bradford.
- Steffe, L. P. (2002). A new hypothesis concerning children's fractional knowledge. *Journal of Mathematical Behavior*, 102, 1-41.
- Steffe, L. P. (1998). Construction & interaction: Children's fractional schemes. Proposal submitted to the National Science Foundation. The University of Georgia, Athens, GA: Author.
- Steffe, L. P. (1992). Schemes of action and operations involving composite units. *Learning and Individual Differences*, 4, 3, 259-309.
- Steffe, L. P. & Cobb, P. (1988). *Construction of arithmetical meanings and strategies*. New York: Springer-Verlag.
- Steffe, L. P. & Olive, J. (In press). Children's fractional knowledge: A constructive odyssey. *Journal of Mathematical Behavior Monograph Series*.
- Steffe, L. P. & Olive, J. (1990). Children's Construction of the Rational Numbers of Arithmetic. Proposal submitted to the National Science Foundation. The University of Georgia, Athens, GA: Author.
- Streefland, L. (1993). Fractions: a realistic approach. In T. P. Carpenter, E. Fennema & T. A. Romberg (Eds.), *Rational numbers an integration of research*, 289-326. Hillsdale, NJ: LEA.

CABRI AS A SHARED WORKSPACE WITHIN THE PROVING PROCESS

Federica Olivero,

Graduate School of Education, University of Bristol

This paper will discuss some findings from a study investigating the development of the proving process in a dynamic geometry environment. Through a detailed analysis of students' processes when working with open geometry problems involving conjecturing and proving in Cabri, an analytical and explanatory framework has been developed. This paper examines in particular the interactions between the students in the proving process. The analysis shows that Cabri works as a shared workspace, i.e. as a space which supports the interaction between students and the construction of shared knowledge in the proving process.

INTRODUCTION AND THEORETICAL FRAMEWORK

The study described in the paper sits within the current mathematics education research strand dealing with the teaching and learning of proof in the context of dynamic geometry environments (e.g. Hoyles & Healy, 1999; Jones, 2000; Laborde, 2000; Mariotti, 2000). In particular, the overall aim of the project (Olivero, 2002; Olivero, Paola, & Robutti, 2001) was to investigate the processes involved in constructing conjectures and proofs in geometry (i.e. in the proving process), when interacting with Cabri, with a particular focus on two things: the interplay between the spatio-graphical field (including Cabri objects, paper drawings, etc) and the theoretical field (including geometrical properties, theorems and definitions) (Laborde, 1998); the interactions taking place in the proving process, both between students and between the students and the tools used (mainly Cabri). This paper will focus on the second issue.

A number of studies (e.g. Crook, 1994; Kieran & Dreyfus, 1998) deals with issues relating to the interactions between subjects working together both with and without computers. When two students work together on the same problem, it must not be taken for granted that they can automatically communicate and really 'work together'. "The process of collaborative learning is not homogeneous or predictable, and does not necessarily occur simply by putting two students together" (Teasley & Roschelle, 1993, p.253). Individuals must make a continuous effort to coordinate their language and activity with respect to shared knowledge and to construct a Joint Problem Space (Teasley & Roschelle, 1993). Boero et al. (1995) introduced the construct of "field of experience", defined as "the system of three evolutive components (external context, student internal context, teacher internal context) referred to a sector of human culture which the teacher and students can recognise and consider as unitary and homogeneous". The notion of internal and external contexts relates to the construction of a shared workspace. The internal context¹ is what is and happens in the mind of the students, while

¹ The notion of internal context is based on the definition of context given by Edwards & Mercer (1987): "We shall use the term *context* to refer to everything that the participants in a conversation know and

the external context is what is produced and visible (as for example Cabri figures, statements, etc)². When working together students need to make their internal contexts explicit in order to be able to communicate.

This paper will discuss the interactions taking place between the students when working at the computer within the proving process. First, the methodology of the research will be sketched; second, typologies of students' interactions will be defined and examples from students' work explored; finally, a preliminary model interpreting these interactions will be presented.

METHODOLOGY

The research consisted of classroom interventions which took place in a number of secondary schools (15-17 years old pupils) in England and Italy. Students were asked to solve open problems in geometry, working in pairs and using Cabri. Within the classroom interventions, observations of case studies of pairs of students were carried out. The methods used were video-recording and collection of material. The data available for the analysis were transcripts from the video-tapes, the Cabri files and the students' worksheets.

The two extracts discussed in the following sections are taken from the work of Bartolomeo and Tiziana, solving the problem Perpendicular bisectors of a quadrilateral³. The students⁴ are 15 years old and belong to a second year classroom of a Liceo Scientifico in Turin (Italy).

STUDENTS INTERACTING THROUGH CABRI: A RESEARCH PROBLEM

When there are two (or more) students solving the problem *at* the computer, everyone has his/her own internal context. How can students communicate and share their understanding? The construction of a Joint Problem Space (Teasley & Roschelle, 1993) was considered a relevant category of analysis in the proving process (Olivero, 2002) as it may either support or get in the way of the evolution of the proving process itself.

When two students are asked to solve a problem together *at* the computer, each student tells his/her own story, but at the same time the two stories need to intersect, given that only one computer is available to them. What can be noticed is that there are moments in the process in which the students think and do different things and moments in which a good communication takes place and the students really work on the 'same' problem. An interesting thing is to observe how students get to communicate and 'merge' their stories towards a common goal, which is the production of conjectures and proofs. This will be the focus of this paper.

understand, over and above that which is explicit in what they say, that contributes to how they make sense of what is said" (p.63).

² This research did not take into account the teacher internal context.

³ You are given a quadrilateral ABCD. Construct the perpendicular bisectors of its sides: a of AB, b of BC, c of CD, d of DA. H is the intersection point of a and b, K of b and c, L of c and d, M of a and d. Investigate how HKLM changes in relation to ABCD. Prove your conjectures.

⁴ They are medium achievers with respect to mathematics. They had already used Cabri some times before this session, working on construction and exploration problems.

Bartolomeo and Tiziana have shown moments in which communication was taking place between them and moments in which they seemed to be focused on different things and not really communicating between each other. Two types of interaction were identified and the process of occurrence of each one and of transition from one to the other is revealed to be interesting for the development of the proving process. The different occurrences of the 'interaction' category (Olivero, 2002) are presented in the following table.

Synchronous interaction	The two students 'see' the same thing on the same figure. The discourse is spoken by the two together, helping each other, interrupting each other.
Asynchronous interaction	The two students look at the same figure but focus on different aspects, say different things, follow different solution strategies. One student has got the mouse and the other one wants it. Indicators are for example 'what are you doing!', 'why did you do that?', 'wait!'.

In the following, two episodes showing different types of interaction between the students are presented.

Asynchronous interaction: two ways of 'seeing' the same dragging episode

In this extract, the same episode of dragging is 'seen' in two different ways. This is seen as an indicator of asynchronous interaction.

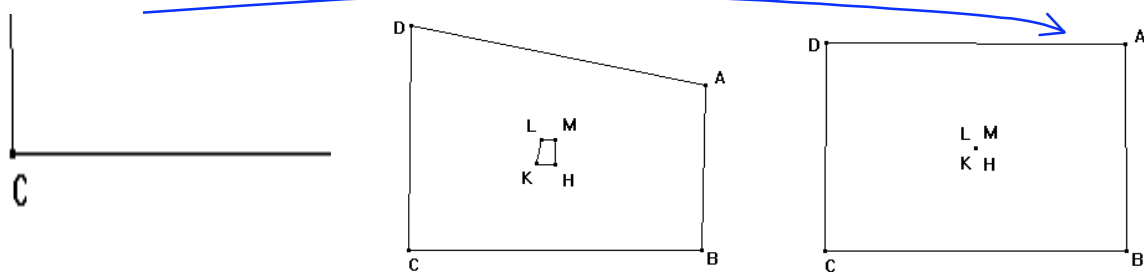

Figure 2

Figure 3

Figure 4

- 69 Meanwhile Tiziana drags ABCD into a rectangle (Figure 2)
- 70 **Bartolomeo:** what have you done, **a rectangle?**
- 71 Tiziana: yes, well...
- 72 **Bartolomeo:** **so... it is a point... try to make it bigger...**
- 75 **Tiziana drags D up and stops** to observe and think (Figure 3)
- 76 **Tiziana:** **excuse me! This (she points at LM) follows what this (AB) does, this (LK) follows this (AD) ...** (she laughs)
- 77 Bartolomeo: let's examine some more cases
- 78 Tiziana drags A up and gets Figure 4
- 79 **Bartolomeo:** **ah, when it's a rectangle it's always a point...** (he writes down the second conjecture) ... if... shall I write "disappears" or "is a point"? It's a point...
- 80 **Tiziana:** **No, because now it's a point too.**

Tiziana drags ABCD to a rectangle (Figure 2), without saying anything. Bartolomeo does not follow Tiziana and does not understand why she made a rectangle (70), but then he

tries to work on what he is presented with, observing that "it is a point" (72). Tiziana does not communicate her ideas to Bartolomeo. Given that she has the mouse, she can do what she wants. Having the mouse allows her to control the situation autonomously. Bartolomeo follows her (70-80) until he needs to have the mouse himself (immediately after) in order to get control again over the situation. In fact his strategy is that of checking all the particular cases, while Tiziana is more open to what Cabri shows her. However, even if Bartolomeo and Tiziana are working on the same figure and the same case (ABCD rectangle), what they 'see' is different. They are seeing the figure on the screen and relating it to their two different internal contexts. And this is shown by the use of dragging in particular. Bartolomeo sees that when Tiziana gets a rectangle then HKLM is a point. He wants to do a sort of dragging test (72) that seems to be a kind of test at a perceptual level ("make it bigger"-72): the aim is to check if it is still a point in another rectangle case. However Tiziana, who has the mouse, does what she wants, moving from Figure 2 to Figure 4 via Figure 3. She stops in 75 and reads a relationship between elements of the figure (she sees a relationship between the side of ABCD and of HKLM, which will be transformed into a conjecture later on in the process). She expresses her reasoning, but Bartolomeo does not follow her. He is thinking about his conjecture. He pays attention only to the initial and final figure (Figure 2 and Figure 4), as two snapshots, as his aim was clear: checking if HKLM is always a point when ABCD is a rectangle. As soon as Tiziana stops in Figure 4, Bartolomeo formulates the conjecture for the rectangle (79). After this, Tiziana seems to abandon her line of thoughts and follows Bartolomeo, and in 80 she shows that she is thinking about the rectangle case, even if in a different way ("no, because now it's a point too").

Towards a synchronous interaction: the 'space' of the parallelogram.

The following extract starts with a situation in which the two students are thinking about and doing different things. Bartolomeo, who does not have the mouse and therefore cannot do what he wants, suggests an idea, but Tiziana, who has the mouse, chooses to do something else. However, the whole episode converges to a communication within the shared Cabri space.

- 49 **Bartolomeo:** Now go to pointer and **let's try to move...** [...]
- 52 Tiziana drags D randomly rightwards and then leftwards (Figure 5)
- 53 Bartolomeo: so, let's do this...
- 54 **Tiziana:** eh, excuse me, **isn't that a...** [...]
- 57 **Bartolomeo:** **ok, try to make it a trapezium...**
- 58 Tiziana drags D
- 59 Tiziana: is it a trapezium?
- 60 **Bartolomeo:** **let's see what happens in every case**, shall we?
- 61 **Tiziana:** **wait, eh... let's do this...**
- 62 Tiziana drags C
- 63 **Bartolomeo:** **... a parallelogram?**
- 64 Tiziana stops moving when she gets a parallelogram (Figure 6)
- 65 **Bartolomeo:** **ok, so... if ABCD is a parallelogram, then...**
- 66 **Tiziana:** **this is a parallelogram too**

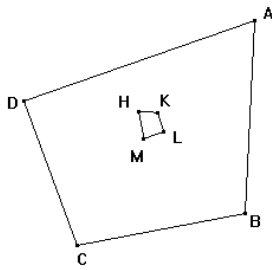

Figure 5

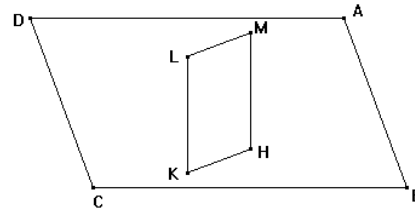

Figure 6

Bartolomeo has a strategy in mind and wants to move ABCD (49). Tiziana starts moving in 52, accomplishing Bartolomeo's wish. Bartolomeo continues to think about his own strategy (53), which he has not made explicit yet. Tiziana is thinking about something on her own. She is looking at the Cabri figure and 'reading' it (54). Bartolomeo makes explicit what he wants to do (57). Tiziana follows what Bartolomeo says but without seeming to understand where he wants to go (58). Bartolomeo makes explicit the general strategy he has in mind, that is an ordered exploration of cases (60): what happens to HKLM when ABCD is a...? This time Tiziana does not pay attention to what Bartolomeo says and pursues her own idea ("wait"-61), without talking Bartolomeo through it. They are going along two different paths. They both have ideas so it is the person who has the mouse that leads the situation, i.e. Tiziana; she does what she wants (62), forcing Bartolomeo to follow her in her thoughts. Bartolomeo is surprised to see a parallelogram (63) on the screen because he does not know what Tiziana wants to achieve. It is only when dragging is stopped (64) that the two students produce a conjecture about the same thing. At this point (65-66) the students seem to be sharing the 'same' story, after a whole episode in which they were not communicating (49-64). The communication seems to take place around Figure 5 and it seems to be more a fact of 'tuning' each other's thoughts than only communicating with each other. It is a visual element, not a spoken one that provides mutual sharing and understanding. There is no need of speaking at this point, everything happens around a Cabri figure which now has a shared meaning: synchronous interaction is taking place and a conjecture can be produced by both students at the same time (65-66).

BUILDING A SHARED WORKSPACE AND SYNCHRONISING INTERNAL CONTEXTS

This section elaborates on the previous extracts, providing a preliminary model interpreting students' interactions in the proving process.

When two students work together at the computer solving an open problem, the internal context of each student is projected into the problem situation. Using a metaphor, this projection forms two different 'shadows' in the external context. As Figure 7 shows, at the beginning of the process it is likely that the two 'shadows' do not intersect, as the students' internal contexts may be different. The starting point may be a state of asynchrony. During the process there is a continuous feedback from the external context to students' actions, therefore the internal context is constantly modified, and a process of

"internalisation"⁵ (Vygotsky, 1978, p.56) takes place, so that the external tools (Cabri tools) may be internalised as psychological tools which direct students' behaviour in solving the problem. The students see things in Cabri and they relate what they see to their internal context, therefore they may see different things on the same figure (see the first extract). They work on what they see and they transform it. They produce statements. But at the same time through the 'shadows' the students start to interact with each other's internal contexts and intentions. A point may be reached in which the projections of the two internal contexts intersect (Figure 8). When this happens it means that the students are communicating and working together on the same issues. Synchronisation may then take place. The internal context is then continuously modified by both the feedback from the Cabri environment and the interaction with the other student. The projection of the internal contexts in the external context should be imagined as dynamic, so that at times the intersection exists and at times it does not. The moments in which the intersection exists are the moments in which there is the construction of joint understanding and knowledge, which may support the production of conjectures and proofs. The moments of synchronisation do not necessarily coincide with the development of well-formed logical statements. In fact it seems that if there is a synchrony between the students they understand each other perfectly through the external space (mainly Cabri) without finding the need of developing a well-formed logical language. Things can be seen and understood in Cabri, without any need for explicit logic and Cabri becomes part of students' interactions. As Teasley & Roschelle (1993) state,

students are not wholly dependent on language to maintain shared understanding. In fact, one major role of the computer in supporting collaborative learning is providing a context for the production of action and gestures. (p.238)

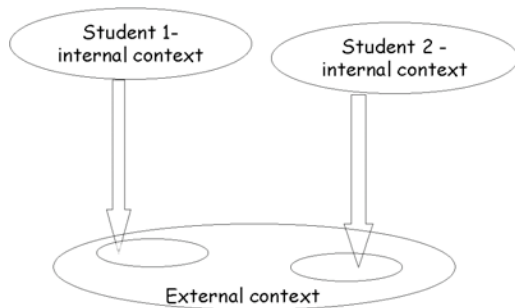

Figure 7. Two internal contexts are projected onto the external context

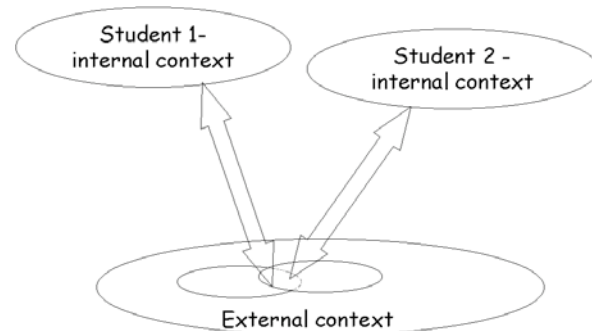

Figure 8. The internal contexts communicate through the external context.

Summarising, the analysis suggests that the Cabri environment is revealed to be a *shared workspace* for students, that is a space in which students communicate and converge

⁵ "The process of internalization consists of a series of transformations: (a) An operation that initially represent an external activity is reconstructed and begins to occur internally. [...]. (b) An interpersonal process is transformed into an intrapersonal one. [...]. (c) The transformation of an interpersonal process into an intrapersonal one is the result of a long series of developments" (Vygotsky, 1978, p.56-57).

towards a shared understanding. In the second extract presented above the shared space was the 'space' of the parallelogram.

Already A has some insight into the state of B's understandings, the meanings which are evoked for B by the problem or the situation. [...] The computer has brought an arena in which A and B's understandings can be externalised. (Noss & Hoyles, 1996, p.5)

Entering another's *universe of thought* (Trognon, 1993) in Cabri may be easier than in paper and pencil, because of the possibility of moving figures on the screen which contrasts with the fact that figures on paper are static. Both the background knowledge and the knowledge being constructed over the solution process can be expressed, changed and explored via dragging in Cabri.

A has now a language with which to interact with B, the language of action in which ideas on the computer are expressed. [...] A and B both have a two-way channel of communication with the computer, and in establishing these channels, it (actually the setting) has opened a channel from B to A where previously the direction of communication was essentially one-way. (Noss & Hoyles, 1996, p.5)

Seeing the dynamic variation of figures on the screen allows interactive participation of both students to the same experience. At the beginning it seems that the one who has got the mouse leads the solution process, however it is observed that once figures start moving on the screen also the other person is allowed to enter the experience and process of discovery, which seems to be a pre-requisite for the construction of shared knowledge or understanding. The possibility of direct manipulation of Cabri objects through the mouse makes Cabri an external space in which the two subjects can interact and communicate, trying to *synchronise their internal contexts*.

CONCLUDING REMARKS

The modalities of students' interactions are defined by what students say and do. The extracts discussed in this paper analysed in particular the different interpretation of dragging and the ownership of the mouse. The students communicate through dragging while interacting in front of the computer and dragging is one of the possibilities students have to make explicit their internal contexts. So their interpretation of dragging⁶ affects how the communication is carried out and contributes to the solution of the problem. Other directly 'observable' variables which provide information about students' interaction, and which have been discussed elsewhere, are:

- The different types of interaction of the students with the software and the ways in which the students incorporate (or not) the software in their thinking over the proving process (Olivero, 2002).
- The ways in which they use paper and pencil sketches (when they do) in order to break the interaction and think on their own or to communicate something that cannot be done through Cabri (Olivero, 2002).
- The language they use to communicate *with* and *at* the computer (Arzarello, 2000).

⁶ See Arzarello et al. (1998; 2002) and Olivero (2002) for a detailed classification of students' use of different dragging modalities.

References

- Arzarello, F. (2000). Inside and Outside: Spaces, Times and Language in Proof Production. In T. Nakahara & M. Koyama (Eds.), *Proceedings of PME24* (Vol. 1, pp. 23-38). Hiroshima.
- Arzarello, F., Gallino, G., Micheletti, C., Olivero, F., Paola, D., & Robutti, O. (1998). Dragging in Cabri and modalities of transition from conjectures to proofs in geometry. In A. Olivier & K. Newstead (Eds.), *Proceedings of PME22* (Vol. 2, pp. 32-39). Stellenbosh.
- Arzarello, F., Olivero, F., Paola, D., & Robutti, O. (2002). A cognitive analysis of dragging practises in Cabri environments. *Zentralblatt fur Didaktik der Mathematik*.
- Boero, P., Dapuzeto, C., Ferrari, P., Ferrero, E., Garuti, R., Lemut, E., Parenti, L., & Scali, E. (1995). Aspects of the Mathematics-Culture Relationship in Mathematics Teaching-Learning in Compulsory School, *Proceedings of PME19* (Vol. 1, pp. 151-166). Recife.
- Crook, C. (1994). *Computers and the collaborative experience of learning*. London: Routledge.
- Edwards, D., & Mercer, N. (1987). *Common Knowledge*. London and New York: Routledge.
- Hoyle, C., & Healy, L. (1999). Linking informal argumentation with formal proof through computer-integrated teaching experiments. In O. Zaslavsky (Ed.), *Proceedings of PME23* (Vol. 3, pp. 105-112). Haifa.
- Jones, K. (2000). Providing a foundation for deductive reasoning: students' interpretations when using dynamic geometry software and their evolving mathematical explanations. *Educational Studies in Mathematics*, 44, 55-85.
- Kieran, C., & Dreyfus, Y. (1998). Collaborative versus individual problem solving: entering another's universe of thought. In A. Olivier & K. Newstead (Eds.), *Proceedings of PME22* (Vol. 3, pp. 112-119). Stellenbosh.
- Laborde, C. (1998). Relationship between the spatial and theoretical in geometry: the role of computer dynamic representations in problem solving. In J. D. Tinsley & D. C. Johnson (Eds.), *Information and Communications Technologies in School Mathematics* (pp. 183-195). London: Chapman & Hall.
- Laborde, C. (2000). Dynamic Geometry Environments as a Source of Rich Learning Contexts for the Complex Activity of Proving. *Educational Studies in Mathematics*, 44(1/2), 151-161.
- Mariotti, M. A. (2000). Introduction to Proof: The Mediation of a Dynamic Software Environment. *Educational Studies in Mathematics*, 44(1/2), 25-54.
- Noss, R., & Hoyle, C. (1996). *Windows on mathematical meanings : learning cultures and computers*. Dordrecht ; Boston: Kluwer Academic Publishers.
- Olivero, F. (2002). *The proving process within a dynamic geometry environment*. Unpublished thesis, University of Bristol, Bristol.
- Olivero, F., Paola, D., & Robutti, O. (2001). Approaching theoretical thinking within a dynamic geometry environment. *L'educazione matematica*, 3(3), 127-148.
- Teasley, S. D., & Roschelle, J. (1993). Constructing a Joint Problem Space: the Computer as a Tool for Sharing Knowledge. In S. P. Lajoie & S. J. Derry (Eds.), *Computers as Cognitive Tools* (pp. 229-258). London: Chapman & Hall.
- Trognon, A. (1993). How does the process of interaction work when two interlocutors try to resolve a logical problem? *Cognition and Instruction*, 11(3&4), 325-345.
- Vygotsky, L. S. (1978). *Mind in society. The development of higher psychological processes*. Cambridge, MA: Harvard University Press.

THE CONSTRUCT VALIDITY OF AN INVENTORY FOR THE MEASUREMENT OF YOUNG PUPILS' METACOGNITIVE ABILITIES IN MATHEMATICS

Areti Panaoura* George Philippou
Department of Education, University of Cyprus
* edrita@ucy.ac.cy ** edphilip@ucy.ac.cy

In recent years metacognition has been receiving increased attention in mathematics education. Special attention has been focused on metacognition and its essential role in achievement settings. The basic difficulty of the study on the field of metacognition is to develop and use valid tasks in order to measure metacognitive ability especially for young pupils. The present study is a part of a larger research on the development of young pupils' metacognitive ability in mathematics. It represents the initial phase of an instrument development and the examination of its construct validity. The confirmatory factor analysis confirms the existence of a second order structure representing metacognition and two basic first order factors indicating metacognitive knowledge and metacognitive regulation.

THE TWO DIMENSIONS OF METACOGNITION: METACOGNITIVE KNOWLEDGE AND SELF-REGULATION

Although there is growing evidence that metacognition is an important component of intelligence and cognition, there is confusion on the conceptual definition of the term. There are many different kinds of knowledge and processes subsumed under the term metacognition. According to Campione (1987) this term “has been used by different authors to mean different things” (p.119). In modern psychological literature, the term “metacognition” has been used to refer to knowledge about cognition and regulation of cognition.

Flavell (1976), who was the first to introduce the term “metamemory” into the literature, used the term “meta” in order to indicate the second order knowledge or function, in the sense the predicate is used in a variety of cases such as metatheory. Then the term metamemory was expanded in order to include the metacognitive knowledge and regulation of cognition (Flavell, 1979). On the other hand Demetriou (1993) rejected the term “metacognition” and uses the term “hypercognitive system”, asserting that “meta” indicates an order process that follows all the cognitive processes and has a higher order role. The present study uses the term “metacognition” referring to the awareness and monitoring of one's own cognitive system and it's functioning. It accepts that although metacognition is a multidimensional construct, knowledge of cognition or metacognitive knowledge and self-regulation of cognition are its two basic dimensions.

Metacognitive knowledge is “knowledge or beliefs about what factors or variables act and interact in what ways to affect the course and outcome of cognitive enterprises” (Flavell, 1999, p.4). The major categories of these factors or variables are: person, task and strategy. The person category encompasses everything that a person believes about the nature of him/herself and other people as cognitive processors; it refers to the kind of acquired knowledge and beliefs that concern what human beings are like as cognizing

organisms. The task category concerns the information about the object available to a person during a cognitive enterprise. Thinkers must recognize that different tasks entail different mental operations (Demetriou, 2000). The strategy category includes a great deal of knowledge that can be acquired concerning what type of action are likely to be effective in achieving what goals and in what sort of cognitive undertakings. Actually, metacognitive knowledge is knowledge that people have about their cognitive abilities (I have a bad memory), about cognitive strategies (to remember a phone number I should rehearse it) and about tasks (categorized items are easier to recall).

Whereas Flavell uses the person-task-strategy taxonomy to define metacognitive knowledge, Brown (1987) has categorized metacognitive knowledge based on a person's awareness of this knowledge: declarative, procedural and conditional knowledge. Declarative knowledge is propositional knowledge which refers to "knowing what", procedural knowledge refers to "knowing how" and conditional knowledge refers to "knowing why and when".

The second dimension of metacognition, metacognitive regulation refers to processes that coordinate cognition. It is the ability to use metacognitive knowledge strategically to achieve cognitive goals, especially in cases that someone needs to overcome cognitive obstacles. It has become clear that one of the most important issues in self regulated learning is the students' ability to select, combine and coordinate strategies in an affective way (Boekaerts, 1999). It is essential to the development of students' ability to learn cognitive strategies, such as self-questioning, widen the application of these strategies and gain conscious control over them. Self-regulation strategies play an important role on the learning process. Successful learners are able to swiftly transfer the knowledge and strategies acquired in one situation to new situations, modifying and extending these strategies on the way. Self-regulatory behavior in mathematics includes clarifying problem goals, understanding concepts, applying knowledge to each goal and monitoring progress toward a solution.

Metacognitive regulation and metacognitive knowledge are interdependent constructs. For example, awareness that one is not very good at a certain task would lead him/her to monitor his/her processes more carefully. On the other hand, if one monitors his actions and detects a lot of errors, he/she may conclude that the task is difficult.

For the solution of any complex problem-solving task a variety of metacognitive processes is necessary because problem solving is a complex interplay between cognition and metacognition. It is known that individuals with higher levels of metacognitive ability perform better in problem solving tasks (Artzt & Armour-Thomas, 1992). Some of the programs that were proposed in order to develop pupils' metacognition by teaching metacognitive skills focused either on a wide range of processes or on only one of them. Improving either metacognitive knowledge or metacognitive regulation improves learning. Especially according to Flavell (1979) metacognition improves by practicing it or by practicing other processes, which are not metacognitive, themselves but which indirectly promote metacognitive ability.

The development of metacognition occurs in the same manner as cognition with children learning more about the structure and the function of their cognitive system as they get

older and they have a variety of metacognitive experiences. Actually the development of metacognition is the product and a producer of the cognitive development. Metacognitive theory has not focused on the development of metacognition mainly because researchers encounter serious methodological problems in their attempt to develop valid instruments measuring metacognition.

THE DIFFICULTIES ON THE MEASUREMENT OF METACOGNITION

One of the basic problems of the study on the field of metacognition is to develop and use valid tasks measuring metacognitive ability. Brown (1987) believes that using the term metacognition to refer to two distinct areas of research makes the research procedure more difficult and creates confusion that clouds any interpretation of research findings. Although several methods of measuring metacognition have been implemented each of these methods has advantages and disadvantages. For example, one of the most popular approaches for assessing both metacognitive knowledge and control is to ask students to explain directly about what they know or what they do. For assessing metacognitive regulation, participants may be asked to think aloud about what they are doing and thinking as they solve a problem. Nevertheless verbal reports are subject to many constraints and limitations (Baker & Cerro, 2000). Asking children, particularly young children about their cognitive processing, poses some special problems. Answers may reflect not what the child respondents know or do not know, but rather what he/she can or cannot tell to the interviewer. On the other hand, metacognition is rather cognitive in nature than behavioural and consequently, self-report inventories are, in some ways, the least problematic technique to measure metacognitive ability (Sperling, Howard, Miller & Murphy, 2002).

Schraw and Sperling-Denisson (1994) developed a 52-item Likert-type self-report inventory for adults (MAI), which measured both knowledge of cognition and regulation of cognition. They set out to confirm the existence of eight factors, from which three related to knowledge of cognition and five related to regulation of cognition. The final factor structure was best represented by two main factors. Post-hoc content analysis confirmed that these factors were ended as knowledge of cognition and regulation of cognition. Sperling et al. (2002) used the idea of the MAI inventory and developed two inventories for the use with younger learners, the Jr MAI, version A and B. Their results indicated that this inventory revealed two distinct factors, accounting for 64% and 56% of the sample variance for versions A and B, respectively.

THE RESEARCH

The present study is a part of a bigger research on the development of cognitive and metacognitive abilities in mathematics. The major purpose was to develop an inventory based on the idea of MAI (1994) and Jr MAI (2002) for the measurement of young pupils' metacognitive ability in mathematics. As Baker and Cerro (2000) argue it is time to focus on more valid approaches. Firstly we wanted to examine statistically the construct validity of the inventory we have developed for the measurement of young pupils' metacognitive ability in mathematics. The second aim of the study, in our attempt to avoid a big inventory, which is inappropriate for young pupils, was to choose

statistically the least number of items that could constitute an inventory for the measurement of metacognition.

Sample: Participants included all 246 children in grades four through six (about 8 to 11 years old) of an elementary school (74 were 4th graders, 81 were 5th graders and 91 were 6th graders).

Procedure: The questionnaire was consisted of two basic parts. The first part measured metacognitive abilities in mathematics. Pupils were instructed to read 30 items and for each item circle the answer that best described their thoughts when solve a problem they might see in a math class (1=never, 2= seldom, 3=sometimes, 4=often, 5=always). Examples of items are the following: “When I encounter a difficulty that confuses me in my attempt to solve a problem I try again”, “After I finish my work I know how well I performed on it”. The second part was about their cognitive ability in problem solving. Pupils were instructed to read a problem and answer a set of questions before and after their attempt to solve it. In all classes the questionnaire was administered as part of normal class procedure.

RESULTS

In this paper we present only the results of the analysis of the first part of the inventory. The 30 items were checked with respect to skewness of kurtosis and all items were found within normality criteria. The inventory demonstrated an overall high reliability (Cronbachs’ alpha 0.8298). Firstly we conducted an exploratory factor analysis and we choose the 25 items that after a content analysis indicated to load at nine factors which were in relation to metacognitive knowledge and regulation (KMO=0,807, $p=0,000$). Then we conducted a confirmatory factor analysis to explore the hypothesized structure the inventory examined. Actually we used confirmatory factor analysis and structural equation modeling to test our hypothesis on the existence of the two first order factors and a second order factor. The a priori model hypothesized that: a) responses to the inventory could be explained by two first order factors (metacognitive knowledge and self-regulation) and a second order factor (metacognition), b) each item would have a nonzero loading on the factor it was designed to measure, c) measurements errors would be uncorrelated.

Analysis was conducted using the EQS program and maximum likelihood estimation procedures. Multiple criteria were used in the assessment of the model fit. In a Confirmatory Factor Analysis study the parameters typically consist of factor loadings, factor variances, covariances and measured variables. In the present study 25 indicators were hypothesized to represent the model. After conducting the LMTEST (Bentler, 1993) we arrived at an elaborated model in which the goodness-of-fit index was good in relation to typical standards. Fifteen items were dropped depending on their low loadings on the hypothesized factors ($<0,300$) and three items were connected with both the factors. The different models that were examined in the attempt to decrease the number of items with their goodness of fit index were as follows:

First model with two first order factors:
 F1: 10 items, F2 : 15 items
 $X^2(274)=497,313$ $p=0,000$
 $X^2/df = 1,815$ CFI= 0,764, GFI=0,857
 AGFI = 0,830 RMSEA = 0,058

Second model with two first order factors
 F1: 11 items, F2 : 13 items
 $X^2(181)=326,741$ $p=0,000$
 $X^2/df = 1,805$ CFI= 0,828 GFI=0,884
 AGFI = 0,852 RMSEA = 0,057

Third model with two first order factors
 F1: 8 items, F2 : 10 items
 $X^2(79)=119,128$ $p=0,002$
 $X^2/df = 1,507$ CFI= 0,925, GFI=0,940
 AGFI = 0,909 RMSEA = 0,046

Final model with two first order factors and a second order factor (3 items connected with both the factors)
 F1: 8 items, F2 : 10 items
 $X^2(77)=119,128$ $p=0,0014$
 $X^2/df = 1,547$ CFI= 0,925, GFI=0,940
 AGFI = 0,907 RMSEA = 0,047

F1: metacognitive knowledge, F2: metacognitive regulation

Table 1: Models examined and their goodness of fit

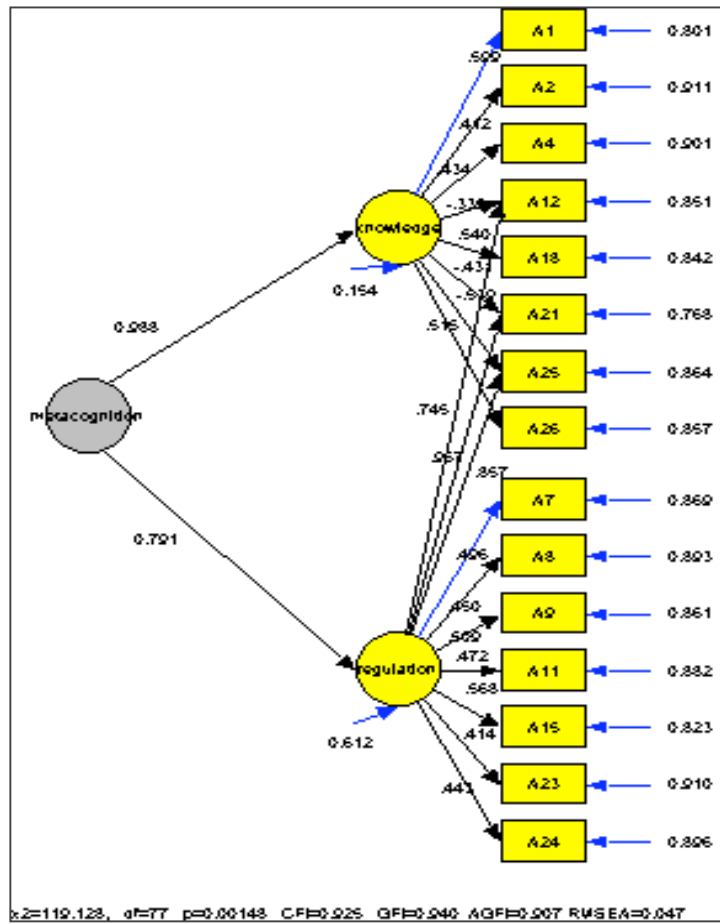

Figure 1: The final model for the measurement of metacognition

The final model proposed that five items were indicators of the metacognitive knowledge, seven items were indicators of the metacognitive regulation and three items

split at both the dimensions of metacognition. The loadings of the two first order factors were loaded high on the second order factor (0,982 and 0,778). The parameter estimates of the model are shown above in Figure 1.

The fit of the final model was excellent and the values of the estimates were satisfactory in all cases. It is noted that to have a good fit to the data a model must have a fit index, such as the Comparative fit index (CFI) higher than 0,9. Also, ideally the p- value for the X^2 must be higher than 0,05 indicating that the model does not differ significantly from the data. When this is not possible because sample size is large, as at the present study, a X^2/df criterion of less than 1,96 is considered satisfactory.

The findings of the structural analysis presented above suggest that all items were used at the inventory split at two basic factors, which stood up as first order factors in the model that found to fit our data. The finding that three items loaded on both the factors is likely to due to the high correlation between knowledge and regulation of cognition. Very important is the high loadings of the two first order factors on the second order factor, confirming the existence of the two basic dimensions of metacognition through the items of the specific inventory.

DISCUSSION

This study presents the initial phase of an examination of the validity of an instrument development for the measurement of metacognition in mathematics education appropriate for pupils in primary education. Undoubtedly it is not easy for young pupils to express their thoughts about their cognitive system and their cognitive abilities. According to Schraw (1998) promoting metacognition begins with building awareness among learners that metacognition exists, differs from cognition and increases academic success. We believe that it is possible in an attempt to measure metacognitive abilities to interfere to the metacognitive processes while pupils are obliged to think about their cognitive system. Those thoughts are metacognitive by their own nature.

The purpose of the present study was to test for the validity of a higher order factorial structure of the inventory we have developed based on the analysis of data within the framework of a confirmatory factor analytic model findings yielded support from the hypothesized second order structure. A first order factor contained items for the knowledge of cognition and a different first order factor contained items for the regulation of cognition. The existence of the three common items for both the factors indicated the high correlations between the two factors because of the high correlation between the two basic dimensions of metacognition: knowledge of cognition and regulation of cognition. The present study is in line with the results of previous studies indicating factors of metacognition and their high relationships. Especially findings are consistent with the work with the MAI (Schraw & Sperling-Dennison, 1994) and Jr MAI (Sperling et al, 2002). We believe that the final set of the 15 items consist an appropriate valid inventory for the measurement of young pupils' metacognitive abilities in mathematics (see Appendix).

Results of this research are expected to be of substantial interest to researchers whose concerns focus on the measurement of metacognition. Being able to measure

metacognition provides the educational system with plenty of tools to help pupils develop their metacognitive abilities.

Reference

- Artzt, A. & Armour–Thomas, E. (1992). Development of a cognitive – metacognitive framework for protocol analysis of mathematical problem solving in small groups, *Cognition and Instruction*, 9 (2), 137-175.
- Baker, L. & Cerro, L. (2000). Assessing metacognition in children and adults. In G. Schraw & J. Impara (Eds), *Issues in the Measurement of metacognition* (99-145). USA: Buros Institute of mental measurements.
- Bentler, M.P. (1995). *EQS: Structural Equations program manual*. Los Angeles: University of California.
- Boekaerts, M. (1999). Self-regulated learning: where we are today, *International Journal of Educational Research*, 31, 445-457.
- Brown, A. (1987). Metacognition, executive control, self-regulation and other more mysterious mechanisms. In Frann Weinert & Rainer Kluwe (Eds), *Metacognition, Motivation and Understanding* (65-115). London: LEA.
- Campione, J. (1987). Metacognitive components of instructional research with problem learners. In F. Weinert & R. Kluwe (Eds), *Metacognition, Motivation and Understanding* (117-140). London: LEA.
- Demetriou, A. (2000). Organization and development of self-understanding and self regulation. In Monique Boekaerts, P. Pintrich & M. Zeidner (Eds), *Handbook of self regulation* (209-251). USA: Academic press.
- Flavell, J. (1976). Metacognitive aspects of problem solving. In L. Resnick (Ed), *In the nature of intelligence* (on line). Available:
<http://www.library.www.edu/cbl/ray.../flavell%20metacognition-1976.htm>.
- Flavell, J. (1979). Metacognition and cognitive monitoring, *American Psychologist*, 34,906-911.
- Flavell, J. (1999). Cognitive development: children’s knowledge about the mind, *Annual review of psychology* (on line). Available:
http://www.findarticles.com/cf_dls/m0961/1999_Annual/54442292/p1/article.html.
- Schraw, G. & Sperling–Dennison, R. (1994). Assessing metacognitive awareness, *Contemporary Educational Psychology*, 19, 460-470.
- Sperling, R., Howard, L. & Murphy, C. (2002). Measures of children’s knowledge and regulation of cognition, *Contemporary Educational Psychology*, 27, 51-79.

APPENDIX

The final inventory that is proposed

1. I know how well I have understood a subject I have studied (A1).
2. My performance depends on my will and my effort (A2).
3. I can learn more about a subject on which I have previous knowledge (A4).
4. I define specific goals before my attempt to learn something (A7).
5. I examine my own performance while I am studying a new subject (A8).
6. When I finish my work I wonder whether I have learned new important things (A9).
7. After I finish my work I repeat the most important points in order to be sure that I have learned them (A11).
8. I use different ways to learn something according to the subject (A12).
9. I know ways to remember knowledge I have learned in Mathematics (A15).
10. I understand a problem better if I write down its data (A18).
11. When I try to solve a problem I pose questions to myself in order to concentrate my attention on it (A21).
12. When I encounter a difficulty that confuse me in my attempt to solve a problem I try to solve it again (A23).
13. While I am solving a problem I wonder whether I answer its major question (A24).
14. Before I present the final solution of a problem, I try to find some other solutions as well (A25).
15. After I finish my work I know how well I performed on it (A26).

STUDENT-CENTERED TEACHING PRACTICES IN KOREAN ELEMENTARY MATHEMATICS CLASSROOMS

JeongSuk Pang

Korea National University of Education

The current mathematics education reform requires substantial changes toward student-centered instruction. In contrast to the widespread awareness of the reform agenda, there is a concern that many teachers do not quite grasp the vision of the reform. This study explored the breakdown that may occur between teachers' adoption of reform objectives and their successful incorporation of reform ideals by comparing and contrasting two reform-oriented Korean classrooms. Given that the two classes established similar social participation patterns but different mathematical culture, this study highlights the importance of sociomathematical norms in the analysis of reform-oriented practices and discusses implications for reform at the classroom level.

BACKGROUND

Educational leaders have sought to change the prevailing teacher-centered pedagogy of mathematics to a student-centered pedagogy (NCTM, 1991, 2000). The term *teacher-centered* refers to a teacher's explanations and ideas constituting the focus of classroom mathematical practice, whereas the term *student-centered* refers to students' contributions and participations constituting the focus of classroom practice.

The reform movement has been successful in marshaling large-scale support for instructional innovation, and in enlisting the participation and allegiance of large numbers of mathematics teachers (Knapp, 1997). However, despite the widespread endorsement of reform, many teachers have not grasped the full implications of the reform ideals (Kirshner, 2002; Research Advisory Committee, 1997). Teachers too easily adopt new teaching techniques such as the use of real-world problems or cooperative learning, but without reconceptualizing how such an instructional change relates to fostering students' conceptual understanding or mathematical dispositions (Burrill, 1997). This is even for teachers who are committed to implementing reform recommendations (Fennema & Nelson, 1997; Pang, 2000). The real issue is then to understand not the form but the quality of an instructional method. What kinds of mathematical and social exchanges occur and in what ways such changes promote students' mathematical development?

Korean students have consistently demonstrated superior mathematics achievement in recent international comparisons (e.g., Beaton et al, 1996; Mullis et al, 2000). Despite the high performance, the problems in Korea with regard to mathematical education are perceived to be similar to those in other countries. Such problems include learning without deep understanding, negative mathematical disposition, weak problem solving ability, and lack of creative mathematical thinking. These shared problems mainly come from teacher-centered instruction in Korea (Kim et al, 1996), and broad-scale efforts have been launched to influence the ways mathematics is taught. The most recent 7th national

curriculum and concomitant textbooks and teachers' guidebooks consistently recommend student-centered teaching methods (Ministry of Education, 1997).

Given the challenges of implementing reform ideals, this study is to understand better the *processes* that constitute student-centered pedagogy in Korean elementary mathematics classrooms. However, this study makes a significant departure from previous research trends on reform where single reform-oriented classroom is extensively studied (e.g., Ball, 1993; Cobb & Bauersfeld, 1995). Close contrasts and comparisons of unequally successful student-centered classes have rarely been conducted in previous research on reform. Such comparisons can provide a unique opportunity to reflect on the subtle but important problems and issues of implementing educational reform at the classroom level.

This study probes in what ways the teacher and students create unequally successful student-centered mathematics classrooms and what kinds of learning opportunities arise for the students in these classrooms. This study then identifies the differences and similarities among the classrooms in order to gain insights on the challenges for reformers -- including educators, policymakers, administrators, and educational researchers -- in changing the culture of primary level mathematics instruction.

THEORETICAL FRAMEWORK

A general guideline to the understanding of mathematics teaching practices is an "emergent" theoretical framework Cobb and his colleagues developed that fits well with the reform agenda (Cobb & Bauersfeld, 1995). In this perspective, mathematical meanings are neither decided by the teacher in advance, nor discovered by students. Rather, they *emerge* in a continuous process of negotiation through social interaction.

Along with the emergent perspective, two constructs of *social norms* and *sociomathematical norms* are mainly used to characterize each mathematics classroom (Yackel & Cobb, 1996). General social norms are the characteristics that constitute the classroom participation structure. They include expectations, obligations, and roles adapted by classroom participants as well as gross patterns of classroom activity. For example, the general social norms in a student-centered classroom include the expectation that students invent, present, and justify their own solution methods and the role that teacher listens carefully to students' contributions and comments on or re-describes them for further discussion.

Sociomathematical norms are the more fine-grained aspects of these general social norms that relate specifically to mathematical discourse and activity. The differentiation of sociomathematical norms from general social norms is of great significant because interest is given to the ways of explicating and acting in mathematical practices that are embedded in classroom social structure. The examples of sociomathematical norms have included the norms of what count as an acceptable, a justifiable, an easy, a clear, a different, an efficient, an elegant, and a sophisticated explanation (Cobb, Gravemeijer, Yackel, McClain, & Whitenack, 1997; Yackel & Cobb, 1996). For instance, the sociomathematical norms in a student-centered classroom may include the expectation that students are to present their solution methods by describing actions on mathematical objects rather than simply accounting for calculational manipulations. Within this study, I

pursue the possibility that the breakdown between teachers' adoption of reform objectives, and their successful incorporation of reform ideals implicates the sociomathematical norms that become established in their classrooms.

METHOD

This study is an exploratory, qualitative, comparative case study (Yin, 1994) using *constant comparative analysis* (Glaser & Strauss, 1967; Strauss & Corbin, 1998) for which the primary data sources are classroom video recordings and transcripts. The data used in this paper are from a one-year project of reform in elementary schools in South Korea. As a kind of purposeful sampling, the classroom teaching practices of 15 elementary school teachers eager to align their teaching practices to reform were preliminary observed and analyzed. An open-ended interview with each teacher was conducted to investigate his or her beliefs on mathematics and its teaching.

Five classes from different schools were selected that aspired to student-centered classroom social norms. Two mathematics lessons per month in each of these classes were videotaped and transcribed. Individual interviews with the teachers were taken three times to trace their construction of their teaching approaches. These interviews were audiotaped and transcribed. Additional data included videotaped inquiry group meetings in which the participant teachers met once per month and discussed mathematics, curriculum, and pedagogy. Through the group meetings, the teachers had lots of opportunities to analyze their own teaching practices as well as others, which might help them develop a keen sense of what student-centered teaching practices look like at each classroom level. The interview and inquiry group data were to understand the successes and difficulties that might occur in the process of changing the culture of primary mathematics classrooms, as well as the recursive relationship among the teachers' learning, beliefs, and classroom teaching.

Data analyses have two stages: Individual analysis of each classroom and comparative analysis. Interview data were included in the analyses whenever they provided useful background information in relation to classroom teaching practices. Because case study should be based on the understanding of the case itself before addressing an issue or developing a theory (Stake, 1998), teaching practices are very carefully scrutinized in a bottom-up fashion using the four categories of classroom flow, the teacher's approaches, students' approaches, and students' learning opportunities. The central feature of these analyses is to compare and to contrast preliminary inferences with new incidents in subsequent data in order to determine if the initial conjectures are sustained throughout the data set.

Next, the data from the individual classes are employed for comparisons among the unequally successful reform instruction in terms of general social norms and sociomathematical norms. The difficulties and successes of the teachers were highlighted and the issues and obstacles that may point toward generic problems of reform were analyzed.

RESULTS

A preliminary analysis shows that the five classrooms display similar general social norms that are compatible with current reform recommendations (Ministry of Education,

1997; NCTM, 2000). For the purpose of this paper, however, the two among the five classes are compared and contrasted in terms of general social norms and sociomathematical norms in order to investigate the challenges of implementing student-centered teaching practices.

Comparison by General Social Norms

The two classes were 6th grade classes in different schools, and shared strikingly similar general social norms. There were many similarities with regard to the expectations, obligations, or roles adopted by the teacher and the students across the classrooms. Both classes displayed a classroom participation structure in which:

- The teacher and the students established permissive and open atmosphere so that students' ideas and even their mistakes were welcomed.
- The discussion pattern of social interaction predominated with a sequence of teacher-student turn taking.
- Each lesson consistently consisted of the brief review of the previous lesson, the teacher's introduction of new mathematical contents or activities, students' activities, and whole-class discussion.
- The teacher introduced mathematical contents in relation to real-life situations, and emphasized the process of problem solving.
- The teacher emphasized mathematical activity and utilized small group formats to encourage collaboration and discussion among students.
- The teacher encouraged students to find different solution methods for a given problem and to provide critiques of their peer's presentations.
- The teacher supported students' contributions to the discussion by providing praise and encouragement.
- Students solved problems for themselves and presented them to the whole class.
- Students complied with the teacher's instruction and usually listened carefully to their friend's explanations.
- Students collaborated with each other while working together.

The similarities in the general social norms exhibited within each class are not entirely coincidental. Korean reform centers around revision of the national mathematics curriculum and concomitant textbooks and teachers' guidebooks. Whereas educational leaders in Korea have recently attempted to provide for some degree of autonomy at a local school level, the reform documents are very influential leading to directive, coherent, and rather uniform changes. Given that the most recent textbooks and teachers' guidebooks provide detailed exemplary instructional procedures for each lesson, and almost all Korean teachers use them as the main instructional resources (Kim et al, 1996), the shared aspects of social norms per se may not be based on the teachers' own reflections on their lesson strategy.

Comparison by Sociomathematical Norms

Despite the exemplary *form* of student-centered instruction, the content and qualities of the teaching practices in the two classes were somewhat different in the extent to which

students' ideas become the center of mathematical discourse and activity. One teacher (Ms. Y) tended to focus on a pre-given mathematical idea after eliciting students' ideas, whereas the other teacher (Ms. K) consistently posed questions that further challenge and extend students' mathematical thinking after eliciting it.

For example, the two teachers taught the ratio of the circumference of a circle to its diameter by encouraging students to measure the circumferences and the diameters of various circular objects. Followed by students' measurement, Ms. Y hurried to emphasize the formula that the circumference of a circle divided by its diameter is about 3.14, and provided students with several problems to which they applied the formula. In contrast, Ms. K pushed students to explain and justify what they discovered through the activity, and filtered their multiple ideas to pursue mathematically significant ones. In particular, Ms. K posed questions by which students had to identify the variants and invariants as the sizes of circles vary.

A more subtle difference occurred when the two teachers taught a fundamental idea of permutations. With the reference to the mathematics workbook, the two teachers asked students to compare the case of electing two representatives and that of electing a president and a vice-president out of three candidates. In Ms. Y's class, students came up with 6 and 3 possibilities for the case of electing representatives, and Ms. Y initiated discussion by asking where the different answers resulted from.

- Teacher: Where did the difference come from?
- Yun-Jeong: One included the same choices, but the other didn't.
- Teacher: So, what do you have to do to solve the first case?
- Da-Hae: We should exclude the same choices.
- Kwon-Min: I think we have to include the same choices. Because, if there are two students and one of the two is a president, then the other can't be a president.
- Teacher: Do you think that the two cases [of the workbook] are the same?
- Min-Gyu: No. The differences are ... [pause]
- Hae-Jin: I think the cases are different. The first case is to elect representatives, but the second is to elect a president and a vice-president.
- Yun-Seok: In the first case, electing Young-Dae and Hyung-Ju are the same as electing Hyung-Ju and Young-Dae. In the second case, if Young-Dae is a president, then Hyung-Ju can be a vice-president, and vice versa.
- Teacher: So, the cases are different. What do you have to do? How can you conclude?
- Seong-Gyun: For the first case, you have to exclude the same choices, but for the second case, you have to include all the possibilities.
- Teacher: So, there are three possibilities for the first case but six ones for the second case. Right? Let's move onto next activity.

In the episode, at first some students confused the case of permutations with that of combinations. The teacher asked them to focus on the difference of electing representatives and one president with one vice-president. Whereas Hae-Jin explained the cases themselves with little mathematical thinking, Yun-Seok came up with a clear idea

of the mathematical difference and justified his claim with specific examples. However, Ms. Y did not probe his mathematical thinking. Rather, she tended to reinforce what students had to do to get the right answer. As a subsequent activity, Ms. Y gave students a few complex problems only with permutations, and checked the answers at the end. Students had little opportunity to explore the mathematical difference in detail between permutation and combination.

In contrast, Ms. K carefully orchestrated the path of classroom discourse towards the mathematical distinction. After solving the problem of electing two representatives and one president with a vice-president out of three people, the students in Ms. K's class solved a similar problem but from five people. They then discussed when to consider the order of an arrangement of objects, and when not to do. When asked to explain what they had discovered by solving the two problems, students came up with the idea that the number of permutations divided by 2 is the number of combinations, that is to say, $(3 \times 2)/2=3$ and $(5 \times 4)/2=10$ respectively. With the excitement of this idea, Ms. K even encouraged students to explore whether this idea would work for the case of electing other numbers of people.

In summary, Ms. Y listened to students' various contributions but usually turned out to control the classroom discourse toward one direction – finding out the correct answer and following the sequence of activities per se rather than students' emergent ideas. This concern occurred across different classroom activities. The important sociomathematical norms of this class included mathematical accuracy and automaticity. In contrast, Ms. K carefully listened to students' individual or collective work and picked out mathematically significant contributions for subsequent in-depth discussion. The important sociomathematical norms of this class included mathematical insightfulness and difference. In this respect, the two classes developed a similar reasonable discourse structure, but students' learning opportunities are very much constrained by the mathematically significant distinctions embedded within the classroom discourse.

DISCUSSION

This study supports the growing realization of the reform community that reforming mathematics teaching involves reconceptualizing how students' engagement in the social fabric of the classroom may enable them to develop increasingly sophisticated ways of mathematical knowing, communicating, and valuing. The similarities and differences between Ms. Y's and Ms. K's teaching practices clearly shows that students' learning opportunities do arise not from general social norms, but from sociomathematical norms of a classroom community. This study addresses the need for a clear distinction between attending to the social practices of the classroom and attending to students' conceptual development within those social practices. In this respect, the construct of sociomathematical norms, not general social norms, should be focused for initiating and evaluating mathematics education reform efforts as they occur at the classroom level.

The teaching practices examined in this study also reveal that the simple dichotomy between student-centered and teacher-centered pedagogy obscures the variety of mathematics education reform possibilities. Ms. Y's class displayed student-centered instruction at one level. The general social norms established in Ms. Y's class, which

were compatible with reform recommendations, were very different from those norms in a typical teacher-centered mathematics class. However, the detailed analysis of the class illustrated that it displayed teacher-centered instruction at another level, because the ultimate focus of mathematical activity and discourse was on the teacher's methods.

Current reform emphasizes students' development with regard to both to specific mathematical content and to mathematical dispositions (Ministry of Education, 1997; NCTM, 2000). Stemming from Piaget's genetic epistemology, psychological constructivism provides valuable insights into the process of students' conceptual development. In order to understand students' mathematical enculturation, there has been increasing interest in theorizing learning mathematics as a social process (e.g., Seeger, Voigt, & Waschescio, 1998). However, the transition from students' conceptual development to its incorporation with social development has remained challenging. Ms. K's case supports one sort of coordination of social and psychological objectives via her explicit mediation of classroom discourse. In other words, the teacher masterfully attends to concordance between the social processes of the classroom and students' engagement toward development of specific mathematical concepts.

Implementing student-centered teaching practices is fundamentally about significant change, and the teacher remains the key to change. The extent to which significant change occurs depends a great deal on how the teacher comes to make sense of reform and respond to it. Teachers need to be empowered in integrating different aspects of reform agenda with regard to their own diverse pedagogical motivations (Kirshner, 2002). To do so, we need to understand the difficulties or obstacles teachers may go through as they move on to student-centered instruction. This study with comparisons and contrasts between reform-oriented classes paves a way by which teachers and reformers open towards possibly subtle but crucial issues with regard to implementing reform agenda.

References

- Ball, D. L. (1993). With an eye on the mathematical horizon: Dilemmas of teaching elementary school mathematics. *The Elementary School Journal*, 93 (4), 373-398.
- Beaton, A. E., Mullis, V.S., Martin, M. O., Gonzalez, E. J., Kelly, D. L., & Smith, T. A. (1996). *Mathematics achievement in the middle school years: IEA's third international mathematics and science study*. Chestnut Hill, MA: Boston College.
- Burrill, G. (1997). The NCTM Standards: Eight years later. *School Science and Mathematics*, 97(6), 335-339.
- Cobb, P., & Bauersfeld, H. (Eds.). (1995). *The emergence of mathematical meaning: Interaction in classroom cultures*. Hillsdale, NJ: Lawrence Erlbaum Associates.
- Cobb, P., Gravemeijer, K., Yackel, E., McClain, K., & Whitenack, J. (1997). Mathematizing and symbolizing: The emergence of chains of signification in one first-grade classroom. In D. Kirshner & J. Whitson (Eds.), *Situated cognition: Social, semiotic, and psychological perspectives*. Mahwah, NJ: Lawrence Erlbaum Associates.
- Fennema, E., & Nelson, B. S. (Eds.). (1997). *Mathematics teachers in transition*. Mahwah, NJ: Lawrence Erlbaum Associates.

- Glaser, B. G., & Strauss, A. L. (1967). *The discovery of grounded theory: Strategies for qualitative research*. Chicago, IL: Aldine.
- Kim, J., Kim, C., Lew, H., & Im, H. (1996). *The Third International Mathematics and Science Study (TIMSS): National report for the main study questionnaires* (in Korean). Seoul, Korea: National Board of Educational Evaluation.
- Kirshner (2002). Untangling teachers' diverse aspirations for student learning: A crossdisciplinary strategy for relating psychological theory to pedagogical practice. *Journal for Research in Mathematics Education*, 33(1), 46-58.
- Knapp, M. S. (1997). Between systemic reforms and the mathematics and science classroom: The dynamics of innovation, implementation, and professional learning. *Review of Educational Research*, 67(2), 227-266.
- Ministry of Education (1997). The 7th elementary school curriculum (In Korean). Seoul, Korea: the Author.
- Mullis, I. V.S., Martin, M.O., Beaton, A. E., Gonzalez, E. J., Kelly, D. L., & Smith, T. A. (2000). *TIMSS 1999 international mathematics report*. Boston, MA: Boston College.
- National Council of Teachers of Mathematics (1991). *Professional standards*. Reston, VA: The Author.
- National Council of Teachers of Mathematics (2000). *Principles and standards for school mathematics*. Reston, VA: The Author.
- Pang, J.S. (2000, April). Implementing student-centered instruction in Korean and the U.S. elementary mathematics classrooms. Paper presented at the Annual Meeting of the American Educational Research Association, New Orleans, LA.
- Research Advisory Committee (1997). Clarifying the contributions of research with NCTM. *Journal for Research in Mathematics Education*, 28 (4), 396-397.
- Seeger, F., Voigt, J., & Waschescio. U. (Eds.). (1998). *The culture of the mathematics classroom*. New York: Cambridge University Press.
- Stake, R. E. (1998). Case studies. In N. K. Denzin & Y. S. Lincoln (Eds.), *Strategies of qualitative inquiry* (pp. 86-109). Thousand Oaks, CA: SAGE.
- Strauss, A., & Corbin, J. (1998). Grounded theory methodology: An overview. In N. K. Denzin & Y. S. Lincoln (Eds.), *Strategies of qualitative inquiry* (pp. 158-183). Thousand Oaks, CA: SAGE.
- Yackel, E., & Cobb, P. (1996). Sociomathematical norms, argumentation, and autonomy in mathematics. *Journal for Research in Mathematics Education*, 27(4), 458-477.
- Yin, R. K. (1994). *Case study research: Design and methods*. Thousand Oaks, CA: SAGE.

ON PUPILS' SELF-CONFIDENCE IN MATHEMATICS: GENDER COMPARISONS

Anu Nurmi, Markku Hannula, Hanna Maijala & Erkki Pehkonen
University of Turku, Dept Teacher Education, Finland

In this paper we will concentrate on pupils' self-confidence in mathematics, which belongs to pupils' mathematical beliefs on themselves, and beliefs on achievement in mathematics. Research described consists of a survey of more than 3000 fifth-graders and seventh-graders. Furthermore, 40 pupils participated a qualitative follow-up study (interviews and observations). Results showed that mathematical beliefs on oneself could be divided, based on the indicator used, into three factors: self-confidence, success orientation, and defense orientation. The fifth-graders had higher self-confidence than the seventh-graders. Additionally, boys in both grades had remarkably higher self-confidence in mathematics than girls.

INTRODUCTION

Pupils' conceptions on themselves as a learner are strongly connected with what kind of general attitudes they have toward the discipline in question. Mathematics has been since centuries a highly valued discipline in school, and therefore, pupils experience success in mathematics important. It has been observed that pupils' beliefs on mathematics and on themselves as mathematics learners have a central role in pupils' learning and success in mathematics (e.g. Schoenfeld 1992).

The importance of beliefs is earning more and more recognition in mathematics education; this is concordance with the constructivist understanding of teaching and learning. For the term "belief", there is no single, exact definition. Furinghetti & Pehkonen (2002) have tried to clarify the problems of the concept belief, and they conclude that it seems to be impossible to find a universally accepted characterization for beliefs. For example, Schoenfeld (1992, 358) describes beliefs as "*an individual's understandings and feelings that shape the ways that the individual conceptualizes and engages in mathematical behavior*". Our understanding of what a belief is may be further characterized by the following specification of its function in a system. Pehkonen & Törner (1996) describes four kind of functions: (a) beliefs form a background regulating system of our perceptions, thinking, and actions, and therefore, (b) beliefs act as indicators for teaching and learning. Moreover, (c) beliefs can be seen as an inertia force that may work against change, and as a consequence (d) beliefs have a forecasting character.

Beliefs have their principal origin in social interaction. An individual's mathematical beliefs originate from his personal experiences in school and outside of school. These, in turn, consist of perceptions that originate from mathematics teachers, other teachers, schoolmates, learning materials, achievements in mathematics, etc. Especially, mathematics teachers have an influence, among other things, through their curricular decisions. The prevailing image of mathematics in society influences students' beliefs through their parents, relatives, friends, different kinds of media, job opportunities, etc.

Mathematical beliefs and mathematics learning form a circular process. I.e. on one hand how mathematics is taught in class influence little by little on pupils' beliefs in mathematics. On the other hand, beliefs influence how pupils can receive mathematics teaching in class. A pupil's mathematical beliefs act as a filter influencing all his thoughts and actions concerning mathematics. Mathematical beliefs can be divided into four main components: beliefs on mathematics, beliefs on oneself as a mathematics learner/applier, beliefs on teaching mathematics, and beliefs on learning mathematics (e.g. Lester & al. 1989).

Of mathematical beliefs on oneself, the most studied ones are, among others, self-confidence, self-efficiency and success expectations and their connections with success. Several studies have shown that beliefs on oneself have a remarkable connection with success in mathematics (e.g. Hannula & Malmivuori 1996, House 2000). For example, in the study of Hannula and Malmivuori (1996) the observation was made that of ninth-graders' mathematical beliefs, self-confidence correlated statistically significantly with success in the mathematics test they used.

Often one tries to approach mathematical beliefs using comparisons of girls' and boys' results. Among others, in the test of Pehkonen (1997) boys in grade 9 were more interested in mathematics and have more confidence in themselves than girls. According to results of the same study, girls were, however, more ready to cooperate with other pupils and to practice with more tasks than boys. Similar results were found also in other studies (e.g. Stipek & Gralinski 1991). These results are supported also by the study of Vanayan & al. (1997) that showed that already in grade 3 and 5 boys estimated themselves to be better in mathematics than girls. That in teenage girls' have weaker self-confidence in mathematics than boys has also been reported in several publications, e.g. in Leder (1995) and Bohlin (1994). Also mathematics anxiety seems to be more general in girls than in boys (Frost, Hyde & Fennema 1994).

The focus of this paper is to describe pupils' mathematical beliefs on themselves, and to consider them in relation to their mathematical achievement. Especially, we concentrate us on comparison of girls' and boys' beliefs and achievement.

METHOD

The study is a part of a research project "Understanding and Self-Confidence in Mathematics" financed by the Academy of Finland (project #51019). The project is targeted grades 5–8, and contains in the beginning a large survey with a statistical sample from the Finnish pupil population of grade 5 and grade 7 with 150 school classes and altogether 3057 pupils. In the sample, the share of girls and boys is about the same, as well as the share of pupils in two grade levels (grade 5 and 7). The survey was implemented at the end of the year 2001, and the information gathered was deepened with interviews in spring 2002. The development of pupils' understanding and self-confidence were tried to track with follow-up interviews that are planned to run during winter 2002-03. For the interviews 10 classes are selected, and from each of them four pupils. Thus, altogether 40 pupils will be interviewed and observed.

The questionnaire was planned especially for the project, but some ideas were collected from the existing literature. Its aim was to measure both pupils' calculation skills in

fractions and decimals, and their understanding in the case of the concepts “density of fractions” and “infinity”; additionally pupils’ self-confidence in mathematics was measured. The questionnaire is a compound of five areas: a pupil’s background knowledge, 19 mathematical tasks, a pupil’s expectation of success before doing the task, a pupil’s evaluation of success after doing the task, and an indicator for his mathematical beliefs. The questionnaire was administered within a normal mathematics lesson (45 minutes) by the teacher. Some examples of the mathematical tasks used in the questionnaire were the following:

Task 5. Write the largest number that exists. How do you know that it is the largest?

Task 6c. Calculate $2 \cdot 0.8$.

Task 7. How many numbers are there between numbers 0.8 and 1.1?

Some results connected to the concept “infinity” have been reported in an earlier paper (cf. Hannula & al. 2002). Here we will concentrate on the results of the self-confidence in mathematics. Furthermore, connections of the pupils’ beliefs are studied with their (self reported) latest marks in mathematics and with their achievement in mathematical tasks of the questionnaire. Grade and gender were used as background variables. The questionnaire and interview structure were tested in autumn 2001, and some small changes were made.

The indicator used (belief scale) contained 25 statements of beliefs on oneself in mathematics. Of these items, ten were taken from the self-confidence part of the Fennema-Sherman scale (cf. Fennema & Sherman 1976), and the other 15 items measured pupils’ beliefs on themselves as mathematics learners, and beliefs on success. The wording of the statements is given in Table 1 describing the factor solution. The students answered on a 5-point Likert-scale (from totally disagree to totally agree).

The sum variables made from beliefs have been considered mainly without classifications, but, if needed, three groups (weak, average, good) were formed. According to school marks in mathematics, pupils were divided into three equal groups in the way that the following division was used: about a quarter of the pupils from the weakest part, about a quarter of the pupils from the best part, and about half of the pupils between these. The same was done with the sum scores of the mathematics tasks in the test: a quarter from the weakest part, a quarter from the best part, and half of the pupils between these. The data of the fifth-graders and the seventh-graders was dealt with both together and separated. The results are reported mainly with all pupils together, but if there are significant differences between the grades, they are mentioned separately.

Data analysis concerning beliefs began with factor analysis. Next the connections of the sum variables, made from the factors obtained, with gender, grade level, mathematics mark and the test score were considered. Parametric tests, such as t-test, were used, and the results were checked, if needed, with corresponding nonparametric tests.

The questionnaire used in research was tested with some pupils from grade 5 and 6 in autumn 2001, and some small changes were made. Since the mathematical tasks in the questionnaire are same for both grades (grade 5 and 7), it is clear that the task scores of the seventh-graders were remarkably higher than those of the fifth-graders. In the case of self-confidence, the belief scale seemed to form a very unified, and therefore, reliable part, since its statements were factorized in several different solutions on the same factor.

The research participants formed a large and covering sample of fifth-graders and seventh-graders in Finland. Therefore, results can be generalized to the whole Finland. Also gender differences in results are possible to generalize in Finland, since the amount of girls and boys in the sample was about the same.

ON RESULTS

Factorized mathematics beliefs

Factor analysis resulted in the case of both grades a very similar structure. The program suggested five factors, when using the criteria “eigen value > 1 ”, whereas according to the Cattell scree-test the proper number of factors seemed to be 3...5. Therefore, several different factor solutions were experimented, and finally decided to use three factors.

For a three factor solution, there were the following facts: In all factor solutions, the 10 Fennema-Sherman statements were loaded in the first factor. Therefore in the four and five factor solutions, there were left only two or three statements for the last factors. Additionally, the Cronbach alphas for the last factors in question were very low. Furthermore, the three-factor solution explained from the variance almost as much as e.g. the five-factor solution.

The three-factor solution was further elaborated. Because of their low communalities (< 0.30), five statements were compelled to remove from the combined data and from the seventh-graders' data. In the case of fifth-graders, two additional statements were removed. In other points the structures were very similar, and therefore, we concentrate here to consider only the factorization made from the combined data.

In Table 1, one can see the three-factor structure with loadings and communalities. The explanation level of this factor solution is 48 %. In the first factor, the central point is clearly self-confidence in mathematics, and therefore, we name the factor “self-confidence”; it explains 26 % of the variance.

The second factor contains, among others, preparation for tests, importance of getting a good mark, and importance of understanding topics. The name of the factor will thus be “Success orientation”, and it explains 12 % of the variance. One should note that the factor contains many types of willingness to success – on one hand desire to understand topics, and on the other hand, desire to success in tests.

The third factor contains statements that are combined with the fear of embarrassing and avoiding behavior in mathematics class. The factor was named “Defense orientation”, and it explains 10 % of the variance.

There is a statistically very significant difference between grades in self-confidence and in success orientation in the way that the fifth-graders have higher means than the seventh-graders in both.

The boys have in the combined data and in the seventh grade statistically very significantly ($p < 0.001$) better self-confidence than the girls, but in success and defense orientation there are no statistically significant differences. In the case of the fifth-graders, there is a statistically very significant ($p < 0.001$) difference beside self-confidence also in success orientation: Boys are more strongly success oriented than

girls. When looking more carefully the self-confidence factor, very significant differences between boys and girls in the combined data can be found in all ten statements, in favor of boys. The differences between fifth-grade boys and girls were not similar clear, although boys in total have a higher success orientation score.

Table 1. The three-factor solution on the mathematics beliefs of the indicator.

<i>Factors and statements</i>	<i>Loading</i>	<i>Communities</i>
<i>SELF-CONFIDENCE (alpha 0.89)</i>		
16. I am not the type who is good in mathematics.	-0.770	0.647
20. I am not very good in mathematics.	-0.761	0.639
8. Mathematics is difficult to me.	-0.755	0.637
5. I am able to get a good mark in mathematics.	0.726	0.597
6. Mathematics is my weakest school subject.	-0.726	0.574
22. I can do also difficult mathematics tasks.	0.677	0.534
11. I believe that I would do also more difficult mathematics.	0.653	0.463
19. I trust in myself in mathematics.	0.643	0.514
24. I know that I can be successful in mathematics.	0.588	0.539
1. I am sure that I can learn mathematics.	0.578	0.492
<i>SUCCESS ORIENTATION (alpha 0.55)</i>		
25. For me the most important in learning mathematics is to understand.	0.623	0.442
17. I prepare myself carefully for the tests.	0.601	0.373
14. In mathematics one succeeds with diligence.	0.590	0.355
15. For me it is very important to get a good mark in mathematics.	0.570	0.396
2. I am anxious before mathematics tests.	0.443	0.373
<i>DEFENCE ORIENTATION (alpha 0.56)</i>		
4. I don't like to reveal others, if I don't understand something in mathematics.	0.679	0.477
3. In mathematics one is not needed to understand everything, when one only gets good marks in tests.	0.580	0.403
23. I fear often to embarrass myself in mathematics class.	0.572	0.397
12. I answer in mathematics class only, if I am compelled to.	0.556	0.360
9. I don't like tasks that I am not able to solve immediately.	0.495	0.331

Correlations between sum variables

Success in mathematics will be clarified with the aid of the last mathematics marks and the tasks in the questionnaire. They form with the three factors the five sum variables (self-confidence, success orientation, defense orientation, school marks, and task scores). In order to acquire a holistic view, the correlations between the sum variables are firstly considered. As one may observe from Table 2, self-confidence and defense orientation correlate negatively. Additionally, school marks and task scores correlate strongly with each other. The strongest correlation with success in mathematics has self-confidence, but also defense orientation has some negative correlation with success. The significance of correlations was checked with a random sample on 15 %, which confirmed the validity of correlations.

Table 2. Correlations between sum variables in the combined data (N ≈ 3000).

	<i>Success orientation</i>	<i>Defence orientation</i>	<i>School marks</i>	<i>Task score</i>
<i>Self-confidence</i>	0.156***	-0.397***	0.538***	0.346***
<i>Success orientation</i>		0.003	0.022	-0.030
<i>Defence orientation</i>			-0.248***	-0.212***
<i>School marks</i>				0.489***

*** Correlation is statistically very significant, $p < 0.001$.

Self-confidence correlates statistically significantly with all other sum variables. Success orientation is in connection only with self-confidence, whereas the rest of the three sum variables seem to form a solid structure with self-confidence. It is worthwhile noting that defense orientation has a negative connection with other sumvariables.

Mathematics achievement and mathematics beliefs

In the case of school marks in mathematics, there are statistically very significant differences between different groups (weak, average, good) in self-confidence and defense orientation: The weak pupils had a remarkably weaker self-confidence and a stronger defense orientation than the good pupils, and the average pupils were between these. The girls had a statistically almost significant difference between groups also in success orientation.

In addition, one may observe that average girls have equal strong or weak self-confidence as weak boys, whereas good girls have almost as strong self-confidence as average boys. We were interesting in focussing on this result, since some earlier results point on that there is no difference in self-confidence of good girls and boys (e.g. Minkkinen 2001). Therefore, we decided to take a still smaller group of good girls (the criteria: school mark¹ is 10), and to compare them with the corresponding group of boys. From Table 3 one may observe that the difference in self-confidence between girls and boys stays on equal level as in the whole data. Therefore, also the best girls don't reach boys in self-confidence.

Table 3. Self-confidence of the highest achieving (mathematics mark 10) girls and boys.

	<i>Gender</i>	<i>N</i>	<i>mean</i>	<i>SD</i>	<i>p</i>
<i>Self-confidence</i>	boy	137	4.4	0.45	0.000***
	girl	101	4.0	0.50	

The similar pattern was also found in groups made according to the task scores of the test. Good girls have even weaker self-confidence than average boys, and average girls weaker self-confidence than weak boys. Again we wanted to look the most skillful pupils and find out, whether the differences in self-confidence still stay equal. Here our criteria was “the task score 30 or more” (the test maximum being 36 points). In Table 4

¹ In Finland 10 is the best mark in school.

one may notice that the difference between boys and girls in self-confidence is even bigger than in the whole data.

Table 4. Self-confidence of the most skillful (the task score 30 or more) girls and boys.

	<i>Gender</i>	<i>N</i>	<i>mean</i>	<i>SD</i>	<i>p</i>
<i>Self-confidence</i>	boy	101	4,4	0.50	0.000***
	girl	52	3,9	0.59	

CONCLUSION

Of the belief factors, self-confidence correlated most strongly both with the last mathematics mark and with the task scores. The weak pupils had the weakest self-confidence and the strongest defense orientation, the good pupils other way round, and the average pupils were between these. A strong connection between self-confidence (and other beliefs on oneself) and mathematical achievement has been found also in earlier research (i.a. Hannula & Malmivuori 1996; Malmivuori & Pehkonen 1996; Tartre & Fennema 1995).

The biggest gender difference was found in self-confidence; boys had remarkably higher self-confidence than girls. And the difference stayed on equal level also when compared the most skillful girls and boys with each other.

In the case of two other factors, one could point, among others, on Yates' research (Yates 1998, 2000). It is interesting that success orientation resulted only one factor, since in the motivational orientation tradition there are usually two different orientations (mastery and performance). On one hand, defense orientation could be connected with "ego-defensive" motivation orientation, and on the other hand, with mathematics anxiety.

Although defense orientation and self-confidence correlated rather strongly negatively, however, they are different constructs. One should not interpret that defense orientation is the same as weak self-confidence. Only a part of those who has weak self-confidence, feels that they need to cover their weak achievement.

References

- Bohlin, C.F. 1994. Learning style factors and mathematics performance: Sex-related differences. *International Journal of Educational Research* 21 (4), 387-398.
- Fennema, E. & Sherman, J.A. 1976. Fennema-Sherman mathematics attitudes scales. *JSAS Catalog of Selected Documents in Psychology*, 6, 31 (Ms. No. 1225).
- Frost, L.A., Hyde, J.S. & Fennema, E. 1994. Gender, mathematics performance, and mathematics related attitudes and affect: a meta-analytic synthesis. *International Journal of Educational Research* 21 (4), 373-385.
- Furinghetti, F. & Pehkonen, E. 2002. Rethinking Characterizations of Belief. To appear in: *Beliefs: A hidden variable in mathematics education?* (eds. G. Leder, E. Pehkonen & G. Törner). Utrecht: Kluwer.
- Hannula, M. & Malmivuori, M-L. 1996. Feminine structures in mathematical beliefs and performances. In: Pehkonen, E. (ed.) *Current state of research on mathematical beliefs III. Proceedings of the MAVI-3 workshop*, 31-38. University of Helsinki, department of teacher education. Research report 170.

- Hannula, M.S., Maijala, H., Pehkonen, E. & Soro, R. 2002. Taking a step to infinity: Student's Confidence with Infinity Tasks in School Mathematics. In: *Third European Symposium on Conceptual Change – A Process Approach to Conceptual Change* (eds. S. Lehti & K. Merenluoto), 195–200. University of Turku. Dept Teacher Education in Turku.
- House, J. 2000. Student self-beliefs and science achievement in Ireland: Findings from the third international mathematics and science study (TIMSS). *International journal of instructional media* 27 (1), 107-115.
- Leder, G. 1995. Equity inside the mathematics classroom: Fact or artifact? In W.G. Secada, E. Fennema & L.B. Adaijan (eds.) *New directions for equity in mathematics education*. Cambridge University Press.
- Lester, F.K., Garofalo, J. & Kroll, D.L. 1989. Self-Confidence, Interest, Beliefs, and Metacognition: Key Influences on Problem-Solving Behavior. In: *Affect and Mathematical Problem Solving* (eds. McLeod & Adams), 75-88. New York: Springer-Verlag.
- Malmivuori, M-L. & Pehkonen, E. 1996. Mathematical beliefs behind school performances. In: Puig, L. & Gutierrez, A. 1996. (eds.) *Proceedings of the 20th conference of the international group for the psychology of mathematics education*. Vol. 3, 305-311. University of Valencia.
- McLeod D.B. 1989. Beliefs, Attitudes, and Emotions: New Views of Affect in Mathematics Education. In: *Affect and Mathematical Problem Solving* (eds. D.B. McLeod & V.M. Adams), 245-258.
- McLeod, D. 1990. Information-processing theories and mathematics learning: The role of affect. *International journal of educational research* 14 (1), 13-29.
- Minkkinen, J. 2001. Lyhyttä vai pitkää matematiikkaa? Tutkimus tyttöjen ja poikien lukion matematiikkavalinnan perusteluista ja valintaan yhteydessä olevista tekijöistä [General or advanced mathematics? A study on reasons behind girls' and boys' mathematics selection and on connected factors]. University of Turku, Department of Teacher Education (a master's theses).
- Pehkonen, E. 1997. Learning results from the viewpoint of equity: boys, girls and mathematics. *Teaching Mathematics and its Applications* 16 (2), 58–63.
- Pehkonen, E. & Törner, G. 1996, Mathematical beliefs and different aspects of their meaning, *International Reviews on Mathematical Education (= ZDM)*, 28, n.4, 101-108.
- Schoenfeld, A. 1992, Learning to think mathematically: problem solving, metacognition and sense making in mathematics, in A. D. Grouws (ed.), *Handbook of research on mathematics learning and teaching*, 334-370.
- Stipek, D. & Gralinski, H. 1991. Gender differences in children's achievement-related beliefs and emotional responses to success and failure in mathematics. *Journal of educational psychology* 83 (3), 361-371.
- Tartre, L. & Fennema, E. 1995. Mathematics achievement and gender: A longitudinal study of selected cognitive and affective variables. *Educational studies in mathematics* 28, 199-217.
- Vanayan, M., White, N., Yuen, P. & Teper, M. 1997. Beliefs and attitudes toward mathematics among third- and fifth-grade students: A descriptive study. *School science & mathematics* 97 (7), 345-351.
- Yates, S. 1998. Teacher perceptions, learned helplessness and mathematics achievement. *Proceedings of the PME-22 conference* (eds. A. Olivier & K. Newstead), Vol. 4, 217–224. University of Stellenbosch.
- Yates, S. 2000. Student optimism, pessimism, motivation and achievement in mathematics: a longitudinal study. In: *Proceedings of the PME-24 conference* (eds. T. Nakahara & M. Koyama), Vol. 4, 297-304. University of Hiroshima.

AUTHOR INDEX VOLUME 3

A

Arbaugh, Fran 269

B

Bednarz, Nadine.....9

Berenson, Sarah87

Brown, Catherine 269

C

Cai, Jinfa..... 103

Cho, Kyoung-Hee 157

Chval, Kathryn 133

Clarke, Doug 261

Correia, Mônica 277

Crespo, Sandra 373

F

Falcade, Rossana..... 237

G

Grevholm, Barbro25

Grootenboer, Peter1

Guzmán, José 9, 141

H

Hadj-Mousová, Zuzana71

Hannula, Markku 17, 453

Hansson, Örjan.....25

Haydar, Hanna.....33

Hegedus, Stephen.....47

Heirdsfield, Ann.....55

Hewitt, Dave63

Hitt, Fernando9

Hofmannová, Marie 71

Horne, Marj.....79

Howe, Ann87

Hoyos, Verónica.....95

Hwang, Stephen 103

I

Iannone, Paola..... 365

Irwin, Kathryn..... 111

Ivey, Kathy 117

J

Jirotková, Darina..... 125

Ju, Mi Kyung..... 157

K

Kaput, Jim..... 47

Khisty, Lena Licón..... 133

Kieran, Carolyn 141

Koirala, Hari 149

Kwon, Oh-Nam 157

Kynigos, Chronis..... 165

L

Laborde, Colette 237

Lamprianou, Iasonas 173

Lamprianou, Thekla 173

Lavy, Ilana 181

Leder, Gilah 189

Leung, Leung..... 197

Lin, Pi-Jen..... 205

Littler, Graham 125

Lopez-Real, Francis 213

Lynch, Kthleen 269

M

Maijala, Hanna 453

Manouchehri, Azita..... 221

Maracci, Mirko 229

Mariotti, Maria 237

Martin, Lyndon..... 245

McClain, Kay 253

McDonough, Andrea..... 261

McGraw, Rebecca 269

Meira, Luciano 277

Merenluoto, Kaarina..... 285

Misailadou, Christina 293

Misfeldt, Morten..... 301

Mohammad, Razia Fakir..... 309

Monteiro, Cecilia..... 317

Morales, Hector 133

Moschkovich, Judit 325

Mousley, Judith 333

Murray, Hanlie 341

N

Nachlieli, Talli..... 349

Namukasa, Immaculate 357

Nardi, Elena 365

Ng, Sharon Sui Ngan..... 213

Nicol, Cynthia..... 373

Nilssen, Vivi 381

Nisbet, Steven..... 389

Novotná, Jarmila 71
Nurmi, Anu..... 453

O

Oehrtman, Michael 397
Oh, Youngyool..... 405
Okazaki, Masakazu 413
Olive, John 421
Olivero, Federica..... 429

P

Panaoura, Areti..... 437
Pang, JeongSuk 445
Pederson, David 189
Pehkonen, Erkki 453
Philippou, George 437
Pollard, Graham 189
Psycharis, Georgos..... 165

R

Rao, Nirmala..... 213

S

Sfard, Anna..... 349
Shin, Kyung-Hee 157
Shriki, Atara..... 181
Simmt. Elaine 357

T

Towers, Jo..... 245

W

Williams, Julian..... 293